

User Manual

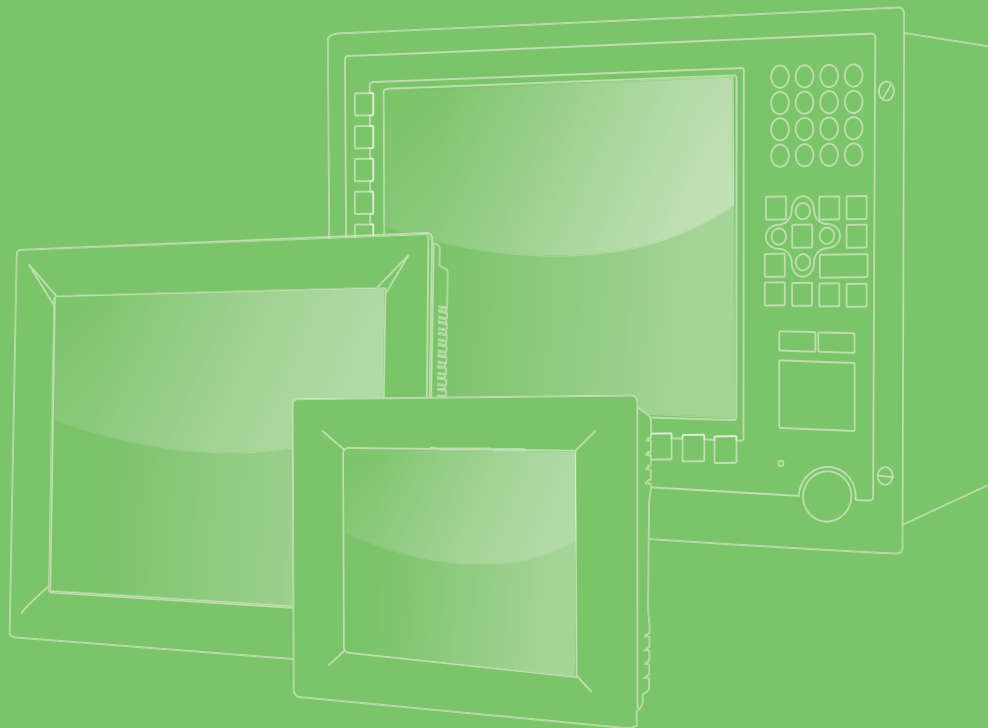

FPM-7000T Series

**True-flat Industrial Monitor with
5-wire Resistive Touchscreen,
Direct-VGA/DP ports**

ADVANTECH

Enabling an Intelligent Planet

Copyright

The documentation and the software included with this product are copyrighted 2015 by Advantech Co., Ltd. All rights are reserved. Advantech Co., Ltd. reserves the right to make improvements in the products described in this manual at any time without notice. No part of this manual may be reproduced, copied, translated or transmitted in any form or by any means without the prior written permission of Advantech Co., Ltd. Information provided in this manual is intended to be accurate and reliable. However, Advantech Co., Ltd. assumes no responsibility for its use, nor for any infringements of the rights of third parties, which may result from its use.

Acknowledgements

Intel and Pentium are trademarks of Intel Corporation.

Microsoft Windows and MS-DOS are registered trademarks of Microsoft Corp.

All other product names or trademarks are properties of their respective owners.

This Manual Covers the Following Models.

- FPM-7061T-XXXX
- FPM-7121T-XXXX
- FPM-7151T-XXXX

Product Warranty (2 years)

Advantech warrants to you, the original purchaser, that each of its products will be free from defects in materials and workmanship for two years from the date of purchase.

This warranty does not apply to any products which have been repaired or altered by persons other than repair personnel authorized by Advantech, or which have been subject to misuse, abuse, accident or improper installation. Advantech assumes no liability under the terms of this warranty as a consequence of such events.

Because of Advantech's high quality-control standards and rigorous testing, most of our customers never need to use our repair service. If an Advantech product is defective, it will be repaired or replaced at no charge during the warranty period. For out-of-warranty repairs, you will be billed according to the cost of replacement materials, service time and freight. Please consult your dealer for more details.

If you think you have a defective product, follow these steps:

1. Collect all the information about the problem encountered. (For example, CPU speed, Advantech products used, other hardware and software used, etc.) Note anything abnormal and list any onscreen messages you get when the problem occurs.
2. Call your dealer and describe the problem. Please have your manual, product, and any helpful information readily available.
3. If your product is diagnosed as defective, obtain an RMA (return merchandise authorization) number from your dealer. This allows us to process your return more quickly.
4. Carefully pack the defective product, a fully-completed Repair and Replacement Order Card and a photocopy proof of purchase date (such as your sales receipt) in a shippable container. A product returned without proof of the purchase date is not eligible for warranty service.
5. Write the RMA number visibly on the outside of the package and ship it prepaid to your dealer.

Declaration of Conformity

This device complies with part 15 of the FCC rules: Operation is subject to the following two conditions:

1. This device may not cause harmful interference.
2. This device must accept any interference received, including interference that may cause undesired operation.

FCC Class A

Note: This equipment has been tested and found to comply with the limits for a Class A digital device, pursuant to part 15 of the FCC Rules. These limits are designed to provide reasonable protection against harmful interference when the equipment is operated in a commercial environment. This equipment generates, uses, and can radiate radio frequency energy and, if not installed and used in accordance with the instruction manual, may cause harmful interference to radio communications. Operation of this equipment in a residential area is likely to cause harmful interference in which case the user will be required to correct the interference at his own expense.

Technical Support and Assistance

1. Visit the Advantech web site at www.advantech.com/support where you can find the latest information about the product.
2. Contact your distributor, sales representative, or Advantech's customer service center for technical support if you need additional assistance. Please have the following information ready before you call:
 - Product name and serial number
 - Description of your peripheral attachments
 - Description of your software (operating system, version, application software, etc.)
 - A complete description of the problem
 - The exact wording of any error messages

Safety Instructions

1. Read these safety instructions carefully.
2. Keep this User Manual for later reference.
3. Disconnect this equipment from any AC outlet before cleaning. Use a damp cloth. Do not use liquid or spray detergents for cleaning.
4. For plug-in equipment, the power outlet socket must be located near the equipment and must be easily accessible.
5. Keep this equipment away from humidity.
6. Put this equipment on a reliable surface during installation. Dropping it or letting it fall may cause damage.
7. The openings on the enclosure are for air convection. Protect the equipment from overheating. **DO NOT COVER THE OPENINGS.**
8. Make sure the voltage of the power source is correct before connecting the equipment to the power outlet.
9. Position the power cord so that people cannot step on it. Do not place anything over the power cord.
10. All cautions and warnings on the equipment should be noted.
11. If the equipment is not used for a long time, disconnect it from the power source to avoid damage by transient overvoltage.
12. Never pour any liquid into an opening. This may cause fire or electrical shock.
13. Never open the equipment. For safety reasons, the equipment should be opened only by qualified service personnel.
14. If one of the following situations arises, get the equipment checked by service personnel:
 - The power cord or plug is damaged.
 - Liquid has penetrated into the equipment.
 - The equipment has been exposed to moisture.
 - The equipment does not work well, or you cannot get it to work according to the user's manual.
 - The equipment has been dropped and damaged.
 - The equipment has obvious signs of breakage.
15. **DO NOT LEAVE THIS EQUIPMENT IN AN ENVIRONMENT WHERE THE STORAGE TEMPERATURE MAY GO BELOW -20° C (-4° F) OR ABOVE 60° C (140° F). THIS COULD DAMAGE THE EQUIPMENT. THE EQUIPMENT SHOULD BE IN A CONTROLLED ENVIRONMENT.**
16. The sound pressure level at the operator's position according to IEC 704-1:1982 is no more than 70 dB (A).

DISCLAIMER: This set of instructions is given according to IEC 704-1. Advantech disclaims all responsibility for the accuracy of any statements contained herein.

Contents

Chapter 1	General Information	1
1.1	Introduction	2
1.2	Specifications	2
1.2.1	General	2
1.2.2	Touchscreen	2
1.3	LCD Specification.....	3
1.4	Power Consumption.....	4
1.5	Connectors.....	4
1.6	Dimensions	5
	Figure 1.1 FPM-7061T Dimensions.....	5
	Figure 1.2 FPM-7121T Dimensions.....	6
	Figure 1.3 FPM-7151T Dimensions.....	7
1.7	Power Connector Bracket	8
Chapter 2	Mounting	9
2.1	Mounting the Monitor	10
2.1.1	Wall Mounting with FPM-1000T-SMKE	10
	Figure 2.1 Wall Mounting.....	10
2.1.2	Panel Mounting.....	11
2.1.3	VESA Mount for FPM-7000T	12
	Figure 2.2 Desktop Stand.....	12
	Figure 2.3 VESA mount for FPM-7061T.....	13
	Figure 2.4 VESA 100 mount for FPM-7121T/7151T.....	14
	Figure 2.5 VESA 75 mount for FPM-7121T/7151T.....	14
Appendix A	OSD Operation Keypad	1
A.1	OSD Board Overview (FPM-71x1T).....	2
A.1.1	OSD Key Functions	2
A.2	OSD Board Overview (FPM-7061T)	8
A.2.1	OSD Key Functions	9
A.3	Installing Drivers for Windows OS.....	13
Appendix B	Setting Serial Data for Expansion	15
B.1	Setting Serial Data for Expansion	16
B.2	Touch screen RS232 Connector Pin Definition.....	17

Chapter 1

General Information

Sections include:

- Introduction
- Specifications
- LCD Specification
- Power Consumption
- Connectors
- Dimensions

1.1 Introduction

Advantech's FPM-7000T is a true-flat TFT LCD flat panel monitor built specifically for industrial applications. With its touchscreen, FPM-7000T is an excellent and user-friendly system control interface.

In addition to its usual application as an LCD panel monitor, FPM-7000T comes standard with direct VGA/DP signal inputs, making it compatible with Industrial PCs and Workstations. Its OSD (On rear cover) function allows you to adjust display factors such as brightness, contrast, colours and VGA signal information. Functions that are more and more critical as HMI users become aware of the benefits of flat panel monitors. The rear cover is of SECC steel, and the front panel is of die-cast magnesium alloy with IP66 certification.

With a new system design, this monitor can support operating temperatures from -20 ~ 60°C for a variety of environments. Designed with various mounting methods for users to apply into the system or adopt to the environment easily.

1.2 Specifications

1.2.1 General

- **Construction:** Die-cast Magnesium alloy front bezel and SECC rear cover
- **Front panel:** IP66 certified
- **Control:** OSD control pad on rear
- **Mounting:** Panel, wall, desktop, VESA
- **Dimensions (W x H x D):**
 - FPM-7061T: 199.0 x 152.0 x 46.10 mm
 - FPM-7121T: 311.8 x 238 x 44.5 mm
 - FPM-7151T: 383.2 x 307.3 x 48.0 mm
- **Weight:**
 - FPM-7061T: 1.2 kg
 - FPM-7121T: 2.6 kg
 - FPM-7151T: 4.2 kg

1.2.2 Touchscreen

- **Type:** 5-wire Resistive Touch
- **Controller:**
 - USB interface for FPM-7061T
 - USB & RS-232 interface for FPM-7121T & FPM-7151T
- **OS Support:** Microsoft® Windows XP, Vista, 7, 8, and Linux
Linux support version please check PenMount Website:
http://www.penmount.com/down_2_1.php

1.3 LCD Specification

FPM-7061T

- **Display Type:** VGA LED LCD
- **Display Size:** 6.5"
- **Max. Colors:** 262K
- **Max. Resolution:** 640 x 480
- **View Angle:** 160° (V), 140° (H)
- **Luminance:** 800 cd/m²
- **Storage Temperature:** -40 ~ 85°C
- **Operating Temperature:** -30 ~ 80°C
- **Contrast Ratio:** 600:1 (typical)
- **Lamp Life Time (MTBF):** 50,000 hrs.

FPM-7121T

- **Display Type:** XGA LED LCD
- **Display Size:** 12.1"
- **Max. Colors:** 16.2 M
- **Max. Resolution:** 1024 x 768
- **View Angle:** 160° (V), 140° (H)
- **Luminance:** 600 cd/m²
- **Storage Temperature:** -40 ~ 85°C
- **Operating Temperature:** -30 ~ 80°C
- **Contrast Ratio:** 700:1 (typical)
- **Lamp Life Time (MTBF):** 50,000 hrs.

FPM-7151T

- **Display Type:** XGA LED LCD
- **Display Size:** 15"
- **Max. Colors:** 16.7 M
- **Max. Resolution:** 1024 x 768
- **View Angle:** 160° (V), 140° (H)
- **Luminance:** 400 cd/m²
- **Storage Temperature:** -40 ~ 85°C
- **Operating Temperature:** -30 ~ 80°C
- **Contrast Ratio:** 700:1 (typical)
- **Lamp Life Time (MTBF):** 50,000 hrs.

Note!  There might be several bright or dark pixels on the LCD. This phenomenon is normal in today's LCD manufacturing. Inspection criteria are following specifications defined by LCD vendor.

Note!  Section 1.3 specifications are for LCD only. Please refer to system specification for operating & storage temperatures

1.4 Power Consumption

- **Max Power consumption:**
 - FPM-7061T: 10 W ± 20%
 - FPM-7121T: 18 W ± 20%
 - FPM-7151T: 16 W ± 20%
- **Power input:** Phoenix Jack: 24 VDC ± 20%
- **Safety Standards:** BSMI, CE, FCC, CCC, UL

1.5 Connectors

The following connectors are situated on FPM-7000T Series:

- **VGA Port (DB-15)**

This DB-15 connector can be connected to the system via the external 15-pin DB-15 connector located on the left side of the system unit.
- **DP or HDMI port**

Connected with a standard DP or HDMI connector thru I/O port of this unit. Only supports digital signals
- **Touchscreen Connector (DB-9)**

This connector will be present only if a touchscreen is installed. It must be connected to the RS-232 port of the PC. The touchscreen cable is included with all orders which include the touchscreen option.
- **Touchscreen Connector (USB)**

This connector will be present only if a touchscreen is installed. It must be connected to the USB port of the PC. The touchscreen cable is included with all orders which include the USB touchscreen option.

Note! *RS-232 & USB touchscreen interface allow connection into the system at the same time, but USB interface has higher priority. Also be noted that when using USB touch interface and switch to RS-232 interface, it need to restart your industrial PCs or workstation.*



- **Plug-In Block 3P Male (ME050-50803) DC 24 V**

This block connector can be connected via the external plug-in block 3P with flanges Female MC211-F103 connector

1.6 Dimensions

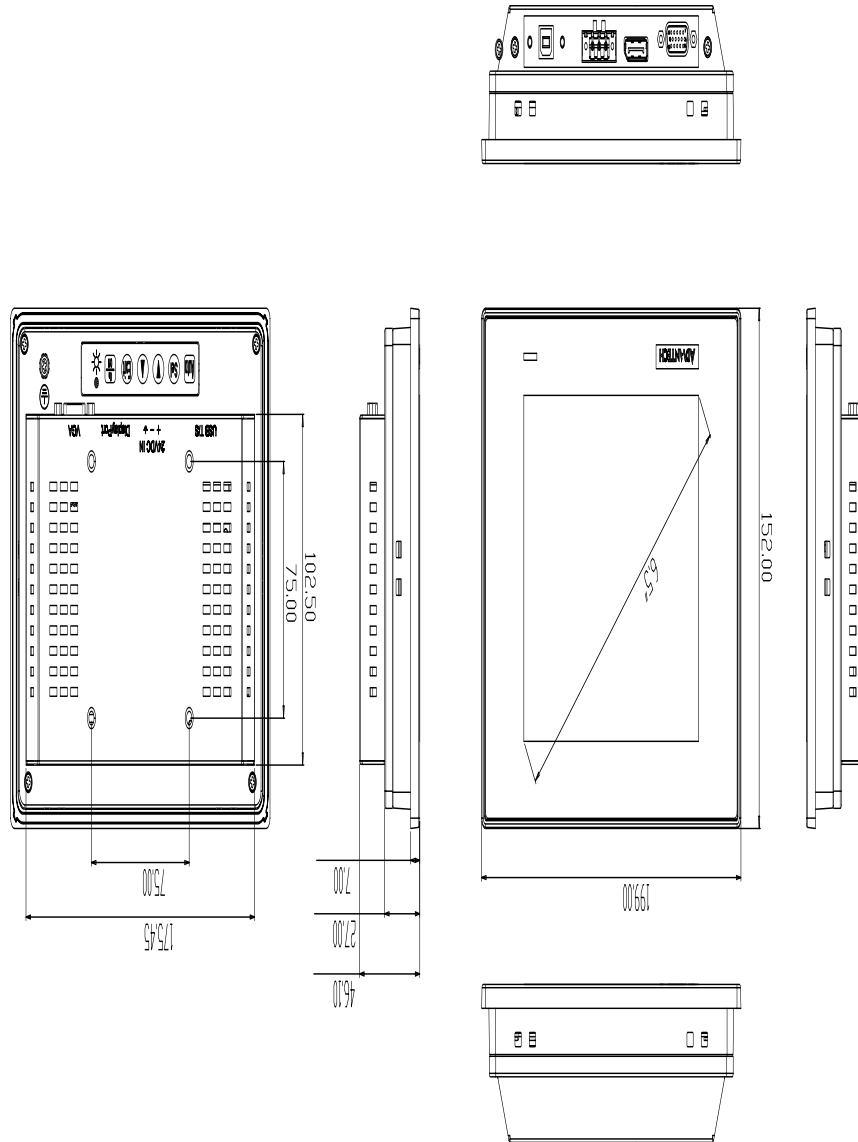

Figure 1.1 FPM-7061T Dimensions

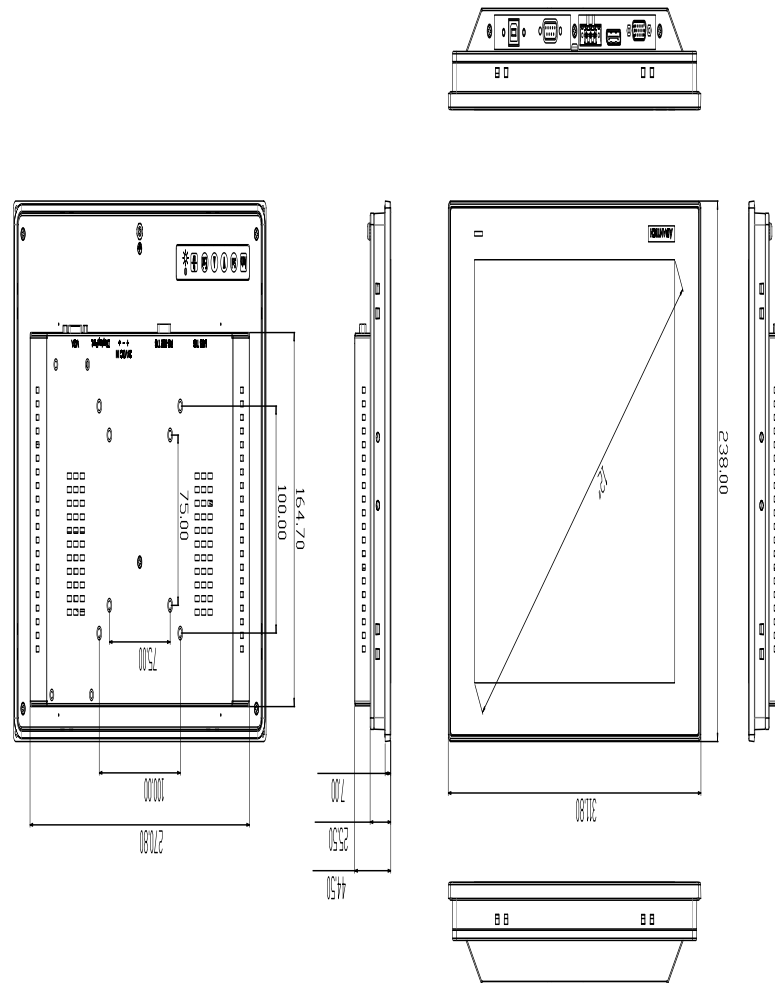

Figure 1.2 FPM-7121T Dimensions

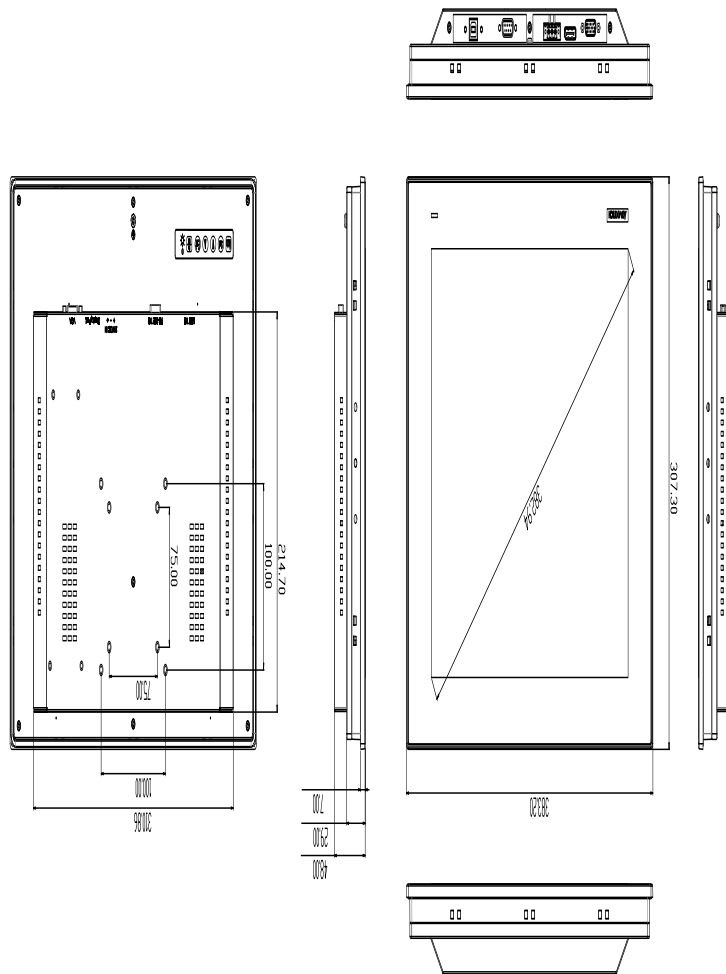
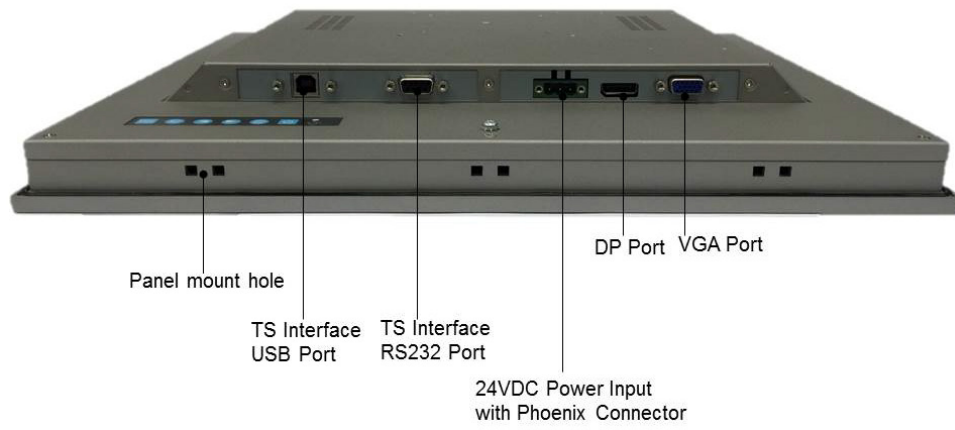

Figure 1.3 FPM-7151T Dimensions

1.7 Power Connector Bracket



Chapter 2

Mounting

- Wall Mounting
- Panel Mounting
- Desktop Mounting
- Swing Arm Mounting

2.1 Mounting the Monitor

The FPM-7000T Series can be mounted in many different ways. The versatility of the FPM-7000T enable it to be mounted on your desk or anywhere else.

2.1.1 Wall Mounting with FPM-1000T-SMKE

The FPM-7000T can be mounted directly on a wall with panel mounting brackets. Please refer to Figure 2.1 and follow the following steps to mount FPM-7000T on a wall:

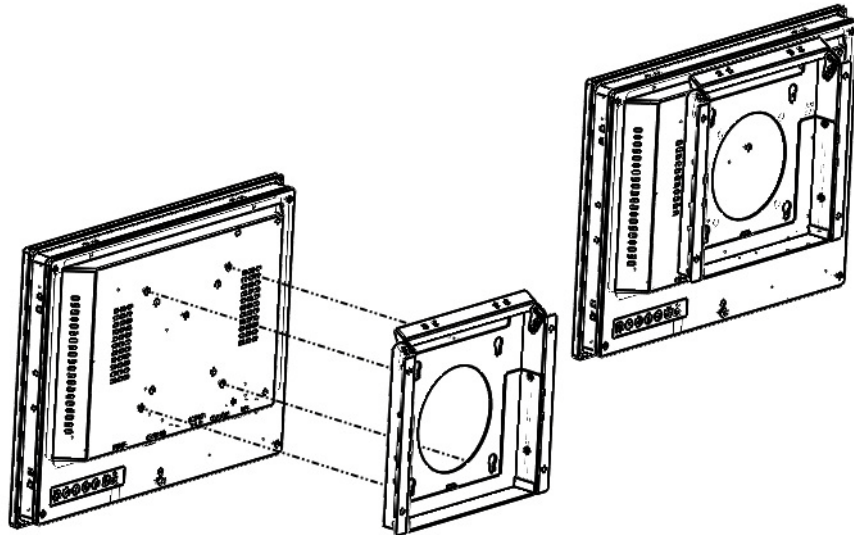
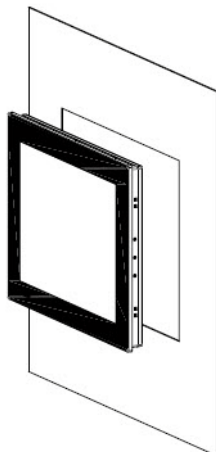

Figure 2.1 Wall Mounting

2.1.2 Panel Mounting

1. Position the FPM against the panel



2. Insert the clamps into the side of the FPM

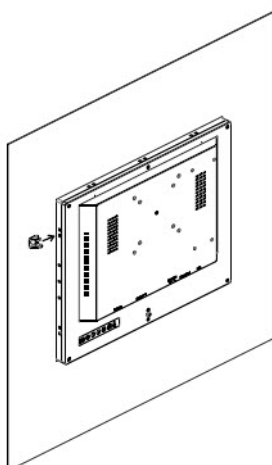

3. Secure the clamp to the panel using the included screws.

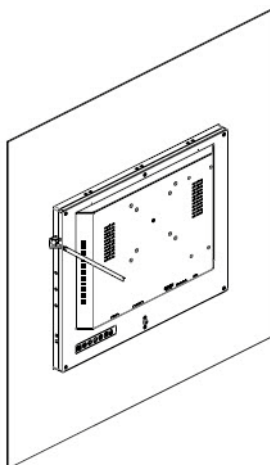

2.1.3 VESA Mount for FPM-7000T

2.1.3.1 Desk top stand with FPM-1000T-SMKE Kit

The FPM-7000T can be mounted as a stand on the desk by additional mounting brackets. See figure 2.2 below for reference.

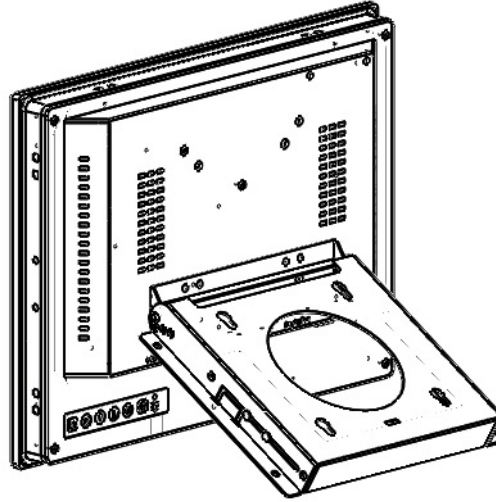

Figure 2.2 Desktop Stand

2.1.3.2 VESA Mount

FPM-7000T has been designed with support for the VESA mount standard. Refer to figure 2.3 & 2.4. FPM-7061T only supports VESA 75 x 75 mm; FPM-7121T supports VESA 75 x 75 mm & 100 x 100 mm; FPM-7151T supports VESA 75 x 75 mm & 100 x 100 mm. Please use M4 screws (Length 8mm to 10 mm).

Warning! Use suitable mounting apparatus to avoid risk of injury.



ATTENTION: Veuillez utiliser un système de montage approprié afin d'éviter tout risque de blessure.

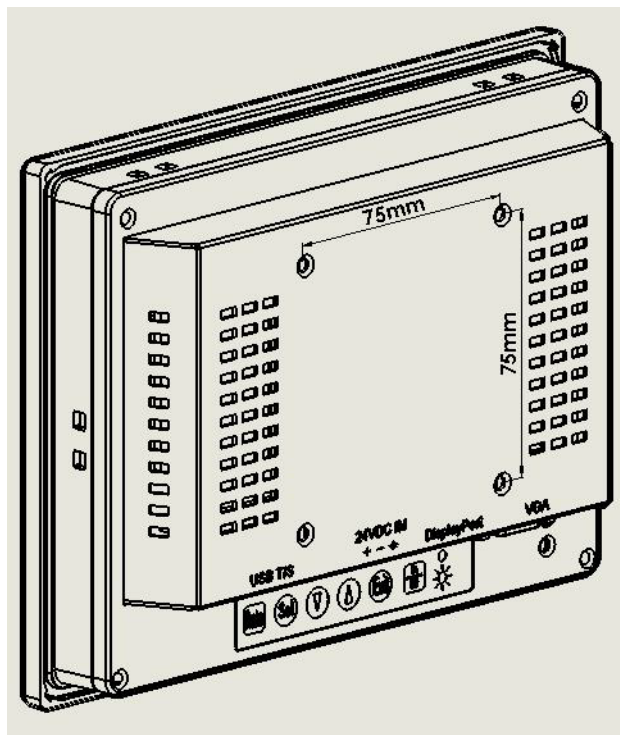

Figure 2.3 VESA mount for FPM-7061T

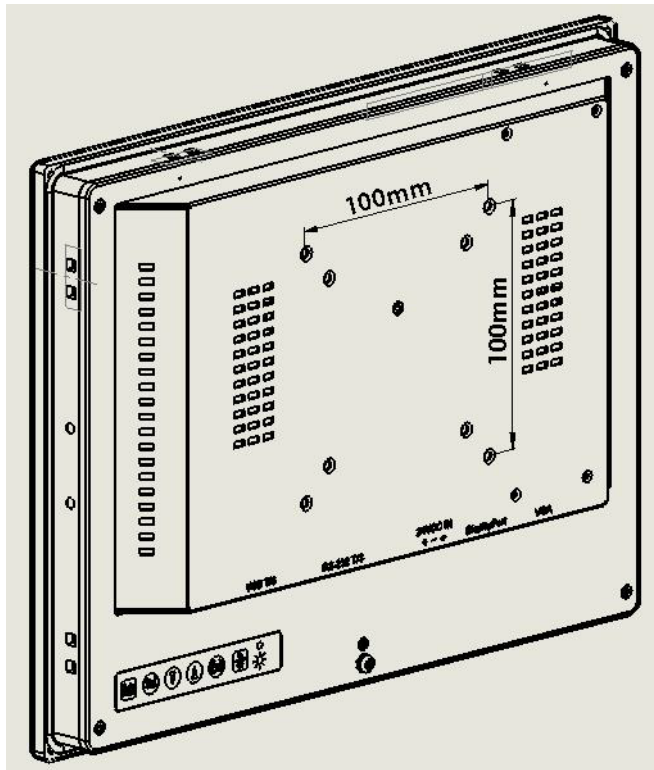

Figure 2.4 VESA 100 mount for FPM-7121T/7151T

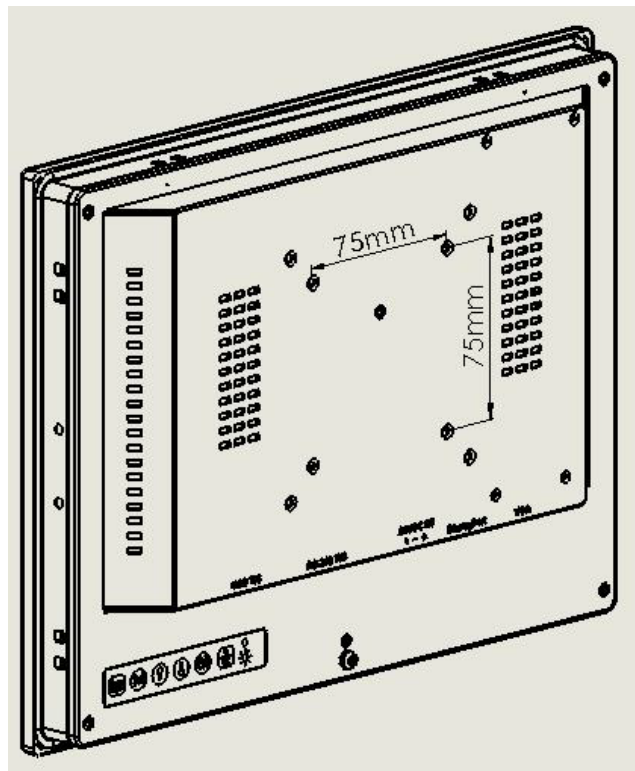

Figure 2.5 VESA 75 mount for FPM-7121T/7151T

Appendix **A**

OSD Operation
Keypad

A.1 OSD Board Overview (FPM-71x1T)



A.1.0.1 OSD Button Description

Buttons	Descriptions
Source	Changes input video source
Menu/Sel	Activate the OSD menu Enter /confirm the selected option
Left/Decrease Arrow	Activate volume control. Move the selector to the previous option Decrease the gauge value of the selected option Brightness can be decreased by left button.
Right/Increase Arrow	Activate the volume control. Move the selector to the next option Increase the gauge value of selected option. Brightness can be increased using the right button.
Auto/Exit	Automatically adjust the clock, phase, H-position and V-position. Exit menu
Power	Turn the monitor ON and OFF

A.1.0.2 LED Functions

On	Green
StandBy/Off	Green Blinking
No Signals	Orange

A.1.1 OSD Key Functions

Each selected value is stored into LCD memory after SEL signal input or time out. The stored values are not affected if the power is turned off. But the selected value is not available in case a selected mode is changed before time out or power is turned off before time out. TIME OUT 5-6 seconds (Can be set in OSD Manager) The default definition of input keys is shown as following:

A.1.1.1 Menu Start





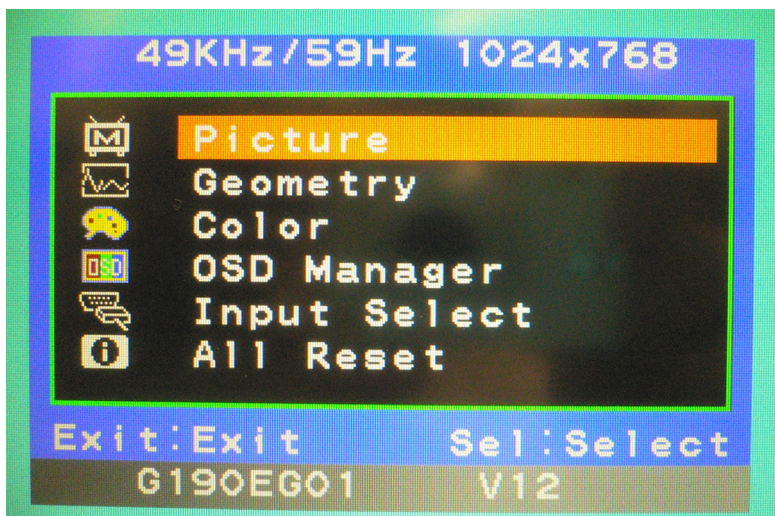

Generate Main Menu

Press MENU Button in OSD function key

- Main Menu



- Available Key Functions

	Power off the LCD monitor		Move down of the selection/ increase the gauge value of the selected option
	Select to return to last menu, exit menu or wait for timeout		Select to confirm
	Move up of the selection/increase the gauge value of the selected option		N/A

A.1.1.2 Picture

Select by Left and Right Button, press Menu Button for selection Confirmation

- Main Menu

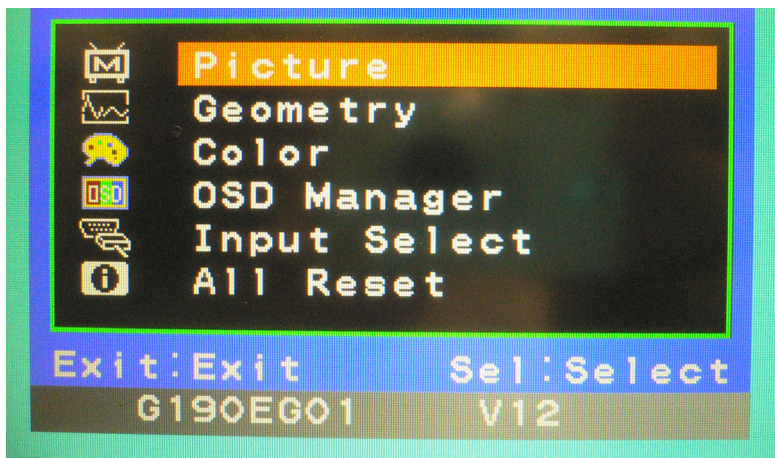





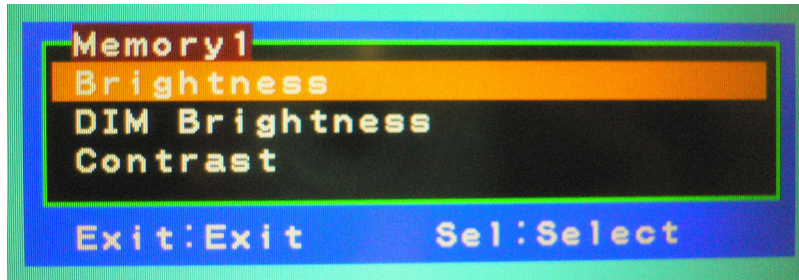
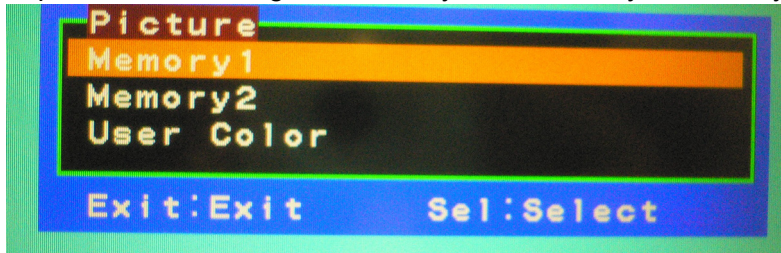

- Sub-Menu

User can set up 2 different settings to "Memory 1" & "Memory 2" for easy adjustment.



■ Available Key Functions

	Power off the LCD monitor		Move down of the selection/ increase the gauge value of the selected option
	Select to return to last menu, exit menu or wait for timeout		Select to confirm
	Move up of the selection/increase the gauge value of the selected option		N/A

A.1.1.3 Geometry



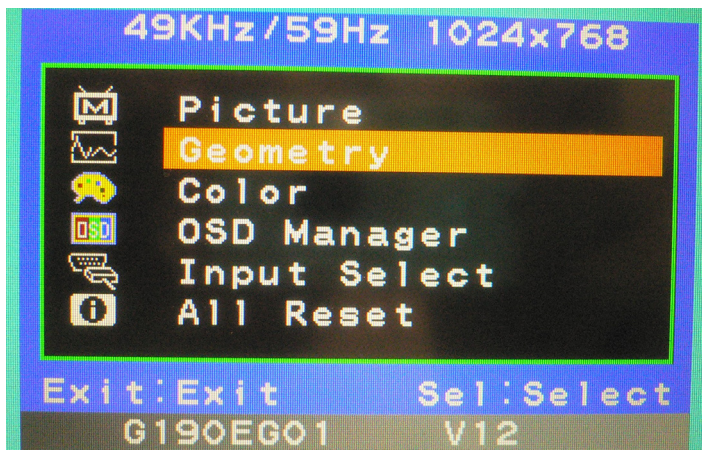



■ Main Menu



■ Sub-Menu



■ Available Key Functions

	Power off the LCD monitor		Move down of the selection/ increase the gauge value of the selected option
	Select to return to last menu, exit menu or wait for timeout		Select to confirm
	Move up of the selection/increase the gauge value of the selected option		N/A

A.1.1.4 Color



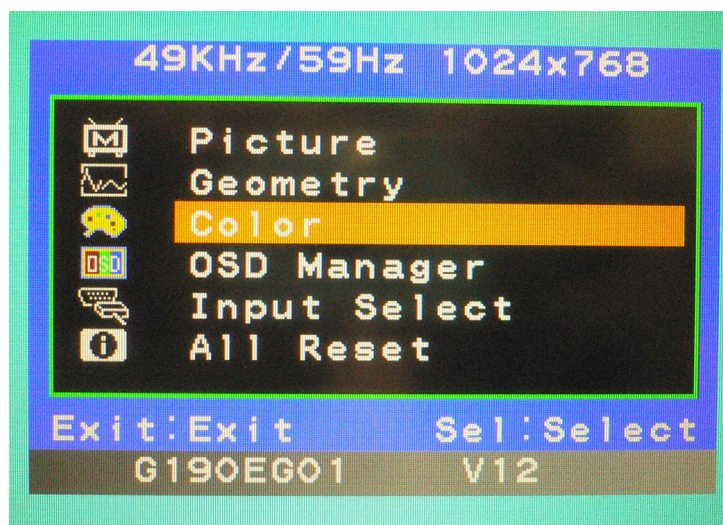

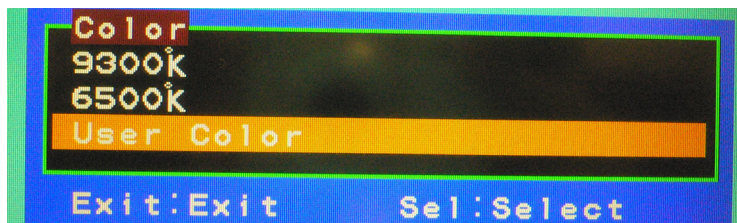

■ Main Menu



■ Sub-Menu



■ Available Key Functions

	Power off the LCD monitor		Move down of the selection/ increase the gauge value of the selected option
	Select to return to last menu, exit menu or wait for timeout		Select to confirm
	Move up of the selection/increase the gauge value of the selected option		N/A

A.1.1.5 OSD Manager



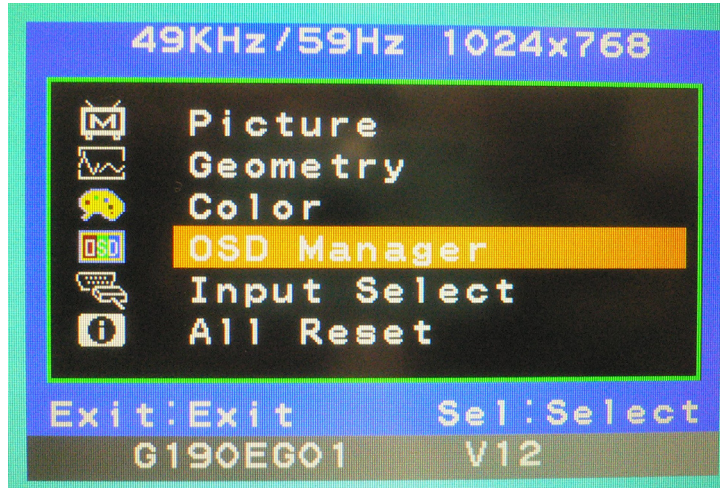



- Main Menu



- Sub-Menu



- Available Key Functions

	Power off the LCD monitor		Move down of the selection/ increase the gauge value of the selected option
	Select to return to last menu, exit menu or wait for timeout		Select to confirm
	Move up of the selection/increase the gauge value of the selected option		N/A

A.1.1.6 Input Select





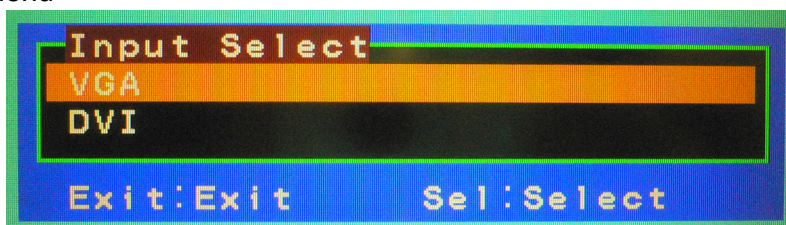

- Main Menu



- Sub-Menu



- Available Key Functions

	Power off the LCD monitor		Move down of the selection/ increase the gauge value of the selected option
	Select to return to last menu, exit menu or wait for timeout		Select to confirm
	Move up of the selection/increase the gauge value of the selected option		N/A

A.2 OSD Board Overview (FPM-7061T)



A.2.0.1 OSD Button Description

Buttons	Descriptions
Sel	Activate the OSD menu Enter /confirm the selected option
Down/Decrease Arrow	Activate volume control. Move the selector to the previous option Decrease the gauge value of the selected option Brightness can be decreased by down button.
Up/Increase Arrow	Activate the volume control. Move the selector to the next option Increase the gauge value of selected option. Brightness can be increased using the up button.

A.2.0.2 LED Functions

On	Green
StandBy/Off	Green Blinking
No Signals	Orange

A.2.1 OSD Key Functions

Each selected value is stored into LCD memory after SEL signal input or time out. The stored values are not affected if the power is turned off. But the selected value is not available in case a selected mode is changed before time out or power is turned off before time out. TIME OUT 5-6 seconds (Can be set in OSD Manager) The default definition of input keys is shown as following:

A.2.1.1 Menu Start



Generate Main Menu

Press **SEL** Button in OSD function key

- Main Menu



- Available Key Functions

	Move downward of the selection/decrease the gauge value of the selected option
	Move up of the selection/increase the gauge value of the selected option
	Select to confirm

A.2.1.2 Picture

Select by using the Up and Down Buttons, press the Sel Button for selection Confirmation

- Main Menu



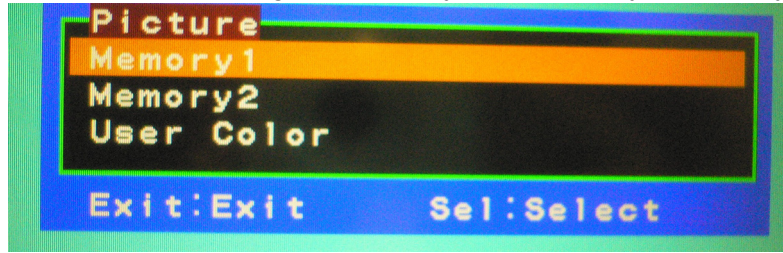

- Sub-Menu

User can set up 2 different settings to "Memory 1" & "Memory 2" for easy adjustment.



- Available Key Functions

	Move downward of the selection/decrease the gauge value of the selected option
	Move up of the selection/increase the gauge value of the selected option
	Select to confirm

A.2.1.3 Geometry



- Main Menu



- Sub-Menu



■ Available Key Functions

	Move downward of the selection/decrease the gauge value of the selected option
	Move up of the selection/increase the gauge value of the selected option
	Select to confirm

A.2.1.4 Color

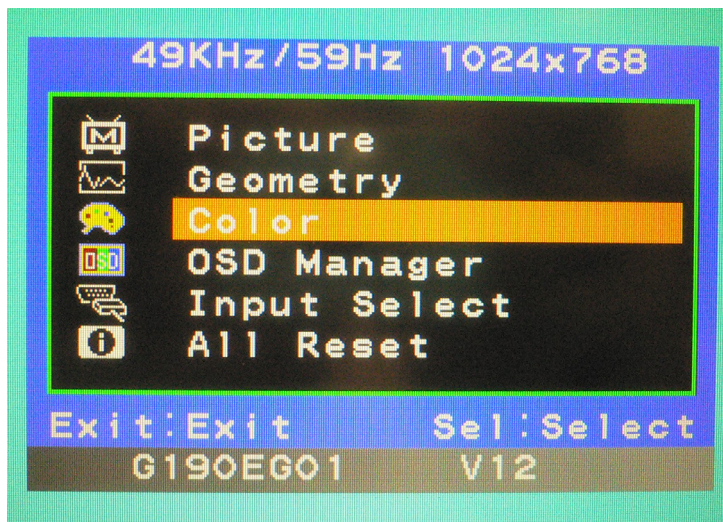

■ Main Menu

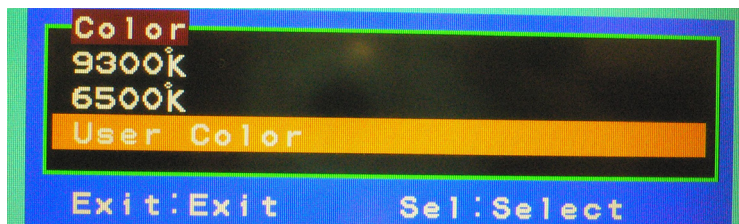

■ Sub-Menu



■ Available Key Functions

	Move downward of the selection/decrease the gauge value of the selected option
	Move up of the selection/increase the gauge value of the selected option
	Select to confirm

A.2.1.5 OSD Manager



- Main Menu

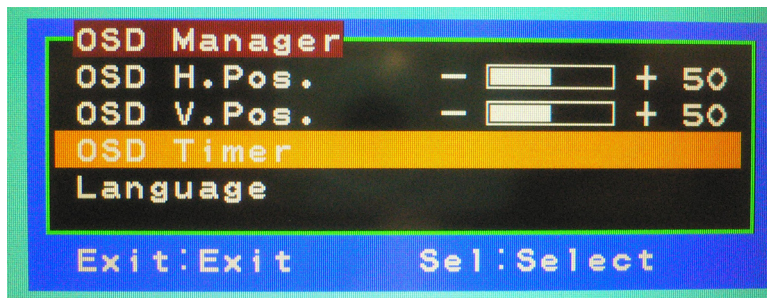

- Sub-Menu



- Available Key Functions

	Move downward of the selection/decrease the gauge value of the selected option
	Move up of the selection/increase the gauge value of the selected option
	Select to confirm

A.2.1.6 Input Select

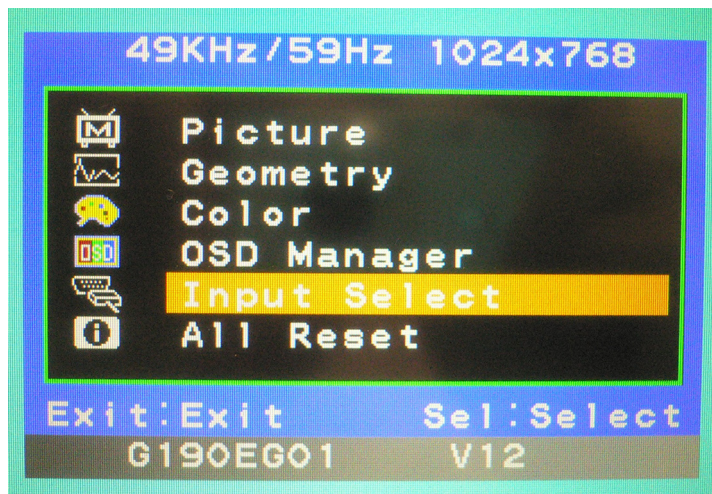

- Main Menu

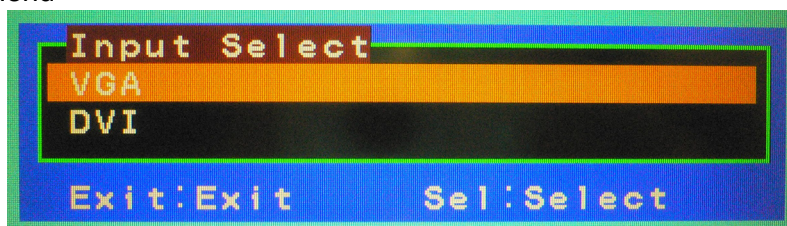

- Sub-Menu



- Available Key Functions

		Move downward of the selection/decrease the gauge value of the selected option
	Move up of the selection/increase the gauge value of the selected option	 Select to confirm

A.3 Installing Drivers for Windows OS

The touchscreen has drivers for Windows 2000/XP/XPT/XPE/2003/VISTA/7/WES7/2008/8, please read the instructions in CD-ROM Disk before installation. Drivers can be found in the Penmount 6000 folder on CD-ROM or Penmount website. Configuration and Calibration info are also included in the Penmount 6000 Installation Guide.

Note! *The driver manual are examples only. You must follow the flow chart instructions and pay attention to the instructions which then appear on your screen.*



Note! *USB & RS-232 interface driver is different, uninstall previous driver before installing a different driver.*



Note! *If there is any others OS driver need, could download at the web site: <http://www.penmount.com.tw>(Penmount 6000)*



Appendix **B**

Setting Serial Data for
Expansion

B.1 Setting Serial Data for Expansion

The several timings below are already programmed in this module.
The input synchronous signals are automatically recognized.

FPM-7061T

Resolution	HSYNC /KHz (+/-)	VSYNC /Hz (+/-)	PIXEL RATE /MHz
IBM, 720 * 400	31.469	70.087	28.322
VESA 640 * 480	31.469	59.940	25.175

FPM-7121T

Resolution	HSYNC /KHz (+/-)	VSYNC /Hz (+/-)	PIXEL RATE /MHz
IBM, 720 * 400	31.469	70.087	28.322
VESA 640 * 480	31.469	59.940	25.175
VESA 800 * 600	35.156	56.250	36.000
VESA 800 * 600	37.879	60.317	40.000
VESA 1024*768	48.363	60.004	65.000

FPM-7151T

Resolution	HSYNC /KHz (+/-)	VSYNC /Hz (+/-)	PIXEL RATE /MHz
IBM, 720 * 400	31.469	70.087	28.322
VESA 640 * 480	31.469	59.940	25.175
VESA 640 * 480	37.861	72.809	31.500
VESA 640 * 480	37.500	75.000	31.500
VESA 800 * 600	35.156	56.250	36.000
VESA 800 * 600	37.879	60.317	40.000
VESA 800 * 600	48.077	72.188	50.000
VESA 800 * 600	46.875	75.000	49.500
VESA 1024*768	48.363	60.004	65.000
VESA 1024*768	56.476	70.069	75.000
VESA 1024*768	60.023	75.029	78.750

Note!  Even if the preset timing is entered, a little adjustment of the functions such as Horizontal period, CLK-delay and display position, are required. The adjusted values are memorized in every preset number.

Note!  This module recognizes the synchronous signals with near preset timing of the frequency of the HS and Vsync, even in the case that the signals other than the preset timing that were entered.

Note!  Because adjustments may not fit, such as differing magnifying ratios or, in the case that you use it except for the display timing that was preset. Recommend best resolution as 1920*1080.

B.2 Touch screen RS232 Connector Pin Definition

Pin	RS232
1	-
2	TXD
3	RXD
4	DTR
5	GND
6	DSR
7	RTS
8	-
9	-

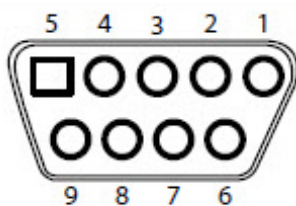

www.advantech.com

Please verify specifications before quoting. This guide is intended for reference purposes only.

All product specifications are subject to change without notice.

No part of this publication may be reproduced in any form or by any means, electronic, photocopying, recording or otherwise, without prior written permission of the publisher.

All brand and product names are trademarks or registered trademarks of their respective companies.

© Advantech Co., Ltd. 2015

Free Manuals Download Website

<http://myh66.com>

<http://usermanuals.us>

<http://www.somanuals.com>

<http://www.4manuals.cc>

<http://www.manual-lib.com>

<http://www.404manual.com>

<http://www.luxmanual.com>

<http://aubethermostatmanual.com>

Golf course search by state

<http://golfingnear.com>

Email search by domain

<http://emailbydomain.com>

Auto manuals search

<http://auto.somanuals.com>

TV manuals search

<http://tv.somanuals.com>