



GREENPOWER

# HY2000<sup>sei</sup> HY2800<sup>si</sup> PORTABLE INVERTER **USER MANUAL**



**HYUNDAI**

# HYUNDAI

LICENSED BY HYUNDAI CORPORATION, KOREA

HY2000-2800 UG\_EN  
© 2014 MIDLAND POWER INC.

Thank you for purchasing this Hyundai GreenPower portable inverter generator.

Please register your product in order for us to ensure your continued satisfaction.

This manual covers the safety, operation and maintenance procedures for the HY2000si and HY2800sei.

All information in this publication is based on the latest product information available at the time of approval for printing.

No part of this publication may be reproduced without written permission. If a problem should arise, please contact us by using the contact information at the end of this manual.

It is important that this manual be read and fully understood before operating the generator set. Failure to do so may cause serious injuries or equipment damage, and may void the warranty.

**THIS PRODUCT MEETS ALL  
CERTIFICATION REQUIREMENTS FROM**



**248027**



California Environmental Protection Agency

 **Air Resources Board**

## **CONTENTS**

- 5 Safety Precautions
- 6 AC Safety Guidelines
- 7 Identification of Components
- 8 Pre-operation Inspection
- 9 Fuel Level Check
- 10 Air Filter Check
- 11 Initial Startup
- 13 Operating Your Generator
- 18 Shutting Off Your Generator
- 19 Maintenance
- 24 Troubleshooting
- 28 Specifications
- 30 Warranty
- 33 Glossary
- 35 Transfer of Ownership and Warranty Card
- 37 Warranty Registration Card

## SAFETY PRECAUTIONS

This generator is designed to give safe and dependable service if operated according to instructions. Read and understand this manual carefully before operating the generator, failure to follow instructions could result in serious injury or death.

Engines give off carbon monoxide, an odorless, colorless, poison gas. Breathing carbon monoxide can cause nausea, fainting or death. Do not operate the generator indoors or in a confined area and make sure the working environment is well-ventilated.

The exhaust and muffler becomes very hot during operation and remains hot for a while after stopping the engine. Make sure to read all warning labels. Be careful not to touch the muffler while it is hot. Let the engine cool before storing the generator indoors.

When storing gasoline or equipment with fuel in tank: Store away from furnaces, stoves, water heaters or other appliances that have a pilot light or other ignition source because they can ignite.

## OPERATING INSTRUCTIONS

- Operate the generator according to instructions for safe and dependable service.
- Always perform a pre-operation inspection before starting the engine.
- Properly clean and maintain the equipment.
- Make sure to read and understand all warning labels.
- Gasoline is a highly flammable and explosive liquid. Make sure to refuel in a well ventilated area with the engine stopped.
- When refuelling the generator, keep it away from cigarettes, open flames, smoke, and/or sparks.
- Connections for standby power to a building's electrical system must be done by a qualified electrician and must comply with all applicable laws and electrical codes. Improper connections may cause serious injuries to workers during power outages. When the utility power is restored, the generator may explode or cause fires
- Place generator at least 1 m (3 ft.) away from buildings or other equipment during operation.
- Operate the generator on a level surface. Tilting the generator may result in fuel spillage.
- Know how to stop the generator quickly and understand the operation of all controls. Never permit anyone to operate the generator without understanding the proper instructions.

- Do not operate the generator in rain or snow or allow any moisture to come in contact with the generator.
- Do not touch the spark plug while the generator is operating and shortly after the generator has been shut down.
- Keep children away from the generator when it is in use.

## AC SAFETY GUIDELINES

Before connecting the generator to an electrical device, or power cord:

- Make sure that everything is in right working order. Faulty devices or power cords can lead to an electrical shock.
- Turn off the generator immediately if the device begins to operate abnormally. Then disconnect the device and investigate the problem.
- Make sure that the electrical rating of the device does not exceed that of the generator. If the power level of the device is between the maximum output power and the running power of the generator, the generator should not be used for more than 30 minutes.
- The connections from the generator to the household power supply should be done by a professional electrical technician. Improper connections may lead to a fire hazard or damages to the generator set.

## MAINTENANCE SAFETY

- After any maintenance is performed, wash your body immediately using soap and clean water. Repeated exposure to lubricant may cause skin irritation.
- Do not clean the filter sponge with flammable fluids, such as gasoline, or explosion may occur.
- Turn off the generator set before performing any maintenance. Otherwise it can cause severe personal injury or death.
- Allow the generator set to cool down before performing any maintenance.
- Always wear safety glasses when cleaning the generator with air.
- Do not clean the generator set with a pressure washer because it may cause damage to the generator set.
- Before working with batteries, ventilate the area, wear safety glasses, do not smoke and always disconnect the negative cable first and reconnect it last.
- Use rubber gloves when coming into contact with engine oil.
- Always stop the generator set before removing the oil filler cap.
- Only qualified maintenance personnel with knowledge of fuels, electricity, and machinery hazards should perform maintenance procedures.

## OTHER SAFETY HAZARDS

- To avoid breathing in poisonous carbon monoxide from the exhaust gases, adequate ventilation should be provided if the generator set is running in a partially enclosed space.
- If the generator set is stored outdoors, check all the electrical components on the control panel before each use.
- Moisture can damage the generator and can lead to an electric shock.

## IDENTIFICATION OF COMPONENTS

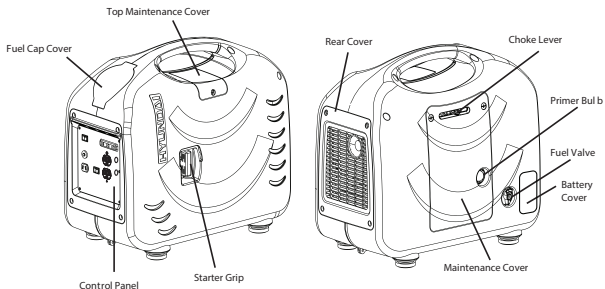

HY2000 Front Panel

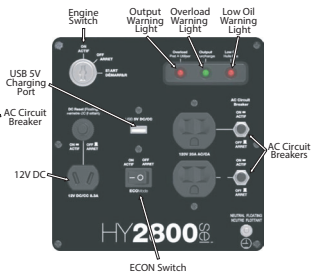

HY2800 Front Panel

## PRE-OPERATION INSPECTION

### WARNING

- Ensure that the generator is on a level surface and the engine is turned off before inspection.

### ENGINE OIL INSPECTION

Use high-detergent, premium quality, 4-stroke engine oil. Select the appropriate viscosity for the average temperature in your area.

1. Loosen the cover screws and remove the maintenance cover (refer to fig.).
2. Remove the oil filler cap and wipe the dipstick clean (refer to fig.). Check the oil level by inserting the dipstick into the filler neck without rotating it.
3. If the level is low, fill to the upper limit of the oil filler neck with the recommended oil.
4. Reinstall the maintenance cover and tighten the cover screws.

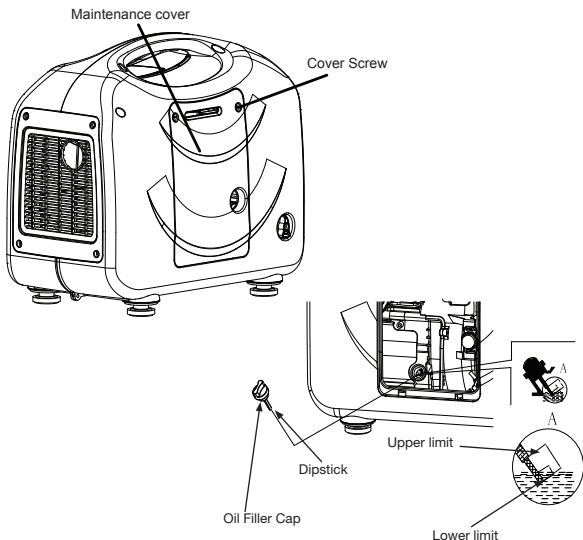



**NOTICE**

The oil alert system is designed to prevent engine damage caused by an insufficient amount of oil in the crankcase. Before the oil level in the crankcase falls below a safe limit, the oil alert system will automatically shut down the engine. If the oil alert system shuts down the engine, the oil alert indicator will come on when you operate the starter and the engine will not run. If this occurs, add engine oil.

**FUEL LEVEL CHECK**

1. Check fuel level display located on top of generator gas tank.
2. Refill the fuel tank if the level is low. Refuel carefully to avoid spilling fuel. Do not fill above the upper limit mark (Refer to Fig.).

**CAUTION**

- Gasoline is highly flammable and explosive. Keep the engine away from heat, spark or open flame.
- Refuel in a well-ventilated area with the engine stopped.
- Only handle fuel outdoors.
- Wipe up spills immediately.
- Avoid getting dirt, dust, or water in the fuel tank.
- Never use an oil/gasoline mixture or dirty gasoline.
- Do not use fuel containing alcohol. Fuel system damage or engine performance problems will result from the use of fuels that contain alcohol.
- Avoid repeated or prolonged contact with skin or breathing of fuel vapor.

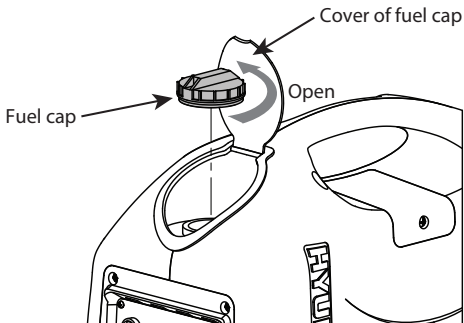

## CHECK THE AIR FILTER

### WARNING

Never run the engine without the air filter. Rapid engine wear will result from contaminants, such as dust and dirt, being drawn through the carburetor into the engine.

1. Remove air filter cover and sponge.
2. Inspect filter sponge for dirt and debris.
3. Clean filter sponge by soaking in gasoline, ring out before reinstalling.
4. Replace air filter every 24 months or when necessary.

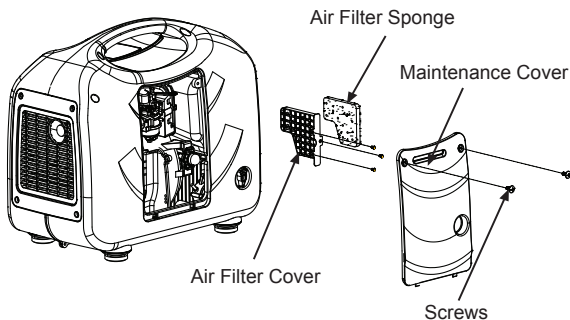

## INITIAL STARTUP

### WARNING

We know you're excited to get using your generator. Please be sure to follow the setup, operation, and shut off instructions below thoroughly to ensure the best lifespan for your generator.

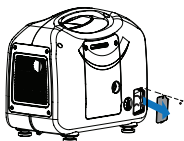

1. Setup the Battery (**HY2800 ONLY**): Remove the Battery Access Panel from the unit by unscrewing the screw at the top and releasing the panel.



2. Connect the Battery (**HY2800 ONLY**): locate and connect the loose connectors from the battery wiring harness and the main wiring harness. The battery is now connected to the unit.

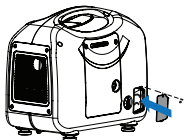

3. (**HY2800 ONLY**) Re-install the Battery Access Panel onto the unit. Ensure the screw is fastened properly.

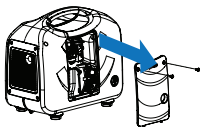

4. Remove the main engine access panel from the unit by unscrewing the (2) screws at the top of the unit.

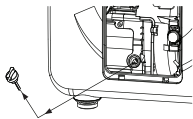

**5.** Locate, unscrew, and remove the Oil Dipstick, exposing the internal engine compartment. Be sure not to allow any dust or debris near the engine during this time.

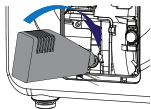

**6.** Pour in the full contents of the 450 mL oil bottle provided with your unit, or fill to the full mark located on the dipstick.

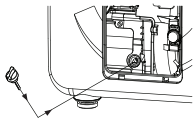

**7.** Re-install the Oil Dipstick and fasten tightly. Wipe away any excess oil. For best results, drain and refill the engine oil after the first 20 hrs of use, and every 50 hrs thereafter. Do not remove the Oil Dipstick when the engine is warm from prior use.

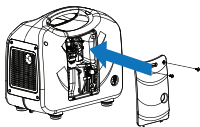

**8.** Re-install the Engine Access Panel onto the unit, ensuring that all (2) screws are fastened properly.



**9.** Remove the fuel cap, exposing the fuel tank. Be sure not to allow any dust or debris near the engine during this time. Pour 91 octane unleaded gasoline into fuel tank, and replace the fuel cap.

## OPERATING YOUR GENERATOR

Before using generator, a ground wire must be connected to the ground terminal. The Ground terminal is located on the Front Panel. Before using the ground terminal consult a qualified electrician.

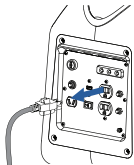

1. Disconnect all devices from the generator.

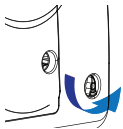

2. Open the fuel valve by turning the fuel valve knob from "off" to "on". Make sure the valve is turned all the way, to ensure that the valve has been fully opened for fuel to pass through.



3. Turn choke to "closed" or OFF position. Leave the choke in the "Open" position if the generator is still warm from recent use, or if the air temperature is higher than 50°F (10°C).

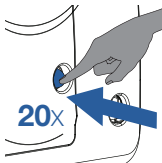

4. Locate and press primer bulb 15-20 times to move fuel through the lines and into the engine.

Note: This step is only necessary when the engine is cold



**5a. (HY2800 Electric only, for HY2000 and manual start proceed to 5b)** Turn Power switch to "Start" for 5 seconds to start engine. If the engine does not start, the battery may be dead, proceed to step 5b to start the engine. Running the engine charges the battery.

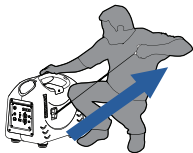

**5b.** Pull Recoil handle until engine starts. Several pulls may be required until engine starts. Do not release the pull cord at the end of a pull, this will damage the recoil assembly. Bring the pull handle back down to the unit by hand.



**6.** Once the generator has started, wait at least 30 seconds for it to warm up, and then you may slowly open the choke lever until it is fully open, or OFF.

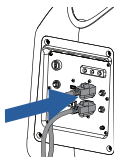

**7.** Connect all of your devices to the generator.

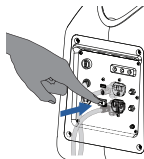

**8.** Turn EcoMode switch to "On". This will reduce the output to a level where the generator will only produce enough power for the connected devices. The reduction of extra, unused power saves fuel.

Connections for standby power to a building's electrical system must be done by a qualified electrician and must comply with all applicable laws and electrical codes. Improper connections may cause serious injuries to electrical worker during power outages. Additionally, the generator may explode or cause fires when the utility power is restored.

**WARNING!**

- To prevent electrical shock from faulty appliances, the generator should be grounded.
- Limit operation requiring maximum power to 30 minutes.
- Do not exceed the current limit specified for any one receptacle.
- Do not connect the generator to a household circuit.
- Do not modify or use the generator for other purposes than it is intended for.
- Be sure to use properly isolated cable when an extension cable is required.
- Limit length of extension cables to 60 m for cables of 1.5 mm wire thickness and 100 m for cables of 2.5 mm wire thickness.
- Keep the generator away from other electric cables or wires, such as a distribution network.
- The DC receptacle can be used while the AC power is in use. If you use both at the same time, be sure not to exceed the total power for AC and DC.
- Before connecting a device to the generator, make sure the electrical rating of the device does not exceed the electrical rating of the generator.
- Be sure the device is turned off before plugging in the power cord.
- When the output indicator light (green) is OFF, and the overload indicator light (red) is ON, flip the engine switch to the STOP position, stop the engine at once and then start the engine again.

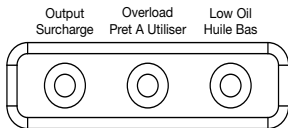

## NOTICE

- Under normal operating conditions, the output indicator light (Green) will be ON
- When a connected device draws high startup power the overload and output indicator light may briefly illuminate, but this is to be expected. Once the device starts up the overload indicator light will shut off and the output light will remain green. If the generator is overloaded (in excess 100W), or if there is a short circuit in a connected device, the overload indicator light (Red) will be ON.
- Substantial overloading that continuously lights the overload indicator light (red) may damage the generator. Marginal overloading that temporarily lights the overload indicator (red) may shorten the service life of the generator.
- If the oil level falls below a safe limit, the low oil indicator light (Red) comes on and the engine will be automatically stopped. If the engine stops or the low oil indicator light comes on when you pull the starter grip, check the engine oil level before troubleshooting in other areas. (Refer to Fig.)
- A hot engine will not start if there is too much gasoline in the cylinder. If this happens, wait for 5 to 10 minutes for the engine to cool down before starting.
- The engine will stop automatically when it is out of gasoline.
- When the output indicator light (green) does not light and the overload indicator light (red) lights instead, set the engine switch to STOP, stop the engine at once and then start the engine again.
- If the engine stops and cannot be restarted, check oil level before troubleshooting other possibilities.
- Ensure ECON switch is off before turning on any connected devices.

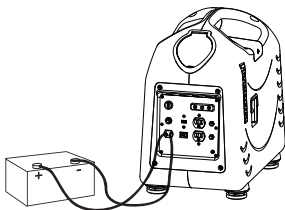



**FOR DC OPERATION**

***Do not leave generator unattended when charging batteries. Stop charging when the voltage of the batteries is above 16V. Failure to monitor charge level may result in damage to the battery or personal injury.***

The DC receptacle may be used while the AC power is in use.

The overloaded DC circuit will trip the DC circuit protector. If this happens, disconnect the DC load before pushing in the circuit protector to resume operation.

1. Set the ECON switch to the OFF position.
2. Connecting the battery charging cable.
  - Connect the battery charging cable to the battery.
  - Plug the charging wires into the DC outlet of the generator.
  - Connect the positive (Red) terminal of the charging wire to the positive (+) battery terminal and negative (black) terminal of the charging wire to the negative (-) battery terminal.
3. Turn the start switch to the ON position.
4. Set the DC breaker switch to ON position (refer to fig.).
5. Start the generator.

**NOTICE**

- The DC socket is only used for charging a 12V battery.
- When using the DC socket, turn the ECON switch to the OFF position.

**WARNING**

- The battery gives off explosive gases; keep sparks, flames and cigarettes away. Provide adequate ventilation when charging or using batteries.
- Battery posts, terminals, and related accessories contain lead components. Wash hands after handling.

An overloaded DC circuit, excessive current draw by the battery, or a wiring problem will automatically trip (turn off) the DC breaker switch. If this happens, wait a few minutes before pressing the breaker switch to the ON position to resume operation. If the breaker switch continues to go OFF, discontinue charging and contact your authorized dealer.

## SHUTTING OFF YOUR GENERATOR

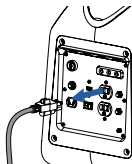

1. Disconnect all devices from the generator.

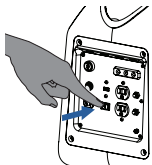

2. Turn EcoMode switch to "Off".

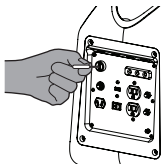

3. Turn Power switch to "Off".

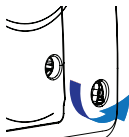

4. Close the fuel valve by turning it to "Off".

To stop the engine in an emergency, turn the engine switch "OFF". Always connect the ground terminal at the front panel to the ground (earth) to prevent electrical shock.

## MAINTENANCE

Proper maintenance is important because it will ensure safe, economical and trouble-free operation. It will also reduce air pollution. Improper maintenance may cause the generator to malfunction and can lead to serious injuries.

### MAINTENANCE SCHEDULE

#### WARNING

- Shut off the engine before performing any maintenance. When the engine is running, make sure the area is well ventilated.
- If you require a part for replacement, we strongly recommend using Hyundai OEM replacement parts. Do not use non-Hyundai parts. Contact customer service for replacement parts.
- Some of these maintenance techniques can be dangerous and should be performed by a qualified technician.

To ensure long-lasting durability and performance be sure to inspect and maintain your generator based on the schedule below:

ITEM	ACTION	EACH USE	1 MONTH (20 HRS)	4 MONTHS (50 HRS)	6 MONTHS (100 HRS)	YEARLY (200 HRS)
ENGINE OIL	Check Level	•				
	Change		•		•	
AIR FILTER	Check	•				
	Clean			• REFER TO NOTICE 1		
SPARK PLUG	Check				•	
	Replace					•
VALVE CLEARANCE	Check					• REFER TO NOTICE 2
COMBUSTION CHAMBER	Clean	EVERY 300 HOURS				
FUEL TANK AND FILTER	Clean				• REFER TO NOTICE 2	
FUEL LINE	Clean	EVERY 2 YEARS (REPLACE IF NECESSARY), REFER TO NOTICE 2.				

1. Service more frequently when used in dusty areas.
2. Should be serviced by an authorized dealer.

## AIR FILTER SERVICE

A dirty air cleaner will restrict air flow to the carburetor. To prevent carburetor malfunction, service the air cleaner regularly. Service more frequently when operating the generator in extremely dirty areas.

1. Loosen cover screws and remove the maintenance cover.
2. Remove air filter cover.
3. Remove air filter sponge (refer to fig.).
4. Check air filter sponge to make sure it is clean and in good condition. Clean sponge if dirty (refer to fig.). Replace sponge if damaged.

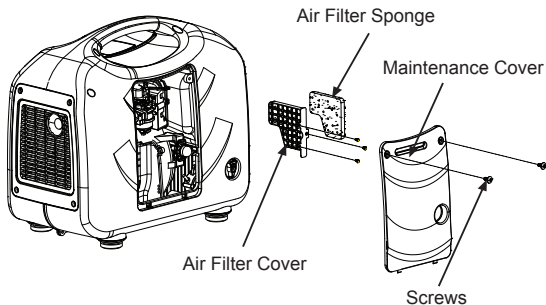

To clean the sponge:

- Clean air filter sponge in warm soapy water or non-flammable detergent. Allow to dry before reinserting into generator.
- Dip sponge in clean engine oil and squeeze out all excess oil. The engine will produce excess smoke if too much oil is left in the filter.
- Wipe dirt off the air filter cover using a moist rag.

## CHANGING THE ENGINE OIL

1. Set the start switch to the STOP position and make sure the fuel cap is fully closed.
2. Loosen the cover screws and remove the maintenance cover.
3. Place a container next to the engine to catch the used oil (refer to fig.).
4. Remove the oil filler cap/dipstick and drain the oil into the container by tilting the generator.

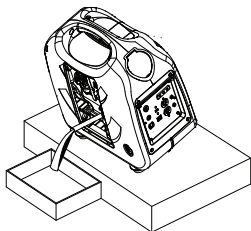

5. With the engine in a level position, add oil to the upper level mark. (refer to fig.).

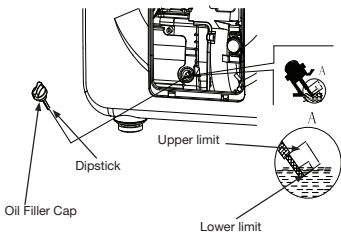

6. Reinstall the oil filler cap/dipstick securely.
7. Reinstall the maintenance cover and tighten the cover screws securely.

#### WARNING

- Make sure the start switch is in the STOP position before draining.
- Please dispose of used motor oil in a manner that is compatible with the environment. We suggest you take it in a sealed container to your local service station for reclamation. Do not throw it in the trash or pour it on the ground.
- Do not use gasoline for cleaning since it is flammable and explosive under certain conditions.

## SPARK PLUG SERVICE

To insure proper operation the spark arrester should be cleaned thoroughly at least once every 100 hours of use.

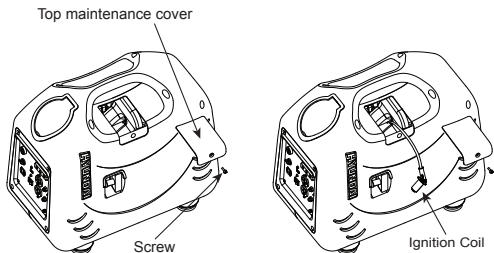

1. Remove the top screw and the top maintenance cover (refer to fig.).
2. Remove the ignition coil (refer to fig.).
3. Clean any dirt and debris around the spark plug base.
4. Use a wrench to remove the spark plug (refer to fig.).
5. Visually inspect the spark plug. Clean the spark plug with a brush if it is to be reused.
6. The spark plug clearance gap should be between 0.7 mm - 0.8 mm (0.028" to 0.03") (refer to fig.).

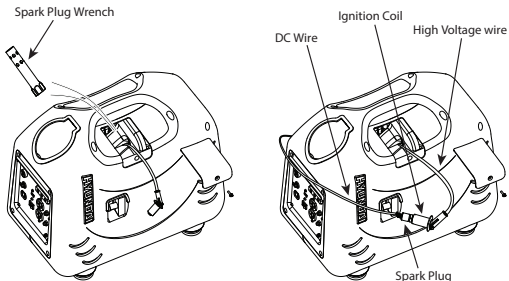

7. Install the correctly gapped spark plug back into the original position.
8. Reinstall the ignition coil securely.
9. Close the top maintenance cover and tighten the screw.

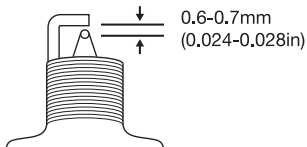

## TRANSPORTATION AND STORAGE

1. Do not overfill the tank.
2. Before attempting to transport allow generator to cool for at least 15 minutes.
3. To prevent fuel spillage, the generator should be secured upright in its normal operating position, with the start switch in the STOP position.
4. Do not drop or strike the generator when transporting.
5. Do not place heavy objects on the generator.

### WARNING

- Gasoline is extremely flammable and explosive under certain conditions.
- Do not smoke or allow flames or sparks in the area.

## STORAGE PROCEDURE

1. Drain fuel: remove gas tank cap, remove fuel filter and syphon fuel into an appropriate gasoline container. Rotate fuel valve to the open position and allow any remaining fuel to drain into the pot (refer to fig.).
2. Start the generator and allow fuel remaining in carburetor bowl to be used. Once the generator shuts off it can be stored.

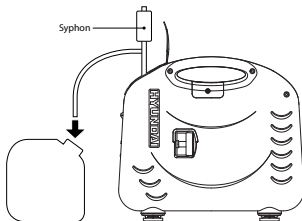

3. To drain oil:
  - Set the start switch to the STOP position and make sure the fuel cap is closed tight.
  - Loosen the cover screws and remove the maintenance cover.
  - Place a container next to the engine to catch the used oil.
  - Remove the oil filler cap/dipstick and drain the oil into the container by tilting the generator.
  - Remove the screw, top maintenance cover and the spark plug.
  - Fill the spark plug orifice with 2cc's (about a tablespoon) of fresh oil. Pull the start motor 3-4 times to distribute the oil.
  - Reinstall the spark plug, top maintenance cover and screw securely.
  - Pull the starter grip slowly until you feel resistance, then return the starter grip gently. This closes the valves so moisture cannot enter.

## TROUBLESHOOTING

If the generator still does not start, have an authorized Hyundai repair technician diagnose and repair the problem. Attempting service or repair without the proper training, tools and equipment may cause injury to you and/or others. It can also damage the generator or lead to hazardous conditions. For more information please refer to the troubleshoot guide below.

### WARNING

- Many troubleshooting procedures present hazards, which can result in severe personal injury or death. Only trained and experienced service personnel with knowledge of fuels, electricity, and machinery hazards should perform service procedures. Review Safety Precautions.
- A hot generator can cause severe burns. Always allow the generator set to cool before performing any maintenance.



PROBLEM	SYMPTOMS	CORRECTION
Generator will not start	Generator will not start	<ol style="list-style-type: none"> <li>1. The on/off switch is in the "Off" position. Switch to "On."</li> <li>2. The engine is out of gasoline.</li> <li>3. Engine choke is in wrong position. Adjust choke lever according to instructions on page 12.</li> <li>4. Fouled spark plug, replace with equal or greater quality plug. Refer to page 27 in your user's manual for a complete list of spark plug compatibility codes.</li> <li>5. Insufficient oil, add more oil.</li> <li>6. Clogged fuel line, inspect gas tank for debris.</li> </ol>
	High resistance when pulling recoil starter.	<ol style="list-style-type: none"> <li>1. The engine does not have enough oil - add oil.</li> <li>2. Air filter element obstructed by debris. Clean according to user manual instructions on page 18.</li> </ol>
Difficulty starting	Engine requires many attempts to start	<ol style="list-style-type: none"> <li>1. Disconnect load before starting.</li> <li>2. Incorrect oil being used. Please refer to the oil usage chart on page 27 in your user's manual.</li> <li>3. Fouled spark plug, replace with equal or greater quality plug. Refer to page 27 in your user's manual for a complete list of spark plug compatibility codes.</li> </ol>
Generator does not produce power	No indicator lights or display on front panel	<ol style="list-style-type: none"> <li>1. Generator circuit breaker off or tripped</li> <li>2. Remove all loads, reset breaker, and check device for defects. Do not exceed generator rating.</li> </ol>

	Overload indicator light keeps flashing	<ol style="list-style-type: none"> <li>Adjust choke lever according to instructions on page 12</li> </ol> <p>*When a connected device draws high startup power the overload and output indicator light may briefly illuminate, but this is to be expected. Once the device starts up the overload indicator light will shut off and the output light will remain green.</p> <ol style="list-style-type: none"> <li>Ensure device wattage consumption does not exceed the generator's maximum peak output.</li> </ol>
	No DC output	<ol style="list-style-type: none"> <li>Disconnect battery, reset breaker and test the battery for shorts.</li> <li>Clean battery connector nodes.</li> </ol>
Generator outputs unstable power	Connected device does not operate consistently	Verify device start up requirements (Wattage consumption). Do not exceed the generators maximum peak output.
	Device will not start up	<ol style="list-style-type: none"> <li>Remove all loads, reset breaker, and check device for defects. Do not exceed generator rating.</li> <li>Ensure device's wattage consumption does not exceed the generator's maximum peak output.</li> </ol>
	Engine idle unusually high or low	Carburetor in need of tuning. For details on how to adjust correctly please contact your local service centre, or contact Midland Intl Inc. at 1-877-528-3772.
Generator overheats	Operation is normal when generator is cool, overheating occurs within moments of start up.	<ol style="list-style-type: none"> <li>Atmospheric temperature high (excess of 35°C).</li> <li>Insufficient air circulation in vicinity of generator.</li> <li>Low oil viscosity, use 10W40 when temperatures exceed 30°C, 10W30 for temperatures between 0° ~ 30°C, and 5W40 for temperatures below 0°C.</li> <li>Fouled spark plug, replace with equal or greater quality plug.</li> </ol>

<p>Engine idle fluctuates</p>		<ol style="list-style-type: none"> <li>1. Carburetor in need of tuning. For details on how to adjust correctly please contact your local service centre, or contact Midland Intl Inc. at 1-877-528-3772. Missing ground reference on return side of differential analog output (external).</li> <li>2. Air filter element obstructed by debris. Clean according to user manual instructions on page 18.</li> </ol>
<p>Engine stops</p>	<p>Engine idles down and shuts off</p>	<ol style="list-style-type: none"> <li>1. The on/off switch is in the "Off" position.</li> <li>2. The engine is out of gasoline. Add regular unleaded gasoline.</li> <li>3. Air filter element obstructed by debris. Clean according to user manual instructions on page 18.</li> <li>4. Adjust choke lever according to user manual instructions on page 12.</li> <li>5. Incorrect oil being used or insufficient oil level. Always ensure high oil levels, and use oil according to oil usage chart in user manual on page 27.</li> <li>6. Fouled spark plug, replace with equal or greater quality plug. Refer to page 27 in your user's manual for a complete list of spark plug compatibility codes.</li> </ol>
<p>Thick smoke released from exhaust</p>	<p>Exhaust fumes thick and dark</p>	<ol style="list-style-type: none"> <li>1. Adjust choke lever according to user manual instructions on page 12.</li> <li>2. Incorrect oil being used. Use oil according to oil usage chart in user manual on page 27.</li> <li>3. Air filter element obstructed by debris. Clean according to user manual instructions on page 18.</li> </ol>

## SPECIFICATIONS

	HY2000SI	HY2800SEI
<b>WATTS</b>	2200W Peak Power 2000W Running Power	2800W Peak Power 2600W Running Power
<b>AMPS</b>	Output Current 16.6A, Max Circuit 20.0A	Output Current 21.6A, Max Circuit 23.3A
<b>MOTOR</b>	3.8 HP 5500RPM 4-Stroke 125CC Hyundai Motor	5.3HP 5500RPM 4-Stroke 150CC Hyundai Motor
<b>START</b>	Manual Recoil	Manual Recoil and Electric Start
<b>OUTLETS</b>	Two 120V 21.6A AC, One 12V 8.3A DC	Two 120V 21.6A AC, One 12V 8.3A DC, One USB
<b>FUEL CAPACITY</b>	4.5 L	4.5 L
<b>MAX AC OUTPUT</b>	2200W	2800W
<b>FUEL TYPE</b>	Unleaded Gasoline (Minimum Octane of 91)	Unleaded Gasoline (Minimum Octane of 91)
<b>RUNNING TIME</b>	4.2 hours @75%	3.7 hours @75%
<b>NOISE LEVEL</b>	64dB @7m	65dB @7m
<b>FRAME</b>	33 mm Polypropylene	33 mm Polypropylene
<b>DIMENSIONS</b>	550x310x500 mm	550x310x500 mm
<b>WEIGHT</b>	32 kg	35 kg

## RECOMMENDED OIL USAGE

OIL GRADE	TEMPERATURE	SEASON
5W40	0° & below	Winter
10W40	20° to -5°	Spring/Fall
15W40	20° +	Summer
10W30	25° to -15	All season

## SPARK PLUG COMPATIBILITY

BRAND	HY2000SI	HY2800SEI
NGK	CR7HS	CR7HS
DENSO	U20FPR	U20FPR
CHAMPION	RZ10YC	RZ10YC
BOSCH	U24BC	U24BC

## WARRANTY

### WARRANTY TERMS AND CONDITIONS

Canadian distribution of Hyundai branded portable generators are distributed by:

Midland Power Inc.  
376 Magnetic Drive, Toronto, ON, Canada, M3J 2C4

This product is warranted to be free of defects in material and workmanship for two years from date of purchase. This warranty guarantees that any defective parts will be repaired or replaced at no cost, including diagnosis and replacement parts.

Limited Warranty periods:  
Recreational/residential use: 2 years limited.  
1st year, parts and labour.  
2nd year parts only.

v

Commercial use: 6 months limited, parts and labour

This limited warranty begins at the initial time of retail purchase and covers manufacturer's defects caused by a defect in components or workmanship during the two-year (2-year) period. The warranty coverage is continual from the initial date of purchase and does not restart at anytime under any circumstances. This limited warranty is valid for residential or recreational applications only and only when the generator receives all necessary preventative maintenance as described in the Hyundai Generators "Operation Manual." The repair or replacement of a generator will take place within a reasonable period of time during normal business hours. All repair and replacement parts shall be warranted for (90) days after the initial date of installation or purchase.

### Limitation of Remedies and Disclaimers

Midland International Inc. disclaims any responsibility for loss of time or use of the generator in a recreational vehicle or any vehicle in which the generator is installed, transportation, commercial loss, or any other incidental or consequential damage. Any implied warranties are limited to the duration of this written warranty. THE FOREGOING LIMITED WARRANTY IS EXCLUSIVE OF AND IN LIEU OF ALL OTHER WARRANTIES OF MERCHANTABILITY, FITNESS FOR A PARTICULAR PURPOSE AND OF ANY OTHER WARRANTY WHETHER EXPRESS OR IMPLIED.

Consumable parts, such as oil or fuel filters, fuel cut off valve, brushes, fuel injection nozzle valve, lubricant, or ignition plug, are not covered under this warranty. All expenses incurred in maintaining and replacing parts for generator shall fall on the purchaser. This warranty coverage does not include parts affected by accident and/or collision, corrosion or rust, normal wear, incorrect fuel type or fuel contamination, use in an application for which the product was not intended, unauthorized service, or any other misuse, neglect, incorporation or use of unsuitable attachments or parts. Damage to voltage regulators caused by failure to ground, shorting or overloading will not be covered under this warranty. Under this Warranty, we do not have the obligation to bear any transportation fees of any product to/from an authorized Warranty Center. Unauthorized alteration, installation or any cause other than defects in material or workmanship of the product will not be covered under the warranty.

#### **EXCLUSIONS**

##### **NOT COVERED BY THIS LIMITED WARRANTY:**

1. Normal engine/alternator wear
2. Damage caused by lack of maintenance as described in the Hyundai manuals, or negligence by using improper or impure motor oil, coolant, or fuel
3. Damage caused by accidents, improper installation or storage;
4. Damage caused by water ingestion, submersion, or external water damage
5. Damage or non-performance caused by operation of the generator set in a marine application
6. Damage caused by operation with improper fuel, or at speeds, loads, conditions, or modifications contrary to published specifications
7. Items not supplied by Hyundai, including, but not limited to; starting batteries, battery cables, external wiring, fuel lines, filters, etc. (refer to exclusions).
8. Repairs made during the warranty period, without first obtaining a case number from Hyundai

Batteries supplied with any generator product should be considered a bonus item and not covered by warranty. Batteries can be damaged by shock, shorting terminals, heat, acid spillage and a number of other factors that cannot be controlled after they have left our facility. It is the customer's responsibility to take great care when handling a battery so no spillage of acid will occur and cause corrosion; damage caused by battery acid is not covered under this warranty.

## Product Registration

Product registration is required for product support and warranty coverage. The owner's registration found in the user manual can be completed and mailed. You can also register online at [www.hyundaipower.ca](http://www.hyundaipower.ca). You should keep your receipt for proof of purchase.

## Warranty Claim Procedure:

Warranty service must be performed by one of our authorized service dealers. If you feel your generator is malfunctioning due to a defect or misuse, simply contact our customer support center for technical advice, a warranty claim or general information.

Do not return your generator to the place of purchase for repair. MIDLAND INTERNATIONAL INC. SHOULD BE CONTACTED TO PROVIDE A CASE NUMBER BEFORE WARRANTY WORK CAN BEGIN.

To obtain warranty service: Contact our customer support centre:

**TOLL FREE: 1-877-528-3772**  
**E-MAIL: [SUPPORT@HYUNDAIPOWER.CA](mailto:SUPPORT@HYUNDAIPOWER.CA)**  
**WEBSITE: [WWW.HYUNDAIPOWER.CA](http://WWW.HYUNDAIPOWER.CA)**



## GLOSSARY

**AC SOCKET** - The receptacle for the device plug used for AC application.

**AC CIRCUIT PROTECTOR** - It protects AC circuits from being damaged due to overload or short circuit by stopping the flow of electricity between the generator and device.

**AIR FILTER** - It removes dust from engine intake air.

**CARBURETOR** - A device used to properly mix fuel and air in the correct proportions and deliver the mixture into the engine's combustion chamber.

**CHOKE ROCKER** - It is used to provide proper starting mixture when the engine is cold. The choke lever must be pulled out to ON position when starting a cold engine.

**DC BREAKER SWITCH** - It protects DC circuits from being damaged due to overload or short circuit by stopping the flow of electricity between the generator and device.

**DC SOCKET** - The receptacle used for charging a 12 V battery

**DIPSTICK** - It seals off engine oil fill hole and is used for indicating the engine oil level.

**DRAIN PLUG** - A plug that can be removed to allow the fluid contents of the engine to be drained off.

**ECON SWITCH** - This system can be described as a load-dependent speed control-type governor that offers excellent fuel economy by automatically adjusting engine speed to the optimum level, given the usage load. This not only reduces fuel consumption and operating noise in the normal usage range, but it also keeps exhaust emissions to levels low enough to clear some of the strictest CARB and EPA emission standards.

**FUEL SWITCH** - It controls flow of fuel from fuel tank to carburetor.

**GROUND TERMINAL** - It connects generator to ground wire for grounding protection.

**OIL INDICATOR LIGHT** - Before the oil level falls below a safe limit, the Oil Indicator light (red) will go ON and the Oil Alert system will automatically stop the engine.

**OUTPUT INDICATOR LIGHT** - The output indicator light (green) is illuminated when the generator is operating normally. It indicates that the generator is producing power at the receptacles

**OVERLOAD INDICATOR LIGHT** - If the generator is overloaded, or if there is a short circuit in a connected device, the overload indicator light (red) will go ON. It will stay ON, and after about four seconds, the device will shut off and the output indicator light (green) will go OFF.

**RECOIL STARTER** - A pull cord is attached to the engine and you pull the T-handle attached to the starter cord assembly to spin the fly-wheel and start the engine.

**SPARK PLUG** - A device inserted in the head of an internal-combustion engine cylinder, which ignites the fuel mixture by means of an electric spark.

## OWNERSHIP AND WARRANTY TRANSFER INSTRUCTIONS:

Changes in ownership must be registered with Hyundai Power Equipment in order to ensure continued warranty and service support. Warranty support cannot be provided without registration (from original date of purchase and after transfer of ownership) This transfer form must be completed on or before the date that ownership change takes effect. Warranty coverage continues from original date of purchase and is not extended by transfer of ownership.

<b>HYUNDAI</b> POWER EQUIPMENT		<b>Transfer of Ownership and Warranty Card</b>																					
<b>Existing Owner Information</b>																							
First Name	Last Name	Company																					
Street Name and Number		City																					
Postal/Zip Code	Province/State	Phone Number																					
Other Contact Number	Fax Number	Email																					
<b>New Owner Information</b>																							
First Name	Last Name	Company																					
Street Name and Number		City																					
Postal/Zip Code	Province/State	Phone Number																					
Other Contact Number	Fax Number	Email																					
<b>Product Information</b>																							
The serial number can be found on the Generator, or on the exterior of the packaging.																							
Model Name	<table border="1"> <tr> <td></td><td></td><td></td><td></td><td></td><td></td><td></td><td></td><td></td><td></td><td></td><td></td><td></td><td></td><td></td><td></td><td></td><td></td><td></td><td></td> </tr> </table>																						
Serial Number																							
YYYY / MM / DD	YYYY / MM / DD	YYYY / MM / DD																					
Initial Date of Purchase	Warranty Expiration Add 2 years to initial date of purchase	Date of Transfer																					
NOTE: Transfer of ownership does not act as a warranty extension. The original 2-Year Warranty is effective as of the Initial Date of Purchase and continues after ownership has transferred. New owners should be made aware of expired or remaining coverage.																							



## REGISTRATION INSTRUCTIONS:

Ownership must be registered with Hyundai Power Equipment in order to ensure continued warranty and service support.

Please fill out the registration card below and mail it along with a copy of your receipt, and the original UPC barcode from your product packaging. The store, date of purchase and product purchase should be clearly visible on the receipt copy.

## YOU MAY ALSO REGISTER ONLINE BY VISITING OUR WEBSITE: WWW.HYUNDAIPOWER.CA

If you wish, you can confirm your registration by calling customer service at or by email at support@hyundaipower.ca. Please allow one week for mail delivery and processing.

Please mail all items to:

Midland Power Inc. Product Registration  
376 Magnetic Drive, Toronto, ON, Canada, M3J 2C4

<b>HYUNDAI</b> POWER EQUIPMENT		<b>Warranty Registration Card</b>	
<b>Existing Owner Information</b>			
First Name _____		Last Name _____	Company _____
Street Name and Number _____		City _____	
Postal/Zip Code _____	Province/State _____	Phone Number _____	
Other Contact Number _____	Fax Number _____	Email _____	
<b>Product Information</b>			
Model Name _____		Serial Number ( can be found on the Generator, or on the exterior of the packaging.)	
Initial Date of Purchase YYYY / MM / DD _____		Warranty Expiration Add 2 years to initial date of purchase YYYY / MM / DD _____	

## Free Manuals Download Website

<http://myh66.com>

<http://usermanuals.us>

<http://www.somanuals.com>

<http://www.4manuals.cc>

<http://www.manual-lib.com>

<http://www.404manual.com>

<http://www.luxmanual.com>

<http://aubethermostatmanual.com>

Golf course search by state

<http://golfingnear.com>

Email search by domain

<http://emailbydomain.com>

Auto manuals search

<http://auto.somanuals.com>

TV manuals search

<http://tv.somanuals.com>