

EVAX 25 / EVAX 50 / EVAX 100 / EVAX 150 / EVAX 200

VOICE EVACUATION INTERFACE SYSTEM

INSTALLATION INSTRUCTIONS

The EVAX 25 / EVAX 50 / EVAX 100 is a self contained amplifier, tone generator, digital message repeater and supervisory interface. It is designed to be used in conjunction with a UL listed Fire Alarm Control Panel (FACP) to provide a Listed Voice Evacuation Alarm System.

The FACP provides all initiating circuitry and a signaling circuit to the EVAX 25 / 50 / 100. The EVAX 25 / 50 / 100 provides its own internal supervision as well as supervision for its speaker lines. Any fault is reported back to the FACP. In normal standby the supervisory circuit from the panel is connected to a matching EOLR. Should the EVAX 25 / 50 / 100 suffer an internal failure or should there be any fault on the speaker line a contact would open and the FACP would report it as an open fault for that circuit.

The EVAX 25 / 50 / 100 is designed to be powered from 120 VAC at 60 Hz. The EVAX 25 will provide 25W to the speaker circuit. The EVAX 50 will provide 50W. The EVAX 100 will provide 100W. Speakers may be 25 or 70 Vrms (jumper selected, 25V is factory set).

MODELS

The EVX-25 / 50 / 100 are complete Voice Evacuation Modules, EVX-25E / 50E / 100E are complete modules with built-in tone generators capable of operating as a stand-alone Voice Evacuation Systems with only tone and microphone amplification. They are not equipped with power transformers or cabinets. The EVAX 25 / 25E / 50 / 50E / 100 / 100E / 150 / 150E / 200 / 200E are complete Voice Evacuation Panels. The EVX-50E / 100E are capable of operating as slave amplifiers when connected to the EVX-100 / 100E, which supplies source audio to the slaves. Different Model numbers are derived from the amplifier sizes used together: These multiple amplifier configurations are factory setup and pre-wired. When using any EVX 25E / 50E / 100E refer to installation instructions P/N B-5002 Rev. E.

EVAX 150	Contains 1) EVX-100	And 1) EVX-50E	2) Speaker Circuits
EVAX 200	Contains 1) EVX-100	And 1) EVX-100E	2) Speaker Circuits
EVAX 150E	Contains 1) EVX-100E	And 1) EVX-50E	2) Speaker Circuits
EVAX 200E	Contains 2) EVX-100E		2) Speaker Circuits

INSTALLATION

Installer must insure that all wiring and devices installed in system meet the following standards:

- National Electrical Code (NFPA 70)
- NFPA Standard 72
- Life Safety Code (NFPA 101)

Install equipment in a clean, dry environment, avoid installation where equipment could be subjected to vibration. Remove electronic assemblies from the enclosure prior to any drilling or punching of the enclosure. Where possible, make all cable entries from the rear or sides. Before making any modifications to the enclosure, be certain that they will not interfere with assemblies or batteries

Install equipment adjacent to FACP or FACP Annunciator to insure proper reporting and display of system Fault conditions..

WIRING (Refer to wiring and terminal designation diagrams)

1. Connect speaker lines to TB1 - 5(+) & 6(-), observe polarity and insure all speakers are connected likewise. For Class "A" (Style "Z")the returns are TB1 - 7(-) & 8(+).
2. Insure that the microphone is attached to connector P2. If Microphone is not installed insure that switch SN2 - 8 is in the OFF position.
3. Attach the appropriate EOLR for the FACP to TB3 - 3 & 4 and TB3 - 5 & 6. The TB3 term 5 & 6 value must be placed at the end of the speaker line as well. You must use EOLR value as specified in the FACP manufactures installation instructions for the indicating appliance circuit. Note: if your system includes one or more EVX-4Z zone splitters, the FACP EOLR is relocated. See EVX-4Z install instructions P/N 1-5022.
4. Connect FACP signaling circuit to TB1 - 3(+) & 4(-), Alarm Polarity (alarm polarity is shown).
5. Connect 120 VAC, 60 Hz, power to the black and white pigtail leads from transformer primary. Secure ground lead to grounding stud in cabinet.
6. Once power is on to the unit, connect battery wiring harness, Red (+) / Black (-). **Observe polarity.** Minimum battery size is 24V 7Ah. Maximum battery size is 18Ah on EVAX 25 / EVAX 50 and 24Ah on EVAX 100. (use two (2) 12V batteries connected in series, see typical installation diagram). If the unit does not have its own batteries and relies on an external power supply with battery back-up, insure that switch SN2 - 7 is in the OFF position. **NOTE:** Wiring for batteries is Non Power-Limited. Care must be taken to insure that all Power-Limited wiring maintain a minimum spacing of 1/4" from any Non Power-Limited wiring. If batteries must be located in separate enclosure, provide separate conduit run for battery wiring only.

Once all power and circuits are connected, the Green LED will remain on to indicate that the EVAX 25 / EVAX 50 / EVAX 100 is fully operational and all circuits are nominal.

BOSCH

EVAX 25 / EVAX 50 / EVAX 100 TERMINAL DESIGNATIONS

TB1:

TER 1 & 2 - Power Input 24-32V AC/DC (NOTE 1, 4)

TER 3 & 4 - FACP Signal Circuit Input - 10mA max. (Alarm Polarity shown) (NOTE 1, 4)

TER 5 & 6 - 25/70 Vrms Speaker Loop Style Y/Z (Class "A"/"B" start) (NOTE 2, 4)

TER 7 & 8 - 25/70 Vrms Speaker Loop Style Z (Class "A" return) (NOTE 2, 4)

Field wiring connections:

#6-32 wire clamp screw 14-18 AWG

#8-32 wire clamp screw 12-18 AWG

Horizontal wire entry terminal 18-26 AWG

Wire gauge determined by circuit load

TB3:

TER 1 & 2 (NOTE 1, 4)

Optional FACP Supervisory Circuit
(See installation instructions page 5
diagram 2 for details (32V - 0.4A
max.)). Factory set for none - J1
(Installed)

TER 3 & 4

FACP Signal/Supervisory Circuit
EOLR

TER 5 & 6

Matching EOLR for speaker
supervisory circuit

TER 7 (NOTE 1, 3, 5)

General purpose output (pulls to
circuit neg on fault condition
32V - 0.2A max). Not for Fire
Protective Signaling use.

TER 8 (NOTE 1, 3, 5)

Trouble input +24 VDC 5mA

NOTES:

- 1 - Intended for connection to Listed Class 2 / Class 3 (Power Limited) sources only.
- 2 - Power Limited
- 3 - Non-Supervised
- 4 - Supervised
- 5 - Terminating equipment must be installed in same room as EVAX25 / EVAX 50 / EVAX 100.

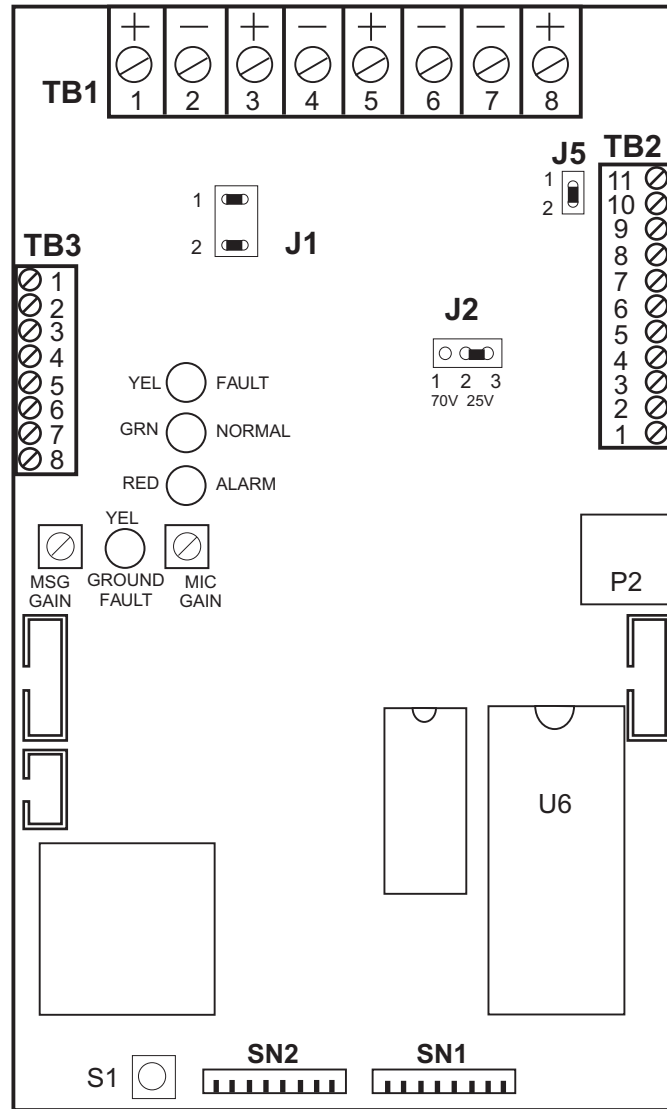

Tb2:

TER 1 - Circuit Neg

TER 2 (NOTE 1, 3)

Aux Audio Input
(0.5V nominal)
(1VRMS - 1mA max.)

TER 3 (NOTE 1, 3, 5)

PreAmp In/Out
(600 Ohm 0dBm)

TER 4 (NOTE 1, 3, 5)

Master - Programmable
+24VDC Active
Slave - +24VDC Input

TER 5 (NOTE 1, 3, 5)

Signal Active
Master - Out / Slave - In

TER 6 (NOTE 1, 3)

Aux Audio Enable
(+24V)(32V - 5mA max.)

TER 7 (NOTE 1, 3)

Aux Signal Activate
(+24V) (32V - 5mA max.)

TER 8 (NOTE 2, 3, 5)

Common Alarm Voltage +24V
condition (0.1A)

TER 9 (NOTE 2, 3)

Common Int V+ (+24V)
disconnected in alarm
condition (0.1A)

TER 10 (NOTE 2, 3)

V+ (+24V 0.1A)

TER 11 (NOTE 5)

Mic PTT (+24V 0.1A)



FACTORY DEFAULT SWITCH / JUMPER SETTINGS:

SN1

- 1 = OFF 8 sec. initial delay
- 2 = ON
- 3 = OFF
- 4 = ON 8 sec. repeat delay
- 5 = OFF
- 6 = ON Message On
- 7 = OFF 3 Repeats
- 8 = ON

SN2

- 1 = OFF Temporal Whoop Signal
- 2 = OFF
- 3 = OFF
- 4 = Fault Code Lock
- 5 = X Do not use
- 6 = AC Fault Delay
- 7 = ON Battery connected
- 8 = ON Mic connected

J1 A/B

1 - 2 = SHORT

J2

25 VRMS 2-3 = SHORT

70 VRMS 1-2 = SHORT

To change output voltage
move shorting block.

J5

1 + 2 SHORT = Ground Fault Enable

BOSCH

OPTIONS:

AUX +24VDC OUTPUT - TB2-4, 8, 9 & 10

These terminals provide a max. 200 mA of regulated 24VDC power for auxiliary functions. Do not exceed 200 mA load combined on these terminals. For connection to Listed General Signal devices only (Non-Fire Protective Signaling applications). Terminal 4 activation is programmed in the U6 EPROM chip. Standard chips are programmed for TB2-4 to go active +24VDC under these conditions: Aux Signal Active, Aux Audio Enable, Bell Circuit Active, RSI Active. Reprogramming of these functions must be done at the factory and require replacing EPROM U6.

CONNECTION OF AN AUX AUDIO SOURCE - TB2-1 & 2

An aux audio source from additional paging equipment may be connected to the EVAX 25 / 50 / 100 to augment an existing paging system. It is not intended for continuous signal input, but may be used for paging applications. For such an operation the Aux Audio Enable input, TB2-6, must be powered from Int V+, TB2-9. This is to insure that in the event of an alarm, the aux audio will not override the evacuation signal. See Wiring Diagram 5 for connection detail.

OPTIONAL SUPERVISORY CIRCUIT - TB3-1 & 2

In place of normal supervision via the signaling circuit, an alternate method may be employed using any supervisory circuit from the FACP. Connection would be made to Terminal Block 3, Ter. 1 and 2. This would provide a normally closed connection to the EOLR on Ter. 3 and 4. The relay contact in the circuit will open upon any trouble condition and report an open circuit trouble to the FACP.

NOTE, jumper shorting blocks A and B must be removed from **J1** if a circuit is to be connected in this manner. See Optional Supervisory Circuit Application (Wiring Diagram 2) for connection detail.

OPERATION

In normal standby the Green LED will remain on.

In alarm condition the Red LED will remain on as long as the unit is in alarm. Green LED will modulate with the audio level.

Default Factory Alarm Sequence settings: (Alarm Tone - 2 cycles Temporal Whoop, Message On - 3 Repeats)

Alarm Tone / Digital Message plays / Alarm Tone / Digital Message plays / Alarm Tone / Digital Message plays / unit reverts to Alarm Tone until alarm condition is cleared. If the Mic is keyed it will override both the tone and the message so a direct broadcast may be made. If this occurs during the initial sequence the digital message will be reset and will not repeat. When the Mic is keyed or when the message is played the Green LED will dim. The intensity of the Green LED will vary with the level of the broadcast audio. Under a fault condition, the Yellow LED will remain on. The Green LED will flash. The number of flashes display a code depending on the specific type of fault. When there is a fault condition the contact connecting the FACP signal circuit to the EOLR will open indicating the fault to the panel which will provide annunciation. During a ground fault condition, Yellow LED 4 will illuminate.

ELECTRICAL RATINGS:

	EVAX 25 / 25E	EVAX 50 / 50E	EVAX 100 / 100E
Primary Input Voltage	120 Vac @ 60 Hz	120 Vac @ 60 Hz	120 Vac @ 60 Hz
Primary Input Current	0.8 A @ 120 Vac	0.5 A @ 120 Vac	1.0 A @ 120 Vac
*Battery Input Current Standby	0.18 A / 1.1 A	0.15 A / 1.0 A	0.16 A / 1.1 A
Battery Input Current Alarm	1.1 A / 2.5 A	0.8 A / 1.1A	0.6 A / 2.0 A
Output power	25 Watt	50 Watt	100 Watt
Freq. Response	800 - 2800 Hz	400 - 4000 Hz	400 - 4000 Hz
Output Voltage	25 / 70 Vrms Selectable	25 / 70 Vrms Selectable	25 / 70 Vrms Selectable
**Optional 24 VDC input	1.3 A Standby 2.6 A Alarm 4.2 A Sine	1.0 A Standby 1.3 A Alarm 5.3 A Sine	1.6 A Standby 2.6 A Alarm 8.9 A Sine
Battery Charging Current	800mA	800mA	800mA
Minimum Battery Size	24V 7 AH	24V 7 AH	24V 7 AH
Maximum Battery Size	24V 18 AH	24V 18 AH	24V 24 AH
Battery Type	(2) 12V Gel Cell (in Series)	(2) 12V Gel Cell (in Series)	(2) 12V Gel Cell (in Series)
Battery Standby Operating Time:	24 - 60 Hours standby, 15 Minutes in Alarm		
Output Protection:	Power Limited, Open and Short Circuit protected		

*Battery input current measurements are determined by test conditions. Two values are shown. First value reflects the unit with a full speaker load and no auxiliary load. Second value reflects the unit with a full speaker load and a full auxiliary load of 0.5A in Standby and 0.75A in Alarm. Your actual load will vary depending on which and how many auxiliary devices, i.e...Zone Splitter, Remote Mic, Relays,...etc., are used. Insure that any current draw from an aux device is added into your final battery calculation.

**Input current measurements are determined by test conditions under UL 1711. Sine represents measurements made while the unit produces a continuous non-distorted sine wave of 1 KHz into the rated load of 25 / 50 / 100W at rated output voltage. Alarm is the average current the unit experiences delivering an alarm signal, Temporal Whoop, to the rated load. Standby is the current draw of the unit with all normal power on and aux., terminals fully loaded. Battery Standby is current draw from the batteries on loss of power and otherwise normal standby.

TESTING

Per NFPA 72 Chapter 7, 100% system test is required, at a minimum, annually. Additional testing may be required by the Local Jurisdiction.

BOSCH

EVAX 25 / 50 / 100 TYPICAL INSTALLATION

WIRING DIAGRAM 1

FIRE ALARM CONTROL PANEL

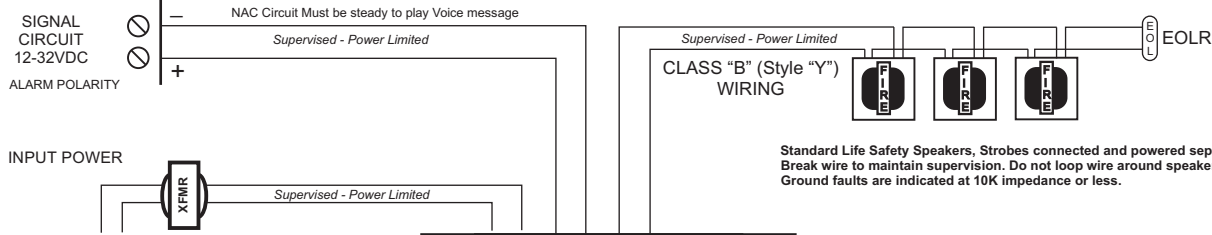

Standard Life Safety Speakers, Strobes connected and powered separately. Break wire to maintain supervision. Do not loop wire around speaker terminals. Ground faults are indicated at 10K impedance or less.

INPUT POWER

FACP
EOLR

MATCHING
EOLR
(SPEAKER
CIRCUIT)

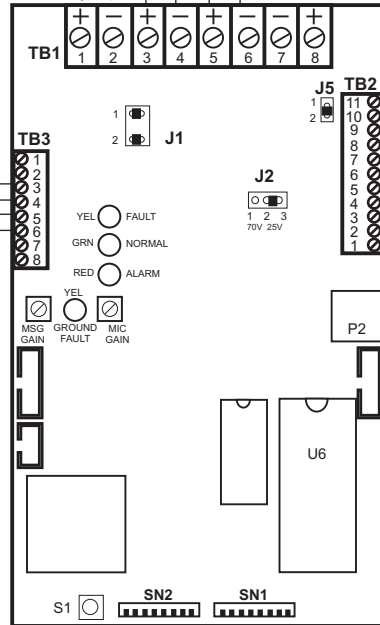

CLASS "A" (Style "Z")
WIRING

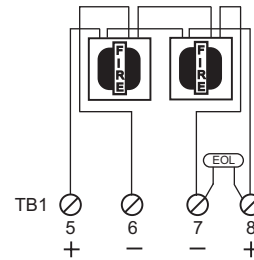

Supervised - Power Limited

CAUTION:
Break wire to maintain supervision.
Do not loop wire around speaker terminals.

Field wiring connections:

- #6-32 wire clamp screw 14-18 AWG
- #8-32 wire clamp screw 12-18 AWG
- Horizontal wire entry terminal 18-26 AWG
- Wire gauge determined by circuit load

Battery Wire Harness
Supervised - Non Power
Limited

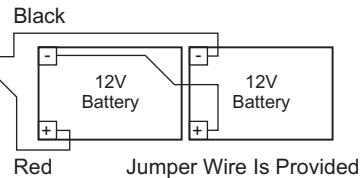

EVAX 25 / 50 / 100 CABINET LAYOUT

Input Power connection is Non-Power Limited. **DO NOT** route any Power Limited wiring within 1/4" of Input cabling.

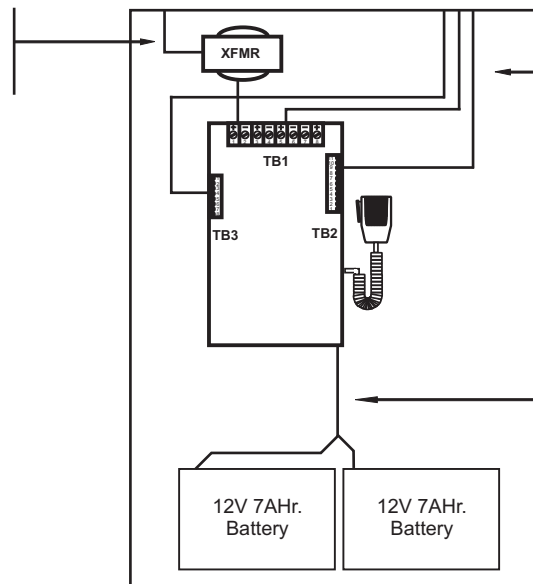

ALL wiring from terminal blocks is Power Limited. Use K.O. at top or side of cabinet for wire routing.

Battery cabling is Non-Power Limited. **DO NOT** route any Power Limited wiring within 1/4" of Input cabling.

BOSCH

EVAX 25 / 50 / 100 OPTIONAL SUPERVISORY CIRCUIT APPLICATION

WIRING DIAGRAM 2

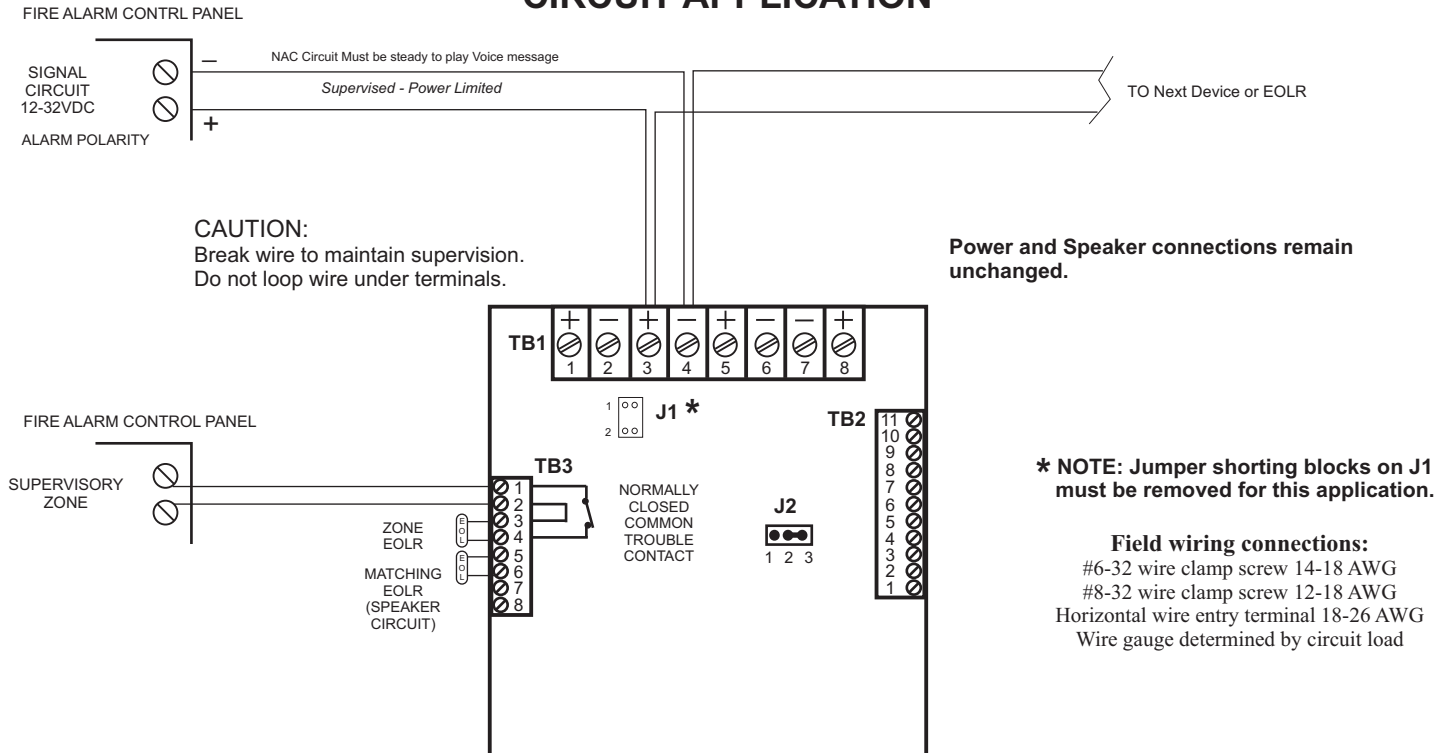

EVAX 25 / 50 / 100 ADDRESSABLE SYSTEM APPLICATION

WIRING DIAGRAM 3

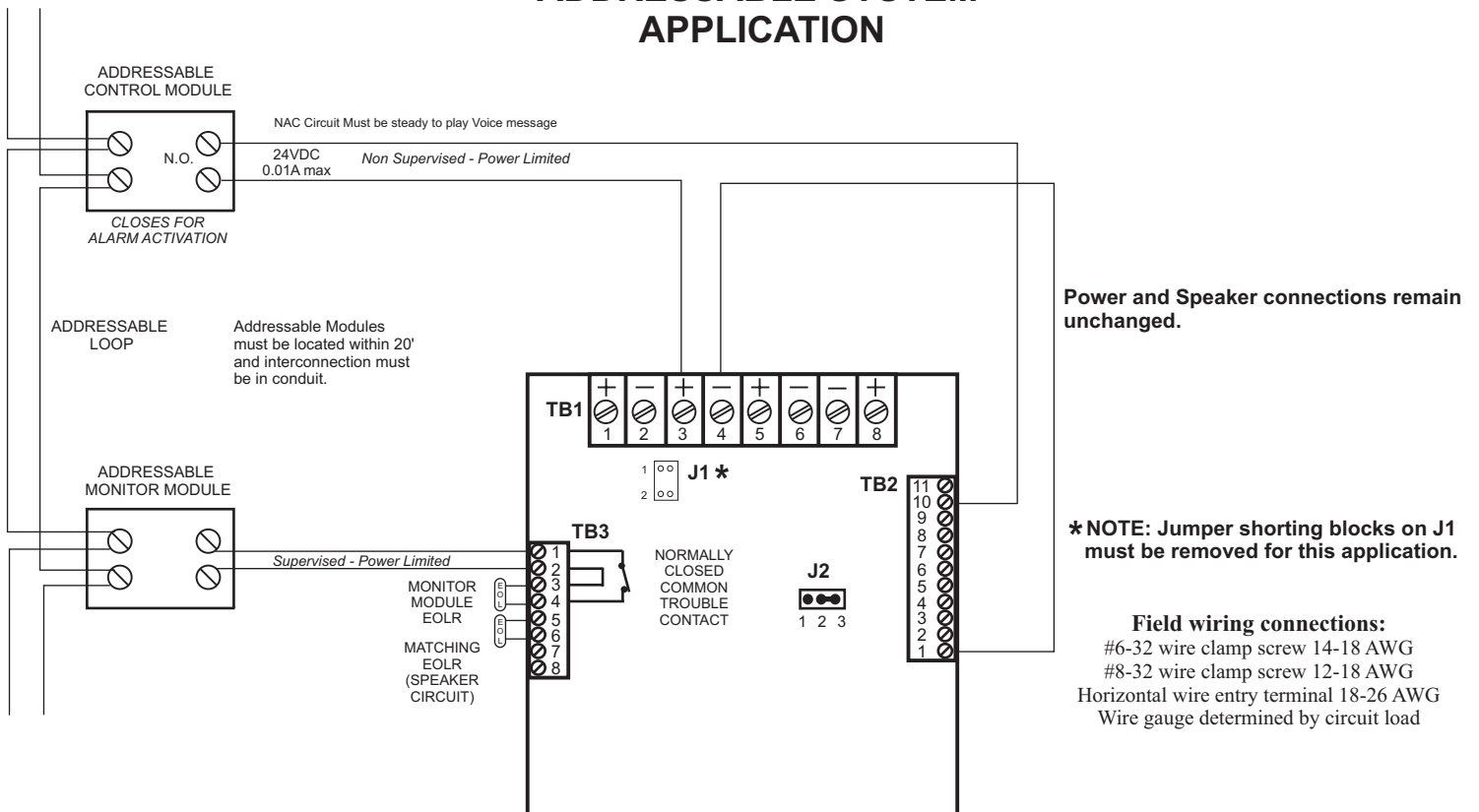

BOSCH

EVAX 25 / 50 / 100 MULTIPLE UNIT CONNECTION DETAIL

WIRING DIAGRAM 4

Non Supervised - Power Limited

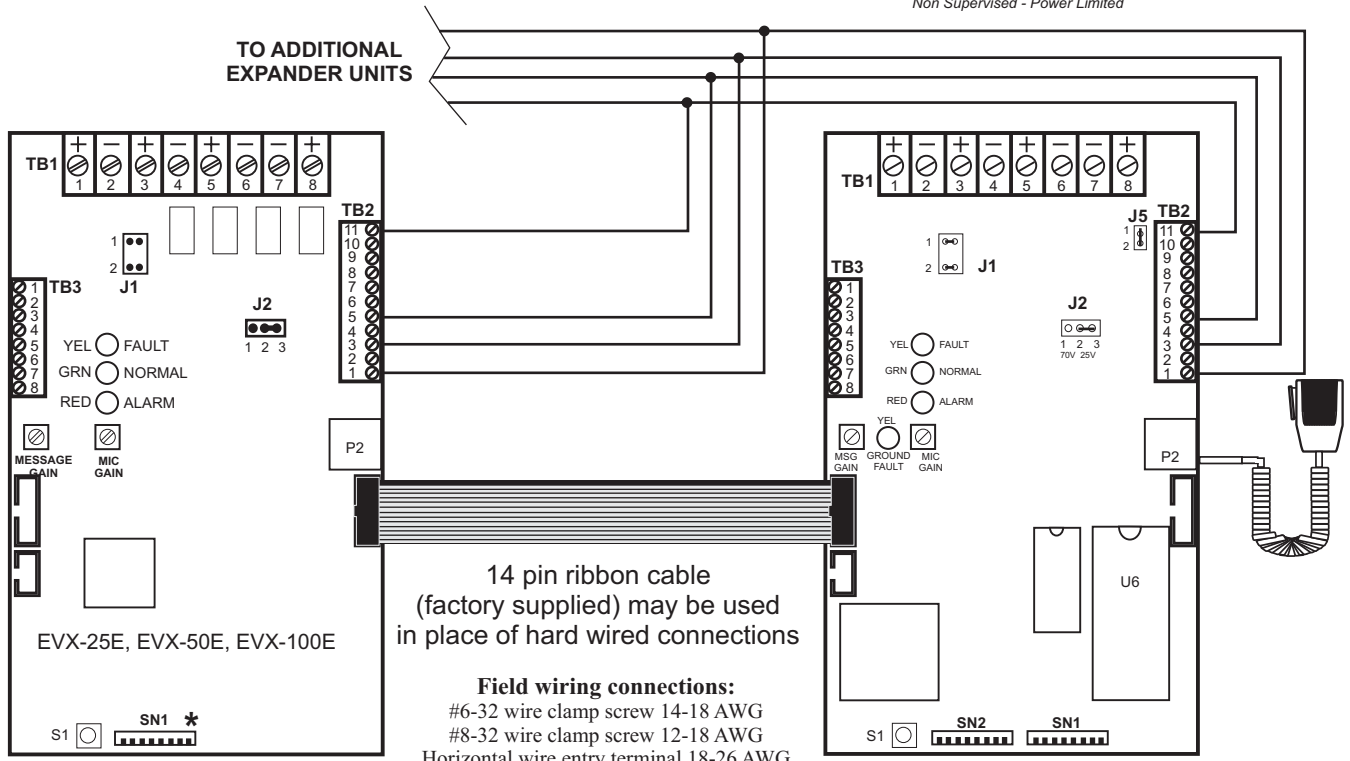

* NOTE: Switch SN2-8 must be in the OFF position for all units without Mic attached.

14 pin ribbon cable
(factory supplied) may be used
in place of hard wired connections

Field wiring connections:
#6-32 wire clamp screw 14-18 AWG
#8-32 wire clamp screw 12-18 AWG
Horizontal wire entry terminal 18-26 AWG
Wire gauge determined by circuit load

All Power, Supervisory and Speaker connections remain unchanged.

NOTE: Maximum number of units to be cascaded is 15

EVAX 25 / 50 / 100 AUX AUDIO ENABLE CONNECTION DETAIL

WIRING DIAGRAM 5

Field wiring connections:
#6-32 wire clamp screw 14-18 AWG
#8-32 wire clamp screw 12-18 AWG
Horizontal wire entry terminal 18-26 AWG
Wire gauge determined by circuit load

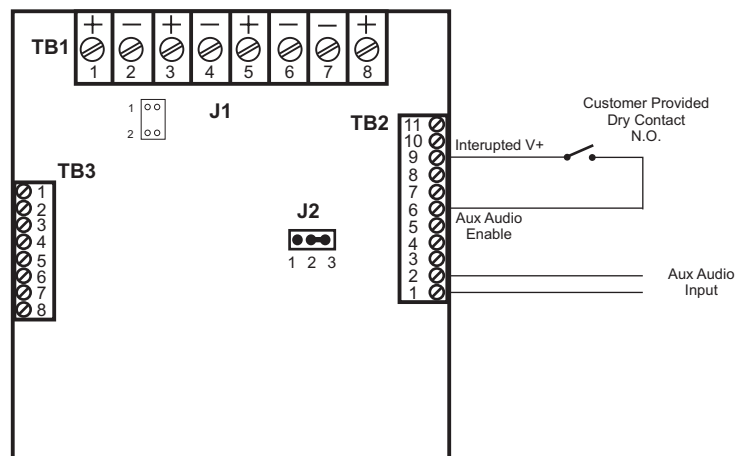

BOSCH

EVAX 25 / 50 / 100

SWITCH SETTINGS

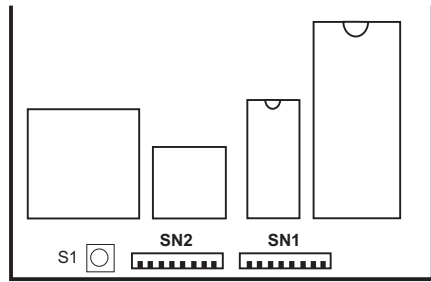

Switch Network Detail

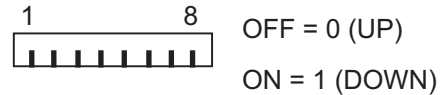

SN2 Default = 0/0/0/0/0/0/1/1

SW 1/2/3 Sets the evac tone.
 8 Settings: **0/0/0 Temporal Whoop**
 1/0/0 Hi Lo
 0/1/0 Horn
 1/1/0 Bell
 0/0/1 Empty
 1/0/1 Chime
 0/1/1 None
 1/1/1 1kHz Sine

SW 4 Sets the diagnostics mode.
 2 Settings: **0 Diagnostics off**
 1 Diagnostics on

SW 5 NA

SW 6 AC power failure report delay.
 2 Settings: **0 No delay**
 1 3 hour delay

SW 7 Batteries.
 2 Settings: 0 Batteries are not connected
1 Batteries are connected

SW 8 Microphone.
 2 Settings: 0 Microphone is not connected
1 Microphone is connected

SN1 Default = 0/1/0/1/0/1/0/1

SW 1/2/3 Sets the initial delay before the message starts to play. Tone sounds during delays.
 8 Settings: 0/0/0 No delay
 1/0/0 4 second delay
0/1/0 8 second delay
 1/1/0 12 second delay
 0/0/1 16 second delay
 1/0/1 20 second delay
 0/1/1 24 second delay
 1/1/1 28 second delay

SW 4/5 Sets the delay between repeats of the message.
 4 Settings: 0/0 4 second delay
1/0 8 second delay
 0/1 12 second delay
 1/1 16 second delay

SW 6 Sets the message play.
 2 Settings: 0 Message off
1 Message on

SW 7/8 Sets the number of times the message plays.
 4 Settings: 0/0 1 play
 1/0 2 plays
0/1 3 plays
 1/1 Continuous plays

Note: Default settings comply with UL 864 AND NFPA 72 operational requirements. Before changing any settings, verify compliance with Local Authority having Jurisdiction.

EVAX 25 / 50 / 100

TROUBLE CODES

When a unit goes into a Trouble Condition, the Yellow LED will remain on until the trouble is cleared. The Green LED will flash a Code to indicate the type of Trouble Condition. There will be a pause between repeats of the code. When multiple Trouble Conditions occur at the same time, the codes will add together. The number of flashes and associated Trouble Condition are listed below.

Code	Trouble	Code	Trouble
1	Power Failure	8	Amplifier Trouble
2	Open Speaker Circuit	16	Microphone Trouble
4	Shorted Speaker Circuit	32	Battery Trouble
6	External Trouble / Ground Fault		

* 6 flashes typically indicates "External Trouble", such as an EVX-RM. If LED 4 is on, the 6 flash indicates a ground fault. If both a ground fault condition and an external trouble occur simultaneously, the fault codes will **not** combine for 12 flash.

EVAX 25 / EVAX 50 / EVAX 100
END OF LINE RESISTORS

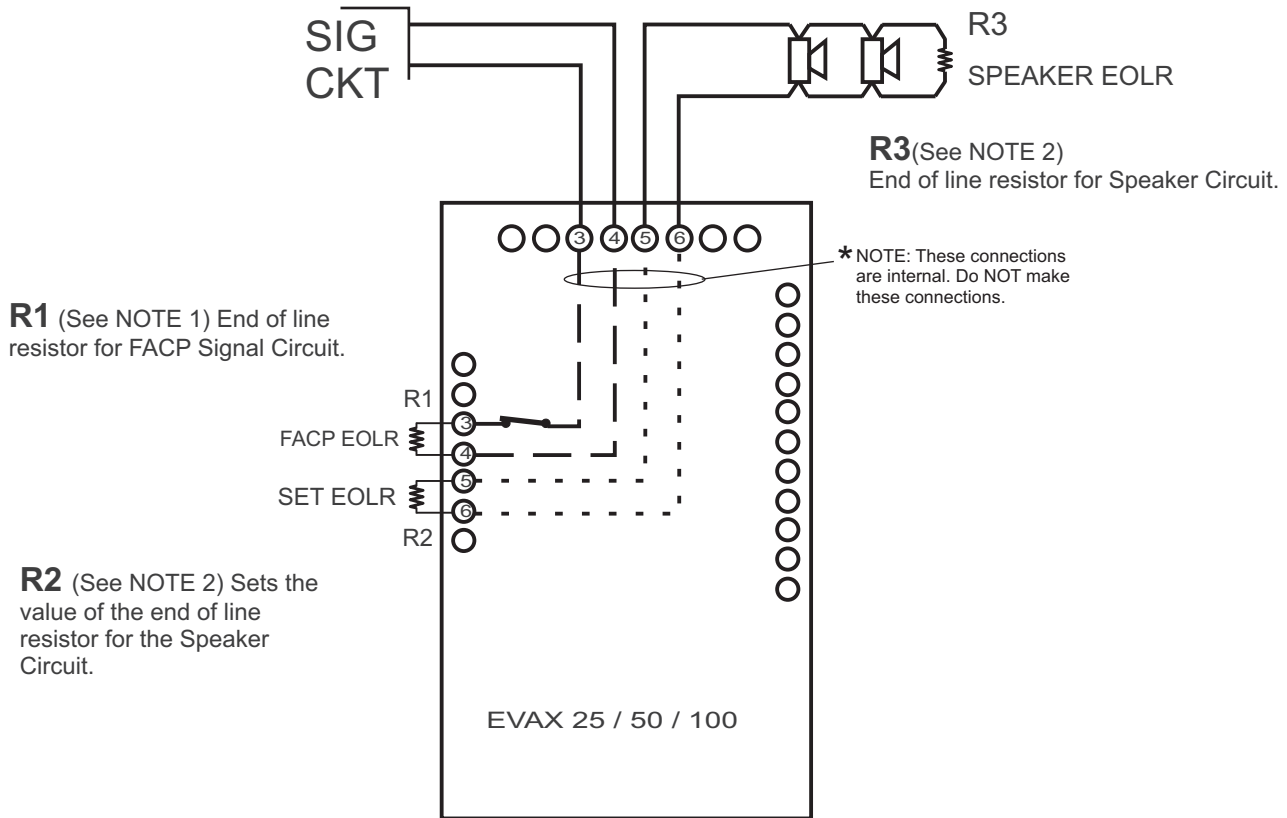

NOTE 1: If the Fire Alarm Signal Circuit requires a 4.7K end-of-line resistor, then R1 must be a 4.7K. Normally, this resistor is connected to the Signal Circuit through a closed Common Trouble contact. When the EVAX 25/50/100 goes into Trouble, the contact opens, producing an "Open" on that Signal Circuit and notifying the FACP.

NOTE 2: R2 and R3 must match each other. R2 "Sets" what the value of R3 needs to be. R2 tells the EVAX 25/50 what to expect on the end of the Speaker Circuit. If a Speaker EOLR (R3) already exists, simply match that value for R2.

Free Manuals Download Website

<http://myh66.com>

<http://usermanuals.us>

<http://www.somanuals.com>

<http://www.4manuals.cc>

<http://www.manual-lib.com>

<http://www.404manual.com>

<http://www.luxmanual.com>

<http://aubethermostatmanual.com>

Golf course search by state

<http://golfingnear.com>

Email search by domain

<http://emailbydomain.com>

Auto manuals search

<http://auto.somanuals.com>

TV manuals search

<http://tv.somanuals.com>