



Register your new Bosch now:
www.bosch-home.com/welcome



Hob



BOSCH

PKB6..F17., PKD6..F17., PKF6..F17., PKF6..F17G,
PKF65.F17., PKF67.F17., PKN6..F17., PKG6..F17.,
PKG6..FB1., PKD7..FB1.

[en] Instruction manual

PKB6..F17.

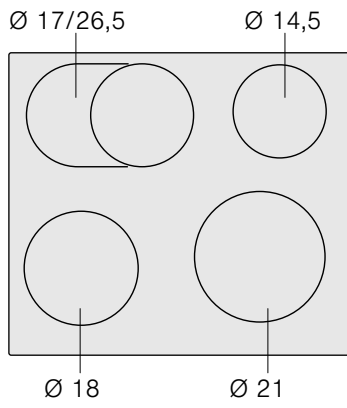

PKD6..F17.

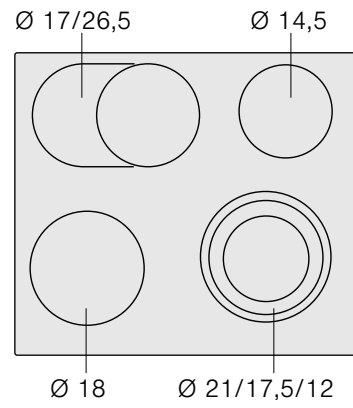

PKF6..F17.

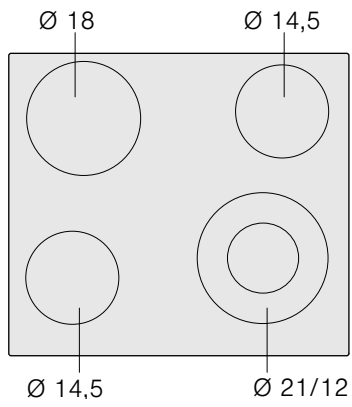

PKF6..F17G

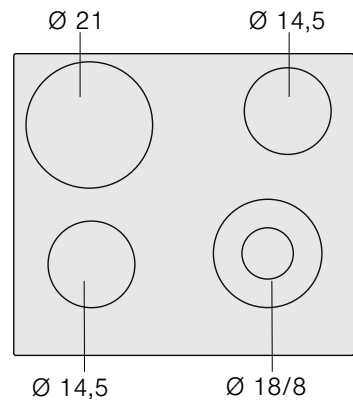

PKF65.F17., PKF67.F17.

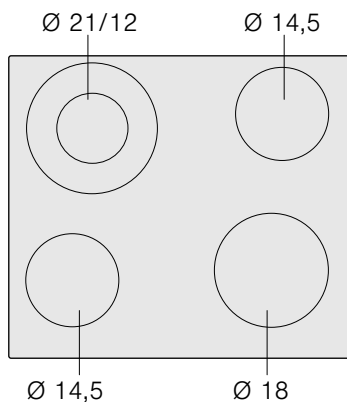

PKN6..F17.

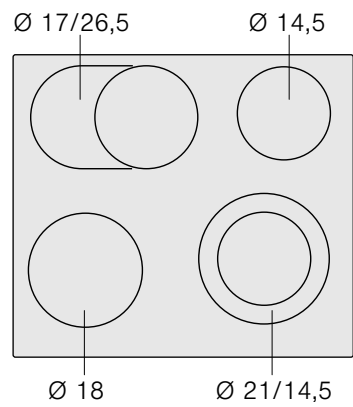

PKG6..F17., PKG6..FB1.

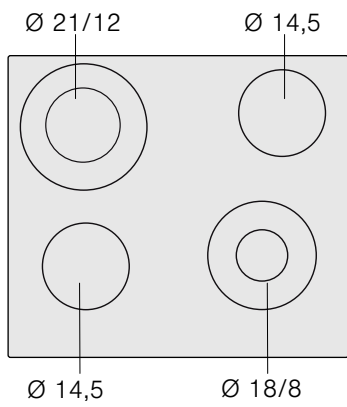

PKD7..FB1.

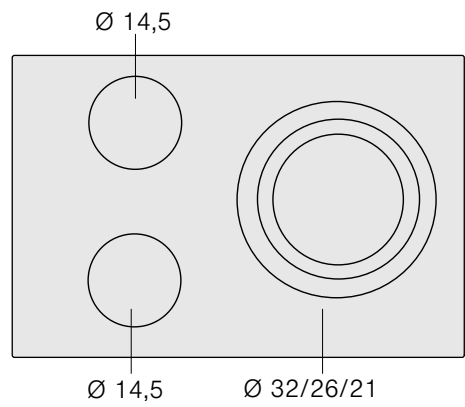

Table of contents

Safety precautions	3	Automatic hotplate switch-off.....	9
Causes of damage	4	Automatic timer	9
Environmental protection	5	Kitchen timer.....	9
Environmentally-friendly disposal.....	5	Automatic time limit	10
Energy-saving tips.....	5	Wipe protection	10
Getting to know your appliance	5	Energy consumption display	10
The control panel	5	Basic settings	10
The hotplates	6	Changing the basic settings.....	11
Residual heat indicator	6	Cleaning and care	11
Setting the hob	6	Ceramic	11
Switching the hob on and off	6	Hob surround.....	12
Setting a hotplate.....	6	Rectifying faults	12
Table of cooking times	6	After-sales service	12
Electronic boil start control	8	Test dishes	13
Setting the electronic boil start control.....	8		
Table of cooking times for electronic boil start control.....	8		
Tips for the electronic boil start control.....	8		
Childproof lock	9		
Switching the child safety lock on and off.....	9		
Automatic childproof lock	9		
Timer	9		

Additional information on products, accessories, replacement parts and services can be found at www.bosch-home.com and in the online shop www.bosch-eshop.com

Safety precautions

Please read this manual carefully. Please keep the instruction and installation manual as well as the appliance certificate in a safe place for later use or for subsequent owners.

Check the appliance for damage after unpacking it. Do not connect the appliance if it has been damaged in transport.

Only a licensed professional may connect appliances without plugs. Damage caused by incorrect connection is not covered under warranty.

This appliance is intended for private domestic use and the household environment only. The appliance must only be used for the preparation of food and beverages. The cooking process must be supervised. A short cooking process must be supervised without interruption. Only use the appliance in enclosed spaces.

This appliance is intended for use up to a maximum height of 2000 metres above sea level.

Do not use covers. These can cause accidents, due to overheating, catching fire or materials shattering, for example.

Do not use inappropriate child safety shields or hob guards. These can cause accidents.

This appliance may be used by children over the age of 8 years old and by persons with reduced physical, sensory or mental capabilities or by persons with a lack of experience or knowledge if they are supervised or are instructed by a person responsible for their safety how to use the appliance safely and have understood the associated hazards.

Children must not play with, on, or around the appliance. Children must not clean the appliance or carry out general maintenance unless they are at least 8 years old and are being supervised.

Keep children below the age of 8 years old at a safe distance from the appliance and power cable.

Risk of fire!

- Hot oil and fat can ignite very quickly. Never leave hot fat or oil unattended. Never use water to put out burning oil or fat. Switch off the hotplate. Extinguish flames carefully using a lid, fire blanket or something similar.

- The hotplates become very hot. Never place combustible items on the hob. Never place objects on the hob.
- The appliance gets hot. Do not keep combustible objects or aerosol cans in drawers directly underneath the hob.
- The hob switches off automatically and can no longer be operated. It may switch on unintentionally at a later point. Switch off the circuit breaker in the fuse box. Contact the after-sales service.

Risk of burns!

- The hotplates and surrounding area (particularly the hob surround, if fitted) become very hot. Never touch the hot surfaces. Keep children at a safe distance.
- The hotplate heats up but the display does not work. Switch off the circuit breaker in the fuse box. Contact the after-sales service.

Risk of electric shock!

- Incorrect repairs are dangerous. Repairs may only be carried out by one of our trained after-sales engineers. If the appliance is faulty, unplug the mains plug or switch off the fuse in the fuse box. Contact the after-sales service.
- Do not use any high-pressure cleaners or steam cleaners, which can result in an electric shock.
- A defective appliance may cause electric shock. Never switch on a defective appliance. Unplug the appliance from the mains or switch off the circuit breaker in the fuse box. Contact the after-sales service.
- Cracks or fractures in the glass ceramic may cause electric shocks. Switch off the circuit breaker in the fuse box. Contact the after-sales service.

Risk of injury!

Saucepans may suddenly jump due to liquid between the pan base and the hotplate. Always keep the hotplate and saucepan bases dry.

Causes of damage

Caution!

- Rough pot and pan bases scratch the ceramic.
- Avoid boiling pots dry. This may cause damage.
- Never place hot pots or pans on the control panel, the display area or the surround. This may cause damage.

- Damage can occur if hard or pointed objects fall on the hob.
- Aluminium foil and plastic containers melt on hot hotplates. Oven protective foil is not suitable for your hob.

Overview

The following table provides an overview of the most frequent kinds of damage:

Damage	Cause	Action
Stains	Food spills	Remove spills immediately with a glass scraper.
	Unsuitable cleaning agents	Only use cleaning agents which are suitable for ceramic
Scratches	Salt, sugar and sand	Do not use the hob as a work surface or storage space.
	Rough pot and pan bases scratch the ceramic.	Check your cookware.
Discolouration	Unsuitable cleaning agents	Only use cleaning agents which are suitable for ceramic
	Pan abrasion (e.g. aluminium)	Lift the pots and pans when moving them.
Blisters	Sugar, food with a high sugar content	Remove spills immediately with a glass scraper.

Environmental protection

Environmentally-friendly disposal

Dispose of packaging in an environmentally-friendly manner.



This appliance is labelled in accordance with European Directive 2012/19/EU concerning used electrical and electronic appliances (waste electrical and electronic equipment - WEEE). The guideline determines the framework for the return and recycling of used appliances as applicable throughout the EU.

Energy-saving tips

- Always place suitable lids on saucepans. When cooking without a lid, considerably more energy is required. A glass lid means that you can see inside without having to lift the lid.
- Use pots and pans with even bases. Uneven bases increase energy consumption.
- The diameter of pot and pan bases should be the same size as the hotplate. In particular, small saucepans on the hotplate cause energy losses. Please note: cookware manufacturers often indicate the upper diameter of the saucepan. This is usually bigger than the diameter of the base of the pan.
- Use a small saucepan for small quantities. A larger, less full saucepan requires a lot of energy.
- Cook with only a little water. This will save energy. Vitamins and minerals in vegetables are preserved.
- Always cover as large an area of the hotplate as possible with your saucepan.
- Switch to a lower heat setting in good time.
- Select a suitable ongoing cooking setting. You will waste energy by using an ongoing cooking setting which is too high.
- Use the residual heat of the hob. For longer cooking times, you can switch the hotplate off 5-10 minutes before the end of the cooking time.

Getting to know your appliance

The instruction manual is the same for various different hobs. An overview of the models with their dimensions is given on page 2.

The control panel

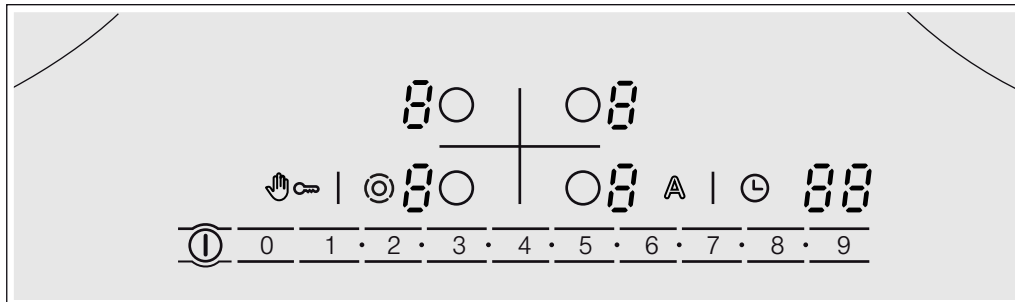

Displays

1-9	Heat settings
H/h	Residual heat
A	Electronic boil start control
88	Timer

Controls

I	Main switch
A	Electronic boil start control
○	Hotplate selection
Hand with lock	Control panel pause / Childproof lock
1•2•3•4•	Settings range
⦿	Automatic zone control
⌚	Timer

Notes

- When you touch a symbol, the respective function is activated.
- Always keep the controls dry. Moisture reduces their effectiveness.
- Do not pull pans close to the displays and sensors. The electronics could overheat.

The hotplates

Hotplate	Activating and deactivating
○	Single-circuit hotplate
⊙	Dual-circuit hotplate Select the hotplate and touch the ⊙ symbol
⊚	Tri-circuit hotplate Select the hotplate, touch the ⊚ symbol, and the 2nd filament circuit is activated Touch the ⊚ symbol again and the 3rd filament circuit is activated
∞	Extended cooking zone Select the hotplate and touch the ⊙ symbol

Activating the hotplate: The corresponding indicator lights up.

Switching on the hotplate: The size of hotplate which was last set is automatically selected

Residual heat indicator

The hob has a two-stage residual heat indicator for each hotplate.

If **H** appears in the display the hob is still hot. It may be used, for example, to keep a small meal warm or to melt cooking chocolate. As the hotplate cools down further, the display changes to **h**. The display remains lit until the hotplate has cooled sufficiently.

Setting the hob

This section informs you how to set the hotplates. The table shows heat settings and cooking times for various meals.

Switching the hob on and off

The main switch is used to switch the hob on and off.

To switch on: touch the ① symbol. A signal sounds. The display light above the main switch and the **H** indicators light up. The hob is ready for use.

To switch off: Touch the ① symbol until the display light above the main switch and the displays go out. All hotplates are switched off. The residual heat indicator remains on until the hotplates have cooled down sufficiently.

Notes

- The hob switches off automatically if all hotplates have been switched off for more than 20 seconds.
- The settings remain stored for 4 seconds after the hob has been switched off. If you switch it on again during this time, the hob will operate using the previously stored settings.

Setting a hotplate

Set the desired heat setting on the control panel.

Heat setting 1 = lowest setting

Heat setting 9 = highest setting

Every heat setting has an intermediate setting. This is marked in the control panel with the • symbol.

Table of cooking times

The following table provides some examples.

Cooking times and heat settings may vary depending on the type of food, its weight and quality. Deviations are therefore possible.

	Ongoing cooking setting	Ongoing cooking time in minutes
Melting		
Chocolate coating	1-1.	-
Butter, honey, gelatine	1-2	-

* Ongoing cooking without a lid

** Without lid

*** Turn frequently

Setting the heat setting

The hob must be switched on.

1. Touch the ○ symbol to select the hotplate.
H lights up in the heat setting display, **_** lights up under the heat setting display.
2. Set the desired heat setting in the control panel.

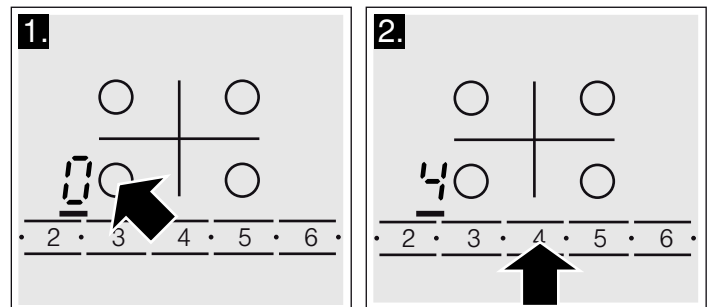

Changing the heat setting

Select the hotplate and set the desired heat setting in the control panel.

Switching off the hotplate

Use the ○ symbol to select the hotplate. Set the control panel to 0. After about 10 seconds, the residual heat indicator appears.

Note: The last selected hotplate remains activated. You can set the hotplate without selecting it again.

For bringing liquids to the boil, use heat setting 9.

Stir thick liquids occasionally.

	Ongoing cooking setting	Ongoing cooking time in minutes
Heating and keeping warm		
Stew (e.g. lentil stew)	1-2	-
Milk**	1.-2.	-
Heating sausages in water**	3-4	-
Defrosting and heating		
Frozen spinach	2.-3.	10-20 min
Frozen goulash	2.-3.	20-30 min
Poaching, simmering		
Dumplings	4.-5.*	20-30 min
Fish	4-5*	10-15 min
White sauces, e.g. béchamel sauce	1-2	3-6 min
Emulsified sauces, e.g. béarnaise sauce, hollandaise sauce	3-4	8-12 min
Boiling, steaming, braising		
Rice (with double the quantity of water)	2-3	15-30 min
Rice pudding	1.-2.	35-45 min
Unpeeled boiled potatoes	4-5	25-30 min
Boiled potatoes	4-5	15-25 min
Pasta, noodles	6-7*	6-10 min
Stew, soups	3.-4.	15-60 min
Vegetables	2.-3.	10-20 min
Frozen vegetables	3.-4.	10-20 min
Cooking in a pressure cooker	4-5	-
Braising		
Roulades	4-5	50-60 min
Pot roasts	4-5	60-100 min
Goulash	2.-3.	50-60 min
Frying**		
Escalope, plain or breaded	6-7	6-10 min
Escalope, frozen	6-7	8-12 min
Cutlet, plain or breaded***	6-7	8-12 min
Steak (3 cm thick)	7-8	8-12 min
Hamburger, rissoles (3 cm thick)***	4.-5.	30-40 min
Poultry breast (2 cm thick)***	5-6	10-20 min
Poultry breast, frozen***	5-6	10-30 min
Fish and fish fillet, plain	5-6	8-20 min
Fish and fish fillet, breaded	6-7	8-20 min
Fish and fish fillet, breaded and frozen, e.g. fish fingers	6-7	8-12 min
Scampi and prawns	7-8	4-10 min
Stir fry, frozen	6-7	6-10 min
Pancakes	6-7	consecutively
Omelette	3.-4.	consecutively
Fried eggs	5-6	3-6 min
Deep-fat frying (fry 150-200 g per portion continuously in 1-2 litres oil**)		
Frozen products, e.g. chips, chicken nuggets	8-9	-
Croquettes	7-8	-
Meat, e.g. chicken portions	6-7	-
Fish, breaded or battered	5-6	-
Vegetables, mushrooms, breaded or battered	5-6	-
Small baked items, e.g. doughnuts, fruit in batter	4-5	-

* Ongoing cooking without a lid

** Without lid

*** Turn frequently

Electronic boil start control

The electronic boil start control heats the hotplate using the highest heat setting and then switches down to the simmer setting you have selected.

The time taken for the hotplate to heat up depends on the simmer setting selected.

Setting the electronic boil start control

The electronic boil start control can only be activated in the first 30 seconds after you have switched on the hotplate:

Table of cooking times for electronic boil start control

The table below shows which dishes electronic boil start control can be used for.

1. Set the desired ongoing cooking setting for the hotplate.
2. Touch the  symbol.

The electronic boil start control is activated.  and the ongoing cooking setting flash alternately.

After the food has been brought to the boil, only the ongoing cooking setting remains lit on the display.

The smaller quantities specified are for the smaller hotplates and the larger quantities are for the larger hotplates. The values given are guidelines.

Stir thick liquids occasionally.

Dish with electronic boil start control	Quantity	Heat setting	Total cooking time in minutes
Heating			
Stock	500 ml-1 litre	A 7-8	4-7 min
Thick soups	500 ml-1 litre	A 2-3	3-6 min
Milk**	200-400 ml	A 1-2	4-7 min
Heating and keeping warm			
Stew (e.g. lentil stew)	400-800 g	A 1-2	-
Defrosting and heating			
Frozen spinach	300-600 g	A 2-3	10-20 min
Frozen goulash	500 g-1 kg	A 2-3	20-30 min
Poaching			
Fish	300-600 g	A 4-5*	20-25 min
Boiling			
Rice (with double the quantity of water)	125-250 g	A 2-3	20-25 min
Unpeeled boiled potatoes with 1-3 cups of water	750 g-1.5 kg	A 4-5	30-40 min
Boiled potatoes with 1-3 cups of water	750 g-1.5 kg	A 4-5	20-30 min
Vegetables with 1-3 cups of water	500 g-1 kg	A 2-3	15-20 min
Frozen vegetables with 1-3 cups of water	500 g-1 kg	A 4-5	15-20 min
Braising			
Roulades	x 4	A 4-5	50-60 min
Pot roasts	1 kg	A 4-5	80-100 min
Frying**			
Escalope, plain or breaded	1-2	A 6-7	8-12 min
Cutlet, plain or breaded	1-2	A 6-7	8-12 min
Steak (3 cm thick)	1-2	A 7-8	8-12 min
Fish and fish fillet, breaded	1-2	A 6-7	8-12 min
Fish and fish fillet, breaded and frozen, e.g. fish fingers	200-300 g	A 6-7	8-12 min
Pancakes		A 6-7	continuous frying

* Ongoing cooking without a lid

** Without lid

Tips for the electronic boil start control

Electronic boil start control is designed to conserve food's nutritional value while using little water for cooking.

- Add only approximately 3 cups of water to the food for large hotplates and approximately 2 cups of water for small hotplates.
- Place a lid on the saucepan.



- Electronic boil start control is not suitable for food that is cooked in a large volume of water (e.g. pasta).

Childproof lock

You can use the childproof lock to prevent children from switching on the hotplates.

Switching the child safety lock on and off

The hob must be switched off.

To switch on: Touch the  symbol for approx. 4 seconds. The  symbol lights up for 10 seconds. The hob is locked.

To switch off: Touch the  symbol for approx. 4 seconds. The lock is released.

Automatic childproof lock

This function automatically activates the childproof lock every time you switch the hob off.

Switching on and off

You can find out how to switch the automatic childproof lock on and off in the Basic settings section.

Timer

The timer can be used in two different ways:



- To switch a hotplate off automatically
- As a kitchen timer

Automatic hotplate switch-off

Enter a cooking time for the relevant hotplate. When the cooking time has elapsed, the hotplate switches off automatically.

Setting the cooking time

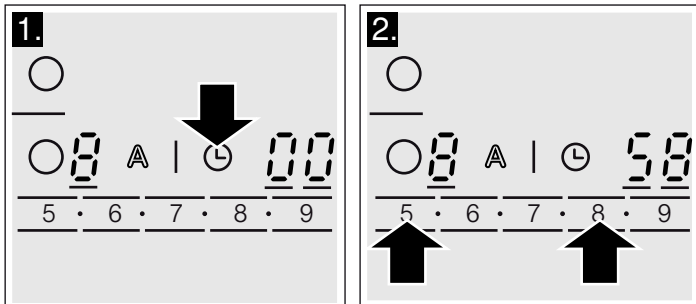

The hotplate must be selected and set.

1. Touch the  symbol. The  display for the desired hotplate lights up.  lights up on the timer display.
2. Within the next 10 seconds, set the desired cooking time in the settings range.





The cooking time counts down. If you have set a cooking time for more than one hotplate, the cooking time of the selected hotplate is always displayed.

When the time has elapsed

When the cooking time has elapsed, the hotplate switches off. You will hear an audible signal and  lights up in the display for 10 seconds. The  display lights up brightly. Touch any symbol. The displays go out and the audible signal ceases.

Changing or cancelling the cooking time

Select the hotplate and touch the  symbol. The  display lights up brightly. Change the cooking time or set to  in the settings range.



Note: You can set a cooking time of up to 99 minutes.

Automatic timer

You can use this function to preselect a cooking time for all hotplates. Each time a hotplate is switched on, the preselected cooking then counts down. When the cooking time has elapsed, the hotplate switches off automatically.

You can find out how to switch on the automatic timer in the Basic settings section.

Note: You can change the cooking time for a hotplate or switch off the automatic timer for the hotplates.



Select the hotplate and touch the  symbol. The desired  display lights up brightly. Change the cooking time or set to  in the settings range.

Kitchen timer

You can use the kitchen timer to set a time of up to 99 minutes. It runs independently of all the other settings.

Switching on the kitchen timer

You can switch the kitchen timer on in 2 different ways:



- If a hotplate has been selected, touch the  symbol twice within 10 seconds.
- If a hotplate has not been selected, touch the .

The  display lights up.

Setting the kitchen timer

Set the desired time in the settings range.

When the cooking time has elapsed

After the time has elapsed, you hear an audible signal.  lights up in the timer display. The  display for the kitchen timer lights up brightly. After 10 seconds, the display switches off.

Displaying the time

Use the  symbol to select the kitchen timer. The time is displayed for 10 seconds.

Changing the time

Use the  symbol to select the kitchen timer and reset the time.

Automatic time limit

If a hotplate has been switched on for a long time without the setting being changed, the automatic time limit is activated.



The hotplate stops heating. **F B** and the **H/h** residual heat indicator flash alternately on the hotplate display.

The display goes out when you touch any control. You can make new settings.

When the time limit is activated depends on the heat setting selected (1 to 10 hours).

Wipe protection

If you wipe over the control panel while the hob is switched on, settings may be altered.

To prevent this from happening, your hob has a control panel pause function. Touch the  symbol. A signal sounds and the display light above the  symbol lights up. The control

panel is locked for 30 seconds. You can now wipe over the control panel without altering any settings.

Note: The main switch is excluded from the control panel pause function. You can switch off the hob at any time.

Energy consumption display

You can use this function to have the total energy consumption between switching the hob on and off displayed.

Once switched off, the energy consumption in kilowatt hours (e.g. 1.08 kWh) is displayed for 10 seconds



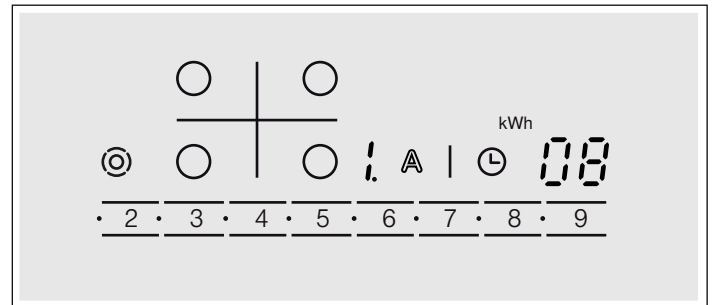











The accuracy of the display depends, amongst other things, on the voltage quality of the power supply.







The display has not been activated. You can find out how to activate the display in the Basic settings section.

Basic settings

Your appliance has various basic settings. You can adapt these settings to suit your own needs.

Display	Function
	Automatic childproof lock  Switched off.*  Switched on.
	Audible signal  Confirmation signal and incorrect operation signal switched off (main switch signal always remains on).  Only incorrect operation signal switched on.  Only confirmation signal switched on.  Confirmation signal and incorrect operation signal switched on.*
	Energy consumption display (ask your electricity supplier for the mains voltage)  Consumption display switched off.*  Consumption display at mains voltage of 230 V.  Consumption display at mains voltage of 400 V.  Consumption display at mains voltage of 220 V.  Consumption display at mains voltage of 240 V.

*Basic setting

Display	Function
c 5	Automatic timer  Switched off.* 1-99 Cooking time after which the hotplates switch off
c 6	Duration of the timer end signal 1 10 seconds.* 2 30 seconds 3 1 minute.
c 7	Activation of the filament circuits  Switched off. 1 Switched on. 2 Last setting before the hotplate switched off.*
c 9	Time for selecting the hotplate  Unlimited: The last selected hotplate can always be adjusted without having to select it again.* 1 Once you select a hotplate, you have 10 seconds to adjust it, after which you will have to select it again in order to be able to adjust it.
c 0	Reset the basic settings  Switched off.* 1 Switched on.

*Basic setting

Changing the basic settings

The hob must be switched off.

1. Switch on the hob.
2. Within the next 10 seconds, touch the  symbol for 4 seconds.

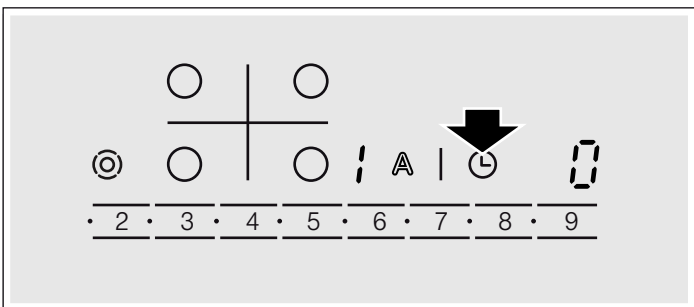

c and 1 flash alternately in the left-hand display and  lights up in the right-hand display.

3. Touch the  symbol repeatedly until the desired symbol appears on the left-hand display.
4. Set the desired value on the settings range.

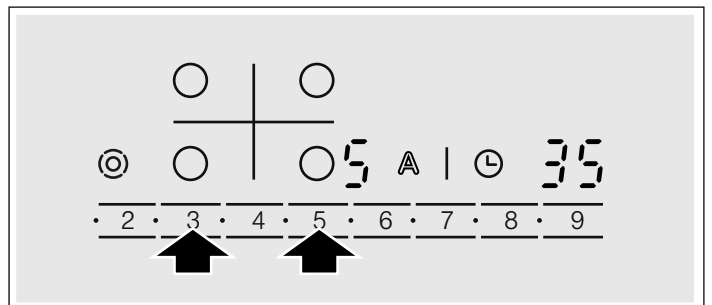

5. Touch the  symbol for 4 seconds.
The setting is activated.

Switching off

To exit the basic setting, switch off the hob with the main switch and make new settings.

Cleaning and care

The information in this section provides help on how best to care for your hob.

Suitable maintenance and cleaning products can be purchased from the after-sales service or in our e-Shop.

Ceramic

Clean the hob after each use. This will prevent spills from burning onto the ceramic.

Only clean the hob when it has cooled down sufficiently.

Use only cleaning agents which are suitable for glass ceramic. Follow the cleaning instructions on the packaging.

Never use:

- Undiluted washing-up liquid
- Detergent intended for dishwashers

- Scouring agents
- Harsh cleaning agents such as oven spray or stain remover
- Abrasive sponges
- High-pressure cleaners or steam jet cleaners

Ground-in dirt can be best removed with a glass scraper, available from retailers. Please note the manufacturer's instructions.

You can also obtain a suitable glass scraper from our after-sales service or from the e-Shop.

Using special sponges to clean glass ceramic achieves great cleaning results.

Hob surround

To prevent damage to the hob surround, observe the following instructions:

- Use only hot soapy water.

- Wash new sponge cloths thoroughly before use.
- Do not use any sharp or abrasive agents.
- Do not use the glass scraper.

Rectifying faults

Faults often have simple explanations. Please read the notes in the table before calling the after-sales service.

The electronics of your hob are underneath the control panel. For various reasons, the temperature in this area may rise sharply.

In order that the electronics do not overheat, the hotplates are switched off as and when necessary. The **F2**, **F4**, or **F5** display appears alternately with the **H** or **h** residual heat indicator.

Display	Fault	Measure
Blank	There is no power supply.	Check the household fuse for the appliance. Check whether there is a power cut by trying other electronic appliances.
All displays flash	The touch controls are wet or an object is resting on them.	Dry the touch controls or remove the object.
F2	Several hotplates have been used over a prolonged period at high power settings. To protect the electronics, the hotplate has been switched off.	Wait a while. Touch any touch control. When F2 goes out, the electronics have cooled down sufficiently. You can continue cooking.
F4	Despite the switch-off by F2 , the electronics have become hot again. All hotplates have therefore been switched off.	Wait a while. Touch any touch control. When F4 goes out, you can continue cooking.
F5 and the heat setting flash alternately. An audible signal can be heard	Warning: There is a hot pan in the area of the control panel. There is a risk that the electronics will overheat.	Remove the pan. The fault display goes out shortly afterwards. You can continue cooking.
F5 and audible signal	There is a hot pan in the area of the control panel. To protect the electronics, the hotplate has been switched off.	Remove the pan. Wait a while. Touch any touch control. When F5 goes out, you can continue cooking.
F8	The hotplate was in operation for too long and has switched itself off.	You can switch the hotplate back on again immediately.

After-sales service

Our after-sales service is there for you if your appliance should need to be repaired. We are committed to find the best solution also in order to avoid an unnecessary call-out.

E number and FD number:

Please quote the E number (product number) and the FD number (production number) of your appliance when contacting the after-sales service. The rating plate bearing these numbers can be found on the appliance certificate.

Please note that a visit from an after-sales service engineer is not free of charge, even during the warranty period.

Please find the contact data of all countries in the enclosed customer service list.

To book an engineer visit and product advice

GB 0344 892 8979

Calls charged at local or mobile rate.

IE 01450 2655

0.03 € per minute at peak. Off peak 0.0088 € per minute.

Rely on the professionalism of the manufacturer. You can therefore be sure that the repair is carried out by trained service technicians who carry original spare parts for your appliances.

Test dishes

This table has been produced for test institutes to facilitate the testing of our appliances.

The data in the table refers to our accessory cookware from Schulte Ufer (4-part induction pot set HEZ 390042) with the following dimensions:

- Saucepan dia. 16 cm, 1.2 litres, for 14.5 cm dia. single-circuit hotplate

- Cooking pot dia. 16 cm, 1.7 litres, for 14.5 cm dia. single-circuit hotplate
- Cooking pot dia. 22 cm, 4.2 litres, for 18 cm dia. or 17 cm dia. hotplate
- Frying pan dia. 24 cm, for 18 cm dia. or 17 cm dia. hotplate

Test dishes	Heating up/bringing to boil			Ongoing cooking	
	Heat setting	Cooking time (min:sec)	Lid	Ongoing cooking setting	Lid
Melting chocolate					
Cookware: saucepan					
Cooking chocolate (e.g. Dr. Oetker dark chocolate, 150 g) on 14.5 cm dia. hotplate	-	-	-	1.	No
Heating and keeping lentil stew warm					
Cookware: cooking pot					
<i>Lentil stew made to DIN 44550</i>					
Initial temperature 20 °C					
Amount: 450 g for 14.5 cm dia. hotplate	9	approx. 2:00 without stirring	Yes	1.	Yes
Amount: 800 g for 18 cm dia. or 17 cm dia. hotplate	9	approx. 2:00 without stirring	Yes	1.	Yes
<i>Lentil stew from the tin</i>					
e.g lentils with Erasco sausages:					
Initial temperature 20 °C					
Amount: 500 g for 14.5 cm dia. hotplate	9	approx. 2:00 (Stir after approx. 1:30)	Yes	1.	Yes
Amount: 1000 g for 18 cm dia. or 17 cm dia. hotplate	9	approx. 2:30 (Stir after approx. 1:30)	Yes	1.	Yes
Simmering Béchamel sauce					
Cookware: saucepan					
Milk temperature: 7° C					
Recipe: 40 g butter, 40 g flour, 0.5 l milk (3.5% fat content) and a pinch of salt for 14.5 cm dia. hotplate	9 ²	approx. 5:20	No	1 ^{1,3}	No

¹ Melt the butter, stir in the flour and salt, and keep cooking the roux for 3 minutes

² Add the milk to the roux and bring to the boil, stirring continuously

³ After the Béchamel sauce has come to the boil, keep cooking it at setting 1 for a further 2 minutes, stirring all the time

Test dishes	Heating up/bringing to boil		Lid	Ongoing cooking	
	Heat setting	Cooking time (min:sec)		Ongoing cooking setting	Lid
Cooking rice pudding - Ongoing cooking with lid					
Cookware: cooking pot					
Milk temperature: 7° C					
Recipe: 190 g round grain rice, 90 g sugar, 750 ml milk (3.5% fat content) and 1 g salt for 14.5 cm dia. hotplate	9	approx. 6:45 Heat the milk until it starts to rise up. Switch down to the ongoing cooking setting and add the rice, sugar and salt to the milk Total cooking time (incl. bringing to boil) approx. 45 minutes	No	2	Yes
				Stir the rice pudding after 10 minutes	
Recipe: 250 g round grain rice, 120 g sugar, 1 l milk (3.5% fat content) and a pinch of salt for 18 cm dia. or 17 cm dia. hotplate	9	approx. 7:20 Heat the milk until it starts to rise up. Switch down to the ongoing cooking setting and add the rice, sugar and salt to the milk Total cooking time (incl. bringing to boil) approx. 45 minutes	No	2	Yes
				Stir the rice pudding after 10 minutes	
Cooking rice pudding - Ongoing cooking without lid					
Cookware: cooking pot					
Milk temperature: 7° C					
Recipe: 190 g round grain rice, 90 g sugar, 750 ml milk (3.5% fat content) and 1 g salt for 14.5 cm dia. hotplate	9	approx. 7:30 Add rice, sugar and salt to the milk and heat the mixture up, stirring continuously. At a milk temperature of approx. 90°C switch down to the ongoing cooking setting. Simmer for approx. 50 minutes	No	2	No
Recipe: 250 g round grain rice, 120 g sugar, 1 l milk (3.5% fat content) and 1.5 g salt for 18 cm dia. or 17 cm dia. hotplate	9	approx. 8:00 Add rice, sugar and salt to the milk and heat the mixture up, stirring continuously. At a milk temperature of approx. 90°C switch down to the ongoing cooking setting. Simmer for approx. 50 minutes	No	2	No
Cooking rice					
Cookware: cooking pot					
Water temperature 20° C					
Recipe acc. to DIN 44550: 125 g long grain rice, 300 g water and a pinch of salt for 14.5 cm dia. hotplate	9	approx. 2:48	Yes	2	Yes
Recipe acc. to DIN 44550: 250 g long grain rice, 600 g water and a pinch of salt for 18 cm dia. or 17 cm dia. hotplate	9	approx. 3:15	Yes	2.	Yes
Frying pork loin chops					
Cookware: frying pan					
Initial temperature loin chops: 7° C					
Amount: 3 loin chops (total weight approx. 300 g, about 1 cm thick) 15 g sunflower oil for 18 cm dia. or 17 cm dia. hotplate	9	approx. 2:40	No	7	No

Test dishes	Heating up/bringing to boil		Lid	Ongoing cooking	
	Heat setting	Cooking time (min:sec)		Ongoing cooking setting	Lid
Frying pancakes					
Cookware: frying pan					
Recipe acc. to DIN EN 60350-2					
Amount: 55 ml batter per pancake for 18 cm dia. or 17 cm dia. hotplate	9	approx. 2:40	No	6 or 6. depending on browning level	No
Deep-fat frying frozen chips					
Cookware: cooking pot					
Amount: 1.8 kg sunflower oil, per portion: 200 g frozen chips (e.g. McCain 123 Original fries) for 18 cm dia. or 17 cm dia. hotplate	9	Until oil temperature reaches 180 °C	No	9	No

If the tests are carried out with an 18 cm dia. hotplate with a power rating of 1500 W, the boiling time is increased by approx. 20% and the ongoing cooking setting by one ongoing cooking setting.



Robert Bosch Hausgeräte GmbH

Carl-Wery-Straße 34

81739 München

Germany

www.bosch-home.com



9000737692

960414

Free Manuals Download Website

<http://myh66.com>

<http://usermanuals.us>

<http://www.somanuals.com>

<http://www.4manuals.cc>

<http://www.manual-lib.com>

<http://www.404manual.com>

<http://www.luxmanual.com>

<http://aubethermostatmanual.com>

Golf course search by state

<http://golfingnear.com>

Email search by domain

<http://emailbydomain.com>

Auto manuals search

<http://auto.somanuals.com>

TV manuals search

<http://tv.somanuals.com>