

# USER'S GUIDE

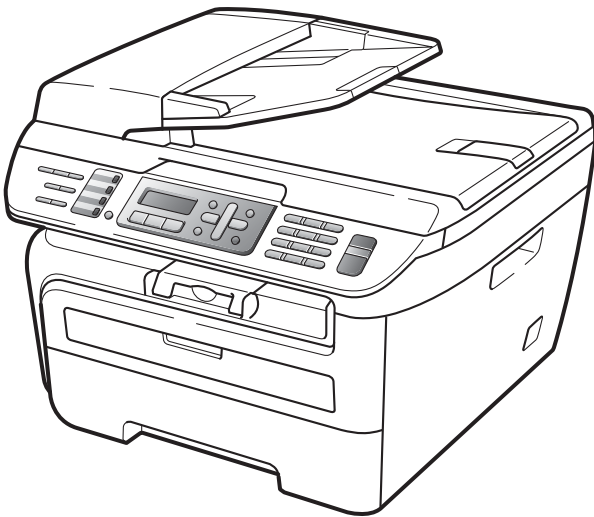

MFC-7340  
MFC-7345N  
MFC-7440N  
MFC-7840W

Not all models are available in all countries.

## If you need to call Customer Service

Please complete the following information for future reference:

**Model Number:**

**MFC-7340, MFC-7345N, MFC-7440N and MFC-7840W**  
(Circle your model number)

**Serial Number:** <sup>1</sup> \_\_\_\_\_

**Date of Purchase:** \_\_\_\_\_

**Place of Purchase:** \_\_\_\_\_

**<sup>1</sup> The serial number is on the back of the unit. Retain this User's Guide with your sales receipt as a permanent record of your purchase, in the event of theft, fire or warranty service.**

**Register your product on-line at**

**<http://www.brother.com/registration/>**

By registering your product with Brother, you will be recorded as the original owner of the product. Your registration with Brother:

- may serve as confirmation of the purchase date of your product should you lose your receipt;
- may support an insurance claim by you in the event of product loss covered by insurance; and,
- will help us notify you of enhancements to your product and special offers.

The most convenient and efficient way to register your new product is online at <http://www.brother.com/registration/>

# Brother numbers

## IMPORTANT

For technical help, you must call the country where you bought the machine. Calls must be made **from within** that country.

## Register your product

By registering your product with Brother International Corporation, you will be recorded as the original owner of the product. Your registration with Brother:

- may serve as confirmation of the purchase date of your product should you lose your receipt;
- may support an insurance claim by you in the event of product loss covered by insurance; and,
- will help us notify you of enhancements to your product and special offers.

Please complete and fax the Brother Warranty Registration And Test Sheet or, for your convenience and most efficient way to register your new product, register on-line at

<http://www.brother.com/registration/>

## FAQs (frequently asked questions)

The Brother Solutions Center is our one-stop resource for all your Fax Machine/Multi-Function Center needs. You can download the latest software and utilities and read FAQs and troubleshooting tips to learn how to get the most from your Brother product.

<http://solutions.brother.com/>



### Note

You can check here for Brother driver updates.

To keep your machine performance up to date, check here for the latest firmware upgrade (for Windows® only).

## For Customer Service

**In USA:** 1-877-BROTHER (1-877-276-8437)  
1-901-379-1215 (fax)

**In Canada:** 1-877-BROTHER  
(514) 685-4898 (fax)

### Service Center Locator (USA only)

For the location of a Brother authorized service center, call 1-877-BROTHER (1-877-276-8437).

### Service Center Locations (Canada only)

For the location of a Brother authorized service center, call 1-877-BROTHER.

# Ordering accessories and supplies

For best quality results use only genuine Brother accessories, which are available at most Brother retailers. If you cannot find the accessory you need and you have a Visa, MasterCard, Discover, or American Express credit card, you can order accessories directly from Brother. (You can visit us online for a complete selection of the Brother accessories and supplies that are available for purchase.)



## Note

In Canada, only Visa and MasterCard are accepted.

**In USA:** 1-877-552-MALL (1-877-552-6255)  
1-800-947-1445 (fax)

<http://www.brothermall.com/>

**In Canada:** 1-877-BROTHER

<http://www.brother.ca/>

Description	Item
Toner Cartridge Standard	TN-330 (Approx. 1,500 pages) <sup>1</sup>
Toner Cartridge High Yield	TN-360 (Approx. 2,600 pages) <sup>1</sup>
Drum Unit	DR-360 (Approx. 12,000 pages) <sup>2</sup>
Telephone Line Cord	LG3077001
User's Guide	LS1666001 (English for USA and Canada)
	LS1666002 (French for Canada)
Quick Setup Guide	(MFC-7340/MFC-7345N/MFC-7440N) LS1667001 (English for USA and Canada)
	(MFC-7840W) LS1179001 (English for USA and Canada)
	(MFC-7340/MFC-7345N/MFC-7440N) LS1667002 (French for Canada) (MFC-7840W) LS1179002 (French for Canada)

<sup>1</sup> Approx. cartridge yield is declared in accordance with ISO/IEC 19752.

<sup>2</sup> Drum yield is approximate, and may vary by type of use.

# **Notice - Disclaimer of Warranties (USA and Canada)**

BROTHER'S LICENSOR(S), AND THEIR DIRECTORS, OFFICERS, EMPLOYEES OR AGENTS (COLLECTIVELY BROTHER'S LICENSOR) MAKE NO WARRANTIES, EXPRESS OR IMPLIED, INCLUDING WITHOUT LIMITATION THE IMPLIED WARRANTIES OF MERCHANTABILITY AND FITNESS FOR A PARTICULAR PURPOSE, REGARDING THE SOFTWARE. BROTHER'S LICENSOR(S) DOES NOT WARRANT, GUARANTEE OR MAKE ANY REPRESENTATIONS REGARDING THE USE OR THE RESULTS OF THE USE OF THE SOFTWARE IN TERMS OF ITS CORRECTNESS, ACCURACY, RELIABILITY, CURRENTNESS OR OTHERWISE. THE ENTIRE RISK AS TO THE RESULTS AND PERFORMANCE OF THE SOFTWARE IS ASSUMED BY YOU. THE EXCLUSION OF IMPLIED WARRANTIES IS NOT PERMITTED BY SOME STATES IN THE USA AND SOME PROVINCES IN CANADA. THE ABOVE EXCLUSION MAY NOT APPLY TO YOU.

IN NO EVENT WILL BROTHER'S LICENSOR(S) BE LIABLE TO YOU FOR ANY CONSEQUENTIAL, INCIDENTAL OR INDIRECT DAMAGES (INCLUDING DAMAGES FOR LOSS OF BUSINESS PROFITS, BUSINESS INTERRUPTION, LOSS OF BUSINESS INFORMATION, AND THE LIKE) ARISING OUT OF THE USE OR INABILITY TO USE THE SOFTWARE EVEN IF BROTHER'S LICENSOR HAS BEEN ADVISED OF THE POSSIBILITY OF SUCH DAMAGES. BECAUSE SOME STATES IN THE USA AND SOME PROVINCES IN CANADA DO NOT ALLOW THE EXCLUSION OR LIMITATION OF LIABILITY FOR CONSEQUENTIAL OR INCIDENTAL DAMAGES, THE ABOVE LIMITATIONS MAY NOT APPLY TO YOU. IN ANY EVENT BROTHER'S LICENSOR'S LIABILITY TO YOU FOR ACTUAL DAMAGES FROM ANY CAUSE WHATSOEVER, AND REGARDLESS OF THE FORM OF THE ACTION (WHETHER IN CONTRACT, TORT (INCLUDING NEGLIGENCE), PRODUCT LIABILITY OR OTHERWISE), WILL BE LIMITED TO \$50.

## **Compilation and Publication Notice**

Under the supervision of Brother Industries Ltd., this manual has been compiled and published, covering the latest product descriptions and specifications.

The contents of this manual and the specifications of this product are subject to change without notice.

Brother reserves the right to make changes without notice in the specifications and materials contained herein and shall not be responsible for any damages (including consequential) caused by reliance on the materials presented, including but not limited to typographical and other errors relating to the publication.

# Brother® One-Year Limited Warranty and Replacement Service (USA Only)

## Who is covered:

- This limited warranty (“warranty”) is given only to the original end-use/retail purchaser (referred to in this warranty as “Original Purchaser”) of the accompanying product, consumables and accessories (collectively referred to in this warranty as “this Product”).
- If you purchased a product from someone other than an authorized Brother reseller in the United States or if the product was used (including but not limited to floor models or refurbished product), prior to your purchase you are not the Original Purchaser and the product that you purchased is not covered by this warranty.

## What is covered:

- This Product includes a Machine and Consumable and Accessory Items. Consumable and Accessory Items include but are not limited to print heads, toner, drums, ink cartridges, print cartridges, cordless handset battery, refill ribbons, therma PLUS paper and thermal paper.
- Except as otherwise provided herein, Brother warrants that the Machine and the accompanying Consumable and Accessory Items will be free from defects in materials and workmanship, when used under normal conditions.
- This warranty applies only to products purchased and used in the United States. For products purchased in, but used outside, the United States, this warranty covers only warranty service within the United States (and does not include shipping outside the United States).

## What is the length of the Warranty Periods:

- Machines: one year from the original purchase date.
- Accompanying Consumable and Accessory Items: 90 days from the original purchase date or the rated life of consumable, whichever comes first.

## What is NOT covered:

### This warranty does not cover:

- 1 Physical damage to this Product;
- 2 Damage caused by improper installation, improper or abnormal use, misuse, neglect or accident (including but not limited to transporting this Product without the proper preparation and/or packaging);

- 3 Damage caused by another device or software used with this Product (including but not limited to damage resulting from use of non Brother®-brand parts and Consumable and Accessory Items);
- 4 Consumable and Accessory Items that expired in accordance with a rated life;
- 5 Problems arising from other than defects in materials or workmanship; and,
- 6 Normal Periodic Maintenance Items, such as Paper Feeding Kit, Fuser and Laser Units.

This limited warranty is VOID if this Product has been altered or modified in any way (including but not limited to attempted warranty repair without authorization from Brother and/or alteration/removal of the serial number).

## **What to do if you think your Product is eligible for warranty service:**

Report your issue to either our Customer Service Hotline at 1-877-BROTHER (1-877-276-8437) or to a Brother Authorized Service Center **within the applicable warranty period.** Supply Brother or the Brother Authorized Service Center with a copy of your dated bill of sale showing that this Product was purchased within the U.S. For the name of local Brother Authorized Service Center(s), call 1-877-BROTHER (1-877-276-8437) or visit [www.brother-usa.com](http://www.brother-usa.com).

## **What Brother will ask you to do:**

After contacting Brother or a Brother Authorized Service Center, you may be required to deliver (by hand if you prefer) or send the Product properly packaged, freight prepaid, to the Authorized Service Center together with a photocopy of your bill of sale.

**You are responsible for the cost of shipping, packing product, and insurance (if you desire). You are also responsible for loss or damage to this Product in shipping.**

## **What Brother will do:**

If the problem reported concerning your Machine and/or accompanying Consumable and Accessory Items is covered by this warranty and if you first reported the problem to Brother or an Authorized Service Center within the applicable warranty period, Brother or its Authorized Service Center will repair or replace the Machine and/or accompanying Consumable and Accessory Items at no charge to you for parts or labor. The decision as to whether to repair or replace the Machine and/or accompanying Consumable and Accessory Items is made by Brother in its sole

## Brother® One-Year Limited Warranty and Replacement Service (USA Only)

discretion. Brother reserves the right to supply a refurbished or remanufactured replacement Machine and/or accompanying Consumable and Accessory Items and use refurbished parts provided such replacement products conform to the manufacturer's specifications for new product/parts. The repaired or replacement Machine and/or accompanying Consumable and Accessory Items will be returned to you freight prepaid or made available for you to pick up at a conveniently located Authorized Service Center.

If the Machine and/or accompanying Consumable and Accessory Items are not covered by this warranty (either stage), you will be charged for shipping the Machine and/or accompanying Consumable and Accessory Items back to you and charged for any service and/or replacement parts/products at Brother's then current published rates.

**The foregoing are your sole (i.e., only) and exclusive remedies under this warranty.**

**What happens when Brother elects to replace your Machine:**

When a replacement Machine is authorized by Brother, and you have delivered the Machine to an Authorized Service Center, the Authorized Service Center will provide you with a replacement Machine after receiving one from Brother. If you are dealing directly with Brother's Express Exchange Service Brother will send to you a replacement Machine shipped for receipt within two business days, with the understanding that you will, after receipt of the replacement Machine, supply the required proof of purchase information, together with the Machine that Brother agreed to replace. You are then expected to pack the Machine that Brother agreed to replace in the package from the replacement Machine and return it to Brother using the pre-paid freight bill supplied by Brother in accordance with the instructions provided by Brother. Since you will be in possession of two machines, Brother will require that you provide a valid major credit card number. Brother will issue a hold against the credit card account number that you provide until Brother receives your original Product and determines that your original Product is entitled to warranty coverage. Your credit card will be charged up to the cost of a new Product only if: (i) you do not return your original Product to Brother within five (5) business days; (ii) the problems with your original Product are not covered by the limited warranty; (iii) the proper packaging instructions are not followed and has caused

damage to the product; or (iv) the warranty period on your original Product has expired or has not been sufficiently validated with a copy of the proof of purchase (bill of sale). The replacement Machine you receive (even if refurbished or remanufactured) will be covered by the balance of the limited warranty period remaining on the original Product, plus an additional thirty (30) days. You will keep the replacement Machine that is sent to you and your original Machine shall become the property of Brother. **Retain your original Accessory Items and a copy of the return freight bill, signed by the courier.**

### Limitations:

Brother is not responsible for damage to or loss of any equipment, media, programs or data related to the use of this Product. Except for the repair or replacement as described above, Brother shall not be liable for any direct, indirect, incidental or consequential damages or specific relief. Because some states do not allow the exclusion or limitation of consequential or incidental damages, the above limitation may not apply to you.

THIS WARRANTY IS GIVEN IN LIEU OF ALL OTHER WARRANTIES, WRITTEN OR ORAL, WHETHER EXPRESSED BY AFFIRMATION, PROMISE, DESCRIPTION, DRAWING, MODEL OR SAMPLE. ANY AND ALL WARRANTIES OTHER THAN THIS ONE, WHETHER EXPRESS OR IMPLIED, INCLUDING IMPLIED WARRANTIES OF MERCHANTABILITY AND FITNESS FOR A PARTICULAR PURPOSE, ARE HEREBY DISCLAIMED.

- This Limited Warranty is the only warranty that Brother is giving for this Product. It is *the final expression and the exclusive and only statement* of Brother's obligations to you. It replaces all other agreements and understandings that you may have with Brother or its representatives.
- This warranty gives you certain rights and you may also have other rights that may vary from state to state.
- This Limited Warranty (and Brother's obligation to you) may not be changed in any way unless you and Brother sign the same piece of paper in which we (1) refer to this Product and your bill of sale date, (2) describe the change to this warranty and (3) agree to make that change.

**Important:** *We recommend that you keep all original packing materials, in the event that you ship this Product.*

## **BROTHER MULTIFUNCTION CENTER / FAX MACHINE LIMITED WARRANTY (Canada only)**

Pursuant to the limited warranty of 1 year from the date of purchase for labour and parts, Brother International Corporation (Canada) Ltd. ("Brother"), or its Authorized Service Centres, will repair or replace (at Brother's sole discretion) this MFC/Fax machine free of charge if defective in material or workmanship. This warranty applies only to products purchased and used in Canada.

This limited Warranty does not include cleaning, consumables (including, without limitation, ink cartridges, print cartridges, print rolls, thermal paper rolls, toner cartridges, drum units, OPC belts, fixing units, print heads, paper feed rollers, transfer rolls, cleaning rollers, waste toner packs, oil bottles) or damage caused by accident, neglect, misuse or improper installation or operation, any damage caused from service, maintenance, modifications, or tampering by anyone other than a Brother Authorized Service Representative, or if shipped out of the country.

The use of supplies or consumable items that are non-Brother products may void your warranty. This limited warranty ceases when this machine is rented, sold, or otherwise disposed of. Operation of the MFC/Fax machine in excess of the specifications or with the Serial Number or Rating Label removed shall be deemed abuse and all repairs thereafter shall be the sole liability of the end-user/purchaser.

In order to obtain warranty service, the MFC/Fax machine must be delivered or shipped freight prepaid by the end-user/purchaser to a "Brother" Authorized Service Centre, together with your Canadian Proof of Purchase in the form of a Sales Receipt.

When shipping or transporting your MFC/Fax machine, please refer to your Operation Manual for the proper packaging procedures.

For Laser units: Failure to remove the Toner Cartridge (and Toner Drum Unit, waste toner packs or oil bottles on applicable models) during shipping or transport will cause severe damage to the Laser MFC/Fax machine and will void the Warranty.

For inkjet units: (When shipping your Inkjet MFC/Fax machine remove the ink cartridges and replace them with the original protective parts. If original protective parts are not available, leave ink cartridges installed. Please avoid shipping the unit without original protective parts or ink cartridges.) Damage to your print head resulting from packing the Inkjet MFC/Fax machine without the ink cartridges or the protective parts will void your warranty.

Improper packaging may cause severe damage to the machine during shipping and will void the warranty.

**BROTHER DISCLAIMS ALL OTHER WARRANTIES EXPRESSED OR IMPLIED INCLUDING, WITHOUT LIMITATIONS, ANY IMPLIED WARRANTIES OF MERCHANTABILITY OR FITNESS FOR A PARTICULAR PURPOSE, EXCEPT TO THE EXTENT THAT ANY WARRANTIES IMPLIED BY LAW CANNOT BE VALIDLY WAIVED.**

No oral or written information, advice or representation provided by Brother, its Authorized Service Centres, Distributors, Dealers, Agents or employees, shall create another warranty or modify this warranty. The warranty states Brother's entire liability and your exclusive remedy against Brother for any failure of the MFC/Fax machine to operate properly.

Neither Brother nor anyone else involved in the development, production, or delivery of this MFC/Fax machine shall be liable for any indirect, incidental, special, consequential, exemplary, or punitive damages, including lost profits, arising from the use of or inability to use the product, even if advised by the end user/purchaser of the possibility of such damages. Since some Provinces do not allow the above limitation of liability, such limitation, may not apply to you.

**This Limited Warranty gives you specific legal rights and you may also have other rights which vary from Province to Province.**

**Warranty Service is available at Brother Authorized Service Centres throughout Canada. For Technical Assistance or for the name and location of your nearest Authorized Service Centre call 1-877-BROTHER.**

At your side.  
**brother**®

**Internet support: [support@brother.ca](mailto:support@brother.ca) or browse Brother's Web Site [www.brother.ca](http://www.brother.ca).**



# Table of Contents

## Section I General

<b>1</b>	<b>General information</b>	<b>2</b>
	Using the documentation .....	2
	Symbols and conventions used in the documentation .....	2
	Accessing the Software User's Guide and Network User's Guide .....	2
	Viewing documentation .....	2
	Accessing Brother support (for Windows®) .....	5
	Control panel overview .....	6
<b>2</b>	<b>Loading paper and documents</b>	<b>9</b>
	Loading paper and print media .....	9
	Loading paper in the paper tray .....	9
	Loading paper in the manual feed slot .....	10
	Unprintable area .....	13
	Acceptable paper and other print media .....	14
	Recommended paper and print media .....	14
	Type and size of paper .....	14
	Handling and using special paper .....	15
	Loading documents .....	18
	Using the automatic document feeder (ADF) .....	18
	Using the scanner glass .....	19
<b>3</b>	<b>General setup</b>	<b>20</b>
	Mode timer .....	20
	Paper settings .....	20
	Paper type .....	20
	Paper size .....	20
	Volume settings .....	21
	Ring volume .....	21
	Beeper volume .....	21
	Speaker volume .....	21
	Automatic daylight savings time .....	22
	Ecology features .....	22
	Toner save .....	22
	Sleep time .....	22
	LCD contrast .....	22
	Dial prefix .....	23
	Setting up the prefix number .....	23
	Changing the prefix number .....	23

---

**4 Security features 24**

---

Security..... 24  
TX lock (MFC-7340, MFC-7345N and MFC-7440N only)..... 24  
Secure function lock (MFC-7840W only)..... 25  
Setting lock ..... 28  
Restricting dialing ..... 29  
Dial pad restriction..... 29  
One touch restriction ..... 29  
Speed dial restriction ..... 29

## Section II Fax

---

**5 Sending a fax 32**

---

How to fax..... 32  
Entering fax mode ..... 32  
Sending a fax from the ADF ..... 32  
Sending a fax from the scanner glass ..... 32  
Canceling a fax in progress ..... 33  
Broadcasting ..... 33  
Canceling a broadcast in progress ..... 33  
Additional sending operations..... 34  
Sending faxes using multiple settings ..... 34  
Electronic cover page ..... 34  
Contrast ..... 35  
Changing fax resolution ..... 36  
Dual access ..... 36  
Real time transmission ..... 36  
Overseas mode ..... 37  
Delayed fax..... 37  
Delayed batch transmission ..... 37  
Checking and canceling waiting jobs..... 38  
Sending a fax manually ..... 38  
Out of memory message ..... 38

---

**6 Receiving a fax 39**

---

Choose the correct Receive Mode ..... 39  
Using receive modes ..... 40  
Fax Only ..... 40  
Fax/Tel..... 40  
Manual ..... 40  
External TAD ..... 40  
Receive mode settings ..... 41  
Ring delay..... 41  
F/T ring time (Fax/Tel mode only) ..... 41  
Easy receive ..... 42  
Setting the print density ..... 42

Additional receiving operations.....	43
Printing a reduced incoming fax .....	43
Setting the fax receive stamp .....	43
Receiving a fax at the end of a conversation.....	43
Printing a fax from the memory .....	43

---

## **7 Telephone services and external devices 44**

Telephone line services .....	44
Voice Mail .....	44
Distinctive Ring.....	44
Caller ID .....	46
Connecting an external TAD (telephone answering device).....	47
Connections.....	48
Recording an outgoing message (OGM).....	48
Special line considerations.....	48
Multi-line connections (PBX) .....	50
External and extension telephones.....	50
Using external and extension telephones.....	50
For Fax/Tel mode only.....	51
Connecting an external or extension telephone .....	51
Using a non-Brother cordless external handset .....	51
Using remote codes.....	51

---

## **8 Dialing and storing numbers 53**

How to dial .....	53
Manual dialing .....	53
One touch dialing.....	53
Speed dialing.....	53
Search .....	54
Fax redial.....	54
Storing numbers .....	54
Storing a pause .....	54
Storing one touch dial numbers.....	54
Storing speed dial numbers.....	55
Changing one touch and speed dial numbers.....	55
Setting up groups for broadcasting.....	56
Dialing access codes and credit card numbers.....	57
Pause .....	57
Tone or pulse (Canada only).....	57

---

**9 Remote fax options 58**

---

Fax forwarding ..... 58  
Paging..... 59  
Fax storage ..... 59  
PC fax receive ..... 60  
Changing remote fax options ..... 61  
    Turning off remote fax options ..... 61  
Remote retrieval ..... 62  
    Setting a remote access code ..... 62  
    Using your remote access code ..... 62  
    Retrieving fax messages ..... 63  
    Changing the fax forwarding number ..... 63  
Remote fax commands ..... 64

**10 Polling 65**

---

Polling receive ..... 65  
    Sequential polling ..... 65  
Polled transmit ..... 66  
    Setup for polled transmit..... 66

**11 Printing reports 67**

---

Fax reports..... 67  
    Transmission verification report..... 67  
    Fax journal..... 67  
Reports ..... 68  
    How to print a report..... 68

## Section III Copy

**12 Making copies 70**

---

How to copy ..... 70  
    Entering copy mode..... 70  
    Making a single copy ..... 70  
    Making multiple copies ..... 70  
    Stop copying..... 70  
Copy options (temporary settings)..... 71  
    Enlarging or reducing the image copied ..... 71  
    Using the Options key ..... 72  
    Improving copy quality ..... 73  
    Sorting copies using the ADF ..... 73  
    Adjusting contrast ..... 74  
    Making N in 1 copies (page layout) ..... 74  
Out of memory message ..... 75

## Section IV Software

<b>13</b>	<b>Software and Network features</b>	<b>78</b>
	How to read HTML User's Guide.....	78
	For Windows®.....	78
	For Macintosh®.....	79

## Section V Appendixes

<b>A</b>	<b>Safety and legal</b>	<b>82</b>
	Choosing a location.....	82
	To use the machine safely.....	83
	Important information.....	86
	Standard telephone and FCC notices.....	86
	Industry Canada Compliance Statement (Canada only).....	88
	Disconnect device.....	88
	LAN connection (MFC-7345N, MFC-7440N and MFC-7840W only).....	88
	International ENERGY STAR® Compliance Statement.....	89
	Laser safety.....	89
	FDA regulations.....	89
	Important safety instructions.....	90
	Trademarks.....	92
<b>B</b>	<b>Troubleshooting and routine maintenance</b>	<b>93</b>
	Troubleshooting.....	93
	If you are having difficulty with your machine.....	93
	Improving the print quality.....	100
	Setting dial tone detection.....	105
	Telephone line interference.....	106
	Error and maintenance messages.....	107
	Transferring your faxes or Fax Journal report.....	111
	Document jams.....	113
	Paper jams.....	114
	Routine maintenance.....	118
	Cleaning the outside of the machine.....	118
	Cleaning the scanner glass.....	119
	Cleaning the laser scanner window.....	120
	Cleaning the corona wire.....	122
	Cleaning the drum unit.....	123
	Replacing the consumable items.....	126
	Replacing a toner cartridge.....	126
	Replacing the drum unit.....	130
	Machine information.....	132
	Checking the serial number.....	132
	Checking the page counters.....	132
	Checking the Drum life.....	133
	Packing and shipping the machine.....	133

<b>C</b>	<b>Menu and features</b>	<b>135</b>
	On-screen programming .....	135
	Menu table .....	135
	Memory storage .....	135
	Menu keys .....	135
	How to access the menu mode .....	136
	Menu table .....	137
	Entering text.....	150
<b>D</b>	<b>Specifications</b>	<b>152</b>
	General .....	152
	Print media.....	154
	Fax.....	155
	Copy .....	157
	Scan.....	158
	Print .....	159
	Interfaces .....	159
	Computer requirements .....	160
	Consumable items .....	162
	Ethernet wired network	
	(MFC-7345N, MFC-7440N and MFC-7840W only) .....	163
	Ethernet wireless network (MFC-7840W only) .....	164
	Authentication and encryption for wireless users only .....	165
	Wi-Fi Alliance certification .....	166
	Wireless one-push configuration .....	167
<b>E</b>	<b>Glossary</b>	<b>168</b>
<b>F</b>	<b>Index</b>	<b>172</b>



# General

---

<b>General information</b>	2
<b>Loading paper and documents</b>	9
<b>General setup</b>	20
<b>Security features</b>	24

## Using the documentation

Thank you for buying a Brother machine! Reading the documentation will help you make the most of your machine.

### Symbols and conventions used in the documentation

The following symbols and conventions are used throughout the documentation.

**Bold** Bold style identifies keys on the machine control panel or computer screen.

*Italics* Italicized style emphasizes an important point or refers you to a related topic.

**Courier New** Courier New font identifies the messages shown on the LCD of the machine.



Warnings tell you what to do to prevent possible personal injury.



Cautions specify procedures you must follow or avoid to prevent possible damage to the machine or other objects.



Electrical Hazard icons alert you to a possible electrical shock.



Hot Surface icons warn you not to touch machine parts that are hot.



Incorrect setup icons alert you to devices and operations that are not compatible with the machine.



Note icons give useful tips.

## Accessing the Software User's Guide and Network User's Guide

This User's Guide does not contain all the information about the machine such as how to use the advanced features of Fax, Printer, Scanner, PC Fax and Network (MFC-7345N, MFC-7440N and MFC-7840W only). When you are ready to learn detailed information about these operations, read the **Software User's Guide** and **Network User's Guide** (MFC-7345N, MFC-7440N and MFC-7840W only).

### Viewing documentation

#### Viewing documentation (Windows®)

To view the documentation, from the **Start** menu, point to **Brother, MFC-XXXX** (where XXXX is your model name) from the program group, and then click **User's Guides in HTML format**.

If you have not installed the software, you can find the documentation by following the instructions below:

- 1 Turn on your PC. Insert the Brother CD-ROM labeled Windows® into your CD-ROM drive.
- 2 If the language selection screen appears, click your language.



- 3 If the model name screen appears, click your model name. The CD-ROM main menu will appear.



*If this window does not appear, use Windows® Explorer to find and run the start.exe program from the root directory of the Brother CD-ROM.*

- 4 Click **Documentation**.
- 5 Click the documentation you want to read:

- HTML documents (2 manuals): **Software User's Guide** and **Network User's Guide** (MFC-7345N, MFC-7440N and MFC-7840W only) in HTML format.

This format is recommended for viewing on your computer.

- PDF documents (4 manuals): **User's Guide** for stand-alone operations, **Software User's Guide**, **Network User's Guide** (MFC-7345N, MFC-7440N and MFC-7840W only) and **Quick Setup Guide**.

This format is recommended for printing the manuals. Click to go to the Brother Solutions Center, where you can view or download the PDF documents. (Internet access and PDF Reader software are required.)

## How to find scanning instructions

There are several ways you can scan documents. You can find the instructions as follows:

### Software User's Guide:

- Scanning a document using the TWAIN driver in Chapter 2
- Scanning a document using the WIA driver (For Windows® XP/Windows Vista® only) in Chapter 2
- Using ControlCenter3 in Chapter 3
- Network Scanning in Chapter 4 (MFC-7345N, MFC-7440N and MFC-7840W only)

### ScanSoft™ PaperPort™ 11SE with OCR How-to-Guides:

- The complete ScanSoft™ PaperPort™ 11SE with OCR How-to-Guides can be viewed from the Help selection in the ScanSoft™ PaperPort™ 11SE application.

## Viewing documentation (Macintosh®)

1 Turn on your Macintosh®. Insert the Brother CD-ROM labeled Macintosh® into your CD-ROM drive.

2 The following window will appear.



3 Double-click the **Documentation** icon.

4 If the language selection screen appears, double-click your language.

5 Double-click the top page file to view the **Software User's Guide** and **Network User's Guide** (MFC-7345N, MFC-7440N and MFC-7840W only) in HTML format.

6 Click the documentation you want to read.

- **Software User's Guide**
- **Network User's Guide** (MFC-7345N, MFC-7440N and MFC-7840W only)

## Note

The documents are also available in PDF format (4 manuals):

**User's Guide** for stand-alone operations, **Software User's Guide**, **Network User's Guide** (MFC-7345N, MFC-7440N and MFC-7840W only) and **Quick Setup Guide**.

The PDF format is recommended for printing the manuals.

Double-click **Brother Solutions Center** icon to go to the Brother Solutions Center, where you can view or download the PDF documents. (Internet access and PDF Reader software are required.)

## How to find scanning instructions

There are several ways you can scan documents. You can find the instructions as follows:

### Software User's Guide:

- Scanning in Chapter 9
- Using ControlCenter2 in Chapter 10
- Network Scanning in Chapter 11 (MFC-7345N, MFC-7440N and MFC-7840W only)

### Presto!® PageManager® User's Guide:

- The complete Presto!® PageManager® User's Guide can be viewed from the Help selection in the Presto!® PageManager® application.

# Accessing Brother support (for Windows®)

You can find all the contacts you will need, such as Web support (Brother Solutions Center), Customer Service and Brother Authorized Service Centers on page i and on the Brother CD-ROM.

- Click **Brother Support** on the main menu. The following screen will appear:

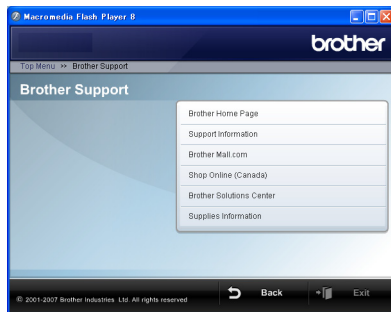

- To access our web site (<http://www.brother.com/>) click **Brother Home Page**.
- To view all Brother Numbers, including Customer Service numbers for the USA and Canada, click **Support Information**.
- To access the USA Brother online shopping mall (<http://www.brothermall.com/>) for additional product and service information, click **Brother Mall.com**.
- To access Canada's Brother online shopping mall (<http://www.brother.ca/>) for additional product and services information, click **Shop Online (Canada)**.
- For the latest news and product support information (<http://solutions.brother.com/>), click **Brother Solutions Center**.
- To visit our web site for original/genuine Brother supplies (<http://www.brother.com/original/>), click **Supplies Information**.

To return to the main page, click **Back**.

Or, if you have finished, click **Exit**.

# Control panel overview

## MFC-7340

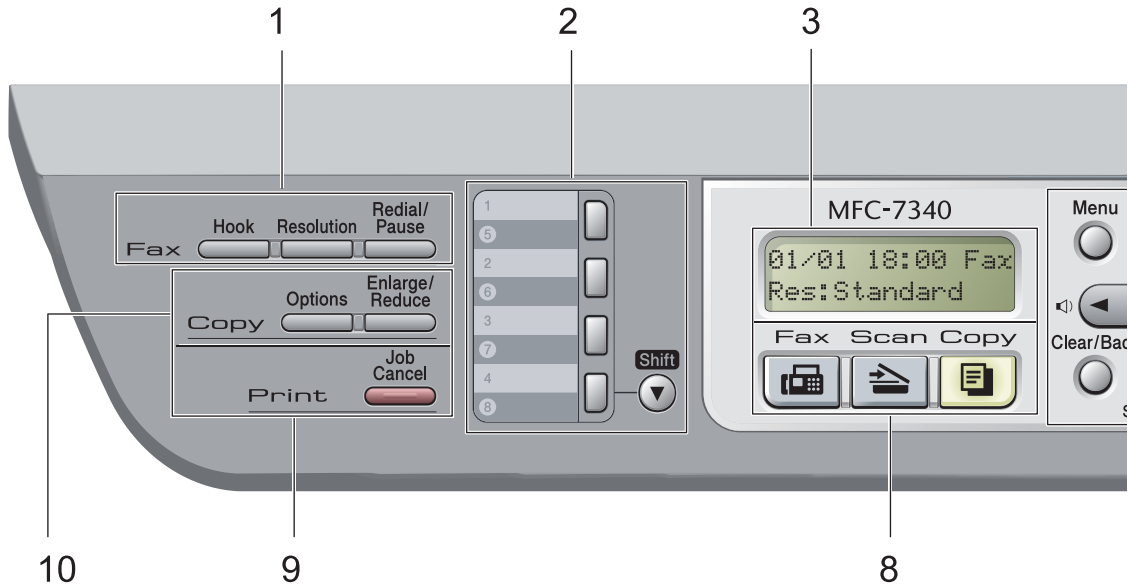

**MFC-7345N, MFC-7440N and MFC-7840W** have the same keys.

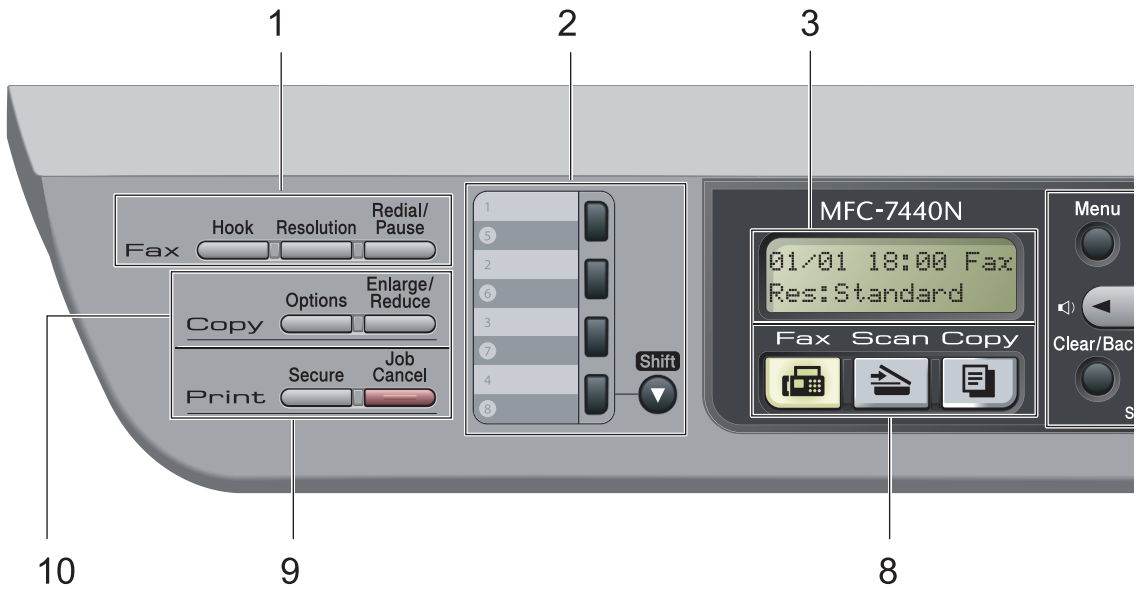

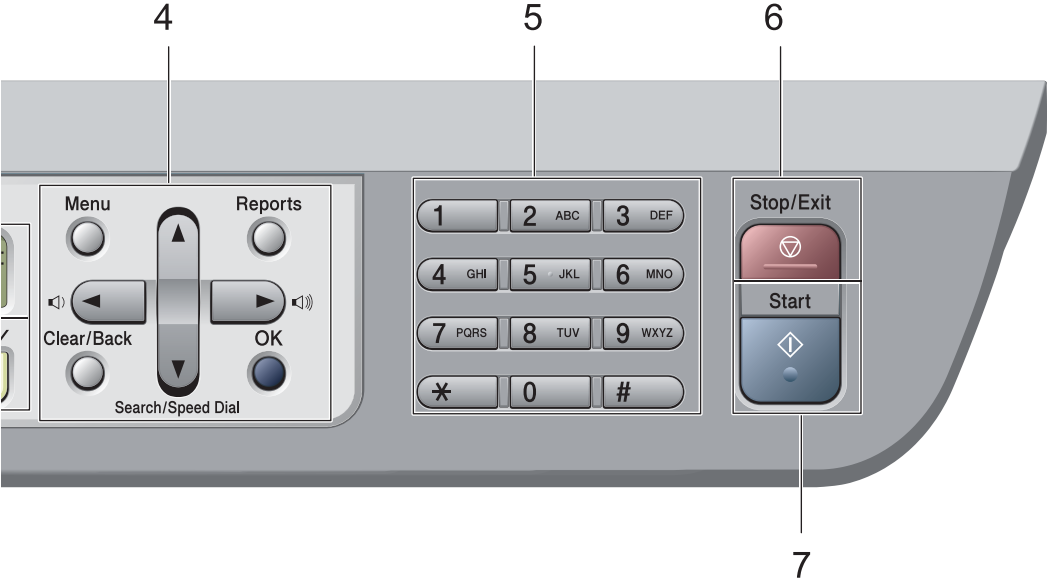

**1 Fax and telephone keys:****Hook**

Press before dialing if you want to make sure a fax machine will answer, and then press **Start**. Also, press this key after you pick up the handset of an external telephone during the F/T ring (fast double-rings).

**Resolution**

Sets the resolution when sending a fax.

**Redial/Pause**

Redials the last number called. It also inserts a pause when programming quick dial numbers or when dialing a number manually.

**2 One Touch keys**

These 4 keys give you instant access to 8 previously stored numbers.

**Shift**

Lets you access One Touch numbers 5 to 8 when held down.

**3 LCD**

Displays messages to help you set up and use your machine.

**4 Menu keys:****Menu**

Lets you access the Menu to program your settings in this machine.



**Clear/Back**

Deletes entered data or lets you cancel the current setting.

**OK**

Lets you store your settings in the machine.

**Volume keys**

 ◀ or ▶ 

Press to scroll backwards or forwards through menu selections. Press to change the volume when in fax or standby mode.

▲ or ▼

Press to scroll through the menus and options.

**▼ Search/Speed Dial**

Lets you look up numbers that are stored in the dialing memory. It also lets you dial stored numbers by pressing a three-digit number.

**Reports**

Print the Transmission Verification Report, Help List, Tel Index List, Fax Journal, User Settings and Network Configuration\*. (\*MFC-7345N, MFC-7440N and MFC-7840W only)

**5 Dial pad**

Use these keys to dial telephone and fax numbers and as a keyboard for entering information into the machine.

(Canada only) The # key temporarily switches the dialing mode from Pulse to Tone during a telephone call.

**6 Stop/Exit**

Stops an operation or exits from a menu.

**7 Start**

Lets you start sending faxes, making copies or scanning.

**8 Mode keys:** **Fax**

Puts the machine in Fax mode.

 **Scan**

Puts the machine in Scan mode. (For details about scanning, see the *Software User's Guide on the CD-ROM*.)

 **Copy**

Puts the machine in Copy mode.

**9 Print keys :**

**Secure** (MFC-7345N, MFC-7440N and MFC-7840W only)

You can print data saved in memory when you enter your four-digit password. (For details about using the Secure key, see the *Software User's Guide on the CD-ROM*.)

(MFC-7840W only) When using Secure Function Lock, you can switch restricted users by holding down **Shift** as you press the **Secure** key. (See *Secure function lock (MFC-7840W only)* on page 25.)

**Job Cancel**

Cancels a programmed print job and clears it from the machine's memory.

To cancel multiple print jobs, hold down this key until the LCD shows

Job Cancel (All).

**10 Copy keys:****Options**

You can quickly and easily choose temporary settings for copying.

**Enlarge/Reduce**

Reduces or enlarges copies.

# 2

## Loading paper and documents

### Loading paper and print media

The machine can feed paper from the standard paper tray or manual feed slot.

When you put paper into the paper tray, note the following:

- If your application software supports paper size selection on the print menu, you can select it through the software. If your application software does not support it, you can set the paper size in the printer driver or by using the control panel buttons.
- Before using paper that has holes in it, such as organizer sheets, you must 'fan' the stack to avoid paper jams and misfeeds.



### Loading paper in the paper tray

2

#### Printing on plain paper, recycled paper or transparencies from the paper tray

- 1 Pull the paper tray completely out of the machine.

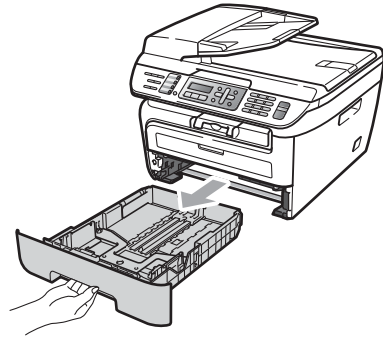

- 2 While pressing the green paper guide release lever, slide the paper guides to fit the paper size. Make sure that the guides are firmly in the slots.

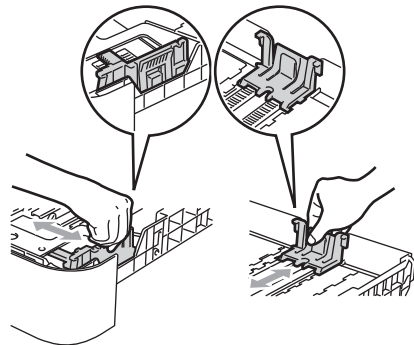

 **Note**

For Legal size paper, press the release button in the bottom of the paper tray and then pull out the back of the paper tray. (Legal size paper is not available in some regions.)

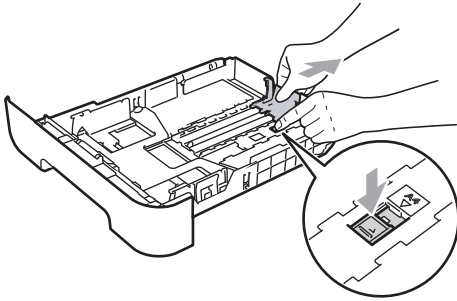

- Put paper in the tray, and make sure that the paper is below the maximum paper mark (1). The side to be printed on must be face down.

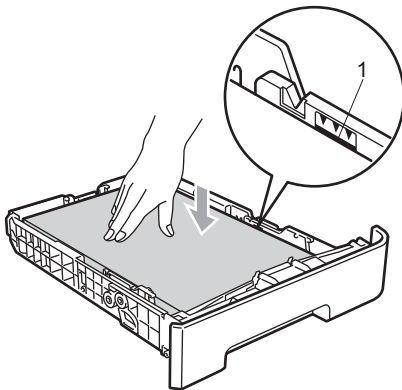

 **CAUTION**

Make sure the paper guides touch the sides of the paper so it will feed properly. If you do not do this, it may cause damage to your machine.

- Put the paper tray firmly back in the machine. Make sure that it is completely inserted into the machine.

- Unfold the support flap (1) to prevent paper from sliding off the face-down output tray.



**Loading paper in the manual feed slot**

You can load envelopes and special print media one at a time into this slot. Use the manual feed slot to print or copy on labels, envelopes or thicker paper.

**Printing on plain paper, recycled paper or transparencies from the manual feed slot**

 **Note**

The machine automatically turns on the Manual Feed mode when you put paper in the manual feed slot.

- Unfold the support flap (1) to prevent paper from sliding off the face-down output tray, or remove each page as soon as it comes out of the machine.

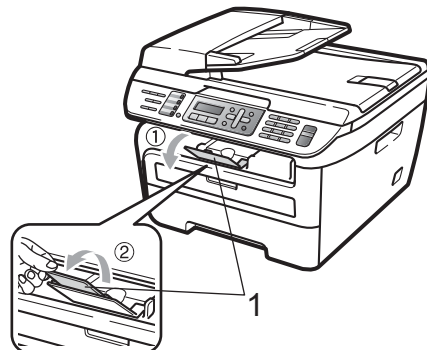



- 2 Open the manual feed slot cover.

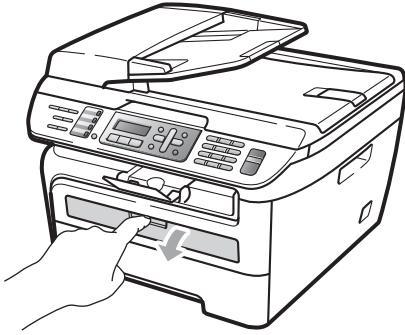

- 3 Using both hands, slide the manual feed slot paper guides to the width of the paper that you are going to use.

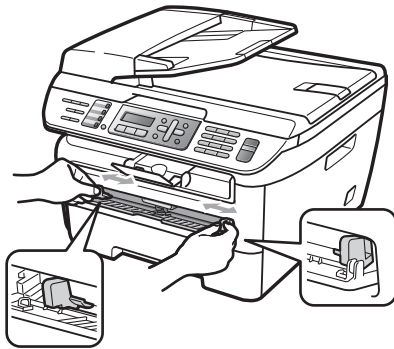

- 4 Using both hands, put one sheet of paper in the manual feed slot until the front edge of the paper or transparency touches the paper feed roller. When you feel the machine pull in the paper, let go.



### Printing on thick paper, bond paper, labels and envelopes

When the back output tray is pulled down, the machine has a straight paper path from the manual feed slot through to the back of the machine. Use this paper feed and output method when you want to print on thick paper, labels or envelopes.



#### Note

- Remove each printed sheet or envelope immediately to prevent a paper jam.
- The machine automatically turns on the Manual Feed mode when you put paper in the manual feed slot.

- 1 Open the back cover (back output tray).

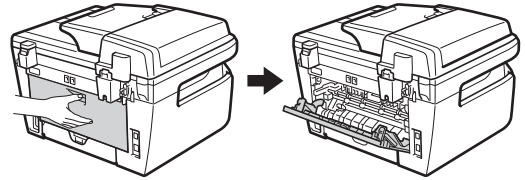

- 2 Open the manual feed slot cover.

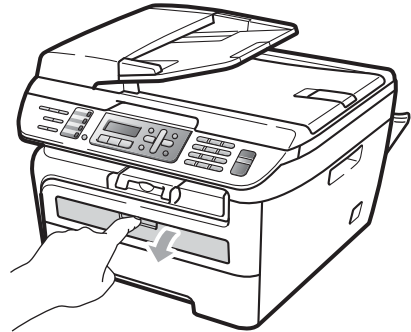

- 3 Using both hands, slide the manual feed slot paper guides to the width of the paper that you are going to use.

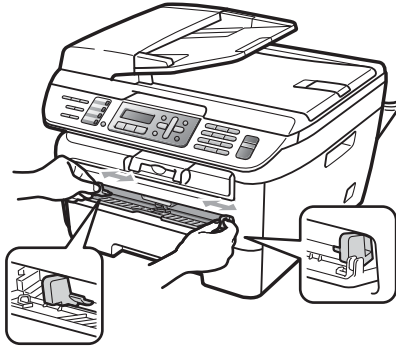

- 4 Using both hands, put one sheet of paper or one envelope in the manual feed slot until the front edge of the paper or envelope touches the paper feed roller. When you feel the machine pull in the paper, let go.

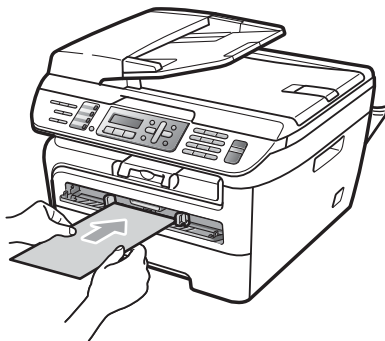
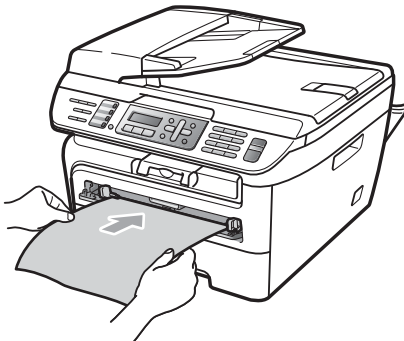

 **Note**

- Put the paper into the manual feed slot with the side to be printed face up.
- Make sure that the print media (paper, transparency and so on) is straight and in the proper position on the manual feed slot. If it is not, the paper or the transparency may not be fed properly, resulting in a skewed printout or a paper jam.
- Do not put more than one sheet of paper in the manual feed slot at any one time, as it may cause a jam.
- If you put any print media in the manual feed slot before the machine is in the Ready state, the print media may be ejected without being printed on.
- To easily remove a small printout from the output tray, lift up the scanner cover by using both hands as shown in the illustration.

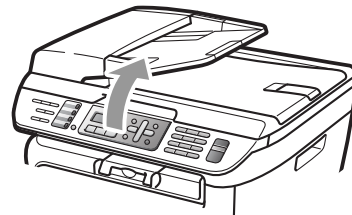

- You can still use the machine while the scanner cover is up. To close the scanner cover, push it down with both hands.

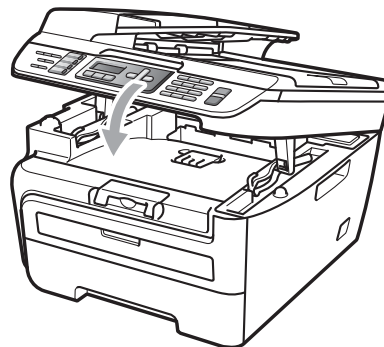

## Unprintable area

### Unprintable area for copies

The printable area of your machine begins at approximately 0.12 in. (3 mm) from the top and bottom and 0.16 in. (4 mm) from both sides of the paper.

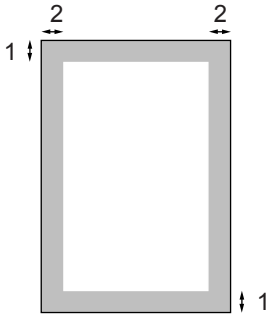

1 0.12 in. (3 mm)

2 0.16 in. (4 mm)



#### Note

This unprintable area shown above is for a single copy or a 1 in 1 copy using Letter size paper. The unprintable area changes with the paper size.

### Unprintable area when printing from a computer

When using the driver the printable area is smaller than the paper size, as shown below.

#### Portrait

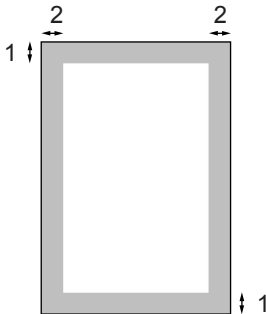

#### Landscape

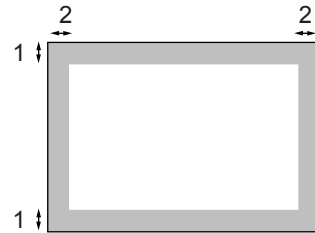

		Windows® printer driver and Macintosh® printer driver	BRScript Driver for Windows® and Macintosh® (MFC-7840W only)
Portrait	1	0.16 in. (4.23 mm)	0.16 in. (4.23 mm)
	2	0.25 in. (6.35 mm)	0.16 in. (4.23 mm)
Landscape	1	0.16 in. (4.23 mm)	0.16 in. (4.23 mm)
	2	0.2 in. (5.08 mm)	0.16 in. (4.23 mm)



#### Note

The unprintable area shown above is for Letter size paper. The unprintable area changes with the paper size.

## Acceptable paper and other print media

Print quality may vary according to the type of paper you are using.

You can use the following types of print media: plain paper, bond paper, recycled paper, transparencies, labels or envelopes.

For best results, follow the instructions below:

- Use paper made for plain paper copying.
- Use paper that is 20 to 24 lb (75 to 90 g/m<sup>2</sup>).
- Use labels and transparencies which are designed for use in laser machines.
- DO NOT put different types of paper in the paper tray at the same time because it may cause paper jams or misfeeds.
- For proper printing, you must choose the same paper size from your software application as the paper in the tray.
- Avoid touching the printed surface of the paper immediately after printing.
- When you use transparencies remove each sheet immediately to prevent smudging or paper jams.
- Use long grain paper with a neutral Ph value, and a moisture content of approx. 5%.

## Recommended paper and print media

To get the best print quality, we suggest using the following paper.

Paper Type	Item
Plain Paper	Xerox 4200DP 20 lb
	Hammermill Laser Print (24 lb=90 g/m <sup>2</sup> )
Recycled Paper	No specific brand recommended
Transparency	3M CG3300
Labels	Avery laser labels white #5160
Envelope	No specific brand recommended

## Type and size of paper

The machine loads paper from the installed standard paper tray or manual feed slot.

### Standard paper tray

Since the standard paper tray is a universal type, you can use any of the paper sizes (one paper type and size at a time) listed in the table in *Paper capacity of the paper trays* on page 15. The standard paper tray can hold up to 250 sheets of Letter/A4, legal or folio size paper (20 lb or 80 g/m<sup>2</sup>). Paper can be loaded up to the maximum paper mark on the sliding paper width guide.

### Manual feed slot

The manual feed slot can hold a sheet with a size of 3 to 8.66 in. (76.2 to 220 mm) wide and 4.57 to 16 in. (116 to 406.4 mm) long. You can use the manual feed slot if you are using special paper, envelopes or labels.

## Paper capacity of the paper trays

	Paper size	Paper types	No. of sheets
Paper Tray	A4, Letter, Legal, Executive, A5, A6, B5, B6 and Folio <sup>1</sup> .	Plain paper and recycled paper	up to 250 [20 lb (80 g/m <sup>2</sup> )]
		Transparency	up to 10
Manual Feed Slot	Width: 3 to 8.66 in. (76.2 to 220 mm) Length: 4.57 to 16 in. (116 to 406.4 mm)	Plain paper, recycled paper, bond paper, envelopes, labels and transparencies	1

<sup>1</sup> Folio size is 8 in. × 13 in. (215.9 mm x 330.2 mm)

## Recommended paper specifications

The following paper specifications are suitable for this machine.

Basis weight	20-24 lb (75-90 g/m <sup>2</sup> )
Thickness	80-110 µm
Roughness	Higher than 20 sec.
Stiffness	90-150 cm <sup>3</sup> /100
Grain direction	Long grain
Volume resistivity	10e <sup>9</sup> -10e <sup>11</sup> ohm
Surface resistivity	10e <sup>9</sup> -10e <sup>12</sup> ohm-cm
Filler	CaCO <sub>3</sub> (Neutral)
Ash content	Below 23 wt%
Brightness	Higher than 80 %
Opacity	Higher than 85 %

## Handling and using special paper

The machine is designed to work well with most types of xerographic and bond paper. However, some paper variables may have an effect on print quality or handling reliability. Always test samples of paper before purchasing to ensure desirable performance. Store paper in its original packaging and keep it sealed. Keep the paper flat and away from moisture, direct sunlight and heat.

Some important guidelines when selecting paper are:

- Do not use inkjet paper because it may cause a paper jam or damage your machine.
- Preprinted paper must use ink that can withstand the temperature of the machine's fusing process (200 degrees centigrade).
- If you use bond paper, paper having a rough surface or paper that is wrinkled or creased, the paper may exhibit degraded performance.

## Types of paper to avoid

### ! CAUTION

Some types of paper may not perform well or may cause damage to your machine.

DO NOT use paper:

- that is highly textured
- that is extremely smooth or shiny
- that is curled or warped

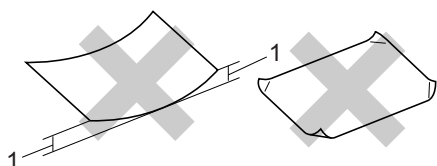

#### 1 0.08 in. (2 mm)

- that is coated or has a chemical finish
- that is damaged, creased or folded
- that exceeds the recommended weight specification in this guide
- with tabs and staples
- with letterheads using low temperature dyes or thermography
- that is multipart or carbonless
- that is designed for inkjet printing

If you use any of the types of paper listed above, they may damage your machine. This damage is not covered under any Brother warranty or service agreement.

## Envelopes

Most envelopes will be suitable for your machine. However, some envelopes may have feed and print-quality problems because of the way they have been made. A suitable envelope should have edges with straight, well-creased folds and the leading edge should not be thicker than two sheets of paper. The envelope should lie flat and not be of baggy or flimsy construction. You should buy quality envelopes from a supplier who understands that you will be using the envelopes in a laser machine.

Envelopes can be fed from manual feed slot one at a time. We recommend that you print a test envelope to make sure the print results are what you want before you print or purchase a large quantity of envelopes.

Check the following:

- Envelopes should have a lengthwise sealing flap.
- The sealing flaps should be folded crisply and correctly (irregularly cut or folded envelopes may cause paper jams).
- Envelopes should consist of two layers of paper in the area circled in figure below.

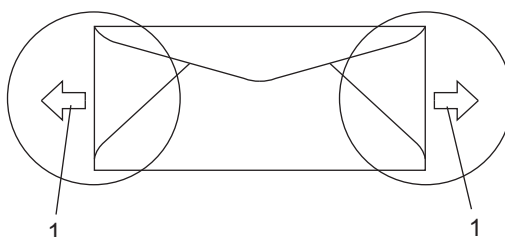

#### 1 Feeding direction

- Envelope joints that are sealed by the manufacturer should be secure.
- We recommend that you do not print within 0.6 in. (15 mm) of the edges of envelopes.

## Types of envelopes to avoid

### ! CAUTION

DO NOT use envelopes:

- that are damaged, curled, wrinkled or an unusual shape
- that are extremely shiny or textured
- with clasps, staples, snaps or tie strings
- with self-adhesive closures
- that are of a baggy construction
- that are not sharply creased
- that are embossed (have raised writing on them)
- that were previously printed by a laser machine
- that are pre-printed on the inside
- that cannot be arranged neatly when stacked
- that are made of paper that weighs more than the paper weight specifications for the machine
- with edges that are not straight or consistently square
- with windows, holes, cut-outs or perforations
- with glue on surface as shown in figure below

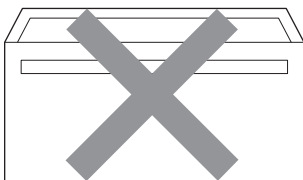

- with double flaps as shown in figure below

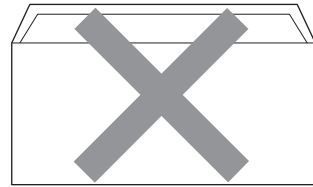

- with sealing flaps that have not been folded at purchase
- with sealing flaps as shown in figure below

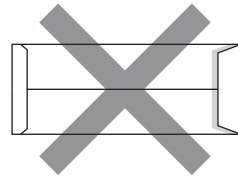

- with each side folded as shown in figure below

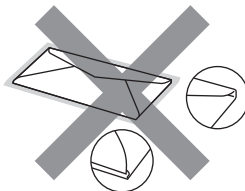

If you use any of the types of envelopes listed above, they may damage your machine. This damage is not covered under any Brother warranty or service agreement.

Occasionally you may experience paper feed problems caused by the thickness, size and flap shape of the envelopes you are using.

## Labels

The machine will print on most types of labels designed for use with a laser machine. Labels should have an adhesive that is acrylic-based since this material is more stable at the high temperatures in the fuser unit. Adhesives should not come in contact with any part of the machine, because the label stock may stick to the drum unit or rollers and cause jams and print quality problems. No adhesive should be exposed between the labels. Labels should be arranged so that they cover the entire length and width of the sheet. Using labels with spaces may result in labels peeling off and causing serious jams or print problems.

All labels used in this machine must be able to withstand a temperature of 392 degrees Fahrenheit (200 degrees centigrade) for a period of 0.1 seconds.

Label sheets should not exceed the paper weight specifications described in this User's Guide. Labels exceeding this specification may not feed or print properly and may cause damage to your machine.

Labels can be fed from the manual feed slot only.

## Types of labels to avoid

Do not use labels that are damaged, curled, wrinkled or an unusual shape.

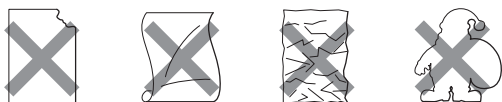

### ! CAUTION

Avoid feeding labels with the carrier sheet exposed because your machine will be damaged.

## Loading documents

### Using the automatic document feeder (ADF)

The ADF can hold up to 35 pages and feeds each sheet individually. Use standard 20 lb (80 g/m<sup>2</sup>) paper and always fan the pages before putting them in the ADF.

### Recommended environment

Temperature: 68° F to 86° F (20 to 30° C) Humidity: 50% - 70% Paper: Xerox 4200 (20 lb/Letter)
--

### ! CAUTION

DO NOT leave thick documents on the scanner glass. If you do this, the ADF may jam.

DO NOT use paper that is curled, wrinkled, folded, ripped, stapled, paper-clipped, pasted or taped.

DO NOT use cardboard, newspaper or fabric.

To avoid damaging your machine while using the ADF, DO NOT pull on the document while it is feeding.

To scan non-standard documents see *Using the scanner glass* on page 19.

- Make sure documents written with ink are completely dry.
- Documents to be faxed must be from 5.8 to 8.5 in. (148 to 215.9 mm) wide and from 5.8 to 14 in. (148 to 355.6 mm) long, and of a standard weight [20 lb (80 g/m<sup>2</sup>)].



- 1 Unfold the ADF document output support flap (1) and the ADF support flap (2).

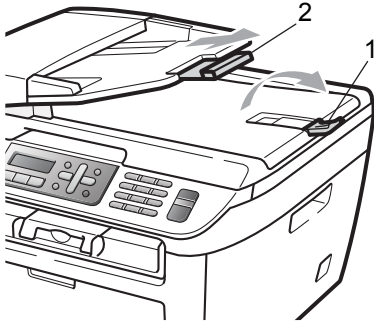

- 2 Fan the pages well.
- 3 Place your document, face up top edge first, in the ADF until you feel it touch the feed roller.
- 4 Adjust the paper guides (1) to fit the width of your document.

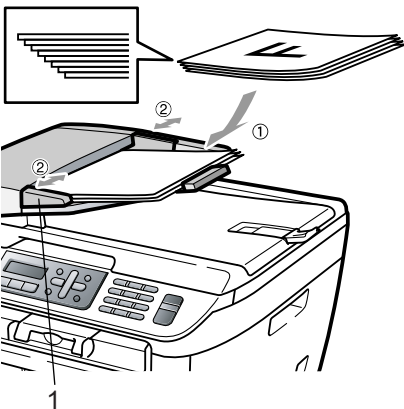

- 1 Lift the document cover.
- 2 Using the document guidelines on the left, center the document face down on the scanner glass.

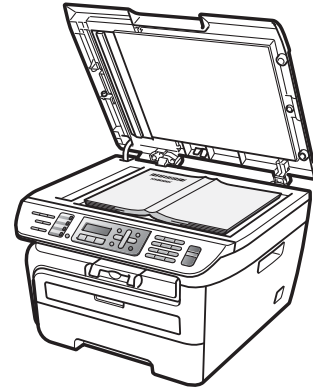
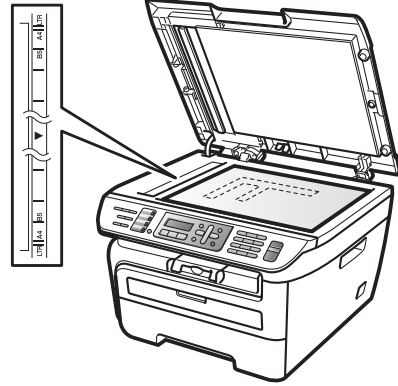

- 3 Close the document cover.

### ! CAUTION

If the document is a book or is thick do not slam the cover or press on it.

## Using the scanner glass

You can use the scanner glass to fax, copy or scan pages of a book or one page at a time. Documents can be up to 8.5 in. wide and 11.7 in. long (215.9 mm wide and 297 mm long).



### Note

To use the scanner glass, the ADF must be empty.

# 3

## General setup

### Mode timer

The machine has three mode keys on the control panel: **Fax**, **Scan**, and **Copy**.

You can set how much time the machine takes after the last Copy or Scan operation to return to Fax mode. If you choose *Off*, the machine will stay in the mode you used last.

(MFC-7840W only) This setting also sets the time the machine will change from individual user to public user when using Secure Function Lock. (See *Switching users* on page 27.)

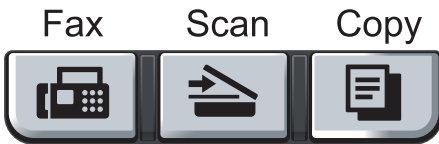

- 1 Press **Menu**, 1, 1.

```
General Setup
1.Mode Timer
```

- 2 Press **▲** or **▼** to choose 0 Sec, 30 Secs, 1 Min, 2 Mins, 5 Mins or *Off*. Press **OK**.
- 3 Press **Stop/Exit**.

### Paper settings

#### Paper type

Set up the machine for the type of paper you are using. This will give you the best print quality.

- 1 Press **Menu**, 1, 2.

```
General Setup
2.Paper Type
```

- 2 Press **▲** or **▼** to choose *Thin*, *Plain*, *Thick*, *Thicker*, *Transparency* or *Recycled Paper*. Press **OK**.
- 3 Press **Stop/Exit**.

#### Paper size

You can use nine sizes of paper for printing copies: A4, Letter, Legal, Executive, A5, A6, B5, B6 and Folio and four sizes for printing faxes: A4, Letter, Legal or Folio (8"×13").

When you change the size of paper in the tray, you will also need to change the setting for paper size at the same time so your machine can fit the document or an incoming fax on the page.

- 1 Press **Menu**, 1, 3.

```
General Setup
3.Paper Size
```

- 2 Press **▲** or **▼** to choose A4, Letter, Legal, Executive, A5, A6, B5, B6 or Folio. Press **OK**.
- 3 Press **Stop/Exit**.



#### Note

If you chose *Transparency* as the paper type (**Menu**, 1, 2) you will only be able to choose *Letter*, *Legal*, *Folio* or *A4* size paper in Step 2.

## Volume settings

### Ring volume

You can choose a ring volume level from a range of settings, from *High* to *Off*.

While in Fax mode press  $\blacktriangleleft$  or  $\blacktriangleright$  to adjust the volume level. The LCD will show the current setting, and each key press will change the volume to the next level. The machine will keep the new setting until you change it.

You can also change the ring volume through the menu:

- 1 Press **Menu, 1, 4, 1.**

```
Volume
1. Ring
```

- 2 Press  $\blacktriangle$  or  $\blacktriangledown$  to choose *Off, Low, Med* or *High*.  
Press **OK**.
- 3 Press **Stop/Exit**.

### Beeper volume

When the beeper is on, the machine will beep when you press a key, make a mistake, or after you send or receive a fax. You can choose a range of volume levels, from *High* to *Off*.

- 1 Press **Menu, 1, 4, 2.**

```
Volume
2. Beeper
```

- 2 Press  $\blacktriangle$  or  $\blacktriangledown$  to choose *Off, Low, Med* or *High*.  
Press **OK**.
- 3 Press **Stop/Exit**.

### Speaker volume

You can choose a range of speaker volume levels, from *High* to *Off*.

- 1 Press **Menu, 1, 4, 3.**

```
Volume
3. Speaker
```

- 2 Press  $\blacktriangle$  or  $\blacktriangledown$  to choose *Off, Low, Med* or *High*.  
Press **OK**.
- 3 Press **Stop/Exit**.

You can also adjust the speaker volume with the control panel keys.

- 1 Press  (**Fax**).
- 2 Press **Hook**.
- 3 Press  $\blacktriangleleft$  or  $\blacktriangleright$ .  
This setting will stay until you change it again.
- 4 Press **Hook**.

## Automatic daylight savings time

You can set the machine to change automatically for Daylight Savings Time. It will set itself forward one hour in the Spring, and back one hour in the Fall.

- 1 Press **Menu 1, 5**.

```
General Setup
5.Auto Daylight
```

- 2 Press **▲** or **▼** to choose **On** or **Off**. Press **OK**.
- 3 Press **Stop/Exit**.

## Ecology features

### Toner save

You can save toner using this feature. When you set toner save to **On**, print appears lighter. The default setting is **Off**.

- 1 Press **Menu, 1, 6, 1**.

```
Ecology
1.Toner Save
```

- 2 Press **▲** or **▼** to choose **On** or **Off**. Press **OK**.
- 3 Press **Stop/Exit**.



#### Note

We do not recommend Toner Save for printing Photo or Gray Scale images.

## Sleep time

Setting the sleep time reduces power consumption by turning off the fuser while the machine is idle.

You can choose how long the machine must be idle (from 00 to 99 minutes) before it goes into sleep mode. When the machine receives a fax, computer data, or makes a copy, the timer will be reset. The default setting is 05 minutes.

While the machine is in sleep mode the LCD will display **Sleep**. When printing or copying in sleep mode, there will be a short delay while the fuser warms up.

- 1 Press **Menu 1, 6, 2**.

```
Ecology
2.Sleep Time
```

- 2 Enter the length of time the machine is idle before entering sleep mode (00 to 99). Press **OK**.
- 3 Press **Stop/Exit**.



#### Note

To turn *off* sleep mode, press **Start** and **Options** at the same time in ②. Press **▲** or **▼** to choose **Off**. Press **OK**.

## LCD contrast

You can change the contrast to make the LCD look lighter or darker.

- 1 Press **Menu, 1, 7**.

```
General Setup
7.LCD Contrast
```

- 2 Press **▲** to make the LCD darker. Or, press **▼** to make the LCD lighter. Press **OK**.
- 3 Press **Stop/Exit**.

## Dial prefix

The dial prefix setting will automatically dial a predefined number before every fax number you dial. For example: If your telephone system requires a 9 to dial an outside number use this setting to automatically dial 9 for every fax you send.

### Setting up the prefix number

- 1 (USA) Press **Menu, 0, 5**.  
(Canada) Press **Menu, 0, 6**.
- 2 Enter the prefix number (up to 5 digits) on the dial pad.  
Press **OK**.



#### Note

- You can use the numbers 0 to 9, #, \* and !. (Press **Hook** to display "!".)

You cannot use ! with any other numbers or characters.

If your telephone system requires a timed break recall (hookflash), press **Hook** to enter the break.

- (Canada only) If the pulse dialing mode is on, # and \* are not available to use.

- 3 Press **Stop/Exit**.

### Changing the prefix number

- 1 (USA) Press **Menu, 0, 5**.  
(Canada) Press **Menu, 0, 6**.
- 2 Do one of the following:
  - To change the prefix number, press **1**.
  - To exit without making a change, press **2** and go to **4**.
- 3 Enter a new prefix number using the dial pad (up to 5 digits),  
press **OK**.
- 4 Press **Stop/Exit**.

# 4

## Security features

### Security

You can set up your machine with multiple levels of security using Setting Lock and TX Lock (MFC-7340, MFC-7345N and MFC-7440N only) or Secure Function Lock (MFC-7840W only). You will not be able to continue to schedule Delayed Faxes or Polling jobs. However, any prescheduled Delayed Faxes will be sent even if you turn on TX Lock or Secure Function Lock, so they will not be lost.

#### TX lock (MFC-7340, MFC-7345N and MFC-7440N only)

TX Lock lets you prevent unauthorized access to the machine. While TX Lock is on, the following operations are available:

- Receiving faxes
- Fax Forwarding  
(if Fax Forwarding was already on)
- Paging  
(if Paging was already on)
- Remote Retrieval  
(if Fax Storage was already on)
- PC Fax Receive  
(if PC Fax Receive was already on)

While TX Lock is on, the following operations are NOT available:

- Sending faxes
- Copying
- PC printing
- Scanning



#### Note

- To print the faxes in memory, turn off TX Lock.
- If you forget the TX Lock password, please call Brother Customer Service.

### Setting up the password



#### Note

If you have already set the password, you will not need to set it, again.

- 1 Press **Menu**, **1**, **8**, **1**.

```
Security
1.TX Lock
```

- 2 Enter a four-digit number for the password using numbers 0-9. Press **OK**.
- 3 If you are entering the password for the first time, the LCD will show *Verify:*
- 4 Re-enter the password. Press **OK**.
- 5 Press **Stop/Exit**.

### Changing the TX lock password

- 1 Press **Menu**, **1**, **8**, **1**.

```
Security
1.TX Lock
```

- 2 Press **▲** or **▼** to choose *Set Password*. Press **OK**.
- 3 Enter the registered four-digit password. Press **OK**.
- 4 Enter a four-digit number for the new password. Press **OK**.
- 5 If the LCD shows *Verify:*, re-enter the new password. Press **OK**.
- 6 Press **Stop/Exit**.

## Secure function lock (MFC-7840W only)

Secure Function Lock lets you restrict Public access to certain machine functions (Fax Tx, Fax Rx, Copy, Scan and Print <sup>1</sup>).

This feature also prevents users from changing the Default settings of the machine by limiting access to the Menu settings.

Disabling at least one function is required to turn on Secure Function Lock for the Public user.

Before using the security features you must first enter an administrator password.

Access to restricted operations can be enabled by creating a restricted user. Restricted users must enter a user password to use the machine.

Make a careful note of your password. If you forget it, please call Brother Customer Service.

<sup>1</sup> Print includes PC-Fax Send as well as all print jobs.



### Note

- You can set up to 10 individual users and one Public user.
- When you set up a Public user, you can restrict one or more of the machine's functions to all users who do not have a password.
- Only administrators can set limitations and make changes for each user.
- When Print is disabled, PC print jobs will be lost without notification.
- When Secure Function Lock is on, you can only use 1.Contrast, 6.Polled TX or 7.Coverpg Setup in the Fax menu.  
If Fax Tx is disabled, you cannot use any function in the Fax menu.
- Polling Receive is enabled only when the both Fax Tx and Fax Rx are enabled.

## Setting the password for the administrator

The password you set in these steps is for the administrator. This password is used to set up users and to turn Secure Function Lock on or off. (See *Setting up restricted users* on page 26 and *Turning secure function lock on* on page 27.)

- 1 Press **Menu, 1, 8, 1**.

```
Security
1.Function Lock
```

- 2 Enter a four-digit number for the password using numbers 0-9. Press **OK**.
- 3 Re-enter the password when the LCD shows `Verify:.` Press **OK**.
- 4 Press **Stop/Exit**.

## Changing the password for the administrator

- 1 Press **Menu, 1, 8, 1**.

```
Security
1.Function Lock
```

- 2 Press **▲** or **▼** to choose `Set Password`. Press **OK**.
- 3 Enter the registered four-digit password. Press **OK**.
- 4 Enter a four-digit number for the new password. Press **OK**.
- 5 If the LCD shows `Verify:.`, re-enter the new password. Press **OK**.
- 6 Press **Stop/Exit**.

## Setting up the public user

You can set up the Public user. Public users do not need to enter a password.



### Note

You must disable at least one function to turn on Secure Function Lock for the Public user.

- 1 Press **Menu, 1, 8, 1**.

```
Security
1.Function Lock
```

- 2 Press **▲** or **▼** to choose `Setup User`. Press **OK**.
- 3 Enter the administrator password. Press **OK**.
- 4 Press **▲** or **▼** to choose `Public`. Press **OK**.
- 5 Press **▲** or **▼** to choose `Enable` or `Disable` for `Fax Tx`. Press **OK**. After you have set `Fax Tx`, repeat this step for `Fax Rx`, `Copy`, `Scan` and `Print`. Press **OK**.



### Note

You can set PC printing for only the Public user. If you disable `Print` for Public users it will also disable PC printing for all restricted users.

- 6 Press **Stop/Exit**.

## Setting up restricted users

You can set up users with restrictions and a password.

- 1 Press **Menu, 1, 8, 1**.

```
Security
1.Function Lock
```

- 2 Press **▲** or **▼** to choose `Setup User`. Press **OK**.
- 3 Enter the administrator password. Press **OK**.
- 4 Press **▲** or **▼** to choose `User01`. Press **OK**.
- 5 Use the numeric keys to enter the user name. (See *Entering text* on page 150.) Press **OK**.
- 6 Enter a four-digit password for the user. Press **OK**.
- 7 Press **▲** or **▼** to choose `Enable` or `Disable` for `Fax Tx`. Press **OK**. After you have set `Fax Tx`, repeat this step for `Fax Rx`, `Copy` and `Scan`. Press **OK**.
- 8 Repeat 4 to 7 for entering each additional user and password.
- 9 Press **Stop/Exit**.



### Note

You cannot use the same password as another user's password.



## Turning secure function lock on/off

If you enter the wrong password when following the instructions below, the LCD will show `Wrong Password`. Re-enter the correct password.

### Turning secure function lock on

- 1 Press **Menu, 1, 8, 1**.

```
Security
1.Function Lock
```

- 2 Press **▲** or **▼** to choose `Lock Off-On`. Press **OK**.

- 3 Enter your four-digit administrator password. Press **OK**.

### Turning secure function lock off

- 1 Press **Menu, 1, 8, 1**.

```
Security
1.Function Lock
```

- 2 Press **▲** or **▼** to choose `Lock On-Off`. Press **OK**.

- 3 Enter your four-digit administrator password. Press **OK**.

## Switching users

This setting allows a restricted user to log on the machine when Secure Function Lock is turned on.



### Note

After a restricted user has finished using the machine, it will return to the Public setting within the same time as the Mode Timer setting (**Menu, 1,1**). (See *Mode timer* on page 20.) Also, you can exit from an individual user by pressing the lighted Mode key.

- 1 Hold down **Shift** as you press **Secure**.

```
Change User
PIN:XXXX
```

- 2 Enter your four-digit password. Press **OK**.

### When Copy mode is disabled:

- 1 Press the **Copy** key.

```
Access Denied
```

- 2 Enter your four-digit password. Press **OK**.

### When Scan mode is disabled:

- 1 Press the **Scan** key.

```
Access Denied
```

- 2 Enter your four-digit password. Press **OK**.

## Setting lock

Setting Lock lets you set a password to stop other people from accidentally changing your machine settings.

Make a careful note of your password. If you forget it, please call Brother Customer Service.

While Setting Lock is **On**, you cannot change the following settings without a password:

- Date/Time
- Station ID
- Quick Dial settings
- Mode Timer
- Paper Type
- Paper Size
- Volume
- Auto Daylight
- Ecology
- LCD Contrast
- Setting Lock
- Dial Restriction
- TX Lock  
(MFC-7340, MFC-7345N and MFC-7440N only)

### Setting up the password

- 1 Press **Menu**, **1**, **8**, **2**.

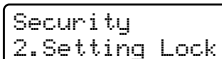

Security  
2.Setting Lock

- 2 Enter a four-digit number for the password using numbers 0-9.  
Press **OK**.
- 3 Re-enter your password when the LCD shows *Verify:.*  
Press **OK**.
- 4 Press **Stop/Exit**.

### Changing your setting lock password

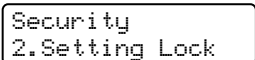
- 1 Press **Menu**, **1**, **8**, **2**.  

- 2 Press **▲** or **▼** to choose *Set Password*.  
Press **OK**.
- 3 Enter your four-digit password.  
Press **OK**.
- 4 Enter a four-digit number for the new password.  
Press **OK**.
- 5 Re-enter your new password when the LCD shows *Verify:.*  
Press **OK**.
- 6 Press **Stop/Exit**.

### Turning setting lock on/off

If you enter the wrong password when following the instructions below, the LCD will show *Wrong Password*. Re-enter the correct password.

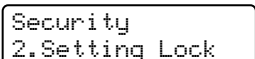
#### Turning setting lock on

- 1 Press **Menu**, **1**, **8**, **2**.  

- 2 Press **▲** or **▼** to choose *On*.  
Press **OK**.
- 3 Enter your four-digit password.  
Press **OK**.
- 4 Press **Stop/Exit**.

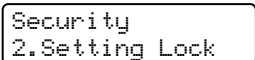
#### Turning setting lock off

- 1 Press **Menu**, **1**, **8**, **2**.  

- 2 Enter your four-digit password.  
Press **OK** twice.
- 3 Press **Stop/Exit**.

## Restricting dialing

This feature is to prevent users from sending a fax or call to a wrong number by mistake. You can set the machine to restrict dialing by using the dial pad, One Touch or Speed Dial.

If you choose *Off*, the machine does not restrict any dialing method.

If you choose *Enter # twice*, the machine will prompt you to re-enter the number, and then if you re-enter the same number correctly, the machine will start dialing. If you re-enter the wrong number, the LCD will show an error message.

If you choose *On*, the machine will restrict all fax sending and outbound calls.

### Dial pad restriction

- 1 Press **Menu, 2, 6, 1.**

```
Dial Restrict.
1.Dial Pad
```

- 2 Press **▲** or **▼** to choose *Off*,  
*Enter # twice* or *On*.  
Press **OK**.

- 3 Press **Stop/Exit**.

### One touch restriction

- 1 Press **Menu, 2, 6, 2.**

```
Dial Restrict.
2.One Touch Dial
```

- 2 Press **▲** or **▼** to choose *Off*,  
*Enter # twice* or *On*.  
Press **OK**.

- 3 Press **Stop/Exit**.

### Speed dial restriction

- 1 Press **Menu, 2, 6, 3.**

```
Dial Restrict.
3.Speed Dial
```

- 2 Press **▲** or **▼** to choose *Off*,  
*Enter # twice* or *On*.  
Press **OK**.

- 3 Press **Stop/Exit**.



#### Note

- The *Enter # twice* setting will not work if you use an external phone or press the **Hook** key before entering the number. You will not be asked to re-enter the number.
- You can not restrict dialing when you use the **Redial/Pause** key.
- If you chose *On* or *Enter # twice*, you can not use the Broadcasting feature and can not combine quick dial numbers when dialing.





# Fax

---

<b>Sending a fax</b>	32
<b>Receiving a fax</b>	39
<b>Telephone services and external devices</b>	44
<b>Dialing and storing numbers</b>	53
<b>Remote fax options</b>	58
<b>Polling</b>	65
<b>Printing reports</b>	67

# 5

## Sending a fax

### How to fax

#### Entering fax mode

To enter fax mode press  (Fax), and the key will glow green.

#### Sending a fax from the ADF

Using the ADF to send your faxes is the easiest way. To cancel a fax in progress press **Stop/Exit**.

- 1 Make sure you are in Fax mode .
- 2 Place your document *face up* in the ADF.
- 3 Dial the fax number. (See *How to dial* on page 53.)
- 4 Press **Start**.  
The machine scans the pages into memory and then sends the document.



#### Note

If the **Out of Memory** message appears while scanning a document into memory, press **Stop/Exit** to cancel or **Start** to send the scanned pages.

#### Sending a fax from the scanner glass

You can use the scanner glass to fax the pages of a book, or a single page at a time. The documents can be up to Letter or A4 size. Press **Stop/Exit** to cancel a fax in progress.

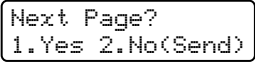
- 1 Make sure you are in Fax mode .
- 2 Place your document *face down* on the scanner glass.
- 3 Dial the fax number. (See *How to dial* on page 53.)
- 4 Press **Start**.  
The machine starts scanning the first page.
- 5 After the machine scans the page, the LCD will prompt you to choose one of the options below:  

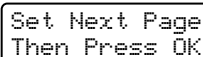
  - Press **1** to send another page. Go to 6.
  - Press **2** or **Start** to send the document. Go to 7.
- 6 Place the next page on the scanner glass, press **OK**. Repeat 5 and 6 for each additional page.



- 7 Your machine will automatically send the fax.



#### Note

When faxing multiple pages from the scanner glass, real time transmission should be set to **OFF**. (See *Real time transmission* on page 36.)

## Canceling a fax in progress

Press **Stop/Exit** to cancel the fax. If you press **Stop/Exit** while the machine is dialing or sending, the LCD will show

1. **Clear** 2. **Exit**, press **1** to cancel the fax.

## Broadcasting

Broadcasting lets you send the same fax message to more than one fax number. You can include Groups, One Touch, Speed Dial numbers and up to 50 manually dialed numbers in the same broadcast.

You can broadcast up to 258 different numbers. This will depend on how many groups, access codes or credit card numbers you have stored, and on how many delayed or stored faxes in memory.



### Note

Use the **Search/Speed Dial** to help you choose numbers easily.

- 1 Make sure you are in Fax mode .
- 2 Load your document.
- 3 Enter a number.  
Press **OK**.  
You can use either a One Touch, Speed Dial, a Group number, or a number manually entered using the dial pad. (See *How to dial* on page 53.)
- 4 Repeat 3 until you have entered all the fax numbers you want to broadcast to.
- 5 Press **Start**.

After the broadcast is finished the machine will print a broadcast report to let you know the results.

## Canceling a broadcast in progress

While broadcasting you can cancel the fax currently being sent or the whole broadcast job.

- 1 Press **Menu**, **2**, **7**.  
The LCD will display the fax being dialed (for example, #001 0123456789) and the broadcast job number (for example, Broadcast#001).

Fax  
 7.Remaining Jobs

- 2 Press **▲** or **▼** to choose the job number you want to cancel.  
Press **OK**.
- 3 Press **1** to clear the job number or **2** to exit.  
If you chose to only cancel the fax currently being sent in 2, the machine will ask you if you want to cancel the broadcast. Press **1** to clear the whole broadcast job or **2** to exit.
- 4 Press **Stop/Exit**.

## Additional sending operations

### Sending faxes using multiple settings

Before you send a fax, you can change any combination of these settings: contrast, resolution, overseas mode, delayed fax timer, polling transmission, real time transmission or cover page settings.

- 1 Make sure you are in Fax mode . After each setting is accepted, the LCD asks if you want to enter more settings:

```
Other Settings
1.Yes 2.No
```

- 2 Do one of the following:
  - To choose more settings, press **1**. The LCD returns to the `Setup Send` menu so you can choose another setting.
  - If you have finished choosing settings, press **2** and go to the next step for sending your fax.

### Electronic cover page

This feature will *not* work unless you have already programmed your Station ID. (See *the Quick Setup Guide*.)

You can automatically send a cover page with every fax. Your cover page includes your Station ID, a comment, and the name (or number) stored in the One Touch or Speed Dial memory.

By choosing `Next Fax:On` you can also display the number of pages on the cover page.

You can choose one of the following preset comments.

- 1.Comment Off
- 2.Please Call

- 3.Urgent
- 4.Confidential

Instead of using one of the preset comments, you can enter two personal messages of your own, up to 27 characters long. Use the chart on page 150 for help entering characters.

(See *Composing your own comments* on page 34.)

- 5.(User Defined)
- 6.(User Defined)

### Composing your own comments

You can set up two comments of your own.

- 1 Make sure you are in Fax mode .
- 2 Press **Menu, 2, 2, 8**.
 

```
Setup Send
8.Coverpage Msg
```
- 3 Press **▲** or **▼** to choose 5 or 6 to store your own comment. Press **OK**.
- 4 Enter your own comment using the dial pad. Press **OK**.

Use the chart on page 150 for help entering characters.

### Send a cover page for the next fax

If you want to send a cover page only for the next fax, your machine will ask you to enter the number of pages you are sending so it can be printed on the cover page.

- 1 Make sure you are in Fax mode .
- 2 Load your document.
- 3 Press **Menu, 2, 2, 7**.

```
Setup Send
7.Coverpg Setup
```



- 4 Press ▲ or ▼ to choose `Next Fax:On` (or `Next Fax:Off`). Press **OK**.
- 5 Press ▲ or ▼ to choose a comment. Press **OK**.
- 6 Enter two digits to show the number of pages you are sending. Press **OK**.  
For example, enter **0, 2** for 2 pages or **0, 0** to leave the number of pages blank. If you make a mistake, press ◀ or **Clear/Back** to back up and re-enter the number of pages.

### Send a cover page for all faxes

You can set the machine to send a cover page whenever you send a fax.

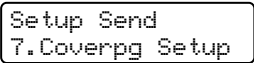
- 1 Make sure you are in Fax mode .
- 2 Press **Menu, 2, 2, 7**.  

- 3 Press ▲ or ▼ to choose `On` (or `Off`). Press **OK**.
- 4 Press ▲ or ▼ to choose a comment. Press **OK**.

### Using a printed cover page

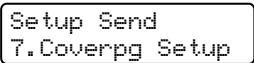
If you want to use a printed cover page that you can write on, you can print the sample page and attach it to your fax.

- 1 Make sure you are in Fax mode .
- 2 Press **Menu, 2, 2, 7**.  

- 3 Press ▲ or ▼ to choose `Print Sample`. Press **OK**.
- 4 Press **Start**.

- 5 After the machine print a copy of your cover page, press **Stop/Exit**.

## Contrast

For most documents the default setting of `Auto` will give the best results. It automatically chooses the suitable contrast for your document.

If your document is very light or dark, changing the contrast may improve the quality of the fax.

Use `Dark` to make the faxed document lighter.

Use `Light` to make the faxed document darker.

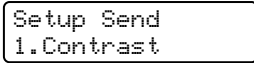
- 1 Make sure you are in Fax mode .
- 2 Load your document.
- 3 Press **Menu, 2, 2, 1**.  

- 4 Press ▲ or ▼ to choose `Auto`, `Light` or `Dark`. Press **OK**.



### Note

Even if you choose `Light` or `Dark`, the machine will send the fax using the `Auto` setting if you choose `Photo` as the Fax Resolution.



## Changing fax resolution

The quality of a fax can be improved by changing the fax resolution. Resolution can be changed for the next fax *or* for all faxes.

### To change the fax resolution for the next fax

- 1 Make sure you are in Fax mode .
- 2 Load your document.
- 3 Press **Resolution**, then **▲** or **▼** to choose the resolution. Press **OK**.

### To change the default fax resolution

- 1 Make sure you are in Fax mode .
- 2 Press **Menu**, **2**, **2**, **2**.  

- 3 Press **▲** or **▼** to choose the resolution you want. Press **OK**.



#### Note

You can choose four different resolution settings.

**Standard**  
Suitable for most typed documents.

**Fine**  
Good for small print and transmits a little slower than Standard resolution.

**S.Fine**  
Good for small print or artwork and transmits slower than Fine resolution.

**Photo**  
Use when the document has varying shades of gray or is a photograph. This has the slowest transmission time.

## Dual access

You can dial a number, and start scanning the fax into memory—even when the machine is sending from memory, receiving faxes or printing PC data. The LCD will show the new job number.

The number of pages you can scan into the memory will vary depending on the data that is printed on them.



#### Note

If you get an **Out of Memory** message while scanning the first page of a fax, press **Stop/Exit** to cancel scanning. If you get an **Out of Memory** message while scanning a subsequent page, you can press **Start** to send the pages scanned so far, or press **Stop/Exit** to cancel the operation.

## Real time transmission

When you are sending a fax, the machine will scan the documents into the memory before sending. Then, as soon as the telephone line is free, the machine will start dialing and sending.

If the memory is full, the machine will send the document in real time (even if **Real Time TX** is set to **Off**).

Sometimes, you may want to send an important document immediately, without waiting for memory transmission. You can set **Real Time TX** to **On** for all documents or **Next Fax:On** for the next fax only.



#### Note

In **Real Time Transmission**, the automatic redial feature does not work when using the scanner glass.

## Sending in real time for all faxes

- 1 Make sure you are in Fax mode .
  - 2 Press **Menu, 2, 2, 5**.
- Setup Send  
5.Real Time TX
- 3 Press **▲** or **▼** to choose **On**.  
Press **OK**.

## Sending in real time for the next fax only

- 1 Make sure you are in Fax mode .
  - 2 Press **Menu, 2, 2, 5**.
- Setup Send  
5.Real Time TX
- 3 Press **▲** or **▼** to choose **Next Fax:On**.  
Press **OK**.

## Overseas mode

If you are having difficulty sending a fax overseas due to a bad connection, then turning on the overseas mode may help.

This is a temporary setting, and will only be active for your next fax.

- 1 Make sure you are in Fax mode .
  - 2 Load your document.
  - 3 Press **Menu, 2, 2, 9**.
- Setup Send  
9.Overseas Mode
- 4 Press **▲** or **▼** to choose **On or Off**.  
Press **OK**.

## Delayed fax

You can store up to 50 faxes in the memory to be sent within a twenty four hour period.

- 1 Make sure you are in Fax mode .
  - 2 Load your document.
  - 3 Press **Menu, 2, 2, 3**.
- Setup Send  
3.Delayed Fax
- 4 Enter the time you want the fax to be sent (in 24-hour format).  
(For example, enter 19:45 for 7:45 PM)  
Press **OK**.



### Note

The number of pages you can scan into the memory depends on the amount of data printed on each page.

## Delayed batch transmission

Before sending the delayed faxes, your machine will help you economize by sorting all the faxes in the memory by destination and scheduled time.

All delayed faxes that are scheduled to be sent at the same time to the same fax number will be sent as one fax to save transmission time.

- 1 Make sure you are in Fax mode .
  - 2 Press **Menu, 2, 2, 4**.
- Setup Send  
4.Batch TX
- 3 Press **▲** or **▼** to choose **On or Off**.  
Press **OK**.
  - 4 Press **Stop/Exit**.

## Checking and canceling waiting jobs

---

Check which jobs are still waiting in the memory to be sent. If there are no jobs, the LCD will show `No Jobs Waiting`. You can cancel a fax job that is stored and waiting in the memory.

- 1 Press **Menu**, **2**, **7**.  
The number of jobs still to be sent will be displayed.
- 2 Do one of the following:
  - Press **▲** or **▼** to scroll through the waiting jobs, press **OK** to choose a job, and then press **1** to cancel it.
  - Press **2** to exit without canceling.
- 3 When you have finished, press **Stop/Exit**.

## Sending a fax manually

---

### Manual transmission

Manual transmission lets you hear the dialing, ringing and fax-receiving tones while sending a fax.

- 1 Make sure you are in Fax mode .
- 2 Load your document.
- 3 Press **Hook** and listen for a dial tone. Or pick up the handset of the external telephone and listen for a dial tone.
- 4 Dial the fax number you want to call.
- 5 When you hear the fax tone, press **Start**.
  - If you are using the scanner glass, press **1** to send a fax.
- 6 If you picked up the handset of an external telephone, replace it.

## Sending a fax at the end of a conversation

At the end of a conversation you can send a fax to the other party before you both hang up.

- 1 Ask the other party to wait for fax tones (beeps) and then to press the **Start** or **Send** key before hanging up.
- 2 Make sure you are in Fax mode .
- 3 Load your document.
- 4 Press **Start**.
  - If you are using the scanner glass, press **1** to send a fax.
- 5 Replace the handset of an external telephone.

## Out of memory message

---

If you get an `Out of Memory` message while scanning the first page of a fax, press **Stop/Exit** to cancel the fax.

If you get an `Out of Memory` message while scanning a subsequent page, you will have the option to press **Start** to send the pages scanned so far, or to press **Stop/Exit** to cancel the operation.



### Note

---

If you get an `Out of Memory` message while faxing and you do not want to delete your stored faxes to clear the memory, you can send the fax in real time. (See *Real time transmission* on page 36.)

---

## Choose the correct Receive Mode

The correct Receive mode is determined by the external devices and telephone subscriber services (Voice Mail, Distinctive Ring, etc.) you have (or will be using) on the same line as the Brother machine.

### Will you be using a Distinctive Ring number for receiving faxes?

Brother uses the term "Distinctive Ring" but different telephone companies may have other names for this service such as Custom Ringing, RingMaster, Personalized Ring, Teen Ring, Ident-A-Ring, Ident-A-Call, Date Ident-A-Call, Smart Ring and SimpleBiz Fax & Alternate Number Ringing. (See *Distinctive Ring* on page 44 for instructions on setting up your machine using this feature.)

### Will you be using Voice Mail on the same telephone line as your Brother machine?

If you have Voice Mail on the same telephone line as your Brother machine, there is a strong possibility that Voice Mail and the Brother machine will conflict with each other when receiving incoming calls. (See *Voice Mail* on page 44 for instructions on setting up your machine using this service.)

### Will you be using a Telephone Answering Device on the same telephone line as your Brother machine?

Your external telephone answering device (TAD) will automatically answer every call. Voice messages are stored on the external TAD and fax messages are printed. Choose `External TAD` as your receive mode. (See *External TAD* on page 40.)

### Will you be using your Brother machine on a dedicated fax line?

Your machine automatically answers every call as a fax. Choose `Fax Only` as your receive mode. (See *Fax Only* on page 40.)

### Will you be using your Brother machine on the same line as your telephone?

#### Do you want to receive voice calls and faxes automatically?

The `Fax/Tel` receive mode is used when sharing the Brother machine and your telephone on the same line. Choose `Fax/Tel` as your receive mode. (See *Fax/Tel* on page 40.)

**Important Note:** You can not receive voice messages on either Voice Mail or an answering machine when choosing the `Fax/Tel` mode.

#### Do you expect to receive very few faxes?

Choose `Manual` as your receive mode. You control the telephone line and must answer every call yourself. (See *Manual* on page 40.)

To set the receive mode follow the instructions below.

- 1 Press **Menu**, **0**, **1**.
- 2 Press **▲** or **▼** to choose the receive mode.  
Press **OK**.
- 3 Press **Stop/Exit**.

```
Initial Setup
1. Receive Mode
```

The LCD will display the current receive mode.

## Using receive modes

Some receive modes answer automatically (**Fax Only** and **Fax/Tel**). You may want to change the ring delay before using these modes. (See *Ring delay* on page 41.)

### Fax Only

---

**Fax Only** mode will automatically answer every call as a fax.

### Fax/Tel

---

**Fax/Tel** mode helps you automatically manage incoming calls, by recognizing whether they are fax or voice calls and handling them in one of the following ways:

- Faxes will be automatically received.
- Voice calls will start the **F/T** ring to tell you to pick up the line. The **F/T** ring is a fast double ring made by your machine.

(Also see *F/T ring time (Fax/Tel mode only)* on page 41 and *Ring delay* on page 41.)

### Manual

---

**Manual** mode turns off all automatic answering functions unless you are using the **Distinctive Ring Receive** feature.

To receive a fax in **Manual** mode press **Start** when you hear fax tones (short repeating beeps). You can also use the **Easy Receive** feature to receive faxes by lifting a handset on the same line as the machine.

(Also see *Easy receive* on page 42.)

### External TAD

---

**External TAD** mode lets an external answering device manage your incoming calls. Incoming calls will be handled in the following ways:

- Faxes will be automatically received.
- Voice callers can record a message on the external TAD.

(For more information see *Connecting an external TAD (telephone answering device)* on page 47.)

## Receive mode settings

### Ring delay

The ring delay sets the number of times the machine rings before it answers in **Fax Only** and **Fax/Tel** modes.

If you have external or extension telephones on the same line as the machine, keep the Ring Delay setting of 4. (See *Using external and extension telephones* on page 50 and *Easy receive* on page 42.)

1 Make sure you are in Fax mode .

2 Press **Menu, 2, 1, 1**.

```
Setup Receive
1.Ring Delay
```

3 Press **▲** or **▼** to choose 00, 01, 02, 03 or 04 for how many times the line rings before the machine answers. Press **OK**.

4 Press **Stop/Exit**.



#### Note

Choose 00 in 3 to have the machine answer immediately.

### F/T ring time (Fax/Tel mode only)

When somebody calls your machine, you and your caller will hear the normal telephone ring sound. The number of rings is set by the ring delay setting.

If the call is a fax, then your machine will receive it; however, if it is a voice call the machine will sound the F/T ring (a fast double-ring) for the time you have set in the F/T ring time setting. If you hear the F/T ring it means that you have a voice caller on the line.

Because the F/T ring is made by the machine, extension and external telephones will *not* ring; however, you can still answer the call on any telephone. (For more information see *Using remote codes* on page 51.)

1 Make sure you are in Fax mode .

2 Press **Menu, 2, 1, 2**.

```
Setup Receive
2.F/T Ring Time
```

3 Press **▲** or **▼** to choose how long the machine will ring to alert you that you have a voice call (20, 30, 40 or 70 seconds). Press **OK**.

4 Press **Stop/Exit**.

## Easy receive

Turning easy receive **On** allows the machine to receive fax calls automatically if you lift any handset on the same line as the machine.

When you see **Receiving** on the LCD or when you hear 'chirps' through the handset of an extension telephone connected to another telephone wall jack, just replace the handset and your machine will receive the fax.

If this feature is set to **On**, but your machine does not connect a fax call when you lift the handset of an extension or external telephone, press the Fax Receive Code **\*51**. (See *Using external and extension telephones* on page 50.)



### Note

If you use a modem, or send faxes from a computer, on the same line and your machine intercepts them, set easy receive to **Off**.

1 Make sure you are in Fax mode .

2 Press **Menu, 2, 1, 3**.

```
Setup Receive
3.Easy Receive
```

3 Press **▲** or **▼** to choose **On** or **Off**. Press **OK**.

4 Press **Stop/Exit**.

## Setting the print density

You can adjust the print density to make your printed pages darker or lighter.

1 Make sure you are in Fax mode .

2 Press **Menu, 2, 1, 6**.

```
Setup Receive
6.Print Density
```

3 Press **▲** to make the print darker. Or, press **▼** to make the print lighter. Press **OK**.

4 Press **Stop/Exit**.



## Additional receiving operations

### Printing a reduced incoming fax

If you choose **On**, the machine automatically reduces each page of an incoming fax to fit on one page of A4, Letter, Legal or Folio size paper.

The machine calculates the reduction ratio by using the page size of the fax and your Paper Size setting (**Menu, 1, 3**).

- 1 Make sure you are in Fax mode .
  - 2 Press **Menu, 2, 1, 5**.
- ```
Setup Receive
5.Auto Reduction
```
- 3 Press **▲** or **▼** to choose **On** or **Off**. Press **OK**.
  - 4 Press **Stop/Exit**.

### Setting the fax receive stamp

You can set the machine to print the received date and time in the top center of each received fax page.

- 1 Make sure you are in Fax mode .
  - 2 Press **Menu, 2, 1, 8**.
- ```
Setup Receive
8.Fax Rx Stamp
```
- 3 Press **▲** or **▼** to choose **On** or **Off**. Press **OK**.
  - 4 Press **Stop/Exit**.



#### Note

Make sure you have set the current date and time in the machine.

### Receiving a fax at the end of a conversation

At the end of a conversation you can ask the other party to send you a fax before you both hang up.

- 1 Ask the other party to place the document in their machine and to press the **Start** or **Send** key.
- 2 When you hear the CNG tones (slowly repeating beeps), press **Start**.
- 3 Press **2** to receive a fax.
- 4 Replace the external handset.

### Printing a fax from the memory

If you are using the Fax Storage feature (**Menu, 2, 5, 1**), you can still print a fax from the memory when you are at your machine. (See *Fax storage* on page 59.)

- 1 Press **Menu, 2, 5, 3**.
- ```
Remote Fax Opt
3.Print Fax
```
- 2 Press **Start**.
  - 3 Press **Stop/Exit**.

## Telephone line services

### Voice Mail

---

If you have Voice Mail on the same telephone line as your Brother machine, Voice Mail and the Brother machine will conflict with each other when receiving incoming calls.

For example, if your Voice Mail is set to answer after 4 rings and your Brother machine is set to answer after 2 rings, then your Brother machine will answer first. This will prevent callers from being able to leave a message in your Voice Mail.

Similarly, if your Brother machine is set to answer after 4 rings and your Voice Mail is set to answer after 2 rings, then your Voice Mail will answer first. This will prevent your Brother machine from being able to receive an incoming fax, since Voice Mail cannot transfer the incoming fax back to the Brother machine.

To avoid conflicts between your Brother machine and your Voice Mail service, do one of the following:

Get the Distinctive Ring service from your telephone company. Distinctive Ring is a feature of your Brother machine that allows a person with one line to receive fax and voice calls through two different telephone numbers on that one line. Brother uses the term 'Distinctive Ring,' but telephone companies market the service under a variety of names, such as Custom Ringing, Personalized Ring, Smart Ring, RingMaster, Ident-A-Ring, Ident-A-Call, Data Ident-A-Call,

Teen Ring, and SimpleBiz Fax & Alternate Number Ringing. This service establishes a second telephone number on the same line as your existing telephone number, and each number has its own ring pattern. Typically, the original number rings with the standard ring pattern and is used for receiving voice calls, and the second number rings with a different ring pattern and is used for receiving faxes. (See *Distinctive Ring* on page 44.)

### OR

Set your Brother machine's Receive Mode to "Manual". Manual Mode requires that you answer every incoming call if you want to be able to receive a fax. If the incoming call is a telephone call, then complete the call as you normally would. If you hear fax sending tones you must transfer the call to the Brother machine. (See *Using external and extension telephones* on page 50.) Unanswered fax and voice calls will go to your Voice Mail. (To set the machine in **MANUAL** Mode, see *Choose the correct Receive Mode* on page 39.)

### Distinctive Ring

---

Brother uses the term 'Distinctive Ring' but different telephone companies may have other names for this service such as Custom Ringing, Personalized Ring, RingMaster, Smart Ring, Teen Ring, Ident-A-Call, Data Ident-A-Call, Ident-A-Ring, SimpleBiz Fax & Alternate Number Ringing.

## What does your telephone company's 'Distinctive Ring' do?

Your telephone company's Distinctive Ring service allows you to have more than one number on the same telephone line. **If you need more than one telephone number, it is cheaper than paying for an extra line.** Each telephone number has its own distinctive ring pattern, so you will know which telephone number is ringing. This is one way you can have a separate telephone number for your machine.



### Note

Please call your telephone company for availability and rates.

## What does Brother's 'distinctive ring' do?

The Brother machine has a Distinctive Ring feature that allows you to use your machine to take full advantage of the telephone company's Distinctive Ring service. The new telephone number on your line can just receive faxes.



### Note

You must pay for your telephone company's Distinctive Ring service before you program the machine to work with it.

## Do you have Voice Mail?

If you have Voice Mail on the telephone line that you will install your new machine on, *there is a strong possibility that Voice Mail and the machine will conflict with each other while receiving incoming calls.* **However, the Distinctive Ring feature allows you to use more than one number on your line, so both Voice Mail and the machine can work together without any problems.** If each one has a separate telephone number, neither will interfere with the other's operations.

If you decide to get the Distinctive Ring service from the telephone company, you will need to follow the directions below to 'register' the new Distinctive Ring pattern they give you. This is so your machine can recognize its incoming calls.



### Note

You can change or cancel the Distinctive Ring pattern at any time. You can switch it off temporarily, and turn it back on later. When you get a new fax number, make sure you reset this feature.

## Before you choose the ring pattern to register

You can only register one Distinctive Ring pattern with the machine. Some ring patterns cannot be registered. The ring patterns below are supported by your Brother machine. Register the one your telephone company gives you.

| Ring Pattern | Rings                      |  |
|--------------|----------------------------|--|
| 1            | long-long                  |  |
| 2            | short-long-short           |  |
| 3            | short-short-long           |  |
| 4            | very long (normal pattern) |  |



### Note

- Ring Pattern #1 is often called Short-Short and is the most commonly used.
  - If the ring pattern you received is not on this chart, **please call your telephone company and ask for one that is shown.**
- The machine will only answer calls to its registered number.

- The first two rings are silent on the machine. This is because the fax must <<listen>> to the ring pattern (to compare it to the pattern that was 'registered'). (Other telephones on the same line will ring.)
- If you program the machine properly, it will recognize the registered ring pattern of the 'fax number' within 2 ring patterns and then answer with a fax tone. When the 'voice number' is called, the machine will not answer.

### Registering the distinctive ring pattern Very important!

After you have set the Distinctive Ring feature to On, your Distinctive Ring number will receive faxes automatically. The receive mode is automatically set to `Manual` and you cannot change it to another receive mode while Distinctive Ring is set to On. This ensures the Brother machine will only answer the Distinctive Ring number and not interfere when your main telephone number is called.

- 1 Press **Menu, 2, 0, 2.**

```
Miscellaneous
2.Distinctive
```

- 2 Press ▲ or ▼ to choose `Set`.
- 3 Press **OK**.
- 4 Press ▲ or ▼ to choose the prestored ring pattern you want to use. Press **OK**.
- 5 (You will hear each pattern as you scroll through the four patterns. Make sure you choose the pattern that the telephone company gave you.)
- 6 Press **Stop/Exit**. Distinctive Ring is now set to On.

### Turning off distinctive ring

- 1 Press **Menu, 2, 0, 2.**

```
Miscellaneous
2.Distinctive
```

- 2 Press ▲ or ▼ to choose `Off`. Press **OK**.
- 3 Press **Stop/Exit**.



#### Note

If you do not want to receive faxes on your Distinctive Ring number, you can turn off Distinctive Ring. The machine will stay in `Manual` receive mode so you will need to set the Receive Mode again. (See *Choose the correct Receive Mode* on page 39.)

### Caller ID

The Caller ID feature lets you use the Caller ID subscriber service offered by many local telephone companies. Call your telephone company for details. This service shows the telephone number, or name if it is available, of your caller as the line rings.

After a few rings, the LCD will show the telephone number of your caller (and name, if available). Once you answer a call, the Caller ID information disappears from the LCD, but the call information stays stored in the Caller ID memory.

- You will see the first 16 characters of the number (or name).
- The `# Unavailable` message means the call originated outside your Caller ID service area.
- The `Private Call` message means the caller has intentionally blocked transmission of information.

You can print a list of the Caller ID information received by your machine. (See *Printing the Caller ID List* on page 47.)

## Note

- This feature may not be available in certain areas of the USA and Canada.
- Caller ID service varies with different carriers. Call your local telephone company to find out about the kind of service available in your area.

## Viewing the Caller ID List

Your machine stores information for the last thirty calls in the Caller ID list. You can view or print this list. When the thirty-first call comes in to the machine, it replaces information about the first call.

- 1 Press **Menu, 2, 0, 3**.

```
Miscellaneous
3.Caller ID
```

- 2 Press **▲** or **▼** to choose `Display#`. Press **OK**.

The Caller ID of the last call will appear on the display. If no ID is stored, the beeper will sound and `No Caller ID` will appear on the display.

- 3 Press **▲** or **▼** to scroll through the Caller ID memory to choose the Caller ID you want to view, and then press **OK**. The LCD will show the caller's number or name and the date and time of the call.

- 4 To finish viewing, press **Stop/Exit**.

## Printing the Caller ID List

- 1 Press **Menu, 2, 0, 3**.

```
Miscellaneous
3.Caller ID
```

- 2 Press **▲** or **▼** to choose `Print Report`. Press **OK**.

If no ID is stored, the beeper will sound and `No Caller ID` will appear on the LCD.

- 3 Press **Start**.
- 4 After printing has finished, press **Stop/Exit**.

## Connecting an external TAD (telephone answering device)

You can connect an external Telephone Answering Device (TAD) to the same line as your machine. When the TAD answers a call, your machine will “listen” for the CNG (fax calling) tones sent by a sending fax machine. If it hears them it will take over the call and receive the fax. If it does not hear them, it will let your TAD take a voice message and the display will show `Telephone`.

The external TAD must answer within four rings (we recommend you set it to two rings). This is because your machine cannot hear the CNG tones until the external TAD has picked up the call. The sending machine will send CNG tones for only eight to ten seconds longer. We do not recommend using the toll saver feature on your external TAD if it needs more than four rings to activate it.

Unless you are using Distinctive Ring, the TAD must be connected to the EXT. jack of the machine.

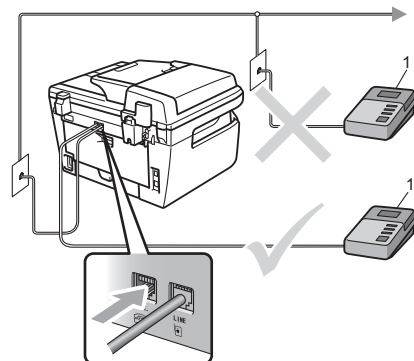

1 TAD

**Note**

If you have problems receiving faxes, reduce the ring delay setting on your external TAD.

## Connections

The external TAD must be plugged into the back of the machine, into the jack labeled EXT. Your machine cannot work properly if you plug the TAD into a wall jack (unless you are using Distinctive Ring).

- 1 Plug the telephone line cord from the telephone wall jack into the back of the machine, in the jack labeled LINE.
- 2 Plug the telephone line cord from your external TAD into the back of the machine, in the jack labeled EXT. (Make sure this cord is connected to the TAD at the TAD's telephone line jack, and not its handset jack.)
- 3 Set your external TAD to four rings or less. (The machine's Ring Delay setting does not apply.)
- 4 Record the outgoing message on your external TAD.
- 5 Set the TAD to answer calls.
- 6 Set the Receive Mode to `External TAD`. (See *Choose the correct Receive Mode* on page 39.)

## Recording an outgoing message (OGM)

- 1 Record 5 seconds of silence at the beginning of your message. This allows your machine time to listen for fax tones.
- 2 Limit your speaking to 20 seconds.
- 3 End your 20-second message by giving your Fax Receive Code for people sending manual faxes. For example: "After the beep, leave a message or send a fax by pressing \*51 and Start."

**Note**

We recommend beginning your OGM with an initial 5 second silence because the machine cannot hear fax tones over a loud voice. You may try leaving out this pause, but if your machine has trouble receiving, then you should re-record the OGM to include it.

## Special line considerations

### Roll over telephone lines

A roll over telephone system is a group of two or more separate telephone lines that pass incoming calls to each other if they are busy. The calls are usually passed down or "rolled over" to the next available telephone line in a preset order.

Your machine can work in a roll over system as long as it is the last number in the sequence, so the call cannot roll away. Do not put the machine on any of the other numbers; when the other lines are busy and a second fax call is received, the fax call would be transferred to a line that does not have a fax machine. **Your machine will work best on a dedicated line.**

## Two-line telephone system

A two-line telephone system is nothing more than two separate telephone numbers on the same wall outlet. The two telephone numbers can be on separate jacks (RJ11) or combined into one jack (RJ14). Your machine must be plugged into an RJ11 jack. RJ11 and RJ14 jacks may be equal in size and appearance and both may contain four wires (black, red, green, yellow). To test the type of jack, plug in a two-line telephone and see if it can access both lines. If it can, you must separate the line for your machine. (See *Easy receive* on page 42.)

## Converting telephone wall outlets

There are three ways to convert to an RJ11 jack. The first two ways may require assistance from the telephone company. You can change the wall outlets from one RJ14 jack to two RJ11 jacks. Or, you can have an RJ11 wall outlet installed and slave or jump one of the telephone numbers to it.

The third way is the easiest: Buy a triplex adapter. You can plug a triplex adapter into an RJ14 outlet. It separates the wires into two separate RJ11 jacks (Line 1, Line 2) and a third RJ14 jack (Lines 1 and 2). If your machine is on Line 1, plug the machine into L1 of the triplex adapter. If your machine is on Line 2, plug it into L2 of the triple adapter.

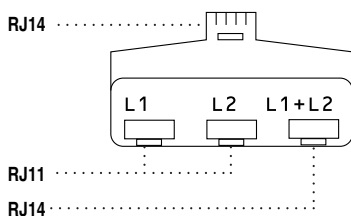

## Installing machine, external two-line TAD and two-line telephone

When you are installing an external two-line telephone answering device (TAD) and a two-line telephone, your machine must be isolated on one line at both the wall jack and at the TAD. The most common connection is to put the machine on Line 2, which is explained in the following steps. The back of the two-line TAD must have two telephone jacks: one labeled L1 or L1/L2, and the other labeled L2. You will need at least three telephone line cords, the one that came with your machine and two for your external two-line TAD. You will need a fourth line cord if you add a two-line telephone.

Place the two-line TAD and the two-line telephone next to your machine.

Plug one end of the telephone line cord for your machine into the L2 jack of the triplex adapter. Plug the other end into the LINE jack on the back of the machine.

Plug one end of the first telephone line cord for your TAD into the L1 jack of the triplex adapter. Plug the other end into the L1 or L1/L2 jack of the two-line TAD.

Plug one end of the second telephone line cord for your TAD into the L2 jack of the two-line TAD. Plug the other end into the EXT. jack on the left side of the machine.

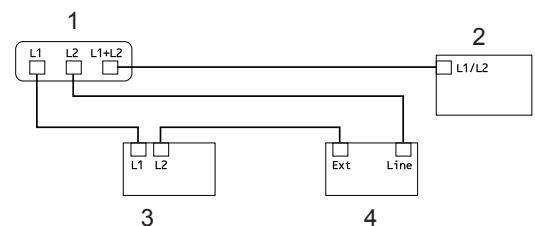

- 1 Triplex Adapter
- 2 Two Line Telephone
- 3 External Two Line TAD
- 4 Machine

You can keep two-line telephones on other wall outlets as always. There are two ways to add a two-line telephone to the machine's wall outlet. You can plug the telephone line cord from the two-line telephone into the L1+L2 jack of the triplex adapter. Or, you can plug the two-line telephone into the TEL jack of the two-line TAD.

## Multi-line connections (PBX)

---

We suggest you ask the company who installed your PBX to connect your machine. If you have a multi line system we suggest you ask the installer to connect the unit to the last line on the system. This prevents the machine being activated each time the system receives telephone calls. If all incoming calls will be answered by a switchboard operator we recommend that you set the Receive Mode to *Manual*.

We cannot guarantee that your machine will operate properly under all circumstances when connected to a PBX. Any difficulties with sending or receiving faxes should be reported first to the company who handles your PBX.

## External and extension telephones

### Using external and extension telephones

---

#### Using extension telephones

If you answer a fax call at an extension telephone, you can make your machine receive the fax by pressing the Fax Receive Code **\*51**. If the machine answers a voice call and pseudo/double-rings for you to take over, you can take the call at an extension telephone by pressing the Telephone Answer Code **#51**. (See *F/T ring time (Fax/Tel mode only)* on page 41.)

#### Using an external telephone (connected to the EXT. jack of the machine.)

If you answer a fax call at the external telephone, you can make the machine receive the fax by pressing **Start**. If the machine answers a voice call and pseudo/double-rings for you to take over, you can take the call at the external telephone by pressing **Hook**.

#### If you answer a call and no one is on the line:

You should assume that you're receiving a manual fax.

Press **\*51** and wait for the chirp or until the machine's LCD shows *Receiving*, and then hang up.



#### Note

---

You can also use the Easy Receive feature to make your machine automatically take the call. (See *Easy receive* on page 42.)

---



## For Fax/Tel mode only

When the machine is in Fax/Tel mode, it will use the F/T Ring Time (pseudo/double-ringing) to alert you to pick up a voice call.

Lift the external telephone's handset, and then press **Hook** to answer.

If you are at an extension telephone, you will need to lift the handset during the F/T Ring Time and then press **#51** between the pseudo/double rings. If no one is on the line, or if someone wants to send you a fax, send the call back to the machine by pressing **\*51**.

## Connecting an external or extension telephone

You can connect a separate telephone directly to your machine as shown in the diagram below.

Connect the telephone line cord to the jack labeled EXT.

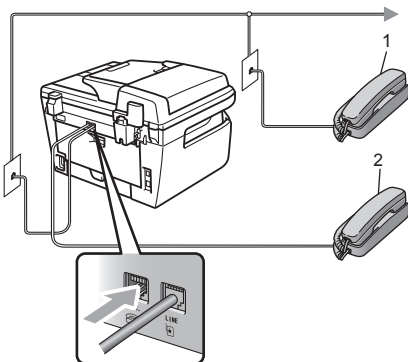

- 1 Extension telephone
- 2 External telephone

When you are using an external telephone, the LCD shows `Telephone`.

## Using a non-Brother cordless external handset

If your non-Brother cordless telephone is connected to the EXT. jack of the machine (see page 51) and you typically carry the cordless handset elsewhere, it is easier to answer calls during the Ring Delay.

If you let the machine answer first, you will have to go to the machine so you can press **Hook** to transfer the call to the cordless handset.

## Using remote codes

### Fax Receive Code

If you answer a fax call on an extension or external telephone, you can tell your machine to receive it by pressing the fax receive code **\*51**. Wait for the chirping sounds then replace the handset. (See *Easy receive* on page 42.)

If you answer a fax call at the external telephone, you can make the machine receive the fax by pressing **Start**.

### Telephone Answer Code

If you receive a voice call and the machine is in F/T mode, it will start to sound the F/T (double-ring) after the initial ring delay. If you pick up the call on an extension telephone you can turn the F/T ring off by pressing **#51** (make sure you press this *between* the rings).

If the machine answers a voice call and pseudo/double-rings for you to take over, you can take the call at the external telephone by pressing **Hook**.

## Changing the remote codes

The preset fax receive code is \*51. The preset telephone answer code is #51. If you are always disconnected when accessing your external TAD, try changing the three-digit remote codes, for example ### and 999.

1 Make sure you are in Fax mode .

2 Press **Menu 2, 1, 4**.

```
Setup Receive
4.Remote Codes
```

3 Press ▲ or ▼ to choose On (or Off).  
Press **OK**.

4 If you chose On in 3, enter the new Fax Receive Code.  
Press **OK**.

5 Enter the new Telephone Answer Code.  
Press **OK**.

6 Press **Stop/Exit**.

## How to dial

You can dial in any of the following ways.

### Manual dialing

Use the dial pad to enter all the digits of the telephone or fax number.



### One touch dialing

Press the One Touch key that stores the number you want to call. (See *Storing one touch dial numbers* on page 54.)

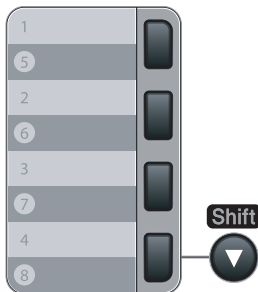

To dial One Touch numbers 5 to 8, hold down **Shift** as you press the One Touch key.

### Speed dialing

Press **Search/Speed Dial**, and then the three digit Speed Dial number. (See *Storing speed dial numbers* on page 55.)



#### Note

If the LCD shows **Not Registered** when you enter a One Touch or a Speed Dial number, it means that a number is not stored there.

## Search

You can search alphabetically for names you have stored in the One Touch and Speed Dial memories. (See *Storing one touch dial numbers* on page 54 and *Storing speed dial numbers* on page 55.)

- 1 Press **Search/Speed Dial**.
- 2 Press **▼**.
- 3 Press the dial pad key for the first few letters of the name. (Use the chart on *Entering text* on page 150 to help you enter letters.)  
Press **OK**.
- 4 Press **▲** or **▼** to scroll until you find the name you are looking for.  
Press **OK**.
- 5 Press **Start**.



### Note

- If you do not enter a letter and press **OK** in 3, all registered names will appear. Press **▲** or **▼** to scroll until you find the name you are looking for.
- If the LCD shows `No Contact Found` when you enter the first few letters of the name, it means that a name for the letter is not stored.

## Fax redial

If you are sending a fax manually and the line is busy, press **Redial/Pause**, wait for the other fax machine to answer, and then press **Start** to try again. If you want to make a second call to the last number dialed, you can save time by pressing **Redial/Pause** and **Start**.

**Redial/Pause** only works if you dialed from the control panel.

If you are sending a fax automatically and the line is busy, the machine will automatically redial one time after five minutes.

## Storing numbers

You can set up your machine to do the following types of easy dialing: One Touch, Speed Dial and Groups for Broadcasting faxes. You can also specify the default resolution for each One Touch and Speed Dial number. When you dial a quick dial number, the LCD shows the name, if you stored it, or the number. A scan profile can also be stored along with the fax number.

If you lose electrical power, the quick dial numbers stored in the memory will not be lost.

A scan profile is the resolution and other scan settings that you choose when you store a number.

## Storing a pause

Press **Redial/Pause** to insert a 3.5-second pause between numbers. You can press **Redial/Pause** as many times as needed to increase the length of the pause.

## Storing one touch dial numbers

Your machine has 4 One Touch keys where you can store 8 fax or telephone numbers for automatic dialing. To access numbers 5 to 8, hold down **Shift** as you press the One Touch key.

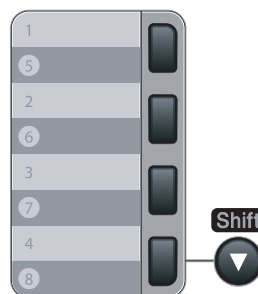

- 1 Press **Menu**, **2**, **3**, **1**.

```
Set Quick Dial
1.One Touch Dial
```

- 2 Press the One Touch key where you want to store a number.
- 3 Enter the number (up to 20 characters). Press **OK**.
- 4 Do one of the following:
  - Enter the name using the dial pad (up to 15 characters). Press **OK**.
  - Press **OK** to store the number without a name.
- 5 (MFC-7440N and MFC-7840W only) Do one of the following:
  - If you want to save a fax resolution along with the number, Press **▲** or **▼** to choose *Std*, *Fine*, *S.Fine* or *Photo*. Press **OK**.
  - Press **OK** if you do not want to change the default resolution.
- 6 Do one of the following:
  - To store another One Touch number go to 2.
  - To finish storing One Touch numbers press **Stop/Exit**.
- 4 Do one of the following:
  - Enter the name using the dial pad (up to 15 characters). Press **OK**.
  - Press **OK** to store the number without a name.
- 5 (MFC-7440N and MFC-7840W only) Do one of the following:
  - If you want to save a fax resolution along with the number, Press **▲** or **▼** to choose *Std*, *Fine*, *S.Fine* or *Photo*. Press **OK**.
  - Press **OK** if you do not want to change the default resolution.
- 6 Do one of the following:
  - To store another Speed Dial number go to 2.
  - To finish storing Speed Dial numbers press **Stop/Exit**.



#### Note

When you do a broadcast and you have saved a scan profile along with the number, the scan profile of the One Touch, Speed Dial or Group number you chose first will be applied to the broadcast.

## Storing speed dial numbers

You can store your frequently used numbers as Speed Dial numbers, so that when you dial you will only have to press a few keys (**Search/Speed Dial**, the three-digit number and **Start**). The machine can store 200 Speed Dial numbers (001 - 200).

- 1 Press **Menu**, **2**, **3**, **2**.
 

Set Quick Dial  
 2.Speed Dial
- 2 Use the dial pad to enter a three-digit Speed Dial location number (001-200). Press **OK**.
- 3 Enter the number (up to 20 characters) Press **OK**

## Changing one touch and speed dial numbers

If you try to store a One Touch or Speed Dial number over an existing number, the LCD will show the name or number already stored there. If your machine has a scheduled job or you have set a fax forwarding number, the LCD will ask you if you want to change the number.

- 1 Do one of the following:
  - To change the stored number, press **1**.

- To exit without making a change, press **2**.

```
#005:MIKE
1.Change 2.Exit
```

- 2 Enter a new number or character. Press **OK**.
- 3 Press ◀ or ▶ to position the cursor under the character you want to change, and then press **Clear/Back** to delete it. Repeat for each character you want to delete.

## Setting up groups for broadcasting

If you often want to send the same fax message to many fax numbers you can set up a group.

Groups are stored on a One Touch key or a Speed Dial number. Each group uses up a One Touch key or a Speed Dial location. You can then send the fax message to all the numbers stored in a group just by pressing a One Touch key or entering a Speed Dial number, and then pressing **Start**.

Before you can add numbers to a group, you need to store them as One Touch or Speed Dial numbers. You can have up to 8 small groups, or you can assign up to 207 numbers to one large group.

- 1 Press **Menu, 2, 3, 3**.

```
Set Quick Dial
3.Setup Groups
```

- 2 Choose an empty location where you want to store the group in one of the following ways:
  - Press a One Touch key.
  - Press **Search/Speed Dial** and then enter the three-digit Speed Dial location. Press **OK**.

- 3 Use the dial pad to enter a group number (01 to 08). Press **OK**.
- 4 To add One Touch or Speed Dial numbers follow the instructions below:
  - For One Touch numbers, press the One Touch keys one after the other.
  - For Speed Dial numbers, press **Search/Speed Dial**, and then enter the three-digit Speed Dial location.

The LCD will display your chosen One Touch numbers with a \* and Speed Dial numbers with a # (for example \*006, #009).

- 5 Press **OK** when you have finished adding numbers.
- 6 Do one of the following:
  - Enter the name using the dial pad (up to 15 characters). Use the chart on *Entering text* on page 150 to help you enter letters. Press **OK**.
  - Press **OK** to store the group without a name.
- 7 (MFC-7440N and MFC-7840W only) Do one of the following:
  - If you want to save a fax resolution along with the number, Press ▲ or ▼ to choose *Std*, *Fine*, *S.Fine* or *Photo*. Press **OK**.
  - Press **OK** if you do not want to change the default resolution.
- 8 Do one of the following:
  - To store another group for broadcasting, press **OK**. Go to 2.
  - To finish storing groups for broadcasting, press **Stop/Exit**.

## Dialing access codes and credit card numbers

---

You can combine more than one Quick Dial number when you dial. This feature may be useful if you need to dial an access code for a cheaper rate from another long distance carrier.

For example, you might have stored '555' on Speed Dial #003 and '7000' on Speed Dial #002. You can use them both to dial '555-7000' if you press the following keys:

Press **Search/Speed Dial, 003**. Press **Search/Speed Dial, 002** and **Start**.

Numbers can be added manually by entering them on the dial pad:

Press **Search/Speed Dial, 003, 7001** (on the dial pad), and **Start**.

This would dial '555-7001'. You can also add a pause by pressing the **Redial/Pause** key.

## Pause

---

Press **Redial/Pause** to insert a 3.5-second pause between numbers. You can press **Redial/Pause** as many times as needed to increase the length of the pause.

## Tone or pulse (Canada only)

---

If you have a Pulse dialing service, but need to send Tone signals (for example, for telephone banking), follow the instructions below. If you have Touch Tone service, you will not need this feature to send tone signals.

- 1 Press **Hook**.
- 2 Press **#** on the machine's control panel. Any digits dialed after this will send tone signals.  
When you hang up, the machine will return to the Pulse dialing service.

# 9

## Remote fax options

Remote fax options let you receive faxes while you are away from the machine.

You can use *only one* remote fax option at a time.

### Fax forwarding

The fax forwarding feature lets you automatically forward your received faxes to another machine.

- 1 Press **Menu**, **2**, **5**, **1**.

```
Remote Fax Opt
1.Fwd/Page/Store
```

- 2 Press **▲** or **▼** to choose **Fax Forward**. Press **OK**.

The LCD will ask you to enter the fax number you want your faxes to be forwarded to.

- 3 Enter the forwarding number using the dial pad (up to 20 digits), using a One Touch key or press **Search/Speed Dial** and the three-digit location.



#### Note

If you store a group on a One Touch key or a Speed Dial location, the faxes will be forwarded to several fax numbers.

Press **OK**.

- 4 Press **▲** or **▼** to choose **On** or **Off**. Press **OK**.

```
Backup Print
On
```

- 5 Press **Stop/Exit**.



#### Note

If you choose Backup Print On, the machine will also print the fax at your machine so you will have a copy. This is a safety feature in case if there is a power failure before the fax is forwarded or a problem at the receiving machine. The MFC-7840W can store faxes for approximately 4 days if there is a power failure. The faxes stored in the MFC-7340, MFC-7345N or MFC-7440N memory will be deleted.



## Paging

When Paging is chosen, your machine dials the pager number you have programmed, and then dials your Personal Identification Number (PIN). This activates your pager so you will know that you have a fax message in the memory.

- 1 Press **Menu, 2, 5, 1**.

```
Remote Fax Opt
1.Fwd/Page/Store
```

- 2 Press **▲** or **▼** to choose **Paging**. Press **OK**.

- 3 Enter your pager telephone number followed by **# #** (up to 20 digits). Press **OK**.  
Do not include the area code if it is the same as that of your machine.  
For example, press  
**1 8 0 0 5 5 1 2 3 4 # #**.

- 4 Do one of the following:
  - If your pager needs a PIN, enter the PIN, press **#**, press **Redial/Pause**, enter your fax number followed by **# #**.  
Press **OK**.  
(For example, press:  
**1 2 3 4 5 # Redial/Pause 1 8 0 0 5 5 5 6 7 8 9 # #**)
  - If you do not need a PIN, press **OK**.

- 5 Press **Stop/Exit**.



### Note

- You cannot change a Paging number or PIN remotely.
- If you have set Paging, a backup copy will automatically be printed at the machine.

## Fax storage

The fax storage feature lets you store your received faxes in the machine's memory. You can retrieve stored fax messages from a fax machine at another location using the remote retrieval commands. (See *Retrieving fax messages* on page 63.) Your machine will automatically print a copy of the stored fax.

- 1 Press **Menu, 2, 5, 1**.

```
Remote Fax Opt
1.Fwd/Page/Store
```

- 2 Press **▲** or **▼** to choose **Fax Storage**. Press **OK**.

- 3 Press **Stop/Exit**.

## PC fax receive

If you turn on the PC Fax Receive feature your machine will store received faxes in memory and send them to your PC automatically. You can then use your PC to view and store these faxes.

Even if you have turned off your PC (at night or on the weekend, for example), your machine will receive and store your faxes in its memory. The LCD will show the number of stored faxes received, for example:

```
PC Fax Msg:001
```

When you start your PC and the PC Fax Receiving software runs, your machine transfers your faxes to your PC automatically.

For PC fax receive to work you must have the PC-FAX Receive software running on your PC. (For details, see *PC-FAX Receiving* in the Software User's Guide on the CD-ROM.)

If you choose Backup Print On, the machine will also print the fax.

- 1 Press **Menu**, **2**, **5**, **1**.

```
Remote Fax Opt
1.Fwd/Page/Store
```

- 2 Press **▲** or **▼** to choose PC Fax Receive.  
Press **OK**.

- 3 Press **▲** or **▼** to choose **<USB>** or your computer name if the machine is connected to a network\* (\* MFC-7345N, MFC-7440N and MFC-7840W only).

```
Select ▲▼ or OK
<USB>
```

Press **OK**.

- 4 Press **▲** or **▼** to choose **On** or **Off**.

```
Backup Print
Off
```

Press **OK**.

- 5 Press **Stop/Exit**.



### Note

- Before you can set up PC Fax Receive you must install the MFL-Pro Suite software on your PC. Make sure your PC is connected and turned on. (For details see *PC-FAX Receiving* in the Software User's Guide on the CD-ROM.)
- If your machine has a problem and is unable to print faxes in memory, you can use this setting to transfer your faxes to a PC. (For details, see *Error and maintenance messages* on page 107.)
- If you choose Backup Print On, the machine will also print the fax at your machine so you will have a copy. This is a safety feature in case if there is a power failure before the fax is forwarded or a problem at the receiving machine. The MFC-7840W can store faxes for approximately 4 days if there is a power failure. The faxes stored in the MFC-7340, MFC-7345N or MFC-7440N memory will be deleted.
- PC Fax Receive is not supported in Mac OS. (See *PC Fax receiving* in the Software User's Guide on the CD-ROM.)

## Changing remote fax options

If received faxes are left in your machine's memory when you change to another remote fax option, the LCD will ask you the following message:

```
Erase All Fax?
1.Yes 2.No
```

or

```
Print All Fax?
1.Yes 2.No
```

- If you press **1**, faxes in the memory will be erased or printed before the setting changes. If a backup copy has already been printed it will not be printed again.
- If you press **2**, faxes in the memory will not be erased or printed and the setting will be unchanged.

If received faxes are left in the machine's memory when you change to PC Fax Receive from another remote fax option (Fax Forward, Paging or Fax Storage), the LCD will ask you the following message:

```
Send Fax to PC?
1.Yes 2.No
```

- If you press **1**, faxes in the memory will be sent to your PC before the setting changes. Faxes in the memory will be sent to your PC when the PC Fax Receive icon is active on your PC. (See *the Software User's Guide on the CD-ROM*.)
- If you press **2**, faxes in the memory will not be erased or transferred to your PC and the setting will be unchanged.

The LCD will ask you the following message:

```
Backup Print
On
```

```
Backup Print
Off
```

Press **▲** or **▼** to choose **On** or **Off**.

Press **OK**.

Press **Stop/Exit**.



### Note

If you choose Backup Print On, the machine will also print the fax at your machine so you will have a copy. This is a safety feature in case if there is a power failure before the fax is forwarded or a problem at the receiving machine. The MFC-7840W can store faxes for approximately 4 days if there is a power failure. The faxes stored in the MFC-7340, MFC-7345N or MFC-7440N memory will be deleted.

## Turning off remote fax options

- 1 Press **Menu**, **2**, **5**, **1**.

```
Remote Fax Opt
1.Fwd/Page/Store
```

- 2 Press **▲** or **▼** to choose **Off**. Press **OK**.



### Note

The LCD will give you options if there are received faxes still in your machine's memory. (See *Changing remote fax options* on page 61.)

- 3 Press **Stop/Exit**.

## Remote retrieval

The remote retrieval feature lets you retrieve your stored fax messages when you are not at the machine. You can call your machine from any touch tone telephone or fax machine, then use the Remote Access Code to retrieve your messages.

### Setting a remote access code

The remote access code lets you access the remote retrieval features when you are away from your machine. Before you use the remote access and retrieval features, you have to set up your own code. The default code is an inactive code: --\*.

- 1 Press **Menu**, **2**, **5**, **2**.

```
Remote Fax Opt
2.Remote Access
```

- 2 Enter a three-digit code using the numbers **0 – 9**, **\*** or **#**. Press **OK**.
- 3 Press **Stop/Exit**.



#### Note

Do not use the same code used for your Fax Receive Code (**\*51**) or Telephone Answer Code (**#51**). (See *Changing the remote codes* on page 52.)

You can change your code at any time. If you want to make your code inactive, press **Clear/Back** and then **OK** in ② to restore the inactive setting --\*.

## Using your remote access code

- 1 Dial your fax number from a telephone or another fax machine using touch tone.
- 2 When your machine answers, immediately enter your Remote Access Code (3 digits followed by \*).
- 3 The machine signals if it has received messages:
  - *No beeps*  
No messages received.
  - *1 long beep*  
Fax message received.
- 4 The machine gives two short beeps to tell you to enter a command (See *Remote fax commands* on page 64). The machine will hang up if you wait longer than 30 seconds before entering a command. If you enter an invalid command the machine will beep three times.
- 5 Press **9 0** to reset the machine when you have finished.
- 6 Hang up.



#### Note

If your machine is set to **Manual** mode, you can still access the remote retrieval features. Dial the fax number as normal and let the machine ring. After 2 minutes you will hear a long beep to tell you to enter the remote access code. You will then have 30 seconds to enter the code.

## Retrieving fax messages

---

- 1 Dial your fax number from a telephone or another fax machine using touch tone.
- 2 When your machine answers, immediately enter your remote access code (3 digits followed by \*). If you hear one long beep, you have messages.
- 3 When you hear two short beeps, use the dial pad to press **9 6 2**.
- 4 Wait for a long beep, and then use the dial pad to enter the number of the remote fax machine where you want your fax messages sent to, followed by **##** (up to 20 digits).
- 5 Hang up after you hear your machine beep. Your machine will call the other machine, which will then print your fax messages.



### Note

---

You can insert a pause in a fax number by using the # key.

---

## Changing the fax forwarding number

---

You can change the default setting of your fax forwarding number from another telephone or fax machine using touch tone.

- 1 Dial your fax number from a telephone or another fax machine using touch tone.
- 2 When your machine answers, enter your remote access code (3 digits followed by \*). If you hear one long beep, you have messages.
- 3 When you hear two short beeps, use the dial pad to press **9 5 4**.
- 4 Wait for a long beep, and then use the dial pad to enter the new number of the remote fax machine where you want your fax messages forwarded followed by **##** (up to 20 digits).
- 5 Press **9 0** to reset the machine when you have finished.
- 6 Hang up after you hear your machine beep.



### Note

---

You can insert a pause in a fax number by using the # key.

---

## Remote fax commands

Follow the commands below to access features when you are away from the machine. When you call the machine and enter your Remote Access Code (3 digits followed by \*), the system will give two short beeps and you must enter a remote command.

| Remote commands |                                                                  | Operation details                                                                                                                                                                                                                                                                                                                                                                                           |
|-----------------|------------------------------------------------------------------|-------------------------------------------------------------------------------------------------------------------------------------------------------------------------------------------------------------------------------------------------------------------------------------------------------------------------------------------------------------------------------------------------------------|
| 95              | <b>Change the fax forwarding, paging or fax storage settings</b> |                                                                                                                                                                                                                                                                                                                                                                                                             |
|                 | 1 OFF                                                            | You can choose OFF after you have retrieved or erased all your messages.                                                                                                                                                                                                                                                                                                                                    |
|                 | 2 Fax forwarding                                                 | One long beep means the change is accepted. If you hear three short beeps, you cannot make the change because something has not been set up (for example, a fax forwarding or paging number has not been registered). You can register your fax forwarding number by entering 4. (See <i>Changing the fax forwarding number</i> on page 63.) Once you have registered the number, fax forwarding will work. |
|                 | 3 Paging                                                         |                                                                                                                                                                                                                                                                                                                                                                                                             |
|                 | 4 Fax forwarding number                                          |                                                                                                                                                                                                                                                                                                                                                                                                             |
|                 | 6 Fax storage                                                    |                                                                                                                                                                                                                                                                                                                                                                                                             |
| 96              | <b>Retrieve a fax</b>                                            |                                                                                                                                                                                                                                                                                                                                                                                                             |
|                 | 2 Retrieve all faxes                                             | Enter the number of a remote fax machine to receive stored fax messages. (See <i>Retrieving fax messages</i> on page 63.)                                                                                                                                                                                                                                                                                   |
|                 | 3 Erase faxes from the memory                                    | If you hear one long beep, fax messages have been erased from the memory.                                                                                                                                                                                                                                                                                                                                   |
| 97              | <b>Check the receiving status</b>                                |                                                                                                                                                                                                                                                                                                                                                                                                             |
|                 | 1 Fax                                                            | You can check whether your machine has received any faxes. If yes, you will hear one long beep. If no, you will hear three short beeps.                                                                                                                                                                                                                                                                     |
| 98              | <b>Change the receive mode</b>                                   |                                                                                                                                                                                                                                                                                                                                                                                                             |
|                 | 1 External TAD                                                   | If you hear one long beep, your change has been accepted.                                                                                                                                                                                                                                                                                                                                                   |
|                 | 2 Fax/Tel                                                        |                                                                                                                                                                                                                                                                                                                                                                                                             |
|                 | 3 Fax Only                                                       |                                                                                                                                                                                                                                                                                                                                                                                                             |
| 90              | <b>Exit</b>                                                      | Press <b>9 0</b> to exit remote retrieval. Wait for the long beep, then replace the handset.                                                                                                                                                                                                                                                                                                                |

# 10 Polling

Polling lets you set up your machine so other people can receive faxes from you, but they pay for the call. It also lets you call somebody else's fax machine and receive a fax from it, so you pay for the call. The polling feature needs to be set up on both machines for this to work. Not all fax machines support polling.

To cancel all sequential polling receive jobs, press **Menu, 2, 7**. (See *Checking and canceling waiting jobs* on page 38.)

## Polling receive

Polling receive lets you call another fax machine to receive a fax.

1 Make sure you are in Fax mode .

2 Press **Menu, 2, 1, 7**.

```
Setup Receive
7.Polling RX
```

3 Enter the fax number you are polling.  
Press **Start**.  
The LCD will show *Dialing*.

## Sequential polling

Sequential polling lets you request documents from several fax machines in one operation. Afterwards, a Sequential Polling Report will be printed.

1 Make sure you are in Fax mode .

2 Press **Menu, 2, 1, 7**.

3 Specify the fax machines you want to poll by using One Touch, Speed Dial, Search, a Group or the dial pad. You must press **OK** between each location.

4 Press **Start**.  
The machine polls each number or Group number in turn for a document.

Press **Stop/Exit** while the machine is dialing to cancel the polling process.

## Polled transmit

Polled transmit lets you set up your machine to wait with a document so another fax machine can call and retrieve it.

### Setup for polled transmit

1 Make sure you are in Fax mode .

2 Load your document.

3 Press **Menu, 2, 2, 6**.

```
Setup Send
6.Polled TX
```

4 Press **▲** or **▼** to choose On (or Off).  
Press **OK**.

5 Press **2** to choose 2.No if you do not want to enter more settings when the LCD asks you the following message:

```
Other Settings
1.Yes 2.No
```

6 Press **Start**.

7 If you are using the scanner glass, the LCD will prompt you to choose one of the options below:

```
Next Page?
1.Yes 2.No(send)
```

■ Press **1** to send another page.

Go to 8.

■ Press **2** or **Start** to send the document.

8 Place the next page on the scanner glass, press **OK**. Repeat 7 and 8 for each additional page.

Your machine will automatically send the fax.



### Note

The document will be stored and can be retrieved from any other fax machine until you delete the fax from memory.

To delete the fax from memory, press **Menu, 2, 7**. (See *Checking and canceling waiting jobs* on page 38.)



## Fax reports

Some fax reports (transmission verification and fax journal) can be printed automatically and manually.

### Transmission verification report

You can use the transmission report as proof that you sent a fax. This report lists the time and date of transmission and whether the transmission was successful (shown as "OK"). If you choose **On** or **On+Image**, the report will print for every fax you send.

If you send a lot of faxes to the same place, you may need more than the job numbers to know which faxes you must send again. Choosing **On+Image** or **Off+Image** will print a section of the fax's first page on the report to help you remember.

When the verification report is turned **Off** or to **Off+Image**, the report will *only* print if there is a transmission error and the fax was not sent.



#### Note

If you choose **On+Image**, or **Off+Image**, the image will only appear on the Transmission Verification Report if Real Time Transmission is set to **Off**. (See *Real time transmission* on page 36.)

- 1 Press **Menu, 2, 4, 1**.

```
Report Setting
1.Transmission
```

- 2 Press **▲** or **▼** to choose **On**, **On+Image**, **Off** or **Off+Image**. Press **OK**.

- 3 Press **Stop/Exit**.

## Fax journal

You can set the machine to print a fax journal (activity report) at specific intervals (every 50 faxes, 6, 12 or 24 hours, 2 or 7 days). The default setting is **Every 50 Faxes**, this means that your machine will print the journal when the machine has stored 50 jobs.

If you set the interval to **Off**, you can still print the report by following the steps on the next page.

- 1 Press **Menu, 2, 4, 2**.

```
Report Setting
2.Journal Period
```

- 2 Press **▲** or **▼** to choose an interval. Press **OK**.

If you choose 7 days, you will be asked to choose a day when you want the 7 day countdown to begin.

- 3 Enter the time to begin printing, in 24 hour format.

Press **OK**.

For example: enter 19:45 for 7:45 PM.

- 4 Press **Stop/Exit**.

If you choose 6, 12, 24 hours, 2 or 7 days, the machine will print the report at the selected time and then erase all jobs from its memory. If the machine's memory becomes full with 200 jobs before the time you chose has passed, the machine will print the journal early and then erase all jobs from memory.

If you want an extra report before it is due to print, you can print it manually without erasing the jobs from memory.

# Reports

The following reports are available:

- 1 **Transmission**  
Displays the Transmission Verification Report for your last outgoing 200 faxes and prints the last report.
- 2 **Help List**  
Prints a list of commonly used functions to help you program your machine.
- 3 **Tel Index List**  
Prints a list of names and numbers stored in the One Touch and Speed Dial memory in numerical or alphabetical order.
- 4 **Fax Journal**  
Prints a list of information about your last 200 incoming and outgoing faxes. (TX: transmit.) (RX: receive.)
- 5 **User Settings**  
Print a list of your current settings.
- 6 **Network Config (MFC-7345N, MFC-7440N and MFC-7840W only)**  
Lists your network settings.

## How to print a report

---

- 1 Press **Reports**.
- 2 Do one of the following:
  - Press **▲** or **▼** to choose the report you want.  
Press **OK**.
  - Enter the number of the report you want to print. For example, press **2** to print the help list.
- 3 Press **Stop/Exit**.



# Copy

---

**Making copies**

70

# 12

## Making copies

### How to copy

#### Entering copy mode

Press  (**Copy**) to enter Copy mode.

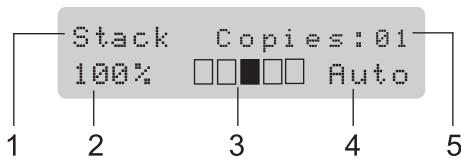

- 1 **Stack/Sort**
- 2 **Copy ratio and copy layout**
- 3 **Contrast**
- 4 **Quality**
- 5 **Number of copies**

#### Making a single copy

- 1 Make sure you are in Copy mode .
- 2 Load your document.
- 3 Press **Start**.

#### Making multiple copies

- 1 Make sure you are in Copy mode .
- 2 Load your document.
- 3 Use the dial pad to enter the number of copies (up to 99).
- 4 Press **Start**.



#### Note

To sort your copies, see *Sorting copies using the ADF* on page 73.

#### Stop copying

To stop copying, press **Stop/Exit**.

# Copy options (temporary settings)

When you want to quickly change the copy settings temporarily for the next copy, use the temporary **Copy** keys. You can use different combinations.



The machine returns to its default settings one minute after copying, unless you have set the Mode Timer to 30 seconds or less. (See *Mode timer* on page 20.)

## Enlarging or reducing the image copied

You can choose the following enlargement or reduction ratios:

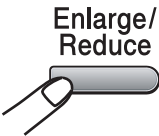
|                                                                                                  |                  |
|--------------------------------------------------------------------------------------------------|------------------|
| Press<br><br> | <b>100%*</b>     |
|                                                                                                  | 97% LTR→A4       |
|                                                                                                  | 94% A4→LTR       |
|                                                                                                  | 91% Full Page    |
|                                                                                                  | 85% LTR→EXE      |
|                                                                                                  | 83% LGL→A4       |
|                                                                                                  | 78% LGL→LTR      |
|                                                                                                  | 70% A4→A5        |
|                                                                                                  | 50%              |
|                                                                                                  | Custom (25-400%) |
|                                                                                                  | Auto             |
|                                                                                                  | 200%             |
|                                                                                                  | 141% A5→A4       |
|                                                                                                  | 104% EXE→LTR     |

\* The factory setting is shown in Bold with an asterisk.

**Auto** sets the machine to calculate the reduction ratio that best fits the size of paper. **Auto** is only available when using the ADF.

**Custom (25-400%)** allows you to enter a ratio from 25% to 400%.

To enlarge or reduce the next copy follow the instructions below:

- 1 Make sure you are in Copy mode .
- 2 Load your document.
- 3 Use the dial pad to enter the number of copies (up to 99).
- 4 Press **Enlarge/Reduce**.
- 5 Do one of the following:
  - Press **▲** or **▼** to choose the enlargement or reduction ratio you want.  
Press **OK**.
  - Press **▲** or **▼** to choose Custom (25-400%).  
Press **OK**.

Use the dial pad to enter an enlargement or reduction ratio from 25% to 400%. (For example, press **5 3** to enter 53%.)  
Press **OK**.
- 6 Press **Start**.





### Note

Page Layout Options 2 in 1(P), 2 in 1(L), 4 in 1(P) or 4 in 1(L) are *not* available with Enlarge/Reduce.

## Using the Options key

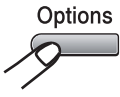
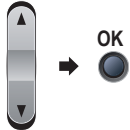
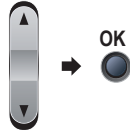
Use the **Options** key to quickly set the following copy settings temporarily for the next copy.

| Press                                                                                      | Menu selections                                                                                                         | Options                                                                                                                 | Page |
|--------------------------------------------------------------------------------------------|-------------------------------------------------------------------------------------------------------------------------|-------------------------------------------------------------------------------------------------------------------------|------|
| Press<br> | Press ▲ or ▼, then press <b>OK</b><br> | Press ▲ or ▼, then press <b>OK</b><br> |      |
|                                                                                            | Quality                                                                                                                 | <b>Auto*</b><br>Text<br>Photo                                                                                           | 73   |
|                                                                                            | Stack/Sort<br>(appears when the document is in the ADF)                                                                 | <b>Stack*</b><br>Sort                                                                                                   | 73   |
|                                                                                            | Contrast                                                                                                                | ▼-□□□■+▲<br>▼-□□□■+▲<br>▼-□□■□+▲*<br>▼-□■□□+▲<br>▼-■□□□+▲                                                               | 74   |
|                                                                                            | Page Layout                                                                                                             | <b>Off (1 in 1)*</b><br>2 in 1 (P)<br>2 in 1 (L)<br>4 in 1 (P)<br>4 in 1 (L)                                            | 74   |

 The factory settings are shown in Bold with an asterisk.

## Improving copy quality

You can choose from a range of quality settings. The default setting is `Auto`.

### ■ Auto

Auto is the recommended mode for ordinary printouts. Suitable for documents that contain both text and photographs.

### ■ Text

Suitable for documents containing only text.

### ■ Photo

Suitable for copying photographs.

To *temporarily* change the quality setting, follow the steps below:

- 1 Make sure you are in Copy mode .
- 2 Load your document.
- 3 Use the dial pad to enter the number of copies (up to 99).
- 4 Press **Options**.  
Press **▲** or **▼** to choose `Quality`.  
Press **OK**.
- 5 Press **▲** or **▼** to choose `Auto`, `Text` or `Photo`.  
Press **OK**.
- 6 Press **Start**.

To change the *default* setting, follow the steps below:

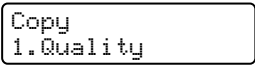
- 1 Press **Menu, 3, 1**.  

- 2 Press **▲** or **▼** to choose the copy quality.  
Press **OK**.
- 3 Press **Stop/Exit**.

## Sorting copies using the ADF

You can sort multiple copies. Pages will be stacked in the order 1 2 3, 1 2 3, 1 2 3, and so on.

- 1 Make sure you are in Copy mode .
- 2 Load your document in the ADF.
- 3 Use the dial pad to enter the number of copies (up to 99).
- 4 Press **Options** and **▲** or **▼** to choose `Stack/Sort`.  
Press **OK**.
- 5 Press **▲** or **▼** to choose `Sort`.  
Press **OK**.
- 6 Press **Start**.

## Adjusting contrast

### Contrast

Adjust the contrast to help an image look sharper and more vivid.

To *temporarily* change the contrast setting, follow the steps below:

- 1 Make sure you are in Copy mode .
- 2 Load your document.
- 3 Use the dial pad to enter the number of copies (up to 99).
- 4 Press **Options**.  
Press **▲** or **▼** to choose **Contrast**.  
Press **OK**.
- 5 Press **▲** or **▼** to increase or decrease the contrast.  
Press **OK**.
- 6 Press **Start**.

To change the *default* setting follow the steps below:

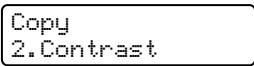
- 1 Press **Menu, 3, 2**.  

- 2 Press **▲** or **▼** to increase or decrease the contrast.  
Press **OK**.
- 3 Press **Stop/Exit**.

## Making N in 1 copies (page layout)

You can reduce the amount of paper used when copying by using the N in 1 copy feature. This allows you to copy two or four pages onto one page, which lets you save paper.

### Important

- Please make sure the paper size is set to Letter, A4, Legal or Folio.
- (P) means Portrait and (L) means Landscape.
- You cannot use the Enlarge/Reduce setting with the N in 1 feature.

- 1 Make sure you are in Copy mode .
- 2 Load your document.
- 3 Use the dial pad to enter the number of copies (up to 99).
- 4 Press **Options**.
- 5 Press **▲** or **▼** to choose **Page Layout**.  
Press **OK**.
- 6 Press **▲** or **▼** to choose 2 in 1 (P), 2 in 1 (L), 4 in 1 (P), 4 in 1 (L) or Off (1 in 1).  
Press **OK**.
- 7 Press **Start** to scan the page.  
If you placed the document in the ADF, the machine scans the pages and starts printing.  
**If you are using the scanner glass, go to 8.**
- 8 After the machine scans the page, press **1** to scan the next page.

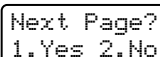



- 9 Place the next page on the scanner glass. Press **OK**. Repeat 8 and 9 for each page of the layout.

- 10 After all the pages have been scanned, press 2 in 8 to finish.

**If you are copying from the ADF:**

Insert your document face up in the direction shown below:

■ 2 in 1 (P)



■ 2 in 1 (L)



■ 4 in 1 (P)



■ 4 in 1 (L)



**If you are copying from the scanner glass:**

Insert your document face down in the direction shown below:

■ 2 in 1 (P)

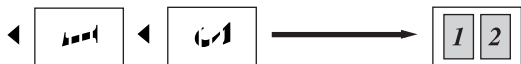

■ 2 in 1 (L)

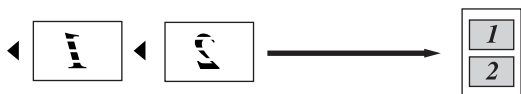

■ 4 in 1 (P)



■ 4 in 1 (L)

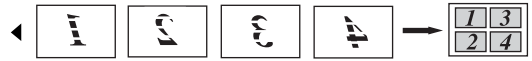

## Out of memory message

If the memory becomes full while you are making copies, the LCD message will guide you through the next step.

If you get an *Out of Memory* message while scanning a subsequent page, you will have the option to press **Start** to copy the pages scanned so far, or to press **Stop/Exit** to cancel the operation.

To gain extra memory, you can do the following:

- Print the faxes that are in the memory. (See *Printing a fax from the memory* on page 43.)
- You can turn off Fax Storage. (See *Turning off remote fax options* on page 61.)



**Note**

When you get an *Out of Memory* message, you may be able to make copies if you first print incoming faxes in the memory to restore the memory to 100%.





# Software

---

Software and Network features

78

# 13

## Software and Network features

The User's Guide on the CD-ROM includes the **Software User's Guide** and **Network User's Guide** (MFC-7345N, MFC-7440N and MFC-7840W only) for features available when connected to a computer (for example, printing and scanning). These guides have easy to use links that, when clicked, will take you directly to a particular section.

You can find information on these features:

- Printing
- Scanning
- ControlCenter3 (for Windows®)
- ControlCenter2 (for Macintosh®)
- Remote Setup
- Faxing from your computer
- Network Faxing (MFC-7345N, MFC-7440N and MFC-7840W only)
- Network Printing (MFC-7345N, MFC-7440N and MFC-7840W only)
- Network Scanning (MFC-7345N, MFC-7440N and MFC-7840W only)
- Internet Fax (I-Fax) / Scan to E-mail Server (MFC-7440N and MFC-7840W available as download)
- Wireless Network Users (MFC-7840W only)



### Note

See *Accessing the Software User's Guide and Network User's Guide* on page 2.

## How to read HTML User's Guide

This is a quick reference for using the HTML User's Guide.

### For Windows®



### Note

If you have not installed the software, see *Chapter 1*.

- 1 From the **Start** menu, point to **Brother, MFC-XXXX** from the programs group, then click **User's Guides in HTML format**.
- 2 Click on the manual you want (**SOFTWARE USER'S GUIDE** or **NETWORK USER'S GUIDE** (MFC-7345N, MFC-7440N and MFC-7840W only)) from the top menu.

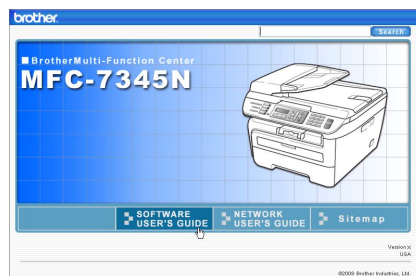

- 3 Click the heading you would like to view from the list at the left of the window.

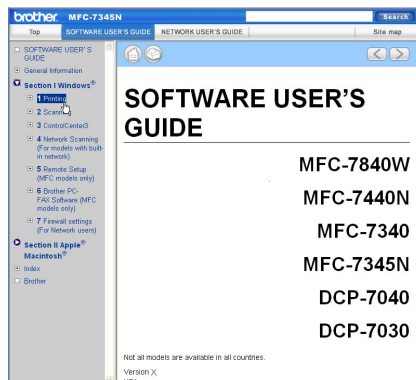

## For Macintosh®

- 1 Make sure your Macintosh® is turned on. Insert the Brother CD-ROM into your CD-ROM drive.
- 2 Double-click the **Documentation** icon.
- 3 Double-click your language folder, and then double-click the top page file.
- 4 Click on the manual you want (**SOFTWARE USER'S GUIDE** or **NETWORK USER'S GUIDE** (MFC-7345N, MFC-7440N and MFC-7840W only) ) in the top menu, and then click the heading you would like to read from the list at the left of the window.

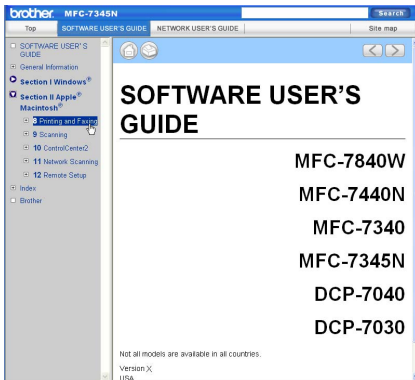





# Appendixes

---

|                                                |     |
|------------------------------------------------|-----|
| <b>Safety and legal</b>                        | 82  |
| <b>Troubleshooting and routine maintenance</b> | 93  |
| <b>Menu and features</b>                       | 135 |
| <b>Specifications</b>                          | 152 |
| <b>Glossary</b>                                | 168 |

# A

## Safety and legal

### Choosing a location

Place your machine on a flat, stable surface that is free of vibration and shocks. Put the machine near a telephone wall jack and a standard, grounded AC power outlet. Choose a location where the temperature remains between 50° F and 90.5° F (10° C and 32.5° C) and the humidity is between 20% to 80% (without condensation).

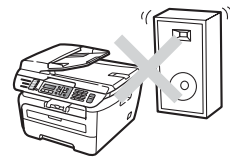
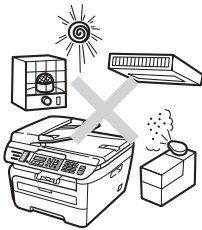

#### ! CAUTION

Avoid placing your machine in a high-traffic area.

---

DO NOT place the machine near heaters, air conditioners, refrigerators, water, chemicals or devices that contain magnets or generate magnetic fields.

---

DO NOT expose the machine to direct sunlight, excessive heat, open flames, salty or corrosive gasses, moisture, or dust.

---

DO NOT connect your machine to an AC power outlet controlled by wall switches or automatic timers.

---

Disruption of power can wipe out information in the machine's memory.

---

DO NOT connect your machine to an AC power outlet on the same circuit as large appliances or other equipment that might disrupt the power supply.

---

Avoid interference sources, such as speakers or the base units of non-Brother cordless telephones.

---

DO NOT put objects on top of the machine.

---



## To use the machine safely

Please keep these instructions for later reference and read them before attempting any maintenance. If you do not follow these safety instructions, there is a possibility of a fire, electrical shock, burn or suffocation.



### WARNING



There are high voltage electrodes inside the machine. Before you clean the inside of the machine, make sure you have unplugged the telephone line cord first and then the power cord from the AC power outlet (See *Routine maintenance* on page 118.)

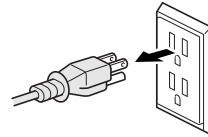

DO NOT use flammable substances, any type of spray, or an organic solvent/liquid that contains alcohol or ammonia to clean the inside or outside of the machine. Refer to *Routine maintenance* on page 118 for how to clean the machine.



DO NOT handle the plug with wet hands. Doing this might cause an electrical shock.

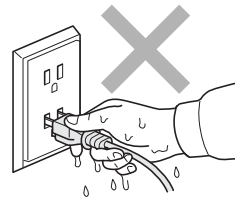

Always make sure the plug is fully inserted.



After you have just used the machine, some internal parts of the machine will be extremely hot. When you open the front or back cover of the machine, DO NOT touch the shaded parts shown in the illustration.

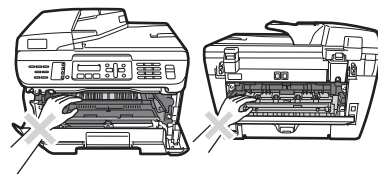



To prevent injuries, be careful not to put your hands on the edge of the machine under the document cover or scanner cover as shown in the illustrations.

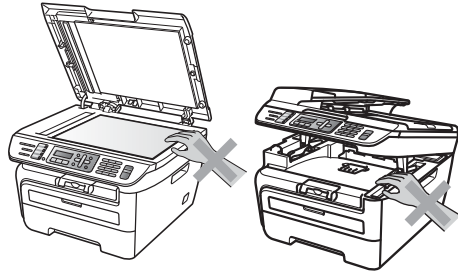

To prevent injuries, be careful not to put your fingers in the areas shown in the illustrations.

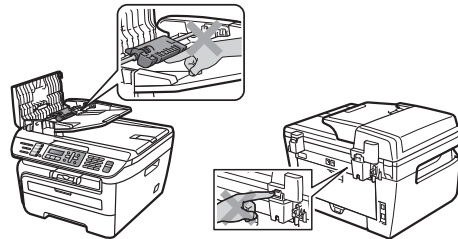

DO NOT use a vacuum cleaner to clean up scattered toner. Doing this might cause the toner dust to ignite inside the vacuum cleaner, potentially starting a fire. Please carefully clean the toner dust with a dry, lint-free cloth and dispose of it according to local regulations.



When you move the machine, grasp the side hand holds that are under the scanner.



Use caution when installing or modifying telephone lines. Never touch telephone wires or terminals that are not insulated unless the telephone line has been unplugged at the wall jack. Never install telephone wiring during a lightning storm. Never install a telephone wall jack in a wet location.



This product must be installed near an AC power outlet that is easily accessible. In case of an emergency, you must disconnect the power cord from the AC power outlet to shut off the power completely.



Plastic bags are used in the packaging of your machine and drum unit. To avoid the danger of suffocation, keep these bags away from babies and children.



To reduce the risk of shock or fire, use only a No. 26 AWG or larger telecommunication line cord.

**! CAUTION**

Lightning and power surges can damage this product! We recommend that you use a quality surge protection device on the AC power line and on the telephone line, or unplug the cords during a lightning storm.

**Note**

The fuser unit is marked with a Caution label. Please DO NOT remove or damage the label.

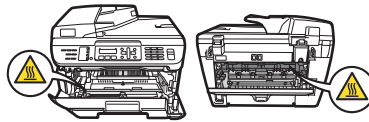
**! WARNING****IMPORTANT SAFETY INSTRUCTIONS**

When using your telephone equipment, basic safety precautions should always be followed to reduce the risk of fire, electric shock and injury to people, including the following:

- 1 DO NOT use this product near water, for example, near a bath tub, wash bowl, kitchen sink, washing machine, or in a wet basement or near a swimming pool.
- 2 Avoid using this product during an electrical storm. There may be a remote risk of electric shock from lightning.
- 3 DO NOT use this product to report a gas leak in the vicinity of the leak.
- 4 Use only the power cord provided with the machine.
- 5 DO NOT dispose of batteries in a fire. They may explode. Check with local codes for possible special disposal instructions.

SAVE THESE INSTRUCTIONS

# Important information

## Standard telephone and FCC notices

---

**These notices are in effect on models sold and used in the United States only.**

**When programming emergency numbers or making test calls to emergency numbers:**

- Remain on the line and briefly explain to the dispatcher the reason for the call before hanging up.
- Perform these activities in the off-peak hours, such as early morning or late evening.

This equipment complies with Part 68 of the FCC rules and the requirements adopted by the ACTA. On the backside of this equipment is a label that contains, among other information, a product identifier in the format US: AAAEQ##TXXXX. If requested, this number must be provided to the telephone company.

You may safely connect this equipment to the telephone line by means of a standard modular jack, USOC RJ11C.

A plug and jack used to connect this equipment to the premises wiring and telephone network must comply with the applicable FCC Part 68 rules and requirements adopted by the ACTA. A compliant telephone cord and modular plug is provided with this product. It is designed to be connected to a compatible modular jack that is also compliant. (See installation instructions for details.)

The REN is used to determine the number of devices that may be connected to a telephone line. Excessive RENs on a telephone line may result in the devices not ringing in response to an incoming call. In most but not all areas, the sum of RENs should not exceed five (5.0). To be certain of the number of devices that may be connected to a line, as determined by the total RENs, contact the local telephone company. For products approved after July 23, 2001, the REN for this product is part of the product identifier that has the format US:AAAEQ##TXXXX. The digits represented by ## are the REN without a decimal point (e.g., 06 is a REN of 0.6). For earlier products, the REN is separately shown on the label.

If this equipment causes harm to the telephone network, the telephone company will notify you in advance that temporary discontinuance of service may be required. But if advance notice is not practical, the telephone company will notify the customer as soon as possible. Also, you will be advised of your right to file a complaint with the FCC if you believe it is necessary.

The telephone company may make changes in its facilities, equipment, operations or procedures that could affect the operation of the equipment. If this happens the telephone company will provide advance notice in order for you to make necessary modifications to maintain uninterrupted service.

If trouble is experienced with this equipment, for repair or warranty information, please contact Brother Customer Service. (See *Brother numbers* on page i.) If the equipment is causing harm to the telephone network, the telephone company may request that you disconnect the equipment until the problem is resolved.

Connection to party line service is subject to state tariffs. Contact the state public utility commission, public service commission or corporation commission for information.

If your home has specially wired alarm equipment connected to the telephone line, ensure the installation of this equipment does not disable your alarm equipment. If you have questions about what will disable alarm equipment, call your telephone company or a qualified installer.

If you are not able to solve a problem with your machine, call Brother Customer Service. (See *Brother numbers* on page i.)



## WARNING

For protection against the risk of electrical shock, always disconnect all cables from the wall outlet before servicing, modifying or installing the equipment.

This equipment may not be used on coin service lines provided by the telephone company or connected to party lines.

Brother cannot accept any financial or other responsibilities that may be the result of your use of this information, including direct, special or consequential damages. There are no warranties extended or granted by this document.

This machine has been certified to comply with FCC standards, which are applied to the USA only. A grounded plug should be plugged into a grounded AC power outlet after checking the rating of the local power supply for the machine to operate properly and safely.

## Federal Communications Commission (FCC) Declaration of Conformity (USA only)

Responsible Party:                    Brother International Corporation  
                                                  100 Somerset Corporate Boulevard  
                                                  Bridgewater, NJ 08807-0911 USA  
                                                  TEL: (908) 704-1700

declares, that the products

Product Name: MFC-7340, MFC-7345N, MFC-7440N and MFC-7840W

comply with Part 15 of the FCC Rules. Operation is subject to the following two conditions: (1) This device may not cause harmful interference, and (2) this device must accept any interference received, including interference that may cause undesired operation.

This equipment has been tested and found to comply with the limits for a Class B digital device, pursuant to Part 15 of the FCC Rules. These limits are designed to provide reasonable protection against harmful interference in a residential installation. This equipment generates, uses, and can radiate radio frequency

and, if not installed and used in accordance with the instructions, may cause harmful interference to radio communications. However, there is no guarantee that interference will not occur in a particular installation. If this equipment does cause harmful interference to radio or television reception, which can be determined by turning the equipment off and on, the user is encouraged to try to correct the interference by one or more of the following measures:

- Reorient or relocate the receiving antenna.
- Increase the separation between the equipment and receiver.
- Connect the equipment into an outlet on a circuit different from that to which the receiver is connected.
- Call the dealer or an experienced radio/TV technician for help.
- This transmitter must not be co-located or operated in conjunction with any other antenna or transmitter.

### **Important**

Changes or modifications not expressly approved by Brother Industries, Ltd. could void the user's authority to operate the equipment.

### **Important—about the interface cable**

A shielded interface cable should be used to ensure compliance with the limits for a Class B digital device.

## **Industry Canada Compliance Statement (Canada only)**

---

This Class B digital apparatus complies with Canadian ICES–003.

Cet appareil numérique de la classe B est conforme à la norme NMB–003 du Canada.

Operation is subject to the following two conditions: (1) this device may not cause interference, and (2) this device must accept any interference, including interference that may cause undesired operation of this device.

## **Disconnect device**

---

This product must be installed near an AC power outlet that is easily accessible. In case of emergencies, you must disconnect the power cord from the AC power outlet to shut off power completely.

## **LAN connection (MFC-7345N, MFC-7440N and MFC-7840W only)**

---

### **! CAUTION**

DO NOT connect this product to a LAN connection that is subject to over-voltages.

## International ENERGY STAR® Compliance Statement

The purpose of the International ENERGY STAR® Program is to promote the development and popularization of energy-efficient office equipment.

As an ENERGY STAR® Partner, Brother Industries, Ltd. has determined that this product meets the ENERGY STAR® guidelines for energy efficiency.



### Laser safety

This equipment is certified as a Class 1 laser product as defined in IEC 60825-1+A2: 2001 under the U.S. Department of Health and Human Services (DHHS) Radiation Performance Standard according to the Radiation Control for Health and Safety Act of 1968. This means that the equipment does not produce hazardous laser radiation.

Since radiation emitted inside the equipment is completely confined within protective housings and external covers, the laser beam cannot escape from the machine during any phase of user operation.

### FDA regulations

U.S. Food and Drug Administration (FDA) has implemented regulations for laser products manufactured on and after August 2, 1976. Compliance is mandatory for products marketed in the United States. One of the following labels on the back of the machine indicates compliance with the FDA regulations and must be attached to laser products marketed in the United States.

**Manufactured:**

BROTHER Industries (Vietnam) LTD.

Phuc Dien Industrial Zone Cam Phuc Commune, Cam giang Dist Hai Duong Province, Vietnam.

This product complies with FDA performance standards for laser products except for deviations pursuant to Laser Notice No. 50, dated June 24, 2007.

**Manufactured:**

BROTHER TECHNOLOGY (SHENZHEN) LTD.

NO6 Gold Garden Ind., Nanling Buji, Longgang, Shenzhen, China

This product complies with FDA performance standards for laser products except for deviations pursuant to Laser Notice No. 50, dated June 24, 2007.



## WARNING

Use of controls, adjustments or performance of procedures other than those specified in this manual may result in hazardous invisible radiation exposure.

Internal laser radiation

Max. Radiation Power: 10 mW

Wave Length: 780 – 800 nm

Laser Class: Class 3B

## Important safety instructions

- 1 Read all of these instructions.
- 2 Save them for later reference.
- 3 Follow all warnings and instructions marked on the product.
- 4 Unplug this product from the wall outlet before cleaning inside of the machine. DO NOT use liquid or aerosol cleaners. Use a damp cloth for cleaning.
- 5 DO NOT place this product on an unstable cart, stand, or table. The product may fall, causing serious damage to the product.
- 6 Slots and openings in the cabinet at the back or bottom are provided for ventilation. To ensure reliable operation of the product and to protect it from overheating, these openings must not be blocked or covered. The openings should never be blocked by placing the product on a bed, sofa, rug, or other similar surface. This product should never be placed near or over a radiator or heater. This product should never be placed in a built-in installation unless proper ventilation is provided.
- 7 This product should be connected to an AC power source within the range indicated on the rating label. DO NOT connect it to a DC power source or inverter. If you are not sure, contact a qualified electrician.
- 8 This product is equipped with a 3-wire grounded plug. This plug will only fit into a grounded power outlet. This is a safety feature. If you are unable to insert the plug into the outlet, call your electrician to replace your obsolete outlet. DO NOT defeat the purpose of the grounded plug.
- 9 Use only the power cord supplied with this machine.
- 10 DO NOT allow anything to rest on the power cord. DO NOT place this product where people can walk on the cord.
- 11 If an extension cord is used with this product, make sure that the total ampere ratings on the products plugged into the extension cord DO NOT exceed the extension cord ampere rating. Also, make sure that the total of all products plugged into the AC power outlet does not exceed 15 amperes (US only).



- 12 The power cord, including extensions, should be no longer than 16.5 feet (5 meters).  
DO NOT share the same power circuit with other high powered appliances, such as an air conditioner, copier, shredder, and so on. If you cannot avoid using the printer with these appliances, we recommend that you use a voltage transformer or a high-frequency noise filter.  
Use a voltage regulator if the power source is not stable.
- 13 DO NOT place anything in front of the machine that will block received faxes. DO NOT place anything in the path of received faxes.
- 14 Wait until pages have exited the machine before picking them up.
- 15 Never push objects of any kind into this product through cabinet slots, since they may touch dangerous voltage points or short out parts resulting in the risk of fire or electric shock. Never spill liquid of any kind on the product. DO NOT attempt to service this product yourself because opening or removing covers may expose you to dangerous voltage points and other risks and may void your warranty. Refer all servicing to a Brother Authorized Service Center. For the location of your nearest Brother Authorized Service Center, please call:  
**In USA:** 1-877-BROTHER (1-877-276-8437)  
**In Canada:** 1-877-BROTHER
- 16 Unplug this product from the AC power outlet and refer all servicing to Brother Authorized Service Personnel under the following conditions:
- When the power cord is damaged or frayed.
  - If liquid has been spilled into the product.
  - If the product has been exposed to rain or water.
  - If the product does not operate normally when the operating instructions are followed. Adjust only those controls that are covered by the operating instructions. Improper adjustment of other controls may result in damage and will often require extensive work by a qualified technician to restore the product to normal operation.
  - If the product has been dropped or the cabinet has been damaged.
  - If the product exhibits a distinct change in performance, indicating a need for service.
- 17 To protect your product against power surges, we recommend the use of a power protection device (Surge Protector).
- 18 To reduce the risk of fire, electric shock and injury to people, note the following:
- DO NOT use this product near appliances that use water, a swimming pool or in a wet basement.
  - DO NOT use the machine during an electrical storm (there is the remote possibility of an electrical shock). If you have connected a telephone DO NOT use it to report a gas leak in the vicinity of the leak.

# Trademarks

The Brother logo is a registered trademark of Brother Industries, Ltd.

Brother is a registered trademark of Brother Industries, Ltd.

Multi-Function Link is a registered trademark of Brother International Corporation.

Windows Vista is either a registered trademark or a trademark of Microsoft Corporation in the United States and other countries.

Microsoft, Windows and Windows Server are registered trademarks of Microsoft Corporation in the United States and/or other countries.

Macintosh and TrueType are registered trademarks of Apple Inc.

PostScript is a registered trademark and PostScript 3 is a trademark of Adobe Systems Incorporated.

Nuance, the Nuance logo, PaperPort and ScanSoft are trademarks or registered trademarks of Nuance Communications, Inc. or its affiliates in the United States and/or other countries.

Presto! PageManager is a registered trademark of NewSoft Technology Corporation.

BROADCOM, SecureEasySetup and the SecureEasySetup logo are trademarks or registered trademarks of Broadcom Corporation in the United States and/or other countries.

AOSS is a trademark of Buffalo Inc.

Wi-Fi, WPA and WPA2 are registered trademarks and Wi-Fi Protected Setup is a trademark of Wi-Fi Alliance.

Java and all Java-based trademarks and logos are trademarks or registered trademarks of Sun Microsystems, Inc. in the United States and other countries.

Each company whose software title is mentioned in this manual has a Software License Agreement specific to its proprietary programs.

**All other brand and product names mentioned in this User's Guide are registered trademarks of their respective companies.**

## Troubleshooting

### IMPORTANT

For technical help, you must call the country where you bought the machine. Calls must be made **from within** that country.

### If you are having difficulty with your machine

If you think there is a problem, check the chart below and follow the troubleshooting tips. You can solve most problems by yourself.

If you need additional help, the Brother Solutions Center offers the latest FAQs and troubleshooting tips.

Visit us at <http://solutions.brother.com/>.

### Printing or receiving faxes

| Difficulties                                                                                                                                                               | Suggestions                                                                                                                                                                                                      |
|----------------------------------------------------------------------------------------------------------------------------------------------------------------------------|------------------------------------------------------------------------------------------------------------------------------------------------------------------------------------------------------------------|
| <ul style="list-style-type: none"> <li>■ Condensed print</li> <li>■ Horizontal streaks</li> <li>■ Top and bottom sentences are cut off</li> <li>■ Missing lines</li> </ul> | Usually this is caused by a poor telephone connection. If your copy looks good, you probably had a bad connection, with static or interference on the telephone line. Ask the other party to send the fax again. |
| Poor print quality                                                                                                                                                         | See <i>Improving the print quality</i> on page 100.                                                                                                                                                              |
| Vertical black lines when receiving                                                                                                                                        | The corona wire for printing may be dirty. Clean the corona wire. (See <i>Cleaning the corona wire</i> on page 122.)                                                                                             |
|                                                                                                                                                                            | The sender's scanner may be dirty. Ask the sender to make a copy to see if the problem is with the sending machine. Try receiving from another fax machine.                                                      |
|                                                                                                                                                                            | If the problem continues, call Brother Customer Service at 1-877-BROTHER (1-877-276-8437) (in USA) or 1-877-BROTHER (in Canada).                                                                                 |
| Received faxes appear as split or blank pages.                                                                                                                             | If the received faxes are divided and printed on two pages or if you get an extra blank page, your paper size setting may not be correct for the paper you are using. (See <i>Paper size</i> on page 20.)        |
|                                                                                                                                                                            | Turn on auto reduction. (See <i>Printing a reduced incoming fax</i> on page 43.)                                                                                                                                 |

## Telephone line or connections

| Difficulties                             | Suggestions                                                                                                                                                                                                                                                                                                                                                        |
|------------------------------------------|--------------------------------------------------------------------------------------------------------------------------------------------------------------------------------------------------------------------------------------------------------------------------------------------------------------------------------------------------------------------|
| Dialing does not work.                   | Check for a dial tone.                                                                                                                                                                                                                                                                                                                                             |
|                                          | Change <b>Tone/Pulse</b> setting. (See <i>the Quick Setup Guide</i> .) (Canada only)                                                                                                                                                                                                                                                                               |
|                                          | Check all line cord connections.                                                                                                                                                                                                                                                                                                                                   |
|                                          | Check that the machine is plugged in and switched on.                                                                                                                                                                                                                                                                                                              |
|                                          | Send a manual fax by pressing <b>Hook</b> or by lifting the handset of an external telephone and dialing the number. Wait to hear fax receiving tones before pressing <b>Start</b> .                                                                                                                                                                               |
| The machine does not answer when called. | Make sure the machine is in the correct receive mode for your setup. (See <i>Receiving a fax</i> on page 39.) Check for a dial tone. If possible, call your machine to hear it answer. If there is still no answer, check the telephone line cord connection. If you do not hear ringing when you call your machine, ask your telephone company to check the line. |

## Sending faxes

| Difficulties                                       | Suggestions                                                                                                                                                                                                                                                                                                                                                                                                                                                                                                                                                                                                                                                                                                                                                                                                                                                                                               |
|----------------------------------------------------|-----------------------------------------------------------------------------------------------------------------------------------------------------------------------------------------------------------------------------------------------------------------------------------------------------------------------------------------------------------------------------------------------------------------------------------------------------------------------------------------------------------------------------------------------------------------------------------------------------------------------------------------------------------------------------------------------------------------------------------------------------------------------------------------------------------------------------------------------------------------------------------------------------------|
| Poor sending quality.                              | Try changing your resolution to <b>Fine</b> or <b>S.Fine</b> . Make a copy to check your machine's scanner operation. If the copy quality is not good, clean the scanner. (See <i>Cleaning the scanner glass</i> on page 119.)                                                                                                                                                                                                                                                                                                                                                                                                                                                                                                                                                                                                                                                                            |
| Transmission Verification Report says 'RESULT:NG'. | <p>There is probably temporary noise or static on the line. Try sending the fax again. If you are sending a PC Fax message and get 'RESULT:NG' on the Transmission Verification Report, your machine may be out of memory. To free up extra memory, you can turn off fax storage (see <i>Turning off remote fax options</i> on page 61), print fax messages in memory (see <i>Printing a fax from the memory</i> on page 43) or cancel a delayed fax or polling job (see <i>Checking and canceling waiting jobs</i> on page 38). If the problem continues, ask the telephone company to check your telephone line.</p> <p>If you often get transmission errors due to possible interference on the telephone line, try changing the Compatibility setting to <b>Basic (for VoIP)</b> (For MFC-7840W, <b>Normal</b> or <b>Basic (for VoIP)</b>). (See <i>Telephone line interference</i> on page 106.)</p> |
| Vertical black lines when sending.                 | Black vertical lines on faxes you send are typically caused by dirt or correction fluid on the glass strip. (See <i>Cleaning the scanner glass</i> on page 119.)                                                                                                                                                                                                                                                                                                                                                                                                                                                                                                                                                                                                                                                                                                                                          |

## Handling incoming calls

| Difficulties                               | Suggestions                                                                                                                                                                                                                                                                                                                                                  |
|--------------------------------------------|--------------------------------------------------------------------------------------------------------------------------------------------------------------------------------------------------------------------------------------------------------------------------------------------------------------------------------------------------------------|
| The machine 'Hears' a voice as a CNG Tone. | If Easy Receive is set to on, your machine is more sensitive to sounds. It may mistakenly interpret certain voices or music on the line as a fax machine calling and respond with fax receiving tones. Deactivate the machine by pressing <b>Stop/Exit</b> . Try avoiding this problem by turning Easy Receive to off. (See <i>Easy receive</i> on page 42.) |
| Sending a Fax Call to the machine.         | If you answered on an external or extension telephone, press your Fax Receive Code [default setting is (* 51)]. When your machine answers, hang up.                                                                                                                                                                                                          |

## Handling incoming calls (continued)

| Difficulties                      | Suggestions                                                                                                                                                                                                                                                                                                                                                                                                                                                                                                                                                                                                                                                                                                                                                                                                                                                      |
|-----------------------------------|------------------------------------------------------------------------------------------------------------------------------------------------------------------------------------------------------------------------------------------------------------------------------------------------------------------------------------------------------------------------------------------------------------------------------------------------------------------------------------------------------------------------------------------------------------------------------------------------------------------------------------------------------------------------------------------------------------------------------------------------------------------------------------------------------------------------------------------------------------------|
| Custom features on a single line. | <p>If you have Call Waiting, Call Waiting/Caller ID, Caller ID, RingMaster, Voice Mail, an answering machine, an alarm system or other custom feature on a single telephone line with your machine, it may create a problem sending or receiving faxes.</p> <p><b>For Example:</b> If you subscribe to Call Waiting or some other custom service and its signal comes through the line while your machine is sending or receiving a fax, the signal can temporarily interrupt or disrupt the faxes. Brother's ECM feature should help overcome this problem. This condition is related to the telephone system industry and is common to all devices that send and receive information on a single, shared line with custom features. If avoiding a slight interruption is crucial to your business, a separate line with no custom features is recommended.</p> |

## Menu access difficulties

| Difficulties                                                                     | Suggestions                                                                                                                                                                                                              |
|----------------------------------------------------------------------------------|--------------------------------------------------------------------------------------------------------------------------------------------------------------------------------------------------------------------------|
| The machine beeps when you try to access the Setup Receive and Setup Send menus. | If the <b>Fax</b> key is not illuminated, press it to turn on Fax mode. The Setup Receive setting ( <b>Menu, 2, 1</b> ) and Setup Send setting ( <b>Menu, 2, 2</b> ) are available only when the machine is in Fax mode. |

## Copy quality difficulties

| Difficulties                           | Suggestions                                                                                                                                                                                                                                                |
|----------------------------------------|------------------------------------------------------------------------------------------------------------------------------------------------------------------------------------------------------------------------------------------------------------|
| Vertical black line appears in copies. | Black vertical lines on copies are typically caused by dirt or correction fluid on the glass strip, or one of the corona wires for printing is dirty. (See <i>Cleaning the scanner glass</i> on page 119 and <i>Cleaning the corona wire</i> on page 122.) |

## Printing difficulties

| Difficulties | Suggestions                                                                                                                                                                                                                                                                                                                                                                                                                                                                                                                                                                                                                                                                                                                                                                                                                                                                                                                                                                                                                                                                                                                                                                                                                                                                                                                                                                                                                 |
|--------------|-----------------------------------------------------------------------------------------------------------------------------------------------------------------------------------------------------------------------------------------------------------------------------------------------------------------------------------------------------------------------------------------------------------------------------------------------------------------------------------------------------------------------------------------------------------------------------------------------------------------------------------------------------------------------------------------------------------------------------------------------------------------------------------------------------------------------------------------------------------------------------------------------------------------------------------------------------------------------------------------------------------------------------------------------------------------------------------------------------------------------------------------------------------------------------------------------------------------------------------------------------------------------------------------------------------------------------------------------------------------------------------------------------------------------------|
| No printout. | <ul style="list-style-type: none"> <li>■ Check that the machine is plugged in and the power switch is turned on.</li> <li>■ Check that the toner cartridge and drum unit are installed properly. (See <i>Replacing the drum unit</i> on page 130.)</li> <li>■ Check the interface cable connection on both the machine and your computer. (See <i>the Quick Setup Guide</i>.)</li> <li>■ Check that the correct printer driver has been installed and chosen.</li> <li>■ Check to see if the LCD is showing an error message. (See <i>Error and maintenance messages</i> on page 107.)</li> <li>■ Check that machine is online:                     <ul style="list-style-type: none"> <li>(For Windows Vista®)</li> <li>Click the <b>Start</b> button, <b>Control Panel, Hardware and Sound</b>, and then <b>Printers</b>. Right-click <b>Brother MFC-XXXX Printer</b>. Make sure that <b>Use Printer Offline</b> is unchecked.</li> <li>(For Windows® XP and Windows Server® 2003)</li> <li>Click the <b>Start</b> button and choose <b>Printers and Faxes</b>. Right-click <b>Brother MFC-XXXX Printer</b>. Make sure that <b>Use Printer Offline</b> is unchecked.</li> <li>(For Windows® 2000)</li> <li>Click the <b>Start</b> button and choose <b>Settings</b> and then <b>Printers</b>. Right-click <b>Brother MFC-XXXX Printer</b>. Make sure that <b>Use Printer Offline</b> is unchecked.</li> </ul> </li> </ul> |

## Printing difficulties (continued)

| Difficulties                                                                                                       | Suggestions                                                                                                                                                                                                                                                                                                                                                                                                                     |
|--------------------------------------------------------------------------------------------------------------------|---------------------------------------------------------------------------------------------------------------------------------------------------------------------------------------------------------------------------------------------------------------------------------------------------------------------------------------------------------------------------------------------------------------------------------|
| The machine prints unexpectedly or it prints garbage.                                                              | <ul style="list-style-type: none"> <li>■ Pull out the paper tray and wait until the machine stops printing. Then turn off the machine's power switch and disconnect from the power for several minutes. (The MFC-7840W can be turned off for approximately 4 days without losing faxes stored in the memory.)</li> <li>■ Check the settings in your application to make sure it is set up to work with your machine.</li> </ul> |
| The machine prints the first couple of pages correctly, then some pages have text missing.                         | <ul style="list-style-type: none"> <li>■ Check the settings in your application to make sure that it is set up to work with your machine.</li> <li>■ Your computer is not recognizing the machine's input buffer's full signal. Make sure that you connected the interface cable correctly. (See <i>the Quick Setup Guide</i>.)</li> </ul>                                                                                      |
| The headers or footers appear when the document displays on the screen but they do not show up when it is printed. | There is an unprintable area on the top and bottom of the page. Adjust the top and bottom margins in your document to allow for this.                                                                                                                                                                                                                                                                                           |

## Scanning difficulties

| Difficulties                                                              | Suggestions                                                                                                                                                                    |
|---------------------------------------------------------------------------|--------------------------------------------------------------------------------------------------------------------------------------------------------------------------------|
| TWAIN errors appear while scanning.                                       | Make sure that the Brother TWAIN driver is chosen as the primary source. In PaperPort™ 11SE, click <b>File, Scan or Get Photo</b> and choose the <b>Brother TWAIN driver</b> . |
| OCR does not work                                                         | Try increasing the scanning resolution.                                                                                                                                        |
| Network scanning does not work. (MFC-7345N, MFC-7440N and MFC-7840W only) | See <i>Network difficulties</i> (MFC-7345N, MFC-7440N and MFC-7840W only) on page 97.                                                                                          |

## Software difficulties

| Difficulties                                       | Suggestions                                                                                                     |
|----------------------------------------------------|-----------------------------------------------------------------------------------------------------------------|
| Cannot install software or print.                  | Run the <b>Repair MFL-Pro Suite</b> program on the CD-ROM. This program will repair and reinstall the software. |
| Cannot perform '2 in 1' or '4 in 1' printing.      | Check that the paper size setting in the application and in the printer driver are the same.                    |
| The machine does not print from Adobe Illustrator. | Try to reduce the print resolution. (See <i>Advanced tab in the Software User's Guide on the CD-ROM</i> .)      |

## Paper handling difficulties

| Difficulties                                                                       | Suggestions                                                                                                                                                                                                                                                                                                                                                                                                                                                                                                                                            |
|------------------------------------------------------------------------------------|--------------------------------------------------------------------------------------------------------------------------------------------------------------------------------------------------------------------------------------------------------------------------------------------------------------------------------------------------------------------------------------------------------------------------------------------------------------------------------------------------------------------------------------------------------|
| The machine does not load paper.<br>The LCD shows No Paper or a Paper Jam message. | <ul style="list-style-type: none"> <li>■ If there is no paper, load a new stack of paper into the paper tray.</li> <li>■ If there is paper in the paper tray, make sure it is straight. If the paper is curled, you should straighten it. Sometimes it is helpful to remove the paper, turn the stack over and put it back into the paper tray.</li> <li>■ Reduce the amount of paper in the paper tray, and then try again.</li> <li>■ If the LCD shows Paper Jam message and you still have a problem, see <i>Paper jams</i> on page 114.</li> </ul> |

### Paper handling difficulties (continued)

| Difficulties                 | Suggestions                                                                                                                                                                                                                                                          |
|------------------------------|----------------------------------------------------------------------------------------------------------------------------------------------------------------------------------------------------------------------------------------------------------------------|
| How do I print on envelopes? | You can load envelopes from the manual feed slot. Your application must be set up to print the envelope size you are using. This is usually done in the Page Setup or Document Setup menu of your application. (See your application's manual for more information.) |
| Which paper can I use?       | You can use plain paper, recycled paper, transparency and labels that are made for laser machines. (For details, see <i>Acceptable paper and other print media</i> on page 14.)                                                                                      |
| There is a paper jam.        | (See <i>Paper jams</i> on page 114.)                                                                                                                                                                                                                                 |

### Print quality difficulties

| Difficulties               | Suggestions                                                                                                                                                                                                                                                                                                                                                                                  |
|----------------------------|----------------------------------------------------------------------------------------------------------------------------------------------------------------------------------------------------------------------------------------------------------------------------------------------------------------------------------------------------------------------------------------------|
| Printed pages are curled.  | <ul style="list-style-type: none"> <li>■ Low quality thin or thick paper or not printing on the recommended side of the paper could cause this problem. Try turning over the stack of paper in the paper tray.</li> <li>■ Make sure that you choose the Paper Type that suits the print media type you are using. (See <i>Acceptable paper and other print media</i> on page 14.)</li> </ul> |
| Printed pages are smeared. | The Paper Type setting may be incorrect for the type of print media you are using, or the print media may be too thick or have a rough surface. (See <i>Acceptable paper and other print media</i> on page 14 and <i>Basic tab in the Software User's Guide on the CD-ROM</i> .)                                                                                                             |
| Printouts are too light.   | <ul style="list-style-type: none"> <li>■ If this problem occurs when making copies or printing received faxes, turn Toner Save mode to off in the machine menu settings. (See <i>Toner save</i> on page 22.)</li> <li>■ Set Toner Save mode to off in the Advanced tab in the printer driver. (See <i>Advanced tab in the Software User's Guide on the CD-ROM</i>.)</li> </ul>               |

### Network difficulties(MFC-7345N, MFC-7440N and MFC-7840W only)

| Difficulties                       | Suggestions                                                                                                                                                                                                                                                                                                                                                                                                                                                                                                                                                                                                              |
|------------------------------------|--------------------------------------------------------------------------------------------------------------------------------------------------------------------------------------------------------------------------------------------------------------------------------------------------------------------------------------------------------------------------------------------------------------------------------------------------------------------------------------------------------------------------------------------------------------------------------------------------------------------------|
| Cannot print over a wired Network. | <p>If you are having Network problems see <i>the Network User's Guide on the CD-ROM</i> for more information.</p> <p>Make sure your machine is powered on and is on-line and in the Ready state. Print the Network Configuration list to see your current Network settings. (See <i>How to print a report</i> on page 68.) Reconnect the LAN cable to the hub to verify that the cable and network connections are good. If possible, try connecting the machine to a different port on your hub using a different cable. If the connections are good, the lower LED of the back panel of the machine will be green.</p> |

## Network difficulties(MFC-7345N, MFC-7440N and MFC-7840W only) (continued)



| Difficulties                                                                                                                                                   | Suggestions                                                                                                                                                                                                                                                                                                                                                                                                                                                                                                                                                                                                                                                                                                                                                                                                                                                                                                                                                                                                                                                                                                                                                                                                                                                                                                                                                                                                                                                                                                                                                                                                                                                                                                                                                                                                                                                                                                                                                                                                                                                                                                                                                                                                                                                                                                                                                                                                                                                                                                                                                                                                                                                                                                                                                                                                                                                                                                                          |
|----------------------------------------------------------------------------------------------------------------------------------------------------------------|--------------------------------------------------------------------------------------------------------------------------------------------------------------------------------------------------------------------------------------------------------------------------------------------------------------------------------------------------------------------------------------------------------------------------------------------------------------------------------------------------------------------------------------------------------------------------------------------------------------------------------------------------------------------------------------------------------------------------------------------------------------------------------------------------------------------------------------------------------------------------------------------------------------------------------------------------------------------------------------------------------------------------------------------------------------------------------------------------------------------------------------------------------------------------------------------------------------------------------------------------------------------------------------------------------------------------------------------------------------------------------------------------------------------------------------------------------------------------------------------------------------------------------------------------------------------------------------------------------------------------------------------------------------------------------------------------------------------------------------------------------------------------------------------------------------------------------------------------------------------------------------------------------------------------------------------------------------------------------------------------------------------------------------------------------------------------------------------------------------------------------------------------------------------------------------------------------------------------------------------------------------------------------------------------------------------------------------------------------------------------------------------------------------------------------------------------------------------------------------------------------------------------------------------------------------------------------------------------------------------------------------------------------------------------------------------------------------------------------------------------------------------------------------------------------------------------------------------------------------------------------------------------------------------------------------|
| <p>The network scanning feature does not work.</p> <p>The network PC Fax Receive feature does not work.</p> <p>The network printing feature does not work.</p> | <p>(For Windows® only) The firewall setting on your PC may be rejecting the necessary network connection. Follow the instructions below to configure your firewall. If you are using a personal firewall software, see the User's Guide for your software or contact the software manufacturer.</p> <p><b>For Windows® XP SP2 users:</b></p> <ol style="list-style-type: none"> <li>1 Click the <b>Start</b> button, <b>Control Panel, Network and Internet Connections</b> and then <b>Windows Firewall</b>. Make sure that <b>Windows Firewall</b> on the <b>General</b> tab is set to <b>On</b>.</li> <li>2 Click the <b>Advanced</b> tab and <b>Settings...</b> button of the <b>Network Connection Settings</b>.</li> <li>3 Click the <b>Add</b> button.</li> <li>4 To add port 54925 for network scanning, enter the information below:             <ol style="list-style-type: none"> <li>1. In <b>Description of service</b>: Enter any description, for example "Brother Scanner".</li> <li>2. In <b>Name or IP address (for example 192.168.0.12) of the computer hosting this service on your network</b>: Enter "Localhost".</li> <li>3. In <b>External Port number for this service</b>: Enter "54925".</li> <li>4. In <b>Internal Port number for this service</b>: Enter "54925".</li> <li>5. Make sure <b>UDP</b> is chosen.</li> <li>6. Click <b>OK</b>.</li> </ol> </li> <li>5 Click the <b>Add</b> button.</li> <li>6 To add port 54926 for network PC Fax, enter the information below:             <ol style="list-style-type: none"> <li>1. In <b>Description of service</b>: Enter any description, for example "Brother PC Fax".</li> <li>2. In <b>Name or IP address (for example 192.168.0.12) of the computer hosting this service on your network</b>: Enter "Localhost".</li> <li>3. In <b>External Port number for this service</b>: Enter "54926".</li> <li>4. In <b>Internal Port number for this service</b>: Enter "54926".</li> <li>5. Make sure <b>UDP</b> is chosen.</li> <li>6. Click <b>OK</b>.</li> </ol> </li> <li>7 If you still have trouble with your network connection, click the <b>Add</b> button.</li> <li>8 To add port 137 for network scanning, network printing and network PC Fax receiving, enter the information below:             <ol style="list-style-type: none"> <li>1. In <b>Description of service</b>: - Enter any description, for example "Brother PC Fax receiving".</li> <li>2. In <b>Name or IP address (for example 192.168.0.12) of the computer hosting this service on your network</b>: Enter "Localhost".</li> <li>3. In <b>External Port number for this service</b>: Enter "137".</li> <li>4. In <b>Internal Port number for this service</b>: Enter "137".</li> <li>5. Make sure <b>UDP</b> is chosen.</li> <li>6. Click <b>OK</b>.</li> </ol> </li> <li>9 Make sure if the new setting is added and is checked, and then click <b>OK</b>.</li> </ol> |





**Network difficulties(MFC-7345N, MFC-7440N and MFC-7840W only) (continued)**

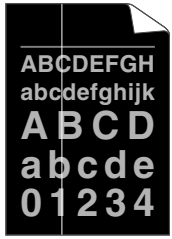

| Difficulties                                                                                                                                                                      | Suggestions                                                                                                                                                                                                                                                                                                                                                                                                                                                                                                                                                                                                                                                                                                                                                                                                                                                                                                                                                                                                                                                                                                                                                                                                                                                                                                                                                                                                                                                                                                                                                                                                                                                                                                                                                                          |
|-----------------------------------------------------------------------------------------------------------------------------------------------------------------------------------|--------------------------------------------------------------------------------------------------------------------------------------------------------------------------------------------------------------------------------------------------------------------------------------------------------------------------------------------------------------------------------------------------------------------------------------------------------------------------------------------------------------------------------------------------------------------------------------------------------------------------------------------------------------------------------------------------------------------------------------------------------------------------------------------------------------------------------------------------------------------------------------------------------------------------------------------------------------------------------------------------------------------------------------------------------------------------------------------------------------------------------------------------------------------------------------------------------------------------------------------------------------------------------------------------------------------------------------------------------------------------------------------------------------------------------------------------------------------------------------------------------------------------------------------------------------------------------------------------------------------------------------------------------------------------------------------------------------------------------------------------------------------------------------|
| <p>The network scanning feature does not work.</p> <p>The network PC Fax Receive feature does not work.</p> <p>The network printing feature does not work.</p> <p>(continued)</p> | <p><b>For Windows Vista® users:</b></p> <ol style="list-style-type: none"> <li>1 Click the <b>Start</b> button, <b>Control Panel</b>, <b>Network and Internet</b>, <b>Windows Firewall</b> and click <b>Change settings</b>.</li> <li>2 When the <b>User Account Control</b> screen appears, do the following. <ul style="list-style-type: none"> <li>■ Users who have administrator rights: Click <b>Continue</b>.</li> <li>■ For users who do not have administrator rights: Enter the administrator password and click <b>OK</b>.</li> </ul> </li> <li>3 Make sure that <b>Windows Firewall</b> on the <b>General</b> tab is set to <b>On</b>.</li> <li>4 Click the <b>Exceptions</b> tab.</li> <li>5 Click the <b>Add port...</b> button.</li> <li>6 To add port 54925 for network scanning, enter the information below: <ol style="list-style-type: none"> <li>1. In <b>Name</b>: Enter any description. (for example "Brother Scanner")</li> <li>2. In <b>Port number</b>: Enter "54925".</li> <li>3. Make sure <b>UDP</b> is chosen. Then click <b>OK</b>.</li> </ol> </li> <li>7 Click the <b>Add port...</b> button.</li> <li>8 To add port 54926 for Network PC Fax, enter the information below: <ol style="list-style-type: none"> <li>1. In <b>Name</b>: Enter any description. (for example "Brother PC Fax")</li> <li>2. In <b>Port number</b>: Enter "54926".</li> <li>3. Make sure <b>UDP</b> is chosen. Then click <b>OK</b>.</li> </ol> </li> <li>9 Make sure that the new setting is added and is checked, and then click <b>Apply</b>.</li> <li>10 If you still have trouble with your network connection such as network scanning or printing, check <b>File and Printer Sharing</b> box in the <b>Exceptions</b> tab and then click <b>Apply</b>.</li> </ol> |
| <p>Your computer cannot find your machine.</p>                                                                                                                                    | <p><b>For Windows® users:</b> The firewall setting on your PC may be rejecting the necessary network connection. (For details, see the instructions above.)</p> <p><b>For Macintosh® users:</b> Re-select your machine in the Device Selector application located in <b>Macintosh HD/Library/Printers/Brother/Utilities/DeviceSelector</b> or from the Model pop-up menu of ControlCenter2.</p>                                                                                                                                                                                                                                                                                                                                                                                                                                                                                                                                                                                                                                                                                                                                                                                                                                                                                                                                                                                                                                                                                                                                                                                                                                                                                                                                                                                      |

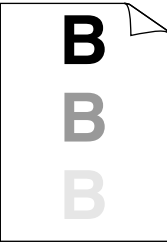
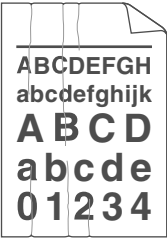

## Improving the print quality

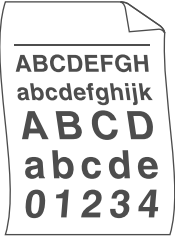
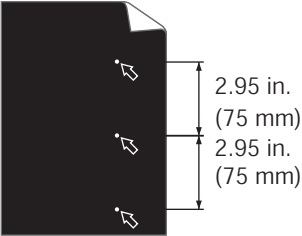
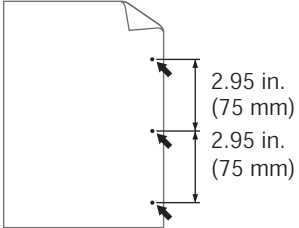
| Examples of poor print quality                                                                                                                           | Recommendation                                                                                                                                                                                                                                                                                                                                                                                                                                                                                                                                                                                                                                                                                                                                                                                                                                                                                                        |
|----------------------------------------------------------------------------------------------------------------------------------------------------------|-----------------------------------------------------------------------------------------------------------------------------------------------------------------------------------------------------------------------------------------------------------------------------------------------------------------------------------------------------------------------------------------------------------------------------------------------------------------------------------------------------------------------------------------------------------------------------------------------------------------------------------------------------------------------------------------------------------------------------------------------------------------------------------------------------------------------------------------------------------------------------------------------------------------------|
|  <p data-bbox="120 643 437 672"><b>White lines across the page</b></p>  | <ul style="list-style-type: none"> <li data-bbox="474 382 1226 469">■ Make sure that you use paper that meets our specifications. A rough surfaced paper or thick print media can cause the problem. (See <i>Acceptable paper and other print media</i> on page 14.)</li> <li data-bbox="474 484 1226 600">■ Make sure that you choose the appropriate media type in the printer driver or in the machine's Paper Type menu setting. (See <i>Acceptable paper and other print media</i> on page 14 and <i>Basic tab in the Software User's Guide on the CD-ROM</i>.)</li> <li data-bbox="474 616 1226 672">■ The problem may disappear by itself. Print multiple pages to clear this problem, especially if the machine has not been used for a long time.</li> <li data-bbox="474 687 1226 743">■ The drum unit may be damaged. Put in a new drum unit. (See <i>Replacing the drum unit</i> on page 130.)</li> </ul> |
|  <p data-bbox="120 1010 437 1039"><b>White lines down the page</b></p> | <ul style="list-style-type: none"> <li data-bbox="474 753 1226 809">■ Wipe the laser scanner windows with a soft cloth. (See <i>Cleaning the laser scanner window</i> on page 120.)</li> <li data-bbox="474 824 1226 880">■ Make sure that a torn sheet of paper is not inside the machine covering the scanner window.</li> <li data-bbox="474 896 1226 952">■ The toner cartridge may be damaged. Put in a new toner cartridge. (See <i>Replacing a toner cartridge</i> on page 126.)</li> <li data-bbox="474 967 1226 1023">■ The drum unit may be damaged. Put in a new drum unit. (See <i>Replacing the drum unit</i> on page 130.)</li> </ul>                                                                                                                                                                                                                                                                   |
|  <p data-bbox="209 1319 348 1348"><b>Hollow print</b></p>             | <ul style="list-style-type: none"> <li data-bbox="474 1052 1226 1108">■ Make sure that you use paper that meets our specifications. (See <i>Acceptable paper and other print media</i> on page 14.)</li> <li data-bbox="474 1124 1226 1240">■ Choose <b>Thick paper</b> mode in the printer driver, choose <b>Thick</b> in the machine's Paper Type menu setting or use thinner paper than you are currently using. (See <i>Paper type</i> on page 20 and <i>Basic tab in the Software User's Guide on the CD-ROM</i>.)</li> <li data-bbox="474 1255 1226 1311">■ Check the machine's environment. Conditions such as high humidity can cause hollow print. (See <i>Choosing a location</i> on page 82.)</li> <li data-bbox="474 1327 1226 1383">■ The drum unit may be damaged. Put in a new drum unit. (See <i>Replacing the drum unit</i> on page 130.)</li> </ul>                                                 |
|  <p data-bbox="179 1663 378 1692"><b>Gray background</b></p>          | <ul style="list-style-type: none"> <li data-bbox="474 1396 1226 1452">■ Make sure that you use paper that meets our specifications. (See <i>Acceptable paper and other print media</i> on page 14.)</li> <li data-bbox="474 1468 1226 1555">■ Check the machine's environment. Conditions such as high temperatures and high humidity can increase the amount of background shading. (See <i>Choosing a location</i> on page 82.)</li> <li data-bbox="474 1570 1226 1626">■ The toner cartridge may be damaged. Put in a new toner cartridge. (See <i>Replacing a toner cartridge</i> on page 126.)</li> <li data-bbox="474 1642 1226 1698">■ The drum unit may be damaged. Put in a new drum unit. (See <i>Replacing the drum unit</i> on page 130.)</li> </ul>                                                                                                                                                      |

| Examples of poor print quality                                                                                                               | Recommendation                                                                                                                                                                                                                                                                                                                                                                                                                                                                                                                                                                                                                                                                                                                                                                                                                |
|----------------------------------------------------------------------------------------------------------------------------------------------|-------------------------------------------------------------------------------------------------------------------------------------------------------------------------------------------------------------------------------------------------------------------------------------------------------------------------------------------------------------------------------------------------------------------------------------------------------------------------------------------------------------------------------------------------------------------------------------------------------------------------------------------------------------------------------------------------------------------------------------------------------------------------------------------------------------------------------|
|  <p data-bbox="234 552 385 581">Page skewed</p>             | <ul style="list-style-type: none"> <li data-bbox="504 295 1255 382">■ Make sure that the paper or other print media is loaded properly in the paper tray and that the guides are not too tight or too loose against the paper stack.</li> <li data-bbox="504 392 1255 450">■ Set the paper guides correctly. (See <i>Loading paper in the paper tray</i> on page 9.)</li> <li data-bbox="504 459 857 488">■ The paper tray may be too full.</li> <li data-bbox="504 498 1197 566">■ If you are using the manual feed slot, see <i>Loading paper in the manual feed slot</i> on page 10.</li> <li data-bbox="504 575 1255 633">■ Check the paper type and quality. (See <i>Acceptable paper and other print media</i> on page 14.)</li> </ul>                                                                                  |
|  <p data-bbox="275 915 344 944">Ghost</p>                   | <ul style="list-style-type: none"> <li data-bbox="504 649 1255 736">■ Make sure that you use paper that meets our specifications. Rough-surfaced paper or thick paper may cause the problem. (See <i>Acceptable paper and other print media</i> on page 14.)</li> <li data-bbox="504 745 1255 861">■ Make sure that you choose the proper media type in the printer driver or in the machine's Paper Type menu setting. (See <i>Acceptable paper and other print media</i> on page 14 and <i>Basic tab in the Software User's Guide on the CD-ROM.</i>)</li> <li data-bbox="504 871 1188 938">■ The drum unit may be damaged. Put in a new drum unit. (See <i>Replacing the drum unit</i> on page 130.)</li> <li data-bbox="504 948 1255 977">■ The fuser unit may be contaminated. Call Brother Customer Service.</li> </ul> |
|  <p data-bbox="196 1251 422 1280">Wrinkles or creases</p> | <ul style="list-style-type: none"> <li data-bbox="504 991 1255 1049">■ Check the paper type and quality. (See <i>Acceptable paper and other print media</i> on page 14.)</li> <li data-bbox="504 1058 1255 1116">■ Make sure that paper is loaded properly. (See <i>Loading paper in the paper tray</i> on page 9.)</li> <li data-bbox="504 1126 1255 1193">■ Turn over the stack of paper in the tray or rotate the paper 180° in the input tray.</li> </ul>                                                                                                                                                                                                                                                                                                                                                                 |
|  <p data-bbox="248 1557 371 1586">Poor fixing</p>         | <ul style="list-style-type: none"> <li data-bbox="504 1296 1255 1383">■ Choose <b>Improve Toner Fixing</b> mode in the printer driver. (See <i>Device Options (For Windows®)</i> or <i>Print Settings (For Macintosh®)</i> in the software <i>User's Guide on the CD-ROM.</i>)</li> </ul> <p data-bbox="532 1402 1208 1460">If you print only a few pages, change the printer driver setting in <b>Media Type</b> to a thin setting.</p>                                                                                                                                                                                                                                                                                                                                                                                      |

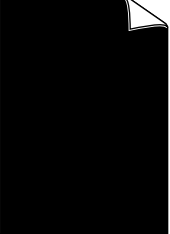
| Examples of poor print quality                                                                                                                                                                                                                                                                                                                                            | Recommendation                                                                                                                                                                                                                                                                                                                                                                                                                                                                                            |
|---------------------------------------------------------------------------------------------------------------------------------------------------------------------------------------------------------------------------------------------------------------------------------------------------------------------------------------------------------------------------|-----------------------------------------------------------------------------------------------------------------------------------------------------------------------------------------------------------------------------------------------------------------------------------------------------------------------------------------------------------------------------------------------------------------------------------------------------------------------------------------------------------|
|  <p data-bbox="193 552 367 581"><b>Curled or wavy</b></p>                                                                                                                                                                                                                                | <ul style="list-style-type: none"> <li data-bbox="477 295 1163 349">■ Check the paper type and quality. High temperatures and high humidity will cause paper to curl.</li> <li data-bbox="477 369 1222 479">■ If you do not use the machine often, the paper may have been in the paper tray too long. Turn over the stack of paper in the paper tray. Also, fan the paper stack and then rotate the paper 180° in the paper tray.</li> </ul>                                                             |
|  <p data-bbox="131 853 428 942"><b>White Spots on black text and graphics at 2.95 in. (75 mm) intervals</b></p>  <p data-bbox="152 1209 410 1267"><b>Black Spots at 2.95 in. (75 mm) intervals</b></p> | <ul style="list-style-type: none"> <li data-bbox="477 595 1204 705">■ Make ten copies of a blank, white sheet of paper. (See <i>Making multiple copies</i> on page 70.) If the problem is not solved, the drum unit may have glue from a label stuck on the OPC drum surface. Clean the drum unit. (See <i>Cleaning the drum unit</i> on page 123.)</li> <li data-bbox="477 724 1222 778">■ The drum unit may be damaged. Put in a new drum. (See <i>Replacing the drum unit</i> on page 130.)</li> </ul> |

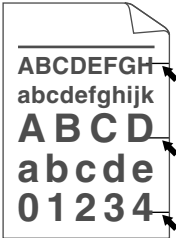
| Examples of poor print quality                                                                                                       | Recommendation                                                                                                                                                                                                                                                                                                                                                                                                                                                                                                                                                                                                                                                                                                                                                                                                                                                                                                                                                                                                                                                                                                                           |
|--------------------------------------------------------------------------------------------------------------------------------------|------------------------------------------------------------------------------------------------------------------------------------------------------------------------------------------------------------------------------------------------------------------------------------------------------------------------------------------------------------------------------------------------------------------------------------------------------------------------------------------------------------------------------------------------------------------------------------------------------------------------------------------------------------------------------------------------------------------------------------------------------------------------------------------------------------------------------------------------------------------------------------------------------------------------------------------------------------------------------------------------------------------------------------------------------------------------------------------------------------------------------------------|
|  <p data-bbox="279 556 343 581">Faint</p>           | <ul style="list-style-type: none"> <li data-bbox="504 295 1251 378">■ Check the machine's environment. Conditions such as humidity, high temperatures, and so on, may cause this print fault. (See <i>Choosing a location</i> on page 82.)</li> <li data-bbox="504 397 1251 537">■ If the whole page is too light, Toner Save mode may be on. Turn off <b>Toner Save</b> mode in the machine menu settings or <b>Toner Save</b> mode in the printer <b>Properties</b> of the driver. (See <i>Toner save</i> on page 22 or <i>Advanced tab in the Software User's Guide on the CD-ROM</i>.)</li> <li data-bbox="504 556 1251 639">■ Clean the scanner window and the corona wire of the drum unit. (See <i>Cleaning the laser scanner window</i> on page 120 and <i>Cleaning the corona wire</i> on page 122.)</li> <li data-bbox="504 658 1251 710">■ The toner cartridge may be damaged. Put in a new toner cartridge. (See <i>Replacing a toner cartridge</i> on page 126.)</li> <li data-bbox="504 730 1251 782">■ The drum unit may be damaged. Put in a new drum unit. (See <i>Replacing the drum unit</i> on page 130.)</li> </ul> |
|  <p data-bbox="230 1058 392 1083">Toner specks</p> | <ul style="list-style-type: none"> <li data-bbox="504 797 1251 880">■ Make sure that you use paper that meets our specifications. Rough-surfaced paper may cause the problem. (See <i>Acceptable paper and other print media</i> on page 14.)</li> <li data-bbox="504 900 1251 952">■ Clean the corona wire and the drum unit. (See <i>Cleaning the corona wire</i> on page 122 and <i>Cleaning the drum unit</i> on page 123.)</li> <li data-bbox="504 971 1251 1023">■ The drum unit may be damaged. Put in a new drum unit. (See <i>Replacing the drum unit</i> on page 130.)</li> <li data-bbox="504 1043 1251 1068">■ The fuser unit may be contaminated. Call Brother Customer Service.</li> </ul>                                                                                                                                                                                                                                                                                                                                                                                                                                 |
|  <p data-bbox="257 1367 364 1392">All black</p>   | <ul style="list-style-type: none"> <li data-bbox="504 1107 1251 1190">■ Clean the corona wire inside the drum unit by sliding the green tab. Be sure to return the green tab to the home position (▲). (See <i>Cleaning the corona wire</i> on page 122.)</li> <li data-bbox="504 1209 1251 1261">■ The drum unit may be damaged. Put in a new drum unit. (See <i>Replacing the drum unit</i> on page 130.)</li> <li data-bbox="504 1280 1251 1306">■ The fuser unit may be contaminated. Call Brother Customer Service.</li> </ul>                                                                                                                                                                                                                                                                                                                                                                                                                                                                                                                                                                                                      |

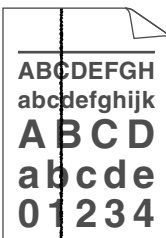
| Examples of poor print quality                                                                                                                                                                              | Recommendation                                                                                                                                                                                                                                                                                                                                                                                                                                                                                                                                                                                                                                                                                                                                                                                                                                                                                                                                                                                                                     |
|-------------------------------------------------------------------------------------------------------------------------------------------------------------------------------------------------------------|------------------------------------------------------------------------------------------------------------------------------------------------------------------------------------------------------------------------------------------------------------------------------------------------------------------------------------------------------------------------------------------------------------------------------------------------------------------------------------------------------------------------------------------------------------------------------------------------------------------------------------------------------------------------------------------------------------------------------------------------------------------------------------------------------------------------------------------------------------------------------------------------------------------------------------------------------------------------------------------------------------------------------------|
|  <p data-bbox="112 556 445 614"><b>Black toner marks across the page</b></p>                                               | <ul style="list-style-type: none"> <li data-bbox="477 295 1218 353">■ Make sure that you use paper that meets our specifications. (See <i>Acceptable paper and other print media</i> on page 14.)</li> <li data-bbox="477 369 1218 450">■ If you use label sheets for laser machines, the glue from the sheets may sometimes stick to the OPC drum surface. Clean the drum unit. (See <i>Cleaning the drum unit</i> on page 123.)</li> <li data-bbox="477 465 1218 523">■ Do not use paper that has clips or staples because they will scratch the surface of the drum.</li> <li data-bbox="477 539 1218 596">■ If the unpacked drum unit is in direct sunlight or room light, the unit may be damaged.</li> <li data-bbox="477 612 1218 670">■ The toner cartridge may be damaged. Put in a new toner cartridge. (See <i>Replacing a toner cartridge</i> on page 126.)</li> <li data-bbox="477 685 1218 743">■ The drum unit may be damaged. Put in a new drum unit. (See <i>Replacing the drum unit</i> on page 130.)</li> </ul> |
|  <p data-bbox="159 1012 400 1039"><b>Line across the page</b></p>                                                          | <ul style="list-style-type: none"> <li data-bbox="477 755 1218 836">■ Clean the laser scanner window and the corona wire inside the drum unit. (See <i>Cleaning the laser scanner window</i> on page 120 and <i>Cleaning the corona wire</i> on page 122.)</li> <li data-bbox="477 852 1218 909">■ The drum unit may be damaged. Put in a new drum unit. (See <i>Replacing the drum unit</i> on page 130.)</li> </ul>                                                                                                                                                                                                                                                                                                                                                                                                                                                                                                                                                                                                              |
|  <p data-bbox="128 1315 430 1416"><b>Black lines down the page<br/>Printed pages have toner stains down the page</b></p> | <ul style="list-style-type: none"> <li data-bbox="477 1052 1218 1134">■ Clean the corona wire inside the drum unit by sliding the green tab. Be sure to return the green tab to the home position (▲). (See <i>Cleaning the corona wire</i> on page 122.)</li> <li data-bbox="477 1149 1218 1207">■ The toner cartridge may be damaged. Put in a new toner cartridge. (See <i>Replacing a toner cartridge</i> on page 126.)</li> <li data-bbox="477 1222 1218 1280">■ The drum unit may be damaged. Put in a new drum unit. (See <i>Replacing the drum unit</i> on page 130.)</li> <li data-bbox="477 1296 1218 1377">■ The fuser unit may be smudged. Call Brother Customer Service at 1-877-BROTHER (1-877-276-8437) (in USA) or 1-877-BROTHER (in Canada).</li> </ul>                                                                                                                                                                                                                                                           |

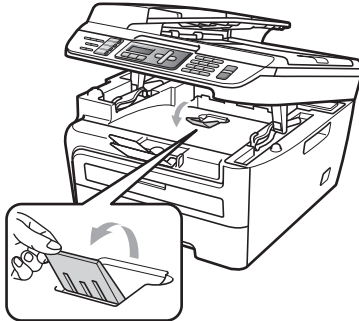
| Examples of poor print quality                                                                                              | Recommendation                                                                                                                                                                                                                                                                                                                                                                                                                                                                                                                                                                                                                                                                                                                                                                                                      |
|-----------------------------------------------------------------------------------------------------------------------------|---------------------------------------------------------------------------------------------------------------------------------------------------------------------------------------------------------------------------------------------------------------------------------------------------------------------------------------------------------------------------------------------------------------------------------------------------------------------------------------------------------------------------------------------------------------------------------------------------------------------------------------------------------------------------------------------------------------------------------------------------------------------------------------------------------------------|
|  <p style="text-align: center;">Curled</p> | <ul style="list-style-type: none"> <li>■ Choose <b>Reduce Paper Curl</b> mode in the printer driver when you do not use our recommended paper. (See <i>Device Options (For Windows®)</i> or <i>Print Settings (For Macintosh®)</i> in the <i>Software User's Guide on the CD-ROM.</i>)</li> <li>■ Turn the paper over in the paper tray, and print again. (Excluding Letterhead paper)</li> <li>■ Lift up the output tray support flap.</li> </ul>  <ul style="list-style-type: none"> <li>■ Replace the paper in the paper tray with paper from a freshly opened ream.</li> <li>■ Make sure you are using paper that is recommended for your machine. (See <i>Acceptable paper and other print media</i> on page 14.)</li> </ul> |

## Setting dial tone detection

Setting the dial tone to *Detection* will shorten the dial tone detect pause.

- 1 (USA) Press **Menu, 0, 4.**  
(Canada) Press **Menu, 0, 5.**

Initial Setup  
4.Dial Tone

- 2 Press **▲** or **▼** to choose *Detection* or *No Detection*.  
Press **OK**.
- 3 Press **Stop/Exit**.

## Telephone line interference

---

If you are having difficulty sending or receiving a fax due to possible interference on the telephone line, we recommend that you adjust the Equalization for compatibility to reduce the modem speed for fax operations.

- 1 Press **Menu**, **2**, **0**, **1**.

```
Miscellaneous
1.Compatibility
```

- 2 Press **▲** or **▼** to choose **Basic (for VoIP)** or **Normal** or **High (MFC-7840W)**.

- **Basic (for VoIP)** cuts the modem speed to 9600 bps. and turns the error correction mode (ECM) off.

For a standard telephone line: If you regularly experience interference on your standard telephone line try this setting.

If you are using VoIP: VoIP service providers offer fax support using various standards. If you regularly experience fax transmission errors try this setting.

- **Normal** sets the modem speed at 14400 bps.
- **High** sets the modem speed at 33600 bps. (MFC-7840W only)

Press **OK**.

- 3 Press **Stop/Exit**.



### Note

---

When you change the compatibility to **Basic (for VoIP)**, the ECM feature is not available.

---



## Error and maintenance messages

As with any sophisticated office product, errors may occur and consumable items may need to be replaced. If this happens, your machine identifies the error or required routine maintenance and shows the appropriate message. The most common error and maintenance messages are shown below.

You can correct most errors and routine maintenance by yourself. If you need more help, the Brother Solutions Center offers the latest FAQs and troubleshooting tips.

Visit us at <http://solutions.brother.com/>.

| Error Message   | Cause                                                               | Action                                                                                                                                                                    |
|-----------------|---------------------------------------------------------------------|---------------------------------------------------------------------------------------------------------------------------------------------------------------------------|
| Cartridge Error | The toner cartridge is not installed properly.                      | Pull out the drum unit, take out the toner cartridge that is indicated on the LCD, and put it back into the drum unit again.                                              |
| Drum End Soon   | The drum unit is near the end of its life.                          | Use the drum unit until you have a print quality problem; then replace the drum unit with a new one.<br><i>(See <a href="#">Replacing the drum unit</a> on page 130.)</i> |
| Size mismatch   | The paper in the tray is not the correct size.                      | Load the correct size of paper in the tray and set the "Paper Size" ( <b>Menu, 1, 3</b> (See <i>Paper size</i> in Chapter 3)).                                            |
| Comm.Error      | Poor telephone line quality caused a communication error.           | Send the fax again or connect the machine to another telephone line. If the problem continues, call the telephone company and ask them to check your telephone line.      |
| Connection Fail | You tried to poll a fax machine that is not in Polled Waiting mode. | Check the other fax machine's polling setup.                                                                                                                              |

| Error Message                    | Cause                                                                                                                                                                                                                                                                          | Action                                                                                                                                                                                                                                                                                                                                                                                                                                                                                                                                                                                                                                                                                                                                                                                                                                                                                                                                        |
|----------------------------------|--------------------------------------------------------------------------------------------------------------------------------------------------------------------------------------------------------------------------------------------------------------------------------|-----------------------------------------------------------------------------------------------------------------------------------------------------------------------------------------------------------------------------------------------------------------------------------------------------------------------------------------------------------------------------------------------------------------------------------------------------------------------------------------------------------------------------------------------------------------------------------------------------------------------------------------------------------------------------------------------------------------------------------------------------------------------------------------------------------------------------------------------------------------------------------------------------------------------------------------------|
| Cooling Down<br>Wait for a while | The temperature of the drum unit or toner cartridge is too hot. The machine will pause its current print job and go into cooling down mode. During the cooling down mode, you will hear the cooling fan running while the LCD shows <i>Cooling Down, and Wait for a while.</i> | <p>Make sure that you can hear the fan in the machine spinning and that the exhaust outlet is not blocked by something.</p> <p>If the fan is spinning, remove any obstacles that surround the exhaust outlet, and then leave the machine turned on but do not use it for several minutes.</p> <p>If the fan is not spinning do one of the following:</p> <p>(MFC-7340, MFC-7345N and MFC-7440N only)<br/>See <i>Transferring your faxes or Fax Journal report</i> on page 111 before disconnecting the machine so you will not lose any important messages.<br/>Then, disconnect the machine from the power for several minutes and then reconnect it.</p> <p>(MFC-7840W only)<br/>Disconnect the machine from the power for several minutes, then reconnect it. (The machine can be turned off for approximately 4 days without losing faxes stored in the memory. See <i>Transferring your faxes or Fax Journal report</i> on page 111.</p> |
| Cover is Open                    | The front cover is not closed completely.                                                                                                                                                                                                                                      | Close the front cover of the machine.                                                                                                                                                                                                                                                                                                                                                                                                                                                                                                                                                                                                                                                                                                                                                                                                                                                                                                         |
| Cover is Open                    | The fuser cover is not closed completely.                                                                                                                                                                                                                                      | Close the fuser cover of the machine.                                                                                                                                                                                                                                                                                                                                                                                                                                                                                                                                                                                                                                                                                                                                                                                                                                                                                                         |
| Cover is Open                    | The fuser cover is not closed completely or paper was jammed in the back of the machine when you turned on the power.                                                                                                                                                          | Make sure paper is not jammed inside the back of the machine, and then close the fuser cover and press <b>Start</b> .                                                                                                                                                                                                                                                                                                                                                                                                                                                                                                                                                                                                                                                                                                                                                                                                                         |
| Disconnected                     | The other person or other person's fax machine stopped the call.                                                                                                                                                                                                               | Try to send or receive again.                                                                                                                                                                                                                                                                                                                                                                                                                                                                                                                                                                                                                                                                                                                                                                                                                                                                                                                 |
| Document Jam                     | The document was not inserted or fed properly, or the document scanned from the ADF was too long.                                                                                                                                                                              | See <i>Document jams</i> on page 113 or <i>Using the automatic document feeder (ADF)</i> on page 18.                                                                                                                                                                                                                                                                                                                                                                                                                                                                                                                                                                                                                                                                                                                                                                                                                                          |
| DR Mode in Use                   | The machine is set to Distinctive Ring mode. You cannot change the Receive Mode from Manual to another mode.                                                                                                                                                                   | Set Distinctive Ring to <b>Off</b> . (See <i>Turning off distinctive ring</i> on page 46.)                                                                                                                                                                                                                                                                                                                                                                                                                                                                                                                                                                                                                                                                                                                                                                                                                                                    |
| Drum Error                       | The corona wire on the drum unit needs to be cleaned.                                                                                                                                                                                                                          | Clean the corona wire on the drum unit. (See <i>Cleaning the corona wire</i> on page 122.)                                                                                                                                                                                                                                                                                                                                                                                                                                                                                                                                                                                                                                                                                                                                                                                                                                                    |
|                                  | The drum unit has reached the end of its life.                                                                                                                                                                                                                                 | Replace the drum unit. (See <i>Replacing the drum unit</i> on page 130.)                                                                                                                                                                                                                                                                                                                                                                                                                                                                                                                                                                                                                                                                                                                                                                                                                                                                      |

| Error Message  | Cause                                                                                                                                  | Action                                                                                                                                                                                                                                                                                                                                                                                                                                                                                                                                                                                                                                                                                                                                                                                                             |
|----------------|----------------------------------------------------------------------------------------------------------------------------------------|--------------------------------------------------------------------------------------------------------------------------------------------------------------------------------------------------------------------------------------------------------------------------------------------------------------------------------------------------------------------------------------------------------------------------------------------------------------------------------------------------------------------------------------------------------------------------------------------------------------------------------------------------------------------------------------------------------------------------------------------------------------------------------------------------------------------|
| Fuser Error    | <p>The temperature of fuser unit does not rise at a specified temperature within specified time.</p> <p>The fuser unit is too hot.</p> | <ul style="list-style-type: none"> <li>■ (MFC-7340, MFC-7345N and MFC-7440N only)<br/>Received fax messages still in memory will be lost when the machine is turned off. See <i>Transferring your faxes or Fax Journal report</i> on page 111 before disconnecting the machine so you will not lose any important messages. Then, turn the power switch off, wait a few seconds, and then turn it on again. Leave the machine for 15 minutes with the power on.</li> <li>■ (MFC-7840W only)<br/>Turn the power switch off, wait a few seconds, and then turn it on again. Leave the machine for 15 minutes with the power on. The machine can be turned off for approximately 4 days without losing faxes stored in the memory. (See <i>Transferring your faxes or Fax Journal report</i> on page 111.)</li> </ul> |
| Init Unable XX | The machine has a mechanical problem.                                                                                                  | <p>Do one of the following:</p> <ul style="list-style-type: none"> <li>■ (MFC-7340, MFC-7345N and MFC-7440N only)<br/>See <i>Transferring your faxes or Fax Journal report</i> on page 111 before disconnecting the machine so you will not lose any important messages. Then, disconnect the machine from the power for several minutes and then reconnect it.</li> <li>■ (MFC-7840W only)<br/>Disconnect the machine from the power for several minutes, then reconnect it. (The machine can be turned off for approximately 4 days without losing faxes stored in the memory. See <i>Transferring your faxes or Fax Journal report</i> on page 111.)</li> </ul>                                                                                                                                                 |
| Jam Rear       | The paper is jammed in the back of the machine.                                                                                        | (See <i>Paper jams</i> on page 114.)                                                                                                                                                                                                                                                                                                                                                                                                                                                                                                                                                                                                                                                                                                                                                                               |
| Jam Inside     | The paper is jammed inside the machine.                                                                                                | (See <i>Paper jams</i> on page 114.)                                                                                                                                                                                                                                                                                                                                                                                                                                                                                                                                                                                                                                                                                                                                                                               |
| Jam Tray       | The paper is jammed in the paper tray of the machine.                                                                                  | (See <i>Paper jams</i> on page 114.)                                                                                                                                                                                                                                                                                                                                                                                                                                                                                                                                                                                                                                                                                                                                                                               |
| No Paper       | The machine is out of paper or paper is not properly loaded in the paper tray.                                                         | <p>Do one of the following:</p> <ul style="list-style-type: none"> <li>■ Refill the paper in the paper tray, and then press <b>Start</b>.</li> <li>■ Remove the paper and load it again, and then press <b>Start</b>.</li> </ul>                                                                                                                                                                                                                                                                                                                                                                                                                                                                                                                                                                                   |



| Error Message    | Cause                                                                        | Action                                                                                                                                                                                                                                                                                                                                                                                                                                                                                                                                                                                                                                                                                                                                      |
|------------------|------------------------------------------------------------------------------|---------------------------------------------------------------------------------------------------------------------------------------------------------------------------------------------------------------------------------------------------------------------------------------------------------------------------------------------------------------------------------------------------------------------------------------------------------------------------------------------------------------------------------------------------------------------------------------------------------------------------------------------------------------------------------------------------------------------------------------------|
| No Response/Busy | The number you dialed does not answer or is busy.                            | Verify the number and try again.                                                                                                                                                                                                                                                                                                                                                                                                                                                                                                                                                                                                                                                                                                            |
| Not Registered   | You tried to access a One Touch or Speed Dial number that is not programmed. | Set up the One Touch or Speed Dial number.<br>(See <i>Storing one touch dial numbers</i> on page 54 and <i>Storing speed dial numbers</i> on page 55.)                                                                                                                                                                                                                                                                                                                                                                                                                                                                                                                                                                                      |
| Out of Memory    | The machine's memory is full.                                                | <p><b>Fax sending or copy operation in progress</b></p> <p>Do one of the following:</p> <ul style="list-style-type: none"> <li>■ Press <b>Start</b> to send or copy the scanned pages.</li> <li>■ Press <b>Stop/Exit</b> and wait until the other operations in progress finish, and then try again.</li> <li>■ Clear the data from the memory. (See <i>Out of memory message</i> on page 38 or page 75.)</li> </ul> <p><b>Print operation in process</b></p> <p>Do one of the following:</p> <ul style="list-style-type: none"> <li>■ Reduce print resolution. (See <i>Advanced tab in the Software User's Guide on the CD-ROM.</i>)</li> <li>■ Clear the faxes from the memory. (See <i>Out of memory message</i> on page 75.)</li> </ul> |
| Print Unable XX  | The machine has a mechanical problem.                                        | <p>Do one of the following:</p> <ul style="list-style-type: none"> <li>■ (MFC-7340, MFC-7345N and MFC-7440N only)<br/>See <i>Transferring your faxes or Fax Journal report</i> on page 111 before disconnecting the machine so you will not lose any important messages. Then, disconnect the machine from the power for several minutes and then reconnect it.</li> <li>■ (MFC-7840W only)<br/>Disconnect the machine from the power for several minutes, then reconnect it. (The machine can be turned off for approximately 4 days without losing faxes stored in the memory. See <i>Transferring your faxes or Fax Journal report</i> on page 111.)</li> </ul>                                                                          |

| Error Message  | Cause                                                                                                                                                    | Action                                                                                                                                                                                                                                                                                                                                                                                                                                                                                                                                                                                                                                                      |
|----------------|----------------------------------------------------------------------------------------------------------------------------------------------------------|-------------------------------------------------------------------------------------------------------------------------------------------------------------------------------------------------------------------------------------------------------------------------------------------------------------------------------------------------------------------------------------------------------------------------------------------------------------------------------------------------------------------------------------------------------------------------------------------------------------------------------------------------------------|
| Scan Unable XX | The machine has a mechanical problem.                                                                                                                    | Do one of the following: <ul style="list-style-type: none"> <li>■ (MFC-7340, MFC-7345N and MFC-7440N only)<br/>See <i>Transferring your faxes or Fax Journal report</i> on page 111 before disconnecting the machine so you will not lose any important messages. Then, disconnect the machine from the power for several minutes and then reconnect it.</li> <li>■ (MFC-7840W only)<br/>Disconnect the machine from the power for several minutes, then reconnect it. (The machine can be turned off for approximately 4 days without losing faxes stored in the memory. See <i>Transferring your faxes or Fax Journal report</i> on page 111.)</li> </ul> |
| Toner Life End | The drum unit and toner cartridge assembly may have been installed improperly, or the toner cartridge is used up and printing is not possible.           | Do one of the following: <ul style="list-style-type: none"> <li>■ Re-install the toner cartridge and drum unit assembly.</li> <li>■ Replace the toner cartridge with a new one. (See <i>Replacing a toner cartridge</i> on page 126.)</li> </ul>                                                                                                                                                                                                                                                                                                                                                                                                            |
| Toner Low      | If the LCD shows <code>Toner Low</code> , you can still print; however, the machine is telling you that the toner cartridge is near the end of its life. | Order a new toner cartridge now.                                                                                                                                                                                                                                                                                                                                                                                                                                                                                                                                                                                                                            |

## Transferring your faxes or Fax Journal report

If the LCD shows:

- Init Unable XX
- Print Unable XX
- Scan Unable XX

We recommend transferring your faxes to another fax machine or to your PC. (See *Transferring faxes to another fax machine* on page 112 or *Transferring faxes to your PC* on page 112.)

You can also transfer the Fax Journal report to see if there are any faxes you need to transfer. (See *Transferring Fax Journal report to another fax machine* on page 112.)



### Note

If there is an error message on the machine's LCD, after the faxes have been transferred, disconnect the machine from the power source for several minutes, and then reconnect it.

## Transferring faxes to another fax machine

If you have not set up your Station ID, you cannot enter fax transfer mode. (See *Setting your station ID in the Quick Setup Guide.*)

- 1 Press **Menu, 9, 0, 1.**
- 2 Do one of the following:
  - If the LCD shows **No Data**, there are no faxes left in the machine's memory. Press **Stop/Exit.**
  - Enter the fax number to which faxes will be forwarded.
- 3 Press **Start.**

## Transferring faxes to your PC

You can transfer the faxes from your machine's memory to your PC.

- 1 Make sure that you have installed **MFL-Pro Suite** on your PC, and then turn on **PC-Fax Receiving** on the PC. (For details about PC Fax Receive, see *PC-FAX receiving in the Software User's Guide on the CD-ROM.*)
- 2 Make sure that you have set **PC Fax Receive** on the machine. (See *PC fax receive* on page 60.) If faxes are in the machine's memory when you set up PC Fax Receive, the LCD will ask if you want to transfer the faxes to your PC.
- 3 Do one of the following:
  - To transfer all faxes to your PC, press **1**. You will be asked if you want a backup print.
  - To exit and leave the faxes in the memory, press **2**.
- 4 Press **Stop/Exit.**

## Transferring Fax Journal report to another fax machine

If you have not set up your Station ID, you cannot enter fax transfer mode. (See *Setting your station ID in the Quick Setup Guide.*)

- 1 Press **Menu, 9, 0, 2.**
- 2 Enter the fax number to which Fax Journal report will be forwarded.
- 3 Press **Start.**

## Document jams

If the document is jammed, follow the steps below.



### Note

After removing a jammed document, check that no paper scraps are left in the machine that could cause another jam.

### Document is jammed in the top of the ADF unit

- 1 Take out any paper from the ADF that is not jammed.
- 2 Open the ADF cover.
- 3 Pull the jammed document out to the left.

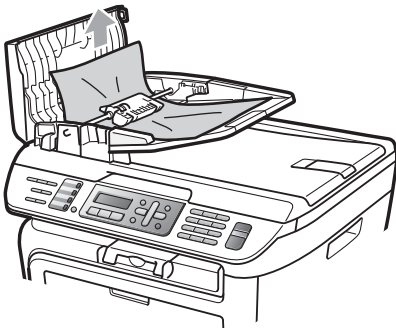

- 4 Close the ADF cover.
- 5 Press **Stop/Exit**.

### Document is jammed under the document cover

- 1 Take out any paper from the ADF that is not jammed.
- 2 Lift the document cover.
- 3 Pull the jammed document out to the right.

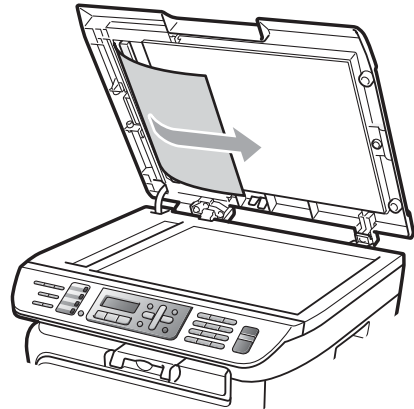

- 4 Close the document cover.
- 5 Press **Stop/Exit**.

### Document is jammed at the output tray

- 1 Pull the jammed document out to the right.

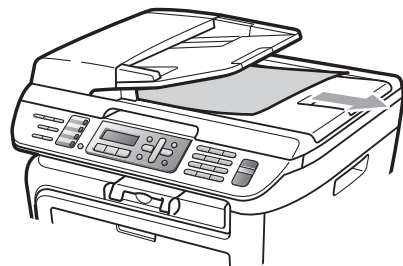

- 2 Press **Stop/Exit**.

## Paper jams

To clear paper jams, please follow the steps in this section.

### Note

- Please confirm that you have installed both a toner cartridge and a drum unit in the machine. If you have not installed a drum unit or have installed the drum unit improperly, then this may cause a paper jam in your Brother machine.
- If the error message remains, open and close the front cover and fuser cover firmly to reset the machine.

### WARNING

#### HOT SURFACE

After you have just used the machine, some internal parts of the machine will be extremely hot. When you open the front or back cover (back output tray) of the machine, DO NOT touch the shaded parts shown in the illustration. If you do this, you may get burned.

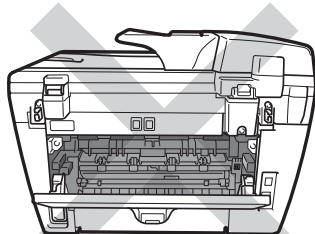
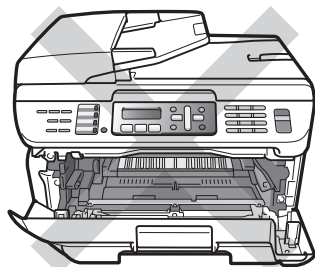

### CAUTION

To prevent damage to the machine caused by static electricity, DO NOT touch the electrodes shown in the illustration.

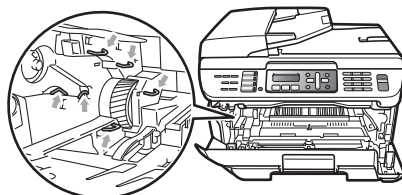

## Paper is jammed inside the machine

- 1 Open the front cover.



- 2 Slowly take out the drum unit and toner cartridge assembly. The jammed paper will be pulled out with the toner cartridge and drum unit assembly.

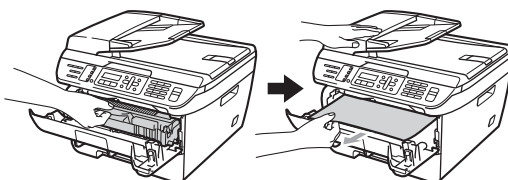

### CAUTION

We recommend that you place the drum unit and toner cartridge assembly on a clean, flat surface with a sheet of disposable paper or cloth underneath it in case you accidentally spill or scatter toner.



- 3** Do one of the following:
- If you were able to remove the drum unit and toner cartridge assembly and the jammed paper, then go to step **7**.
  - If you can not remove the drum unit and toner cartridge assembly easily, do not use extra force. Instead, lift the scanner cover.

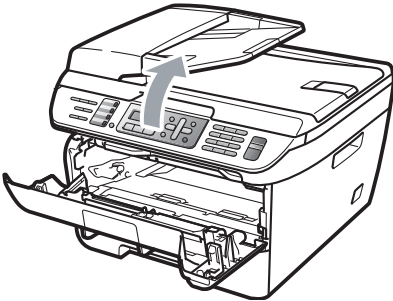

Use both hands to carefully pull the jammed paper up and out of the output tray opening.

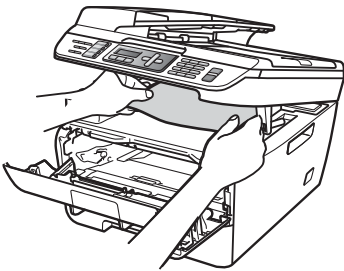

- 4** Close the scanner cover.

- 5** If you could not pull the jammed paper out of the output tray opening as shown in the step **3**, take the paper tray completely out of the machine.

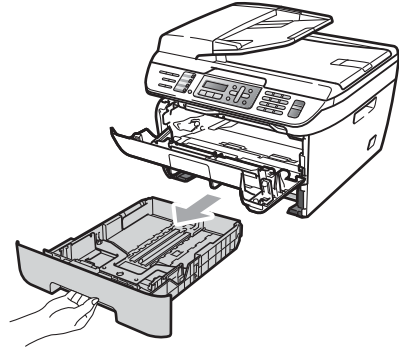

- 6** Pull the jammed paper out of the paper tray opening.

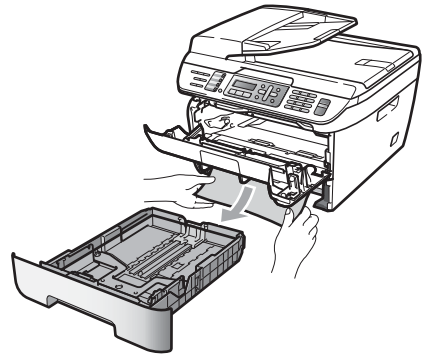

- 7** Put the drum unit and toner cartridge assembly back in the machine.

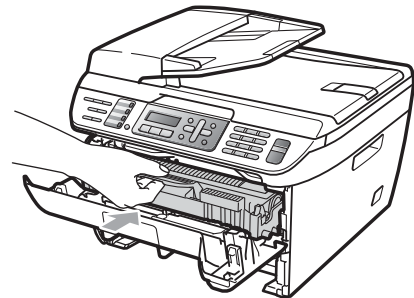

- 8** Put the paper tray back in the machine.

- 9** Close the front cover.

## Paper is jammed at the back of the machine

- 1 Open the front cover.

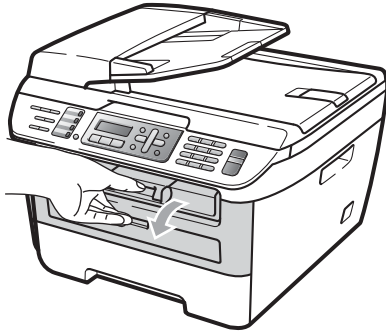

- 2 Slowly take out the drum unit and toner cartridge assembly.

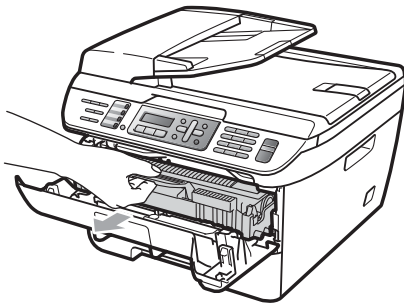

### ! CAUTION

We recommend that you place the drum unit and toner cartridge assembly on a clean, flat surface with a sheet of disposable paper or cloth underneath it in case you accidentally spill or scatter toner.

- 3 Open the back cover (back output tray).

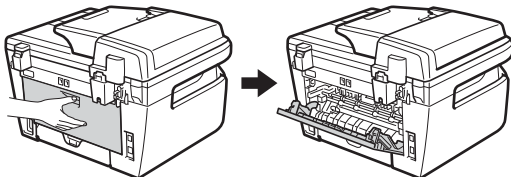

- 4 Pull the tabs (1) toward you to open the fuser cover (2).

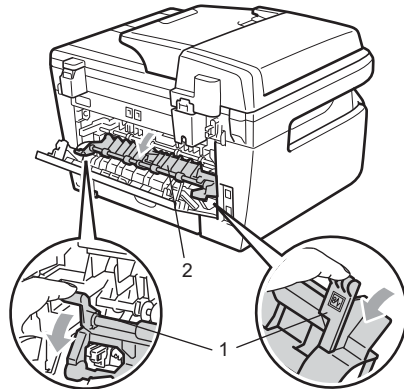

- 5 Pull the jammed paper out of the fuser unit.

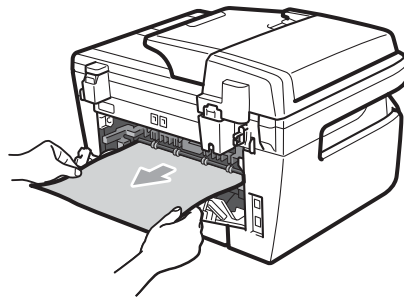

- 6 Close the back cover (back output tray).

- 7 Put the drum unit and toner cartridge assembly back in the machine.

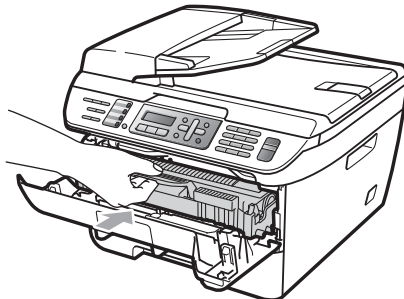

- 8 Close the front cover.

### Paper is jammed inside the drum unit and toner cartridge assembly

- 1 Open the front cover.

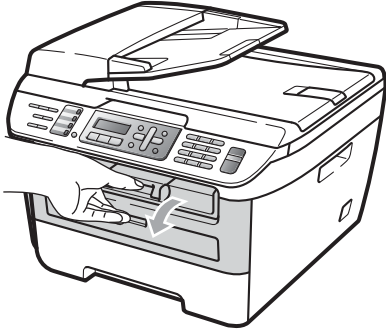

- 2 Slowly take out the drum unit and toner cartridge assembly.

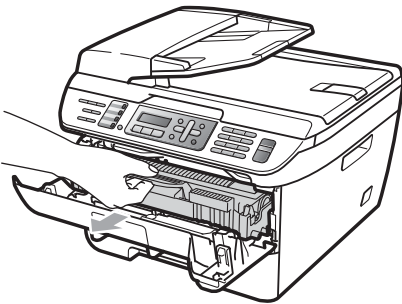

#### ! CAUTION

We recommend that you place the drum unit and toner cartridge assembly on a clean, flat surface with a sheet of disposable paper or cloth underneath it in case you accidentally spill or scatter toner.

- 3 Push down the green lock lever and take the toner cartridge out of the drum unit.

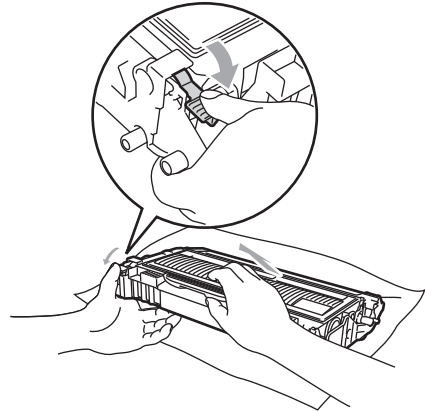

#### ! CAUTION

Handle the toner cartridge carefully. If toner scatters on your hands or clothes, wipe or wash it off with cold water at once.

To avoid print quality problems, DO NOT touch the shaded parts shown in the illustrations below.

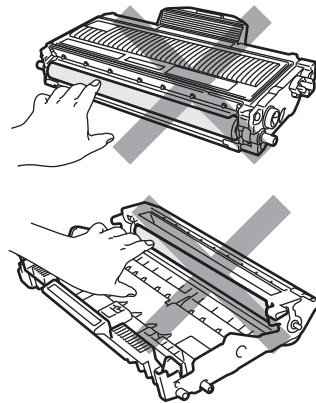

- 4 Clear the jammed paper if there is any inside the drum unit.

- 5 Put the toner cartridge back into the drum unit until you hear it lock into place. If you put it in properly, the green lock lever will lift automatically.

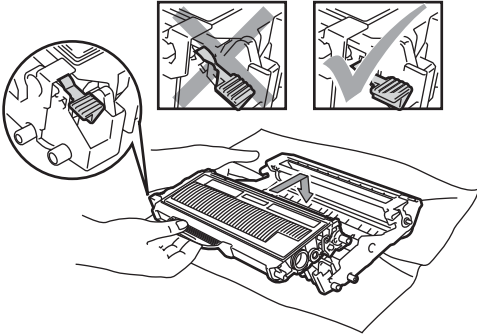

- 6 Put the drum unit and toner cartridge assembly back in the machine.

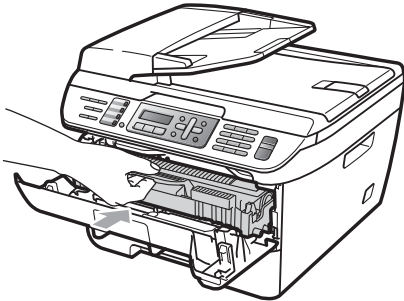

- 7 Close the front cover.

## Routine maintenance

### WARNING

Use neutral detergents.

DO NOT use cleaning materials that contain ammonia, alcohol, any type of spray, or any type of flammable substance to clean the outside or inside of the machine. Doing this may cause a fire or electrical shock. For more information see *Important safety instructions* on page 90

### CAUTION

The drum unit contains toner, so handle it carefully. If toner scatters on your hands or clothes, wipe or wash it off with cold water at once.

## Cleaning the outside of the machine

- 1 Turn off the machine's power switch. Unplug the telephone line cord first, disconnect all cables, and then unplug the power cord from the AC power outlet.
- 2 Pull the paper tray completely out of the machine.

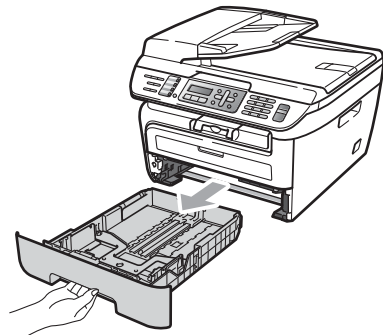

- Wipe the outside of the machine with a soft cloth to remove dust.

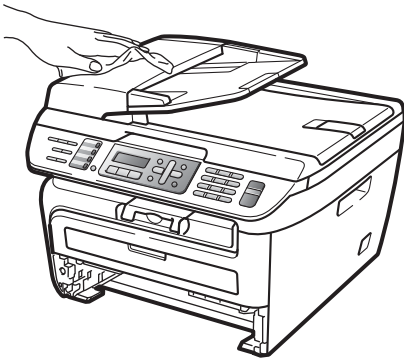

- Remove anything that is stuck inside the paper tray.

- Wipe the inside and the outside of the paper tray with a soft cloth to remove dust.

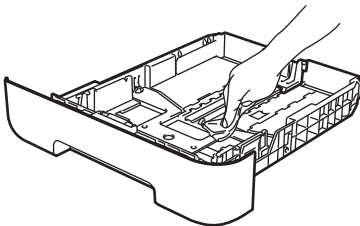

- Re-load the paper and put the paper tray firmly back in the machine.

- Plug the machine's power cord back into the AC power outlet first, and reconnect all cables and telephone line cord. Turn on the machine's power switch.

## Cleaning the scanner glass

- Turn off the machine's power switch. Unplug the telephone line cord first, disconnect all cables and then unplug the power cord from the AC power outlet.
- Lift the document cover (1). Clean the white plastic surface (2) and scanner glass (3) underneath it with a soft lint-free cloth moistened with water.

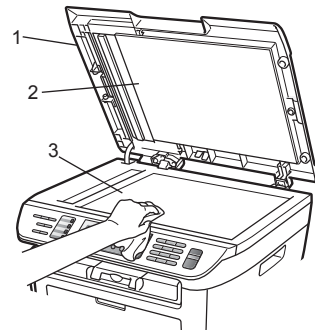

- In the ADF unit, clean the white bar (1) and the scanner glass strip (2) underneath it with a soft lint-free cloth moistened with water.

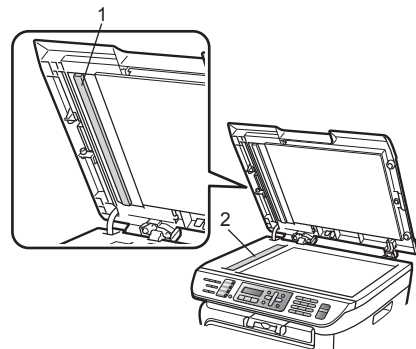

- 4 Plug the machine's power cord back into the AC power outlet first, and reconnect all cables and telephone line cord. Turn on the machine's power switch.

 **Note**

In addition to cleaning the scanner glass and glass strip with a soft lint-free cloth moistened with water, run your finger tip over the glass to see if you can feel anything on it. If you feel dirt or debris, clean the glass again concentrating on that area. You may need to repeat the cleaning process three or four times. To test, make a copy after each cleaning.

## Cleaning the laser scanner window

 **WARNING**

DO NOT use isopropyl alcohol to clean the laser scanner window.

 **CAUTION**

DO NOT touch the laser scanner window with your fingers.

- 1 Before you clean the inside of the machine, turn off the machine's power switch. Unplug the telephone line cord first, and then unplug the power cord from the AC power outlet.

- 2 Open the front cover and slowly take out the drum unit and toner cartridge assembly.

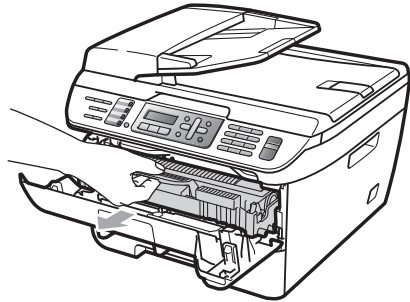
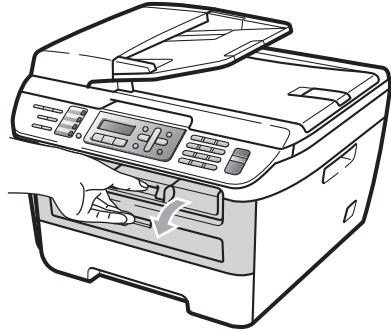

 **WARNING**

 **HOT SURFACE**

After you have just used the machine, some internal parts of the machine will be extremely hot. When you open the front or back cover (back output tray) of the machine, DO NOT touch the shaded parts shown in the illustration. If you do this, you may get burned.

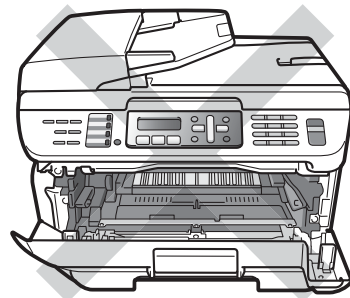

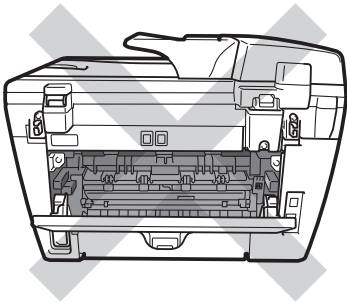

**!** CAUTION

To prevent damage to the machine caused by static electricity, **DO NOT** touch the electrodes shown in the illustration.

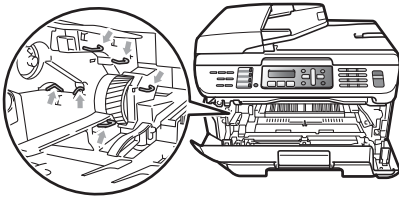

We recommend that you place the drum unit on a clean, flat surface with a sheet of disposable paper or cloth underneath it in case you accidentally spill or scatter toner.

- 3 Wipe the laser scanner window by wiping it with a clean soft, dry lint-free cloth.

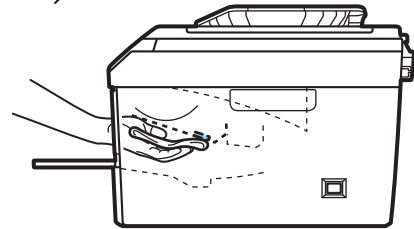
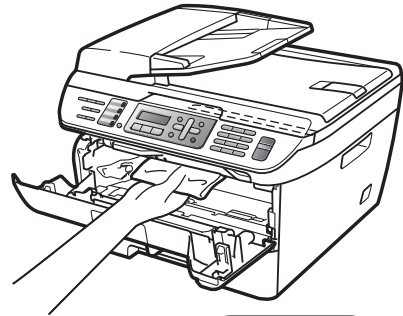

- 4 Put the drum unit and toner cartridge assembly back in the machine.

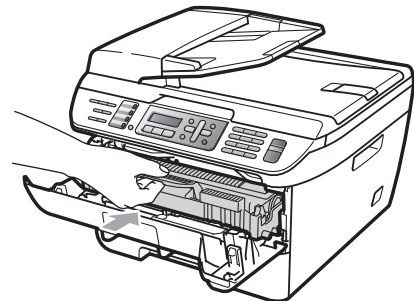

- 5 Close the front cover.
- 6 Plug the machine's power cord back into the AC power outlet first, and then plug in the telephone line cord. Turn on the machine's power switch.

## Cleaning the corona wire

If you have print quality problems, clean the corona wire as follows:

- 1 Turn off the machine's power switch. Unplug the telephone line cord first, disconnect all cables, and then unplug the power cord from the AC power outlet.
- 2 Open the front cover.



- 3 Slowly take out the drum unit and toner cartridge assembly.

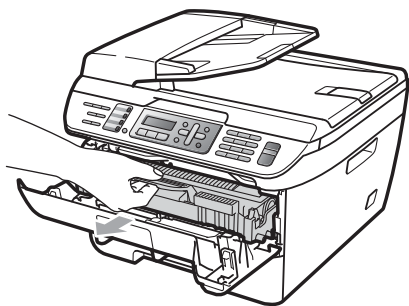

### ! CAUTION

We recommend that you place the drum unit and toner cartridge assembly on a clean, flat surface with a sheet of disposable paper or cloth underneath it in case you accidentally spill or scatter toner.

Handle the toner cartridge carefully. If toner scatters on your hands or clothes, wipe or wash it off with cold water at once.

To prevent damage to the machine caused by static electricity, DO NOT touch the electrodes shown in the illustration.

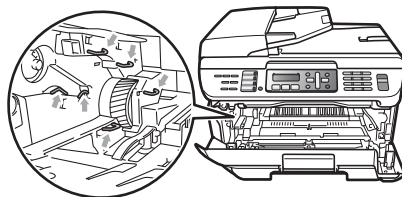

- 4 Clean the corona wire inside the drum unit by gently sliding the green tab from right to left and left to right several times.

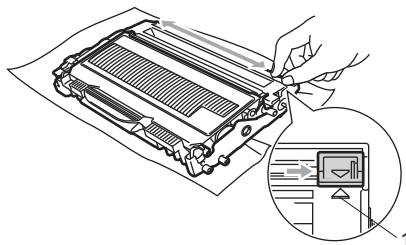

### ! CAUTION

Be sure to return the green tab to the home position (▲) (1). If you do not, printed pages may have a vertical stripe.

- 5 Put the drum unit and toner cartridge assembly back in the machine.

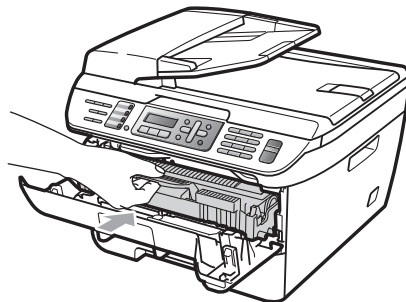

- 6 Close the front cover.



- 7 Plug the machine's power cord back into the AC power outlet first, and then reconnect all cables and telephone line cord. Turn on the machine's power switch.

**! CAUTION**

To avoid print quality problems, DO NOT touch the shaded parts shown in the illustrations below.

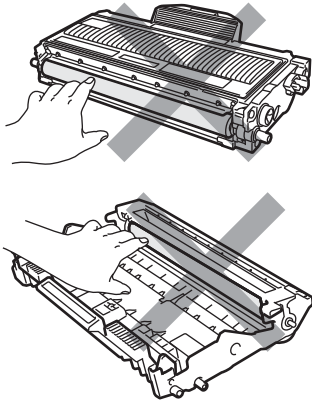

## Cleaning the drum unit

If you have print quality problems, clean the drum unit as follows.

- 1 Turn off the machine's power switch. Unplug the telephone line cord first, and then unplug the power cord from the AC power outlet.

- 2 Open the front cover.

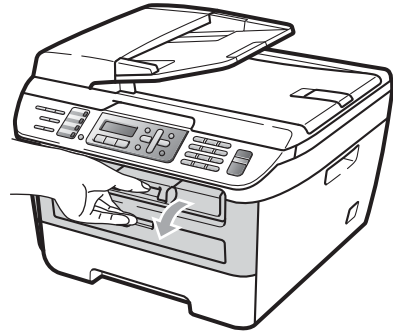

- 3 Slowly take out the drum unit and toner cartridge assembly.

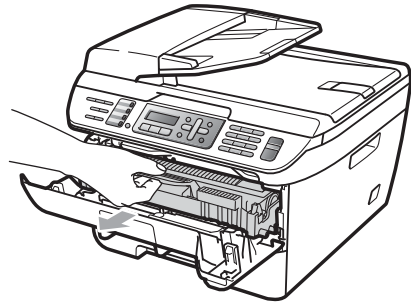

**! CAUTION**

We recommend that you put the drum unit and toner cartridge assembly on a clean, flat surface with a sheet of disposable paper or cloth underneath it in case you accidentally spill or scatter toner.

---

To prevent damage to the machine caused by static electricity, **DO NOT** touch the electrodes shown in the illustration.

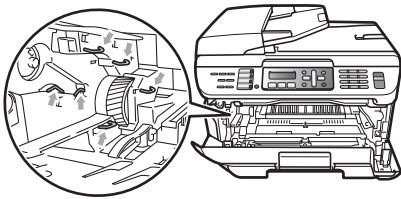

- 4** Push down the green lock lever and take the toner cartridge out of the drum unit.

**! CAUTION**

Handle the toner cartridge carefully. If toner scatters on your hands or clothes, wipe or wash it off with cold water at once.

---

To avoid print quality problems, **DO NOT** touch the shaded parts shown in the illustrations below.

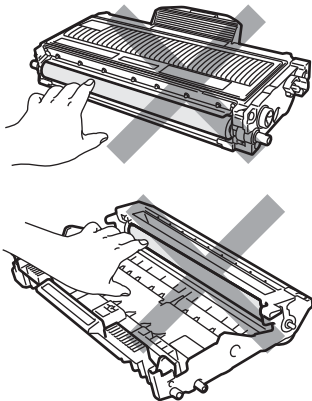

- 5** Put the print sample in front of the drum unit, and find the exact position of the poor print.

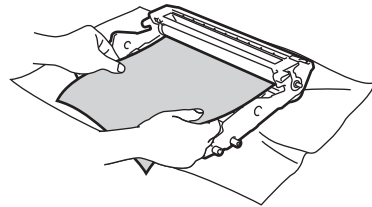

- 6** Turn the drum unit gear by hand while looking at the surface of the OPC drum (1).

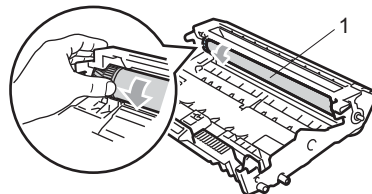

- 7** When you have found the mark on the drum that matches the print sample, wipe the surface of the OPC drum with a dry cotton swab until the dust or glue on the surface comes off.

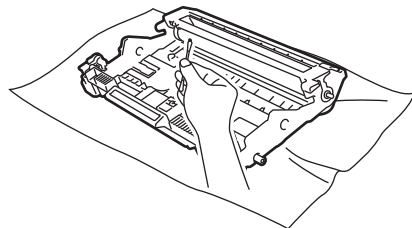

**! CAUTION**

The drum is photosensitive so **DO NOT** touch it with your fingers.

---

**DO NOT** clean the surface of the photosensitive drum with a sharp object.

---

**DO NOT** use a scrubbing or wiping motion because this might damage the drum.

---

- 8 Put the toner cartridge back into the drum unit until you hear it lock into place. If you put the cartridge in properly, the green lock lever will lift automatically.

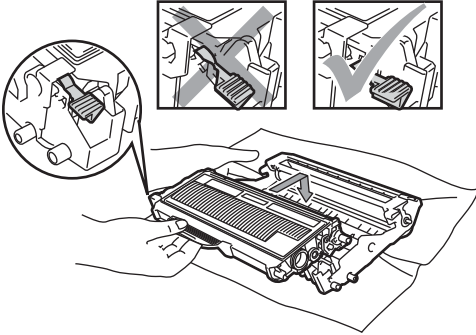

- 9 Put the drum unit and toner cartridge assembly back in the machine.

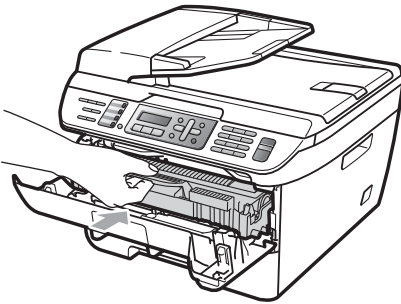

- 10 Close the front cover.
- 11 Plug the machine's power cord back into the AC power outlet first, and then reconnect all cables and telephone line cord. Turn on the machine's power switch.

# Replacing the consumable items

You will need to replace the consumable items when the machine indicates that the life of the consumable is over.

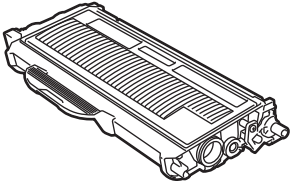
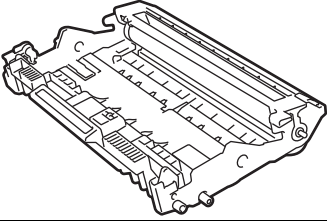
| Toner cartridge                                                                   | Drum unit                                                                          |
|-----------------------------------------------------------------------------------|------------------------------------------------------------------------------------|
|  |  |
| Order No. TN-330, TN-360                                                          | Order No. DR-360                                                                   |

## Note

- Go to <http://www.brother.com/original/index.html> for instructions on how to return your used consumable items to the Brother collection program. If you choose not to return your used consumable, please discard the used consumable according to local regulations, keeping it separate from domestic waste. If you have questions, call your local waste disposal office. Be sure to reseal the consumable items tightly so that the material inside does not spill.
- We recommend placing used consumable items on a sheet of paper to prevent accidentally spilling or scattering the material inside.
- If you use paper that is not a direct equivalent for the recommended paper, the life of consumable items and machine parts may be reduced.

## Replacing a toner cartridge

The High Yield toner cartridges can print approximately 2,600 pages<sup>1</sup> and the Standard toner cartridges can print approximately 1,500 pages<sup>1</sup>. Actual page count will vary depending on your average type of document (i.e., standard letter, detailed graphics).

The machine is supplied with the Starter toner cartridge that will need to be replaced after approximately 1,000 pages<sup>1</sup>. When a toner cartridge is running low, the LCD shows Toner Low.

<sup>1</sup> Approx. cartridge yield is declared in accordance with ISO/IEC 19752.

## Note

It is a good idea to keep a new toner cartridge ready for use when you see the Toner Low warning.

**! WARNING**

**! HOT SURFACE**

After you have just used the machine, some internal parts of the machine will be extremely hot. When you open the front or back cover (back output tray) of the machine, DO NOT touch the shaded parts shown in the illustration. If you do this, you may get burned.

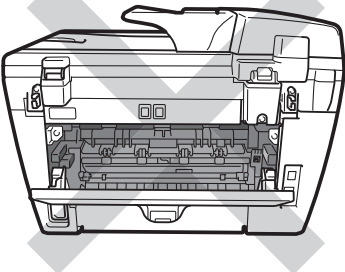
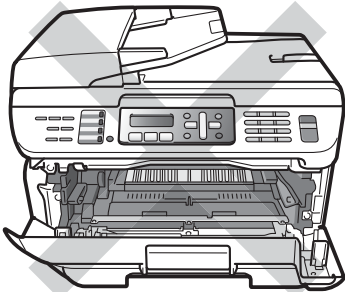

- 1 Open the front cover.

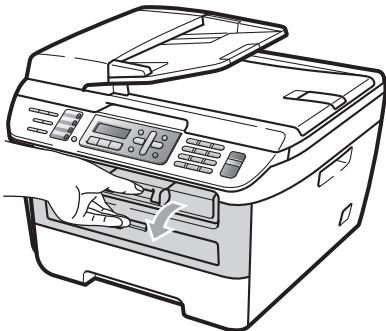

- 2 Slowly take out the drum unit and toner cartridge assembly.

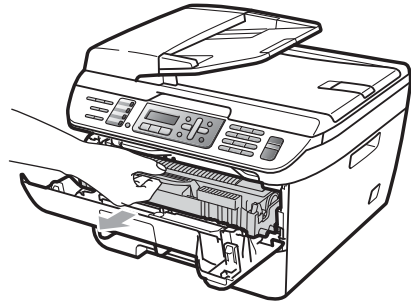

**! CAUTION**

We recommend that you put the drum unit and toner cartridge assembly on a clean, flat surface with a sheet of disposable paper or cloth underneath it in case you accidentally spill or scatter toner.

To prevent damage to the machine caused by static electricity, DO NOT touch the electrodes shown in the illustration.

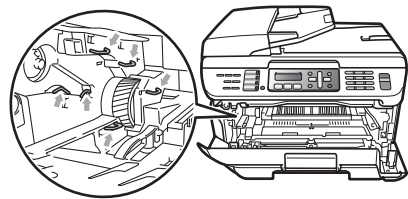

- 3 Push down the green lock lever and take the used toner cartridge out of the drum unit.

**! WARNING**

DO NOT put a toner cartridge into a fire. It could explode, resulting in injuries.

**! CAUTION**

Handle the toner cartridge carefully. If toner scatters on your hands or clothes, wipe or wash it off with cold water at once.

To avoid print quality problems, DO NOT touch the shaded parts shown in the illustrations.

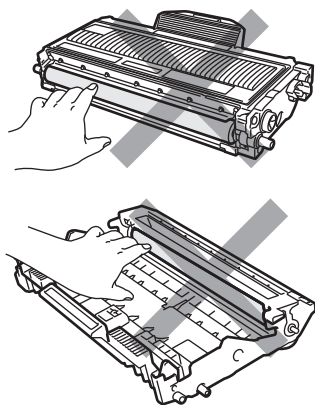

Brother strongly recommends that you DO NOT refill the toner cartridge provided with your machine. We also strongly recommend that you continue to use only Genuine Brother Brand replacement toner cartridge. Use or attempted use of potentially incompatible toner and/or cartridge in the Brother machine may cause damage to the machine and/or may result in unsatisfactory print quality. Our warranty coverage does not apply to any problem that is caused by the use of unauthorized third party toner and/or cartridge. To protect your investment and obtain premium performance from the Brother machine, we strongly recommend the use of Genuine Brother Supplies.

Wait to unpack the new toner cartridge until immediately before you put it in the machine. If a toner cartridge is left unpacked for a long time, the toner life will be shortened.

**Note**

Be sure to seal up the used toner cartridge tightly in a suitable bag so that toner powder does not spill out of the cartridge.

- 4 Unpack the new toner cartridge. Hold the cartridge level with both hands and gently rock it from side to side five or six times to spread the toner evenly inside the cartridge.

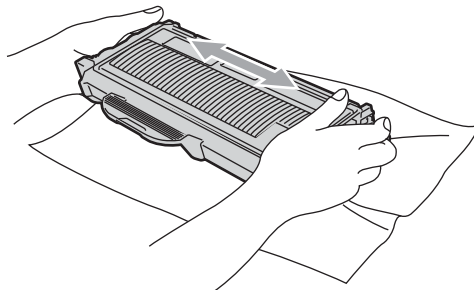

- 5 Pull off the protective cover.

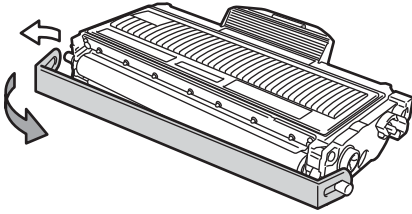

- 6 Put the new toner cartridge firmly into the drum unit until you hear it lock into place. If you put it in properly, the lock lever will lift automatically.

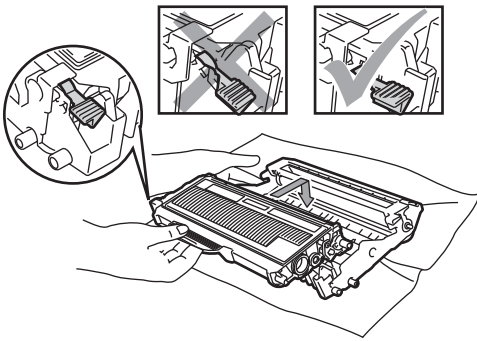

**! CAUTION**

Make sure that you put in the toner cartridge properly or it may separate from the drum unit.

- 7 Clean the corona wire of the drum unit by gently sliding the green tab from right to left and left to right several times.

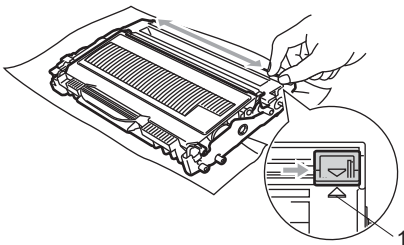

**! CAUTION**

Be sure to return the green tab to the home position (▲) (1). If you do not, printed pages may have a vertical stripe.

- 8 Put the drum unit and toner cartridge assembly back in the machine.

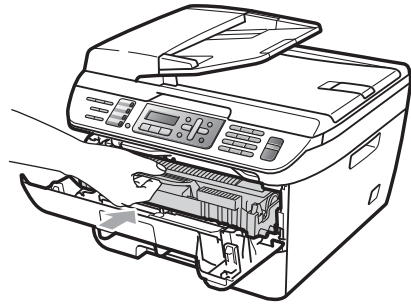

- 9 Close the front cover.

**! CAUTION**

DO NOT turn off the machine's power switch or open the front cover until the LCD returns to the standby state.

## Replacing the drum unit

The machine uses a drum unit to create print images on paper. If the LCD shows *Drum End Soon*, the drum unit is near the end of its life and it is time to buy a new one. Even if the LCD shows *Drum End Soon*, you may be able to continue printing without having to replace the drum unit for a while. However, if there is a noticeable deterioration in the output print quality (even before *Drum End Soon* appears), then the drum unit should be replaced. You should clean the machine when you replace the drum unit. (See *Cleaning the laser scanner window* on page 120.)

### CAUTION

While removing the drum unit, handle it carefully because it may contain toner. If toner scatters on your hands or clothes, wipe or wash it off with cold water at once.

### Note

The drum unit is a consumable item, and it is necessary to replace it periodically. There are many factors that determine the actual drum life, such as temperature, humidity, type of paper and how much toner you use for the number of pages per print job. The estimated drum life is approximately 12,000 pages<sup>1</sup>. The actual number of pages your drum will print may be significantly less than this estimate. Because we have no control over the many factors that determine the actual drum life, we cannot guarantee a minimum number of pages that will be printed by your drum.

<sup>1</sup> Drum yield is approximate, and may vary by type of use.

### WARNING

#### HOT SURFACE

After you have just used the machine, some internal parts of the machine will be extremely hot. When you open the front or back cover (back output tray) of the machine, DO NOT touch the shaded parts shown in the illustration. If you do this, you may get burned.

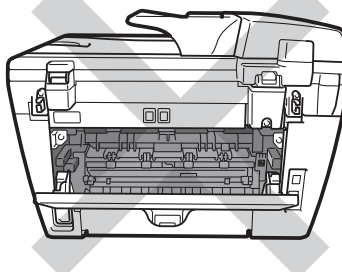
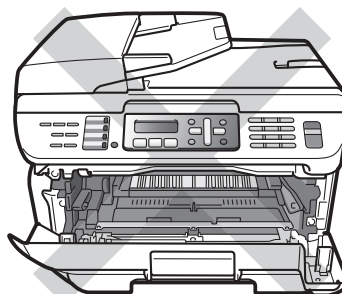

- 1 Open the front cover.

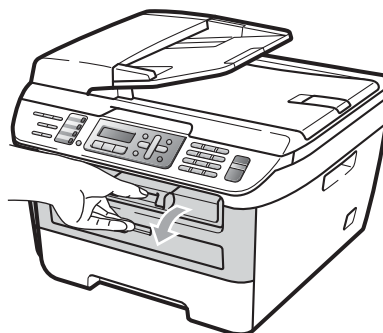



- 2 Slowly take out the drum unit and toner cartridge assembly.

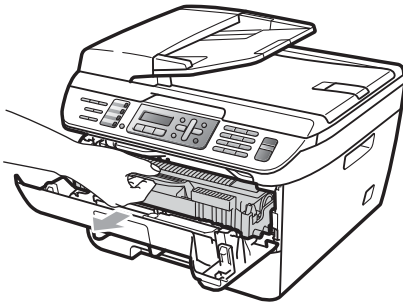

**! CAUTION**

We recommend that you put the drum unit and toner cartridge assembly on a clean, flat surface with a sheet of disposable paper or cloth underneath it in case you accidentally spill or scatter toner.

To prevent damage to the machine caused by static electricity, DO NOT touch the electrodes shown in the illustration.

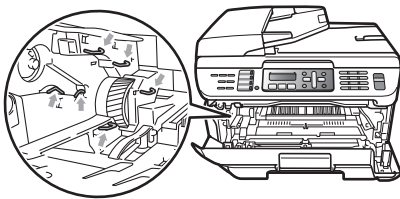

- 3 Push down the green lock lever and take the toner cartridge out of the drum unit.

**! CAUTION**

To avoid print quality problems, DO NOT touch the shaded parts shown in the illustrations.

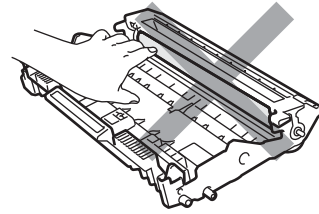
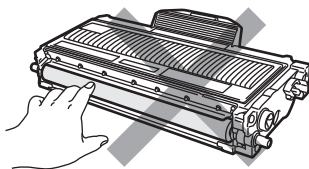

Wait to unpack a new drum unit until immediately before you put it in the machine. Exposure to direct sunlight or room light may damage the drum unit.

**Note**

Be sure to seal up the used drum unit tightly in a bag so that toner powder does not spill out of the unit.

- 4 Unpack the new drum unit.
- 5 Put the toner cartridge firmly into the new drum unit until you hear it lock into place. If you put the cartridge in properly, the green lock lever will lift automatically.

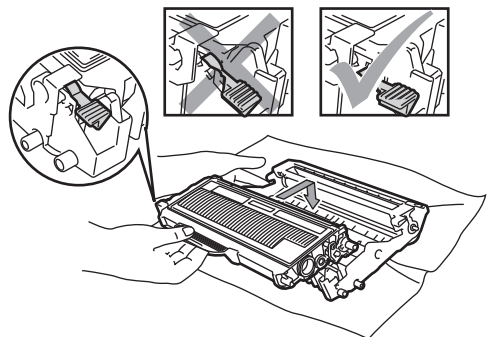

**! CAUTION**

Make sure that you put in the toner cartridge properly or it may separate from the drum unit.

- 6 Clean the corona wire of the drum unit by gently sliding the green tab from right to left and left to right several times.

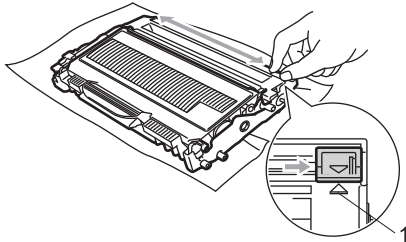

### ! CAUTION

Be sure to return the green tab to the home position (▲) (1). If you do not, printed pages may have a vertical stripe.

- 7 Put the new drum unit and toner cartridge assembly in the machine.

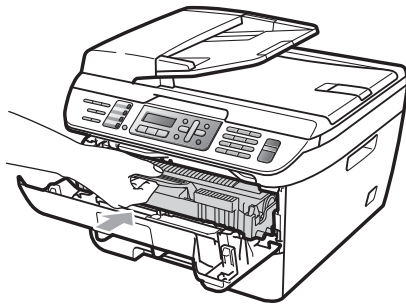

- 8 Press **Clear/Back**.  
To confirm you are installing a new drum, press 1.
- 9 When the LCD shows *Accepted*, close the front cover.

## Machine information

### Checking the serial number

You can see the machine's serial number on the LCD.

- 1 (For MFC-7340) Press **Menu, 4, 1**.  
(For MFC-7345N and MFC-7440N)  
Press **Menu, 5, 1**.  
(For MFC-7840W) Press **Menu, 6, 1**.

```
Machine Info.  
1.Serial No.
```

- 2 Press **Stop/Exit**.

### Checking the page counters

You can see the machine's page counters for copies, printed pages, reports and lists, faxes or a summary total.

- 1 (For MFC-7340) Press **Menu, 4, 2**.  
(For MFC-7345N and MFC-7440N)  
Press **Menu, 5, 2**.  
(For MFC-7840W) Press **Menu, 6, 2**.

```
Machine Info.  
2.Page Counter
```

- 2 Press ▲ or ▼ to choose **Total**,  
**Fax/List**, **Copy** or **Print**.  
You can see the machine's page count.
- 3 Press **Stop/Exit**.

## Checking the Drum life

You can see the machine's drum life on the LCD.

- 1 (For MFC-7340) Press **Menu, 4, 3.**  
(For MFC-7345N and MFC-7440N)  
Press **Menu, 5, 3.**  
(For MFC-7840W) Press **Menu, 6, 3.**

Machine Info.  
3. Drum Life

- 2 Press **OK.**  
You can see the remaining percentage of drum life.
- 3 Press **Stop/Exit.**



### Note

The drum life check will be accurate only if you have reset the drum counter when you installed a *new* drum unit. It will not be accurate if you have reset the drum counter during the life of a *used* drum.

## Packing and shipping the machine

### ! CAUTION

If you pack the machine soon after turning off the power make sure the machine has cooled down completely.

When you transport the machine, use the packing materials that came with your machine. If you do not pack the machine properly, you could void your warranty. The machine should be adequately insured with the carrier.

- 1 Turn off the machine's power switch.
- 2 Unplug the machine from the telephone wall jack.
- 3 Unplug all the cables and AC power cord from the machine.
- 4 Open the front cover.
- 5 Remove the drum unit and toner cartridge assembly. Leave the toner cartridge installed in the drum unit.
- 6 Place the drum unit and toner cartridge assembly into the plastic bag and seal the bag.
- 7 Close the front cover.
- 8 Wrap the machine in the plastic bag and place it in the original carton with the original packing material.

- 9 Pack the drum unit and toner cartridge assembly, AC cord and printed materials in the original carton as shown below:

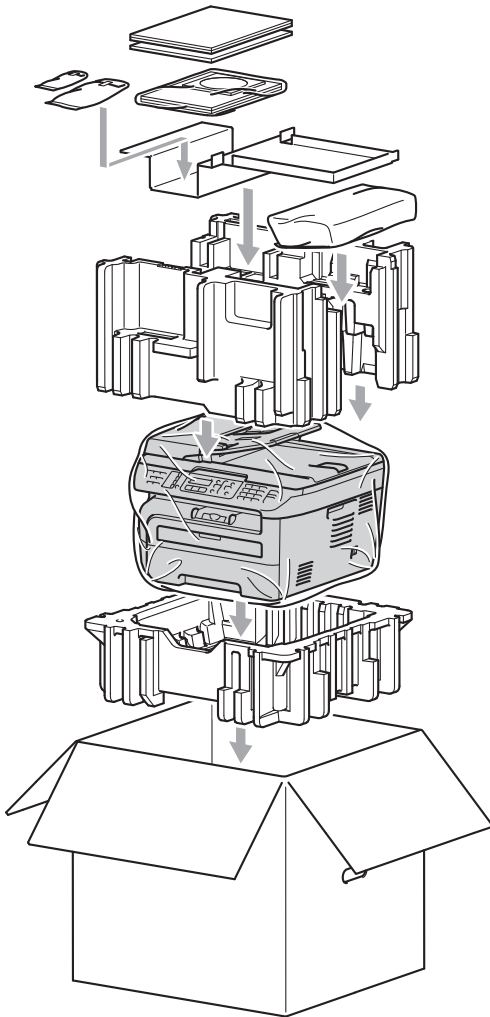

**Note**

If you are returning your machine to Brother as part of the Exchange Service, pack only the machine. Keep all separate parts and printed materials to use with your “Exchange” machine.

- 10 Close the carton and tape it shut.

## On-screen programming

Your machine has been designed to be easy to use. The LCD provides on-screen programming using the menu keys.

We have created step by step on-screen instructions to help you program your machine. Simply follow the steps as they guide you through the menu selections and programming options.

### Menu table

You can program your machine by using the *Menu table* on page 137. These pages list the menu selections and options.

Press **Menu** followed by the menu numbers to program your machine.







For example, to set *Beeper* volume to *Low*:

- 1 Press **Menu**, **1**, **4**, **2**.
- 2 Press **▲** or **▼** to choose *Low*.
- 3 Press **OK**.

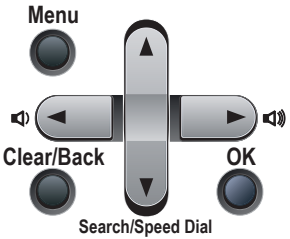
### Memory storage

Your menu settings are stored permanently, and in the event of a power failure will *not* be lost. Temporary settings (for example, Contrast, Overseas Mode) *will* be lost. The MFC-7840W can store the date and time for approximately 4 days.

## Menu keys

|                                                                                     |                                                                              |
|-------------------------------------------------------------------------------------|------------------------------------------------------------------------------|
|   |                                                                              |
|    | Access the menu.                                                             |
|    | Go to the next menu level.<br>Accept an option.                              |
|    | Exit the menu by pressing repeatedly.<br>Go back to the previous menu level. |
|  | Scroll through the current menu level.                                       |
|  | Go back to the previous menu level or forward to the next menu level.        |
|  | Exit the menu.                                                               |

## How to access the menu mode

---

- 1 Press **Menu**.
- 2 Choose an option.
  - Press **1** for General Setup menu.
  - Press **2** for Fax menu.
  - Press **3** for Copy menu.
  - (MFC-7340 only)  
Press **4** for Machine Info. menu.
  - (MFC-7345N and MFC-7440N only)  
Press **4** for LAN menu.  
Press **5** for Machine Info. menu.
  - (MFC-7840W only)  
Press **4** for Printer menu.  
Press **5** for LAN menu.  
Press **6** for Machine info. menu.
  - Press **9** for Service menu. <sup>1</sup>
  - Press **0** for Initial Setup.

<sup>1</sup> This will appear only when the LCD shows an error message.

You can also scroll through each menu level by pressing **▲** or **▼** for the direction you want.

- 3 Press **OK** when the option you want appears on the LCD.  
The LCD will then show the next menu level.
- 4 Press **▲** or **▼** to scroll to your next menu selection.
- 5 Press **OK**.  
When you have finished setting an option, the LCD will show *Accepted*.
- 6 Press **Stop/Exit** to exit Menu mode.

# Menu table

The factory settings are shown in Bold with an asterisk.

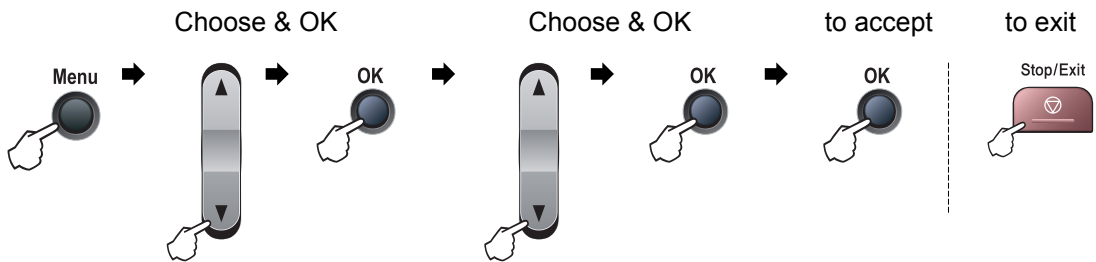

| Main Menu                                                                                                                                    | Submenu       | Menu Selections | Options                                                                     | Descriptions                                                                                                                                  | Page     |
|----------------------------------------------------------------------------------------------------------------------------------------------|---------------|-----------------|-----------------------------------------------------------------------------|-----------------------------------------------------------------------------------------------------------------------------------------------|----------|
| 1. General Setup                                                                                                                             | 1. Mode Timer | —               | 0 Sec<br>30 Secs<br>1 Min<br><b>2 Mins*</b><br>5 Mins<br>Off                | Sets the time to return to Fax mode and the time the machine will change from individual user to public user when using Secure Function Lock. | 20<br>27 |
|                                                                                                                                              | 2. Paper Type | —               | Thin<br><b>Plain*</b><br>Thick<br>Thicker<br>Transparency<br>Recycled Paper | Sets the type of paper in the paper tray.                                                                                                     | 20       |
|                                                                                                                                              | 3. Paper Size | —               | A4<br><b>Letter*</b><br>Legal<br>Executive<br>A5<br>A6<br>B5<br>B6<br>Folio | Sets the size of the paper in the paper tray.                                                                                                 | 20       |
|  The factory settings are shown in Bold with an asterisk. |               |                 |                                                                             |                                                                                                                                               |          |

| Main Menu                       | Submenu          | Menu Selections                                        | Options                                                             | Descriptions                                                                                                     | Page                                                                             |    |
|---------------------------------|------------------|--------------------------------------------------------|---------------------------------------------------------------------|------------------------------------------------------------------------------------------------------------------|----------------------------------------------------------------------------------|----|
| 1. General Setup<br>(continued) | 4. Volume        | 1. Ring                                                | Off<br>Low<br><b>Med*</b><br>High                                   | Adjusts the ring volume.                                                                                         | 21                                                                               |    |
|                                 |                  | 2. Beeper                                              | Off<br>Low<br><b>Med*</b><br>High                                   | Adjusts the volume level of the beeper.                                                                          | 21                                                                               |    |
|                                 |                  | 3. Speaker                                             | Off<br>Low<br><b>Med*</b><br>High                                   | Adjusts the speaker volume.                                                                                      | 21                                                                               |    |
|                                 | 5. Auto Daylight | —                                                      | On<br><b>Off*</b>                                                   | Changes for Daylight Savings Time automatically.                                                                 | 22                                                                               |    |
|                                 | 6. Ecology       | 1. Toner Save                                          | On<br><b>Off*</b>                                                   | Increases the page yield of the toner cartridge.                                                                 | 22                                                                               |    |
|                                 |                  | 2. Sleep Time                                          | (00-99)<br><b>05Min*</b>                                            | Conserves power.                                                                                                 | 22                                                                               |    |
|                                 | 7. LCD Contrast  | —                                                      | ▼ -□□□■+ ▲<br>▼ -□□□■+ ▲<br>▼ -□□■□+ ▲*<br>▼ -□■□□+ ▲<br>▼ -■□□□+ ▲ | Adjusts the contrast of the LCD.                                                                                 | 22                                                                               |    |
|                                 | 8. Security      | 1. TX Lock<br>(MFC-7340, MFC-7345N and MFC-7440N only) | —                                                                   | Prohibits most operations except receiving faxes.                                                                | 24                                                                               |    |
|                                 |                  | 1. Function Lock<br>(MFC-7840W only)                   | —                                                                   | Can restrict selected machine operation for up to 10 individual users and all other non-authorized Public users. | 25                                                                               |    |
|                                 |                  | 2. Setting Lock                                        | —                                                                   | Stops unauthorized users from changing the machine's current settings.                                           | 28                                                                               |    |
|                                 | 2. Fax           | 1. Setup Receive<br>(In Fax mode only)                 | 1. Ring Delay                                                       | 00<br>01<br>02<br>03<br><b>04*</b>                                                                               | Sets the number of rings before the machine answers in Fax Only or Fax/Tel mode. | 41 |



The factory settings are shown in Bold with an asterisk.



| Main Menu             | Submenu                                                                                                                                      | Menu Selections   | Options                                                             | Descriptions                                                                                                                                       | Page                                                 |    |
|-----------------------|----------------------------------------------------------------------------------------------------------------------------------------------|-------------------|---------------------------------------------------------------------|----------------------------------------------------------------------------------------------------------------------------------------------------|------------------------------------------------------|----|
| 2. Fax<br>(continued) | 1. Setup Receive<br>(continued)                                                                                                              | 2. F/T Ring Time  | <b>20 Secs*</b><br>30 Secs<br>40 Secs<br>70 Secs                    | Sets the pseudo/double-ring time in Fax/Tel mode.                                                                                                  | 41                                                   |    |
|                       |                                                                                                                                              | 3. Easy Receive   | <b>On*</b><br>Off                                                   | Receives fax messages without pressing <b>Start</b> .                                                                                              | 42                                                   |    |
|                       |                                                                                                                                              | 4. Remote Codes   | <b>On*</b> (*51, #51)<br>Off                                        | Allows you to answer all calls at an extension or external telephone and use codes to turn the machine on or off. You can personalize these codes. | 51                                                   |    |
|                       |                                                                                                                                              | 5. Auto Reduction | <b>On*</b><br>Off                                                   | Cuts the size of incoming faxes.                                                                                                                   | 43                                                   |    |
|                       |                                                                                                                                              | 6. Print Density  | ▼ -□□□■+ ▲<br>▼ -□□■□+ ▲<br>▼ -□■□□+ ▲*<br>▼ -□■□□+ ▲<br>▼ -■□□□+ ▲ | Makes printouts darker or lighter.                                                                                                                 | 42                                                   |    |
|                       |                                                                                                                                              | 7. Polling RX     | —                                                                   | Sets up your machine to poll another fax machine.                                                                                                  | 65                                                   |    |
|                       |                                                                                                                                              | 8. Fax Rx Stamp   | On<br><b>Off*</b>                                                   | Prints the received time and date on the top of the received faxes.                                                                                | 43                                                   |    |
|                       |                                                                                                                                              | 2. Setup Send     | 1. Contrast                                                         | <b>Auto*</b><br>Light<br>Dark                                                                                                                      | Changes the lightness or darkness of faxes you send. | 35 |
|                       | 2. Fax Resolution                                                                                                                            |                   | <b>Standard*</b><br>Fine<br>S. Fine<br>Photo                        | Sets the default resolution for outgoing faxes.                                                                                                    | 36                                                   |    |
|                       | 3. Delayed Fax                                                                                                                               |                   | —                                                                   | Sets the time of day in 24 hour format that the delayed faxes will be sent.                                                                        | 37                                                   |    |
|                       | 4. Batch TX                                                                                                                                  |                   | On<br><b>Off*</b>                                                   | Combines delayed faxes going to the same fax number at the same time of day into one transmission.                                                 | 37                                                   |    |
|                       |  The factory settings are shown in Bold with an asterisk. |                   |                                                                     |                                                                                                                                                    |                                                      |    |

| Main Menu            | Submenu                     | Menu Selections  | Options                                                                                                            | Descriptions                                                                                          | Page |
|----------------------|-----------------------------|------------------|--------------------------------------------------------------------------------------------------------------------|-------------------------------------------------------------------------------------------------------|------|
| 2.Fax<br>(continued) | 2.Setup Send<br>(continued) | 5.Real Time TX   | Next Fax:On<br>Next Fax:Off<br>On<br><b>Off*</b>                                                                   | Sends a fax without using the memory.                                                                 | 36   |
|                      |                             | 6.Polled TX      | On<br><b>Off*</b>                                                                                                  | Sets up your machine with a document to be retrieved by another fax machine.                          | 66   |
|                      |                             | 7.Coverpg Setup  | Next Fax:On<br>Next Fax:Off<br>On<br><b>Off*</b><br>Print Sample                                                   | Automatically sends a cover page you have programmed.                                                 | 34   |
|                      |                             | 8.Coverpage Msg  | —                                                                                                                  | Sets up your own comments for the fax cover page.                                                     | 34   |
|                      |                             | 9.Overseas Mode  | On<br><b>Off*</b>                                                                                                  | If you are having difficulty sending faxes overseas, set this to on.                                  | 37   |
|                      | 3.Set Quick Dial            | 1.One Touch Dial | —                                                                                                                  | Stores up to 8 One Touch Dial numbers, so you can dial by pressing one key (and <b>Start</b> ).       | 54   |
|                      |                             | 2.Speed Dial     | —                                                                                                                  | Stores up to 200 Speed Dial numbers, so you can dial by pressing only a few keys (and <b>Start</b> ). | 55   |
|                      |                             | 3.Setup Groups   | —                                                                                                                  | Sets up to 8 Group numbers for Broadcasting.                                                          | 56   |
|                      | 4.Report Setting            | 1.Transmission   | On<br>On+Image<br><b>Off*</b><br>Off+Image                                                                         | Sets initial setup for Transmission Verification Report.                                              | 67   |
|                      |                             | 2.Journal Period | Off<br><b>Every 50 Faxes*</b><br>Every 6 Hours<br>Every 12 Hours<br>Every 24 Hours<br>Every 2 Days<br>Every 7 Days | Sets the interval for automatic printing of the Fax Journal.                                          | 67   |





The factory settings are shown in Bold with an asterisk.

| Main Menu             | Submenu           | Menu Selections                         | Options                                                                                                                       | Descriptions                                                                                                                                                                                                                                                                                           | Page |
|-----------------------|-------------------|-----------------------------------------|-------------------------------------------------------------------------------------------------------------------------------|--------------------------------------------------------------------------------------------------------------------------------------------------------------------------------------------------------------------------------------------------------------------------------------------------------|------|
| 2. Fax<br>(continued) | 5. Remote Fax Opt | 1. Fwd/Page/Store<br><br>(Backup Print) | <b>Off*</b><br>Fax Forward<br>Paging<br>Fax Storage<br>PC Fax Receive                                                         | Sets the machine to forward fax messages, to call your pager, to store incoming faxes in the memory (so you can retrieve them while you are away from your machine), or to send faxes to your PC.<br><br>If you choose Fax Forward or PC Fax Receive, you can turn on the safety feature Backup Print. | 58   |
|                       |                   | 2. Remote Access                        | ---*                                                                                                                          | Sets your own code for Remote Retrieval.                                                                                                                                                                                                                                                               | 62   |
|                       |                   | 3. Print Fax                            | —                                                                                                                             | Prints incoming faxes stored in the memory.                                                                                                                                                                                                                                                            | 43   |
|                       | 6. Dial Restrict. | 1. Dial Pad                             | <b>Off*</b><br>Enter # twice<br>On                                                                                            | You can set the machine to restrict dialing when using the dial pad.                                                                                                                                                                                                                                   | 29   |
|                       |                   | 2. One Touch Dial                       | <b>Off*</b><br>Enter # twice<br>On                                                                                            | You can set the machine to restrict the dialing of One Touch numbers.                                                                                                                                                                                                                                  | 29   |
|                       |                   | 3. Speed Dial                           | <b>Off*</b><br>Enter # twice<br>On                                                                                            | You can set the machine to restrict the dialing of Speed Dial numbers.                                                                                                                                                                                                                                 | 29   |
|                       | 7. Remaining Jobs | —                                       | —                                                                                                                             | You can check which jobs are in the memory and lets you cancel scheduled jobs.                                                                                                                                                                                                                         | 38   |
|                       | 0. Miscellaneous  | 1. Compatibility                        | High <sup>1</sup><br>(MFC-7840W only)<br><b>Normal*</b><br>Basic (for VoIP)<br><br><sup>1</sup> Factory setting for MFC-7840W | Adjusts the equalization for transmission difficulties.<br><br>VoIP service providers offer fax support using various standards. If you regularly experience fax transmission errors, choose Basic (for VoIP).                                                                                         | 106  |
|                       |                   | 2. Distinctive                          | <b>Off*</b><br>Set                                                                                                            | Uses the telephone company's Distinctive Ring subscriber service to register the ring pattern with the machine.                                                                                                                                                                                        | 44   |



The factory settings are shown in Bold with an asterisk.

| Main Menu                                                                                                                                    | Submenu                         | Menu Selections  | Options                                                                 | Descriptions                                                         | Page                                                    |
|----------------------------------------------------------------------------------------------------------------------------------------------|---------------------------------|------------------|-------------------------------------------------------------------------|----------------------------------------------------------------------|---------------------------------------------------------|
| 2. Fax<br>(continued)                                                                                                                        | 0. Miscellaneous<br>(continued) | 3. Caller ID     | Display#<br>Print Report                                                | View or print a list of the last 30 Caller IDs stored in the memory. | 46                                                      |
| 3. Copy                                                                                                                                      | 1. Quality                      | —                | Auto*<br>Text<br>Photo                                                  | You can choose the Copy resolution for your type of document.        | 73                                                      |
|                                                                                                                                              | 2. Contrast                     | —                | ▼ -□□□■+ ▲<br>▼ -□□□□+ ▲<br>▼ -□□■□+ ▲*<br>▼ -□■□□+ ▲<br>▼ -■□□□+ ▲     | Adjusts the contrast for copies.                                     | 74                                                      |
| 4. Printer<br>(MFC-7840W<br>only)                                                                                                            | 1. Emulation                    | —                | Auto*<br>HP LaserJet<br>BR-Script 3                                     | Chooses the emulation mode.                                          | See<br>Software<br>User's<br>Guide on<br>the<br>CD-ROM. |
|                                                                                                                                              | 2. Print Options                | 1. Internal Font | —                                                                       | Prints a list of the machine's internal fonts.                       |                                                         |
|                                                                                                                                              |                                 | 2. Configuration | —                                                                       | Prints a list of the machine's printer settings.                     |                                                         |
|                                                                                                                                              |                                 | 3. Test Print    | —                                                                       | Prints a test page.                                                  |                                                         |
| 3. Reset Printer                                                                                                                             | 1. Reset<br>2. Exit             | —                | Restores the printer settings to the original factory default settings. |                                                                      |                                                         |
|  The factory settings are shown in Bold with an asterisk. |                                 |                  |                                                                         |                                                                      |                                                         |

| Main Menu                                                                                                                                    | Submenu   | Menu Selections       | Options | Descriptions                                                           | Page                                                                      |                                                       |
|----------------------------------------------------------------------------------------------------------------------------------------------|-----------|-----------------------|---------|------------------------------------------------------------------------|---------------------------------------------------------------------------|-------------------------------------------------------|
| 4. LAN<br>(MFC-7345N<br>and<br>MFC-7440N<br>only)                                                                                            | 1. TCP/IP | 1. <b>BOOT Method</b> | —       | <b>Auto*</b><br>Static<br>RARP<br>BOOTP<br>DHCP                        | Chooses the BOOT method that best suits your needs.                       | See<br>Network<br>User's<br>Guide<br>on the<br>CD-ROM |
|                                                                                                                                              |           | 2. <b>IP Address</b>  | —       | [000-255].<br>[000-255].<br>[000-255].<br>[000-255]                    | Enter the IP address.                                                     |                                                       |
|                                                                                                                                              |           | 3. <b>Subnet Mask</b> | —       | [000-255].<br>[000-255].<br>[000-255].<br>[000-255]                    | Enter the Subnet mask.                                                    |                                                       |
|                                                                                                                                              |           | 4. <b>Gateway</b>     | —       | [000-255].<br>[000-255].<br>[000-255].<br>[000-255]                    | Enter the Gateway address.                                                |                                                       |
|                                                                                                                                              |           | 5. <b>Node Name</b>   | —       | BRN<br>XXXXXXXXXXXX                                                    | Enter the Node name.                                                      |                                                       |
|                                                                                                                                              |           | 6. <b>WINS Config</b> | —       | <b>Auto*</b><br>Static                                                 | Chooses the WINS configuration mode.                                      |                                                       |
|                                                                                                                                              |           | 7. <b>WINS Server</b> | —       | (Primary)<br>000.000.000.<br>000<br>(Secondary)<br>000.000.000.<br>000 | Specifies the IP address of the primary or secondary WINS server.         |                                                       |
|                                                                                                                                              |           | 8. <b>DNS Server</b>  | —       | (Primary)<br>000.000.000.<br>000<br>(Secondary)<br>000.000.000.<br>000 | Specifies the IP address of the primary or secondary DNS server.          |                                                       |
|                                                                                                                                              |           | 9. <b>APIPA</b>       | —       | <b>On*</b><br>Off                                                      | Automatically allocates the IP address from the link-local address range. |                                                       |
|  The factory settings are shown in Bold with an asterisk. |           |                       |         |                                                                        |                                                                           |                                                       |

| Main Menu                                                      | Submenu                                   | Menu Selections    |                                                                                                                                           | Options                                                                                                                                                     | Descriptions                                                                                                                                                                     | Page                                           |
|----------------------------------------------------------------|-------------------------------------------|--------------------|-------------------------------------------------------------------------------------------------------------------------------------------|-------------------------------------------------------------------------------------------------------------------------------------------------------------|----------------------------------------------------------------------------------------------------------------------------------------------------------------------------------|------------------------------------------------|
| <b>4. LAN</b><br>(MFC-7345N and MFC-7440N only)<br>(continued) | <b>1. TCP/IP</b><br>(continued)           | <b>0. IPv6</b>     | —                                                                                                                                         | On<br><b>Off*</b>                                                                                                                                           | Enable or Disable the IPv6 protocol. If you want to use the IPv6 protocol, visit <a href="http://solutions.brother.com/">http://solutions.brother.com/</a> for more information. | <i>See Network User's Guide on the CD-ROM.</i> |
|                                                                |                                           | <b>2. Ethernet</b> | —                                                                                                                                         | —                                                                                                                                                           | <b>Auto*</b><br>100B-FD<br>100B-HD<br>10B-FD<br>10B-HD                                                                                                                           |                                                |
|                                                                | <b>3. Scan to FTP</b><br>(MFC-7440N only) | —                  | <b>Color 150 dpi*</b><br>Color 300 dpi<br>Color 600 dpi<br>Gray 100 dpi<br>Gray 200 dpi<br>Gray 300 dpi<br>B&W 200 dpi<br>B&W 200x100 dpi | (If you chose color option)<br><b>PDF*</b><br>JPEG<br>(If you chose gray option)<br>PDF<br><b>JPEG*</b><br>(If you chose B&W option)<br><b>PDF*</b><br>TIFF | Chooses the file format to send the scanned data via FTP.                                                                                                                        |                                                |
|                                                                | <b>0. Factory Reset</b>                   | <b>1. Reset</b>    | —                                                                                                                                         | 1. Yes<br>2. No                                                                                                                                             | Restore all network settings to factory default.                                                                                                                                 |                                                |
|                                                                | <b>2. Exit</b>                            | —                  | —                                                                                                                                         |                                                                                                                                                             |                                                                                                                                                                                  |                                                |



The factory settings are shown in Bold with an asterisk.

| Main Menu                  | Submenu  | Menu Selections |                       | Options                                                                | Descriptions                                                                                                                                                                     | Page                                           |
|----------------------------|----------|-----------------|-----------------------|------------------------------------------------------------------------|----------------------------------------------------------------------------------------------------------------------------------------------------------------------------------|------------------------------------------------|
| 5. LAN<br>(MFC-7840W only) | 1. Wired | 1. TCP/IP       | <b>1. BOOT Method</b> | <b>Auto*</b><br>Static<br>RARP<br>BOOTP<br>DHCP                        | Chooses the BOOT method that best suits your needs.                                                                                                                              | See <i>Network User's Guide on the CD-ROM.</i> |
|                            |          |                 | <b>2. IP Address</b>  | [000-255].<br>[000-255].<br>[000-255].<br>[000-255]                    | Enter the IP address.                                                                                                                                                            |                                                |
|                            |          |                 | <b>3. Subnet Mask</b> | [000-255].<br>[000-255].<br>[000-255].<br>[000-255]                    | Enter the Subnet mask.                                                                                                                                                           |                                                |
|                            |          |                 | <b>4. Gateway</b>     | [000-255].<br>[000-255].<br>[000-255].<br>[000-255]                    | Enter the Gateway address.                                                                                                                                                       |                                                |
|                            |          |                 | <b>5. Node Name</b>   | BRN<br>XXXXXXXXXXXX                                                    | Enter the Node name.                                                                                                                                                             |                                                |
|                            |          |                 | <b>6. WINS Config</b> | <b>Auto*</b><br>Static                                                 | Chooses the WINS configuration mode.                                                                                                                                             |                                                |
|                            |          |                 | <b>7. WINS Server</b> | (Primary)<br>000.000.000.<br>000<br>(Secondary)<br>000.000.000.<br>000 | Specifies the IP address of the primary or secondary WINS server.                                                                                                                |                                                |
|                            |          |                 | <b>8. DNS Server</b>  | (Primary)<br>000.000.000.<br>000<br>(Secondary)<br>000.000.000.<br>000 | Specifies the IP address of the primary or secondary DNS server.                                                                                                                 |                                                |
|                            |          |                 | <b>9. APIPA</b>       | <b>On*</b><br>Off                                                      | Automatically allocates the IP address from the link-local address range.                                                                                                        |                                                |
|                            |          |                 | <b>0. IPv6</b>        | On<br><b>Off*</b>                                                      | Enable or Disable the IPv6 protocol. If you want to use the IPv6 protocol, visit <a href="http://solutions.brother.com/">http://solutions.brother.com/</a> for more information. |                                                |



The factory settings are shown in Bold with an asterisk.

| Main Menu                                                                                                                                    | Submenu                 | Menu Selections   |                     | Options                                                | Descriptions                                                   | Page                                    |                                                                   |
|----------------------------------------------------------------------------------------------------------------------------------------------|-------------------------|-------------------|---------------------|--------------------------------------------------------|----------------------------------------------------------------|-----------------------------------------|-------------------------------------------------------------------|
| 5. LAN<br>(MFC-7840W only)<br>(continued)                                                                                                    | 1. Wired<br>(continued) | 2. Ethernet       | —                   | <b>Auto*</b><br>100B-FD<br>100B-HD<br>10B-FD<br>10B-HD | Chooses the Ethernet link mode.                                | See Network User's Guide on the CD-ROM. |                                                                   |
|                                                                                                                                              |                         | 3. Set to Default | 1. Reset<br>2. Exit | —                                                      | Restore the wired network setting to factory default.          |                                         |                                                                   |
|                                                                                                                                              |                         | 4. Wired Enable   | —                   | <b>On*</b><br>Off                                      | Enable or Disable the Wired LAN manually.                      |                                         |                                                                   |
|                                                                                                                                              | 2. WLAN                 | 1. TCP/IP         | 1. BOOT Method      | 1. <b>BOOT Method</b>                                  | <b>Auto*</b><br>Static<br>RARP<br>BOOTP<br>DHCP                |                                         | Chooses the BOOT method that best suits your needs.               |
|                                                                                                                                              |                         |                   | 2. IP Address       | 2. <b>IP Address</b>                                   | [000-255].<br>[000-255].<br>[000-255].<br>[000-255]            |                                         | Enter the IP address.                                             |
|                                                                                                                                              |                         |                   | 3. Subnet Mask      | 3. <b>Subnet Mask</b>                                  | [000-255].<br>[000-255].<br>[000-255].<br>[000-255]            |                                         | Enter the Subnet mask.                                            |
|                                                                                                                                              |                         |                   | 4. Gateway          | 4. <b>Gateway</b>                                      | [000-255].<br>[000-255].<br>[000-255].<br>[000-255]            |                                         | Enter the Gateway address.                                        |
|                                                                                                                                              |                         |                   | 5. Node Name        | 5. <b>Node Name</b>                                    | BRW<br>XXXXXXXXXXXX                                            |                                         | Enter the Node name.                                              |
|                                                                                                                                              |                         |                   | 6. WINS Config      | 6. <b>WINS Config</b>                                  | <b>Auto*</b><br>Static                                         |                                         | Chooses the WINS configuration mode.                              |
|                                                                                                                                              |                         |                   | 7. WINS Server      | 7. <b>WINS Server</b>                                  | (Primary)<br>000.000.000.000<br>(Secondary)<br>000.000.000.000 |                                         | Specifies the IP address of the primary or secondary WINS server. |
|  The factory settings are shown in Bold with an asterisk. |                         |                   |                     |                                                        |                                                                |                                         |                                                                   |



| Main Menu                                 | Submenu                | Menu Selections                                                                                                                              | Options                    | Descriptions                                                                  | Page                                                                                                                                                                             |                                                |                                                           |  |
|-------------------------------------------|------------------------|----------------------------------------------------------------------------------------------------------------------------------------------|----------------------------|-------------------------------------------------------------------------------|----------------------------------------------------------------------------------------------------------------------------------------------------------------------------------|------------------------------------------------|-----------------------------------------------------------|--|
| 5. LAN<br>(MFC-7840W only)<br>(continued) | 2. WLAN<br>(continued) | 1. TCP/IP<br>(continued)                                                                                                                     | 8. DNS Server              | (Primary)<br>000.000.000.000<br><br>(Secondary)<br>000.000.000.000            | Specifies the IP address of the primary or secondary DNS server.                                                                                                                 | See <i>Network User's Guide on the CD-ROM.</i> |                                                           |  |
|                                           |                        |                                                                                                                                              | 9. APIPA                   | On*<br>Off                                                                    | Automatically allocates the IP address from the link-local address range.                                                                                                        |                                                |                                                           |  |
|                                           |                        |                                                                                                                                              | 0. IPv6                    | On<br>Off*                                                                    | Enable or Disable the IPv6 protocol. If you want to use the IPv6 protocol, visit <a href="http://solutions.brother.com/">http://solutions.brother.com/</a> for more information. |                                                |                                                           |  |
|                                           |                        | 2. Setup Wizard                                                                                                                              | 1. On<br>2. Off            | —                                                                             | You can configure your print server.                                                                                                                                             |                                                |                                                           |  |
|                                           |                        | 3. SES/WPS/AOSS                                                                                                                              | 1. On<br>2. Off            | —                                                                             | You can easily configure your wireless network settings using the one-button push method.                                                                                        |                                                |                                                           |  |
|                                           |                        | 4. WPS w/PIN Code                                                                                                                            | 1. On<br>2. Off            | —                                                                             | You can easily configure your wireless network settings using WPS with a PIN code.                                                                                               |                                                |                                                           |  |
|                                           |                        | 5. WLAN Status                                                                                                                               | 1. Status                  | Active (11b)<br>Active (11g)<br>Wired LAN Active<br>WLAN OFF<br>Connection NG | —                                                                                                                                                                                |                                                | You can see the current wireless network status.          |  |
|                                           |                        |                                                                                                                                              | 2. Signal <sup>1</sup>     | Strong<br>Medium<br>Weak<br>None                                              | —                                                                                                                                                                                |                                                | You can see the current wireless network signal strength. |  |
|                                           |                        |                                                                                                                                              | 3. SSID <sup>1</sup>       | —                                                                             | —                                                                                                                                                                                |                                                | You can see the current SSID.                             |  |
|                                           |                        |                                                                                                                                              | 4. Comm. Mode <sup>1</sup> | Ad-hoc<br>Infrastructure                                                      | —                                                                                                                                                                                |                                                | You can see the current Communication Mode.               |  |
|                                           |                        |  The factory settings are shown in Bold with an asterisk. |                            |                                                                               |                                                                                                                                                                                  |                                                |                                                           |  |
|                                           |                        | <sup>1</sup> This setting only appears when WLAN Enable is On.                                                                               |                            |                                                                               |                                                                                                                                                                                  |                                                |                                                           |  |

| Main Menu             | Submenu                | Menu Selections   |                                                                                                                                    | Options                                                                                                                                | Descriptions                                              | Page                                    |
|-----------------------|------------------------|-------------------|------------------------------------------------------------------------------------------------------------------------------------|----------------------------------------------------------------------------------------------------------------------------------------|-----------------------------------------------------------|-----------------------------------------|
| 5. LAN<br>(continued) | 2. WLAN<br>(continued) | 6. Set to Default | 1. Reset<br>2. Exit                                                                                                                | —                                                                                                                                      | Restore the wireless network setting to factory default.  | See Network User's Guide on the CD-ROM. |
|                       |                        | 7. WLAN Enable    | —                                                                                                                                  | On<br>Off*                                                                                                                             | Enable or Disable the wireless LAN manually.              |                                         |
|                       | 3. Scan to FTP         | —                 | Color 150 dpi*<br>Color 300 dpi<br>Color 600 dpi<br>Gray 100 dpi<br>Gray 200 dpi<br>Gray 300 dpi<br>B&W 200 dpi<br>B&W 200x100 dpi | (If you chose color option)<br>PDF*<br>JPEG<br>(If you chose gray option)<br>PDF<br>JPEG*<br>(If you chose B&W option)<br>PDF*<br>TIFF | Chooses the file format to send the scanned data via FTP. |                                         |
|                       | 0. Factory Reset       | 1. Reset          | —                                                                                                                                  | 1. Yes<br>2. No                                                                                                                        | Restores all network settings to factory default.         |                                         |
|                       |                        | 2. Exit           | —                                                                                                                                  | —                                                                                                                                      |                                                           |                                         |



The factory settings are shown in Bold with an asterisk.

| Main Menu                                            | Submenu                              | Menu Selections                                                                    | Options                                                 | Descriptions                                                                              | Page                          |
|------------------------------------------------------|--------------------------------------|------------------------------------------------------------------------------------|---------------------------------------------------------|-------------------------------------------------------------------------------------------|-------------------------------|
| <b>4. Machine Info.</b><br>(MFC-7340)                | <b>1. Serial No.</b>                 | —                                                                                  | —                                                       | You can check the serial number of your machine.                                          | 132                           |
|                                                      | <b>2. Page Counter</b>               | —                                                                                  | Total                                                   | You can check the number of total pages the machine has printed during its life.          | 132                           |
|                                                      |                                      |                                                                                    | Fax/List<br>Copy<br>Print                               |                                                                                           |                               |
| <b>5. Machine Info.</b><br>(MFC-7345N and MFC-7440N) |                                      |                                                                                    |                                                         |                                                                                           |                               |
| <b>6. Machine Info.</b><br>(MFC-7840W)               | <b>3. Drum Life</b>                  | —                                                                                  | —                                                       | You can check the percentage of a Drum life that remains available.                       | 133                           |
| <b>0. Initial Setup</b>                              | <b>1. Receive Mode</b>               | —                                                                                  | <b>Fax Only*</b><br>Fax/Tel<br>External TAD<br>Manual   | Chooses the receive mode that best suits your needs.                                      | 39                            |
|                                                      | <b>2. Date&amp;Time</b>              | —                                                                                  | —                                                       | Puts the date and time on the LCD and in headings of faxes you send.                      | <i>See Quick Setup Guide.</i> |
|                                                      | <b>3. Station ID</b>                 | —                                                                                  | Fax:<br>Tel:<br>Name:                                   | Sets your name and fax number to appear on each page you fax.                             |                               |
|                                                      | <b>4. Tone/Pulse</b><br>(in Canada)  | —                                                                                  | <b>Tone*</b><br>Pulse                                   | Chooses the dialing mode.                                                                 |                               |
|                                                      | <b>4. Dial Tone</b><br>(in USA)      | —                                                                                  | Detection                                               | You can shorten the dial tone detect pause.                                               | 105                           |
|                                                      | <b>5. Dial Tone</b><br>(in Canada)   | —                                                                                  | <b>No Detection*</b>                                    |                                                                                           |                               |
|                                                      | <b>5. Dial Prefix</b><br>(in USA)    | —                                                                                  | —                                                       | Sets a prefix number that will always be added before the fax number every time you dial. | 23                            |
|                                                      | <b>6. Dial Prefix</b><br>(in Canada) | —                                                                                  | —                                                       |                                                                                           |                               |
| <b>0. Local Language</b>                             | —                                    | (in USA)<br><b>English*</b><br>Spanish<br>(in Canada)<br><b>English*</b><br>French | Allows you to change the LCD language for your country. | <i>See Quick Setup Guide.</i>                                                             |                               |



The factory settings are shown in Bold with an asterisk.

## Entering text

When setting certain menu selections, such as the Station ID, you will need to type text characters. The dial pad keys have letters printed on them. The keys: **0**, **#** and **\*** do *not* have printed letters because they are used for special characters.

Press the appropriate dial pad key the number of times shown in this reference table to access the character you want.

| Press Key | one time | two times | three times | four times | five times | six times | seven times | eight times | nine times |
|-----------|----------|-----------|-------------|------------|------------|-----------|-------------|-------------|------------|
| 1         | @        | .         | /           | 1          | @          | .         | /           | 1           | @          |
| 2         | a        | b         | c           | A          | B          | C         | 2           | a           | b          |
| 3         | d        | e         | f           | D          | E          | F         | 3           | d           | e          |
| 4         | g        | h         | i           | G          | H          | I         | 4           | g           | h          |
| 5         | j        | k         | l           | J          | K          | L         | 5           | j           | k          |
| 6         | m        | n         | o           | M          | N          | O         | 6           | m           | n          |
| 7         | p        | q         | r           | s          | P          | Q         | R           | S           | 7          |
| 8         | t        | u         | v           | T          | U          | V         | 8           | t           | u          |
| 9         | w        | x         | y           | z          | W          | X         | Y           | Z           | 9          |

For menu selections that do not allow lower case character selection, please use this reference table:

| Press Key | one time | two times | three times | four times | five times |
|-----------|----------|-----------|-------------|------------|------------|
| 2         | A        | B         | C           | 2          | A          |
| 3         | D        | E         | F           | 3          | D          |
| 4         | G        | H         | I           | 4          | G          |
| 5         | J        | K         | L           | 5          | J          |
| 6         | M        | N         | O           | 6          | M          |
| 7         | P        | Q         | R           | 7          | P          |
| 8         | T        | U         | V           | 8          | T          |
| 9         | W        | X         | Y           | 9          | W          |

### Inserting spaces

To enter a space in a fax number, press **▶** once between numbers. To enter a space in a name, press **▶** twice between characters.

### Making corrections

If you entered a letter incorrectly and want to change it, press **◀** to move the cursor to the incorrect character, and then press **Clear/Back**.

## Repeating letters

To enter a character on the same key as the previous character, press ► to move the cursor right before pressing the key again.

## Special characters and symbols

Press \*, # or 0, then press ◀ or ▶ to move the cursor to the symbol or character you want. Press **OK** to choose it. The symbols and characters below will appear depending on your menu selection.

|         |     |                                          |
|---------|-----|------------------------------------------|
| Press * | for | (space) ! " # \$ % & ' ( ) * + , - . / € |
| Press # | for | : ; < = > ? @ [ ] ^ _ ¥ ~ '   { }        |
| Press 0 | for | É À È Ê Î Ç Ë Ö 0                        |

# D

# Specifications

## General

|                                     |                                                                                                                                                                                                                                                                                                                                                                                   |       |        |          |                            |        |                           |  |                                           |  |                             |          |              |
|-------------------------------------|-----------------------------------------------------------------------------------------------------------------------------------------------------------------------------------------------------------------------------------------------------------------------------------------------------------------------------------------------------------------------------------|-------|--------|----------|----------------------------|--------|---------------------------|--|-------------------------------------------|--|-----------------------------|----------|--------------|
| <b>Printer Type</b>                 | Laser                                                                                                                                                                                                                                                                                                                                                                             |       |        |          |                            |        |                           |  |                                           |  |                             |          |              |
| <b>Print Method</b>                 | Electrophotography by semiconductor laser beam scanning                                                                                                                                                                                                                                                                                                                           |       |        |          |                            |        |                           |  |                                           |  |                             |          |              |
| <b>Memory Capacity</b>              | 16 MB (MFC-7340)<br>32 MB (MFC-7345N, MFC-7440N and MFC-7840W)                                                                                                                                                                                                                                                                                                                    |       |        |          |                            |        |                           |  |                                           |  |                             |          |              |
| <b>LCD (liquid crystal display)</b> | 16 characters × 2 lines                                                                                                                                                                                                                                                                                                                                                           |       |        |          |                            |        |                           |  |                                           |  |                             |          |              |
| <b>Power Source</b>                 | 110-120 V AC 50/60 Hz                                                                                                                                                                                                                                                                                                                                                             |       |        |          |                            |        |                           |  |                                           |  |                             |          |              |
| <b>Power Consumption</b>            | <table> <tr> <td>Peak:</td> <td>1056 W</td> </tr> <tr> <td>Copying:</td> <td>Average 320 W <sup>1</sup></td> </tr> <tr> <td>Sleep:</td> <td>(MFC-7340)<br/>Average 9 W</td> </tr> <tr> <td></td> <td>(MFC-7345N and MFC-7440N)<br/>Average 10 W</td> </tr> <tr> <td></td> <td>(MFC-7840W)<br/>Average 12 W</td> </tr> <tr> <td>Standby:</td> <td>Average 75 W</td> </tr> </table> | Peak: | 1056 W | Copying: | Average 320 W <sup>1</sup> | Sleep: | (MFC-7340)<br>Average 9 W |  | (MFC-7345N and MFC-7440N)<br>Average 10 W |  | (MFC-7840W)<br>Average 12 W | Standby: | Average 75 W |
| Peak:                               | 1056 W                                                                                                                                                                                                                                                                                                                                                                            |       |        |          |                            |        |                           |  |                                           |  |                             |          |              |
| Copying:                            | Average 320 W <sup>1</sup>                                                                                                                                                                                                                                                                                                                                                        |       |        |          |                            |        |                           |  |                                           |  |                             |          |              |
| Sleep:                              | (MFC-7340)<br>Average 9 W                                                                                                                                                                                                                                                                                                                                                         |       |        |          |                            |        |                           |  |                                           |  |                             |          |              |
|                                     | (MFC-7345N and MFC-7440N)<br>Average 10 W                                                                                                                                                                                                                                                                                                                                         |       |        |          |                            |        |                           |  |                                           |  |                             |          |              |
|                                     | (MFC-7840W)<br>Average 12 W                                                                                                                                                                                                                                                                                                                                                       |       |        |          |                            |        |                           |  |                                           |  |                             |          |              |
| Standby:                            | Average 75 W                                                                                                                                                                                                                                                                                                                                                                      |       |        |          |                            |        |                           |  |                                           |  |                             |          |              |

<sup>1</sup> When making a copy from one sheet

## Dimensions

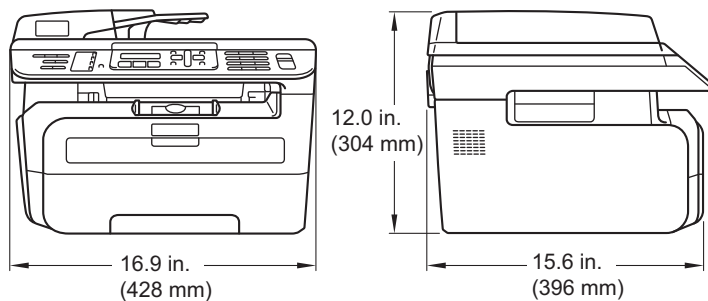

## Weight

Without Drum/Toner Unit: 22 lb (10 kg)

## Noise level

|                      |                 |
|----------------------|-----------------|
| Sound power          |                 |
| Operating (Copying): | LWAd = 6.2 Bell |
| Standby:             | LWAd = 4.4 Bell |
| Sound pressure       |                 |
| Operating (Copying): | LpAm = 53 dBA   |
| Standby:             | LpAm = 32 dBA   |

|                                        |                                                                                                                                                                                                                  |
|----------------------------------------|------------------------------------------------------------------------------------------------------------------------------------------------------------------------------------------------------------------|
| <b>Temperature</b>                     | Operating: 50° F to 90.5° F (10 to 32.5° C)<br>Storage: 41° F to 95° F (5 to 35° C)                                                                                                                              |
| <b>Humidity</b>                        | Operating: 20 to 80% (without condensation)<br>Storage: 10 to 90% (without condensation)                                                                                                                         |
| <b>ADF (automatic document feeder)</b> | Up to 35 pages (Staggered) 20 lb (80 g/m <sup>2</sup> )<br><br>Recommended Environment for Best Results:<br>Temperature: 68° F to 86° F (20 to 30° C)<br>Humidity: 50% - 70%<br>Paper: Xerox 4200 (20 lb/Letter) |
| <b>Paper Tray</b>                      | 250 Sheets 20 lb (80 g/m <sup>2</sup> )                                                                                                                                                                          |

# Print media

|                    |                                      |                                                                                           |
|--------------------|--------------------------------------|-------------------------------------------------------------------------------------------|
| <b>Paper Input</b> | <b>Paper Tray</b>                    |                                                                                           |
|                    | ■ Paper Type:                        | Plain Paper, Transparencies <sup>1</sup> or Recycled Paper                                |
|                    | ■ Paper Size:                        | Letter, A4, B5(ISO), A5, B6, A6, Executive, Legal and Folio                               |
|                    | ■ Paper Weight:                      | 16 to 28 lb (60 to 105 g/m <sup>2</sup> )                                                 |
|                    | ■ Maximum Paper Tray Capacity:       | Up to 250 sheets of 20 lb (80 g/m <sup>2</sup> ) Plain Paper                              |
|                    | <b>Manual Feed Slot</b>              |                                                                                           |
|                    | ■ Paper Type:                        | Plain Paper, Transparencies, Recycled Paper, Bond Paper, Envelopes or Labels <sup>1</sup> |
|                    | ■ Paper Size:                        | Width: 3.0 to 8.66 in. (76.2 to 220 mm)<br>Length: 4.57 to 16 in. (116.0 to 406.4 mm)     |
|                    | ■ Paper Weight:                      | 16 to 43 lb (60 to 163 g/m <sup>2</sup> )                                                 |
|                    | ■ Maximum Manual Feed Slot Capacity: | One sheet at a time                                                                       |

<sup>1</sup> For transparencies and labels, we recommend removing printed pages from the output paper tray immediately after they exit the machine to avoid the possibility of smudging.

**Paper Output** Up to 100 sheets (face down print delivery to the output paper tray)



# Fax

|                               |                                                                                                                                                                                                                                                                                        |
|-------------------------------|----------------------------------------------------------------------------------------------------------------------------------------------------------------------------------------------------------------------------------------------------------------------------------------|
| <b>Compatibility</b>          | ITU-T Group 3                                                                                                                                                                                                                                                                          |
| <b>Coding System</b>          | MH/MR/MMR (MFC-7340, MFC-7345N and MFC-7440N)<br>MH/MR/MMR/JBIG (MFC-7840W)                                                                                                                                                                                                            |
| <b>Modem Speed</b>            | Automatic Fallback: 14,400 bps (MFC-7340,<br>MFC-7345N and MFC-7440N)<br>33,600 bps (MFC-7840W)                                                                                                                                                                                        |
| <b>Document Size</b>          | ADF Width: 5.8 to 8.5 in. (148 to 215.9 mm)<br>ADF Length: 5.8 to 14 in. (148 to 355.6 mm)<br>Scanner Glass Width: Max. 8.5 in. (215.9 mm)<br>Scanner Glass Length: Max. 11.7 in. (297 mm)                                                                                             |
| <b>Scanning Width</b>         | Max. 8.2 in. (208 mm)                                                                                                                                                                                                                                                                  |
| <b>Printing Width</b>         | Max. 8.2 in. (208 mm)                                                                                                                                                                                                                                                                  |
| <b>Gray Scale</b>             | 256 levels                                                                                                                                                                                                                                                                             |
| <b>Polling Types</b>          | Standard, Sequential                                                                                                                                                                                                                                                                   |
| <b>Contrast Control</b>       | Automatic/Light/Dark (manual setting)                                                                                                                                                                                                                                                  |
| <b>Resolution</b>             | Horizontal: 203 dot/inch (8 dot/mm)<br>Vertical<br><ul style="list-style-type: none"> <li>■ Standard: 98 line/in. (3.85 line/mm)</li> <li>■ Fine: 196 line/in. (7.7 line/mm)</li> <li>■ Photo: 196 line/in. (7.7 line/mm)</li> <li>■ Superfine: 392 line/in. (15.4 line/mm)</li> </ul> |
| <b>One Touch Dial</b>         | 8 (4 × 2)                                                                                                                                                                                                                                                                              |
| <b>Speed Dial</b>             | 200 stations                                                                                                                                                                                                                                                                           |
| <b>Groups</b>                 | Up to 8                                                                                                                                                                                                                                                                                |
| <b>Broadcasting</b>           | 258 stations                                                                                                                                                                                                                                                                           |
| <b>Automatic Redial</b>       | Yes, 1 time after 5 minutes                                                                                                                                                                                                                                                            |
| <b>Ring Delay</b>             | 0, 1, 2, 3 or 4 rings                                                                                                                                                                                                                                                                  |
| <b>Communication Source</b>   | Public switched telephone network                                                                                                                                                                                                                                                      |
| <b>Memory Transmission</b>    | Up to 500 <sup>1</sup> / <sub>400</sub> <sup>2</sup> pages (MFC-7340, MFC-7345N and<br>MFC-7440N)<br>Up to 600 <sup>3</sup> / <sub>500</sub> <sup>4</sup> pages (MFC-7840W)                                                                                                            |
| <b>Out of Paper Reception</b> | Up to 500 <sup>1</sup> / <sub>400</sub> <sup>2</sup> pages (MFC-7340, MFC-7345N and<br>MFC-7440N)<br>Up to 600 <sup>3</sup> / <sub>500</sub> <sup>4</sup> pages (MFC-7840W)                                                                                                            |

- 1 'Pages' refers to the 'Brother Standard Chart No. 1' (a typical business letter, Standard resolution, MMR code). Specifications and printed materials are subject to change without prior notice.
- 2 'Pages' refers to the 'ITU-T Test Chart #1' (a typical business letter, Standard resolution, MMR code). Specifications and printed materials are subject to change without prior notice.
- 3 'Pages' refers to the 'Brother Standard Chart No. 1' (a typical business letter, Standard resolution, JBIG code). Specifications and printed materials are subject to change without prior notice.
- 4 'Pages' refers to the 'ITU-T Test Chart #1' (a typical business letter, Standard resolution, JBIG code). Specifications and printed materials are subject to change without prior notice.

# Copy

|                            |                                                                                                                                                                                                                                  |
|----------------------------|----------------------------------------------------------------------------------------------------------------------------------------------------------------------------------------------------------------------------------|
| <b>Copy Speed</b>          | Up to 21 pages/minute (Letter size) <sup>1</sup> (MFC-7340 and MFC-7345N)                                                                                                                                                        |
|                            | Up to 23 pages/minute (Letter size) <sup>1</sup><br>(MFC-7440N and MFC-7840W)                                                                                                                                                    |
| <b>Color/Monochrome</b>    | Monochrome                                                                                                                                                                                                                       |
| <b>Document Size</b>       | ADF Width: 5.8 to 8.5 in. (148 to 215.9 mm)<br>ADF Length: 5.8 to 14 in. (148 to 355.6 mm)<br>Scanner Glass Width: Max. 8.5 in. (215.9 mm)<br>Scanner Glass Length: Max. 11.7 in. (297 mm)<br>Copy Width: Max. 8.26 in. (210 mm) |
| <b>Multiple Copies</b>     | Stacks or Sorts up to 99 pages                                                                                                                                                                                                   |
| <b>Reduce/Enlarge</b>      | 25% to 400% (in increments of 1%)                                                                                                                                                                                                |
| <b>Resolution</b>          | Up to 600 × 600 dpi                                                                                                                                                                                                              |
| <b>First Copy Out Time</b> | Less than 15 seconds (from Ready state) <sup>2</sup>                                                                                                                                                                             |

<sup>1</sup> The copy speed may change depending on the type of document you copy.

<sup>2</sup> The first copy out time may vary depending on scanner lamp warm up time.

# Scan

|                         |                                                                                                                                                                                                |
|-------------------------|------------------------------------------------------------------------------------------------------------------------------------------------------------------------------------------------|
| <b>Color/Monochrome</b> | Yes                                                                                                                                                                                            |
| <b>TWAIN Compliant</b>  | Yes (Windows® 2000 Professional/XP/<br>XP Professional x64 Edition/Windows Vista®)<br>Mac OS® X 10.2.4 or greater                                                                              |
| <b>WIA Compliant</b>    | Yes (Windows® XP/Windows Vista®)                                                                                                                                                               |
| <b>Color Depth</b>      | 24 bit color                                                                                                                                                                                   |
| <b>Resolution</b>       | Up to 19200 × 19200 dpi (interpolated) <sup>1</sup><br>Up to 600 × 2400 dpi (optical) (From Scanner Glass)<br>Up to 600 × 600 dpi (optical) (From ADF)                                         |
| <b>Document Size</b>    | ADF Width: 5.8 to 8.5 in. (148.0 to 215.9 mm)<br>ADF Length: 5.8 to 14 in. (148.0 to 355.6 mm)<br>Scanner Glass Width: Max. 8.5 in. (215.9 mm)<br>Scanner Glass Length: Max. 11.7 in. (297 mm) |
| <b>Scanning Width</b>   | Max. 8.26 in. (210 mm)                                                                                                                                                                         |
| <b>Gray Scale</b>       | 256 levels                                                                                                                                                                                     |

<sup>1</sup> Maximum 1200 × 1200 dpi scanning with the WIA driver in Windows® XP/Windows Vista® (resolution up to 19200 × 19200 dpi can be chosen by using the Brother scanner utility)

# Print

|                                       |                                                                                                                                                                                                                                                                                                                                                                             |
|---------------------------------------|-----------------------------------------------------------------------------------------------------------------------------------------------------------------------------------------------------------------------------------------------------------------------------------------------------------------------------------------------------------------------------|
| <b>Emulations</b><br>(MFC-7840W only) | PCL6, BR-Script3 (PostScript®3)                                                                                                                                                                                                                                                                                                                                             |
| <b>Printer Driver</b>                 | Host-Based Driver for Windows® 2000 Professional/<br>XP/XP Professional x64 Edition/Windows Vista®/<br>Windows Server® 2003 (print only via network)<br>(MFC-7840W only)<br>BR-Script3 (PPD file) for Windows® 2000 Professional/<br>Macintosh® Printer Driver for Mac OS® X 10.2.4 or greater<br>(MFC-7840W only)<br>BR-Script3 (PPD file) for Mac OS® X 10.2.4 or greater |
| <b>Resolution</b>                     | HQ1200 (2400 × 600 dpi), 600, 300 dpi                                                                                                                                                                                                                                                                                                                                       |
| <b>Print Speed</b>                    | Up to 21 pages/minute (Letter size) (MFC-7340 and MFC-7345N) <sup>1</sup><br>Up to 23 pages/minute (Letter size) (MFC-7440N and MFC-7840W) <sup>1</sup>                                                                                                                                                                                                                     |
| <b>First Print Out Time</b>           | Less than 10 seconds (from Ready state and standard tray)                                                                                                                                                                                                                                                                                                                   |

<sup>1</sup> The print speed may change depending on the type of document you print.

# Interfaces

|                                                  |                                                                                                                                                                    |
|--------------------------------------------------|--------------------------------------------------------------------------------------------------------------------------------------------------------------------|
| <b>USB</b>                                       | Use a USB 2.0 interface cable that is no longer than 6 feet (2.0 m). <sup>1 2</sup>                                                                                |
| <b>LAN cable</b><br>(MFC-7440N and<br>MFC-7840W) | Use an Ethernet UTP cable category 5 or greater.                                                                                                                   |
| <b>Wireless LAN</b><br>(MFC-7840W)               | Your machine supports IEEE 802.11b/g wireless communication with your wireless LAN using Infrastructure mode or a wireless Peer-to-Peer connection in Ad-hoc mode. |

<sup>1</sup> Your machine has a USB interface that is compatible with the USB 2.0 specification. This interface is also compatible with High-Speed USB 2.0; however, the maximum data transfer rate will be 12 Mb/s. The machine can also be connected to a computer that has a USB 1.1 interface.

<sup>2</sup> Third party USB ports are not supported for Macintosh®.



## Note

MFC-7345N includes the USB cable.

# Computer requirements

| Minimum System Requirements and Supported PC Software Functions |                                                           |                                                    |                                                                                                                 |                                                                          |             |                 |                            |                  |
|-----------------------------------------------------------------|-----------------------------------------------------------|----------------------------------------------------|-----------------------------------------------------------------------------------------------------------------|--------------------------------------------------------------------------|-------------|-----------------|----------------------------|------------------|
| Computer Platform & Operating System Version                    |                                                           | Supported PC Software Functions                    | PC Interface                                                                                                    | Processor Minimum Speed                                                  | Minimum RAM | Recommended RAM | Hard Disk Space to install |                  |
|                                                                 |                                                           |                                                    |                                                                                                                 |                                                                          |             |                 | For Drivers                | For Applications |
| Windows® Operating System <sup>1</sup>                          | Windows® 2000 Professional <sup>4</sup>                   | Printing, PC Fax, Scanning                         | USB, 10/100 Base Tx (Ethernet) (MFC-7345N, MFC-7440N and MFC-7840W only) , Wireless 802.11 b/g (MFC-7840W only) | Intel® Pentium® II or equivalent                                         | 64 MB       | 256 MB          | 150 MB                     | 310 MB           |
|                                                                 | Windows® XP Home® <sup>2 4</sup>                          |                                                    |                                                                                                                 |                                                                          | 128 MB      |                 |                            |                  |
|                                                                 | Windows® XP Professional <sup>2 4</sup>                   |                                                    |                                                                                                                 |                                                                          |             |                 |                            |                  |
|                                                                 | Windows® XP Professional x64 Edition <sup>2</sup>         |                                                    |                                                                                                                 | 64-bit (Intel®64 or AMD64) supported CPU                                 | 256 MB      | 512 MB          |                            |                  |
|                                                                 | Windows Vista® <sup>2</sup>                               |                                                    |                                                                                                                 | Intel® Pentium® 4 or equivalent 64-bit (Intel®64 or AMD64) supported CPU | 512 MB      | 1 GB            | 500 MB                     | 500 MB           |
|                                                                 | Windows Server® 2003 (print only via network)             | Printing (MFC-7345N, MFC-7440N and MFC-7840W only) | 10/100 Base Tx (Ethernet) (MFC-7345N, MFC-7440N and MFC-7840W only) , Wireless 802.11 b/g (MFC-7840W only)      | Intel® Pentium® III or equivalent                                        | 256 MB      | 512 MB          | 50MB                       | N/A              |
|                                                                 | Windows Server® 2003 x64 Edition (print only via network) |                                                    |                                                                                                                 | 64-bit (Intel®64 or AMD64) supported CPU                                 |             |                 |                            |                  |

|                                   |                                   |                                       |                                                                                                                                                                          |                                                |        |        |       |        |
|-----------------------------------|-----------------------------------|---------------------------------------|--------------------------------------------------------------------------------------------------------------------------------------------------------------------------|------------------------------------------------|--------|--------|-------|--------|
| Macintosh®<br>Operating<br>System | Mac OS®<br>X 10.2.4<br>- 10.4.3   | Printing,<br>PC Fax send,<br>Scanning | USB <sup>3</sup> ,<br>10/100<br>Base Tx<br>(Ethernet)<br>(MFC-7345N,<br>MFC-7440N<br>and<br>MFC-7840W<br>only),<br><br>Wireless<br>802.11 b/g<br><br>(MFC-7840W<br>only) | PowerPC<br>G4/G5,<br>PowerPC G3<br>350MHz      | 128 MB | 256 MB | 80 MB | 400 MB |
|                                   | Mac OS®<br>X 10.4.4<br>or greater |                                       |                                                                                                                                                                          | PowerPC<br>G4/G5, Intel®<br>Core™<br>Processor | 512 MB | 1 GB   |       |        |

<sup>1</sup> Microsoft® Internet Explorer 5.5 or greater.

<sup>2</sup> For WIA, 1200x1200 resolution. Brother Scanner Utility enables to enhance up to 19200 x 19200 dpi.

<sup>3</sup> Third party USB ports are not supported.

<sup>4</sup> PaperPort™ 11SE supports Microsoft® SP4 or higher for Windows® 2000 and SP2 or higher for XP.

# Consumable items

|                             |                                               |                                               |
|-----------------------------|-----------------------------------------------|-----------------------------------------------|
| <b>Toner Cartridge Life</b> | Starter Toner Cartridge:                      | Approx. 1,000 pages <sup>1</sup>              |
|                             | Standard Toner Cartridge:<br><b>TN-330:</b>   | Approx. 1,500 pages<br>(Letter) <sup>1</sup>  |
|                             | High-Yield Toner Cartridge:<br><b>TN-360:</b> | Approx. 2,600 pages<br>(Letter) <sup>1</sup>  |
| <b>Drum Unit</b>            | <b>DR-360:</b>                                | Approx. 12,000 pages<br>(Letter) <sup>2</sup> |

<sup>1</sup> Approx. cartridge yield is declared in accordance with ISO/IEC 19752.

<sup>2</sup> Drum yield is approximate, and may vary by type of use.



## Ethernet wired network (MFC-7345N, MFC-7440N and MFC-7840W only)

|                                         |                                                                                                                                                                                                                                                                                                                                                                                                                                                                                                                                                                                                                                                                                                                                                                                                                                                                                       |
|-----------------------------------------|---------------------------------------------------------------------------------------------------------------------------------------------------------------------------------------------------------------------------------------------------------------------------------------------------------------------------------------------------------------------------------------------------------------------------------------------------------------------------------------------------------------------------------------------------------------------------------------------------------------------------------------------------------------------------------------------------------------------------------------------------------------------------------------------------------------------------------------------------------------------------------------|
| <b>Network board model name</b>         | NC-6600h (MFC-7345N and MFC-7440N)                                                                                                                                                                                                                                                                                                                                                                                                                                                                                                                                                                                                                                                                                                                                                                                                                                                    |
| <b>LAN</b>                              | You can connect your machine to a network for Network Printing, Network Scanning, PC Fax and Remote Setup. <sup>1 2</sup>                                                                                                                                                                                                                                                                                                                                                                                                                                                                                                                                                                                                                                                                                                                                                             |
| <b>Support for</b>                      | Windows <sup>®</sup> 2000 Professional, Windows <sup>®</sup> XP,<br>Windows <sup>®</sup> XP Professional x64 Edition, Windows Vista <sup>®</sup> , Windows Server <sup>®</sup> 2003 and Windows Server <sup>®</sup> 2003 x64 Edition <sup>2</sup><br>Mac OS <sup>®</sup> X 10.2.4 or greater <sup>3</sup>                                                                                                                                                                                                                                                                                                                                                                                                                                                                                                                                                                             |
| <b>Protocols</b>                        | TCP/IP for IPv4: ARP, RARP, BOOTP, DHCP, APIPA (Auto IP), WINS/NetBIOS name resolution, DNS resolver, mDNS, LPR/LPD, Custom Raw Port/Port9100, IPP, FTP server, POP before SMTP, SMTP AUTH, TELNET, SNMPv1, HTTP Server, FTP Client, TFTP Client and Server, SMTP Client, APOP, LLMNR responder, ICMP, Web Services<br>TCP/IP for IPv6: (Turned off as default) NDP, RA, DNS resolver, mDNS, LPR/LPD, Custom Raw Port/Port9100, IPP, FTP Server, POP before SMTP, SMTP AUTH, TELNET, SNMPv1, HTTP Server, FTP Client, TFTP Client and Server, SMTP Client, APOP, LLMNR responder, ICMPv6, Web Services<br>Other: LLTD responder                                                                                                                                                                                                                                                       |
| <b>Network type</b>                     | Ethernet 10/100 BASE-TX Auto Negotiation (Wired LAN)                                                                                                                                                                                                                                                                                                                                                                                                                                                                                                                                                                                                                                                                                                                                                                                                                                  |
| <b>Management utilities<sup>4</sup></b> | BRAdmin Light for Windows <sup>®</sup> 2000 Professional, Windows <sup>®</sup> XP, Windows <sup>®</sup> XP Professional x64 Edition, Windows Vista <sup>®</sup> , Windows Server <sup>®</sup> 2003, Windows Server <sup>®</sup> 2003 x64 Edition and Mac OS <sup>®</sup> X 10.2.4 or greater<br>BRAdmin Professional for Windows <sup>®</sup> 2000 Professional, Windows <sup>®</sup> XP, Windows <sup>®</sup> XP Professional x64 Edition, Windows Vista <sup>®</sup> , Windows Server <sup>®</sup> 2003 and Windows Server <sup>®</sup> 2003 x64 Edition<br>Web BRAdmin for Windows <sup>®</sup> 2000 Professional, Windows <sup>®</sup> XP, Windows <sup>®</sup> XP Professional x64 Edition, Windows Vista <sup>®</sup> , Windows Server <sup>®</sup> 2003 and Windows Server <sup>®</sup> 2003 x64 Edition<br>Client computers with a web browser supporting Java <sup>™</sup> . |

<sup>1</sup> PC Fax Send for Mac<sup>®</sup>

<sup>2</sup> Printing only for Windows Server<sup>®</sup> 2003

<sup>3</sup> Mac OS<sup>®</sup> X 10.2.4 or greater (mDNS)

<sup>4</sup> BRAdmin Professional and Web BRAdmin are available as a download from <http://solutions.brother.com/>

## Ethernet wireless network (MFC-7840W only)

|                                          |                                                                                                                                                                                                                                                                                                                                                                                                                                                                                                                                                                                                                                                                                                                                                                                                                                                                                       |
|------------------------------------------|---------------------------------------------------------------------------------------------------------------------------------------------------------------------------------------------------------------------------------------------------------------------------------------------------------------------------------------------------------------------------------------------------------------------------------------------------------------------------------------------------------------------------------------------------------------------------------------------------------------------------------------------------------------------------------------------------------------------------------------------------------------------------------------------------------------------------------------------------------------------------------------|
| <b>Network board model name</b>          | NC-7400w                                                                                                                                                                                                                                                                                                                                                                                                                                                                                                                                                                                                                                                                                                                                                                                                                                                                              |
| <b>LAN</b>                               | You can connect your machine to a network for Network Printing, Network Scanning, PC Fax and Remote Setup <sup>1 2</sup> .                                                                                                                                                                                                                                                                                                                                                                                                                                                                                                                                                                                                                                                                                                                                                            |
| <b>Support for</b>                       | Windows <sup>®</sup> 2000 Professional, Windows <sup>®</sup> XP,<br>Windows <sup>®</sup> XP Professional x64 Edition, Windows Vista <sup>®</sup> , Windows Server <sup>®</sup> 2003 and Windows Server <sup>®</sup> 2003 x64 Edition<br>Mac OS <sup>®</sup> X 10.2.4 or greater <sup>3</sup>                                                                                                                                                                                                                                                                                                                                                                                                                                                                                                                                                                                          |
| <b>Protocols</b>                         | TCP/IP for IPv4: ARP, RARP, BOOTP, DHCP, APIPA (Auto IP), WINS/NetBIOS name resolution, DNS resolver, mDNS, LPR/LPD, Custom Raw Port/Port9100, IPP, FTP server, POP before SMTP, SMTP AUTH, TELNET, SNMPv1, HTTP Server, FTP Client, TFTP Client and Server, SMTP Client, APOP, LLMNR responder, ICMP, Web Services<br>TCP/IP for IPv6 (Turned off as default) NDP, RA, DNS resolver, mDNS, LPR/LPD, Custom Raw Port/Port9100, IPP, FTP Server, POP before SMTP, SMTP AUTH, TELNET, SNMPv1, HTTP Server, FTP Client, TFTP Client and Server, SMTP Client, APOP, LLMNR responder, ICMPv6, Web Services<br>Other: LLTD responder                                                                                                                                                                                                                                                        |
| <b>Network type</b>                      | IEEE 802.11 b/g (Wireless LAN)                                                                                                                                                                                                                                                                                                                                                                                                                                                                                                                                                                                                                                                                                                                                                                                                                                                        |
| <b>Management utilities <sup>4</sup></b> | BRAdmin Light for Windows <sup>®</sup> 2000 Professional, Windows <sup>®</sup> XP, Windows <sup>®</sup> XP Professional x64 Edition, Windows Vista <sup>®</sup> , Windows Server <sup>®</sup> 2003, Windows Server <sup>®</sup> 2003 x64 Edition and Mac OS <sup>®</sup> X 10.2.4 or greater<br>BRAdmin Professional for Windows <sup>®</sup> 2000 Professional, Windows <sup>®</sup> XP, Windows <sup>®</sup> XP Professional x64 Edition, Windows Vista <sup>®</sup> , Windows Server <sup>®</sup> 2003 and Windows Server <sup>®</sup> 2003 x64 Edition<br>Web BRAdmin for Windows <sup>®</sup> 2000 Professional, Windows <sup>®</sup> XP, Windows <sup>®</sup> XP Professional x64 Edition, Windows Vista <sup>®</sup> , Windows Server <sup>®</sup> 2003 and Windows Server <sup>®</sup> 2003 x64 Edition<br>Client computers with a web browser supporting Java <sup>™</sup> . |

<sup>1</sup> PC Fax Send for Mac<sup>®</sup>

<sup>2</sup> Only printing for Windows Server<sup>®</sup> 2003

<sup>3</sup> Mac OS<sup>®</sup> X 10.2.4 or greater (mDNS)

<sup>4</sup> BRAdmin Professional and Web BRAdmin are available as a download from <http://solutions.brother.com/>.

## Authentication and encryption for wireless users only

---

### Authentication method

The Brother machine supports the following methods:

- Open system

Wireless devices are allowed to access the network without any authentication.

- Shared key

A secret pre-determined key is shared by all devices that will access the wireless network. The Brother machine uses the WEP keys as the pre-determined key.

- WPA-PSK/WPA2-PSK

Enables a Wi-Fi® Protected Access Pre-Shared Key (WPA-PSK/WPA2-PSK), which enables the Brother wireless machine to associate with access points using TKIP for WPA-PSK or AES for WPA-PSK and WPA2-PSK (WPA-Personal).

- LEAP

Cisco® LEAP (Light Extensible Authentication Protocol) has been developed by Cisco Systems, Inc. and enables the Brother wireless product to associate with access points using CKIP and CMIC encryptions.

### Encryption methods

Encryption is used to secure the data that is sent over the wireless network. The Brother machine supports the following encryption methods:

- WEP

By using WEP (Wired Equivalent Privacy), the data is transmitted and received with a secure key.

- TKIP

TKIP (Temporal Key Integrity Protocol) provides per-packet key mixing a message integrity check and re-keying mechanism.

- AES

AES (Advanced Encryption Standard) is Wi-Fi® authorized strong encryption standard.

- CKIP

The original Key Integrity Protocol for LEAP by Cisco Systems, Inc.

- CMIC

CMIC (Cisco Message Integrity Check) is the message integrity check mechanism for LEAP by Cisco Systems, Inc.

### Network key

There are some rules for each security method:

#### ■ Open system/Shared key with WEP

This key is a 64-bit or 128-bit value that must be entered in an ASCII or hexadecimal format.

- 64 (40) bit ASCII:

Uses 5 text characters. e.g. "WLAN" (this is case sensitive).

- 64 (40) bit hexadecimal:

Uses 10 digits of hexadecimal data. e.g. "71f2234aba"

- 128 (104) bit ASCII:

Uses 13 text characters. e.g. "Wirelesscomms" (this is case sensitive)

- 128 (104) bit hexadecimal:

Uses 26 digits of hexadecimal data. e.g. "71f2234ab56cd709e5412aa2ba"

#### ■ WPA-PSK/WPA2-PSK and TKIP or AES

Uses a Pre-Shared Key (PSK) that is 8 or more characters in length, up to a maximum of 63 characters.

#### ■ LEAP

Uses User ID and Password.

- User ID: less than 64 characters in length.

- Password: less than 32 characters in length.

## Wi-Fi Alliance certification

---

This wireless Ethernet multi-function print server is a Wi-Fi certified IEEE 802.11b/802.11g product by the Wi-Fi Alliance. The Wi-Fi Alliance certification ensures the interoperability of other wireless LAN products based on the IEEE 802.11 specification. For more information on the Wi-Fi Alliance and other Wi-Fi certified products, visit <http://www.wi-fi.org/>.

## Wireless one-push configuration

---

If your wireless access point supports either SecureEasySetup™, Wi-Fi Protected Setup™ (PBC<sup>1</sup>) or AOSS™, you can configure the machine easily without a computer. By pushing a button on the wireless LAN router / access point and using the menu on the machine, you can set up the wireless network and security settings. See the user's guide for your wireless LAN router / access point for instructions on how to access one-push mode.

<sup>1</sup> Push Button Configuration



### Note

---

Routers or access points that support SecureEasySetup™, Wi-Fi Protected Setup™ or AOSS™ have the symbols shown below.



# E

## Glossary

This is a comprehensive list of features and terms that appear in Brother manuals. Availability of these features depends on the model you purchased.

### **ADF (automatic document feeder)**

The document can be placed in the ADF and scanned one page at a time automatically.

### **Auto Reduction**

Reduces the size of incoming faxes.

### **Automatic fax transmission**

Sending a fax without picking up the handset of the external telephone or pressing **Hook**.

### **Automatic Redial**

A feature that enables your machine to redial the last fax number after five minutes if the fax did not go through because the line was busy.

### **Backup Print**

Your machine prints a copy of every fax that is received and stored in memory. This is a safety feature so you will not lose messages during a power failure.

### **Batch Transmission**

As a cost saving feature, all delayed faxes to the same fax number will be sent as one transmission.

### **Beeper Volume**

Volume setting for the beep when you press a key or make an error.

### **Broadcasting**

The ability to send the same fax message to more than one location.

### **Cancel Job**

Cancels a programmed print job and clears the machine's memory.

### **CNG tones**

The special tones (beeps) sent by fax machines during automatic transmission to tell the receiving machine that a fax machine is calling.

### **Coding method**

Method of coding the information contained in the document. All fax machines must use a minimum standard of Modified Huffman (MH). Your machine is capable of greater compression methods, Modified Read (MR), Modified Modified Read (MMR) and JBIG\* (\* MFC-7840W only), if the receiving machine has the same capability.

### **Communication error (or Comm. Error)**

An error during fax sending or receiving, usually caused by line noise or static.

### **Compatibility group**

The ability of one fax unit to communicate with another. Compatibility is assured between ITU-T Groups.

### **Contrast**

Setting to compensate for dark or light documents, by making faxes or copies of dark documents lighter and light documents darker.

### **Delayed Fax**

Sends your fax at a specified later time that day.

### **Distinctive Ring**

A subscriber service purchased from the telephone company that gives you another telephone number on an existing telephone line. The Brother machine uses the new number to simulate a dedicated fax line.

### **Dual Access**

Your machine can scan outgoing faxes or scheduled jobs into memory at the same time it is sending a fax or receiving or printing an incoming fax.

**Easy Receive**

Enables your machine to respond to CNG tones if you interrupt a fax call by answering it.

**ECM (Error Correction Mode)**

Detects errors during fax transmission and resends the pages of the fax that had an error.

**Extension telephone**

A telephone on the fax number that is plugged into a separate telephone wall jack.

**External telephone**

A telephone that is plugged into the EXT jack of your machine.

**F/T Ring Time**

The length of time that the Brother machine pseudo/double-rings (when the Receive Mode setting is Fax/Tel) to notify you to pick up a voice call that it answered.

**Fax Forwarding**

Sends a fax received into the memory to another pre-programmed fax number.

**Fax Journal**

Lists information about the last 200 incoming and outgoing faxes. TX means Transmit. RX means Receive.

**Fax Receive Code**

Press this code (\* 5 1) when you answer a fax call on an extension or external telephone.

**Fax Storage**

You can store faxes in the memory.

**Fax tones**

The signals sent by sending and receiving fax machines while communicating information.

**Fax/Tel**

You can receive faxes and telephone calls. Do not use this mode if you are using a telephone answering device (TAD).

**Fine resolution**

Resolution is 203 × 196 dpi. It is used for small print and graphs.

**Gray scale**

The shades of gray available for copying and faxing photographs.

**Group number**

A combination of One Touch and Speed Dial numbers that are stored on a One Touch key or in a Speed Dial location for Broadcasting.

**Help list**

A printout of the complete Menu table that you can use to program your machine when you do not have the User's Guide with you.

**Journal Period**

The pre-programmed time period between automatically printed Fax Journal Reports. You can print the Fax Journal on demand without interrupting the cycle.

**LCD (liquid crystal display)**

The display screen on the machine that shows interactive messages during On-Screen Programming and shows the date and time when the machine is idle.

**Manual fax**

When you lift the handset of your external telephone or press **Hook** so you can hear the receiving fax machine answer before you press **Start** to begin transmission.

**Menu mode**

Programming mode for changing your machine's settings.

**OCR (optical character recognition)**

The bundled ScanSoft™ PaperPort™ 11SE with OCR or Presto!® PageManager® software application converts an image of text to text you can edit.

## One Touch

Keys on the machine's control panel where you can store numbers for easy dialing. You can store a second number on each key if you press **Shift** and the One Touch key together.

## Out of Paper Reception

Receives faxes into the machine's memory when the machine is out of paper.

## Overseas Mode

Makes temporary changes to the fax tones to accommodate noise and static on overseas telephone lines.

## Paging

This feature enables your machine to call your pager when a fax is received into its memory.

## Pause

Allows you to place a 3.5 second delay in the dialing sequence while you are dialing using the dial pad or while you are storing One Touch and Speed Dial numbers. Press **Redial/Pause** as many times as needed for longer pauses.

## Polling

The process of a fax machine calling another fax machine to retrieve waiting fax messages.

## Pulse (Canada only)

A form of rotary dialing on a telephone line.

## Real Time Transmission

When memory is full, you can send faxes in real time.

## Remaining jobs

You can check which programmed fax jobs are waiting in the memory and cancel the jobs individually.

## Remote Access Code

Your own four-digit code (— — —\*) that allows you to call and access your machine from a remote location.

## Remote Retrieval Access

The ability to access your machine remotely from a touch tone telephone.

## Resolution

The number of vertical and horizontal lines per inch.

## Ring Delay

The number of rings before the machine answers in **Fax Only** and **Fax/Tel** modes.

## Ring Volume

Volume setting for the machine's ring.

## Scanning

The process of sending an electronic image of a paper document into your computer.

## Search

An electronic, alphabetical listing of stored One Touch, Speed Dial and Group numbers.

## Speed Dial

A pre-programmed number for easy dialing. You must press **Search/Speed Dial**, then enter the three-digit Speed Dial location and press **Start** to begin the dialing process.

## Station ID

The stored information that appears on the top of faxed pages. It includes the sender's name and fax number.

## TAD (telephone answering device)

You can connect an external device or answering machine to the EXT. jack of your machine.

## Telephone Answer Code (Fax/Tel mode only)

When the machine answers a voice call, it pseudo/double-rings. You can pick up at an extension telephone by pressing this code (**# 5 1**).

## Tel Index List

A listing of names and numbers stored in One Touch and Speed Dial memory, in numerical order.



**Temporary settings**

You can choose certain options for each fax transmission and copy without changing the default settings.

**Tone**

A form of dialing on the telephone line used for Touch Tone telephones.

**Transmission**

The process of sending faxes over the telephone lines from your machine to the receiving fax machine.

**Transmission Verification Report**

A report for each transmission, that shows its date, time and number.

**User Settings List**

A printed report that shows the current settings of the machine.

# F

# Index

- A**
- Accessories and supplies ..... ii
  - ADF (automatic document feeder)
    - faxing ..... 32
    - using ..... 18
  - Answering machine (TAD)
    - connecting ..... 48
  - Apple® Macintosh®
    - See Software User's Guide on the CD-ROM.
  - Automatic
    - fax receive ..... 40
    - easy receive ..... 42
    - fax redial ..... 54
- B**
- Broadcasting ..... 33
    - canceling ..... 33
    - setting up groups for ..... 56
  - Brother
    - accessories and supplies ..... ii
    - Brother numbers ..... i
    - Customer Service ..... i
    - FAQs (frequently asked questions) ..... i
    - product support ..... i
    - service centers ..... i
    - warranties ..... iii, iv, vi
- C**
- Canceling
    - broadcast in process ..... 33
    - fax jobs in memory ..... 38
    - jobs awaiting redial ..... 38
    - print jobs ..... 8
    - remote fax options ..... 61
  - Cleaning
    - corona wire ..... 122
    - drum unit ..... 123
    - laser scanner window ..... 120
    - scanner glass ..... 119
  - Connecting
    - external TAD (answering machine) ..... 47
    - external telephone ..... 51
    - two-line external TAD or telephone ..... 49
  - Consumable items ..... 126
  - Control panel overview ..... 6
  - ControlCenter2 (for Macintosh®)
    - See Software User's Guide on the CD-ROM.
  - ControlCenter3 (for Windows®)
    - See Software User's Guide on the CD-ROM.
  - Copy
    - contrast ..... 70, 74
    - Enlarge/Reduce key ..... 71
    - enter copy mode ..... 70
    - keys ..... 8, 71
    - multiple ..... 70
    - N in 1 (page layout) ..... 74
    - out of memory ..... 75
    - quality ..... 73
    - single ..... 70
    - sort (ADF only) ..... 73
    - temporary settings ..... 71
    - using ADF ..... 73, 75
    - using scanner glass ..... 74, 75
  - Cordless telephone (non-Brother) ..... 51
  - Cover page ..... 34
    - custom comments ..... 34
    - for all faxes ..... 35
    - for next fax only ..... 34
    - printed form ..... 35
  - Custom Ringing ..... 44
- D**
- Data Ident-A-Call ..... 44
  - Delayed batch transmission ..... 37
  - Dialing
    - a pause ..... 54
    - access codes and
      - credit card numbers ..... 57
      - automatic fax redial ..... 54
      - dial prefix ..... 23
      - groups (broadcasting) ..... 33
      - manual ..... 53
      - one touch ..... 53
      - restricting dialing ..... 29
      - speed dial ..... 53
      - using the Search key ..... 54
  - Distinctive ring ..... 44

|                                 |          |
|---------------------------------|----------|
| choosing ring pattern .....     | 45       |
| setting ring pattern .....      | 46       |
| turning off .....               | 46       |
| Document                        |          |
| how to load .....               | 18, 19   |
| jam .....                       | 113      |
| Drum unit                       |          |
| checking (remaining life) ..... | 133      |
| cleaning .....                  | 122, 123 |
| replacing .....                 | 130      |
| Dual access .....               | 36       |

## E

|                                      |                        |
|--------------------------------------|------------------------|
| Enlarge/Reduce key .....             | 71                     |
| Envelopes .....                      | 11, 14, 15, 16, 17, 97 |
| how to load .....                    | 11                     |
| Equalization .....                   | 106                    |
| Error messages on LCD .....          | 107                    |
| Comm. Error .....                    | 107                    |
| Init Unable XX .....                 | 109                    |
| No Paper .....                       | 109                    |
| Not Registered .....                 | 53                     |
| Out of Memory .....                  | 110                    |
| Print Unable XX .....                | 110                    |
| Scan Unable XX .....                 | 111                    |
| Extension telephone, using .....     | 50, 51                 |
| External telephone, connecting ..... | 51                     |

## F

|                                |        |
|--------------------------------|--------|
| Fax codes                      |        |
| changing .....                 | 52, 62 |
| fax receive code .....         | 50, 51 |
| remote access code .....       | 62     |
| telephone answer code .....    | 50, 51 |
| Fax forwarding                 |        |
| changing remotely .....        | 63, 64 |
| programming a number .....     | 58     |
| Fax storage .....              | 59     |
| printing from memory .....     | 43     |
| turning off .....              | 61     |
| turning on .....               | 59     |
| Fax, stand-alone               |        |
| receiving .....                | 39     |
| at end of conversation .....   | 43     |
| easy receive .....             | 42     |
| fax forwarding .....           | 64     |
| fax receive stamp .....        | 43     |
| from extension telephone ..... | 51     |

|                                         |        |
|-----------------------------------------|--------|
| from external telephone .....           | 50     |
| paging .....                            | 59     |
| polling receive .....                   | 65     |
| reducing to fit on paper .....          | 43     |
| retrieving from a remote site .....     | 63, 64 |
| ring delay, setting .....               | 41     |
| sequential polling .....                | 65     |
| telephone line interference .....       | 106    |
| sending .....                           | 20, 32 |
| at end of conversation .....            | 38     |
| broadcasting .....                      | 33     |
| canceling from memory .....             | 38     |
| contrast .....                          | 35     |
| delayed batch .....                     | 37     |
| delayed fax .....                       | 37     |
| from ADF .....                          | 32     |
| from memory (dual access) .....         | 36     |
| from scanner glass .....                | 32     |
| manual .....                            | 38     |
| overseas .....                          | 37     |
| polled transmit .....                   | 66     |
| real time transmission .....            | 36     |
| resolution .....                        | 36     |
| telephone line interference .....       | 106    |
| Fax/Tel mode                            |        |
| answering at extension telephones ..... | 50, 51 |
| easy receive .....                      | 42     |
| F/T ring time (double-ring) .....       | 41     |
| fax receive code .....                  | 50, 51 |
| receiving faxes .....                   | 51     |
| ring delay .....                        | 41     |
| telephone answer code .....             | 50, 51 |
| Folio .....                             | 15     |
| Function Lock .....                     | 25     |

## G

|                               |          |
|-------------------------------|----------|
| Gray scale .....              | 155, 158 |
| Groups for broadcasting ..... | 56       |

## H

|                       |          |
|-----------------------|----------|
| HELP .....            | 68       |
| Help List .....       | 68       |
| LCD messages .....    | 135      |
| Menu Table .....      | 135, 137 |
| using menu keys ..... | 135      |
| Hook key .....        | 8, 51    |

## I

|                    |    |
|--------------------|----|
| Ident-A-Call ..... | 44 |
| Ident-A-Ring ..... | 44 |

## J

|                               |     |
|-------------------------------|-----|
| Jacks                         |     |
| convert to RJ11 jack          |     |
| triplex adapter .....         | 49  |
| EXT                           |     |
| external telephone .....      | 51  |
| TAD (answering machine) ..... | 47  |
| Jams                          |     |
| document .....                | 113 |
| paper .....                   | 114 |
| Job Cancel key .....          | 8   |

## L

|                                    |                             |
|------------------------------------|-----------------------------|
| Labels .....                       | 10, 11, 14, 15, 18, 97, 154 |
| LCD (liquid crystal display) ..... | 8, 135                      |
| contrast .....                     | 22                          |
| Help List .....                    | 68                          |

## M

|                                          |          |
|------------------------------------------|----------|
| Machine information                      |          |
| checking remaining life of drum unit ... | 133      |
| page counts .....                        | 132      |
| Macintosh®                               |          |
| See Software User's Guide on the         |          |
| CD-ROM.                                  |          |
| Maintenance, routine .....               | 118      |
| checking the remaining life              |          |
| of drum unit .....                       | 133      |
| replacing                                |          |
| drum unit .....                          | 130      |
| toner cartridge .....                    | 126      |
| Manual                                   |          |
| dialing .....                            | 53       |
| receive .....                            | 39, 40   |
| transmission .....                       | 38       |
| Memory                                   |          |
| storage .....                            | 135      |
| Menu Table .....                         | 135, 137 |
| using menu keys .....                    | 135      |
| Mode, entering                           |          |
| copy .....                               | 70       |

|                                    |    |
|------------------------------------|----|
| fax .....                          | 32 |
| scan .....                         | 8  |
| Multi-line connections (PBX) ..... | 50 |

## N

|                                  |    |
|----------------------------------|----|
| N in 1 (page layout) .....       | 74 |
| Network                          |    |
| faxing                           |    |
| See Software User's Guide on the |    |
| CD-ROM.                          |    |
| printing                         |    |
| See Network User's Guide on the  |    |
| CD-ROM.                          |    |
| scanning                         |    |
| See Software User's Guide on the |    |
| CD-ROM.                          |    |

## O

|                             |             |
|-----------------------------|-------------|
| One touch                   |             |
| changing .....              | 55          |
| setting up .....            | 54          |
| using .....                 | 53          |
| Out of Memory message ..... | 38, 75, 110 |

## P

|                                           |               |
|-------------------------------------------|---------------|
| Packing and shipping the machine .....    | 133           |
| Page layout (N in 1) .....                | 74            |
| Paging .....                              | 59            |
| programming your pager number ...         | 58, 59        |
| Paper .....                               | 14, 154       |
| how to load .....                         | 9             |
| jam .....                                 | 114           |
| recommended .....                         | 14, 15        |
| size .....                                | 14, 20        |
| size of document .....                    | 155, 157, 158 |
| tray capacity .....                       | 15            |
| type .....                                | 14, 20        |
| PaperPort™ 11SE with OCR                  |               |
| See Software User's Guide on the          |               |
| CD-ROM and Help in the PaperPort™         |               |
| 11SE application to access How-to-Guides. |               |
| PC Fax                                    |               |
| See Software User's Guide on the          |               |
| CD-ROM.                                   |               |
| Personalized Ring .....                   | 44            |
| Polling                                   |               |
| polled transmit .....                     | 66            |

|                                             |         |
|---------------------------------------------|---------|
| polling receive .....                       | 65      |
| sequential polling .....                    | 65      |
| Power failure .....                         | 135     |
| Print                                       |         |
| difficulties .....                          | 93, 95  |
| drivers .....                               | 159     |
| fax from memory .....                       | 43      |
| Job Cancel key .....                        | 8       |
| keys .....                                  | 8       |
| paper jams .....                            | 114     |
| quality .....                               | 97, 100 |
| reports .....                               | 68      |
| resolution .....                            | 159     |
| Secure key .....                            | 8       |
| specifications .....                        | 159     |
| Printing                                    |         |
| See Software User's Guide on the<br>CD-ROM. |         |
| Programming your machine .....              | 135     |

## Q

|                                               |         |
|-----------------------------------------------|---------|
| Quality                                       |         |
| copying .....                                 | 72, 73  |
| printing .....                                | 97, 100 |
| Quick dial .....                              | 54      |
| access codes and<br>credit card numbers ..... | 57      |
| broadcasting .....                            | 33      |
| using groups .....                            | 33      |
| group dial                                    |         |
| changing .....                                | 55      |
| setting up groups for broadcasting .....      | 56      |
| one touch dial                                |         |
| changing .....                                | 55      |
| custom scan profile .....                     | 54      |
| setting up .....                              | 54      |
| using .....                                   | 53      |
| search .....                                  | 54      |
| speed dial                                    |         |
| changing .....                                | 55      |
| custom scan profile .....                     | 55      |
| setting up .....                              | 55      |
| using .....                                   | 53      |

## R

|                        |        |
|------------------------|--------|
| Redial/Pause key ..... | 54, 57 |
| Reducing               |        |
| copies .....           | 71     |

|                                             |         |
|---------------------------------------------|---------|
| incoming faxes .....                        | 43      |
| Remote retrieval .....                      | 62      |
| access code .....                           | 62      |
| commands .....                              | 64      |
| getting your faxes .....                    | 63      |
| Remote setup                                |         |
| See Software User's Guide on the<br>CD-ROM. |         |
| Replacing                                   |         |
| drum unit .....                             | 130     |
| toner cartridge .....                       | 126     |
| Reports .....                               | 67, 68  |
| Fax Journal .....                           | 67, 68  |
| journal period .....                        | 67      |
| Help List .....                             | 68      |
| how to print .....                          | 68      |
| Network Configuration .....                 | 68      |
| Tel Index List .....                        | 68      |
| Transmission Verification .....             | 67      |
| User Settings .....                         | 68      |
| Resolution                                  |         |
| copy .....                                  | 157     |
| fax                                         |         |
| (standard, fine, superfine, photo) .        | 36, 155 |
| print .....                                 | 159     |
| scan .....                                  | 158     |
| setting for next fax .....                  | 36      |
| Resolution key .....                        | 8, 36   |
| Restricted users .....                      | 26      |
| Ring delay, setting .....                   | 41      |
| RingMaster .....                            | 44      |

## S

|                                             |            |
|---------------------------------------------|------------|
| Safety instructions .....                   | 90         |
| Scanner glass                               |            |
| faxing .....                                | 32         |
| using .....                                 | 19         |
| Scanning                                    |            |
| See Software User's Guide on the<br>CD-ROM. |            |
| Search/Speed Dial key .....                 | 53, 54, 56 |
| Secure key .....                            | 8          |
| Security                                    |            |
| restricting dialing .....                   | 29         |
| Secure function lock                        |            |
| administrator password .....                | 25         |
| Public user .....                           | 26         |
| restricted users .....                      | 26         |
| Secure key .....                            | 8          |

|                                |                        |
|--------------------------------|------------------------|
| Setting lock .....             | 28                     |
| Serial number                  |                        |
| how to find.....               | See inside front cover |
| Service centers .....          | i                      |
| Shipping the machine .....     | 133                    |
| SimpleBiz Fax &                |                        |
| Alternate Number Ringing ..... | 44                     |
| Sleep time .....               | 22                     |
| Smart Ring .....               | 44                     |
| Sort .....                     | 73                     |
| Speed dial                     |                        |
| changing .....                 | 55                     |
| setting up .....               | 55                     |
| using .....                    | 53                     |

## T

---

|                                   |                        |
|-----------------------------------|------------------------|
| TAD (telephone answering device), |                        |
| external .....                    | 39, 40, 49             |
| connecting .....                  | 47, 48                 |
| recording OGM .....               | 48                     |
| with two-line jack .....          | 49                     |
| Teen Ring .....                   | 44                     |
| Telephone line                    |                        |
| connections .....                 | 48                     |
| difficulties .....                | 94                     |
| interference .....                | 106                    |
| multi-line (PBX) .....            | 50                     |
| roll over lines .....             | 48                     |
| two-line telephone system .....   | 49                     |
| Temporary copy settings .....     | 71                     |
| Text, entering .....              | 150                    |
| Toner cartridge, replacing .....  | 126                    |
| Toner save .....                  | 22                     |
| Transparency .....                | 9, 10, 14, 15, 97, 154 |
| Troubleshooting .....             | 93                     |
| document jam .....                | 113                    |
| error messages on LCD .....       | 107                    |
| if you are having difficulty      |                        |
| copy quality .....                | 95                     |
| incoming calls .....              | 94                     |
| network .....                     | 97                     |
| paper handling .....              | 96                     |
| print quality .....               | 97, 100                |
| printing .....                    | 93, 95                 |
| scanning .....                    | 96                     |
| software .....                    | 96                     |
| telephone line .....              | 106                    |
| maintenance messages on LCD ..... | 107                    |
| paper jam .....                   | 114                    |

|                                 |    |
|---------------------------------|----|
| Two-line telephone system ..... | 49 |
|---------------------------------|----|

## V

---

|                  |    |
|------------------|----|
| Voice mail ..... | 44 |
| Volume, setting  |    |
| beeper .....     | 21 |
| ring .....       | 21 |
| speaker .....    | 21 |

## W

---

|                                       |     |
|---------------------------------------|-----|
| Warranties                            |     |
| Canada .....                          | vi  |
| Notice-Disclaimer .....               | iii |
| USA .....                             | iv  |
| Windows®                              |     |
| See Software User's Guide on the      |     |
| CD-ROM.                               |     |
| Wireless Network                      |     |
| See Software User's Guide and Network |     |
| User's Guide on the CD-ROM.           |     |
| World Wide Web .....                  | i   |

## **EQUIPMENT ATTACHMENT LIMITATIONS (Canada only)**

### **NOTICE**

This product meets the applicable Industry Canada technical specifications.

### **NOTICE**

The Ringer Equivalence Number is an indication of the maximum number of devices allowed to be connected to a telephone interface. The termination on an interface may consist of any combination of devices subject only to the requirement that the sum of the RENs of all the devices does not exceed five.

Brother International Corporation  
100 Somerset Corporate Boulevard  
P.O. Box 6911  
Bridgewater, NJ 08807-0911 USA

Brother International Corporation (Canada) Ltd.  
1 rue Hôtel de Ville,  
Dollard-des-Ormeaux, QC, Canada H9B 3H6

**brother**®

**Visit us on the World Wide Web**  
**<http://www.brother.com/>**

These machines are made for use in the USA and Canada only. We cannot recommend using them overseas because it may violate the Telecommunications Regulations of that country and the power requirements of your machine may not be compatible with the power available in foreign countries. **Using USA or Canada models overseas is at your own risk and may void your warranty.**



## Free Manuals Download Website

<http://myh66.com>

<http://usermanuals.us>

<http://www.somanuals.com>

<http://www.4manuals.cc>

<http://www.manual-lib.com>

<http://www.404manual.com>

<http://www.luxmanual.com>

<http://aubethermostatmanual.com>

Golf course search by state

<http://golfingnear.com>

Email search by domain

<http://emailbydomain.com>

Auto manuals search

<http://auto.somanuals.com>

TV manuals search

<http://tv.somanuals.com>