

# USING A MEMORY CARD

You can expand the storage capabilities of your camera by using a commercially available memory card (SD memory card or MultiMediaCard). You can also copy files from built-in flash memory to a memory card and from a memory card to flash memory.



- Normally, files are stored in built-in flash memory. When you insert a memory card, however, the camera automatically stores files to the card.
- Note that you cannot save files to built-in memory while a memory card is installed in the camera.

## ▶▶ IMPORTANT! ◀◀

- Use only an SD memory card or a MultiMediaCard with this camera. Proper operation is not guaranteed when any other type of card is used.
- See the instructions that come with the memory card for information about how to use it.
- Certain types of cards can slow down processing speeds.
- SD memory cards have a write protect switch, which you can use to protect against accidental deletion of image data. Note, however, if you write protect an SD memory card, you must remove write protection whenever you want to record to it, format it, or delete any of its files.
- Electrostatic charge, electrical noise, and other phenomena can cause data to become corrupted or even lost. Always make sure that you always back up important data on other media (CD-R, CD-RW, MO disc, computer hard disk, etc.)

### Using a Memory Card

#### ▶▶ IMPORTANT! ◀◀

- Make sure you turn off the camera before inserting or removing a memory card.
- Be sure to orient the card correctly when inserting it. Never try to force a memory card into the slot when you feel resistance.

### To insert a memory card into the camera

1. Positioning the memory card so its back is facing in the same direction as the camera's lens, carefully slide it into the card slot.

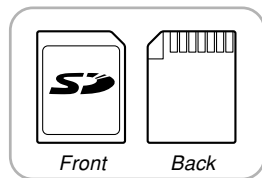
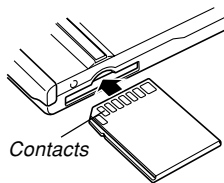

### To remove a memory card from the camera

1. Press the memory card into the camera and then release it. This will cause the card to come part way out of the camera.
2. Pull the memory card out of the slot.

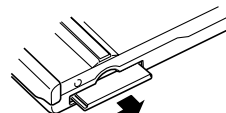
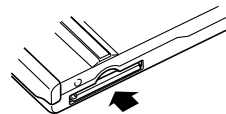

### ▶▶ IMPORTANT! ◀◀

- Never insert any other object besides a memory card into the camera's card slot. Doing so creates the risk of damage to the camera and card.
- Should water or any foreign object ever get into the card slot, immediately turn off the camera, remove the battery, and contact your dealer or nearest CASIO authorized service center.
- Never remove a card from the camera while the operation/flash charge lamp is flashing. Doing so can cause the file save operation to fail, and even damage the memory card.

## Formatting a Memory Card

Formatting a memory card deletes any data already stored on it.

### ▶▶ IMPORTANT! ◀◀

- Be sure to use the camera to format a memory card. Formatting a memory card on a computer and then using it in the camera can slow down data processing by the camera. In the case of an SD card, formatting on a computer can result in non-conformity with the SD format, causing problems with compatibility, operation, etc.
- Note that data deleted by a memory card format operation cannot be recovered. Check to make sure you do not need any of the data on the memory card before you format it.
- Formatting a memory card that contains files deletes all the files, even those that are protected (page 100).

1. Load the memory card into the camera.
2. Turn on the camera. Next, enter the REC mode or PLAY mode and press [MENU].
3. Select the “Set Up” tab, select “Format”, and then press [▶].
4. Use [▲] and [▼] to select “Format”, and then press [SET].
  - To exit the format operation without formatting, select “Cancel”.

## Memory Card Precautions

- If a memory card starts to behave abnormally, you can restore normal operation by reformatting it. However, we recommend that you always take along more than one memory card whenever using the camera far away from the home or office.
- We recommend that you format a memory card before using it for the first time after purchasing it, or whenever the card you are using seems to be the cause of abnormal images.
- Before starting a format operation, check to make sure that the battery is fully charged. Power interruption during the format operation can result in improper formatting, and even damage the memory card and make it unusable.

### Copying Files

Use the procedures below to copy files between built-in memory and a memory card.

#### ▶▶▶ IMPORTANT! ◀◀◀

- Only snapshot, movie files, audio snapshot (EX-M20 only), and voice recording files (EX-M20 only) recorded with this camera can be copied. Other files cannot be copied.
- Copying an audio snapshot (EX-M20 only) copies both the image file and the audio file.

### To copy all the files in built-in memory to a memory card

1. Load the memory card into the camera.
2. Turn on the camera. Next, enter the PLAY mode and press [MENU].
3. Select the “PLAY” tab, select “Copy”, and then press [▶].



4. Use [▲] and [▼] to select “Built-in → Card”, and then press [SET].
  - This starts the copy operation and displays the message “Busy.... Please wait...”.
  - After the copy operation is complete, the monitor screen shows the last file in the folder.

## To copy a file from a memory card to built-in memory

With this procedure you can copy one file at a time.

1. Perform steps 1 through 3 of the procedure under “To copy all the files in built-in memory to a memory card”.
2. Use [▲] and [▼] to select “Card → Built-in”, and then press [SET].
3. Use [◀] and [▶] to select the file you want to copy.
4. Use [▲] and [▼] to select “Copy”, and then press [SET].
  - This starts the copy operation and displays the message “Busy.... Please wait...”.
  - The file reappears on the monitor screen after the copy operation is complete.
  - Repeat steps 3 through 4 to copy other images, if you want.
5. Press [MENU] to exit the copy operation.

### NOTE

- Files are copied to the folder in built-in memory whose name has the largest number.

# VIEWING IMAGES ON A COMPUTER

After using the USB cradle to establish a USB connection between the camera and your computer, you can use your computer to view images in file memory and copy images to your computer's hard disk or other storage media. In order to do this, you first need to install the USB driver located on the CD-ROM that comes bundled with the camera onto your computer.

Note that the procedure you need to perform depends on whether you are using computer running under Windows (see below) or a Macintosh (see page 136).

## Using the Camera with a Windows Computer

The following are the general steps for viewing and copying files from a computer running under Windows. You can find details about each operation in the procedures that follow below. Note that you should also refer to the documentation that comes with your computer for other information about USB connections, etc.

1. If you are running Windows 98, Me, or 2000, install the USB driver onto your computer.
  - You need to perform this step only once, the first time you connect to your computer.
  - If you are running Windows XP, you do not need to install the USB driver.



2. Use the USB cradle to establish a connection between the camera and computer.



3. View and copy the images you want.

## VIEWING IMAGES ON A COMPUTER

### »» IMPORTANT! ««

- Do not try to establish a connection between the camera and computer before installing the USB driver onto the computer.
- If you want to transfer files from the camera's built-in memory to a computer, make sure there is no memory card loaded in the camera before you place it onto the USB cradle.

### 1. What you should do first depends on whether your computer is running under Windows 98/Me/2000 or Windows XP.

#### ■ Windows 98/Me/2000 Users

- Start from step 2 to install the USB driver.
- Note that the example installation presented here uses Windows 98.

#### ■ Windows XP Users

- Installation of the USB driver is not required, so jump directly to step 6.

### 2. Set the bundled CD-ROM into the CD-ROM drive of your computer.

### 3. On the menu screen that appears, click “English”.



### 4. Click [USB driver] and then [Install].

- This starts installation.
- The following steps show installation under the English version of Windows.

### 5. On the screen that appears after installation is complete, select the “Yes, I want to restart my computer now.” check box and then click [Finish] to restart your computer.



## VIEWING IMAGES ON A COMPUTER

6. Connect the AC power cord to the bundled AC adaptor, and then plug the other end of the AC power cord into a household power outlet.
7. Connect the AC adaptor to the [DC IN 5.3V] connector of the USB cradle.

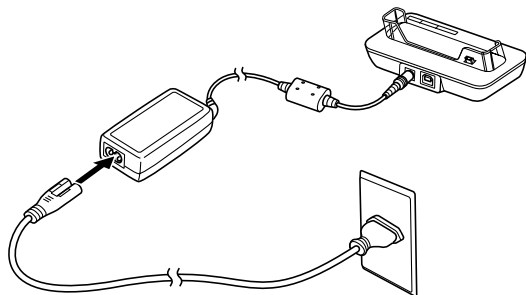

8. Connect the USB cable that comes bundled with the camera to the USB cradle and your computer's USB port.

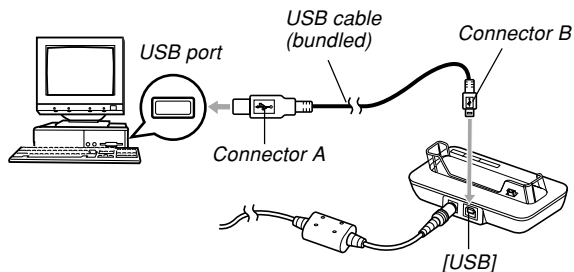

- Take care when connecting the USB cable to the USB cradle or your computer. USB ports and cable plugs are shaped for proper positioning.
- Plug the USB cable plugs into the ports securely, as far as they will go. Proper operation is not possible if connections are not correct.

### 9. After making sure the camera is turned off, place the camera onto the USB cradle.

- Do not place the camera onto the USB cradle while it is turned on.

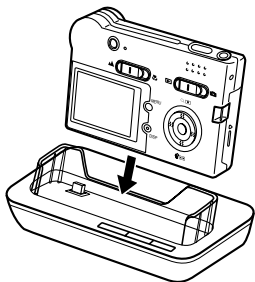

### 10. Press the USB cradle's [USB] button.

- This will cause the “Add New Hardware...” dialog box to appear on the computer screen as the computer automatically detects the camera’s file memory. After you install the USB driver, “Add New Hardware...” dialog box will no longer appear when you perform the above steps to establish a USB connection.
- Pressing the [USB] button enters the USB mode, which causes the USB cradle’s [USB] lamp to light green (page 177).
- At this point, some operating systems will display a “Removable Disk” dialog box. If your operating system does, close the dialog box.

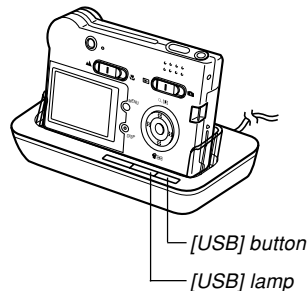

11. On your computer, double-click “My Computer”.
12. Double-click “Removable Disk”.
  - Your computer sees the camera’s file memory as a removable disk.
13. Double-click the “Dcim” folder.
14. Double-click the folder that contains the image you want.
15. Double-click the file that contains the image you want to view.
  - For information about file names, see “Memory Directory Structure” on page 142.
16. To copy all the files in file memory to your computer’s hard disk, drag the “Dcim” folder from “Removable Disk” to the “My Documents” folder on your computer.

### ▶▶ IMPORTANT! ◀◀

- Never use your computer to edit, delete, move, or rename images stored in file memory. Doing so can cause problems with the image management data used by the camera, which may make it impossible to display images on the camera or it may cause a large error in the number of images value displayed by the camera. Always copy images to your computer memory before performing any edit, delete, move, or rename operation.
17. Depending on the version of Windows you are running, use one of the following procedures to terminate the USB connection.
    - **WindowsMe/98 Users**
      - After pressing the USB cradle [USB] button and making sure that the [USB] lamp is not lit, remove the camera from the USB cradle.
    - **Windows2000/XP Users**
      - Click card services in the task tray on your computer screen, and disable the drive number assigned to the camera. After pressing the USB cradle [USB] button and making sure that the [USB] lamp is not lit, remove the camera from the USB cradle.

### USB Connection Precautions

- Be sure to read the documentation that comes with your computer for other important information about USB connections.
- Be sure to connect the AC adaptor to the USB cradle to supply power to the camera.
- USB data communication is performed regardless of the current setting of the camera's mode selector.
- Do not leave the same image displayed on your computer screen for a long time. Doing so can cause the image to "burn in" on the screen.
- Never disconnect the USB cable, or perform any camera or USB cradle operation while data communication is in progress. Doing so can cause data to become corrupted.

### Using the Camera with a Macintosh Computer

The following are the general steps for viewing and copying files from a Macintosh.

You can find details about each operation in the procedures that follow below. Note that you should also refer to the documentation that comes with your Macintosh for other information about USB connections, etc.

#### ▶▶ IMPORTANT! ◀◀

- This camera does not support operation with a computer running Mac OS 8.6 or lower, or Mac OS X 10.0. If you have a Macintosh running Mac OS 9 or OS X (10.1, 10.2 or higher), use the standard USB driver that comes with your OS.

1. Use the USB cradle to establish a connection between the camera and your Macintosh.



2. View and copy the images you want.

## VIEWING IMAGES ON A COMPUTER

### ▶▶ IMPORTANT! ◀◀

- If you want to transfer files from the camera's built-in memory to a computer, make sure there is no memory card loaded in the camera before you place it onto the USB cradle.

1. Connect the AC power cord to the bundled AC adaptor, and then plug the other end of the AC power cord into a household power outlet.
2. Connect the AC adaptor to the [DC IN 5.3V] connector of the USB cradle.

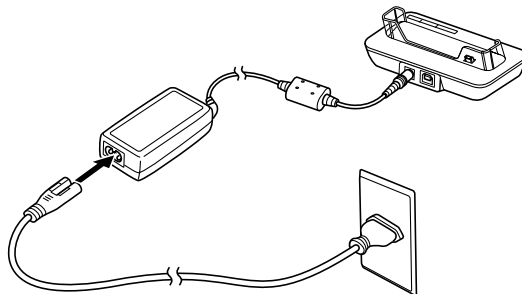

## VIEWING IMAGES ON A COMPUTER

- 3. Connect the USB cable that comes bundled with the camera to the USB cradle and your computer's USB port.**

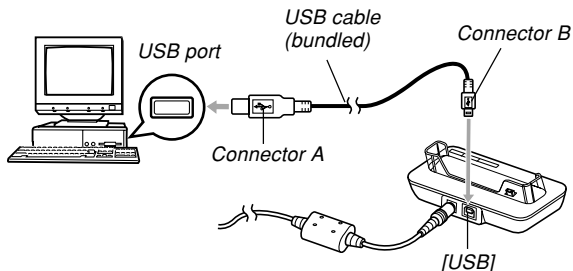

- Take care when connecting the USB cable to the USB cradle or your computer. USB ports and cable plugs are shaped for proper positioning.
- Plug the USB cable plugs into the ports securely, as far as they will go. Proper operation is not possible if connections are not correct.

- 4. After making sure the camera is turned off, place the camera onto the USB cradle.**

- Do not place the camera onto the USB cradle while it is turned on.

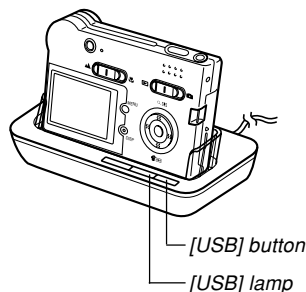

### 5. Press the USB cradle's [USB] button.

- Pressing the [USB] button enters the USB mode, which causes the USB cradle's [USB] lamp to light green (page 177).

### 6. Your Macintosh will see the camera's file memory as a drive.

- The appearance of the drive icon depends on the Mac OS version you are using.
- After installing the USB driver, your Macintosh will see the camera's file memory as a drive whenever you establish a USB connection between them.

### 7. Double-click the drive icon for the camera's file memory, the "DCIM" folder, and then the folder that contains the image you want.

### 8. Double-click the file that contains the image you want to view.

- For information about file names, see "Memory Directory Structure" on page 142.

### 9. To copy all the files in file memory to your Macintosh hard disk, drag the "DCIM" folder to the folder to which you want to copy it.

#### ▶▶ IMPORTANT! ◀◀

- Never use your computer to edit, delete, move, or rename images stored in file memory. Doing so can cause problems with the image management data used by the camera, which may make it impossible to display images on the camera or it may cause a large error in the number of images value displayed by the camera. Always copy images to your computer memory before performing any edit, delete, move, or rename operation.

### 10. To terminate the USB connection, drag the drive icon that represents the camera to Trash. After pressing the USB cradle [USB] button and making sure that the [USB] lamp is not lit, remove the camera from the USB cradle.

### USB Connection Precautions

- Be sure to read the documentation that comes with your computer for other important information about USB connections.
- Be sure to connect the AC adaptor to the USB cradle to supply power to the camera.
- USB data communication is performed regardless of the current setting of the camera's mode selector.
- Do not leave the same image displayed on your computer screen for a long time. Doing so can cause the image to "burn in" on the screen.
- Never disconnect the USB cable, or perform any camera or USB cradle operation while data communication is in progress. Doing so can cause data to become corrupted.

### Operations You Can Perform from Your Computer

The following are the operations you can perform while there is a USB connection between your camera and computer. See the referenced pages for more information about each operation.

- View images in album format  
.... See "Using the Album Feature" on page 145.
- Print images in album format  
.... See "Using the Album Feature" on page 145.
- Automatically transfer images to your computer and manage images  
.... See "Installing the Software from the CD-ROM" on page 152 for information about installing Photo Loader.
- Retouch images  
.... See "Installing the Software from the CD-ROM" on page 152 for information about installing Photohands.



### Using a Memory Card to Transfer Images to a Computer

The procedures in this section describe how to transfer images from the camera to your computer using a memory card.

#### Using a Computer with a Built-in SD Memory Card Slot

Insert the SD memory card directly into the slot.

#### Using a Computer with a Built-in PC Card Slot

Use a commercially available PC card adapter (for an SD memory card/MMC). For full details, see the user documentation that comes with the PC card adapter and your computer.

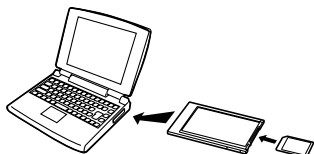

#### Using a Commercially Available SD Memory Card Reader/Writer

See the user documentation that comes with the SD memory card reader/writer for details about how to use it.

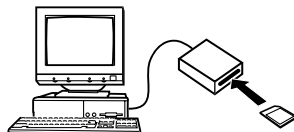

#### Using a Commercially Available PC Card Reader/Writer and PC Card Adapter (for SD Memory Cards and MMCs)

See the user documentation that comes with the PC card reader/writer and PC card adapter (for an SD memory card/MMC) for details about how to use them.

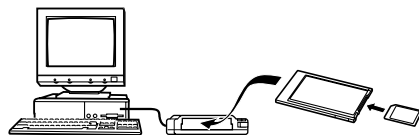

## Memory Data

Images recorded with this camera and other data are stored in memory using DCF (Design rule for Camera File System) protocol. DCF protocol is designed to make it easier to exchange image and other data between digital cameras and other devices.

## DCF Protocol

DCF devices (digital cameras, printers, etc.) can exchange images with each other. DCF protocol defines camera format for image file data and the directory structure for file memory, so images can be viewed using another manufacturer's DCF camera or printed on a DCF printer.

## Memory Directory Structure

### ■ Directory Structure

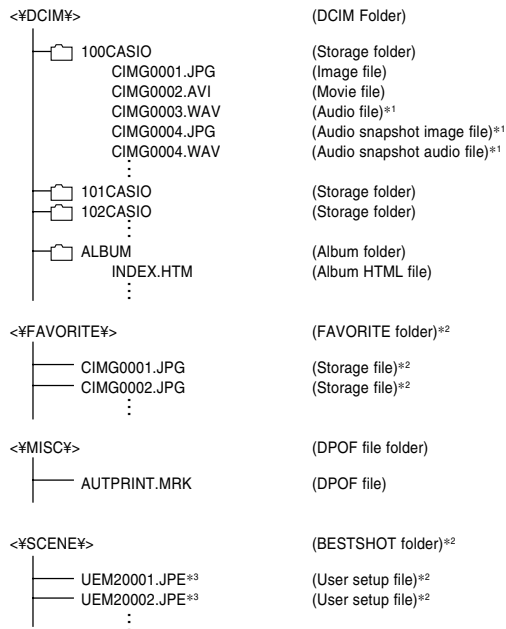

## VIEWING IMAGES ON A COMPUTER

<¥AUDIO¥>	(MP3 file folder)*1
├── *****.MP3	(MP3 file)*1
└── LASTPLAY	(LASTPLAY file)*1

\*1 These folders and files are for the EX-M20 only.

\*2 These folders are created in built-in memory only.

\*3 These file names are part of the EX-M20 file structure only.

With the EX-S20, files are named UES20001.JPE,  
UES20002.JPE, etc.

### ■ Folder and File Contents

- DCIM folder  
Folder that stores all of the digital camera files
- Storage folder  
Folder for storing files created by the digital camera
- Image file  
File that contains an image recorded with the digital camera (File Name Extension: JPG)
- Movie file  
File that contains a movie recorded with the digital camera (File Name Extension: AVI)
- Audio file (EX-M20 only)  
File that contains an audio recording (File Name Extension: WAV).

- Audio snapshot image file (EX-M20 only)  
File that contains the image part of an audio snapshot (File Name Extension: JPG).
- Audio snapshot audio file (EX-M20 only)  
File that contains the audio part of an audio snapshot (File Name Extension: WAV).
- Album folder  
Folder that contains files used by the album function
- Album HTML file  
File used by the album function (File Name Extension: HTM)
- FAVORITE folder (Built-in memory only)  
Folder that contains Favorites image files (Image Size: 320 x 240 pixels)
- DPOF file folder  
Folder that contains DPOF files
- BESTSHOT folder (Built-in memory only)  
Folder that contains BESTSHOT user setup files.
- User setup files (Built-in memory only)  
Files that contain BESTSHOT user setups

- MP3 files folder (EX-M20 only)  
Folder that contains MP3 files.
- LASTPLAY file (EX-M20 only)  
File that contains information about the last played MP3 file.

### Image Files Supported by the Camera

- Image files recorded with the CASIO EX-S20/EX-M20 Digital Camera
- DCF protocol image files

Certain DCF functions may not be supported. When displaying an image recorded on another camera model, it may take a long time for the image to appear on the display.

### Built-in Memory and Memory Card Precautions

- Note that the folder named “DCIM” is the parent (top) folder of all the files in memory. When transferring memory contents to a hard disk, CD-R, MO disk, or other external storage, treat all the contents inside a DCIM folder as a set and always keep them together. You can change the name of the DCIM folder on your computer. Changing the name to a date is a good way to keep track of multiple DCIM folders. However, if you even want to copy the folders back to the camera’s file memory, be sure you change the name of the DCIM folder back to “DCIM” first. The camera does not recognize any folder name other than DCIM.
- We also strongly recommend that after transferring data from file memory to other external storage that you reformat the camera’s file memory and delete its contents before using it to store more files. Remember that formatting memory deletes all of its contents. Check to make sure that you no longer need any of the files in memory before you format it.

# USING THE CAMERA WITH A COMPUTER

The album feature of the camera creates files that make it possible for you to view images on your computer in a photo album layout. You can also use the applications contained on the CD-ROM that comes bundled with the camera to automate image transfer and to retouch images.

## Using the Album Feature

The album feature creates an HTML photo album layout that displays your images. You can use the HTML layout to post your images on a Web page, or for printing the images.

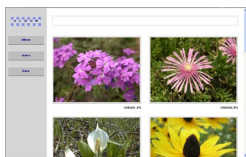

*Album*



*Index*



*Info*

- You can use the Web browser shown below to view or print the contents of an album. Note that to view a movie on a computer running Windows 2000 or 98, you need to install DirectX.

Microsoft Internet Explorer Ver 5.5 or later

## Creating an album

1. In the **PLAY** mode, press **[MENU]**.
2. Select the **“PLAY”** tab, select **“Create Album”**, and then press **[▶]**.

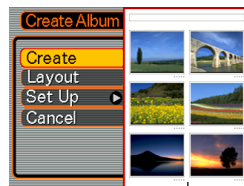

*Sample layout*

3. Use **[▲]** and **[▼]** to select **“Create”**, and then press **[SET]**.
  - This starts creation of the album, and causes the message **“Busy.... Please wait...”** to appear on the monitor screen.

- The PLAY mode screen reappears after creation of the album is complete.
- Creating an album causes a file folder named “ALBUM”, which contains a file named “INDEX.HTM” plus other files to be created in camera memory or on the memory card.

### ▶▶ IMPORTANT! ◀◀

- Never open the battery cover or remove the memory card from the camera while an album is being created. Doing so not only runs the risk of certain album files being skipped, it can also result in image data and other data in memory being corrupted.
- If memory becomes full while an album is being created, the message “Memory Full” appears on the monitor screen and album creation is terminated.
- Album creation will not be performed properly if the battery goes dead while album creation is in progress.
- You can also configure the camera to create albums automatically (page 148). However, performing the above procedure creates an album regardless of whether automatic album creation is turned on or off.

## Selecting an Album Layout

You can select from among 10 different display layouts for an album.

- 1. In the PLAY mode, press [MENU].**
- 2. Select the “PLAY” tab, select “Create Album”, and then press [▶].**
- 3. Use [▲] and [▼] to select “Layout”.**
- 4. Use [◀] and [▶] to select the layout you want.**
  - Changing the layout causes the layout sample on the right side of the screen to change.

### ▶▶ IMPORTANT! ◀◀

- The sample layout shows the arrangement of items and the background color. It does not show whether the layout uses a list view or detailed view, or the current Image Type setting.

## Configuring Detailed Album Settings

1. In the **PLAY** mode, press **[MENU]**.
2. Select the **“PLAY”** tab, select **“Create Album”**, and then press **[▶]**.
3. Use **[▲]** and **[▼]** to select **“Set Up”**, and then press **[▶]**.
4. Use **[▲]** and **[▼]** to select the item whose setting you want to change, and then press **[▶]**.



- Details about each of the settings are provided in the following sections.

5. Use **[▲]** and **[▼]** to change the setting, and then press **[SET]**.

### ■ Background Color

You can specify white, black, or gray as the color of the album background using the procedure under “Configuring Detailed Album Settings”.

### ■ Album Type

There are two album types: Normal and Index/Info.

**Normal Type** : This type of album displays images in accordance with the currently selected layout.

**Index/Info Type** : In addition to the normal album screen, this type of album also includes thumbnails of images and detailed information about each image.

### ■ Image Use

This setting lets you select from among three different image uses, as described below. Select the image use that best suits the way you plan to use the image.

For this purpose:	Select this setting:
<p>Smaller images for album browsing, Website thumbnails, or archiving on a CD-R or other media, with the full-size image displayed when a thumbnail is clicked</p> <ul style="list-style-type: none"> <li>This setting can be used for browsing with the thumbnails. Clicking a thumbnail displays a larger version for viewing or printing.</li> </ul>	View
<p>Small image files only for album browsing, or uploading to a Website, etc.</p> <ul style="list-style-type: none"> <li>This option displays only the small-file images (located in the camera's "ALBUM" folder). Smaller files upload to the Internet faster.</li> <li>You cannot enlarge images by clicking a thumbnail or play movies while this image is selected.</li> </ul>	WEB
<p>Printing (high resolution)</p> <ul style="list-style-type: none"> <li>High-resolution images take longer to display on your computer screen.</li> <li>You cannot enlarge images by clicking a thumbnail or play movies while this image is selected.</li> </ul>	Print

### ■ Auto Album Creation On/Off

This setting controls whether an album is created automatically whenever you turn off the camera.

To do this:	Select this option:
Turn on auto album creation	On
Turn off auto album creation	Off

- When auto album creation is turned on, an album is created automatically in built-in memory or on the memory card whenever you turn off the camera.

### ⓘ IMPORTANT! ⓘ

- When you turn off the camera while auto album creation is turned on, the monitor screen turns off, but the operation/flash charge lamp continues to flash for a few seconds to indicate that the album creation process is being performed. Never open the battery cover or remove the memory card while the operation/flash charge lamp is flashing green.



### NOTE

- Depending on the number of images in memory, it can take quite a bit of time to complete auto album creation when you turn off the camera. If you do not plan to use the album feature, we suggest that you keep auto album creation turned off, which shortens the amount of time the camera takes to power down completely.

## Viewing Album Files

You can view and print album files using your computer's Web browser application.

- 1. Use your computer to access the data in built-in memory or on the memory card, or access a memory card with your computer (pages 131, 141).**
- 2. Open the built-in memory "ALBUM" folder or the memory card "ALBUM" folder, which is located inside the folder named "DCIM".**
- 3. Use your computer's Web browser to open the file named "INDEX.HTM".**

- This displays a list of folders in built-in memory or on the memory card.

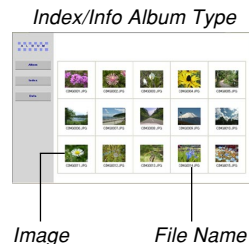

## USING THE CAMERA WITH A COMPUTER

### 4. If you created the album after selecting “Normal” type or “Index/Info” as the album type under “Configuring Detailed Album Settings” on page 147, you can click one of the following display options.

Album: Displays an album created by the camera.

Index : Displays a list of images stored in a folder.

Info : Displays information about each image.

- If “View” is selected for “Use” (page 148), you can double-click an image on your computer screen to display the full-size version.

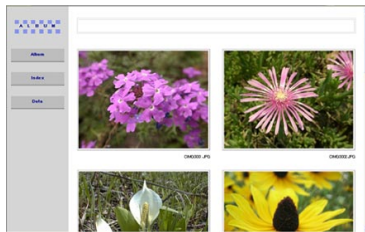

*Album*



*Index*

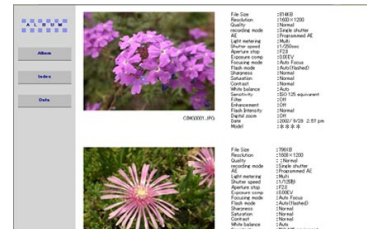

*Info*

## USING THE CAMERA WITH A COMPUTER

- The following describes the information that appears on the Info Screen.

This Info Screen item:	Shows this:
File Size	Image file size
Resolution	Resolution
Quality	Quality
Drive mode	Drive mode
AE	Exposure mode
Light metering	Metering mode
Shutter speed	Shutter speed
Aperture stop	Aperture stop
Exposure comp	EV shift
Focusing mode	Focusing mode
Flash mode	Flash mode
Sharpness	Sharpness
Saturation	Saturation
Contrast	Contrast
White balance	White balance
Sensitivity	Sensitivity
Filter	Filter setting
Enhancement	Enhancement setting
Flash intensity	Flash intensity
Digital zoom	Digital zoom setting
World	Location
Date	Recording date and time
Model	Camera model name

### »» NOTES ««

- When printing an album page, you should set up your Web browser as described below.
  - Select the browser frame where the images are located.
  - Set margins to the lowest possible values.
  - Set the background color to a printable color.
- See the user documentation that came with your Web browser application for details about printing and configuring settings for printing.

### **5. After you are finished viewing the album, exit your Web browser application.**

### Saving an Album

- To save an album, copy the “DCIM” folder from camera memory or the memory card to your computer’s hard disk, a CD-R, an MO disk, or some other storage medium. Note that copying only the “ALBUM” folder, does not copy image data and other necessary files.
- After copying the “DCIM” folder, do not change or delete any of the files inside of it. Adding new images or deleting existing images may lead to abnormal album display.
- If you plan to use a memory card again after saving its album, first delete all of its files or format it before loading it into the camera.
- When you have “WEB” selected for the “Use” setting, the album shows only the smaller image files stored in the “ALBUM” folder. Such images can be uploaded to the Internet more quickly.

### Installing the Software from the CD-ROM

#### About the bundled CD-ROM

The CD-ROM that comes bundled with the camera contains the applications described below. Installation of these applications is optional, and you should install only the ones you want to use.

#### USB Driver for Mass Storage (for Windows)

This is the software that makes it possible for the camera to “talk” to your personal computer over a USB connection. If you are using Windows XP, do not install the USB driver from the CD-ROM. With these operating systems, you will be able to perform USB communication simply by connecting the camera to your computer with the USB cable.

#### Photo Loader (for Windows/Macintosh)

This application loads image data saved in JPEG and AVI format from a digital camera to your computer. With the EX-M20, you can also load audio snapshot and voice recording WAV files to your computer.

#### Photohands (for Windows)

This application is for retouching and printing image files.

### DirectX (for Windows)

This software provides an extended tool set including a codec that allows Windows 98 and 2000 to handle movie files recorded using a digital camera. You do not need to install DirectX if you are running Windows XP or Me.

### Acrobat Reader (for Windows)

This is an application that lets you read PDF files. Use it to read the user documentation for the camera, Photo Loader, and Photohands, all of which is included on the bundled CD-ROM.

### NOTE

- See the user documentation files (PDF) on the bundled CD-ROM for details about using Photo Loader and Photohands. See “Viewing User Documentation (PDF files)” on page 156 (Windows) and page 158 (Macintosh) of this manual for more information.

## Computer System Requirements

Computer system requirements depend on each of the applications, as described below.

### Windows

See the “Readme” file on the bundled CD-ROM.

### Macintosh

See the “readme” file on the bundled CD-ROM.

### Installing Software from the CD-ROM in Windows

Use the procedures in this section to install the software from the bundled CD-ROM to your computer.

#### NOTE

- If you already have one of the bundled applications installed on your computer, check its version. If the bundled version is newer than the one you have, you should install the newer version.

The CD-ROM includes the software and user documentation for various languages. Check the CD-ROM menu screen to see if applications and user documentation are available for a particular language.

### Getting Started

Start up your computer and insert the CD-ROM into its CD-ROM drive. This will automatically launch the menu application, which displays a menu screen on your computer.

- The menu application may not start up automatically on some computers. If this happens, navigate to the CD-ROM and double-click “menu.exe” to launch the menu application.

### Selecting a Language

First select a language. Note that some software is not available in all languages.

- 1. On the menu screen, click the tab for the language you want.**

## Viewing the Contents of the “Read me” File

You should always read the “Read me” file for any application before installing it. The “Read me” file contains information you need to know when installing the application.

### 1. Click the “Read me” button for the application you are going to install.

#### »» IMPORTANT! ««

- Before upgrading or reinstalling Photo Loader, or before installing it onto another computer, be sure to read the “Read me” file for information about retaining existing libraries.

## Installing an Application

1. Click the “Install” button for the application you want to install.
2. Follow the instructions that appear on your computer screen.

#### »» IMPORTANT! ««

- Be sure to follow the instructions carefully and completely. If you make a mistake when installing Photo Loader, you may not be able to browse your existing library information and HTML files that are created automatically by Photo Loader. In some cases, image files may be lost.
- When using an operating system other than Windows XP, never connect the camera to your computer without installing the USB driver from the CD-ROM first.

## Viewing User Documentation (PDF Files)

1. In the “Manual” area, click the name of the manual you want to read.

### »» IMPORTANT! ««

- You need to have Adobe Acrobat Reader installed on your computer to read user documentation files. If you do not already have Adobe Acrobat Reader installed, you can install it from the bundled CD-ROM.

## User Registration

You can perform user registration over the Internet. To do so, of course, you need to be able to connect to the Internet with your computer.

1. Click the “Register” button.

- This starts up your Web browser and accesses the user registration website. Follow the instructions that appear on your computer screen to register.

2. After registering, terminate your connection to the Internet.

## Exiting the Menu Application

1. On the menu screen, click “Exit” to exit the menu.



### Installing Software from the CD-ROM on a Macintosh

Use the procedures in this section to install the software from the bundled CD-ROM to your computer.

### Installing Software

Use the following procedures to install the software.

#### ■ To install Photo Loader

1. Open the folder named “Photo Loader”.
2. Open the folder named “English”, and then open the file named “Important”.
3. Open the folder named “Installer”, and then open the file named “readme”.
4. Follow the instructions in the “readme” file to install Photo Loader.

#### »» IMPORTANT! ««

- If you are upgrading to the new version of Photo Loader from a previous version and you want to use library management data and HTML files created using the old version of Photo Loader, be sure to read the “Important” file in the “Photo Loader” folder. Follow the instructions in the file to use your existing library management files. Failure to follow this procedure correctly can result in loss or corruption of your existing files.

### Viewing User Documentation (PDF Files)

To perform the following procedures, you must have Acrobat Reader installed on your Macintosh. You can download the latest version of Adobe Acrobat Reader by visiting the Adobe Systems website.

#### ■ To view the camera user's guide

1. On the CD-ROM, open the "Manual" folder.
2. Open the "Digital Camera" folder, and then open the folder for the language whose user's guide you want to view.
3. Open the file named "camera\_xx.pdf".
  - "xx" is the language code.

#### ■ To read the Photo Loader user's guide

1. On the CD-ROM, open the "Manual" folder.
2. Open the "Photo Loader" folder and then open the "English" folder.
3. Open "PhotoLoader\_english".

#### ■ To register as a user

Internet registration only is supported. Visit the following CASIO website to register:

<http://world.casio.com/qv/register/>

# PLAYING AN AUDIO FILE (EX-M20 Only)

You can transfer MP3 music data files from your computer to the camera and then use the camera as a portable audio player.

- MP3 stands for MPEG Audio Layer-3, which is the name of audio compression technology.
- Supported Files  
An “MP3 file” is a Windows file whose name is followed by the extension “.MP3”. The following describes the types of MP3 files that are supported by this camera.
  - MPEG-1 Audio Layer-3  
Bit Rate: 32 to 320 kbps, VBR-compatible  
Sampling Frequencies: 32, 44.1, 48kHz
  - MPEG-2 Audio Layer-3  
Bit Rate: 8 to 160 kbps, VBR-compatible  
Sampling Frequencies: 16, 22.05, 24kHz
- Maximum Number of Playback Files: 999

## ▶▶ IMPORTANT! ◀◀

- Depending on the MP3 file format, some music data may not be playable.
- A bit rate of 128kbps and a sampling frequency of 44.1kHz are recommended for MP3 files.
- It is up to you to obtain software for creating MP3 files and to create the MP3 files you want to play.

## Transferring Audio Files to the Camera

Use the following procedure to import an MP3 audio file from your computer to the camera.

- 1. Establish a USB connection between the camera and your computer (page 131).**
  - If you plan to transfer MP3 audio files to a memory card, load the card into the camera.
- 2. Perform one of the following operations to open camera memory or the memory card.**
  - **Windows XP Users**  
Click “My Computer” and then “Removable Disk”.
  - **Mac OS 9 Users**  
Click “untitled”.
- 3. Open the “AUDIO” folder, and then transfer the MP3 files you want to play into it.**
  - If there is no “AUDIO” folder, create one at the location indicated in “Memory Directory Structure” on page 142.
- 4. This terminates the USB connection between the camera and your computer (page 131).**

»» NOTES ««

- If you are using a “PLAYLIST.TXT” file (page 166), you need to edit the contents of the file accordingly whenever you add or delete an MP3 file.
- See the user documentation that comes with your computer for information about moving, and copying files.

### Preparing the Camera for Audio Player Operation

Perform the following steps to prepare the camera for operation as an audio player.

- 1. Turn off the camera.**
- 2. Connect the LCD remote controller to the camera's connector, and then plug the stereo headphones into the Headphones jack of the LCD remote controller.**

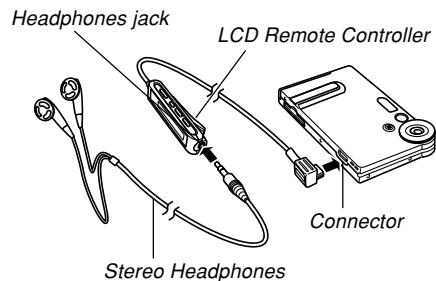

### 3. On the LCD remote controller, press the [▶/■] button.

- This turns on the camera, enters the AUDIO mode, and starts playback.

#### ▶▶ IMPORTANT! ◀◀

- Pressing the LCD remote controller's [▶/■] button enters the AUDIO mode, regardless of the camera's mode selector setting.
- Entering the AUDIO mode causes the camera's monitor screen to turn off. Pressing [MENU] or [DISP] on the camera while playback is stopped or paused causes the monitor screen to turn on.
- Never try to connect any other type of remote controller besides the one that comes with the camera. Also, never try to use the supplied remote controller with any other type of device.
- You cannot play MP3 file data through the camera's built-in speaker.

## Using the Camera as an Audio Player

### General Guide

#### ● LCD Remote Controller

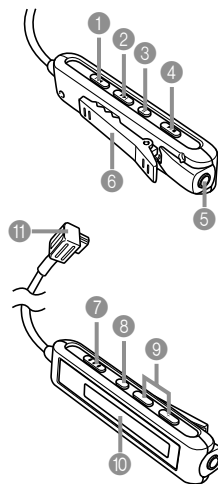

- 1 [◀◀] (Skip Back/Fast Reverse)
- 2 [▶▶] (Skip Forward/Fast Forward)
- 3 [||] (Pause)
- 4 [▶/■] (Play/Stop)
- 5 Headphones jack (ø3.5mm stereo mini jack)
- 6 Clip
- 7 Lock switch
- 8 Playback mode button
- 9 Volume buttons
- 10 LCD
- 11 Camera connector

## PLAYING AN AUDIO FILE (EX-M20 Only)

### ● Display

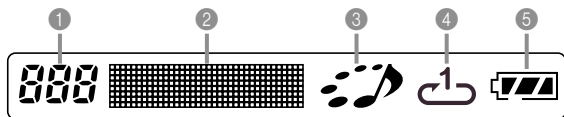

- 1 Track number  
Shows the track number of the current track.
- 2 Track name, artist name, playback time, volume level, BASS BOOST settings
  - Shows the ID3 tag (ID3V1), which is the track name and artist name (alphabetic characters only), contained in the file.
  - During fast forward and fast reverse, shows the elapsed play time.
  - During volume level adjustment, shows the current volume level.
  - When BASS BOOST is selected, shows the current BASS BOOST setting (BASS 0, BASS 1, BASS 2).

- 3 Playback status indicator  
This icon indicates the current playback status.

This type of icon:	Indicates this:
Rotation clockwise while flashing	Playback is in progress.
Flashing	Playback is paused.
Steady and unmoving	Playback is stopped.

- 4 Playback mode indicator  
This icon indicates the playback mode.

This type of icon:	Indicates this:
None	Normal playback
	All track repeat
	1-track repeat

- 5 Battery level indicator

## Basic Remote Controller Operations

### ● To start playback

Press the [▶/■] button. The remote controller beeps to indicate that playback has started.

- Pressing the [▶/■] button while the camera is off turns on power and starts playback.

### ● To pause playback

Press the [⏏] button (remote controller beeps).

Pressing the [▶/■] button or the [⏏] button resumes playback (remote controller beeps).

- If the Auto Power Off trigger time (about two minutes or five minutes) is reached while playback is paused, the camera will automatically turn off.

### ● To fast forward the playback

Hold down the [▶▶] button for a few seconds until fast forward starts.

### ● To fast reverse the playback

Hold down the [◀◀] button for a few seconds until fast reverse starts.

### ● To skip to the beginning of the current track

Press the [◀◀] button (remote controller beeps).

To skip to the beginning of a previous track, press the [◀◀] button multiple times (remote controller beeps).

The current track number is shown on the LCD.

### ● To skip to the beginning of the next track

Press the [▶▶] button (remote controller beeps).

To keep skipping forward, press the [▶▶] button multiple times (remote controller beeps). The current track number is shown on the LCD.

### ● To stop playback

Press the [▶/■] button (remote controller beeps).

- Pressing the [▶/■] button again will restart playback from the beginning of the track where it was stopped.

### ● To adjust volume

Press the [+] or [-] volume buttons to adjust volume to the desired level. The LCD shows the current volume level.

### ● To turn off power

Press the camera's power button.

- Camera power also turns off automatically if you do not perform an operation for about 10 seconds after playback is stopped.

### ▶▶ IMPORTANT! ◀◀



- The button operation tone does not sound if the camera's button tone function is turned off (page 111).
- You cannot use fast forward, fast reverse, or skip while the current volume level is shown on the LCD.

## Playing Back Audio Files

### Specifying the Audio Playback Mode

You can use the following procedure to select one of three playback modes: normal playback, all-track repeat, or one-track repeat.

1. On the LCD remote controller, press **[▶/■]** to start playback.
2. Press the LCD remote controller's playback mode button to cycle through the playback modes.

To do this:	Select this mode:	Which is indicated by this icon:
Play all tracks in order and then stop	Normal	None
Play all tracks in order in an endless loop	All-track repeat	
Play the current track in an endless loop	1-track repeat	

### NOTE

- The initial default mode is normal playback. The camera remembers the last playback mode you selected, even if you turn the camera off.

### Playing Back Tracks Randomly

Use the following procedure to configure audio playback for random play of the audio files in file memory.

1. On the LCD remote controller, press the **[▶/■]** button or the **[||]** button to stop or pause playback.
  - You could also enter the PLAY mode on the camera, press [MENU], select the "PLAY" tab and then "Audio Player", and then press **[▶]**.
2. Use **[▲]** and **[▼]** to select "Random", and then press **[▶]**.



### 3. Use [▲] and [▼] to select “On”, and then press [SET].

To do this:	Select this setting:
Turn on random play	On
Turn off random play	Off

#### ▶▶ IMPORTANT! ◀◀

- Random play is not performed if you have “1-track repeat” selected as the playback mode (page 164).

## Selecting a Specific Track for Playback

You can use the following procedure to select the specific track you want to play from a list of tracks on the camera's monitor screen.

### 1. On the LCD remote controller, press the [▶/■] button or the [||] button to stop or pause playback.

### 2. On the camera, press the [DISP] button.

- This causes an MP3 file list showing track numbers, track names, and play time to appear on the camera's monitor screen.



001	POLICE TECH	04:14
002	PLANET DURAN EARTH	03:58
003	DO DO DO THE ICE	04:20
004	YOUNG RINK	03:06

### 3. Use [▲] and [▼] to move the highlighting to the name of the MP3 file you want to play.

### 4. To start playback of the selected track, press [▶/■] on the LCD remote controller or the [SET] button on the camera.

▶▶ IMPORTANT! ◀◀

- The monitor screen turns off automatically if you do not perform any operation for about 10 seconds.

## Specifying the Track Playback Sequence

Normally, audio files are played back in the sequence that they are stored in file memory. You can also create a text file that lists the MP3 files to be played and the sequence for playing them. Then, simply name the file "PLAYLIST.TXT" and place it into the camera's "AUDIO" folder. The camera will play back files accordingly.

- 1. Use your computer's word processor or text editor to create a text file like the one shown below, and name it "PLAYLIST.TXT".**
- 2. Establish a USB connection between the camera and your computer (page 131).**
- 3. Open the folder in camera memory named "AUDIO", and place the "PLAYLIST.TXT" file inside it.**
- 4. Terminate the USB connection between the camera and your computer (page 131).**
  - Now when you perform a playback operation, MP3 files will be played in the sequence you specified in your play list.

## ■ Example Folder Structure

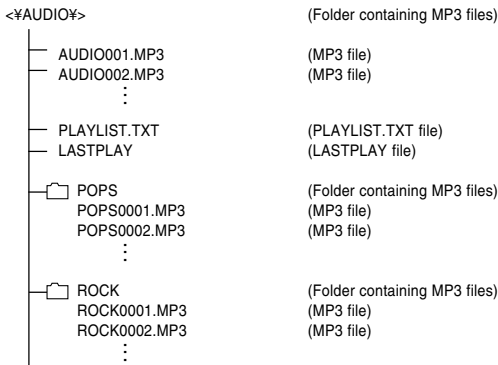

### ▶▶ IMPORTANT! ◀◀

- Playback will include all the files in the “AUDIO” folder and all the files in any folders inside the “AUDIO” folder. Any files nested deeper will not be played. If the “AUDIO” folder contains another folder named “POPS”, and there is another folder named “JAZZ” inside of the “POPS” folder, playback will include all the files in the “AUDIO” folder and the “POPS” folder, but not the files inside the “JAZZ” folder.

## ■ Example PLAYLIST.TXT File Contents

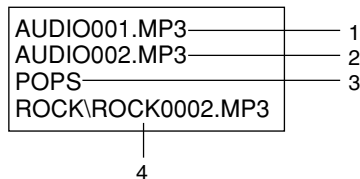

The above PLAYLIST.TXT file specifies the following playback sequence.

1. Playback the MP3 file named AUDIO001.MP3.
2. Playback the MP3 file named AUDIO002.MP3.
3. Playback all the files in the folder named POPS.
4. Playback the MP3 file named ROCK0002.MP3, which is located in folder named ROCK.

▶▶ IMPORTANT! ◀◀

- Any files and folders that are not included in the “PLAYLIST.TXT” file are skipped during playback.
- If there is no file named “PLAYLIST.TXT” in the camera’s “AUDIO” folder, all audio files are played in the sequence they are stored.
- If you want to change the files that are played or their sequence, simply edit the contents of the “PLAYLIST.TXT” file.
- The contents of the “PLAYLIST.TXT” file are ignored when random playback is turned on (page 164).

## Using BASS BOOST

BASS BOOST enhances the low range of the audio for a more powerful sound.

- 1. On the LCD remote controller, press the [▶/■] button or the [||] button to stop or pause playback.**
  - You could also enter the PLAY mode on the camera, press [MENU], select the “PLAY” tab and then “Audio Player”, and then press [▶].
- 2. Use [▲] and [▼] to select “BASS BOOST”, and then press [▶].**
- 3. Use [▲] and [▼] to select the setting you want, and then press [SET].**
  - Available settings are BASS 0, BASS 1, and BASS 2. A higher number provides more powerful sound.

### ▶▶ IMPORTANT! ◀◀

- When using BASS BOOST, playing at loud volume can cause distortion. If this happens, lower the volume level.
- During playback, you can change the BASS BOOST setting using the camera's [▲] and [▼] buttons.

### Deleting MP3 Files from File Memory

You can delete a single MP3 file from camera memory or on the memory card, or you can batch delete all the MP3 files.

### ▶▶ IMPORTANT! ◀◀

- Note that file deletion cannot be undone. Once you delete a file it is gone. Make sure you really do not need an MP3 file anymore before you delete it. Especially when deleting all MP3 files, make sure you check all the files you currently have in memory before proceeding.
- If you are using a "PLAYLIST.TXT" file (page 166), you need to edit the contents of the file accordingly whenever you delete an MP3 file.

## Deleting a Single MP3 File

Use the following procedure to delete a single MP3 file from file memory or a memory card.

- 1. On the LCD remote controller, press the [▶/■] button or the [||] button to stop or pause playback.**
  - You could also enter the PLAY mode on the camera, press [MENU], select the “PLAY” tab and then “Audio Player”, and then press [▶].
- 2. Use [▲] and [▼] to select “Delete”, and then press [SET].**
  - This causes an MP3 file list showing track numbers, track names, and play time to appear on the camera’s monitor screen.
- 3. Use [◀] and [▶] to display the MP3 file you want to delete.**

- 4. Use [▲] and [▼] to select “Delete”.**

- To exit the delete operation without deleting anything, select “Cancel”.

- 5. Press the [SET] button to delete the file.**

- Repeat steps 3 through 5 to delete other MP3 files, if you want.

- 6. Press [MENU] to exit the delete operation.**

## Deleting All MP3 Files

The following procedure deletes all MP3 files currently in file memory.

1. On the LCD remote controller, press the **[▶/■]** button or the **[||]** button to stop or pause playback.
  - You could also enter the PLAY mode on the camera, press [MENU], select the “PLAY” tab and then “Audio Player”, and then press [▶].
2. Use **[▲]** and **[▼]** to select “All File Delete”, and then press **[SET]**.
3. Use **[▲]** and **[▼]** to select “Yes”.
  - To exit the delete operation without deleting anything, select “No”.
4. Press **[SET]** to display all MP3 files in file memory.

## Disabling Remote Controller Button Operations

The remote controller has a lock switch that you can use to disable button operations to guard against accidental operation. To disable all remote controller button operations, slide the lock switch in the direction indicated by the ▶ mark.

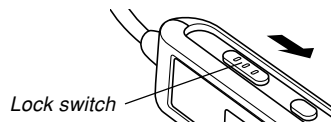

- To re-enable remote controller button operations, slide the lock switch back in the other direction.

### NOTE

- The camera's power button continues to be operational, even while remote controller button operations are disabled.

### LCD Remote Control Error Messages

The following describes the error messages that appear on the LCD remote controller's display.

	Cause	Action
<b>NoData</b>	Playback attempted when there is no MP3 data in memory.	Transfer MP3 file data to the "AUDIO" folder of built-in memory or the memory card.

#### »» NOTE ««

- The message "There are no files." appears on the camera monitor screen if there are no MP3 files in memory.

### Audio Playback Precautions

- Listening to audio at a high volume for long periods can damage your hearing. Particular care is required when first starting a playback operation.
- Never use the headphones, try to perform fine adjustment, or look at the monitor screen while driving a car, riding a motorcycle, or operating any other type of motor vehicle. Doing so creates the risk of traffic accident. When walking, take special care to remain aware of traffic and road conditions around you.



# APPENDIX











## Menu Reference





The following shows lists of menus that appear in the REC mode and PLAY mode, and their settings.

- The settings that are underlined in the following table are initial defaults.
- Menu items marked with an asterisk (\*) appear on the EX-M20 only.

### ■ REC mode

#### ● REC tab menu

REC Mode	EX-S20:  Snapshot /  BESTSHOT /  Movie
	EX-M20:  Snapshot /  BESTSHOT /  Movie /  Voice /  Voice
Self-timer	10 sec / 2 sec / X3 / <u>Off</u>
Flash	<u>Auto</u> /  (Flash Off) /  (Flash On) /  (Red-eye reduction)
Size	<u>1600 x 1200</u> / 1600 x 1072 (3:2) / 1280 x 960 / 640 x 480
Quality	Fine / <u>Normal</u> / Economy
EV Shift	-2.0 / -1.7 / -1.3 / -1.0 / -0.7 / -0.3 / <u>0.0</u> / +0.3 / +0.7 / +1.0 / +1.3 / +1.7 / +2.0

White Balance	<u>Auto</u> /  (Sunlight) /  (Shade) /  (Light Bulb) /  (Fluorescent) / Manual
ISO	<u>Auto</u> / ISO 64 / ISO 125 / ISO 250 / ISO 500
Grid	On / <u>Off</u>
Digital Zoom	<u>On</u> / Off
Review	<u>On</u> / Off
L/R Key	<u>REC Mode</u> / Flash / EV shift / White Balance / ISO / Off
U/D Key	REC Mode / <u>Digital Zoom</u> / Flash / White Balance / Self-timer / Off

#### ● Memory tab menu

REC Mode	<u>On</u> / Off
Flash	<u>On</u> / Off
White Balance	On / <u>Off</u>
ISO	On / <u>Off</u>
Digital Zoom	<u>On</u> / Off

## ● Set Up tab menu

Beep (EX-S20)	<u>On</u> / Off
Sounds (EX-M20)	<u>Startup</u> / Shutter / Operation / Volume
Startup	On (Selectable image) / <u>Off</u>
File No.	<u>Continue</u> / Reset
World Time	<u>Home</u> / World
	Home time setup (city, DST, etc.)
	World Time setup (city, DST, etc.)
Date Style	YY/MM/DD / DD/MM/YY / MM/DD/YY
Adjust	Time setting
Language	日本語 / English / Français / Deutsch / Español / Italiano / Português / 中國語 / 中国語 / 한국어
Auto Power Off	<u>2 min</u> / 5 min
Format	Format / <u>Cancel</u>
Reset	Reset / <u>Cancel</u>

## ■ PLAY mode

## ● PLAY tab menu

Slideshow	<u>Start</u> / Images / Time / Interval
Calender	–
Favorites	<u>Show</u> / Save / Cancel
Create Album	<u>Create</u> / Layout / Set Up / Cancel
DPOF	<u>Select images</u> / All images / Cancel
Protect	<u>On</u> / All Files : On / Cancel
Rotation	<u>Rotate</u> / Cancel
Resize	<u>1280 x 960</u> / 640 x 480 / Cancel
Trimming	–
Dubbing*	–
Alarm	Alarm setups
Copy	<u>Built-in</u> → Card / Card → Built-in / Cancel
Audio Player*	<u>Random</u> / BASS BOOST / Delete

## ● Set Up tab menu

Beep (EX-S20)	On / Off
Sounds (EX-M20)	Startup / Shutter / Operation / Volume
Startup	On (Selectable image) / Off
File No.	Continue / Reset
World Time	Home / World Home time setup (city, DST, etc.) World Time setup (city, DST, etc.)
Date Style	YY/MM/DD / DD/MM/YY / MM/DD/YY
Adjust	Time setting
Language	日本語 / English / Français / Deutsch / Español / Italiano / Português / 中國語 / 中国語 / 한국어
Auto Power Off	2 min / 5 min
Format	Format / Cancel
Reset	Reset / Cancel

## Indicator Lamp Reference

## Camera Indicator Lamps

The camera has two indicator lamps: an operation/flash charge lamp and a self-timer lamp. These lamps light and flash to indicate the current operational status of the camera.

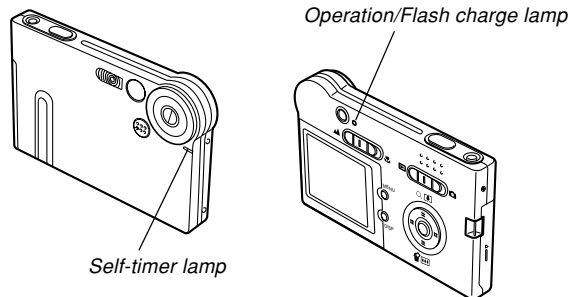

\* There are two lamp flash patterns. Pattern 1 flashes once per second, while Pattern 2 flashes twice per second. The table below explains what each flash pattern indicates.

## ■ REC Mode

Operation/Flash Charge Lamp		Self-timer Lamp		Meaning
Color	Status	Color	Status	
Green	Lit			Power on
Amber	Pattern 1			Flash charging
Green	Lit			Monitor screen off
Green	Pattern 2			Storing image
Green	Pattern 1	Red	Pattern 1	Self-timer countdown (10 to 3 seconds)
Green	Pattern 2	Red	Pattern 2	Self-timer countdown (3 to 1 seconds)
Red	Lit			Memory error
Red	Lit			Memory full
Red	Pattern 1			Low battery alert
Red	Pattern 1			Monitor screen disabled
Green	Pattern 2			Powering down

### ▶▶▶ IMPORTANT! ◀◀◀

- Never remove the memory card from the camera while the operation/flash charge lamp is flashing. Doing so will cause recorded images to be lost.

## ■ PLAY Mode

Operation/Flash Charge Lamp		Self-timer Lamp		Meaning
Color	Status	Color	Status	
Green	Lit			Power on
Green	Pattern 2			Deleting image
Red	Lit			Memory error
Red	Pattern 1			Low battery alert
Green	Pattern 2			Formatting
Green	Pattern 2			Powering down

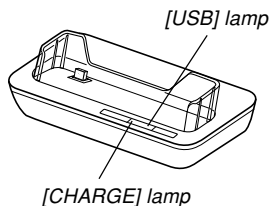

## USB Cradle Indicator Lamps

The USB cradle has two indicator lamps: a [CHARGE] lamp and a [USB] lamp. These lamps light and flash to indicate the current operational status of the USB cradle and camera.



[CHARGE] lamp		[USB] lamp		Meaning
Color	Status	Color	Status	
Red	Lit			Charging
Green	Lit			Charging complete
Amber	Lit			Charge standby
Red	Flashing			Charge error
		Green	Lit	USB connection
		Green	Flashing	Accessing memory

## Troubleshooting Guide

	Symptom	Possible Cause	Action
Power Supply	Power does not turn on.	<ol style="list-style-type: none"> <li>1) The battery is not oriented correctly.</li> <li>2) The battery is dead.</li> </ol>	<ol style="list-style-type: none"> <li>1) Orient the battery correctly (page 26).</li> <li>2) Charge the battery (page 28). If the battery goes dead soon after being charged, it means the battery has reached the end of its life and needs to be replaced. Purchase a separately available NP-20 rechargeable lithium ion battery.</li> </ol>
	Camera suddenly powers down.	<ol style="list-style-type: none"> <li>1) Auto Power Off activated (page 36).</li> <li>2) The battery is dead.</li> </ol>	<ol style="list-style-type: none"> <li>1) Turn power back on.</li> <li>2) Charge the battery (page 28).</li> </ol>
Image Recording	Image is not recorded when the shutter release button is pressed.	<ol style="list-style-type: none"> <li>1) The mode selector is set to  (PLAY).</li> <li>2) Flash unit is being charged.</li> <li>3) Memory is full.</li> </ol>	<ol style="list-style-type: none"> <li>1) Align the mode selector with  (REC).</li> <li>2) Wait until the flash unit finishes charging.</li> <li>3) Transfer files you want to keep to your computer and then delete files from image memory, or use a different memory card.</li> </ol>
	Camera powers down during self-timer countdown.	The battery is dead.	Charge the battery (page 28).
	Recorded images are not saved in memory.	<ol style="list-style-type: none"> <li>1) Camera powers down before the save operation is complete.</li> <li>2) Removing the memory card before the save operation is complete.</li> </ol>	<ol style="list-style-type: none"> <li>1) When the battery indicator shows , charge the battery as soon as possible (page 28).</li> <li>2) Do not remove the memory card before the save operation is complete.</li> </ol>

## APPENDIX

	Symptom	Possible Cause	Action
Playback	Color of the playback image is different from the image on the monitor screen during recording.	Sunlight or light from another source is shining directly into the lens during recording.	Position the camera so sunlight does not shine directly into the lens.
	Images are not displayed.	A memory card with non-DCF images recorded with another camera is loaded in the camera.	This camera cannot display non-DCF images recorded onto a memory card using another digital camera.
Audio Playback	Cannot playback audio, cannot hear audio, or cannot control the audio playback using the remote controller.	<ol style="list-style-type: none"> <li>1) There is no MP3 file data in memory. This is indicated by the message "NoData" on the remote controller LCD.</li> <li>2) Stereo headphones are not connected correctly.</li> <li>3) Volume setting is too low.</li> <li>4) The battery is dead.</li> <li>5) The remote controller buttons are locked.</li> </ol> <ol style="list-style-type: none"> <li>6) There are no playable files.</li> <li>7) Improper PLAYLIST.TXT file contents</li> </ol>	<ol style="list-style-type: none"> <li>1) Transfer MP3 files to the camera's AUDIO folder.</li> <li>2) Correctly connect the headphones to the headphones jack.</li> <li>3) Adjust the volume to a higher level.</li> <li>4) Charge the battery (page 28).</li> <li>5) Slide the remote controller lock switch in the opposite direction of the arrow marking to unlock the controls.</li> <li>6) Check the files you are trying to play (page 159).</li> <li>7) Check to make sure the PLAYLIST.TXT file lists the MP3 files you want to play.</li> </ol>
	Playback time is short.	The battery is dead.	Charge the battery (page 28).

\* Note that audio player capabilities are available with the EX-M20 only.

## APPENDIX

	Symptom	Possible Cause	Action
Other	All buttons and switches are disabled.	Circuit problem caused by electrostatic charge, impact, etc. while the camera was connected to another device.	Remove the battery from the camera, reinsert it, and then try again.
	Monitor screen is off.	<ol style="list-style-type: none"> <li>1) USB communication is in progress.</li> <li>2) The monitor screen is turned off (in the REC mode).</li> </ol>	<ol style="list-style-type: none"> <li>1) After the computer stops accessing camera file memory, press the [USB] button on the USB cradle. Check to make sure that the [USB] lamp on the USB cradle is off, and then remove the camera from the USB cradle.</li> <li>2) Press [DISP] to turn on the monitor screen.</li> </ol>
	Cannot transfer files over a USB connection.	<ol style="list-style-type: none"> <li>1) Camera is not set securely on the USB cradle.</li> <li>2) USB cable is not connected securely.</li> <li>3) USB driver is not installed.</li> <li>4) Camera is turned off.</li> </ol>	<ol style="list-style-type: none"> <li>1) Check the connection between the camera and USB cradle.</li> <li>2) Check all connections.</li> <li>3) Install the USB driver on your computer (page 131).</li> <li>4) Press the [USB] button on the USB cradle.</li> </ol>



## Display Messages

---

**Alarm setting complete.** This message appears after you change the alarm setting.

---

**Battery is low.** The battery is dead.

---

**Cannot register any more files.**

- You are attempting to register a BESTSHOT setup when the "SCENE" folder already contains 999 setups.
- You are attempting to register a FAVORITE file when the "FAVORITE" folder already contains 9999 files.

---

**Card ERROR** Some problem occurred with the memory card. Turn off the camera, and remove and then reinsert the memory card. If the same message appears, format the memory card (page 127).

---

**»» IMPORTANT! ««**

Formatting the memory card deletes all files on the memory card. Before formatting, try transferring recoverable files to a computer or some other storage device.

---

**File could not be saved because battery is low.** The battery is dead, so the recorded image could not be saved.

---

**Folder cannot be created.** This message appears when you try to record an image while there are 9,999 files stored in the 999th folder. If you want to record more files, delete files you no longer need (page 97).

---



---

**Memory Full** Memory is full. If you want to record more files, delete files you no longer need (page 97).

---

**No Favorites file!** There is no FAVORITE file.

---

**Printing Error** One of the following problems occurred during printing.

- Printer power off
- Out of paper
- Out of ink
- Printer internal error

---

**Record Error** Image compression could not be performed during image data storage for some reason. Record the image again.

---

**SYSTEM ERROR** Your camera system is corrupted. Contact your retailer or a CASIO service center.

---

**The card is locked.** The LOCK switch of the SD memory card is locked. You cannot store images to or delete images from a memory card that is locked.

---

**This function is not supported for this file.** The function you are trying to perform is not supported for the file on which you are trying to perform it.

---

**There are no files.** There are no files in built-in memory or on the memory card.

---

<b>There are no printing images.</b>	There are no DPOF settings specifying images and the number of copies of each for printing.
<b>Set up DPOF.</b>	Configure the required DPOF settings (page 101).
<b>There is no file to register.</b>	You are trying to save an invalid file as a BESTSHOT user setup, or as an original startup image.
<b>This card is not formatted.</b>	The memory card is not formatted. Format the memory card (page 127).
<b>This file cannot be played.</b>	The image file or audio file is corrupted, or is a type that cannot be displayed by this camera.
<b>This function cannot be used.</b>	You attempted to copy files from built-in memory to a memory card while there is no memory card loaded in the camera (page 126).

## Specifications

### Main Specifications

**Product** ..... Digital Camera

**Model** ..... EX-S20/EX-M20

### ■ Camera Functions

#### Image Files Format

Snapshots: ..... JPEG (Exif Version 2.2); DCF (Design Rule for Camera File System)1.0 standard; DPOF compliant

Movies: ..... AVI (Motion JPEG)

Audio: ..... WAV (EX-M20 only)

**Recording Media:** ..... 10MB built-in flash memory  
SD Memory Card  
MultiMediaCard

#### Image Size

Snapshots: ..... 1600 x 1200 pixels  
1600 x 1072 (3:2) pixels  
1280 x 960 pixels  
640 x 480 pixels

Movies: ..... 320 x 240 pixels

## APPENDIX

### Approximate Memory Capacity and File sizes

#### • Snapshots

File Size (pixels)	Quality	Approximate Image File Size	Built-in flash memory 10MB	SD Memory Card* 64MB
1600 x 1200 (UXGA)	Fine	1050KB	8 shots	57 shots
	Normal	710KB	12 shots	77 shots
	Economy	370KB	24 shots	151 shots
1600 x 1072 (3:2)	Fine	910KB	9 shots	59 shots
	Normal	610KB	14 shots	89 shots
	Economy	300KB	27 shots	173 shots
1280 x 960 (SXGA)	Fine	680KB	12 shots	81 shots
	Normal	460KB	19 shots	124 shots
	Economy	250KB	34 shots	217 shots
640 x 480 (VGA)	Fine	190KB	46 shots	289 shots
	Normal	140KB	60 shots	379 shots
	Economy	90KB	96 shots	607 shots

#### • Movies (320 x 240 pixels)

Data Size	160KB/second max.
Recording Time	One Movie: 60 seconds maximum Total Movie Time: 60 seconds maximum (built-in memory) 380 seconds maximum (SD 64MB memory card)*

\* Based on Matsushita Electric Industrial Co., Ltd. products. Capacity depends on card manufacturer.

\* To determine the number of images that can be stored on a memory card of a different capacity, multiply the capacities in the table by the appropriate value.

**Delete** ..... Single-file, all files (with protection)

**Effective Pixels:** ..... 2.0 million

**Imaging Element:** ..... 1/2.7-inch square pixel color CCD  
(Total pixels: 2.11 million)

**Lens/Focal Distance** ..... F3.5/f = 5.6mm  
(Equivalent to 37mm on a 35mm film camera.)

**Zoom** ..... 4X digital zoom

**Focusing** ..... Fixed focus with macro mode

**Focus Range** ..... Normal focus: Approximately 0.8 m to ∞  
(2.6' to ∞)  
Macro focus: Approximately 30cm  
(11.8") (Optimum field of view at A4-size.)

#### Exposure Control

Metering: ..... Multi-pattern by imaging element

Exposure: ..... Program AE

Exposure Compensation: ... -2EV to +2EV (in 1/3EV steps)

**Shutter** ..... CCD shutter, mechanical shutter  
1/8 to 1/8000 second  
(Depends on REC mode and ISO sensitivity setting being used.)  
• Shutter speed is different for the following BESTSHOT scenes.  
Night Scene: 1 to 1/8000 second  
Fireworks: 2 seconds (fixed)

**Aperture:** ..... F3.5 fixed

**White Balance** ..... Automatic/fixd (4 modes) /Manual

## APPENDIX

**Self-timer** ..... 10 seconds, 2 seconds, Triple Self-timer

### Built-in Flash

Flash Modes: ..... Auto, Off, On, Red-eye reduction  
Approximate Flash Range: ... 0.8 meter to 1.5 meters (2.6' to 4.9')  
(ISO Sensitivity: "Auto")

**Recording Functions** ..... Snapshot (with audio for EX-M20 only); Macro; self-timer; BESTSHOT; Movie (with audio for EX-M20 only); voice recording (EX-M20 only)  
\* Audio is monaural

### Audio Recording Time (EX-M20 only)

Audio Snapshot: ..... Approximately 30 seconds maximum per image  
Voice Recording: ..... Approximately 40 minutes with built-in memory  
After Recording: ..... Approximately 30 seconds maximum per image

**Monitor Screen** ..... 1.6-inch TFT color LCD  
84,960 pixels (354 x 240)

**Viewfinder** ..... Monitor screen and optical viewfinder

**Timekeeping Functions** .... Built-in quartz digital clock  
Date and Time: ..... Recorded with image data  
Auto Calendar: ..... To 2049

**World Time:** ..... City; Date; Time; Summer time;  
162 cities in 32 time zones

**Input/Output Terminals** .... Cradle connector  
(EX-M20 connector is also used for connection of remote controller.)

**Microphone** ..... Monaural (EX-M20 only)

**Speaker** ..... 13mm round, monaural (EX-M20 only)

## ■ Audio Player Function (EX-M20 Only)

### Data Compression/

**Decompression** ..... MP3 (MPEG-1 Audio Layer-3 / MPEG-2 Audio Layer-3)

**Sampling Frequencies** ..... 32/44.1/48kHz  
(MPEG-1 Audio Layer-3)  
16/22.05/24kHz  
(MPEG-2 Audio Layer-3)

**Bit Rates** ..... 32 to 320kbps, VBR-compatible  
(MPEG-1 Audio Layer-3)  
8 to 160kbps, VBR-compatible  
(MPEG-2 Audio Layer-3)

**Play Mode** ..... Normal, all track repeat, 1-track repeat, random play

### Practical Maximum

**Headphone Output** ..... 11mW + 11mW (16  $\Omega$ )

A bit rate of 128kbps and a sampling frequency of 44.1kHz are recommended for MP3 files.

## APPENDIX

### ■ Power Supply

**Power Requirements** ..... Rechargeable lithium ion battery (NP-20) x 1

### Approximate Battery Life:

Number of Shots,Continuous Recording*1 (Recording Time)	720 shots (120 minutes)
Number of Shots,Normal Recording*2 (Recording Time)	190 shots (95 minutes)
Continuous Playback*3 (Continuous Snapshot Recording)	180 minutes
Continuous Voice Recording*4	170 minutes
Continuous Audio Playback*5	450 minutes

The above values indicate the amount of time under the conditions defined below, until power automatically turns off due to battery failure. They do not guarantee that you will be able to achieve this level of operation. Low temperatures shorten battery life.

\*1 Continuous Recording Conditions

- Temperature: 23°C (73°F)
- Monitor screen: On
- Flash: Off
- Image recorded about every 10 seconds

\*2 Normal Recording Conditions

- Temperature: 23°C (73°F)
- Monitor screen: On
- Flash: On (one flash every two shots)
- Image recorded about every 30 seconds
- Power off/on every 10 shots

\*3 Continuous Playback Conditions

- Temperature: 23°C (73°F)
- Scroll one image about every 10 seconds

\*4 Voice recording times are based on continuous recording.

\*5 Audio playback times are based on continuous output (through headphones).

- Voice recording and audio playback times apply to the EX-M20 only.

**Power Consumption** ..... DC 3.7V Approximately 2.5W

### ■ Other

#### Dimensions

EX-S20: ..... 83(W) x 53(H) x 11.3(D) mm  
(3.3"(W) x 2.1"(H) x 0.44"(D))  
(excluding projections)

EX-M20: ..... 83(W) x 53(H) x 12.4(D) mm  
(3.3"(W) x 2.1"(H) x 0.49"(D))  
(excluding projections)

#### Weight

EX-S20: ..... Approximately 78 g (2.8 oz)  
(excluding battery and accessories)

EX-M20: ..... Approximately 80 g (2.8 oz)  
(excluding battery and accessories)

**Bundled Accessories** ..... Rechargeable lithium ion battery (NP-20); USB Cradle (CA-23); Special AC Adaptor (AD-C51G); AC power cord; Strap; USB cable; LCD Remote Controller (bundled with EX-M20 only); Stereo Headphones (bundled with EX-M20 only); CD-ROM; Basic Reference

### ■ Rechargeable Lithium Ion Battery (NP-20)

**Rated Voltage:** ..... 3.7 V

**Rated Capacitance:** ..... 680 mAh

#### Operating Temperature

**Range:** ..... 0°C to 40°C (32°F to 104°F)

**Dimensions:** ..... 33 (W) x 50 (H) x 4.7 (D) mm  
(1.3" (W) x 2.0" (H) x 0.19" (D))

**Weight:** ..... Approximately 16 g (0.56 oz)

### ■ USB Cradle (CA-23)

**Input/Output Terminals** .... Camera connector; USB port; AC adaptor terminal (DC IN 5.3V)

**Power Consumption** ..... DC 5.3V Approximately 3.2W

**Dimensions** ..... 101(W) x 32(H) x 58(D) mm  
(4.0"(W) x 1.3"(H) x 2.3"(D))  
(excluding projections)

**Weight** ..... Approximately 58 g (2.0 oz)

### ■ Special AC Adaptor (AD-C51G)

**Power Requirement** ..... 100 to 240V AC, 50/60Hz, 83mA

**Output** ..... 5.3V DC, 650mA

**Dimensions** ..... 78(W) x 20(H) x 39(D) mm  
(3.1"(W) x 0.78"(H) x 1.5"(D))  
(excluding projections and cable)

**Weight** ..... Approximately 90 g (3.2 oz)

### ■ LCD Remote Controller (Bundled with EX-M20 Only)

**Input/Output Terminals** .... Camera connector; headphones jack  
(ø3.5mm stereo mini jack)

**Cord Length** ..... Approximately 0.8m (31.5")

**Dimensions** ..... 74.5(W) x 16(H) x 11(D) mm  
(2.9"(W) x 0.63"(H) x 0.43"(D))  
(excluding projections, excluding cradle)

**Weight** ..... Approximately 28 g (1.0 oz)

### Power Supply

- Use only the special NP-20 rechargeable lithium ion battery to power this camera. Use of any other type of battery is not supported.
- This camera does not require a battery for the clock. The date and time settings of the camera are cleared whenever power supplied by both the battery and USB cradle is interrupted. Be sure to reconfigure these settings after power is interrupted (page 39).

### LCD Panel

- The LCD panel is a product of the latest LCD manufacturing technology that provides a pixel yield of 99.99%. This means that less than 0.01% of the total pixels are defective (they do not turn on or always remain turned on).

### Lens

- You may sometimes notice some distortion in certain types of images, such as a slight bend in lines that should be straight. This is due to the characteristics of lens, and does not indicate malfunction of the camera.

## Free Manuals Download Website

<http://myh66.com>

<http://usermanuals.us>

<http://www.somanuals.com>

<http://www.4manuals.cc>

<http://www.manual-lib.com>

<http://www.404manual.com>

<http://www.luxmanual.com>

<http://aubethermostatmanual.com>

Golf course search by state

<http://golfingnear.com>

Email search by domain

<http://emailbydomain.com>

Auto manuals search

<http://auto.somanuals.com>

TV manuals search

<http://tv.somanuals.com>