

CASIO®

Digital Camera

EX-TR100

User's Guide

E

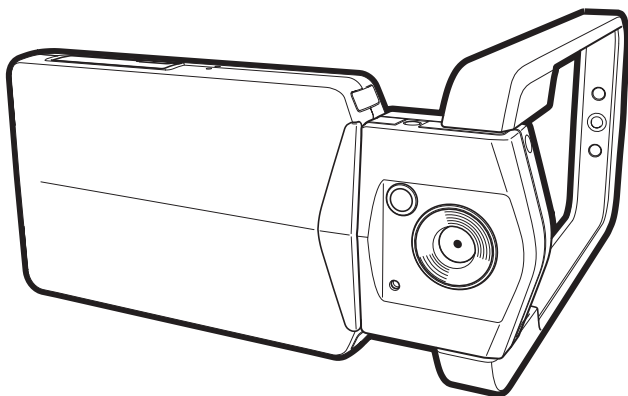

Thank you for purchasing this CASIO product.

- Before using it, be sure to read the precautions contained in this User's Guide.
- Keep the User's Guide in a safe place for future reference.
- For the most up-to-date information about this product, visit the official CASIO Digital Imaging Website at <http://di.casio.com/>

TRYX

Unpacking

As you unpack your camera, check to make sure that all items shown below are included. If anything is missing, contact your original retailer.

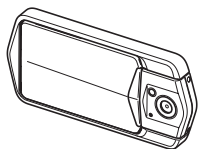

Digital camera

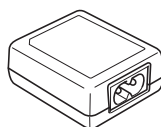

USB-AC adaptor (AD-C53U)

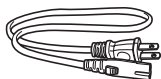

* The shape of the power cord plug varies according to country or geographic area.

Power cord

To attach the strap to the camera

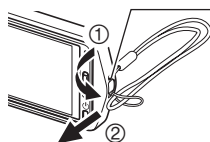

Attach strap here.

Strap



USB cable



Quick Start Guide

Read this first!

- The contents of this manual are subject to change without notice.
- The contents of this manual have been checked at each step of the production process. Feel free to contact us if you notice anything that is questionable, erroneous, etc.
- Any copying of the contents of this User's Guide, either in part or its entirety, is forbidden. Except for your own personal use, any other use of the contents of this manual without the permission of CASIO COMPUTER CO., LTD. is forbidden under copyright laws.
- CASIO COMPUTER CO., LTD. shall not be held liable for any damages or lost profits suffered by you or any third party due to the use or malfunction of this product.
- CASIO COMPUTER CO., LTD. shall not be held liable for any damages, lost profits, or claims by third parties arising out of the use of Photo Transport or CASIO Connection powered by Eye-Fi.
- CASIO COMPUTER CO., LTD. shall not be held liable for any damages or lost profits caused by loss of memory contents due to malfunction, repair, or any other reason.
- Note that the example screens and product illustrations shown in this User's Guide may differ somewhat from the screens and configuration of the actual camera.

LCD Panel

The liquid crystal panel of the monitor screen uses high-precision technology that provides a pixel yield in excess of 99.99%. This means that some very small number of pixels may not light or may remain lit at all times. This is due to the characteristics of the liquid crystal panel, and does not indicate malfunction.

Take test shots

Before shooting your final image, shoot a test shot to ensure that the camera is recording correctly.

Contents

Unpacking	2
Read this first!	3
General Guide	8
Monitor Screen Contents	9

■ Quick Start Basics 11

What you can do with your CASIO camera	11
Changing the Camera Style to Suit Shooting Conditions	13
■ Opening and Closing the Frame	13
■ Rotating the Monitor Screen	14
■ Camera Configurations	15
Using the Touch Panel	16
First, charge the battery prior to use	18
Configuring Basic Settings the First Time You Turn On the Camera	24
Preparing a Memory Card	25
■ Supported Memory Cards	25
■ To load a memory card	26
■ To format (initialize) a new memory card	27
Turning Power On and Off	28
To Shoot a Snapshot	29
■ Selecting an Auto Recording Mode	29
■ To shoot a snapshot	30
Viewing Snapshots	32
Deleting Snapshots and Movies	33
■ To delete a single file	33
■ To delete all files	33
Snapshot Shooting Precautions	34
■ Auto Focus Restrictions	34

■ Recording Images 35

Selecting a Recording Mode	36
■ Shooting Snapshots Digitally Processed for Artistic Effect (HDR Art)	37
■ Shooting a Panorama Image (Slide Panorama)	38
■ Using Motion Shutter to Trigger a Self-timer Operation (Motion Shutter)	40
Shooting with Zoom	41
Shooting a Self-portrait	43
To record a movie	44

■ Using BEST SHOT 47

Shooting Clearer Snapshots (Multi SR Zoom)	48
Digitally Correcting for Overexposure and Underexposure (HDR)	49
Shooting with High Speed Night Scene (High Speed Night Scene)	50
Shooting with High Speed Anti Shake (High Speed Anti Shake)	51
Shooting with Priority on Subject Faces (High Speed Best Selection)	52

■ Advanced Recording Settings 53

Using the REC Menu	53
■ Using Touch Shutter (Touch Shutter)	54
■ Using the Self-timer (Self-timer)	54
■ Using the LED Light (LED)	55
■ Changing the Image Size (Image Size)	55
■ Movie Image Quality Settings (Movie Quality)	57
■ Correcting Image Brightness (EV Shift)	58
■ Adjusting White Balance (White Balance)	59
■ Specifying ISO Sensitivity (ISO)	60
■ Selecting a Focus Mode (Focus)	61
■ Turning on Image Review (Review)	62

■ Viewing Snapshots and Movies 63

Viewing Snapshots	63
Viewing a Movie	63
■ Editing a Movie on the Camera (Movie Editing)	65
Viewing a Panorama Image	66
Playing a Slideshow on the Camera (Slideshow)	67
Viewing the Image Menu	67
Zooming an On-screen Image	68
Viewing Snapshots and Movies on a TV Screen	69

■ Other Playback Functions (PLAY) 71

Using the PLAY Menu	71
■ Protecting a File Against Deletion (Protect)	72
■ Rotating an Image (Rotation)	73

■ Printing 74

Printing with a Computer	74
------------------------------------	----

■ Using the Camera with a Computer 76

Things you can do using a computer...	76
Using the Camera with a Windows Computer	77
■ Viewing and Storing Images on a Computer	78
■ Playing Movies	81
■ Transferring Images from Your Computer to Camera Memory	82
■ Uploading Image Data to an Online Service	84
■ User Registration	86
Using the Camera with a Macintosh	87
■ Connecting the Camera to Your Computer and Saving Files	88
■ Transferring Images Automatically and Managing Them on Your Macintosh	90
■ Playing a Movie	91
■ User Registration	91
Using an Eye-Fi Wireless SD Memory Card to Transfer Images (Eye-Fi)	92
Files and Folders	93
Memory Card Data	93

■ Other Settings (Set Up) 95

Adjusting Monitor Screen Brightness	(Screen)	95
Turning off Eye-Fi Card Communication	(Eye-Fi)	95
Configuring Camera Sound Settings	(Sounds)	96
Time Stamping Snapshots	(Timestamp)	96
Configuring World Time Settings	(World Time)	97
■ Setting a Travel Destination		97
■ Selecting the Time Display		98
Setting the Camera's Clock	(Adjust)	98
Specifying the Date Style	(Date Style)	99
Specifying the Display Language	(Language)	99
Calibrating the Touch Panel	(Calibrate TP)	100
Selecting the HDMI Terminal Output Method	(HDMI)	100
Formatting Built-in Memory or a Memory Card	(Format)	101
Resetting the Camera to Factory Defaults	(Reset)	101

■ Configuring Monitor Screen Settings 102

Changing the Screen Orientation	102
Selecting Display Information	(DISP) 102

Precautions during Use	103
Power Supply.	109
■ Charging	109
■ Battery Precautions.	110
■ Battery Replacement	110
■ Using the Camera in another Country	110
Disposing of the Camera	111
Using a Memory Card	112
■ To replace the memory card	112
Computer System Requirements for Software (For Windows)	114
Reset Initial Default Settings	115
When things don't go right...	116
■ Troubleshooting	116
■ Display Messages.	120
Number of Snapshots/Movie Recording Time	121
Specifications.	123

General Guide

The numbers in parentheses indicate the pages where each item is explained.

Front

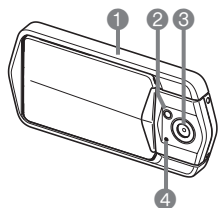

Back

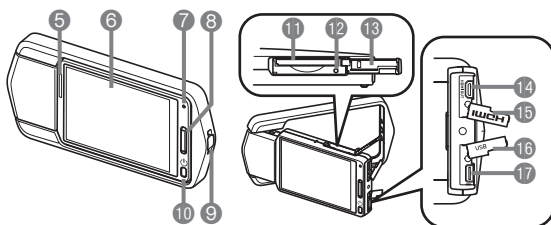

- ❶ Frame (page 13)
- ❷ LED light (page 55)
- ❸ Lens
- ❹ Microphone (pages 15, 46)
- ❺ Speaker
- ❻ Monitor screen (pages 9, 102)
- ❼ Back lamp (pages 19, 22, 28, 30)
- ❽ Shutter button (page 30)
- ❾ Strap hole (page 2)
- ❿ [⏻] (Power) (page 28)
- ⓫ Memory card slot (pages 26, 112)
- ⓬ Reset button (page 116)
- ⓭ Memory card slot cover (page 26)
- ⓮ [HDMI OUT] HDMI output (Micro) (page 69)
- ⓯ HDMI terminal cover (page 69)
- ⓰ USB port cover (pages 18, 20, 78, 88)
- ⓱ [USB] port (pages 19, 21, 79, 84, 89)

Monitor Screen Contents

The monitor screen uses various indicators, icons, and values to keep you informed of the camera's status.

- The sample screens in this section are intended to show you the locations of all the indicators and figures that can appear on the monitor screen in various modes. They do not represent screens that actually appear on the camera.

■ Snapshot Recording



- 1 Tab (page 28)
- 2 Focus mode (page 61)
- 3 Self-timer mode (page 54)
- 4 Digital zoom (page 41)
- 5 Snapshot image size (page 55)
- 6 Movie quality (pages 44, 57)
- 7 Zoom bar (pages 30, 41)
- 8 "Movie" icon (pages 31, 44)
- 9 Battery level indicator (page 23)
- 10 PLAY mode icon (page 28)
- 11 Information icon (page 102)
- 12 Screen orientation icon (page 102)
- 13 Recording mode icon (page 36)
- 14 Menu icon (page 53)

■ Movie Recording

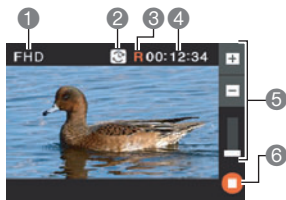

- 1 Movie quality (pages 44, 57)
- 2 Recording time switch icon (page 45)
- 3 Movie remaining time icon (page 45)
- 4 Remaining movie memory capacity/
Movie recording time (pages 45, 122)
- 5 Zoom bar (pages 30, 41)
- 6 "Movie stop" icon (pages 31, 44)

■ Snapshot Viewing

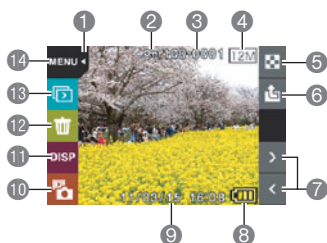

- 1 Tab (page 28)
- 2 Protect indicator (page 72)
- 3 Folder name/file name (page 93)
- 4 Snapshot image size (page 55)
- 5 Image menu icon (page 67)
- 6 Image upload icon (page 85)
- 7 Image scroll icons (pages 32, 63)
- 8 Battery level indicator (page 23)
- 9 Date/time (pages 24, 98)
- 10 REC mode icon (page 28)
- 11 Information icon (page 102)
- 12 Delete icon (page 33)
- 13 Slideshow icon (page 67)
- 14 Menu icon (page 71)

■ Movie Playback

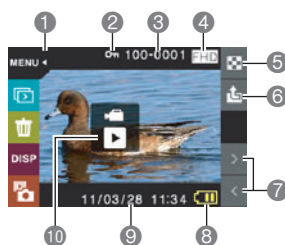

- 1 Tab (page 28)
- 2 Protect indicator (page 72)
- 3 Folder name/file name (page 93)
- 4 Movie quality (pages 44, 57)
- 5 Image menu icon (page 67)
- 6 Image upload icon (page 85)
- 7 Image scroll icons (pages 32, 63)
- 8 Battery level indicator (page 23)
- 9 Date/time (pages 24, 98)
- 10 "▶" Movie play icon (page 63)

What you can do with your CASIO camera

Your CASIO camera is packed with a powerful selection of features and functions to make recording of digital images easier, including the following five main functions.

A variety of shooting styles

The frame can be opened and the LCD monitor screen rotated into positions that make long-term shooting more comfortable and simplify self-shooting.

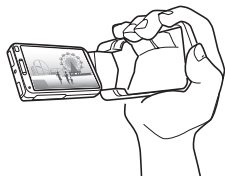

See page **13** for more information.

Simple touch panel operation

The monitor screen is a touch panel that can be used to perform operations.



See page **16** for more information.

Simple self-shooting

The monitor screen can be rotated so it faces in the same direction as the camera's lens, making self-shooting much easier.



See page **43** for more information.

Quick and easy image upload

The camera includes built-in software (CASIO Connection powered by Eye-Fi) that can be installed on a computer for simplifies uploading of image to an online service.

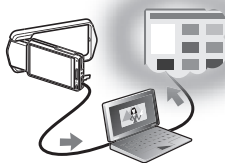

See page **84** for more information.

HDR Art

An HDR Art feature combines different parts of a burst of images shot with different exposures into a final image and performs high-precision image analysis to produce final images that are true works of art.



See page **37** for more information.

Changing the Camera Style to Suit Shooting Conditions

You can change the configuration of the camera by opening or closing the frame and rotating the monitor screen panel to suit shooting conditions.



IMPORTANT!

- Do not apply strong pressure to the surface of the monitor screen. Doing so can damage it.
- Never touch the lens with your fingers. Finger smudges, dirt, and other foreign matter on the lens can interfere with proper operation of the camera. Use a blower or other means to keep the lens and flash window free of dirt and dust, and wipe gently with a soft, dry cloth.

Opening and Closing the Frame

The frame of the camera can be rotated 360 degrees.

1. With the monitor screen facing towards you, hold onto the frame.

2. Push the monitor screen panel from behind.

3. Holding the edges of the monitor screen panel, swing the frame open.

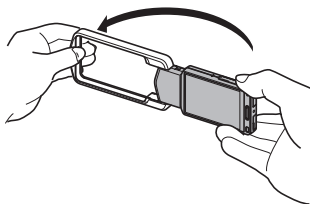
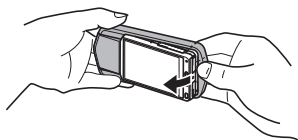

IMPORTANT!

- Do not try to open or close the frame while the monitor screen panel is rotated. Doing so can cause the frame to come into contact with the monitor screen panel and cause malfunction.

Rotating the Monitor Screen

Use the steps below to rotate the monitor screen.

NOTE

- While holding the monitor screen panel as shown in the illustration, you can rotate it 180 degrees clockwise and 90 degrees counterclockwise.
- The monitor screen panel can also be rotated when the frame is closed.

1. Hold the camera as shown in the illustration.

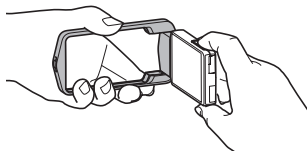

2. Firmly holding the frame, carefully rotate the monitor screen panel.

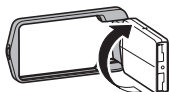



180 degrees clockwise



90 degrees counterclockwise

Camera Configurations

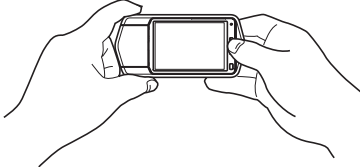
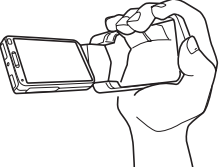
You can open the frame and rotate the monitor screen for a variety of different styles.

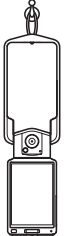
Normal Shooting	Movie Recording
<p>Shoot with the monitor screen facing the opposite direction of the lens.</p> 	<p>Open the frame 90 degrees and hold the frame. You can also shoot with the camera upside down, if you like.</p> 
Tabletop Shooting / Self-shooting	Suspended Shooting
<p>Point the monitor screen and lens in the same direction and open the frame about 30 degrees so the camera can stand up.</p> 	<p>Rotate the monitor screen 180 degrees and then open the frame 180 degrees so it can be hung from a wall, etc.</p> 

NOTE

- When shooting hold the camera still. Carefully press the shutter button and take care to avoid all movement as the shutter releases and for a few moments after it releases.
- Take care that your fingers and the strap do not cover any of the areas indicated in the illustration.
- To protect against accidentally dropping the camera, attach the wrist strap and make sure it is around your fingers or wrist while you are operating the camera.
- Never swing the camera around by its strap.
- The supplied strap is intended for use with this camera only. Never use it for any other purpose.

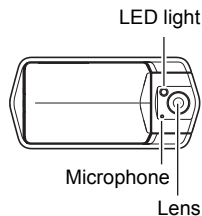

IMPORTANT!

- Take care to ensure that your finger is not blocking or is not too close to the LED light. Fingers can cause unwanted shadows when shooting.

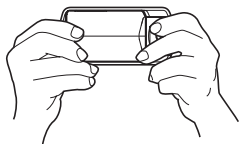

Using the Touch Panel

The monitor screen of the camera is a touch panel. This means you can perform the following operations by touching the screen with your fingers.

Touch

Momentarily touching the screen with your finger. Touch the screen to select an icon or menu item, and to configure settings.

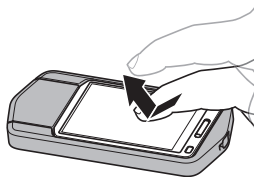

Touch-and-hold

Holding your finger against the screen. Touch and hold the screen to scroll images at high speed, or to perform continual frame-by-frame playback of a movie.



Drag

Holding your finger against the screen as you drag it up, down, left, or right. Use drag to move a screen image to a different location, and to scroll between images.

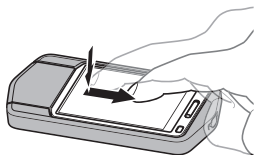

Spread

Holding your thumb and forefinger against the screen as you spread them out. Use spread to enlarge the screen image.

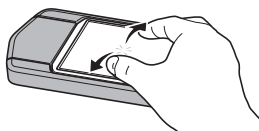

Squeeze

Holding your thumb and forefinger against the screen as you bring them together.

Use squeeze to reduce the size of the screen image.

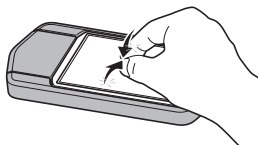

IMPORTANT!

- Never use a pointed or hard object to perform screen operations. Doing so can damage the screen.
- The touch panel is pressure-sensitive. Make sure you touch the panel with sufficient pressure when operating it.

NOTE

- Applying a commercially available LCD protective sheet will reduce the operation sensitivity of the monitor screen.
- If touch panel item selections are not performed as expected, calibrate the touch panel (page 100).

First, charge the battery prior to use.

The built-in rechargeable lithium ion battery of the camera is not charged when you purchase it. Perform the steps below to charge the battery before using the camera.

You can use either of the two following methods to charge the battery.

- USB-AC adaptor
- USB connection to a computer

■ To charge with the USB-AC adaptor

1. Turn off the camera.

Check to make sure that the camera's monitor screen is blank. If it isn't, press [⏻] (Power) to turn off the camera.

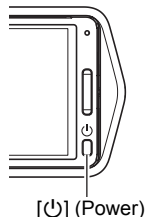

2. After connecting the supplied USB cable to the USB-AC adaptor, plug the adaptor into a household power outlet.

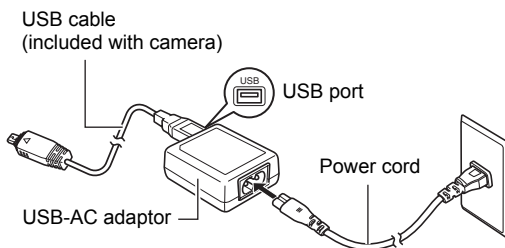

3. Press the back of the monitor screen panel so the panel moves towards you, and open the frame (page 13).

4. Hook your nail into the groove of the USB port cover and pull the cover in the direction indicated by the arrow to open it.

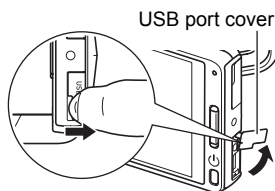

5. Connect the USB cable to the camera.

The back lamp should light red, indicating that charging has started. The back lamp will go out when charging is complete.

- It takes about 130 minutes to bring a fully dead battery to a full charge.
- A battery that has not been used for a long time or ambient temperature extremes can cause charging to take longer than normal. If charging takes longer than about six hours, a timer will terminate it automatically, even if the battery is not fully charged. This is indicated by the back lamp flashing red. If the battery has not been used for a very long time, charging may be terminated automatically and the back lamp may start flashing red after only about 45 minutes. In either case, disconnect the USB cable from the camera and then reconnect it to resume charging.
- Note that even while the connector is fully inserted, you still will be able to see the metal part of the connector as shown in the illustration.

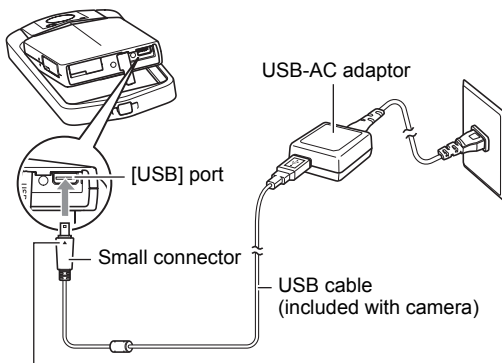

Making sure that the ▲ mark on the USB cable connector is towards the side opposite that of the monitor screen, connect the cable to the camera.

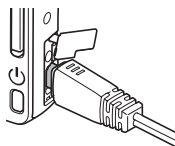

Back Lamp Operation

Lamp Status	Description
Lit Red	Charging
Flashing Red	Abnormal ambient temperature, USB-AC adaptor problem, or battery problem (page 109), or charging terminated by the timer
Off	Charging complete

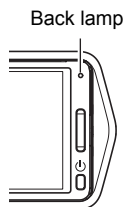

6. After charging is complete, disconnect the USB cable from the camera and then unplug the adaptor from the power outlet.

■ To charge using a USB connection to a computer

The camera's battery is charged whenever the camera is connected directly to a computer with the USB cable.

- Depending on the setup of your computer, you may not be able to charge the battery over a USB connection. If this happens, use of the USB-AC adaptor that comes with the camera is recommended.

IMPORTANT!

- If you connect the camera to a computer for the first time after you purchase it, the computer will enter a camera recognition operation. If this happens, perform the procedure on page 78 or 88. After the computer recognizes the camera, turn off the camera.

1. Press [⏻] (Power) to turn off the camera.

2. Press the back of the monitor screen panel so the panel moves towards you, and open the frame (page 13).

3. Hook your nail into the groove of the USB port cover and pull the cover in the direction indicated by the arrow to open it.

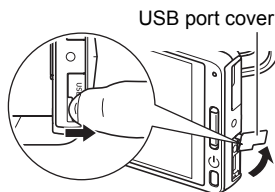

4. With your computer turned on, connect the camera to it.

The camera's back lamp will light red. After a short while, the camera will turn on automatically and the back lamp will light amber to indicate that charging has started.

The back lamp will light green when charging is complete. Note, however, that some computer models or connection conditions can produce low supply capacity. If low supply capacity exists, charging will start without the camera turning on. This is indicated by the back lamp lighting red. The back lamp will go out in this case after charging is complete.

- It takes about 260 minutes to bring a fully dead battery to a full charge.
- A battery that has not been used for a long time or ambient temperature extremes can cause charging to take longer than normal. If charging takes longer than about six hours, a timer will terminate it automatically, even if the battery is not fully charged. This is indicated by the back lamp flashing red. If the battery has not been used for a very long time, charging may be terminated automatically and the back lamp may start flashing red or go out after only about 30 minutes to 45 minutes. In either case, use of the USB-AC adaptor that comes with the camera is recommended.
- Note that even while the connector is fully inserted, you still will be able to see the metal part of the connector as shown in the illustration.

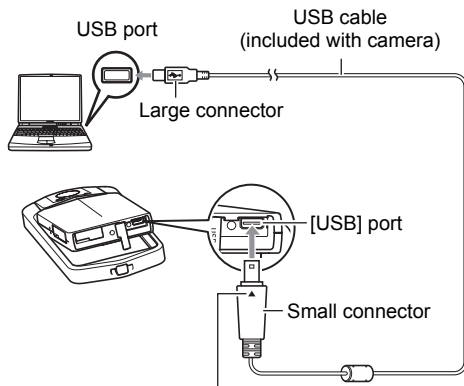

Making sure that the ▲ mark on the USB cable connector is towards the side opposite that of the monitor screen, connect the cable to the camera.

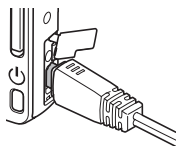

Back Lamp Operation

Lamp Status	Description
Lit Amber	Charging
Lit Red	Charging in progress (Data transfer with computer not supported.)
Flashing Red	Abnormal ambient temperature, or battery problem (page 109), or charging terminated by the timer
Lit Green	Charging complete, or charging stopped

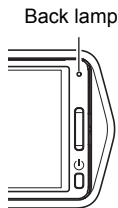

5. After charging is complete, disconnect the USB cable from the camera and then from the computer.

NOTE

- Even if you turn off the camera, the battery will continue to charge if there is a USB connection with a computer. Under this condition, the back lamp operates as described under “Back Lamp Operation” (page 19).

IMPORTANT!





- Charging is not performed while the connected computer is in the hibernate mode.
- A charging error can occur immediately after charging begins or some time after charging begins. A charging error is indicated by the back lamp flashing red.
- If low supply capacity exists due to your computer model or connection conditions, charging will start without the camera turning on. Turning on the camera in this case will cause charging to stop and enter USB data communication between the camera and the computer. The camera's back lamp will be lit green at this time.

Other Charging Precautions

- A battery that is still warm due to normal use may not charge fully. Leave the camera turned off and wait for a while to give the battery time to cool before charging it.
- A battery discharges slightly. Because of this, it is recommended that you charge the battery immediately before you need to use it.
- Charging the battery may cause interference with TV and radio reception. If this happens, plug the USB-AC adaptor into an outlet that is further away from the TV or radio.
- Actual charging time depends on the current battery level and charging conditions.
- Do not use the USB-AC adaptor with any other device.

Checking the Current Battery Level

As battery power is consumed, a battery indicator on the monitor screen indicates its current level as shown below.

Level	High ←————→ Low
Battery Indicator	 →  →  → 
Indicator Color	Cyan → Yellow → Red → Red

 indicates battery power is low. Charge the battery as soon as possible.

Recording is not possible when  is indicated. Charge the battery immediately.

- The level shown by the battery indicator may change when you switch between the REC mode and PLAY mode.
- Leaving the camera for about 30 days with no power supplied while the battery is dead will cause its date and time settings to be cleared. A message telling you to configure time and date settings will appear the next time you turn on the camera after restoring power. When this happens, configure date and time settings (page 98).
- See page 125 for information about battery life and number of shots.

Configuring Basic Settings the First Time You Turn On the Camera

The first time you turn on the camera, a screen appears for configuring the display language, date, and time settings. Failure to set the date and time correctly will cause the wrong date and time data to be recorded with images.

IMPORTANT!

- A screen for language selection will not appear in step 2 of the procedure below if you purchased a camera intended for the Japanese market. To change the display language from Japanese in this case, use the procedure under “Specifying the Display Language (Language)” (page 99). Note that a version of this manual in the language you select may not be included with a camera intended for the Japanese market.
- Camera models sold in certain geographic areas may not support display language selection.

1. Press [⏻] (Power) to turn on the camera.

2. Drag (page 16) upwards and downwards until you find the language you want, and then touch to select it.

3. Touch the date display format you want.

Example: July 10, 2012
YY/MM/DD → 12/7/10
DD/MM/YY → 10/7/12
MM/DD/YY → 7/10/12

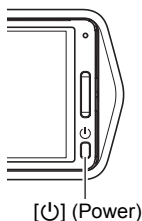

4. Touch the value you want to change (year, month, day, hour, minute).

5. Touch “▲” or “▼” to change the currently selected value.

- Touching and holding “▲” or “▼” will change the setting at high speed.
- To switch between 12-hour and 24-hour format, touch the 12/24 hour switch icon.

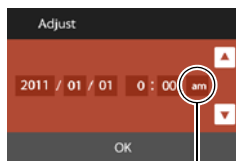

12/24 hour switch icon

6. When the date and time settings are the way you want, touch “OK”.

7. Touch “Auto” or “Premium Auto” to select the default auto recording mode you want.

8. Touch “Apply”.

- You will be able to change this setting later, if you want. See page 29 for details.

If you make a mistake configuring display language, date, or time settings with the above procedure, refer to the following pages for information about how to correct the settings.

- Display language: Page 99
- Date and time: Page 98

NOTE

- Each country controls its local time offset and the use of summer time, and so they are subject to change.

Preparing a Memory Card

Though the camera has built-in memory that can be used to store images and movies, you probably will want to purchase a commercially available memory card for greater capacity. The camera does not come with a memory card. Images recorded while a memory card is loaded are saved to the memory card. When no memory card is loaded, images are saved to built-in memory.

- For information about memory card capacities, see page 121.

Supported Memory Cards

- SD Memory Card
- SDHC Memory Card
- SDXC Memory Card



Use one of the above types of memory card.

- Use only SD cards that are compliant with the SD Card Association specification.
- This camera supports use of Eye-Fi cards.

To load a memory card

1. Press [⏻] (Power) to turn off the camera and then open the frame (page 13).
2. Hook your nail into the groove of the memory card slot cover and pull the cover in the direction indicated by the arrow to open it.

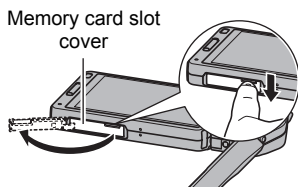

3. Load a memory card.

Positioning the memory card so its back is facing upwards (towards the monitor screen side of the camera), slide it into the card slot all the way in until you hear it click securely into place.

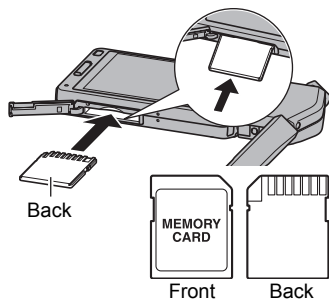

4. Close the memory card slot cover and then return the frame to its original position.

- For information about how to replace the memory card, see page 112.

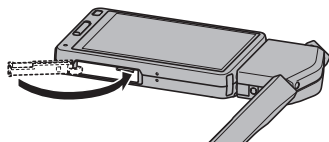

IMPORTANT!

- Never insert anything besides a supported memory card (page 25) into the memory card slot.
- Should water or any foreign object ever get into the card slot, immediately turn off the camera, and contact your retailer or nearest CASIO authorized service center.

To format (initialize) a new memory card

You need to format a new memory card before using it for the first time.

1. Load a memory card (page 26).

2. Turn on the camera and then touch “MENU”.

- If “MENU” is not displayed on the screen, touch the tab to display it (page 35).
-

3. Drag upwards and downwards until you find “Setup”, and then touch it.

4. Touch “Format”.

5. Touch “Format” and then touch “Yes”.

This starts the memory card format operation.



IMPORTANT!

- Formatting a memory card that already has snapshots or other files on it, will delete its contents. Normally you do not need to format a memory card again. However, if storing to a card has slowed down or if you notice any other abnormality, re-format the card.
- Be sure to use the camera to format a memory card. Formatting a memory card on a computer and then using it in the camera can slow down data processing by the camera. In the case of an SD, SDHC, or SDXC memory card, formatting on a computer can result in non-conformity with the SD format, causing problems with compatibility, operation, etc.
- Before formatting a new Eye-Fi card to use it for the first time, copy the Eye-Fi Manager install files to your computer. Do this before formatting the card.

Turning Power On and Off

■ To turn on the camera

Press [⏻] (Power).

This will turn on the camera, which is indicated when the back lamp lights green, and enter the REC mode.

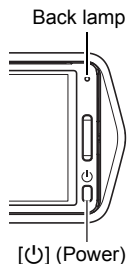

Entering the REC Mode and PLAY Mode

To enter the PLAY mode	In the REC mode, touch the tab on the monitor screen. On the screen image that appears, touch "▶" (PLAY).
To enter the REC mode	In the PLAY mode, touch the tab. On the screen image that appears, touch "▶" (REC).



■ To turn off the camera

Press [⏻] (Power).

NOTE



- To conserve battery power, an Auto Power Off function will turn off power automatically if you do not perform any operation for about five minutes.

To Shoot a Snapshot

Your camera has a variety of different recording modes to suit various shooting conditions and objectives (page 36). This section explains general shooting procedures using the auto recording mode.

Selecting an Auto Recording Mode

You can select one of two auto recording modes (Auto or Premium Auto) according to your digital imaging needs.

 Auto	This is the standard Auto recording mode.
 Premium Auto	With Premium Auto recording, the camera automatically determines whether you are shooting a subject or scenery, and other conditions. Premium Auto recording delivers higher image quality than standard Auto recording. <ul style="list-style-type: none">• It also requires more power (and runs down the battery quicker) than Auto.

1. Press [⏻] (Power) to turn on the camera.

2. Touch “” (Recording mode).

If “” (Recording mode) is not displayed on the screen, touch the tab to display it.



“” (Recording mode)

3. Touch “Auto” or “Premium Auto” to select the auto recording mode you want.

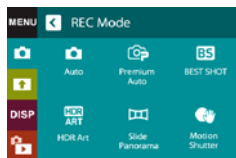

To shoot a snapshot

1. Point the camera at the subject.

If you are using Premium Auto, text will appear in the lower right corner of the monitor screen describing the type of shot the camera has detected.

- Touch the “+” or “-” mark on the top of the zoom bar to change the zoom factor (page 41).



- (Wide Angle)



+ (Telephoto)

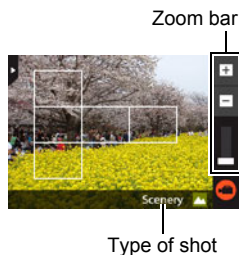

2. Half-press the shutter button to focus the image.

When focus is complete, the camera will beep, the back lamp will light green, and the focus frame will turn green.

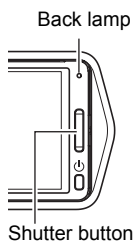

Focus frame

Half-press

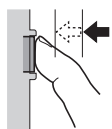

Press lightly until the button stops.

Beep, beep (Image is in focus.)

When you half-press the shutter button, the camera automatically adjusts exposure and focuses on the subject it is currently pointed at. Mastering how much pressure is required for a half-press and a full-press of the shutter button is an important technique for good-looking images.

3. Continuing to keep the camera still, press the shutter button the rest of the way down.

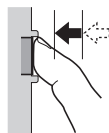

This records the snapshot.

Full-press



Snap (Image is recorded.)

Recording a Movie

Touch “” (Movie) to start movie recording. Touch “” (Movie Stop) to stop recording. See page 44 for details.



“” (Movie)/
“” (Movie Stop)

NOTE

- You also can shoot a snapshot by touching a point on the monitor screen (page 54).
- You can specify the image size for snapshots. See page 55 for more information.

■ If the image does not focus...

If the focus frame stays red and the back lamp is flashing green, it means that the image is not in focus (because the subject is too close, etc.). Re-point the camera at the subject and try to focus again.

■ Shooting with Auto

“Focus lock” (page 62) is the name of a technique you can use when you want to shoot an image in which the subject to be focused on is not within the focus frame in the center of the screen.

■ Shooting with Premium Auto

- In addition to shutter speed and ISO sensitivity, the camera automatically executes the following operation as required when shooting with Premium Auto.
 - Auto Focus is normally performed until you half-press the shutter button.
 - The camera automatically determines the focus point on the screen and focuses there.
 - When shooting people, the face detection feature detects the faces of up to ten individuals and adjusts focus and brightness accordingly.
- When shooting with Premium Auto, the message “Processing Premium Auto. Please wait...” may appear on the monitor screen. If you feel the camera is taking too long to process data, try shooting with standard Auto instead.
- In some cases, Premium Auto may not be able to interpret the shooting environment correctly. If this happens, shoot with standard Auto.

Viewing Snapshots

Use the following procedure to view snapshots on the camera's monitor screen.

- For information about how to play back movies, see page 63.

1. Touch “” (PLAY) to enter the PLAY mode.

This will display one of the snapshots currently stored in memory.

- If “” (PLAY) is not displayed on the screen, touch the tab to display it.
- Information about the displayed snapshot also is included (page 10).
- You also can clear the information to view only the snapshot (page 102).
- You can zoom the screen image by touching the monitor screen (page 68).

If you are recording a snapshot that is very important to you, it is recommended that you zoom the image and check its details after recording it.

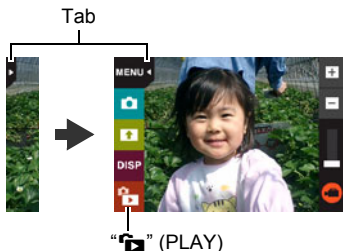

2. Touch “<” or “>”, or drag left or right across the screen image to scroll through the snapshots.

- To scroll at high speed, touch and hold “<” or “>”.



NOTE

- Pressing the shutter button while in the PLAY mode or while a menu screen is displayed will switch directly to the REC mode.

Deleting Snapshots and Movies

If memory becomes full, you can delete snapshots and movies you no longer need in order to free up storage and record more images.



IMPORTANT!

- Remember that a file (image) delete operation cannot be undone.

To delete a single file

1. In the PLAY mode, touch “<” or “>” to display the file you want to delete.

2. Touch “”.

- If “” is not displayed on the screen, touch the tab to display it.

3. Touch “1 File”.

This will delete the selected image.

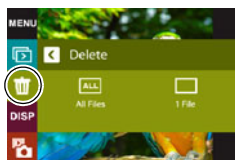

To delete all files

1. Enter the PLAY mode.

2. Touch “”.

- If “” is not displayed on the screen, touch the tab to display it.

3. Touch “All Files”.

4. Touch “Delete”.

This will cause the message “There are no files” to appear.

Snapshot Shooting Precautions

Operation

- If unwanted light is shining directly onto the lens, shade the lens with your hand.

Monitor Screen when Shooting Snapshots

- Subject brightness conditions can cause monitor screen response to slow and can cause digital noise in the monitor screen image.
- The image that appears on the monitor screen is for image composition. The actual image will be recorded in accordance with the currently selected recording mode (page 36).

Shooting Indoors under Fluorescent Lighting

- Minute flickering of fluorescent lighting can affect the brightness or color of an image.

Other Precautions

- The slower the shutter speed, the greater the possibility that noticeable noise will be generated in an image. Because of this, the camera automatically performs a noise reduction at slow shutter speeds. The noise reduction process causes it to take longer to record images at lower shutter speeds. The shutter speeds for which noise reduction is performed depend on the camera setup and shooting conditions.
- A noise reduction process is performed when ISO sensitivity is set to a high value. This can cause the camera to take relatively longer to be ready to shoot again after you press the shutter button. Do not perform any operation while the image recording operation is in progress.
- Due to the characteristics of the imaging element used by the camera, very fast moving objects in an image may appear distorted.

Auto Focus Restrictions

- Any of the following can make proper focus impossible.
 - Solid color wall or other very low contrast subject
 - Strongly back lit subject
 - Very shiny subject
 - Blinds or other subject with a repeating horizontal pattern
 - Multiple subjects at varying distances from the camera
 - Subject in a dark location
 - Camera movement while shooting
 - Fast-moving subject
 - Subjects outside the focus range of the camera
- If you cannot focus properly, try using focus lock (page 62).

Recording Images

Touching the monitor screen in the REC mode will display a screen for configuring REC mode settings.

■ To configure REC mode settings

1. Press [⏻] (Power) to turn on the camera and enter the REC mode.

- If the camera is in the PLAY mode, touch “” (REC) to enter the REC mode.

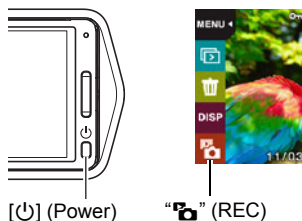

2. Touch the item whose setting you want to change.

- If there are no icons along the left side of the screen, touch the tab to display them.

- 1 Tab (page 28)
- 2 Menu (page 53)*
- 3 Recording mode (page 36)
- 4 Screen orientation (page 102)
- 5 Information (page 102)
- 6 PLAY mode (page 28)
- 7 Zoom (page 41)
- 8 Movie (page 44)



- * Depending on the recording mode, some of the items on the menu that appears may not be usable.

Selecting a Recording Mode

The camera has a variety of different recording modes.





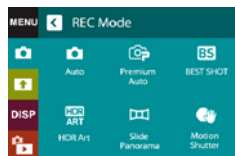

1. In the REC mode, touch “” (Recording mode).

- If “” (Recording mode) is not displayed on the screen, touch the tab to display it.

2. Touch the icon of the recording mode you want to use.

This enters the selected recording mode.



 Auto	Standard Auto recording mode. This is the mode normally used for shooting (page 29).
 Premium Auto	With Premium Auto recording, the camera automatically determines whether you are shooting a subject or scenery, and other conditions. Premium Auto recording delivers higher image quality than standard Auto recording mode (page 29).
 BEST SHOT	With BEST SHOT, simply select the sample scene that resembles the type of shot you want, and the camera automatically configures ideal settings for the subject and shooting conditions (page 47).
 HDR Art	This mode digitally processes data to turn images you shoot into worlds of art (page 37).
 Slide Panorama	Simply move the camera as you record. The camera will shoot a series of images and then combine them into a sweeping panorama automatically.
 Motion Shutter	In this mode, the camera starts a self-timer countdown when it detects subject movement (page 40).

Shooting Snapshots Digitally Processed for Artistic Effect (HDR Art)

This feature applies HDR (High Dynamic Range, page 49) photography to transform snapshots into works of art that provide a greater degree of expression than conventional photography.



Normal image



HDR Art image

1. In the REC mode, touch “” (Recording mode).

2. Touch “” (HDR Art).

3. Press the shutter button to shoot.

- After you press the shutter button, the message “Busy... Please wait...” will appear on the monitor screen to indicate that recording is in progress. Keep the camera still while this message is displayed. The recording process takes some time to complete after the message appears. Image shooting is disabled while the message is displayed.

NOTE

- This function works best when the camera is made stationary by placing it on a level surface, etc.
- With this REC mode, the LED light setting automatically becomes off.
- Shooting with this REC mode makes the shooting range narrower than normal.
- The desired HDR Art effect may not be attained if the camera or subject moves during shooting.
- Depending on shooting conditions and image composition, this REC mode may not be able to produce the desired result.

■ Adjusting the Level of the Art Effect

You can specify one of three levels for application of the art effect.

1. For the recording mode, select “HDR Art”.

2. Touch “ART +2”.

3. Touch the level you want to select.

- 0 (off) - +3 (strong)

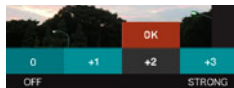

4. Touch “OK”.

|| Shooting a Panorama Image (Slide Panorama)

With Slide Panorama, you move the camera to compose and record multiple images, which are then combined to a panorama. This feature lets you shoot a panorama which is dramatically greater than the physical capabilities of the lens.

- The final panorama image can be one of the two sizes shown below.
Slide Direction is Right or Left: Maximum 11520×1080 pixels
Slide Direction is Up or Down: Maximum 1920×7296 pixels
- Zoom operations are not supporting during Slide Panorama shooting. The zoom setting is fixed at full wide angle.
- You can shoot a panorama image for approximately 360 degrees horizontally, or approximately 180 degrees vertically.







1. In the REC mode, touch “” (Recording mode).

2. Touch “” (Slide Panorama).

3. Touch the icon for the slide direction (the direction the camera will move while shooting).

You can select one of four different slide directions:

“” (right), “” (left), “” (up), “” (down).



4. Point the camera at the start of the panorama and half-press the shutter button to allow the camera to focus automatically.

5. Press the shutter button the rest of the way down and a slide cursor will appear on the monitor screen. Slowly move the camera in the direction indicated by the arrow on the screen until the slide cursor reaches the other end of its movement range (i.e. all the way to the right when moving the camera to the right).

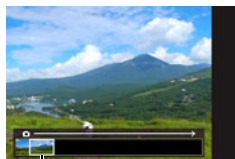

Slide cursor

- The camera will start composing the panorama image internally when the slide cursor reached the other end of the movement range.
- Image composing also will start automatically if you stop moving the camera during panorama shooting. After you stop moving the camera, the message “Busy... Please wait...” appears as the camera processes the image. Wait until this message disappears before using the camera. Image shooting is disabled while the message is displayed.

NOTE



- The following conditions are not compatible with Slide Panorama shooting.
 - Subject whose brightness is very different from that of its surroundings due to artificial light, sunlight, etc.
 - Rivers, waves, waterfalls, or other subject with constantly changing patterns
 - Sky, beach, or other subject with continuous patterns
 - Camera too close to the main subject
 - Moving subject
- Slide Panorama may stop part way through in the following cases.
 - Subject or camera movement
 - Camera movement that is too fast or too slow
- Shooting a Slide Panorama image after half-pressing the shutter button to perform Auto Focus may not produce the desired results if there are considerable differences in the brightness, color, and/or focus of the individual images. If this happens, try changing the focus position by focusing on a different subject, etc.
- Since a Slide Panorama image is created by joining multiple images together, there may be some roughness at the point where two images are joined.
- Shooting under a flickering light source (such as fluorescent lighting) may result in uneven brightness and/or coloring in the final Slide Panorama image.
- Shooting in dark surroundings may result in a blurred image or may make Slide Panorama shooting impossible.
- Slowly move the camera at a constant speed in the same direction as the arrow that appears on the monitor screen.
- When moving the camera, try to keep the arrow on the monitor screen as straight as possible.
- The exposure and white balance when shooting Slide Panorama images are fixed at the levels measured when you half-press the shutter button at the beginning of the operation.
- An error message will appear if the camera is unable to successfully record a series of images.

- If you shoot a moving subject, the camera may not be able to compose the panorama image properly.
- With this REC mode, the LED light setting automatically becomes off.

Using Motion Shutter to Trigger a Self-timer Operation (Motion Shutter)

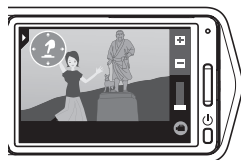
With Motion Shutter the camera automatically triggers a self-timer countdown whenever it detects subject movement within a framed area you specify on the monitor screen. This means you can control operation of the self-timer from a distance by waving your hand, so you can include yourself in the image being shot.



- 1. In the REC mode, touch “” (Recording mode).**
- 2. Touch “” (Motion Shutter).**
- 3. Drag “” to the location in the image where you want movement to be detected.**
- 4. When everything is ready, press the shutter button all the way down.**
Motion Shutter will go into standby to wait for trigger movement.
- 5. Facing the camera, move your hand or perform some other movement in the area of the icon you positioned in step 3.**
When the camera detects subject movement within the framed area, it will automatically start a self-timer countdown. The camera will shoot an image when the countdown reaches zero, and then go back into Motion Shutter standby to wait for the next trigger movement.

NOTE

- The trigger time of the Motion Shutter self-timer is fixed at two seconds.
- Motion Shutter exits standby automatically after it shoots six images.
- To cancel Motion Shutter standby at any time, press the shutter button.
- Motion Shutter may not operate properly when there is little difference in the color of the subject and the color of the background enclosed by the boundary, or when the subject is located far away from the camera, making it too small.

Shooting with Zoom

Your camera is equipped with various types of zoom: HD Zoom, SR Zoom, and digital zoom. The maximum zoom factor depends on the image size setting.

HD Zoom	Allows greater zoom capabilities by cutting out a portion of the original image and enlarging it.
SR Zoom	Applies super resolution technology to suppress image deterioration.
Digital zoom	Digitally processes the center of the image to enlarge it.

1. In the REC mode, touch the “+” or “-” mark on the top of the zoom bar to zoom.

+ (Telephoto):

Enlarges the subject and narrows the range.

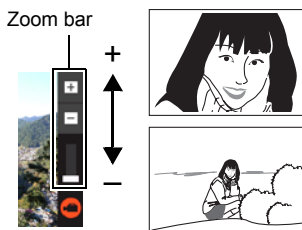

- (Wide Angle):

Reduces the size of the subject and broadens the range.



2. Press the shutter button to shoot the image.

NOTE

- Telephoto images are prone to blurring caused by camera movement when you press the shutter button. Because of this, stabilizing the camera by placing it on a level surface, etc. is recommended.
- Zoom operations are disabled during high speed movie recording. Perform the zoom operation before you touch “” (Movie) to start recording.
- Zoom operations are not supporting during Slide Panorama shooting. The zoom setting is fixed at full wide angle.
- “” is displayed on the monitor screen while digital zoom is being used.

■ Zoom Factor

- The image deterioration point depends on the image size (page 55) and recording mode (page 36). The smaller the image size, the higher the zoom factor you can use before reaching the image deterioration point.

Auto, Premium Auto, Motion Shutter

Image Size	Undeteriorated Zoom Limit	Maximum Zoom Factor
12M	1.5X	4.0X
3:2	1.5X	4.0X
5M	2.3X	6.2X
VGA	9.4X	15.9X

BEST SHOT (Multi SR Zoom)

Image Size	Undeteriorated Zoom Limit	Maximum Zoom Factor
10M	2.0X	4.0X
5M	2.9X	5.7X
VGA	11.4X	15.9X

HDR Art, BEST SHOT (excluding Multi SR Zoom)

Image Size	Undeteriorated Zoom Limit	Maximum Zoom Factor
10M	1.0X	4.0X
5M	1.4X	5.7X
VGA	5.7X	15.9X

Shooting a Self-portrait

You can configure the camera so the monitor screen and lens are facing in the same direction. This means you can shoot with the self-timer as you compose the self-portrait on the monitor screen.

- When using the self-timer to shoot a self-portrait, select “Auto” or “Premium Auto” for the recording mode.

- 1. Rotate the monitor screen panel so the screen is facing in the same direction as the lens (page 13).**
- 2. Select “Auto” or “Premium Auto” for the recording mode (page 29).**
- 3. Drag “⌚” (Self-timer) downwards to specify the self-timer countdown duration.**

The camera will shoot an image when the countdown reaches zero.

- You can set a self-timer countdown duration within the range of two to ten seconds. The further you drag, the longer the duration.
- To cancel an ongoing countdown, touch anywhere on the screen except where the self-timer icon is displayed.
- Pressing the shutter button during an ongoing countdown will cancel the countdown and shoot an image.

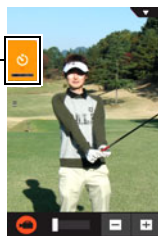

“⌚” (Self-timer)

To record a movie

The following procedure explains how to record a movie.

- You can record a movie while one of the following recording modes is selected.
 - Auto
 - Premium Auto
 - BEST SHOT (High Speed Night Scene)

“MENU”



1. In the REC mode, touch “MENU”.

- If “MENU” is not displayed on the screen, touch the tab to display it.

2. Drag upwards and downwards until you find “Movie Quality”, and then touch to select it.

3. Touch the item whose setting you want to change.

Movie Quality	Frame Rate	Image Size (Pixels)	Description
Full HD	30fps	1920×1080	Select this setting to record full high-definition (Full HD) movies. The aspect ratio of movies recorded with this setting is 16:9.
HD	30fps	1280×720	Select this setting to record high-definition (HD) movies. The aspect ratio of movies recorded with this setting is 16:9.
HS240	240fps	432×320	Select this setting to record high speed movies at a speed of 240 fps. <ul style="list-style-type: none">• Audio is not recorded.

4. To close the menu screen, touch “MENU” or press the shutter button.

5. Touch “ⓘ” (Movie).

This will start recording.

- Monaural audio is also recorded during movie recording while “Full HD” or “HD” is selected for the movie quality setting.
- Touching “ⓘ” while recording is in progress will cause the remaining recording time and “R” to appear. Touch “ⓘ” again to switch back to the elapsed recording time.
- When “Full HD” or “HD” is selected as the movie quality, you can perform a zoom operation while recording is in progress by touching the “+” or “-” mark on the top of the zoom bar.
- When “Macro” is selected as the movie focus mode (page 61), you can half-press the shutter button before starting recording to focus.

Recording time/
Remaining recording time

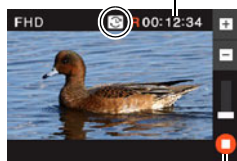

“ⓘ” (Movie)/
“ⓘ” (Movie Stop)

6. Touch “ⓘ” (Movie Stop) to stop recording.

Movie recording also will stop automatically if memory becomes full before you touch “ⓘ” (Movie Stop).

- The maximum size allowed for a single movie file is 4GB. Movie recording stops automatically when a file becomes 4GB.

Minimizing the Effects of Camera Movement during Movie Recording

You can configure the camera to minimize the effects of camera movement during Full HD and HD movie recording (page 81). Note, however, that this does not prevent image blur due to subject movement.

High Speed Movie Recording Precautions

- When shooting a high speed movie, shoot in a well-lit environment.
- When recording a high speed movie, light source flicker can cause horizontal bands to appear in the image. This does not indicate malfunction of the camera.

IMPORTANT!

- Spending a long time using movie recording will cause the camera to become slightly warm to the touch. This is normal and does not indicate malfunction.
- The camera also records audio along with Full HD and HD movies. Note the following points when shooting a movie.
 - Take care that the microphone is not blocked by your fingers, etc.
 - Good audio recording results are not possible when the camera is too far away from what you are trying to record.
- Shooting movies for long periods in areas where temperature is relatively high can cause digital noise (dots of light) to appear in the movie image. A rise in the camera's internal temperature also may force movie recording to stop automatically. If this happens, stop recording and allow the camera to cool down, which should cause normal operation to resume.
- Shooting a movie using the camera's built-in memory will cause movie frames to be dropped. Always use a high speed memory card (not built-in memory) for movie recording.
- Use of certain types of memory cards slows down data transfer and increases the time it takes to record movie data, which can result in movie frames being dropped. The movie icon turns yellow to indicate that frames are being dropped. In order to avoid problems such as these, use of an Ultra High Speed Type SD memory card is recommended. Note, however that CASIO makes no guarantees about the operation of any Ultra High Speed Type SD memory card used with this camera.

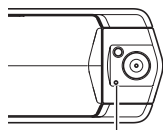

Microphone

NOTE

- Except for High Speed Movie, zoom operations are supported during movie recording (page 41). Zoom is disabled during high speed movie recording. If you want to use zoom, perform the zoom operation before you touch "⏏" (Movie) to start recording.
- SR Zoom (page 41) is disabled during movie recording.
- The effects of camera movement in an image become more pronounced when you shoot close up or with a large zoom factor. Because of this, stabilizing the camera by placing it on a level surface, etc. is recommended.
- During High Speed Movie recording, focus is fixed at the position where it was when recording started. To focus an image, half-press the shutter button for Auto Focus before you touch "⏏" (Movie) to start recording.

Using BEST SHOT

BEST SHOT provides you with a collection of sample “scenes” that show a variety of different types of shooting conditions. When you need to change the setup of the camera, simply find the scene that matches what you are trying to achieve, and the camera sets up for it automatically. This helps to minimize the chance of ruined images due to poor exposure and shutter speed settings.

■ To shoot an image with BEST SHOT

1. In the REC mode, touch “” (Recording mode).

- If “” (Recording mode) is not displayed on the screen, touch the tab to display it.

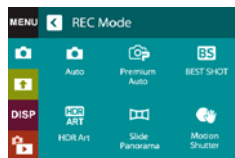

2. Touch “” (BEST SHOT).

This will display a menu of BEST SHOT scenes.

3. Touch the scene you want to select.

- Touching “” in the upper right corner of the screen and then touching a BEST SHOT scene will display detailed information about the scene.

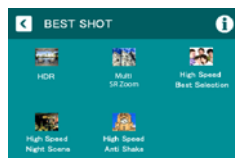

4. Press the shutter button (if you are shooting a snapshot) or touch “” (Movie) (if you are shooting a movie).

■ BEST SHOT Precautions

- BEST SHOT scene images were not shot using this camera.
- Images shot using a BEST SHOT scene may not produce the results you expected due to shooting conditions and other factors.
- You can modify the camera settings that are configured after you select a BEST SHOT scene. Note, however, that the BEST SHOT settings revert to their defaults when you select another BEST SHOT scene or turn off the camera.
- Movie recording is supported only while “High Speed Night Scene” is selected. Selecting “HS240” for the movie quality setting while the “High Speed Night Scene” BEST SHOT scene is selected will cause the camera to record movies using the auto recording mode.
- When a BEST SHOT scene is selected, “12M” and “3:2” cannot be selected for the image size. Selecting a BEST SHOT scene while “12M” or “3:2” is selected will cause the image size setting to change to “10M”.

Shooting Clearer Snapshots (Multi SR Zoom)

Multi SR Zoom uses super-resolution technology and multiple Continuous Shutter (CS) images for higher quality and clarity across the entire image. For information about the zoom factor, see page 42.

- When shooting with Multi SR Zoom, the camera may require more time for image data processing between shots.

1. In the REC mode, touch “” (BEST SHOT).

2. Touch “Multi SR Zoom” scene.

3. Press the shutter button to shoot.

- After you press the shutter button, the message “Busy... Please wait...” will appear on the monitor screen to indicate that recording is in progress. Keep the camera still while this message is displayed. The recording process takes some time to complete after the message appears. Image shooting is disabled while the message is displayed.

NOTE

- Multi SR Zoom is effective when you want to capture delicate textures.
- With this BEST SHOT scene, the LED light setting automatically becomes off.
- Shooting with this BEST SHOT scene makes the shooting range narrower than normal.
- The desired Multi SR Zoom effect may not be attained if the camera or subject moves during shooting.
- Depending on shooting conditions and image composition, this BEST SHOT scene may not be able to produce the desired result.

Digitally Correcting for Overexposure and Underexposure (HDR)

With HDR (High Dynamic Range), the camera shoots a series of CS images using different exposure settings and combines them into a final image to correct for overexposure or underexposure of subjects of different brightness levels.

1. In the REC mode, touch “” (BEST SHOT).

2. Touch “HDR” scene.

3. Press the shutter button to shoot.

- After you press the shutter button, the message “Busy... Please wait...” will appear on the monitor screen to indicate that recording is in progress. Keep the camera still while this message is displayed. The recording process takes some time to complete after the message appears. Image shooting is disabled while the message is displayed.

NOTE

- This function works best when the camera is made stationary by placing it on a level surface, etc.
- With this BEST SHOT scene, the LED light setting automatically becomes off.
- Shooting with this BEST SHOT scene makes the shooting range narrower than normal.
- The desired HDR effect may not be attained if the camera or subject moves during shooting.
- Depending on shooting conditions and image composition, this BEST SHOT scene may not be able to produce the desired result.

Shooting with High Speed Night Scene (High Speed Night Scene)

With High Speed Night Scene, the camera automatically detects shooting conditions. When you press the shutter button, the camera will record a burst of images and merge them in a way that minimizes image blur due to low light conditions.

1. In the REC mode, touch “” (BEST SHOT).

2. Touch “High Speed Night Scene” scene.

3. When you are ready to shoot, press the shutter button.

- After you press the shutter button, the message “Busy... Please wait...” will appear on the monitor screen to indicate that recording is in progress. Keep the camera still while this message is displayed. The recording process takes some time to complete after the message appears. Image shooting is disabled while the message is displayed.

NOTE

- With this BEST SHOT scene, the LED light setting automatically becomes off.
- When holding the camera by hand while shooting with this BEST SHOT scene, make sure that the subjects remain as still as possible as the camera shoots the series of images.
- Shooting with this BEST SHOT scene makes the shooting range narrower than normal.
- Movement of the camera while it is placed on a surface may cause erroneous judgment that it is hand held.
- If surroundings are extremely dark when shooting with “High Speed Night Scene”, the camera may not be able to shoot at proper brightness due to insufficient exposure.
- When shooting with this BEST SHOT scene, the ISO sensitivity setting is fixed at “AUTO”.

Shooting with High Speed Anti Shake (High Speed Anti Shake)

When you press the shutter button while High Speed Anti Shake is enabled, the camera records multiple images and automatically combines them in a way that produces a final image with minimal blur. You can shoot with this feature to minimize the effects of camera movement when shooting with optical anti shake does not produce the desired results.

1. In the REC mode, touch “” (BEST SHOT).

2. Touch “High Speed Anti Shake” scene.

3. When you are ready to shoot, press the shutter button.

- After you press the shutter button, the message “Busy... Please wait...” will appear on the monitor screen to indicate that recording is in progress. Keep the camera still while this message is displayed. The recording process takes some time to complete after the message appears. Image shooting is disabled while the message is displayed.

NOTE

- With this BEST SHOT scene, the LED light setting automatically becomes off.
- Shooting with this BEST SHOT scene makes the shooting range narrower than normal.
- High Speed Anti Shake may not operate properly resulting in blurred images if the camera is moved more than the allowable range or if the subject moves during shooting.
- When shooting with this BEST SHOT scene, the ISO sensitivity setting is fixed at “AUTO”.

Shooting with Priority on Subject Faces (High Speed Best Selection)

With High Speed Best Selection, the camera automatically shoots a series of images, and selects the best one based on facial image blur, and facial expression (whether the subject is smiling or blinking).

1. In the REC mode, touch “” (BEST SHOT).

2. Touch “High Speed Best Selection” scene.

3. Press the shutter button to shoot.

- This will cause the message “Busy... Please wait...” to appear. Do not move the camera while this message is displayed. The recording process takes some time to complete after the message appears.

NOTE

- With this BEST SHOT scene, the LED light setting automatically becomes off.
- Shooting with this BEST SHOT scene makes the shooting range narrower than normal.
- If one or more of the faces are blurred in all of the images that are shot, they will be blurred in the final image as well.
- The following conditions may make it impossible for the camera to determine if the subject is blinking or smiling. This may result in a final image in which the subject is blinking or not smiling.
 - Faces that are partially or completely darkened by shadows, etc.
 - Hair that is hiding or near the eyes
 - Eye glasses
 - Small faces
 - Faces that are not looking directly at the camera
- Shooting a large group of people will cause processing of the image after shooting to take longer.

Advanced Recording Settings

The following are menu operations you can use to configure various camera settings.

Using the REC Menu

■ Example Menu Screen Operation

1. In the REC mode, touch “MENU”.

This will display the menu screen.

- If “MENU” is not displayed on the screen, touch the tab to display it.
- Menu contents are different in the REC mode and PLAY mode.



2. Drag upwards and downwards until you find the item whose setting you want to change.

3. Touch the item.

4. Configure the setting of the item in accordance with the screen contents.

- To cancel and exit the menu, touch “MENU” or press the shutter button.

NOTE

- Switching from “Auto” to “Premium Auto” (page 29) will make some menu items unavailable.

■ Menu Operations in This Manual

Menu operations are represented in this manual as shown below. Touch the indicated icons and items, and perform operations as they are indicated, from left to right.

Procedure

Enter the REC Mode → MENU → Touch Shutter

Using Touch Shutter (Touch Shutter)

Procedure

Enter the REC Mode → MENU → Touch Shutter

You can use the procedure below to shoot a snapshot.

1. Touch “On”.

2. Point the camera at the subject.

3. When you want to shoot, touch the monitor screen.

The camera automatically comes into focus and then shoots.

- You can still use the shutter button to shoot even when “On” is selected for Touch Shutter.

NOTE

- When “Auto” is selected as the recording mode, the camera will automatically focus on the point you touch.
- When “Premium Auto” is selected as the recording mode, the camera will automatically determine the optimum focus point(s) and focus automatically.

Using the Self-timer (Self-timer)

Procedure

Enter the REC Mode → MENU → Self-timer

With the Self-timer, pressing the shutter button starts a timer. The shutter is released and the image is shot after a fixed amount of time.

10 sec	10-second Self-timer
2 sec	2-second Self-timer <ul style="list-style-type: none">• When shooting under conditions that slow down the shutter speed, you can use this setting to prevent image blur due to camera movement.
Off	Self-timer is disabled.

- You can interrupt an ongoing Self-timer countdown by pressing the shutter button.

Using the LED Light (LED)

Procedure

Enter the REC Mode → MENU → LED

Use the LED light when shooting where lighting is dim. The effectiveness of the LED light is reduced the further you are from the subject.

IMPORTANT!

- Do not turn on the LED light near a person's eyes and do not allow anyone to look directly into the light.
- You should compose the image so the main subject is in the center of the image when using the LED light.
- Since the camera is equipped with a wide-angle lens, the center tends to be brighter while the periphery tends to be darker.

Changing the Image Size (Image Size)

Procedure

Enter the REC Mode → MENU → Image Size

This setting can be used to configure snapshot image size.

Image Size (Pixels)	Suggested Print Size and Application	Description
12M (4000×3000)	Poster Print	Good detail for better clarity even for images cropped from the original on a computer, etc.
3:2 (4000×2656)	Poster Print	
10M (3648×2736)	Poster Print	Good detail
5M (2560×1920)	A4 Print	
VGA (640×480)	E Mail	Image files are smaller, which is better when attaching images to e-mail. However, images are relatively coarser.

- The initial factory default image size setting is 12M (12 million pixels).
- Selecting “3:2” records images with an aspect ratio of 3:2, which matches the standard aspect ratio of print paper.
- You should regard the print paper sizes suggested here as guidelines only (200 dpi print resolution).

- Available image sizes are limited for some functions as noted below.

12M, 3:2	This image size cannot be selected while the HDR Art recording mode or a BEST SHOT scene (Except for High Speed Best Selection) is selected. Selecting one of these settings after selecting "12M" in another mode will cause the image size setting to change to "10M" automatically.
10M	This image size can be selected while the HDR Art recording mode or a BEST SHOT scene (Except for High Speed Best Selection) is selected. Switching to another mode will cause the image size to change to "12M" automatically.

■ Pixels

A digital camera image is a collection of small dots called "pixels". The more pixels there are in an image, the more detail there will be. However, you generally can do with fewer pixels when printing an image (L size) through a print service, attaching an image to e-mail, when viewing the image on a computer, etc.

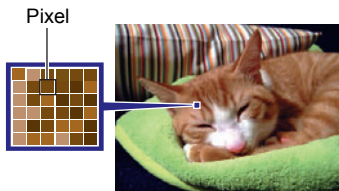

■ About image sizes

The size of an image indicates how many pixels it contains, and is expressed as horizontal pixels×vertical pixels.

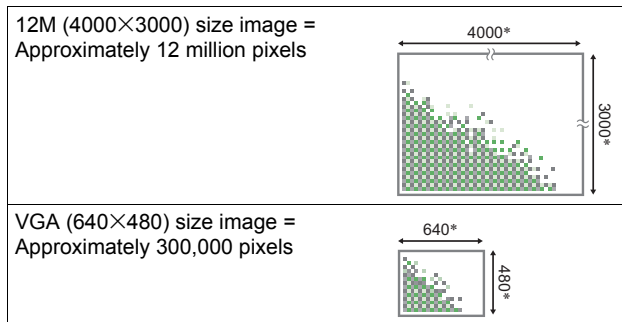



Image Size Selection Tips

Note that larger images have more pixels, so they take up more memory space.

Large Number of Pixels	More detail, but takes up more memory. Best when you plan to print large-size prints (such as Poster size).	
Small Number of Pixels	Less detail, but takes up less memory. Best when you want to send images by e-mail, etc.	

- For information about image size and number of images that can be stored, see page 121.

Movie Image Quality Settings (Movie Quality)

Procedure

Enter the REC Mode → MENU → Movie Quality

This setting can be used to configure movie image quality settings and to select either normal movie recording or High Speed Movie recording. For information about movie image quality settings, see page 44.

Correcting Image Brightness (EV Shift)

Procedure

Enter the REC Mode → MENU → EV Shift

You can manually adjust an image's exposure value (EV value) before shooting it.

- Exposure Compensation Range: -2.0 EV to +2.0 EV
- Unit: 1/3 EV

1. Touch a level you want to set.

- To cancel exposure compensation, change the EV value to 0.0.



Decreases the EV value. A lower EV value is best for dark-color subjects and for shooting outdoors on a clear day.

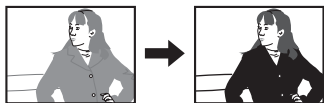

Increases the EV value. A higher EV value is best for light-colored subjects and backlit subjects.

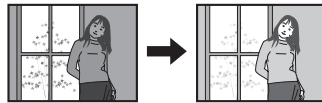

2. Touch "OK".

This applies the exposure compensation value. The exposure compensation value you set remains in effect until you change it or turn off the camera (which causes it to revert to "0.0").

NOTE

- When shooting under very dark or very bright conditions, you may not be able to obtain satisfactory results even after performing exposure compensation.

Adjusting White Balance (White Balance)









Procedure

Enter the REC Mode → MENU → White Balance

You can adjust white balance to match the source of light available where you are shooting and avoid the blue cast that results when shooting outdoors when it is cloudy, and the green cast that results when shooting under fluorescent lighting.

1. Touch the type of white balance you want to select.

You can see the affect of the white balance setting you select on the monitor screen.

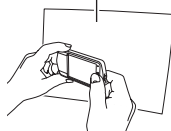
 Auto WB	Configures the camera to adjust white balance automatically
 Daylight	For shooting outdoors on a clear day
 Overcast	For shooting outdoors on an overcast rainy day, in the shade, etc.
 Shade	For shooting on a clear day in the shade of trees or buildings
 Day White Fluor	For shooting under white or day white fluorescent lighting
 Daylight Fluor	For shooting under daylight fluorescent lighting
 Tungsten	For shooting under light bulb lighting
 Manual WB	<p>For configuring the camera manually to suit a particular light source.</p> <ol style="list-style-type: none">① Touch “ Manual WB”.② In the location where you plan to shoot, point the camera at a blank white piece of paper so it fills the entire monitor screen.③ Touch an area of the screen where no icon is located. <p>The white balance setting is retained even if you turn off the camera.</p> 

- When “ Auto WB” is selected for the white balance setting, the camera automatically determines the white point of the subject. Certain subject colors and light source conditions can cause problems when the camera tries to determine the white point, which makes proper white balance adjustment impossible. If this happens, select the white balance setting that matches your shooting conditions (Daylight, Overcast, etc.).

2. Touch “OK”.

Specifying ISO Sensitivity (ISO)

Procedure

Enter the REC Mode → MENU → ISO

ISO sensitivity is a measure of sensitivity to light.

AUTO	Adjusts sensitivity automatically according to conditions		
ISO 100	Lower sensitivity	Slow shutter speed	Less noise
ISO 200	↑	↑	↑
ISO 400			
ISO 800	↓	↓	↓
ISO 1600			
ISO 3200	Higher sensitivity	Fast shutter speed (Set for shooting in dimly lit areas.)	Some coarseness (increased digital noise)

- Higher ISO sensitivity values tend to result in digital noise in images.
- Since higher ISO sensitivity values tend to result in digital noise in images, the camera performs a noise filtering process. Because of this, it may take relatively longer for the camera to finish recording an image after it is shot. You will not be able to perform any operation while image recording is in progress.

Selecting a Focus Mode (Focus)

Procedure

Enter the REC Mode → MENU → Focus

Changing to a different focus mode can help to achieve better focus.

Settings	Type of Shot	Focus Mode		Approximate Focus Range* ¹	
		Snapshot	Movies	Snapshot	Movies
Auto Focus	General recording	Automatic	Fixed focal point	Approximately 8 cm to ∞ (infinity) (3.1" to ∞)	Approximately 46 cm to ∞ (infinity) (18.1" to ∞)
Macro	Close ups	Automatic		Approximately 8 cm to 50 cm (3.1" to 19.7")	Approximately 17 cm to 27 cm (6.7" to 10.6")
Pan Focus	Shooting with a relatively wide focus range	Fixed focal point		Fixed focal point* ²	Approximately 46 cm to ∞ (infinity) (18.1" to ∞)
Infinity	Scenery and other distant subjects	Fixed		Infinity (Wide Angle)	

*1 The focus range is the distance from the lens surface.

*2 The distance depends on shooting conditions.

Using Focus Lock

“Focus lock” is a technique you can use when you want to compose an image in which the subject you want to focus on is not within the focus frame in the center of the screen.

1. Align the monitor screen’s focus frame with the subject you want to focus on and then half-press the shutter button.
2. Keeping the shutter button half-pressed (which maintains the focus setting), move the camera to compose the image.
3. When you are ready to shoot the image, press the shutter button the rest of the way down.

Subject to be focused on

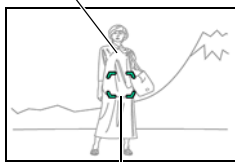

Focus frame



NOTE

- Focus lock also locks exposure (AE).
- The focus frame does not appear on the display when the Touch Shutter is enabled (On).

Turning on Image Review (Review)

Procedure

Enter the REC Mode → MENU → Review

While Review is turned on, the camera will display a image for about one second immediately after you press the shutter button to record it.

- Aperture, shutter speed, and ISO sensitivity values will be amber if Auto Exposure (AE) is incorrect.

Viewing Snapshots and Movies

Viewing Snapshots

See page 32 for the procedure for viewing snapshots.

Viewing a Movie

1. Touch “▶” (PLAY) to enter the PLAY mode.

- If “▶” (PLAY) is not displayed on the screen, touch the tab to display it.

2. Touch “<” or “>”, or drag left or right across the screen image to scroll through the movies until the one you want is displayed.

- To scroll at high speed, touch and hold “<” or “>”.

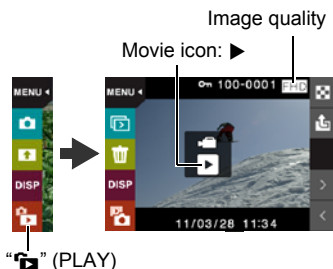

3. Touch “▶” (Movie) to start playback.

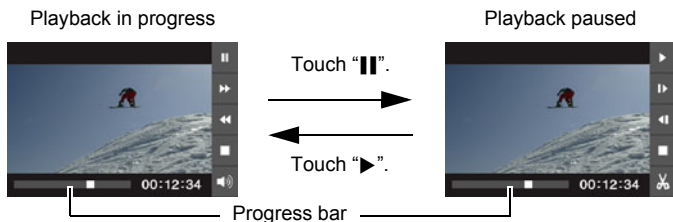

Movie Playback Controls



Pause/Play	Touch “ ” (pause) or “▶” (play).
Fast forward/ Fast reverse	During playback, touch “◀◀” (fast reverse) or “▶▶” (fast forward). <ul style="list-style-type: none">• Each touch of either button increases the speed of the fast forward or fast reverse operation.• To return to normal playback speed, touch “▶”.
Stop playback	During playback, touch “■”.
Volume adjustment	During playback, touch “🔊” and then drag the volume bar to the desired level. <ul style="list-style-type: none">• Volume can be adjusted only while movie playback is in progress.
1 frame forward/ back	While playback is paused, touch “▶ ” or “◀ ”. <ul style="list-style-type: none">• Touching and holding this icon advances frames continuously.
Information display on/off	Touch the screen.
Movie editing	Pause movie play at the location where you want to cut, and then touch “✂” (page 65).

- Playback may not be possible for movies not recorded with this camera.

Editing a Movie on the Camera (Movie Editing)

The Movie Editing feature lets you cut out a specific part of a movie.

1. Enter the **PLAY** mode and then start playback of the movie you want to edit.
2. When playback reaches the location where you want to cut, touch “||” to pause.
3. Touch “✂”.
4. Touch the option that specifies what you want to cut.

 Previous Cut	Cuts everything from the beginning of the movie up to the current location.
 Next Cut	Cuts everything from the current location to the end of the movie.

5. Touch “Cut”.

The selected cut operation will take considerable time to complete. Don't try to perform any camera operation until the “Busy... Please wait...” message disappears from the monitor screen. Note that a cut operation can take a long time if the movie being edited is long.

IMPORTANT!

- When you edit a movie, only the result is saved. The original movie is not retained. An editing operation cannot be undone.

NOTE

- A movie that is shorter than five seconds cannot be edited.
- Editing of movies recorded with a different type of camera is not supported.
- You will not be able to edit a movie if the amount of remaining memory capacity is less than the size of the movie file you want to edit. If there is not enough memory available, delete files you no longer need to free up more.
- Splitting of a movie into two movies and splicing of two different movies into a single movie are not supported.

Viewing a Panorama Image

1. Touch “▶” (PLAY) to enter the PLAY mode.

2. Touch “<” or “>” or drag upwards or downwards to display the panorama image you want to view.

- To scroll at high speed, touch and hold “<” or “>”.



3. Touch “▶” to play the panorama.

Panorama playback causes the image to scroll left, right, up, or down.

Playback Controls

Pause/Play	Touch “ ” (pause) or “▶” (play).
Stop playback	During playback, touch “■”.
Scroll the panorama image	While playback is paused, drag the screen.
Information display on/off	Touch the screen.

- The following functions cannot be performed on a panorama image.
Movie Editing, Rotation

Playing a Slideshow on the Camera (Slideshow)

You can use the slideshow mode to automatically scroll through all of the images in camera memory.

1. In the PLAY mode, touch “” for the playback mode.

This will start the slideshow.

- If “” is not displayed on the screen, touch the tab to display it.

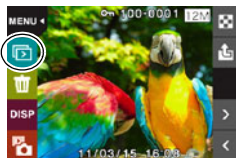

NOTE



- All operations are disabled while the slideshow is transitioning from one image to another.
- The time required for transition from one image to another may be longer in the case of an image that was not recorded with this camera.
- To return to normal (single image) display, touch the screen.

Viewing the Image Menu

The image menu shows multiple images on a single screen.

1. In the PLAY mode, touch “”.

This displays the image menu.

- Touch “” or “” or drag upwards or downwards to scroll to the next page of images.
- To view the normal (single image) display mode, touch the image you want to view or touch “”.
- In the case of a movie, the first image in the movie is displayed.

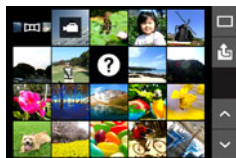

Zooming an On-screen Image

Snapshots can be zoomed on the monitor screen up to 8X.

- The actual available zoom factors depend on the size of the original image.

1. In the PLAY mode, touch “<” or “>” or drag left or right to display the image you want to view.

2. Spread your thumb and forefinger (page 16) on the displayed image to enlarge it.

- Dragging an enlarged screen image will change the part of the image that is displayed.
- Squeezing your thumb and forefinger (page 17) on the displayed image will reduce it in size.
 - When monitor screen contents are turned on, a graphic in the lower right corner of the screen shows what part of the zoomed image is currently displayed.
- Touching “<” or “>” while an enlarged image is displayed will scroll to the next sequential image while maintaining the current zoom factor.
- To return to normal (single image) display, touch “□”.

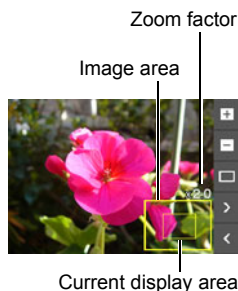

Viewing Snapshots and Movies on a TV Screen

Use a commercially available HDMI cable to connect the camera to the TV.

- Use a commercially available HDMI cable that is marked with the logo shown to the right.



1. Open the frame (page 13).

2. Hook your nail into the groove of the HDMI terminal cover and pull the cover in the direction indicated by the arrow to open it.

HDMI terminal cover

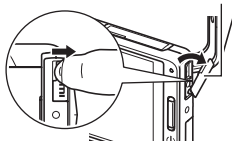

3. Turn off the camera and use a commercially available HDMI cable to connect the camera to a TV.

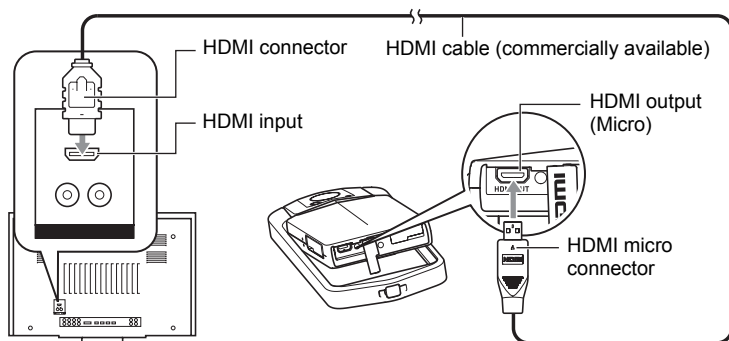

- Make sure that the camera is turned off before plugging in or unplugging the cable. Check the user documentation that comes with the TV for information about requirements before plugging into or unplugging from the TV.

4. Turn on the TV and select its video input mode.

If the TV has more than one video input, select the one where the camera is connected.

5. Turn on the camera.

The camera monitor screen will show a remote controller image. The TV screen will show a recorded image.

- The contents of the remote controller image will depend on the type of image that is displayed on the TV screen.

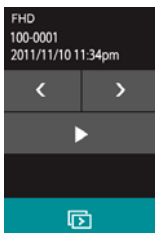

6. Touch the camera monitor screen to perform operations.

NOTE

- Use a HDMI cable with a plug that is compatible with the camera's HDMI micro connector on one end, and a plug that is compatible with your TV's HDMI connector on the other end.
- Proper image and/or audio output and other operations may not be possible with some devices.
- Connecting the camera to the HDMI connector of another device can damage both the camera and the other device. Never connect two HDMI output connectors to each other.
- When cables are connected to both the USB port and the HDMI output connector, the HDMI output connector connection is given priority.
- Disconnect the HDMI cable when you are not using HDMI output. The camera's monitor screen may not operate normally while the HDMI cable is connected.
- Audio is monaural.
- Audio is initially output by the camera at maximum volume. When you first start displaying images, set the TV volume control at a relatively low level and then adjust it as required.
- To select the digital signal format, see page 100.

Other Playback Functions (PLAY)

The following are menu operations you can use to configure various camera settings.

Using the PLAY Menu

■ Example Menu Screen Operation

1. In the PLAY mode, touch “MENU”.

This will display the menu screen.

- If “MENU” is not displayed on the screen, touch the tab to display it.
- Menu contents are different in the REC mode and PLAY mode.

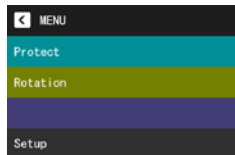

2. Touch the item whose setting you want to change.

3. Configure the setting of the item in accordance with the screen contents.

- To cancel and exit the menu, touch “MENU” or press the shutter button.

■ Menu Operations in This Manual

Menu operations are represented in this manual as shown below. Touch the indicated icons and items, and perform operations as they are indicated, from left to right.

Procedure

Enter the PLAY Mode → MENU → Protect

Protecting a File Against Deletion (Protect)

Procedure

Enter the **PLAY Mode** → **MENU** → **Protect**

You can protect images to prevent them from being deleted.

- A protected image will be indicated by "**On**".

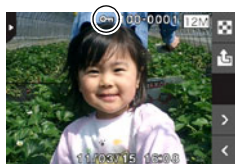

All Files On	Protects all files.
All Files Off	Unprotects all files.
Select	<p>Protects and unprotects specific files.</p> <ol style="list-style-type: none">① Touch "∧" or "∨" or drag upwards or downwards to display the image you want to protect.② Touch an image to be protected, and "On" will appear on the image. You can repeat steps ① and ② as many times as necessary to select multiple images.③ Touch "OK". To unprotect an image, touch it in step ② of the above procedure to remove "On".

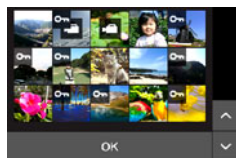

IMPORTANT!

- Note that even if a file is protected, it will be deleted if you perform the format operation (page 101).

Rotating an Image (Rotation)

Procedure

Enter the PLAY Mode → MENU → Rotation

1. Touch “<” or “>” or drag upwards or downwards to display the image you want to rotate.

2. Touch “Rotate”.
This will rotate the image 90 degrees to the left.

3. When the image is in the orientation you want, touch “◀”.

NOTE

- Rotation of a panorama image is not supported.
- Note that this procedure does not actually change the image data. It simply alters how the image is displayed on the camera's monitor screen.
- An image that has been protected or zoomed cannot be rotated.

Printing

Professional Print Service

You can take a memory card that contains the images you want to print to a professional print service and have them printed.



Printing on a Home Printer

You can use a printer equipped with a memory card slot to print images directly from a memory card. For details, see the user documentation that comes with your printer.



Printing with a Computer

After transferring the images to your computer, use commercially available software to print.

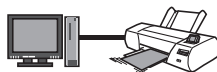

Printing with a Computer

There are a variety of different ways to print images stored on a computer. This section shows one standard printing example.

■ Printing on a Windows Computer

- 1. Use the procedure under “Viewing and Storing Images on a Computer” (page 78) to store the image you want to print, and then display the image on your computer screen.**
- 2. Windows XP users: Click “File” and then “Print”.**
Windows 7, Windows Vista users: Click “Print” and then “Print”.
- 3. Configure the desired print settings and then print.**
Windows XP users: Follow the instructions on the print wizard that appears configure settings and then print.
Windows 7, Windows Vista users: Configure print settings and then click “Print”.

■ Printing on a Macintosh

1. Use the procedure under “Connecting the Camera to Your Computer and Saving Files” (page 88) to store the image you want to print, and then display the image on your Macintosh screen.

2. Click “File” and then “Print”.



3. Configure print settings and then click “Print”.

This will print the selected image.

Using the Camera with a Computer

Things you can do using a computer...

You can perform the operations described below while the camera is connected to a computer.

Save images to a computer and view them there 	<ul style="list-style-type: none">• Save images and view them manually (USB connection) (pages 78, 88).• You can upload specific images to an online service (CASIO Connection powered by Eye-Fi*) (page 82).• Transfer images to a computer automatically over a wireless LAN for viewing (Eye-Fi) (page 92).
Transfer images stored on your computer to camera memory 	In addition to images, you also can transfer screen shot images from your computer to the camera (Photo Transport*) (page 82).
Play back and edit movies 	<ul style="list-style-type: none">• You can play back movies (pages 81, 91).• To edit movies, use commercially available software as required.

* Windows only

The procedures you need to perform when using the camera with your computer and when using the software are different for Windows and the Macintosh.

- Windows users should refer to “Using the Camera with a Windows Computer” on page 77.
- Macintosh users should refer to “Using the Camera with a Macintosh” on page 87.

Using the Camera with a Windows Computer

Install the required software in accordance with the version of Windows you are running and what you want to do.

When you want to do this:	Operating System Version	Install this software:	See page:
Save images to a computer and view them there manually	Windows 7, Windows Vista, Windows XP (SP3)	Installation not required.	78
Play movies	Windows 7, Windows Vista, Windows XP (SP3)	Movies can be played back using QuickTime 7. <ul style="list-style-type: none">• You need to download QuickTime 7 on the Web if you want to use it.	81
Edit movies	Windows 7, Windows Vista, Windows XP (SP3)	– <ul style="list-style-type: none">• Use commercial software as required.	–
Transfer images to the camera	Windows 7, Windows Vista, Windows XP (SP3)	Photo Transport 1.0* <ul style="list-style-type: none">• You need to download it from the website.	82
Upload images to an online service	Windows 7, Windows Vista, Windows XP (SP3)	CASIO Connection powered by Eye-Fi	84

* Photo Transport will not run under 64-bit versions of Windows OS.

■ Computer System Requirements for Software

Information about computer system requirements can be found under “Computer System Requirements for Software (For Windows)” on page 114 of this manual.

■ Precautions for Windows Users

- The software requires Administrator privileges to run.
- Operation on a self-made computer is not supported.
- Operation may not be possible under certain computer environments.

Viewing and Storing Images on a Computer

You can connect the camera to your computer in order to view and store images (snapshot and movie files).

NOTE

- You also can use your computer’s card slot (if it has one) or a commercially available card reader to access image files directly from the camera’s memory card. For details, see the user documentation that comes with your computer.

■ To connect the camera to your computer and save files

1. Press [⏻] (Power) to turn off the camera.
2. Open the frame (page 13), hook your nail into the groove of the USB port cover, and then pull the cover in the direction indicated by the arrow.

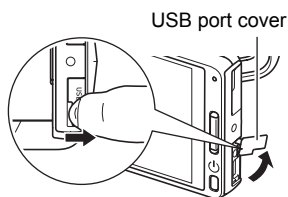

3. Use the USB cable that comes with the camera to connect it to your computer.

The camera will turn on automatically and battery charging will start (page 20).

- The camera may not turn on automatically in the case of certain computer models or connection conditions. If this happens, press [⏻] (Power) to turn on the camera.
- Make sure that you insert the cable connector into the USB port until you feel it click securely into place. Failure to insert the connector fully can result in poor communication or malfunction.
- Note that even while the connector is fully inserted, you still will be able to see the metal part of the connector as shown in the illustration.
- When connecting the USB cable to a USB port, make sure you align the connector correctly with the port.
- Your computer may not be able to recognize the camera if you connect via a USB hub. Always connect directly to the computer's USB port.
- The first time you connect the camera to your computer with the USB cable, an error message may appear on your computer. If this happens, disconnect and then reconnect the USB cable.

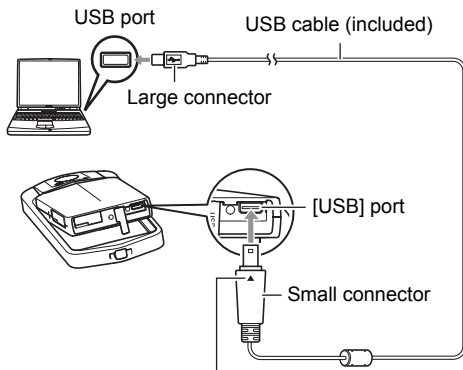

Making sure that the ▲ mark on the USB cable connector is towards the side opposite that of the monitor screen, connect the cable to the camera.

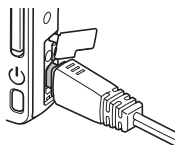

4. Windows 7, Windows Vista users: Click “Start” and then “Computer”. Windows XP users: Click “Start” and then “My Computer”.

5. Double-click “Removable Disk”.

- Your computer recognizes the memory card loaded in the camera (or built-in memory if there is no card) as a removable disk.

6. Right-click the “DCIM” folder.

7. On the shortcut menu that appears, click “Copy”.

8. Windows 7, Windows Vista users: Click “Start” and then “Documents”. Windows XP users: Click “Start” and then “My Documents”.

- If you already have a “DCIM” folder in “Documents” (Windows 7, Windows Vista) or “My Documents” (Windows XP), the next step will overwrite it. If you want to keep the existing “DCIM” folder, you need to change its name or move it to a different location before performing the next step.

9. Windows 7 users: On the “Documents” “Organize” menu, select “Paste”.

Windows Vista users: On the “Documents” “Edit” menu, select “Paste”.

Windows XP users: On the “My Documents” “Edit” menu, select “Paste”.

This will paste the “DCIM” folder (and all the image files it contains) into your “Documents” (Windows 7, Windows Vista) or “My Documents” (Windows XP) folder. You now have a copy of the files that are in camera memory on your computer.

10. After you finish copying images, disconnect the camera from the computer.

■ To view images you copied to your computer

1. Double-click the copied “DCIM” folder to open it.

2. Double-click the folder that contains the images you want to view.

3. Double-click the image file you want to view.

- For information about file names, see “Memory Folder Structure” on page 94.

Never use your computer to modify, delete, move, or rename any image files that are in the camera’s built-in memory or on its memory card.

Doing so can cause problems with the camera’s image management data, which will make it impossible to play back images on the camera and can drastically alter remaining memory capacity. Whenever you want to modify, delete, move, or rename an image, do so only on images that are stored on your computer.

 **IMPORTANT!**

- Never unplug the USB cable, or operate the camera while viewing or storing images. Doing so can cause data to become corrupted.

Playing Movies

To play back a movie, first copy it to your computer and then double-click the movie file. Some operating systems may not be able to play back movies. If this happens, you need to install separately available software.

- If you are unable to play back movies, go to the URL below to download QuickTime 7 and install it on your computer.
<http://www.apple.com/quicktime/>

■ Minimum Computer System Requirements for Movie Playback

The minimum system requirements described below are necessary to play back movies recorded with this camera on a computer.

Operating System : Windows 7, Windows Vista, Windows XP (SP3)

CPU : Image Quality "Full HD", "HD":
Core 2 Duo 3.0GHz or higher
Image Quality "HS240":
Pentium 4 2.0GHz or higher

Required Software: QuickTime 7

- The above are recommended system environments. Configuring one of these environments does not guarantee proper operation.
- Certain settings and other installed software may interfere with proper playback of movies.

■ Movie Playback Precautions

- Be sure to move the movie data to the hard disk of your computer before trying to play it. Proper movie playback may not be possible for data accessed over a network, from a memory card, etc.
- Proper movie playback may not be possible on some computers. If you experience problems, try the following.
 - Quit any other applications you have running, and stop resident applications.

Transferring Images from Your Computer to Camera Memory

If you want to transfer images from your computer to the camera, install Photo Transport on your computer. Photo Transport can be downloaded from the following website:

<http://di.casio.com/>

■ To install Photo Transport

1. Double-click the Photo Transport installation file you downloaded from the website to start up the installer.

2. After reading the information about installation conditions and system requirements for installation in the “Read me” file, install Photo Transport.

■ To transfer images to the camera

1. Connect the camera to your computer (page 78).

2. On your computer, click the following: Start → All Programs → CASIO → Photo Transport.
This starts up Photo Transport.

3. Drag the file(s) you want to transfer to the [Transfer] button.

4. Follow the instructions that appear on the display to complete the transfer.
 - The details of the instructions that appear on the display and the transferred images will depend on your Photo Transport setup. For details, click the [Settings] button or [Help] button and check the setup.

Transfer Data

- Only image files with the following extensions can be transferred to the camera: jpg, jpeg, jpe, bmp (bmp images are converted to jpeg images automatically when transferred.)
- Certain types of images may not be able to be transferred.
- You cannot transfer movies to the camera.

■ To transfer computer screen captures to the camera

1. Connect the camera to your computer (page 78).

2. On your computer, click the following: Start → All Programs → CASIO → Photo Transport.

This starts up Photo Transport.

3. Display the screen whose screen capture you want to transfer.

4. Click the [Capture] button.

5. Draw a boundary around the area you want to capture.

Move your mouse pointer to the upper left corner of the area you want to capture and then hold down the mouse button. Keeping the mouse button depressed, drag the pointer down to the lower right corner of the area and then release the mouse button.

6. Follow the instructions that appear on the display.

This will send an image of the area you selected to the camera.

- The transfer operation converts screen captures to JPEG format.
- The instructions that appear on the display and details about the transferred images will depend on your Photo Transport setup. For details, click the [Settings] button or [Help] button and check the setup.

■ About settings and help

Click the [Settings] button when you want to change the Photo Transport setup. For help about operation procedures and troubleshooting, click the Photo Transport [Help] button.

Uploading Image Data to an Online Service

Installing the CASIO Connection powered by Eye-Fi that comes with the camera on your computer makes it possible to upload image data (photographs and movies) to an online service.



■ To install CASIO Connection powered by Eye-Fi on your computer

1. Start up your computer and connect to the Internet.

- CASIO Connection powered by Eye-Fi cannot be installed on a computer that is not connected to the Internet.

2. Turn off the camera and then remove its memory card (page 112).

3. Connect the USB cable that comes with the camera to the camera and to the USB port of your computer.

- Note that even while the connector is fully inserted, you still will be able to see the metal part of the connector as shown in the illustration.

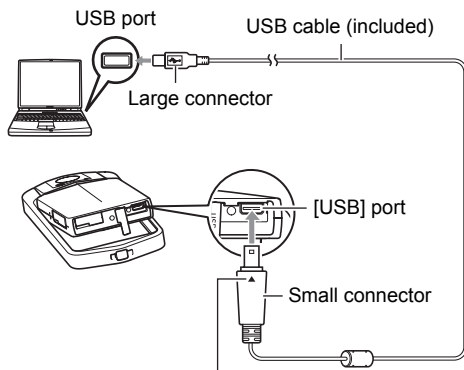
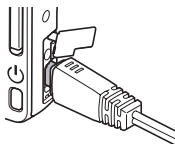

Making sure that the ▲ mark on the USB cable connector is towards the side opposite that of the monitor screen, connect the cable to the camera.

4. Windows 7, Windows Vista users: Click “Start” and then “Computer”. Windows XP users: Click “Start” and then “My Computer”.

5. Open “Removable Disk” and then double-click “setup.exe”. This will start up the CASIO Connection powered by Eye-Fi installer.

6. Follow the instructions that appear on your computer screen to install the software.

7. Follow the instructions that appear on the display to register as a CASIO Connection powered by Eye-Fi user and to log in.

8. Configure online service settings for the image data you want to upload.

Clicking the icon to the right of the EX-TR100 camera icon will enable configuration of settings for uploading image data to Picasa, Facebook, Flickr, or other popular online services.

- For details, see “CASIO Connection powered by Eye-Fi” help.

9. After you finish configuring settings, disconnect the camera from your computer.

IMPORTANT!

- Formatting camera memory will delete the CASIO Connection powered by Eye-Fi installer from the camera. If the installer is deleted, go to the official CASIO Digital Imaging Website at the URL below.
<http://di.casio.com/>
- Make a record of your user registration information and keep it in a safe place so you do not forget it.

■ To upload camera image data to the online service you configured

1. Turn on the camera.

- If the camera is connected to a computer, unplug the USB cable from the camera.

2. In the PLAY mode, touch “”.



3. Touch “” or “” or drag upwards or downwards to display the image you want to upload.

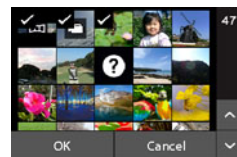

4. Touch the image so its check box is selected.

- If you want to upload another image, repeat steps 3 and 4.

5. After selecting all of the images you want to upload, touch “OK”.

6. Touch “Exit”.

7. Turn off the camera and then use the USB cable that comes with the camera to connect it to your computer.

CASIO Connection powered by Eye-Fi will start up automatically and then upload the image data (photographs and movies) to the online service you have configured.

- The back lamp flashes while image data is being uploaded. After the back lamp stops flashing, disconnect the USB cable from the camera.



IMPORTANT!

- The camera's Auto Power Off function is disabled while image data upload is in progress.
- Uploading of a large number of images can take some time to complete.
- You cannot select specific images for upload while an Eye-Fi card is loaded in the camera. Also, you will not be able to start up CASIO Connection powered by Eye-Fi while the camera is connected to a computer.
- Some services may suddenly shut down without notice.
- Depending on the connection environment, you may not be able to connect to some services.

User Registration

Internet registration only is supported. Visit the following CASIO website to register:
<http://world.casio.com/qv/register/>

Using the Camera with a Macintosh

Install the required software in accordance with what version of the Macintosh OS you are running and what you want to do.

When you want to do this:	Operating System Version	Install this software:	See page:
Save images to your Macintosh and view them there manually	OS 9	Installation not required.	88
	OS X		
Save images to your Macintosh automatically/ Manage images	OS 9	Use commercially available software.	90
	OS X	Use iPhoto, which comes bundled with some Macintosh products.	
Play movies	OS 9	Playback not supported.	91
	OS X	Movie file playback is supported under OS X 10.4.11 or higher when QuickTime 7 or higher is installed.	

Connecting the Camera to Your Computer and Saving Files

IMPORTANT!

- The camera does not support operation with Mac OS 8.6 or earlier, or Mac OS X 10.0. Operation is supported with Mac OS 9, X (10.1, 10.2, 10.3, 10.4, 10.5, 10.6) only. Use the standard USB driver that comes with your supported operating system.

NOTE

- You also can use your computer's card slot (if it has one) or a commercially available card reader to access image files directly from the camera's memory card. For details, see the user documentation that comes with your computer.

To connect the camera to your computer and save files

- 1. Press [⏻] (Power) to turn off the camera.**
- 2. Open the frame (page 13), hook your nail into the groove of the USB port cover, and then pull the cover in the direction indicated by the arrow to open it.**

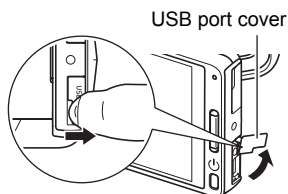

3. Use the USB cable that comes with the camera to connect it to your Macintosh.

The camera will turn on automatically and battery charging will start (page 20).

- The camera may not turn on automatically in the case of certain computer models or connection conditions. If this happens, press [⏻] (Power) to turn on the camera.
- Make sure that you insert the cable connector into the USB port until you feel it click securely into place. Failure to insert the connector fully can result in poor communication or malfunction.
- Note that even while the connector is fully inserted, you still will be able to see the metal part of the connector as shown in the illustration.
- When connecting the USB cable to a USB port, make sure you align the connector correctly with the port.
- Your computer may not be able to recognize the camera if you connect via a USB hub. Always connect directly to the computer's USB port.
- The first time you connect the camera to your computer with the USB cable, an error message may appear on your computer. If this happens, disconnect and then reconnect the USB cable.

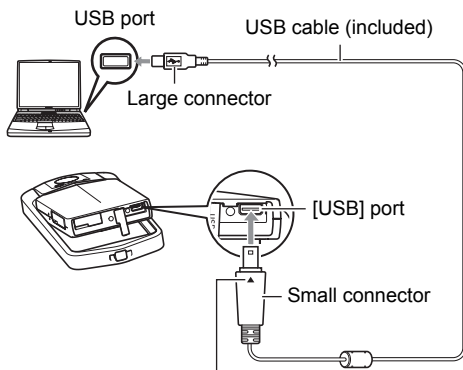

Making sure that the ▲ mark on the USB cable connector is towards the side opposite that of the monitor screen, connect the cable to the camera.

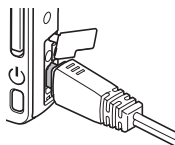

4. Double-click the camera's drive icon.

The camera's back lamp will light green at this time. In this mode, your Macintosh recognizes the memory card loaded in the camera (or the camera's built-in memory if it does not have a memory card loaded) as a drive. The appearance of the drive icon depends on the Mac OS version you are using.

5. Drag the "DCIM" folder to the folder to which you want to copy it.

6. After the copy operation is complete, drag the drive icon to Trash.

7. Disconnect the camera from the computer.

■ To view copied images

1. Double-click the camera's drive icon.

2. Double-click the "DCIM" folder to open it.

3. Double-click the folder that contains the images you want to view.

4. Double-click the image file you want to view.
 - For information about file names, see "Memory Folder Structure" on page 94.
 - An image that was rotated on the camera will be displayed on your Macintosh screen in its original (unrotated) orientation.

Never use your computer to modify, delete, move, or rename any image files that are in the camera's built-in memory or on its memory card.

Doing so can cause problems with the camera's image management data, which will make it impossible to play back images on the camera and can drastically alter remaining memory capacity. Whenever you want to modify, delete, move, or rename an image, do so only on images that are stored on your computer.

IMPORTANT!

- Never unplug the USB cable, or operate the camera while viewing or storing images. Doing so can cause data to become corrupted.

Transferring Images Automatically and Managing Them on Your Macintosh

If you are running Mac OS X, you can manage snapshots using iPhoto, which comes bundled with some Macintosh products. If you are running Mac OS 9, you will need to use commercially available software.

Playing a Movie

You can use QuickTime, which comes bundled with your operating system, to play back movies on a Macintosh. To play back a movie, first copy it to your Macintosh and then double-click the movie file.

■ Minimum Computer System Requirements for Movie Playback

The minimum system requirements described below are necessary to play back movies recorded with this camera on a computer.

Operating System : Image Quality "Full HD": Mac OS X 10.4.11 or higher
Image Quality "HD", "HS240": Mac OS X 10.3.9 or higher

Required Software: QuickTime 7 or higher

- The above are recommended system environments. Configuring one of these environments does not guarantee proper operation.
- Certain settings and other installed software may interfere with proper playback of movies.
- Movie file playback is not supported under OS 9.

■ Movie Playback Precautions

Proper movie playback may not be possible on some Macintosh models. If you experience problems, try the following.

- Upgrade to the latest version of QuickTime.
- Shut down other applications that are running.

IMPORTANT!

- Be sure to move the movie data to the hard disk of your Macintosh before trying to play it. Proper movie playback may not be possible for data accessed over a network, from a memory card, etc.

User Registration

Internet registration only is supported. Visit the following CASIO website to register:
<http://world.casio.com/qv/register/>

Using an Eye-Fi Wireless SD Memory Card to Transfer Images (Eye-Fi)

Shooting with an Eye-Fi wireless SD memory card loaded in the camera makes it possible to transfer image data automatically to a computer via wireless LAN.

- 1. Configure LAN access point, transfer destination and other settings for the Eye-Fi card in accordance with the instructions that come with the Eye-Fi card.**
- 2. After configuring settings, load the Eye-Fi card into the camera and record.**

Images you record are sent by wireless LAN to your computer, etc.

- For full details, see the user documentation that comes with the Eye-Fi card.
- Before formatting a new Eye-Fi card to use it for the first time, copy the Eye-Fi Manager install files to your computer. Do this before formatting the card.

IMPORTANT!

- Recorded images are transferred over wireless LAN. Do not use the Eye-Fi card or turn off Eye-Fi card communication (page 95) when on an aircraft or in any other location where use of wireless communication is limited or prohibited.
- The Eye-Fi icon will be displayed on the monitor screen while all three of the following conditions exist: Eye-Fi card loaded; Eye-Fi setting “On”; Status On (page 102).
- The camera’s Auto Power Off function is disabled while image data transfer is in progress.
- A confirmation message will appear on the monitor screen if you try to turn off the camera while image data transfer is in progress. Follow the instructions in the messages (page 120).
- Transfer of a large number of images can take some time to complete.
- Depending on the type of Eye-Fi card you are using and its settings, images on the Eye-Fi card may be deleted following image data transfer.
- When recording a movie to an Eye-Fi card, it can take too much time to record data, which can result in breaks in the image and/or audio.
- Proper Eye-Fi card data communication may not be possible due to camera settings, battery level, or operating conditions.

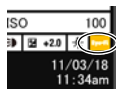

Files and Folders

The camera creates a file each time you shoot a snapshot, record a movie, or perform any other operation that stores data. Files are grouped by storing them in folders. Each file and folder has its own unique name.

- For details about how folders are organized in memory, see “Memory Folder Structure” (page 94).

Name and Maximum Number Allowed	Example
File	
Each folder can contain up to 9999 files named CIMG0001 through CIMG9999. The extension on the file name depends on the file type.	26th file name: CIMG0026.JPG Extension Serial number (4 digits)
Folders	
Folders are named from 100CASIO to 999CASIO. There can be up to 900 folders in memory.	100th folder name: 100CASIO Serial number (3 digits)

- You can view folder and file names on your computer. For details about how file names are displayed on the camera's monitor screen, see page 10.
- The total number of folders and files allowed depends on the image size and quality, and capacity of the memory card being used for storage.

Memory Card Data

The camera stores images you shoot in accordance with the Design Rule for Camera File System (DCF).

■ About DCF

The following operations are supported for DCF-compliant images. Note, however, that CASIO makes no performance guarantees concerning these operations.

- Transferring this camera's DCF-compliant images to another manufacturer's camera and view them.
- Printing this camera's DCF-compliant images on another manufacturer's printer.
- Transferring another camera's DCF-compliant images to this camera and view them.

■ Memory Folder Structure

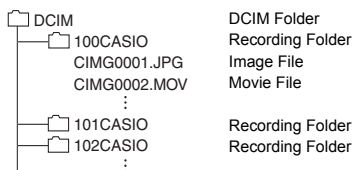

■ Supported Image Files

- Image files shot with this camera
- DCF-compliant image files

This camera may not be able to display an image, even if it is DCF-compliant. When displaying an image recorded on another camera, it may take a long time for the image to appear on this camera's monitor screen.

■ Built-in Memory and Memory Card Data Handling Precautions

- Whenever copying memory contents to your computer, you should copy the DCIM folder and all of its contents. A good way to keep track of multiple DCIM folders is to change their names to dates or something similar after you copy them to your computer. If you later decided to return a DCIM folder to the camera, however, be sure to change its name back to DCIM. The camera is designed to recognize only a root file with the name DCIM. Note the camera also will not be able to recognize the folders inside the DCIM folder unless they have the names they originally had when you copied them from the camera to your computer.
- Folders and files must be stored in accordance with the "Memory Folder Structure" shown on page 94 in order for the camera to be able to recognize them correctly.
- You also can use a PC card adapter or a memory card reader/writer to access camera files directly from the camera's memory card.

Other Settings (Set Up)

This section explains menu items that you can use to configure settings and perform other operations in both the REC mode and PLAY mode.

For information about menu operations, see page 53.

Adjusting Monitor Screen Brightness (Screen)

Procedure

MENU → **Setup** → **Screen**

You can use the following procedure to change the brightness of the monitor screen.

Auto	With this setting, the camera detects available light levels and automatically adjusts the brightness of the monitor screen accordingly.
+2	Brightness that is greater than +1, which makes the screen easier to view. This setting consumes more power.
+1	Bright setting for outdoor use, etc. Brightness that is greater than 0.
0	Normal monitor screen brightness for indoor use, etc.
-1	Screen brightness for viewing in a dark environment without disturbing others around you.

Turning off Eye-Fi Card Communication (Eye-Fi)

Procedure

MENU → **Setup** → **Eye-Fi**

Select "Off" to disable Eye-Fi card communication (page 92).

Configuring Camera Sound Settings (Sounds)

Procedure

MENU → **Setup** → **Sounds**

Startup		Toggles the operation tone between on and off.
Half Shutter		
Shutter		
Operation		
Volume	Operation	Specifies the sound volume. This volume setting is also used during video output (from the HDMI port) (page 69).
	Playback	Specifies the volume of movie audio output. This volume setting is also used during video output (from the HDMI port) (page 69).

- Setting a volume level of 0 mutes output.

Time Stamping Snapshots (Timestamp)

Procedure

MENU → **Setup** → **Timestamp**

You can configure the camera to stamp the recording date only, or date and time in the lower right corner of each snapshot.

- Once date and time information is stamped into a snapshot, it cannot be edited or deleted.

Example: July 10, 2012, 1:25 p.m.

Date	2012/7/10
Date&Time	2012/7/10 1:25pm
Off	No stamping of date and/or time

- Even if you do not stamp the date and/or time with Timestamp, you can do so later using some printing application.
- Stamping is performed in accordance with the date and time settings (page 98) and the display style settings (page 99).

Configuring World Time Settings (World Time)

Procedure

MENU → **Setup** → **World Time**

Setting a Travel Destination

You can use the World Time screen to view the current time in a zone that is different from your Home City when you go on a trip, etc. World Time displays the current time in 162 cities in 32 time zones around the globe.

1. Touch “Destination”.

- To change the geographic area and city for the time where you normally use the camera, select “Home”.

2. Touch “City”.

To specify summer time for the destination city, select “DST” and then select the “On” setting (Summer time is used in some geographical areas to advance the current time setting by one hour during the summer months).

3. Drag upwards and downwards to display the area of the destination city and then touch “OK”.

4. Drag upwards and downwards until you find the city you want, and then touch to select it.

IMPORTANT!

- Before configuring World Time settings, make sure that the Home City setting is the place where you live or normally use the camera. If it isn't, select “Home” on the screen in step 1 and configure the Home City, date, and time settings as required (page 98).

Selecting the Time Display

Use this procedure to specify the time displayed by the camera for your home city and destination.

1. Touch “Time”.

2. Touch “Home” or “Destination”.

This will configure the time setting of the location you touched in the previous step.

Setting the Camera’s Clock (Adjust)

Procedure

MENU → Setup → Adjust

1. Touch the value you want to change (year, month, day, hour, minute).

2. Touch “▲” or “▼” to change the currently selected value.

- You can specify a date from 2001 to 2049.
- Be sure to select your Home City (page 97) before setting the time and date. If you set the time and date while the wrong city is selected for your Home City, the times and dates of all of the World Time cities (page 97) will be wrong.
- To switch between 12-hour and 24-hour format, touch the 12/24 hour switch icon.
- Touching and holding “▲” or “▼” scrolls at high speed.

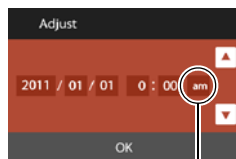

12/24 hour switch icon

3. Touch “OK”.

Specifying the Date Style (Date Style)

Procedure

MENU → **Setup** → **Date Style**

You can select from among three different styles for the date.

Example: July 10, 2012

YY/MM/DD	12/7/10
DD/MM/YY	10/7/12
MM/DD/YY	7/10/12

Specifying the Display Language (Language)

Procedure

MENU → **Setup** → **Language**

■ Specify the display language you want.

1. On the menu screen, touch “Setup”.
2. Touch “Language”.
3. Drag upwards and downwards until you find the language you want, and then touch to select it.

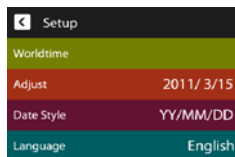

- Camera models sold in certain geographic areas may not support display language selection.

Calibrating the Touch Panel (Calibrate TP)

Procedure

MENU → **Setup** → **Calibrate TP**

Calibrate the touch panel whenever a touch operation does not produce the desired results or if touch panel response is poor.

1. Touch “Start”.

2. Touch the centers of each of the four cross marks “+” as they appear on the screen.

Take your time when performing this operation and wait until the next cross appears.

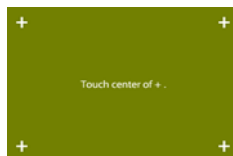

The message “Complete” indicates that touch panel calibration is complete.

- Carefully touch the center of each cross mark (+).
- When calibrating the touch panel, position and hold the camera as you do during normal shooting (page 15).

Selecting the HDMI Terminal Output Method (HDMI)

Procedure

MENU → **Setup** → **HDMI**

Use this setting to select the digital signal format when connecting to a TV with an HDMI cable.

Auto	This setting will cause the format to change automatically in accordance with the connected TV. Normally, you should use this mode.
1080i	1080i format output*
480p	480p format output
576p	576p format output

* 1080i corresponds to 1080 60i, but not 1080 50i. Because of this, the required output method may be 576p when outputting to a digital TV in a PAL reception area that does not support 1080i 60i. If you are in a PAL reception area and nothing is displayed automatically, change the setting to 576p.

- If an image does not appear when “Auto” is selected as the output method, try changing this setting to something else.

Formatting Built-in Memory or a Memory Card (Format)

Procedure

MENU → **Setup** → **Format**

If a memory card is loaded in the camera, this operation will format the memory card. It will format built-in memory if no memory card is loaded.

- The format operation will delete all contents on the memory card or in built-in memory. It cannot be undone. Make sure you do not need any data currently on the card or in built-in memory before you format it.
- Formatting built-in memory or a memory card will delete all protected images stored there.
- Formatting camera built-in memory will delete the CASIO Connection powered by Eye-Fi installer.
- Check the battery level before starting a format operation and make sure it is not too low. Formatting may not be performed correctly and the camera may stop operating normally if the camera powers down while formatting is in progress.

Resetting the Camera to Factory Defaults (Reset)

Procedure

MENU → **Setup** → **Reset**

See page 115 for details about the camera's factory default settings.

The settings below are not reset.

World Time settings, clock settings, date style, screen language, video output

Configuring Monitor Screen Settings

Changing the Screen Orientation

Normally, the camera automatically detects its current orientation and changes the icon and recorded image orientation accordingly. Note, however that the camera may not be able to detect its orientation correctly if it is pointed straight downwards. In this case, you can temporarily change the icon and recorded image orientation. This setting will remain in effect until you change it or until you turn off the camera.

1. Enter the REC mode.



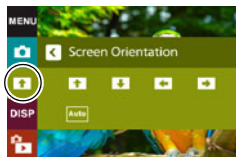

2. Touch “”.

- If “” is not displayed on the screen, touch the tab to display it.



3. Touch the icon of the orientation you want to use.

- This will cause both the icons and the recorded image to change in accordance with your selection.

Auto	Camera detects its current orientation and automatically changes the icon and screen orientation accordingly.
	Icon tops facing up.
	Icon tops facing left.
	Icon tops facing down.
	Icon tops facing right.

Selecting Display Information (DISP)

Each touch of “DISP” will cycle through settings that display or hide on-screen information. You can configure separate settings for the REC mode and PLAY mode.

- If “DISP” is not displayed on the screen, touch the tab to display it.
- Display information cannot be changed during movie recording.

Off	No information displayed.
Information On	Shows information about image settings, etc.
Status On	Shows more detailed information about settings. <ul style="list-style-type: none">• When Status On is selected, you will not be able to view the subject on the monitor screen.

Precautions during Use

■ Avoid Use While In Motion

- Never use the camera to record or play back images while operating an automobile or other vehicle, or while walking. Looking at the monitor while in motion creates the risk of serious accident.

■ Directly Viewing the Sun or Bright Light

- Never look at the sun or any other bright light through the camera's viewfinder. Doing so can damage your eyesight.

■ Monitor Screen

- Should the monitor screen ever become cracked, never touch any of the liquid inside the monitor screen. Doing so creates the risk of skin inflammation.
- Should monitor screen liquid ever get into your mouth, immediately rinse your mouth out and contact your physician.
- Should monitor screen liquid ever get into your eyes or onto your skin, immediately rinse with clean water for at least 15 minutes and contact your physician.

■ Connections

- Never plug any devices that are not specified for use with this camera into connectors. Connecting a non-specified device creates the risk of fire and electric shock.

■ Transport

- Never operate the camera inside of an aircraft or anywhere else where operation of such devices is restricted. Improper use creates the risk of serious accident.

■ Smoke, abnormal odor, overheating, and other abnormalities

- Continued use of the camera while it is emitting smoke or strange odor, or while it is overheating creates the risk of fire and electric shock. Immediately perform the following steps whenever any of the above symptoms are present.
 1. Turn off the camera.
 - * If the camera will not turn off for some reason, press the reset button (page 8).
 2. If you are using the USB-AC adaptor to power the camera, unplug it from the wall outlet.
 3. Contact your dealer or nearest CASIO authorized service center.

■ Water and Foreign Matter

- Water, other liquids, or foreign matter (especially metal) getting inside the camera creates the risk of fire and electric shock. Immediately perform the following steps whenever any of the above symptoms are present. Particular care is required when using the camera where it is raining or snowing, near the ocean or other body of water, or in a bathroom.
 1. Turn off the camera.
 2. If you are using the USB-AC adaptor to power the camera, unplug it from the wall outlet.
 3. Contact your dealer or nearest CASIO authorized service center.

■ Dropping and Rough Treatment

- Continued use of the camera after it is damaged by dropping or other rough treatment creates the risk of fire and electric shock. Immediately perform the following steps whenever any of the above symptoms are present.
 1. Turn off the camera.
 2. If you are using the USB-AC adaptor to power the camera, unplug it from the wall outlet.
 3. Contact your dealer or nearest CASIO authorized service center.

■ Keep Away From Fire

- Never expose the camera to fire, which can cause it to explode and creates the risk of fire and electric shock.

■ Disassembly and Modification

- Never try to take the camera apart or modify it in any way. Doing so creates the risk of electric shock, burn injury, and other personal injury. Be sure to leave all internal inspection, maintenance, and repair up to your dealer or nearest CASIO authorized service center.

■ Locations To Be Avoided

- Never leave the camera in any of the following types of locations. Doing so creates the risk of fire and electric shock.
 - Areas subject to large amounts of humidity or dust
 - Food preparation areas or other locations where oil smoke is present
 - Near heaters, on a heated carpet, in areas exposed to direct sunlight, in a closed vehicle parked in the sun, or other areas subject to very high temperatures
- Never place the camera on an unstable surface, on a high shelf, etc. Doing so can cause the camera to fall, creating the risk of personal injury.

■ Backing Up Important Data

- Always keep backup copies of important data in camera memory by transferring it to a computer or other storage device. Note that data can be deleted in the case of camera malfunction, repair, etc.

■ Rechargeable Battery

- Never attempt to take this camera apart except to remove the built-in battery when disposing of the camera.
- To charge the battery, use only the means and method specifically described in this manual. Attempting to charge the battery by an unauthorized means creates the risk of battery overheating, fire, and explosion.
- Note the following precautions when removing the built-in battery when disposing of the camera.
 - Never use or leave the battery near open flame.
 - Do not expose the battery to heat or fire.
 - Never carry or store the battery together with items that can conduct electricity (necklaces, pencil lead, etc.).
 - Never disassemble the battery, pierce it with a needle, or expose it to strong impact (hit it with a hammer, step on it, etc.), and never apply solder to it. Never place the battery into a microwave oven, heater, high-pressure generating device, etc.
- Keep the battery out of the reach of small children. Accidentally swallowing the battery is harmful to the health. Should you suspect that a child has swallowed the battery, contact a physician immediately.
- If battery charging does not end normally within the specified charging time, stop charging anyway and contact your local CASIO authorized service center. Continued charging creates the risk of battery overheating, fire, and explosion.
- Battery fluid can damage your eyes. Should battery fluid get into your eyes accidentally, immediately rinse them with clean tap water and then consult a physician.
- Should fluid from a battery accidentally get onto clothing or your skin, immediately rinse it off with clean tap water. Prolonged contact with battery fluid can cause skin irritation.

■ Battery Life

- Battery continuous operation times provided in this manual represent the approximate amount of time before the camera turns off due to low battery power when being powered by the battery under normal temperature (23°C (73°F)). They do not guarantee that you will be able to achieve the indicated level of operation. Actual battery life is greatly affected by ambient temperature, camera storage conditions, the amount of time spent in storage, etc.
- Leaving the camera on can run down the battery and cause the low battery warning to appear. Turn off the camera whenever you are not using it.
- The low battery warning indicates that the camera is about to turn off due to low battery power. Charge the battery as soon as possible. Leaving the camera with a low or dead battery can lead to battery leakage and data corruption.

■ Data Error Precautions

Your digital camera is manufactured using precision digital components. Any of the following creates the risk of corruption of data in camera memory.

- Removing the memory card while the camera is performing some operation
- Removing the memory card while the back lamp is flashing green after turning off the camera
- Disconnecting the USB cable while communication is in progress
- Other abnormal operations

Any of the above conditions can cause an error message to appear on the monitor screen (page 120). Perform the action indicated by the message that appears.

■ Operating Environment

- Operating Temperature Requirements: 0 to 40°C (32 to 104°F)
- Operating Humidity: 10 to 85% (non condensation)
- Do not place the camera in any of the following locations.
 - In an area exposed to direct sunlight, or large amounts of moisture, dust, or sand
 - Near an air conditioner or in other areas subjected to extreme temperature or humidity
 - Inside of a motor vehicle on a hot day, or in an area subjected to strong vibration

■ Condensation

Sudden and extreme temperature changes, such as when the camera is moved from the outdoors on a cold winter day into a warm room, can cause water droplets called “condensation” to form on the interior and the exterior of the camera, which creates the risk of malfunction. To prevent condensation from forming seal the camera in a plastic bag before changing locations. Then leave the bag sealed to allow the air inside to naturally change to the same temperature as the air in the new location. After that, remove the camera from the bag for a few hours.

■ Lens

- Never apply too much force when cleaning the surface of the lens. Doing so can scratch the lens surface and cause malfunction.
- You may sometimes notice some distortion in certain types of images, such as a slight bend in lines that should be straight. This is due to the characteristics of lenses, and does not indicate malfunction of the camera.

■ Caring for your camera

- Never touch the lens with your fingers. Finger smudges, dirt, and other foreign matter on the lens can interfere with proper operation of the camera. Use a blower or other means to keep the lens free of dirt and dust, and wipe gently with a soft, dry cloth.
- To clean the camera, wipe it with a soft, dry cloth.

■ USB-AC adaptor Handling Precautions



- Never plug the power cord into an outlet whose voltage rating is different from that marked on the power cord. Doing so creates the risk of fire, malfunction, and electric shock.
 - Take care to protect the power cord against damage and breaking. Never place heavy objects onto the power cord, or expose it to intense heat. Doing so can damage the power cord, creating the risk of fire and electric shock.
 - Never try to modify the power cord, or subject it to severe bending, twisting, or pulling. Doing so creates the risk of fire, malfunction, and electric shock.
 - Never plug in or unplug the power cord while your hands are wet. Doing so creates the risk of electric shock.
 - Do not plug the power cord into an outlet or extension cord that is shared by other devices. Doing so creates the risk of fire, malfunction, and electric shock.
 - Should the power cord ever become damaged (to the point that internal wires are exposed or cut), immediately contact your original retailer or a CASIO authorized service center to request repair. Continued use of a damaged power cord creates the risk of fire, malfunction, and electric shock.
- The USB-AC adaptor becomes slightly warm during charging. This is normal and does not indicate malfunction.
 - Unplug the power cord from the power outlet when you are not using the USB-AC adaptor.
 - Never use detergent to clean the power cord (especially the plug).
 - Never cover the USB-AC adaptor with a blanket, etc. Doing so creates the risk of fire.

■ Other Precautions

The camera becomes slightly warm during use. This is normal and does not indicate malfunction.

■ Copyrights

Except for your own personal enjoyment, unauthorized use of snapshots or movies of images whose rights belong to others, without the permission of the right holder, is forbidden by copyright laws. In some cases, shooting of public performances, shows, exhibitions, etc. may be restricted entirely, even if it is for your own personal enjoyment. Regardless of whether such files are purchased by you or obtained for free, posting them on a website, a file sharing site, or any other Internet site, or otherwise distributing them to third parties without the permission of the copyright holder is strictly prohibited by copyright laws and international treaties. For example, uploading or distributing on the Internet images of TV programs, live concerts, music videos, etc. that were photographed or recorded by you may infringe upon the rights of others. Note that CASIO COMPUTER CO., LTD. shall not be held liable for use of this product in any way that infringes on the copyrights of others or that violates copyright laws.

The following terms, which are used in this manual, are registered trademarks or trademarks of their respective owners.

Note that trademark [™] and registered trademark [®] are not used within the text of this manual.

- SDXC Logo is a trademark of SD-3C, LLC.
- Microsoft, Windows, Internet Explorer, Windows Vista, Windows 7, and DirectX are registered trademarks or trademarks of Microsoft Corporation in the United States and other countries.
- Macintosh, Mac OS, QuickTime, and iPhoto are trademarks of Apple Inc.
- HDMI, the HDMI logo, and High-Definition Multimedia Interface are trademarks or registered trademarks of HDMI Licensing, LLC.
- Eye-Fi, the Eye-Fi logo and Eye-Fi *connected* are trademarks of Eye-Fi, Inc.
- TRYX, Photo Transport and CASIO Connection powered by Eye-Fi are registered trademarks or trademarks of CASIO COMPUTER CO., LTD.
- All other company or product names mentioned herein are registered trademarks or trademarks of their respective companies.

Any and all unauthorized commercial copying, distribution, and copying of the bundled software over a network are prohibited.

Charging

■ If the camera's back lamp starts flashing red...

If the back lamp starts flashing red during charging, it means that further charging is not possible for one of the reasons below. Perform the actions described below to correct the problem and then try charging again.

Ambient temperature or the temperature of the battery is abnormally high or low

Unplug the USB cable from the camera and wait for a while until the camera is within the temperature range of 5°C to 35°C (41°F to 95°F), and then try charging again.

Safety timer activated

A battery that has not been used for a long time, certain types of computers, and connection conditions can cause charging to take longer than normal. If charging takes longer than about six hours, a safety timer will terminate it automatically, even if the battery is not fully charged. If the battery has not been used for a very long time, charging may terminate automatically after only about 45 minutes.

- 1) Using a battery that has not been used for a long time.
Disconnect and then reconnect the USB cable to resume charging.
- 2) Insufficient power supply when connected to computer
Connect directly to a USB port what supplies a current of 500mA.

For details about the power supply capacity of a computer's USB port, contact the manufacturer of the computer. Though disconnecting and then reconnecting the USB cable will resume charging, you may need to do so repeatedly if the power supply capacity of the computer is low.

If problems continue to occur after you perform the above steps, it could mean that the battery is faulty. Contact your nearest CASIO authorized service center.

Battery Precautions

■ Precautions during Use

- Operation provided by a battery under cold conditions is always less than operation under normal temperatures. This is due to the characteristics of the battery, not the camera.
- Charge the battery in an area where the temperature is within the range of 5°C to 35°C (41°F to 95°F). Outside this temperature range charging can take longer than normal or even fail.

■ Storage Precautions

- Storing the camera for a long time while it is charged can cause deterioration of battery characteristics. If you do not plan to use a camera for some time, fully use up its charge before storing it.
- To prevent over discharging of an unused battery, fully charge it about once every six months.

Battery Replacement

- If the battery provides only very limited operation following a full charge, it probably means it has reached the end of its service life. Have the battery replaced with a new one. Contact your retailer or a CASIO authorized service center to have the battery replaced. Do not try to replace the battery yourself.

Using the Camera in another Country

■ Precautions during Use

- The bundled USB-AC adaptor is designed for operation with any power supply in the range of 100V to 240V AC, 50/60Hz. Note, however, that the shape of the power cord plug depends on each country or geographic area. Before taking the camera and USB-AC adaptor along on a trip, check with travel agent about the power supply requirements in your destination(s).
- Do not connect the USB-AC adaptor to a power supply through a voltage converter or similar device. Doing so can lead to malfunction.

Disposing of the Camera

When disposing of the camera, be sure to first remove its built-in lithium ion battery and send it in for recycling.



IMPORTANT!

- The battery of this camera is built-in and cannot be replaced by you. Contact your retailer or a CASIO authorized service center to have the battery replaced.
- Make sure that the camera is turned off before removing the battery.
- The edges of the back cover are sharp. Take care not to cut your fingers when removing it.

1. Turn off the camera.

2. Open the camera's frame until it and the monitor screen panel form a 90 degree angle.

3. Use a precision Phillips tip screwdriver to remove the four screws that secure the monitor screen panel back cover in place.

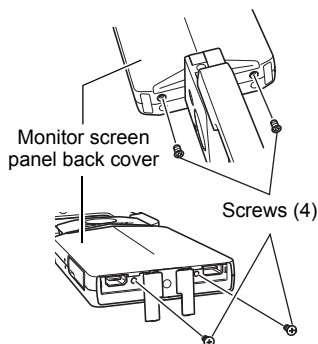

4. Open the memory card slot cover.

5. Use a flat-blade precision screwdriver to release the hooks and then lift the monitor screen panel back cover in the direction indicated by the arrow.

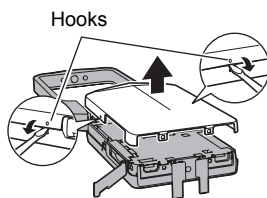

6. Peel the black tape from the battery.

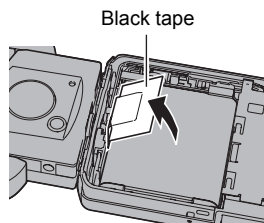

- 7. Pressing the edge of the battery in the direction indicated by the arrow, lift the battery to remove it.**

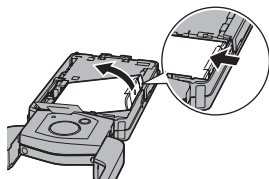

■ Old Rechargeable Battery Handling Precautions

- Insulate the positive and negative terminals with tape, etc.
- Do not peel the covering off of the battery.
- Do not try to take the battery apart.

Using a Memory Card

See page 25 for information about supported memory cards and how to load a memory card.

To replace the memory card

Press the memory card and then release it. This will cause it to pop out of the memory card slot slightly. Pull the card out the rest of the way and then insert another one.

- Never remove a card from the camera while the back lamp is flashing green. Doing so can cause the image save operation to fail and even damage the memory card.

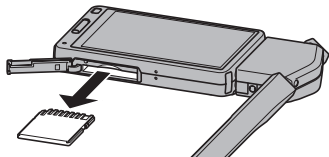

■ Using a Memory Card

- SD memory cards, SDHC memory cards, and SDXC memory cards have a write protect switch. Use the switch when you need to guard against accidentally deleting data. Note, however, if you write protect an SD memory card you must then turn write protection off whenever you want to record to it, format it, or delete any of its images.
- If a memory card starts to behave abnormally during image playback, you can restore normal operation by reformatting it (page 101). However, it is recommended that you always take along multiple memory cards whenever using the camera far away from the home or office.
- As you record data to and delete data from a memory card a number of times, it loses its ability to retain data. Because of this, periodic re-formatting of a memory card is recommended.
- Electrostatic charge, electrical noise, and other phenomena can cause data to become corrupted or even lost. Make sure that you always back up important data on other media (CD-R, CD-RW, hard disk, etc.).

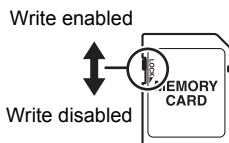

■ Memory Card Handling Precautions

Certain types of memory cards can slow down processing speeds. In particular, you may experience problems saving high-quality (Full HD and HD) movies. When using the camera's built-in memory or certain types of memory cards, it can take too much time to record data, which can result in breaks in the image and/or audio. This condition is indicated by the movie icon turning yellow on the monitor screen. Use of a memory card with a maximum transfer speed of at least 10MB per second is recommended.

■ Discarding or Transferring Ownership of a Memory Card or the Camera

- The format and delete functions of the camera do not actually delete files from the memory card. The original data remains on the card. Note that responsibility for the data on a memory card lies with you. The following procedures are recommended whenever you discard a memory card or the camera, or if you transfer ownership to another party.
 - When discarding a memory card, either physically destroy the memory card or use commercially available data delete software to completely delete the data on the memory card.
 - When transferring ownership of a memory card to another party, use commercially available data deletion software to completely delete the data on it. Use the format function (page 101) to completely delete the data in built-in memory before discarding or transferring ownership of the camera.
- Before giving or selling a camera that is using CASIO Connection powered by Eye-Fi to someone else, be sure unregister your Eye-Fi account. Start up CASIO Connection powered by Eye-Fi, right-click the camera icon, and then select "Unregister".

Computer System Requirements for Software (For Windows)

Computer system requirements are different for each of the applications. Be sure to check the requirements for the particular application you are trying to use. Note that the values provided here are minimum requirements for running each application. Actual requirements are greater, depending on the number of images and the sizes of the images being handled.

Photo Transport 1.0

Operating System : Windows 7, Windows Vista, Windows XP (SP3)

Memory : At least 64MB

Hard Disk Drive Space : At least 2MB

CASIO Connection powered by Eye-Fi

Operating System : Windows 7, Windows Vista, Windows XP (SP3)

* CASIO Connection powered by Eye-Fi comes built into the camera.

Reset Initial Default Settings

The tables in this section show the initial default settings on menus that appear in the REC mode and PLAY mode when you reset the camera (page 101).

- A dash (–) indicates an item whose setting is not reset or an item for which there is no reset setting.



IMPORTANT!

- Switching from “Auto” to “Premium Auto” (page 29) will make some menu items unavailable.

■ REC Menu

Touch Shutter	Off
Self-timer	Off
LED	Off
Image Size	12M
Movie Quality	Full HD
EV Shift	0.0

White Balance	Auto
ISO	Auto
Focus	AF
Review	Off
Setup	→ See below.

■ PLAY Menu

Protect	–
Rotation	–
Setup	→ See below.



■ Setup Menu

Screen	Auto
Eye-Fi	On
Sounds	Startup: On / Half Shutter: On / Shutter: On / Operation: On / Operation: 3 / Playback: 7
Timestamp	Off
World Time	–

Adjust	–
Date Style	–
Language	–
Calibrate TP	–
HDMI	Auto
Format	–
Reset	–
Version	–

Troubleshooting

Problem	Possible Cause and Recommended Action
Power Supply	
Power does not turn on.	<ol style="list-style-type: none"> 1)The battery of new camera is not charged. Charge the battery before using the camera. 2)The camera battery may be dead. Charge the battery (page 18). If this does not resolve the problem, contact your retailer or a CASIO authorized service center.
The camera suddenly powers down.	<ol style="list-style-type: none"> 1)The camera is designed to turn off automatically after no operation is performed for about five minutes. Turn power back on. 2)The battery may be dead. Charge the battery (page 18). 3)The camera's protection function may have activated because camera temperature is too high. Turn off the camera and wait until it cools down before trying to use it again.
Power will not turn off. Nothing happens when a button is pressed.	Use a thin object to press the reset button (page 8) near the memory card slot to turn the camera off and then turn on the camera again. Unlike the reset operation (page 101), pressing the reset button near the memory card slot does not initialize camera settings.
Image Recording	
Image is not recorded when the shutter button is pressed.	<ol style="list-style-type: none"> 1)If the camera is in the PLAY mode, touch "⏏" (REC) to enter the REC mode. 2)If the message "Memory Full" appears, transfer images to your computer, delete images you no longer need, or use a different memory card.
Auto Focus does not focus properly.	<ol style="list-style-type: none"> 1)If the lens is dirty, clean it off. 2)The subject may not be in the center of the focus frame when you compose the image. 3)You may be moving the camera when shooting. Try shooting with the "High Speed Anti Shake" BEST SHOT scene, place the camera on a tabletop or some other stable surface, or find some way to fix the camera in place. 4)You may be pressing the shutter button all the way without waiting for Auto Focus. Half-press the shutter button and allow enough time for Auto Focus to focus.
The subject is out of focus in the recorded image.	The image may not be focused properly. When composing the image, make sure the subject is located inside the focus frame.

Problem	Possible Cause and Recommended Action
The LED light does not light.	1) If the battery is dead, charge it (page 18). 2) LED light operation is disabled automatically whenever you are shooting with a BEST SHOT scene, HDR Art and Slide Panorama. Select a different recording mode (page 36).
Camera powers down during Self-timer countdown.	The battery may be dead. Charge the battery (page 18).
The monitor screen image is out of focus.	1) You may be using “Macro” for scenery or portraits. Use Auto Focus for scenery and portrait shots (page 61). 2) You may be trying to use Auto Focus or “Infinity” when shooting a close-up shot. Use the “Macro” for close ups (page 61).
There is digital noise in images.	1) Sensitivity may have been increased automatically for a dark subject, which increases the chance of digital noise. Use a light or some other means to illuminate the subject. 2) Shooting with a snapshot with a high ISO sensitivity setting can increase digital noise in the image. If digital noise becomes a problem, try changing the ISO sensitivity setting to a lower value.
A recorded image was not saved.	1) Camera power may have been turned off before the save operation was complete, which will result in the image not being saved. If the battery indicator shows  , charge the battery as soon as possible (page 18). 2) You may have removed the memory card from the camera before the save operation was complete, which will result in the image not being saved. Do not remove the memory card before the save operation is complete.
Though available lighting is bright, the faces of people in the image are dark.	Not enough light is reaching the subjects. Adjust EV shift to the + side (page 58).
Night shots come out bad.	Use the “High Speed Night Scene” BEST SHOT scene (page 47) when shooting at night.
Subjects are too dark when shooting images in a seashore or ski area.	Sunlight reflected by water, sand, or snow, can cause underexposure of images. Adjust EV shift to the + side (page 58).
The image is out of focus during movie recording.	1) Focusing may not be possible because the subject is outside the focus range. Shoot within the allowable range. 2) The lens may be dirty. Clean the lens (page 107). 3) During High Speed Movie recording, focus is fixed at the position where it was when recording started. To focus an image, half-press the shutter button for Auto Focus before you touch “  ” (Movie) to start recording.

Problem	Possible Cause and Recommended Action
Playback	
The color of the playback image is different from what appears on the monitor screen when shooting.	Sunlight or light from another source may be shining directly into the lens when you are shooting. Position the camera so sunlight does not shine directly into the lens.
Images are not displayed.	This camera cannot display non-DCF images recorded onto a memory card using another digital camera.
Images cannot be rotated.	Note that you cannot edit the following types of snapshots. <ul style="list-style-type: none"> • Panorama images • Snapshots recorded with another camera
File Deletion	
A file cannot be deleted.	The file may be protected. Unprotect the file (page 72).
Other	
The wrong date and time are displayed, or the wrong date and time are being stored along with image data.	The date and time setting is off. Set the correct date and time (page 98).
The messages on the display are in the wrong language.	The wrong display language is selected. Change the display language setting (page 99).
Images cannot be transferred over a USB connection.	<ol style="list-style-type: none"> 1)The USB cable may not be connected securely. Check all connections. 2)If the camera is not turned on, turn it on. 3)Your computer may not be able to recognize the camera if you connect via a USB hub. Always connect directly to the computer's USB port.

Problem	Possible Cause and Recommended Action
<p>Language selection screen appears when the camera is turned on.</p>	<p>1) You did not configure initial settings after purchasing the camera or the camera may have been left with a dead battery. Check the camera setup (pages 24, 98).</p> <p>2) There may be a problem with the camera's memory data. If this is the case, perform the reset operation to initialize the camera's setup (page 101). After that, configure each setting. If the language selection screen does not re-appear when you turn the camera on, it means that the camera's memory management data has been restored.</p> <p>If the same message appears after you turn power back on, contact your retailer or a CASIO authorized service center.</p>
<p>Buttons are not responsive right after the power has been turned on.</p>	<p>With large capacity memory cards there is a delay after the power has been turned on before the buttons become responsive.</p>

Display Messages

ALERT	The camera's protection function may have activated because camera temperature is too high. Turn off the camera and wait until it cools down before trying to use it again.
Battery is low.	Battery power is low.
Card ERROR	<p>There is something wrong with the memory card. Turn off the camera, remove the memory card and then reload it into the camera. If this message re-appears when you turn the camera back on, format the memory card (page 101).</p> <p> IMPORTANT!</p> <ul style="list-style-type: none">• Formatting a memory card deletes all its files. Before formatting, try transferring recoverable files to a computer or some other storage device.
Files could not be saved because battery is low.	Battery power is low, so an image file could not be saved.
Folder cannot be created.	You are trying to record a file while there are already 9999 files stored in the 999th folder. If you want to record more, delete files you no longer need (page 33).
Images are being transferred. Stop transfer and turn off power?	You are attempting to turn off the camera while image data is being transferred with an Eye-Fi card (page 92).
LENS ERROR	This message appears and the camera turns off whenever lens performs some unexpected operation. If the same message appears after you turn power back on, contact a CASIO authorized service center or your original retailer.
Memory Full	Memory is full with images you recorded and/or files saved by editing operations. Delete files you no longer need (page 33).
Record Error	Image compression could not be performed for some reason during image data storage. Shoot the image again.
SYSTEM ERROR	Your camera system is corrupted. Contact your retailer or a CASIO authorized service center.

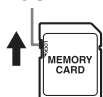
The card is locked.	The LOCK switch of the SD, SDHC, or SDXC memory card loaded in the camera is in the locked position. You cannot store images to or delete images from a memory card that is locked.	<p>LOCK</p> 
There are no files.	There are no files in built-in memory or on the memory card.	
This card is not formatted.	The memory card loaded in the camera is not formatted. Format the memory card (page 101).	
This file cannot be played.	The file you are trying to access is corrupted or is a type that cannot be displayed by this camera.	
This function cannot be used.	This message will appear part way through an operation when you attempt to use a function that is not allowed in combination with another function.	

Number of Snapshots/Movie Recording Time

Snapshot

Image Size (Pixels)	Approximate Image File Size	Built-in Memory (Approx. 34.8MB ^{*1}) Snapshot Recording Capacity	SD Memory Card (1GB ^{*2}) Snapshot Recording Capacity
12M (4000×3000)	4.13 MB	5	142
3:2 (4000×2656)	3.62 MB	6	169
10M (3648×2736)	3.38 MB	6	169
5M (2560×1920)	1.72 MB	9	266
VGA (640×480)	290 KB	61	1667

Movies

Image Quality (Pixels) / (Audio)	Maximum File Size	Approximate Data Rate (Frame Rate)	Built-in Memory (Approx. 34.8MB ^{*1}) Movie Recording Capacity	SD Memory Card (1GB ^{*2}) Movie Recording Capacity	File Size of 1-minute Movie
Full HD (1920×1080) (Monaural)	Maximum Movie Size: 4 GB	14.2 Megabits/second (30 frames/second)	18 seconds	8 minutes 23 seconds	106.5 MB
HD (1280×720) (Monaural)		10.9 Megabits/second (30 frames/second)	24 seconds	10 minutes 58 seconds	81.8 MB
HS240 (432×320) (No audio)		40.0 Megabits/second (240 frames/second)	6 seconds	2 minutes 59 seconds	300.0 MB

*1 Built-in memory capacity after formatting

*2 The above values are based on use of a PRO HIGH SPEED SD memory card (Panasonic Corporation). The number of images you can save depends on the type of memory card you are using.

- Snapshot and movie recording capacity values are approximate and intended for reference only. Actual capacity depends on image contents.
- File size and data rate values are approximate and intended for reference only. Actual values depend on the type of image being shot.
- When using a memory card with a different capacity, calculate the number of images as a percentage of 1GB.
- The time it takes to play back a high speed movie will be different from the time it takes to record it. If you record a high speed movie for 10 seconds, for example, it will take 80 seconds to play it back.

Specifications

File Format	Snapshots: JPEG (Exif Version 2.3; DCF 2.0 standard) Movies: MOV format, H.264/AVC standard, IMA-ADPCM (monaural)
Recording Media	Built-in Memory (Image Storage Area: 34.8MB*) SD/SDHC/SDXC * Built-in memory capacity after formatting
Recorded Image Sizes	Snapshots: 12M (4000×3000), 3:2 (4000×2656), 10M (3648×2736), 5M (2560×1920), VGA (640×480) Movies: Full HD (1920×1080 30 fps), HD (1280×720 30 fps), HS240 (432×320 240 fps)
Image Deletion	1 file; all files (with memory protection feature)
Effective Pixels	12.1 Megapixels
Imaging Element	Size: 1/2.3-inch square pixel high-speed CMOS Total Pixels: 12.75 Megapixels
Lens/Focal Distance (Snapshot)	F2.8 f = 3.8 mm (equivalent to 21 mm in 35 mm format) 5 lenses in 5 groups, including aspherical lens.
Zoom	Up to 4.0X when SR zoom and Digital zoom are used in combination Up to 15.9X when SR Zoom, HD Zoom and Digital zoom are used in combination (VGA size)
Focusing	Contrast Detection Auto Focus • Focus Modes: Auto Focus, Macro Focus, Pan Focus, Infinity • AF Area: Spot * Intelligent AF area used when Premium Auto is selected.
Approximate Focus Range (Snapshot) (From Lens Surface)	Auto Focus: 8 cm to ∞ (3.1" to ∞) Macro Focus: 8 cm to 50 cm (3.1" to 19.7") Infinity: ∞
Metering	Multi-pattern by imaging element
Exposure Control	Program AE
Exposure Compensation	-2.0 EV to +2.0 EV (in 1/3EV steps)
Shutter	CMOS electronic shutter

Shutter Speed	Snapshot (Auto): 1/10 to 1/16000 second Snapshot (Premium Auto): 1 to 1/16000 second * May differ due to the camera setup.
Aperture Value	F2.8
White Balance	Auto, Daylight, Overcast, Shade, Daywhite Fluorescent, Daylight Fluorescent, Tungsten, Manual WB
Sensitivity (Standard Output Sensitivity)	Snapshots: Auto, ISO 100, ISO 200, ISO 400, ISO 800, ISO 1600, ISO 3200 equivalent Movies: Auto
Self-timer	Approximate Trigger Times: 10 seconds, 2 seconds, 2 to 10 seconds
Recording	Snapshots (Auto, Premium Auto), Super-Resolution, Macro, Self-timer, BEST SHOT, Face Detection, Movies (Full HD, HD, HS; with monaural audio, no audio for HS Movies), Slide Panorama, Motion Shutter
Monitor Screen	3.0-inch TFT color LCD (Super Clear LCD) 460,800 (960×480) dots Touch Screen
Viewfinder	Monitor Screen
Timekeeping Functions	Built-in quartz digital clock Date and Time: Recorded with image data Auto Calendar: To 2049
World Time	162 cities in 32 time zones City name, date, time, summer time
External connection terminal	USB port (Hi-Speed USB compatible, USB charging), HDMI output (Micro/TypeD)
Microphones	Monaural
Speaker	Monaural
Power Requirements	Special rechargeable lithium ion battery (built-in)

Approximate Battery Life

All of the values provided below represent the approximate amount of time under normal temperature (23°C (73°F)) before the camera turns off. These values are not guaranteed. Low temperatures shorten battery life.

Number of Shots (CIPA) (Operating Time)*1	220 shots
Continuous Playback (Snapshots)*2	2 hours 10 minutes
Approximate continuous movie recording time (High speed movie)*3	1 hour 20 minutes
Approximate continuous movie recording time (Full HD Movie)*3	1 hour 10 minutes

- Recording Medium: 1GB SD memory card (PRO HIGH SPEED (Panasonic Corporation))
- Measurement Conditions

*1 Approximate number of shots (CIPA) (Operating Time)

In accordance with CIPA (Camera and Imaging Products Association) standards
Normal temperature (23°C (73°F)), monitor on, during which two images are shot;
power turned off and back on every time 10 images are shot.

*2 Approximate playback time

Standard temperature (23°C (73°F)), one-image scroll approximately every 10 seconds

*3 Approximate time using a 16GB SDHC memory card for a repeated cycle of 10 minutes recording followed by deletion of the recorded file.

- The above values are based on a full charge, the first time the battery is charged after the camera is purchased. Repeated charging shortens battery life.
- Frequency of Auto Focus usage and the time the camera is on greatly affects recording time and number of shots values.

Power Consumption	3.7 V DC, Approximately 3.6 W
Dimensions	122.8 (W) × 59.0 (H) × 14.9 (D) mm (4.8" (W) × 2.3" (H) × 0.59" (D))
Weight	Approximately 157 g (5.5 oz) (including memory card) Approximately 155 g (5.5 oz) (excluding memory card)

■ USB-AC adaptor (AD-C53U)

Input Power	100 to 240 V AC, 50/60 Hz, 100 mA
Output Power	5.0 V DC, 650 mA
Operating Temperature Requirements	5 to 35°C (41 to 95°F)
Dimensions	53 (W) × 21 (H) × 45 (D) mm (2.1" (W) × 0.83" (H) × 1.8" (D)) (excluding projections)
Weight	Approximately 37 g (1.3 oz)

- Power cord precautions for use in Singapore
The power cord set is not supplied. The power cord used must comply with relevant national and/or international standards.

CASIO®

CASIO COMPUTER CO.,LTD.
6-2, Hon-machi 1-chome
Shibuya-ku, Tokyo 151-8543, Japan

Free Manuals Download Website

<http://myh66.com>

<http://usermanuals.us>

<http://www.somanuals.com>

<http://www.4manuals.cc>

<http://www.manual-lib.com>

<http://www.404manual.com>

<http://www.luxmanual.com>

<http://aubethermostatmanual.com>

Golf course search by state

<http://golfingnear.com>

Email search by domain

<http://emailbydomain.com>

Auto manuals search

<http://auto.somanuals.com>

TV manuals search

<http://tv.somanuals.com>