

OPERATION CHART:MODULE QW-1294

GENERAL GUIDE

- Press (C) to change from mode to mode.
- After you perform an operation in any mode, pressing (C) returns to the Timekeeping Mode.
- In any mode, hold down (C) for 2 seconds to enter the Dive Time Measurement Mode.

Dive Time Measurement Mode



Hold down (C) for 2 seconds.

Timekeeping Mode

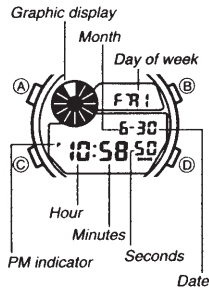
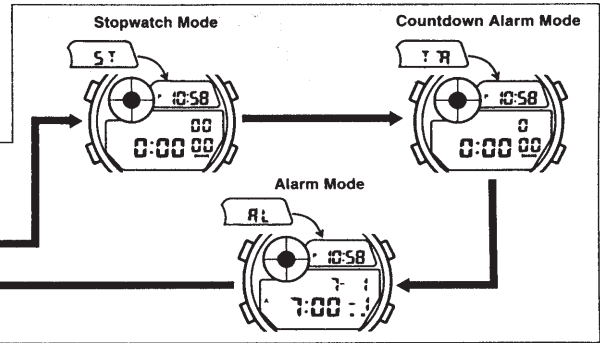
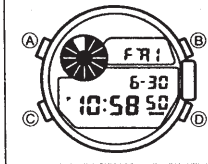

TIMEKEEPING MODE

- While in the Timekeeping Mode, press (B) to illuminate the display for about two seconds. The backlight of this watch employs an electro-luminescent (EL) light, which loses its illuminating power after very long term use.
- Frequent use of the backlight shortens the battery life.

To set the time and date

1. Press (A) while in the Timekeeping Mode. The seconds digits flash on the display because they are selected.
2. Press (C) to change the selection in the following sequence.

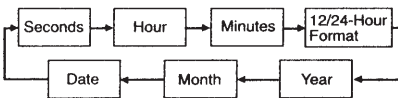

3. While the seconds digits are selected (flashing), press (D) to reset them to "00". If you press (D) while the seconds count is in the range of 30 to 59, the seconds are reset to "00" and 1 is added to the minutes. If the seconds count is in the range of 00 to 29, the minutes count is unchanged.
4. While any digits (besides seconds) are selected (flashing), press (D) to increase the number. Holding down (D) changes the current selection at high speed. While the 12/24-hour setting is selected, press (D) to switch between the two formats.
5. After you set the time and date, press (A) to return to the Timekeeping Mode.

- The day of the week is automatically set in accordance with the date.
- The date can be set within the range of January 1, 1995 to December 31, 2039.
- If you do not operate any button for a few minutes while a selection is flashing, the flashing stops and the watch goes back to the Timekeeping Mode automatically.
- A segment of the graphic display appears every five minutes.

DIVE TIME MEASUREMENT MODE

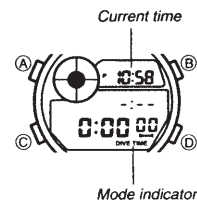

The Dive Time Measurement Mode lets you measure the total time you spend underwater while diving or snorkeling, and the amount of time spent on the surface (surface interval). The watch also stores one set of diving time data (total dive time and dive start time) into log memory for later recall.

- While in the Dive Time Measurement Mode, press (B) to illuminate the display for about two seconds.

Precautions

For your own safety, never operate the buttons of the watch while underwater or while on the water's surface. Perform button operations in a safe place after leaving the water.

Before Diving/Snorkeling

- Be sure to check if the battery power is low (check for low light intensity or a dim display). If it is, do not use the watch for diving/snorkeling.
- Make sure that the watch is set to the correct time of day.
- Check the glass, case and band for cracks or chips.
- Make sure that the band is fastened securely around your wrist.

While Diving/Snorkeling

- Always use the "buddy system" when diving — never dive alone.
- Check to make sure that timer operation is being performed properly.
- Take care when diving/snorkeling near rocks or coral to avoid scratching the watch.

After Diving/Snorkeling

- To avoid corrosion, rinse your watch thoroughly with fresh water to remove salt water, dirt, etc. (When possible, soak the watch in fresh water overnight to make sure that all salt is removed.)

To use the Dive Time Measurement Mode

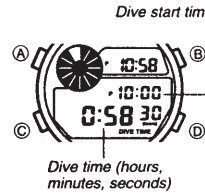

1. Before diving/snorkeling, switch to the Dive Time Measurement Mode by holding down (C) for at least two seconds.
2. To start the dive time measurement operation, press (D).
3. To stop the measurement, hold down (D) for at least one second (until the watch emits a long beep). At this time, timing of the surface interval starts. This timing is performed internally, and it is not indicated on the Dive Time Measurement Mode display. For details on how to view surface interval data, see "To review log data".

4. To resume timing from the dive time shown on the display, press (D). You can repeat steps 3 and 4 as many times as you like.

Important!

Do not recall log data (to view the surface interval) while this procedure is in progress. If you do, the dive time to that point will be stored into memory and the data will be cleared when you re-start the dive time measurement operation.

5. To clear the Dive Time Measurement Mode, stop the measurement operation (step 3, above) and then press (A).

To review log data

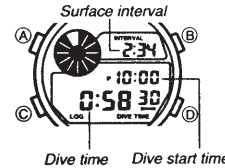

Log data can be reviewed (recalled) in the Timekeeping Mode.

1. Hold down (C) for at least two seconds to enter the Timekeeping Mode from the Dive Time Measurement Mode.
2. Hold down (D) to display the Log Data Display. The Log Data Display remains visible as long as you hold down (D). When you release (D), the normal Timekeeping Mode display returns.

To clear the log data memory

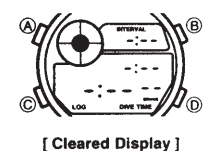

Log data in memory is automatically replaced by the newest measurement. Use the following operation if you want to manually clear the log data memory.

1. While in the Timekeeping Mode, hold down (D) to display the Log Data Display.
2. Press (A) to clear the log data memory. At this time, the display clears so that no data is shown.

STOPWATCH MODE

The Stopwatch Mode lets you measure elapsed time, split times, and two finishes. The range of the stopwatch is 23 hours, 59 minutes, 59.99 seconds.

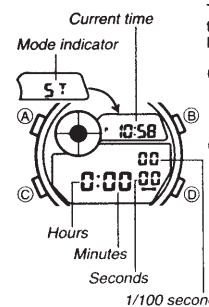

(a) Elapsed time measurement



(b) Split time measurement

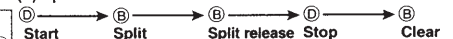

(c) Split time and 1st-2nd place times



COUNTDOWN ALARM MODE

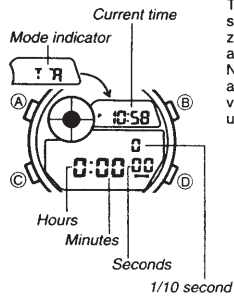

The countdown timer can be set within a range of 1 second to 24 hours. When the countdown reaches zero, an alarm sounds for 10 seconds or until you press any button.

Note that you can also select auto repeat timing that automatically restarts the countdown from the original value you set whenever zero is reached. This continues until you manually stop the countdown.

To set the countdown time

1. Press (A) while in the Countdown Alarm Mode. The hours digit flashes on the display because it is *selected*.
2. Press (C) to change the selection in the following sequence.

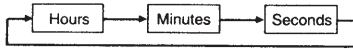

3. Press (D) to increase the selected number. Holding down (D) changes the selection at high speed.
4. To set the starting value of the countdown time to 24 hours, set to 0:00 00.
4. After you set the countdown time, press (A) to return to the Countdown Alarm Mode.

To use the countdown timer

1. Press (D) while in the Countdown Alarm Mode to start the countdown timer.
2. Press (D) again to stop the countdown timer.
- You can continue countdown timer operation by pressing (D).
3. Stop the timer and then press (B) to reset the countdown time to its starting value.
- When the end of the countdown is reached and auto repeat timing is off, the alarm sounds for 10 seconds or until you stop the alarm by pressing any button. Countdown timing stops, and the countdown time is automatically reset to its starting value after the alarm stops.

To switch auto repeat timing on and off

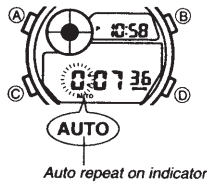

1. Press (A) while in the Countdown Alarm Mode. The hours digit flashes on the display because it is *selected*.
2. Press (B) to switch auto repeat on and off.
3. Press (A) to return to the Countdown Alarm Mode.
- When the end of the countdown is reached while auto repeat is on, the alarm sounds, but the starting countdown time is reset and countdown timing starts again automatically whenever the countdown reaches zero. You can stop timing by pressing (D), and manually reset to the starting countdown time by pressing (B).

ALARM MODE

You can set three independent alarms with hour, minutes, month, and date. When the alarm is on, the alarm sounds for 20 seconds at the preset time. Press any button to stop the alarm after it starts to sound. When the Hourly Time Signal is on, the watch beeps every hour on the hour.

Alarm Types

The types of alarm you get depends on the information you set.

- **To set a Daily alarm**
Set the hour and minutes for the alarm time. Set "--" for the month and "--" for the date (see step 4 under "To set alarms"). This type of setting causes the alarm to sound every day at the time you set.
- **To set a Date alarm**
Set the month, date, hour and minutes for the alarm time. This type of setting causes the alarm to sound at the specific time, on the specific date you set.

- **To set a 1-Month alarm**
Set the month, hour and minutes for the alarm time. Set "--" for the date (see step 4 under "To set alarms"). This type of setting causes the alarm to sound every day at the time you set, only during the month you set.
- **To set a Monthly alarm**
Set the date, hour and minutes for the alarm time. Set "--" for the month (see step 4 under "To set alarms"). This type of setting causes the alarm to sound every month at the time you set, on the date you set.

To set alarms

1. Press (D) while in the Alarm Mode to select Alarm 1 through Alarm 3.



2. After you select an alarm, press (A). The hour digits flash on the display because they are *selected*.
- At this time, the alarm is automatically switched on.

3. Press (C) to change the selection in the following sequence.



4. Press (D) to increase the selected digits. Holding down (D) changes the selection at high speed.
 - To set an alarm that does not include a month (daily alarm, monthly alarm), set "--" for the month. Press (D) until the "--" mark appears (between 12 and 1) while the month digits are flashing.
 - To set an alarm that does not include date (daily alarm, 1-month alarm), set "--" for the date. Press (D) until the "--" mark appears (between 31 and 1) while the date digits are flashing.
 - The format (12-hour and 24-hour) of the alarm time matches the format you select for normal timekeeping.
 - When setting the alarm time using the 12-hour format, take care to set the time correctly as morning (A) or afternoon (P).
5. After you set the alarm, press (A) to return to the Alarm Mode.

To switch an Alarm and Hourly Time Signal on and off

1. In the Alarm Mode, press (D) to select an alarm or the Hourly Time Signal.
2. When the alarm or Hourly Time Signal you want to is selected, press (B) to switch it on and off.

([[[]]) Indicates alarm is ON

([■]) Indicates Hourly Time Signal is ON

- If any alarm is on, the Alarm On Indicator ([[[[]]]) is shown on the display when you change to another mode.

To test the alarm

Hold down (D) while in the Alarm Mode to sound the alarm.

Free Manuals Download Website

<http://myh66.com>

<http://usermanuals.us>

<http://www.somanuals.com>

<http://www.4manuals.cc>

<http://www.manual-lib.com>

<http://www.404manual.com>

<http://www.luxmanual.com>

<http://aubethermostatmanual.com>

Golf course search by state

<http://golfingnear.com>

Email search by domain

<http://emailbydomain.com>

Auto manuals search

<http://auto.somanuals.com>

TV manuals search

<http://tv.somanuals.com>