

**Kodak Professional**

**DCS ProSLR/c**  
DIGITAL CAMERA

USER'S GUIDE





# KODAK PROFESSIONAL DCS Pro SLR/c Digital Camera



## User's Guide

P/N 6B8773



**Eastman Kodak Company**  
**343 State Street**  
**Rochester, New York, 14650**

**© Eastman Kodak Company, 2004**

**Kodak and Kodak Professional are trademarks of Eastman Kodak Company.**



# Table of Contents

## 1 Important Information

System Requirements for Your Computer .....	1-1
Warranty Registration for your Camera.....	1-1
Warnings.....	1-2
Safety Warnings.....	1-2
Operational Warnings .....	1-2
Important Safeguards and Precautions .....	1-3
Electromagnetic Emissions.....	1-6
VCCI.....	1-6

## 2 About Your Camera

Nomenclature.....	2-1
Camera Front.....	2-1
Camera Back .....	2-2
Camera Top.....	2-2
Camera Bottom.....	2-3
Left Side.....	2-3
Right Side .....	2-4
Open Media Door .....	2-4
Control Dials .....	2-5
D-Dial.....	2-5
S-Dial/Mode Selector Lever.....	2-5
Turning the Camera On and Off.....	2-6
Viewfinder and Focus Screen.....	2-6
Digital Buttons.....	2-7
Five-way control.....	2-7
OK Button .....	2-8
Cancel Button .....	2-8
Menu Button.....	2-8
Nav+ Button .....	2-8
Hotkey Button.....	2-9

## Table of Contents

---

Digital Status Button .....	2-9
Delete Button .....	2-9
Tag/Record Button .....	2-9
LCDs .....	2-10
Top Status LCD .....	2-10
Image LCD .....	2-10
Turning On the Image LCD .....	2-11
Display Activation .....	2-12
Turning Off the Image LCD .....	2-12
Digital Status LCD .....	2-13
Using the Menus .....	2-14
Navigating Through the Menus .....	2-15
Using the Digital Status Button and Digital Status LCD to Highlight Menu Options .....	2-16
Using the Hotkey Button to Highlight Menu Options .....	2-17
Lens .....	2-18
Mounting the Lens .....	2-18
Removing the Lens .....	2-19
Imager .....	2-19
Shutter Button .....	2-19
Diopter Adjustment .....	2-20
Depth of Field Preview Button .....	2-21
Depth of Field .....	2-21
Hot Shoe .....	2-22
PC Sync Terminal .....	2-22
Remote Release Accessory Port .....	2-22
Viewfinder Cap .....	2-23
Camera Straps .....	2-24
Attaching the Neck Strap .....	2-24
Attaching the Hand Strap .....	2-24

### 3 Powering Your Camera

Powering Your Camera using the Power Module .....	3-2
Powering Your Camera using a Battery .....	3-2
Charging Batteries .....	3-2
Inserting/Removing Batteries .....	3-4
Checking Battery Status .....	3-4

Conserving Batteries .....	3-5
Situations Using Extra Battery Power .....	3-5
CR 2032 Coin Cell.....	3-6
Disposing of Batteries .....	3-6
<b>4 The Basics</b>	
Basic Mode .....	4-1
Setting Basic Mode.....	4-2
Accessing Functions Using the Basic Menu .....	4-2
Digital Status LCD.....	4-3
Using the Digital Status LCD to Highlight Menu Options .....	4-3
Setting ISO .....	4-4
Setting White Balance.....	4-5
Setting Raw Resolution.....	4-6
Setting JPEG Resolution.....	4-6
Formatting a Card .....	4-7
Changing the Display Contrast.....	4-8
Turning the Overexposure Indicator On and Off.....	4-9
Firmware .....	4-10
Checking the Firmware Version.....	4-10
Updating Firmware.....	4-11
Setting the Time/Date.....	4-13
Setting User Mode.....	4-13
Using the Hotkey button to Highlight Menu Options .....	4-14
Composing, Focusing, and Capturing Images.....	4-15
<b>5 Configuring your Camera</b>	
Setting the User Mode.....	5-1
Setting Battery Save.....	5-2
Camera .....	5-2
Image LCD .....	5-2
Custom Settings.....	5-3
Custom Settings Table .....	5-3
Firmware.....	5-5
Checking the Firmware Version .....	5-5
Downloading Firmware to your Computer .....	5-6
Firmware Features .....	5-6

Updating Firmware.....	5-6
Folder and File Naming.....	5-8
Setting Hotkeys .....	5-9
Using Job Tracker.....	5-10
Saving a Job Tracker File to a Card.....	5-10
Loading a Job Tracker File from a Card.....	5-11
Loading a Job Tracker File From Camera Memory .....	5-12
Selecting a Language.....	5-12
Resetting Defaults .....	5-13
User Setups.....	5-14
Creating a New User Setup.....	5-14
Saved Setups .....	5-15
Loading a Setup from a Card.....	5-15
Saving a Setup to a Card.....	5-15
Deleting Setups from Camera Memory.....	5-16
Selecting a User Setup .....	5-16
Editing an Existing Setup .....	5-16
Using Setups on More than One Camera.....	5-17
Time and Date .....	5-17
Using the Vertical Release.....	5-18
Long Exposure.....	5-19
Intervalometer .....	5-20
Changing Intervalometer Settings .....	5-21
ISO .....	5-22
Setting ISO using the Image LCD.....	5-22
Setting ISO using Camera Controls .....	5-22
Drive Mode.....	5-23
Drive Area of the D-Dial.....	5-23
Single Frame Shooting.....	5-23
Continuous Shooting.....	5-24
Self Timer .....	5-25
To Cancel the Self Timer .....	5-25
Mirror Lock-Up.....	5-26
Remote Controller .....	5-27
Setting the Remote Controller.....	5-27
Setting the Camera to Remote Control Mode .....	5-28



Cancelling Remote Control Mode .....	5-28
Using the Mirror Lock-Up with the Remote Controller.....	5-29
Replacing the Remote Controller Battery.....	5-29
Setting the Electronic Sound.....	5-30
Lens Optimization.....	5-31
Overview.....	5-31
Selecting the Method of Lens Optimization.....	5-32
Auto .....	5-32
Manual.....	5-33
Select a Lens from the User List.....	5-33
When you Change Lenses .....	5-34
Maintaining the User List.....	5-35
Adding Lenses from the Master List .....	5-35
Removing Lenses from the User List .....	5-37
Saving a List .....	5-38
Loading a List.....	5-38
Defining New Lenses .....	5-39
Defining New Fixed Lenses .....	5-39
Defining New Zoom Lenses .....	5-40
Deleting Defined Lenses .....	5-41
Editing the Lens Name .....	5-42
Changing the Strength .....	5-44
Determining the Optimum Strength.....	5-44
Assigning Optimum Strengths to Lenses in the User List.....	5-45
Resetting to Defaults.....	5-46

## 6 Setting up Cards, Folders, and Files

Memory Cards.....	6-1
Inserting Cards .....	6-2
Removing Cards.....	6-2
File Types.....	6-3
Choosing the File Type to be Written to a Card .....	6-3
File Type and ISO .....	6-4
Choosing the JPEG File Type .....	6-5
Formatting Cards .....	6-6
Recovering Deleted Files.....	6-7

Determining Write Speed .....	6-8
For the Most Accurate Write Speed Measurement .....	6-8
Folders for Captured Images.....	6-9
Selecting a Capture Folder.....	6-9
Creating a New Folder .....	6-10
Image Files .....	6-11
Setting the Crop Aspect Ratio.....	6-11
Setting Raw Resolution.....	6-12
Setting JPEG Resolution.....	6-12
Setting JPEG Quality.....	6-13
Correcting Digital Exposure .....	6-14
Setting Exposure Bias.....	6-14
Setting Look .....	6-15
Setting Noise Reduction.....	6-15
Selecting the Sharpening Level .....	6-16

## 7 Controlling Exposure

White Balance.....	7-1
Preset White Balance.....	7-2
Click Balance .....	7-3
Using the Current Image for Click Balance.....	7-3
Displaying the Saved Settings Menu.....	7-4
Using a Saved Setting .....	7-4
Saving a Setting on the Camera .....	7-5
Loading Settings from a Card .....	7-6
Deleting Settings.....	7-6
Exposure .....	7-7
Exposure Metering Modes.....	7-7
Choosing a Metering Mode .....	7-7
Exposure Modes .....	7-7
Program Auto Exposure Mode.....	7-8
Aperture Priority Auto Exposure Mode .....	7-11
Shutter Speed Priority Auto Exposure Mode.....	7-12
Manual Exposure Mode.....	7-13
Bulb Setting.....	7-15
Auto Exposure Lock .....	7-16

Exposure Compensation .....	7-17
Cancelling Exposure Compensation.....	7-17
Auto Bracketing.....	7-18
Cancelling Auto Bracketing .....	7-19
Using Auto Bracketing with Exposure Compensation.....	7-19

## 8 Focusing

Autofocus .....	8-1
Autofocus Modes .....	8-1
Setting Autofocus .....	8-1
Situations where Autofocus May Not Work as Expected.....	8-2
Selecting the Autofocus Mode .....	8-2
Selecting the Autofocus Zone .....	8-3
Capturing Images in Single AF Mode.....	8-4
Capturing Images in Continuous AF Mode.....	8-4
Locking Focus.....	8-5
Manual Focus.....	8-5

## 9 Capture Workflow

Capture Workflow when the Camera is Not Connected to a Computer.....	9-1
Device and Media Preparation.....	9-2
Capturing and Evaluating Test Images.....	9-3
Capturing Images.....	9-3
Occasional Verification.....	9-4
Transferring Images.....	9-4
Editing Images.....	9-4
KODAK PROFESSIONAL DCS Photo Desk .....	9-5
KODAK PROFESSIONAL Extended Range Imaging File Format Module.....	9-5
Capture Workflow when the Camera Is Connected to a Computer.....	9-6
Connecting to a Computer and Power Supply.....	9-6
Starting the Capture Software .....	9-6
Device and Media Preparation.....	9-6
Capturing and Evaluating Test Images.....	9-6
Capturing Images.....	9-6
Occasional Verification.....	9-6
Editing Images.....	9-6

## 10 Flash Photography

Compatible Flash Units .....	10-1
Mounting a Hot Shoe Flash .....	10-2
Connecting a Studio Flash .....	10-2
Available Features .....	10-3
E-TTL Autoflash .....	10-3
High Speed Sync Mode .....	10-4
Flash Exposure Lock.....	10-4
Flash Exposure Compensation .....	10-5
Flash Exposure Bracketing .....	10-5
Previewing Flash Results .....	10-5
Wireless Flash with One or More Flash Units .....	10-5

## 11 Working with Images on the Camera

Reviewing Images .....	11-1
Selecting an Image Mode .....	11-1
Changing the Duration of the Image Mode Menu Display.....	11-2
Single-Image Mode .....	11-2
Histogram Mode .....	11-3
Interpreting a Histogram .....	11-3
Zoom Mode .....	11-4
Enabling or Disabling the Region of Interest Box.....	11-4
Zooming.....	11-4
Panning.....	11-4
Luminometer.....	11-5
Multiple Image Mode .....	11-5
Status Bar.....	11-5
Selecting a Review Folder .....	11-6
Browsing Through Images .....	11-7
Browsing Through Images Using the Nav+ Button .....	11-7
Location Bar .....	11-7
Selecting an Image .....	11-7
Overexposure Indicator .....	11-8
Changing Display Contrast and Brightness.....	11-8
Auto Review .....	11-9
Slide Show .....	11-9
Starting/Stopping a Slide Show .....	11-10

Deleting Images.....	11-11
Tagging Images .....	11-12
Recording Sound Files.....	11-13
<b>12 Viewing Image LCD Information on External Video</b>	
Connecting.....	12-1
Enabling External Video .....	12-2
<b>13 Connecting to Your Computer</b>	
Advantages to an IEEE 1394 Connection.....	13-1
Advantages to a Card Reader .....	13-1
Connecting Your Camera to the Computer.....	13-2
Quitting—Disconnecting from the Computer .....	13-3
Using the Card Reader.....	13-3
<b>14 Camera Care</b>	
Handling .....	14-1
Cleaning.....	14-2
The Imager.....	14-3
Determining if the Imager is Dirty.....	14-3
Examining a Test Image .....	14-3
Inspecting and Cleaning the Imager .....	14-4
.....	14-4
Storing.....	14-5
Top Status and Image LCDs .....	14-5
<b>15 Serial Data Collection and Global Positioning System</b>	
Serial Data Collection .....	15-1
Connecting a Device to the Serial Port .....	15-1
Serial In Mode .....	15-2
Serial In Status .....	15-3
Serial Out Mode.....	15-3
Setting the Baud Rate .....	15-4
Global Positioning System.....	15-4
Requirements for Using the GPS Feature .....	15-4
Using the GPS Feature .....	15-5
<b>Appendix A Specifications</b>	
Burst Depth.....	A-4

## **Appendix B Lens Compatibility**

SIGMA Lenses .....	B-1
CANON Lenses .....	B-3

## **Appendix C Troubleshooting**

Problems, Causes, and Remedies.....	C-1
-------------------------------------	-----

## **Appendix D Warranty**

KODAK PROFESSIONAL DCS Pro SLR/c Digital Camera .....	D-1
Warranty Repair Coverage .....	D-1
Limitations.....	D-2
Outside the United States .....	D-3
How to Obtain Service .....	D-3
Product Support Options .....	D-4

## **Glossary**



# 1 Important Information

Thank you for purchasing your KODAK PROFESSIONAL DCS Pro SLR/c Digital Camera (DCS Pro SLR/c). This portable camera system allows you to capture and store high-resolution, high-quality digital images. Before you start using the camera, follow the instructions listed below.

- Read the Warranty statement.
- Verify that your MACINTOSH or WINDOWS-based computer meets the system requirements.
- Read the Warnings section.
- Review the Important Safeguards and Precautions.
- Register your camera. See below.

## System Requirements for Your Computer

Refer to the following Web site for system requirements:  
[www.kodak.com/go/dcs](http://www.kodak.com/go/dcs).

## Warranty Registration for your Camera

So that we may better serve your support needs, please register your camera in one of two ways (listed below). Your registration enables you to download camera firmware, software updates, and technical information for your camera.

- Go to [www.kodak.com/go/DCSRegister](http://www.kodak.com/go/DCSRegister)
- Complete the Registration card (included with your camera).

## Warnings

### Safety Warnings

- To prevent fire or shock hazard, use only the recommended accessories and attachments.

### Operational Warnings

- Do not use IEEE 1394 repeaters when connecting your camera. Doing so can damage the camera.
- Be sure the connector orientation is correct when you connect the IEEE 1394 cable to the computer. Connecting incorrectly can damage your camera or computer. At the computer connection, the point on the 6-pin plug must align with the point on the computer port.
- Use extreme care when handling memory cards as they are easily damaged. If a card is dropped, all data on the card can be lost.
- Do not remove a memory card, the KODAK PROFESSIONAL DCS Pro Battery, or the KODAK PROFESSIONAL DCS Pro DC Power Module from the camera while the memory card icon on the Digital Status LCD or the Card Busy LED are blinking. The blinking indicates that data is being read from or written to the card. You may lose data if you remove a card at this time.
- Operate your camera only from the type of power source indicated on the name plate of the KODAK PROFESSIONAL DCS Pro DC Power Module. A line voltage outside this range can destroy the power module and/or the camera.
- Use only the KODAK PROFESSIONAL DCS Pro DC Power Module included with your camera or available from Kodak as an accessory. Do not plug other adapters into the camera.
- The KODAK PROFESSIONAL DCS Pro DC Power Module is for indoor use only.
- Do not use the supplied KODAK PROFESSIONAL DCS Pro DC Power Module for any purpose other than for the KODAK PROFESSIONAL DCS Pro SLR/c Digital Camera.
- Use the Image LCD to verify that a picture was captured correctly during your photo session.
- Do not attempt to replace the Focus screen. Return the camera to an authorized KODAK service center if the focus screen needs replacing.



## Important Safeguards and Precautions

**Read Instructions**—Read all the safety and operating instructions before operating your camera.

**Follow Instructions**—Follow all operating and usage instructions.

**Controls**—Adjust only those controls that are covered by the operating instructions.

**Heed Warnings**—Heed all warnings on your camera and in the operating instructions.

**Retain Instructions and Packaging**—Retain the safety and operating instructions for future reference. Retain the packing case for use if your camera needs to be shipped.

**Handling**—Handle your camera with care. Treat the imager as you would your best lens. Do not drop your camera. Do not place your camera on an unstable surface. It can fall, causing serious injury to persons and serious damage to your camera.

**Dust**—If you operate the camera in environments with excessive dust levels, dust may accumulate on the camera.

**Water and Moisture**—Do not use the camera in dripping or splashing water or near salt spray, and do not immerse your camera in water or other liquids. Do not use the KODAK PROFESSIONAL DCS Pro Charger / AC Adapter near water—for example, near a sink or in a wet room or basement.

**Disposal**—This digital camera contains lead. Disposal of lead may be regulated due to environmental considerations. For disposal or recycling information, please contact your local authorities or, in the U.S.A., the Electronics Industry Alliance: [www.eiae.org](http://www.eiae.org).

**Object or Liquid Entry**—Never push foreign objects of any kind into your camera openings. The objects could touch dangerous voltage points or short out parts and cause a fire or electric shock. Never spill liquid of any kind on your camera.

**Attachments**—Do not use attachments that are not recommended. The use of such attachments may cause hazards and serious damage to your camera.

**Overloading**—Do not overload power outlets and extension cords; this can result in a risk of fire or electrical shock.

**Power-Cord Protections**—Route power-supply and other cords so that you are not likely to walk on them or pinch them with items placed on or against them. Pay particular attention to cords at plugs, receptacles, and the point where they leave your camera.

**Camera Cables**—Use only the cables supplied with your camera.

**Lightning**—For added protection for your camera during a lightning storm, or any time when you will leave your camera unattended for long periods of time, unplug the KODAK PROFESSIONAL DCS Pro Charger / AC Adapter from the power outlet and disconnect the camera from the computer.

**Memory cards**—Memory cards (not supplied with the camera) are fragile devices that can be damaged if not treated with care. See the documentation accompanying any card you obtain to ensure that you are handling it as specified, and that you are using the card within its operating ranges for temperature, humidity, condensation, etc.

**Humidity, Condensation**—We recommend operating your camera within the range of 15% to 76% relative humidity, non-condensing. If condensation occurs, added time may be required to read from or write to a memory card. Condensation may be present if the camera system and/or memory cards are moved from a relatively cold environment (like an air-conditioned room) into a warm, humid environment. We recommend that you allow sufficient time for the camera system and/or memory cards to normalize within the specified environmental ranges before operation. (Memory cards may have more restrictive humidity ranges. See the specifications accompanying your memory cards.)

**Temperature**—Do not expose the camera and batteries to excessive heat such as sunshine or fire.

**Servicing**—Do not attempt to service your camera yourself. Opening or removing covers may expose you to dangerous voltage or other hazards and void the warranty.

**Damage Requiring Service**—Unplug your camera from the wall outlet and computer, and refer all servicing to the manufacturer under the following conditions:

- If liquid has been spilled or if objects have fallen into your camera.
- If your camera has been exposed to heavy rain or water. (While it is designed to tolerate a reasonable amount of moisture, your camera is not waterproof.)
- If your camera does not operate normally according to the operating instructions.
- If your camera has been dropped or the housing has been damaged.
- When your camera exhibits a distinct change in performance.

**Disassembling the Camera**—Never attempt to take the camera apart. The camera is shipped as a single unit.

### Electromagnetic Emissions

This equipment has been tested and found to comply with the limits for a Class B digital device, pursuant to Part 15 of the FCC Rules. These limits are designed to provide reasonable protection against harmful interference in a residential installation. This equipment generates, uses and can radiate radio energy and, if not installed and used in accordance with the instructions, may cause harmful interference to radio communications. However, there is no guarantee that interference will not occur in a particular installation. If this equipment does cause harmful interference to radio or television reception, which can be determined by turning the equipment off and on, the user is encouraged to try to correct the interference by one or more of the following measures:

- Reorient or relocate the receiving antenna.
- Increase the separation between your camera and receiver.
- Connect your camera into an outlet on a circuit different from that to which the receiver is connected.
- Consult the dealer or an experienced radio/TV technician for help.

### VCCI

この装置は、情報処理装置等電波障害自主規制協議会（VCCI）の基準に基づくクラス A 情報技術装置です。この装置を家庭環境で使用すると電波妨害を引き起こすことがあります。この場合には使用者が適切な対策を講ずるよう要求されることがあります。

This is a Class B product based on the standard of the Voluntary Control Council for Interference from Information Technology Equipment (VCCI). If this is used near a radio or television receiver in a domestic environment, it may cause radio interference. Install and use the equipment according to the instruction manual.



## Important Information



# 2 About Your Camera

## Nomenclature

### Camera Front

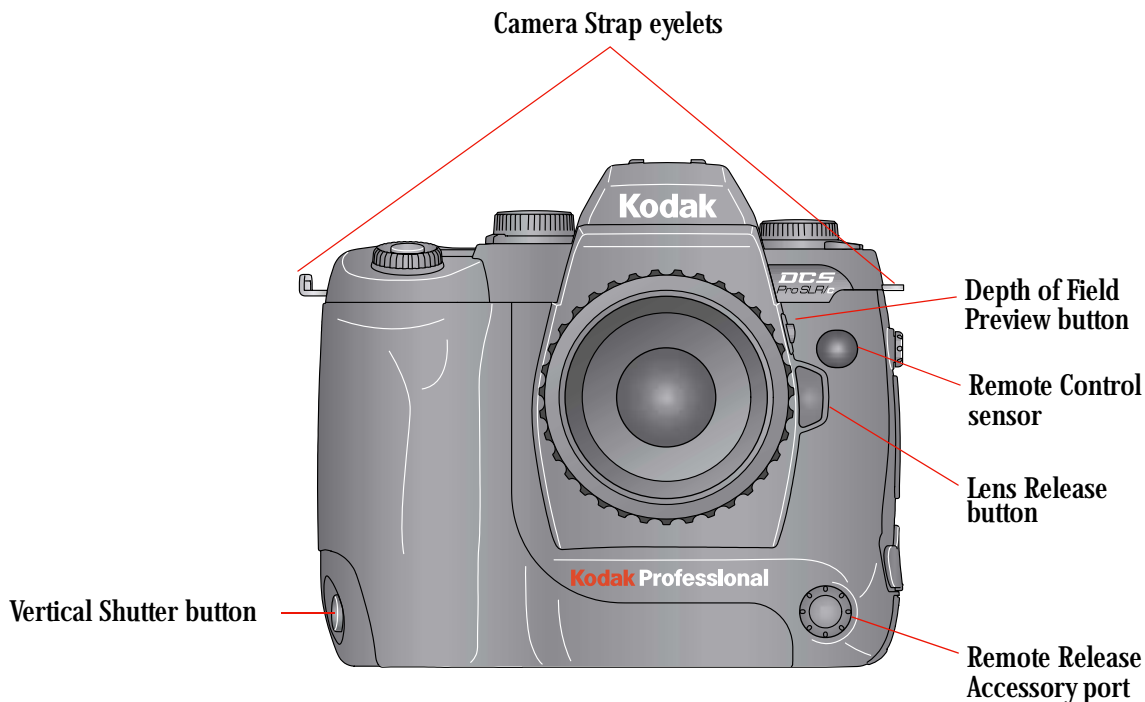

## Camera Back

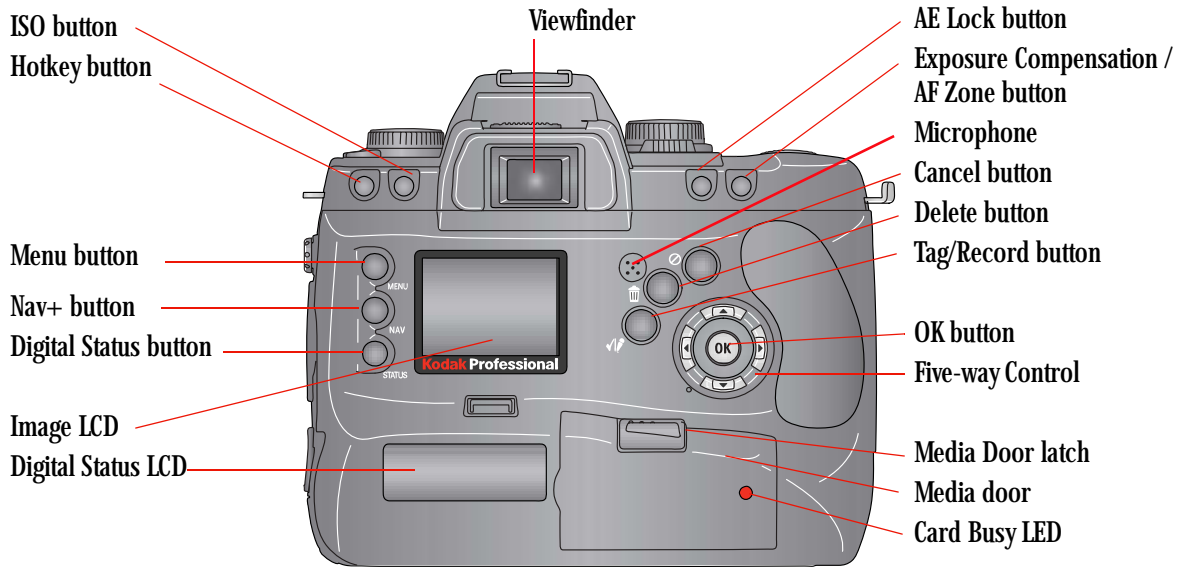

## Camera Top

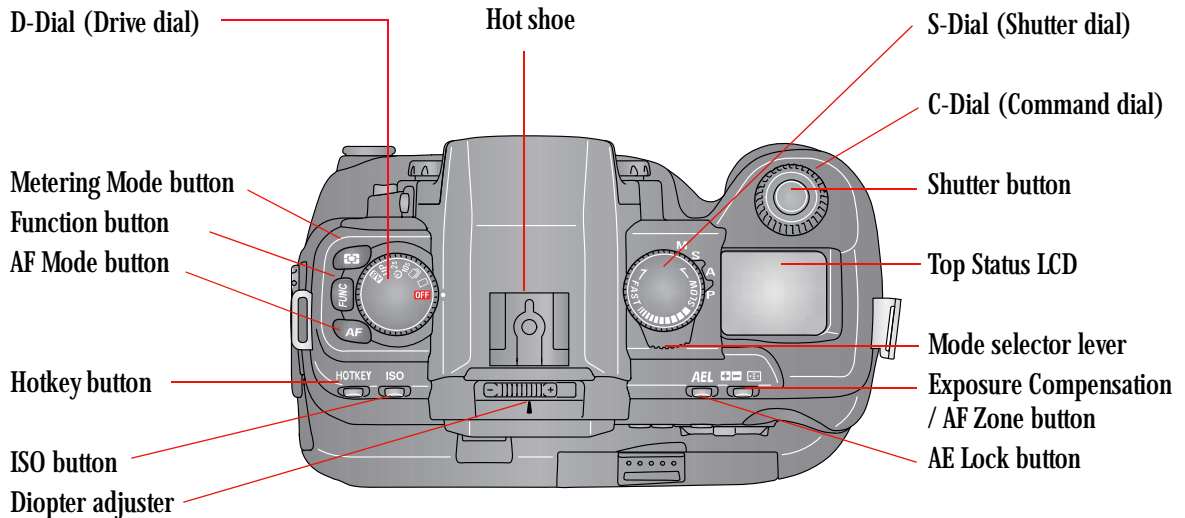



## Camera Bottom

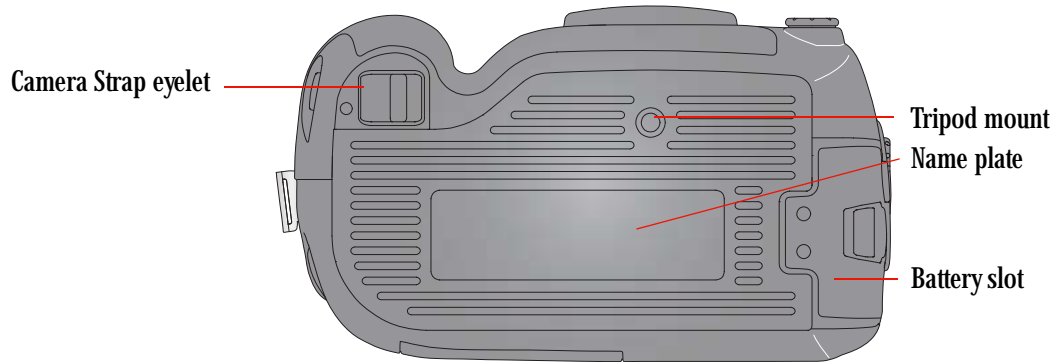

## Left Side

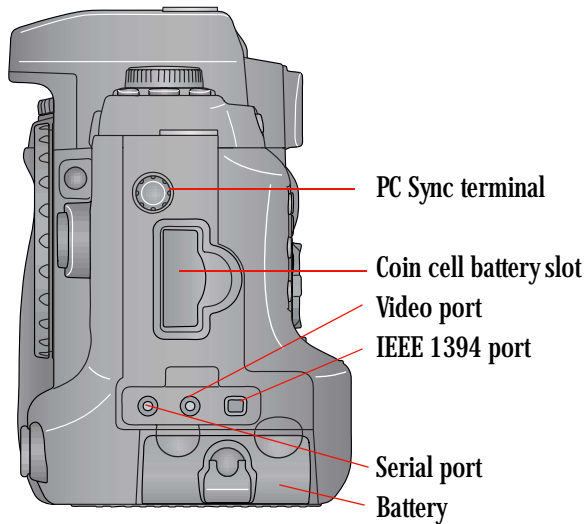

## Right Side

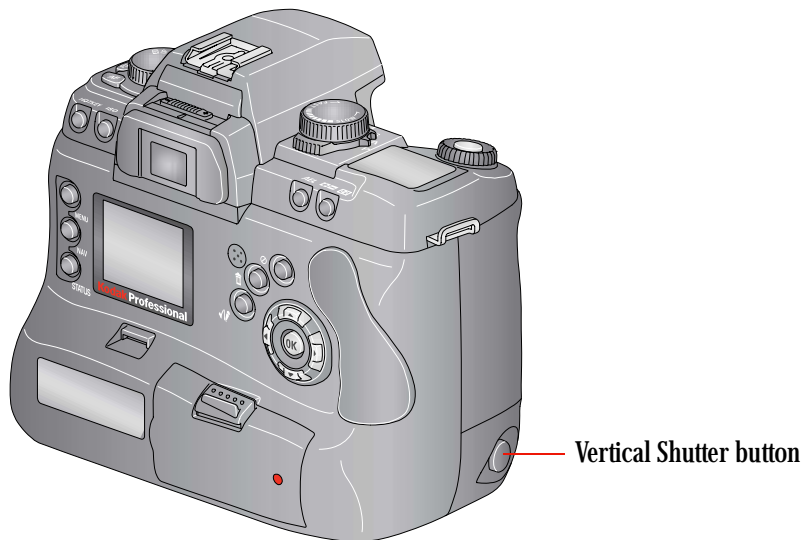

## Open Media Door

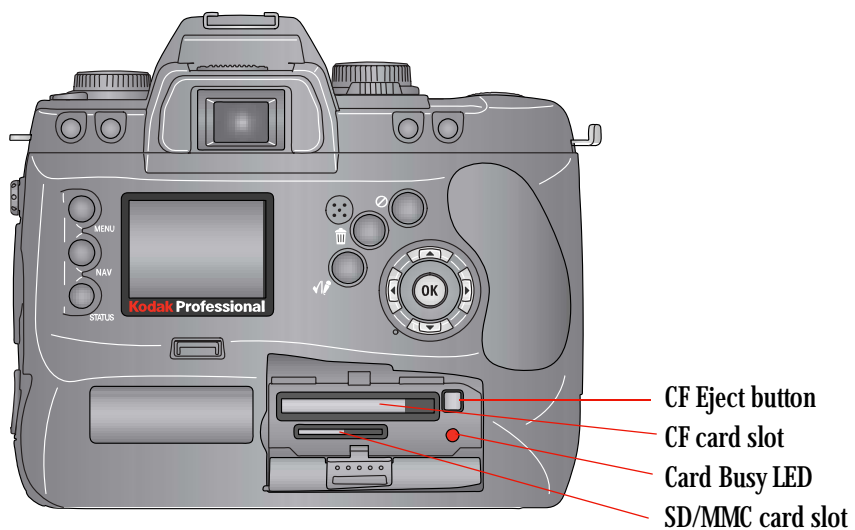

## Control Dials

### D-Dial

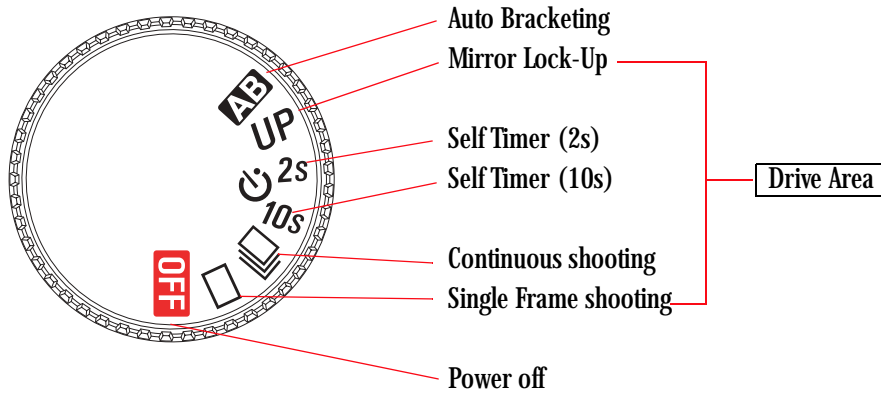

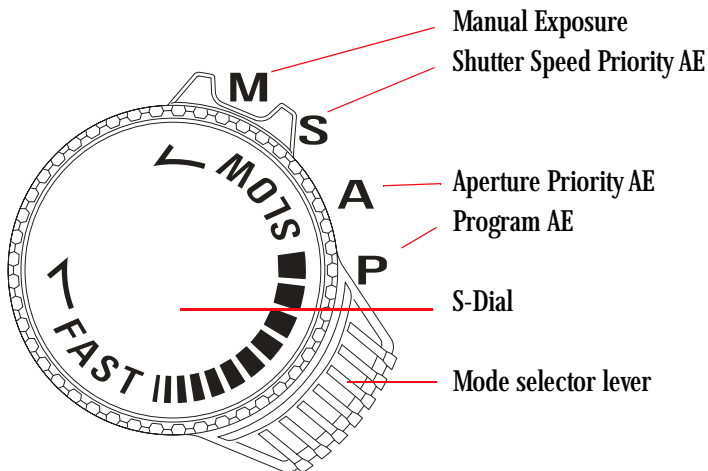

### S-Dial/Mode Selector Lever



## Turning the Camera On and Off

Connect your camera to a power source before turning it on (see [page 3-1](#)).

- Turn the D-Dial to  (Single Frame shooting) to turn the camera on. Turn the D-Dial to  to turn the camera off.

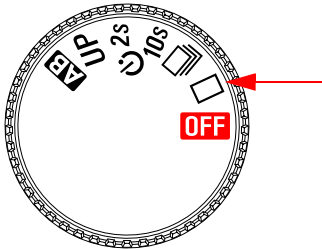

## Viewfinder and Focus Screen

Crop lines for 8 x 10 format

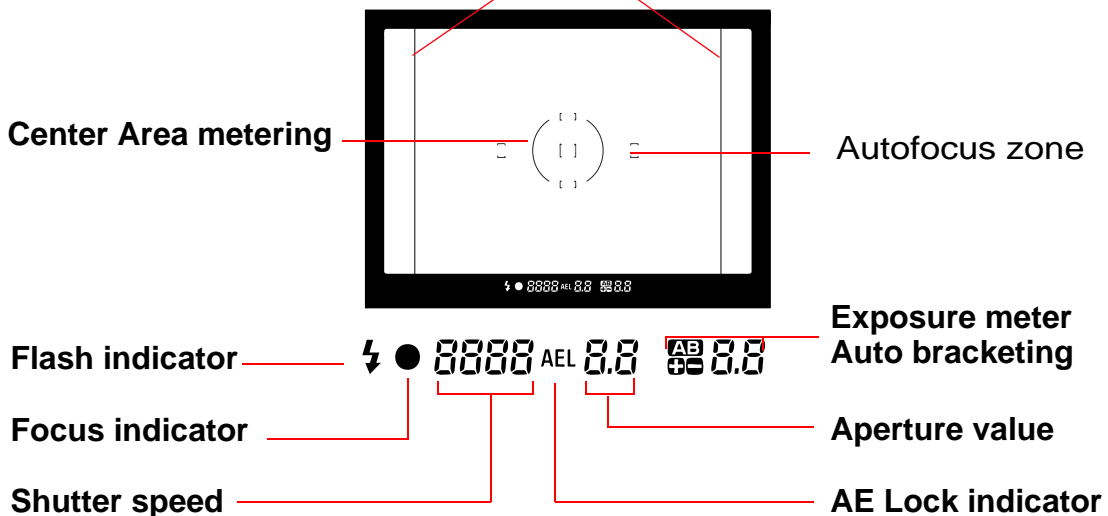

**NOTE:** Do not attempt to replace the Focus screen. Return the camera to an authorized KODAK service center.

## Digital Buttons



**NOTE:** Use the buttons to the left of the Image LCD with the Five-way control. Use the buttons to the right side of the Image LCD without the Five-way control.

## Five-way control

The Five-way control consists of an OK button surrounded by four navigation controls. See [page 2-8](#) for a description of the OK button. When the Image LCD is on, use the Five-way control to access digital functions (see below).

Press the right or left side of the Five-way control to:

- Navigate through images in Image mode
- Move the Region of Interest box right or left in Zoom Image mode
- Navigate among tabbed menus
- When a menu option is highlighted, press the right side of the Five-way control to display/enable a cascaded menu (press the left side to remove/disable the cascaded menu)

Press the top or bottom of the Five-way control to:

- Navigate among Image modes
- Move the Region of Interest box up or down in Zoom Image mode
- Navigate among menu options

### **OK Button**

- Turns on the Image LCD in Image mode
- Implements a highlighted menu option
- Enables the Region of Interest box in Zoom Image mode
- Implements a zoom in Zoom Image mode
- Accepts changes and dismisses confirmation screens

### **Cancel Button**

- Turns off the Image LCD in Image mode
- Exits menus without applying changes
- Disables the Region of Interest box in Zoom Image mode
- Dismisses a confirmation screen without accepting the change
- Displays Image mode when a menu is displayed

### **Menu Button**

- If the Image LCD is off, turns it on and displays a menu (last-accessed menu option highlighted)
- Displays a menu when the Image LCD is in Image mode (last-accessed menu option is highlighted)
- Displays Image mode when a menu is displayed

### **Nav+ Button**

The Nav+ button provides an efficient method of navigating among folders and images within a folder.

- If the Image LCD is off, turns it on in the last-accessed Image mode with Nav+ overlay
- If the Image LCD is on, displays the last-accessed Image mode with Nav+ overlay
- Navigates to higher or lower numbered folders when pressed and held while you press the top or bottom of the Five-way control
- Displays every tenth higher or lower numbered image within a folder when pressed and held while you press the right or left side of the Five-way control

## Hotkey Button

The Hotkey button provides a shortcut to frequently used (user-definable) digital functions.

**NOTE:** The Digital Status button provides shortcuts to specific capture-critical functions. Use the Hotkey button for functions not already available through the Digital Status button.

- If the Image LCD is off, turns it on and displays the menu with the highlighted menu option associated with the first Hotkey position
- If the Image LCD is on, displays the menu with the highlighted menu option associated with the first Hotkey position
- Highlights the menu option for the next / previous Hotkey position when pressed and held while you press the left or right of the Five-way control

## Digital Status Button

The Digital Status button (used with the Digital Status LCD) provides a shortcut to capture-critical menu options on the Image LCD.

- Highlights the last-used function on the Digital Status LCD and highlights its associated menu option on the Image LCD
- Selects a different function on the Digital Status LCD and highlights its associated menu option on the Image LCD when pressed and held while you press the right, left, top, or bottom of the Five-way control
- If the Image LCD is off, turns it on and displays the menu with the highlighted menu option associated with the last-accessed Digital Status LCD function. The menu has a disabled appearance.

## Delete Button

The Delete button is only enabled when the Image LCD is in Image mode.

- Displays a screen with five options for deleting the image.

## Tag/Record Button

The Tag/Record button is only enabled when the Image LCD is in Image mode.

- Press and release quickly (less than one second) to display the tag options
- Press and hold (longer than one second) to activate the microphone and record an annotation

## LCDs

### Top Status LCD

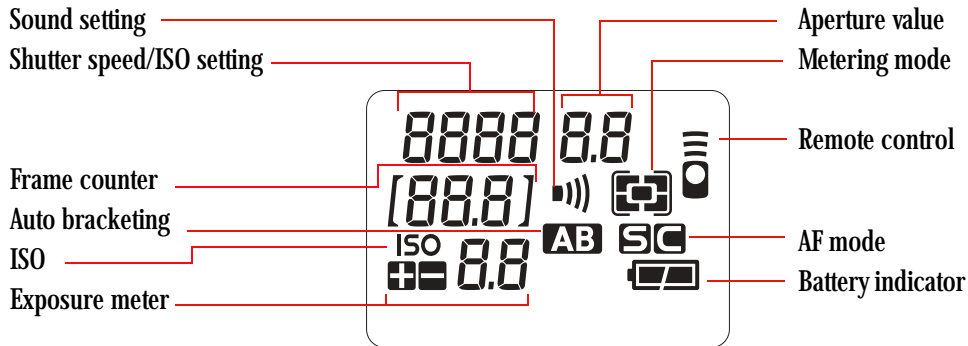

### Image LCD



Using the Image LCD you can:

- Conveniently evaluate and review images in the camera

**NOTE:** Occasionally there are a few pixels in the LCD that are either brighter or darker than the scene depicted. These pixels, few in number, do not affect the quality of the captured image. Furthermore, they do not affect the evaluation of a scene, the exposure or color of the image, or the control of the camera. You are able to fully utilize all the camera features and performance in this instance.

- Use tabbed menus to access digital functions

**NOTE:** The Image LCD screen shown here appears when the camera is in Advanced mode. In Basic mode only some of the information appears.

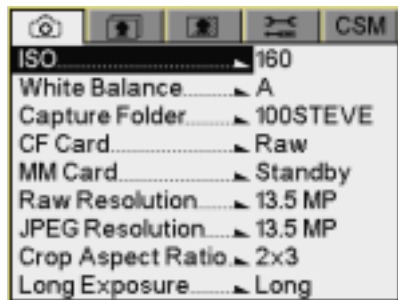



**Turning On the Image LCD** All of the buttons listed below turn on the Image LCD if it is off. Some of the buttons provide shortcuts to specific functions on the Image LCD.

**Browse images**—OK button, Nav+ button

**Navigate menus**—Menu button, Digital Status button (shortcut), Hotkey button (shortcut)

Digital Button	Displayed on Image LCD	Shortcut
OK	Last-accessed Image mode	
Nav+	Last-accessed (Single or Multiple) Image mode with Nav+ overlay	
Menu	Last-accessed menu with last-accessed menu option highlighted	
Digital Status	Menu with highlighted menu option for selected Digital Status LCD function (menu has a disabled appearance)	✓
Hotkey	Menu with highlighted menu option for first Hotkey position	✓

### Display Activation

If you use your right eye when capturing images, your nose may accidentally press one of the buttons on the left side of the camera (Nav+, Menu, Digital Status, or Hotkey). If you use your left eye when capturing images, your nose may accidentally press the OK button on the right side of the camera.

If this is a problem, you can disable the buttons so you don't accidentally turn on the Image LCD.

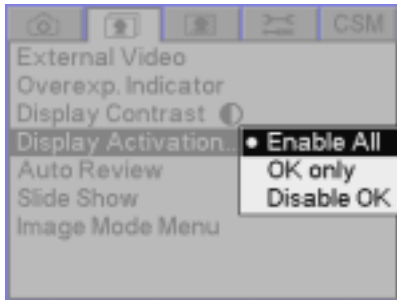

1. Press and hold the Menu button and press the right or left side of the Five-way control to highlight the Review menu.
2. Release the Menu button.
3. Press the top or bottom of the Five-way control to highlight the Display Activation option.
4. Press the right side of the Five-way control to display a the Display Activation menu. Press the top or bottom of the Five-way control to highlight one of the following:

**Enable All** - The buttons on the left and the OK button on the right can turn on the Image LCD.

**OK only** - The buttons on the left are disabled and cannot turn on the Image LCD.

**Disable OK** - The OK button on the right is disabled and cannot turn on the Image LCD.

5. Press the OK button.

### Turning Off the Image LCD

To turn off the Image LCD, press the Cancel button. If the Image LCD is not in Image mode, press the Cancel button more than once.

## Digital Status LCD

The Digital Status LCD provides the following information:

Status information	Capture-related information - interactive shortcuts to associated menu options on the Image LCD
	Review-related information
Helpful messages	Brief descriptions of highlighted menu options
	Brief procedural instructions

**Capture-related status information:** When the Image LCD is turned off, or when you lightly press the Shutter button, the Digital Status LCD displays capture-related information and provides shortcuts to associated menu options on the Image LCD.

**NOTE:** The Digital Status LCD shown here appears when the camera is in Advanced mode. In Basic mode only some of the information appears.

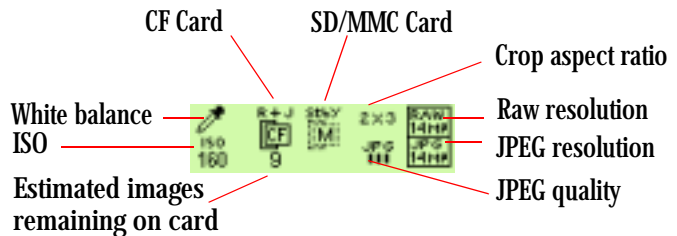

**Review-related status information:** When the Image LCD is in Image mode, the Digital Status LCD displays information about the selected image.

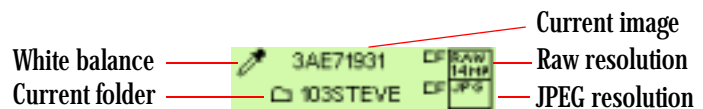

**Helpful messages:** As you perform operations, appropriate messages appear.

Quarter resolution JPEG:  
- 2 MB files to card.

L/R for hrs-min-sec  
U/D to change values.

## Using the Menus

Your camera provides a variety of digital functions. You can access these functions through the tabbed menus on the Image LCD. The tabbed menus are available in Advanced mode. In Basic mode there is a single menu with no tabs.

There are three ways to access the digital functions.

- Navigate through the tabbed menus to access all digital functions (see below).
- Shortcut to some digital functions using the Digital Status button and the Digital Status LCD (see [page 2-16](#)).
- Shortcut to some digital functions using the Hotkey button (see [page 2-17](#)).

There are five tabs. Each tab has an icon at the top representing the type of digital functions available on that tab.

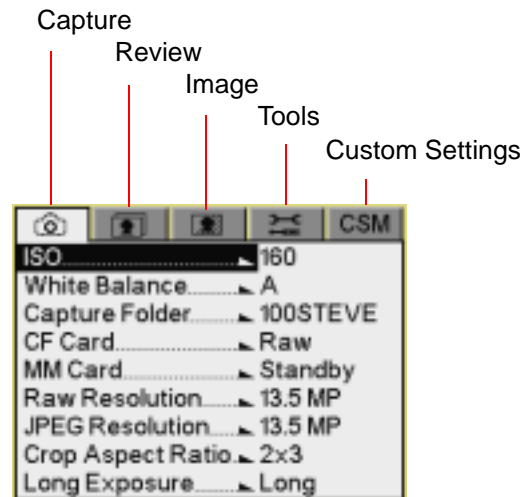

## Navigating Through the Menus

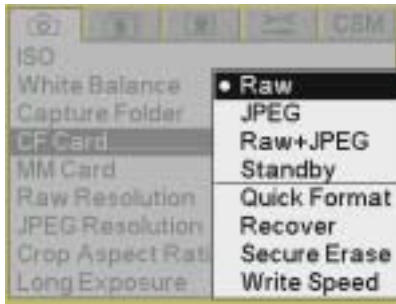

1. Press and hold the Menu button and press the right or left side of the Five-way control to highlight the tab containing the desired set of functions.
2. Release the Menu button.
3. Press the top or bottom of the Five-way control to highlight a menu option.
4. Press the right side of the Five-way control to display a cascaded menu with the options available for the highlighted menu option. Press the top or bottom of the Five-way control to highlight a menu option.  
In some cases there is a second cascaded menu. In this case, repeat step 4.
5. Press the OK button to implement your choice.

### Using the Digital Status Button and Digital Status LCD to Highlight Menu Options

The Digital Status button, the Digital Status LCD, and the Five-way control provide a shortcut to menu options on the Image LCD.

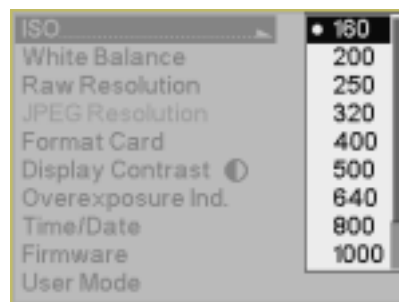
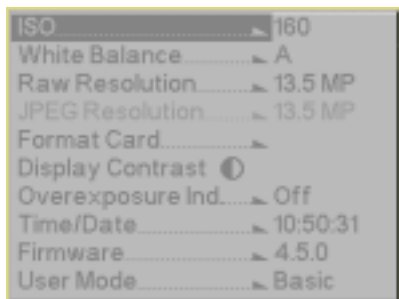

1. Press and hold the Digital Status button to highlight the last-used function on the Digital Status LCD, and highlight its associated menu option on the Image LCD. (The menu has a disabled appearance.)
2. To highlight a different option, continue to press and hold the Digital Status button. Press the right, left, top, or bottom of the Five-way control to sequence through the functions on the Digital Status LCD, and highlight the associated menu options on the Image LCD.
3. Release the Digital Status button to enable the menu option on the Image LCD.

## Using the Hotkey Button to Highlight Menu Options

The Hotkey button provides a shortcut to frequently used (user-definable) digital functions. You can change the Hotkey settings.

To access a function using the Hotkey button:

1. Press the Hotkey button to highlight the menu option associated with the first Hotkey position.
2. Press and hold the Hotkey button and press the right or left side of the Five-way control to display the menu option associated with the next or previous Hotkey position.
3. Release the Hotkey button to enable the menu option.

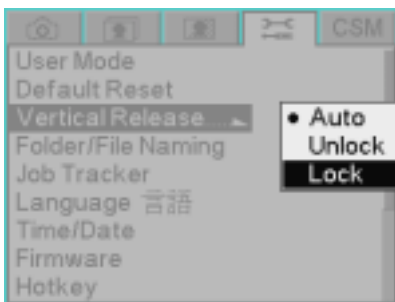
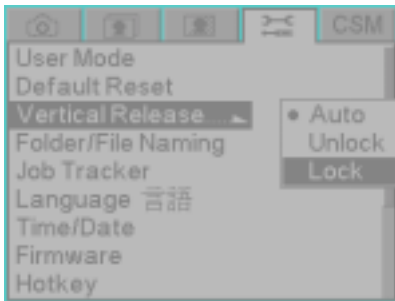

### Lens

Your camera uses CANON EF lenses or SIGMA lenses with a CANON EF mount (see [page B-1](#)).

### Mounting the Lens

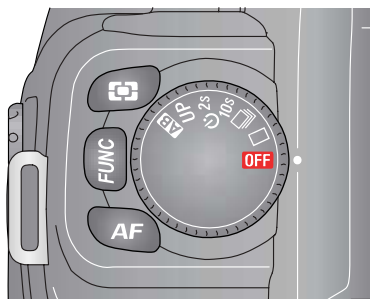

1. Turn the D-Dial to **OFF**.



2. Remove the camera's body cap and the lens' rear cap.

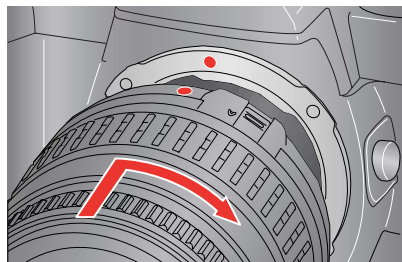

3. Align the red mark on the camera mount with the red dot on the lens. Insert the lens into the mount on the camera, and rotate the lens clockwise until it snaps into the locked position.

**NOTE:** To ensure proper connection, do not press the Lens Lock button while mounting the lens.



## Removing the Lens

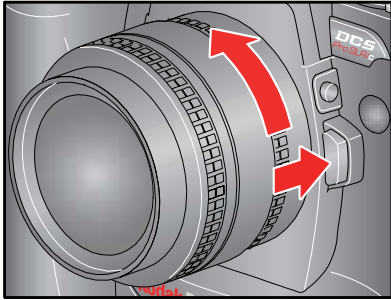

- Press the Lens Release button and turn the lens counterclockwise until it stops. Gently remove the lens from the camera body.

**NOTE:** On the mount surface of the lens, there are a number of electric contacts. Keep them clean to ensure proper connection. To avoid damaging them, put on the lens' rear cap when the lens is off the camera.

## Imager

Light from the scene you are photographing strikes the imager when the camera's shutter is open. The imager converts this light into a digital image. Your camera has an approximately 14 million pixel imager with an ISO range of 160 - 1600 (Raw files) or 160 - 800 (JPEG files).

## Shutter Button

The Shutter button has two positions. When you lightly press the Shutter button, the camera's Autofocus and Exposure Systems activate. When you then press the button all the way down, the shutter releases to capture an image.

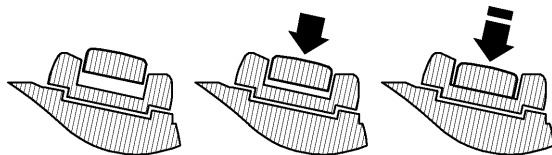

**NOTE:** Before you start to take pictures, you should become familiar with the light press position.

### Diopter Adjustment

Adjust the Viewfinder Diopter so that you can see clearly through the viewfinder.

- While looking through the viewfinder, slide the Diopter adjuster to the left or to the right, until the image appears sharp on the focus screen. The camera's adjustable diopter range is -3 to +1 dpt.

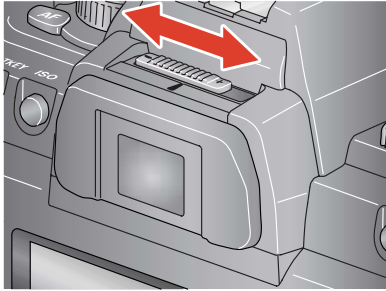

## Depth of Field Preview Button

The depth of field is the zone of acceptable focus in front of and behind the subject.

- Press the Depth of Field Preview button to confirm the depth of field through the viewfinder.

Pressing the Depth of Field Preview button stops the lens down to the aperture controlled in Programmed Auto or Shutter-Priority Auto Exposure mode, and down to the aperture selected in Aperture-Priority Auto or Manual Exposure mode. By looking through the viewfinder, you can confirm the approximate depth of field with the given aperture.

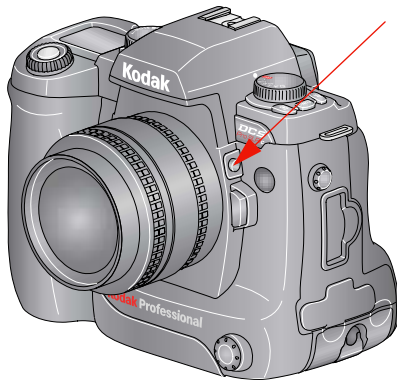

## Depth of Field

Your camera is equipped with autofocus where focusing is automatically executed.

When focusing, you should consider depth of field. Depth of field is the zone of sharpest focus in front of and behind the subject on which the lens is focused. Depth of field varies according to shooting distance, focal length, and especially aperture.

Smaller apertures (larger f-numbers) produce a deeper depth of field where the background and foreground become sharper. Larger apertures (smaller f-numbers) produce a shallower depth of field where the background becomes blurred.

Similarly, shorter shooting distance or longer focal length produce a shallower depth of field, and longer shooting distance or shorter focal length produce a deeper depth of field. Note that depth of field tends to be shallower in front of the subject in focus and deeper behind the subject.

**NOTE:** Confirm the depth of field with the Depth of Field Preview button.

### Hot Shoe

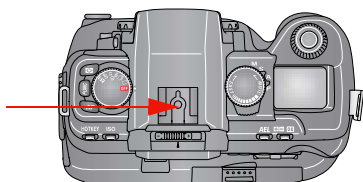

The Hot Shoe allows the mounting of electronic flash products and accessories. See [page 10-1](#) for a list of compatible flash units.



#### CAUTION:

**Do not use flash models other than those listed in chapter 10 since high sync voltages and/or extra hot shoe contacts can damage your camera.**

### PC Sync Terminal

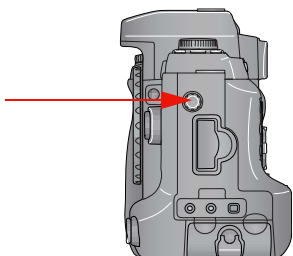

The PC Sync Terminal is compatible with flash sync cords with standard plug-in PC-type sync plugs.



#### CAUTION:

**Flashes with excessive trigger circuit voltage will damage your camera. Your camera is not compatible with sync voltages higher than 250V.**



#### WARNING:

***The PC Sync Terminal is for a flash sync cable system ONLY! Do NOT CONNECT AC MAIN POWER TO THIS CONNECTOR! Doing so can cause electric shock and can damage your camera.***

### Remote Release Accessory Port

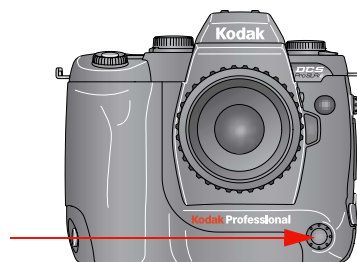

Use this port to connect the optional Remote Release cable.

## Viewfinder Cap

When using the Self Timer or the Remote Controller, cover the Viewfinder eyepiece with the Viewfinder cap to prevent stray light from entering the Viewfinder.

**NOTE:** Attach your Viewfinder cap to the neck strap (see [page 2-24](#)). The strap also helps prevent stray light from entering.

1. Remove the eyecup from the Viewfinder.

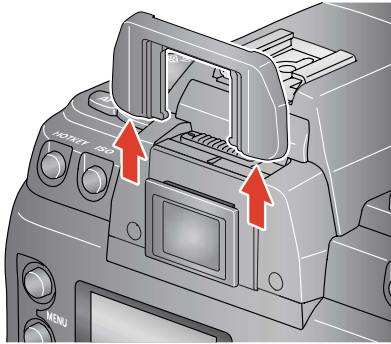

2. Attach the Viewfinder cap to the Viewfinder.

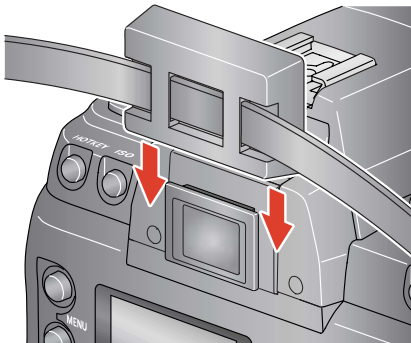

## Camera Straps

A neck strap and a hand strap are included with your camera. You can attach either or both.

### Attaching the Neck Strap

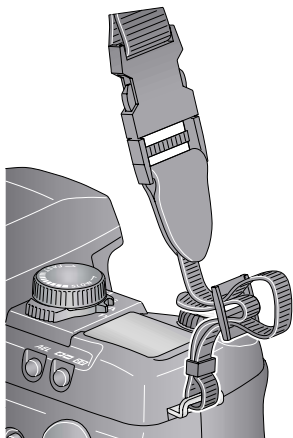

- Slide the Viewfinder cap (see [page 2-23](#)) on the neck strap then thread the ends of the neck strap through the camera strap eyelets. Pull firmly on the strap to make sure it is held securely by the buckles.

### Attaching the Hand Strap

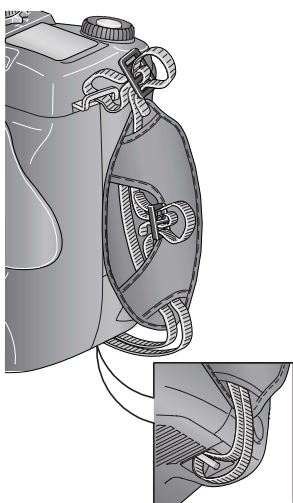

1. Thread the strap through both loops in the hand strap pad.
2. Place the three-holed buckle on the strap and thread through the camera's top strap eyelet.
3. Thread the other end of the strap through the camera's bottom strap eyelet.
4. Thread the top strap back through the buckle as shown.
5. Thread both ends of the strap back through the loops on the hand strap pad.
6. Place the two-holed buckle on the top strap.
7. Tuck the top strap through the bottom loop in the hand strap pad.
8. Thread the bottom strap through the two-holed buckle as shown.
9. Tuck the bottom strap through the top loop in the hand strap pad.

# 3 Powering Your Camera

The following items are included with your camera:

- KODAK PROFESSIONAL DCS Pro Battery (battery)
- KODAK PROFESSIONAL DCS Pro DC Power Module (power module)
- KODAK PROFESSIONAL DCS Pro Charger / AC Adapter (charger/adapter)
- CR 2032 coin cell battery (available at most battery retailers)
- International power cord set

**NOTE:** You can also operate your camera using a KODAK PROFESSIONAL DCS Pro 14n battery.

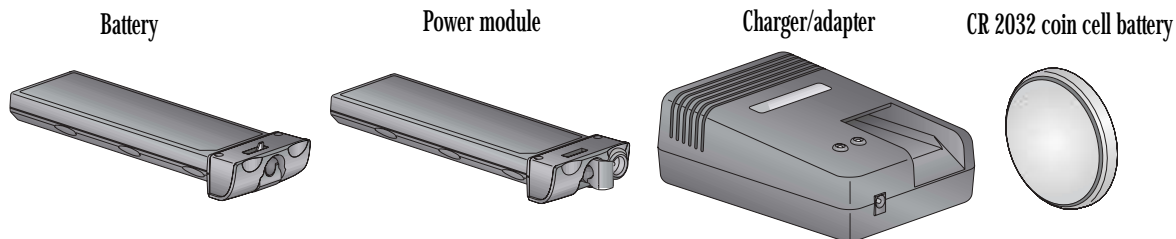

You can power your camera using either the power module or battery. When working in the studio, you will probably use the power module. When on location, use the battery.

When the power module cable is attached to the charger/adapter, the charger/adapter functions as an AC adapter. When the power module cable is not attached, use the charger/adapter to charge your battery.

The CR 2032 coin cell battery maintains the time and date when your camera is not powered.

### Powering Your Camera using the Power Module

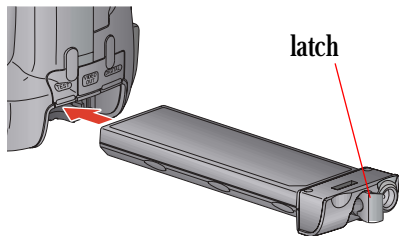

1. Insert the power module in the battery slot on the camera and turn the latch clockwise.

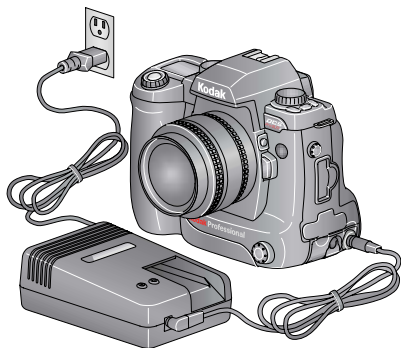

2. Insert the power module cable into the power module and into the port on the charger/adapter.
3. Using the appropriate international power cord, plug the charger/adapter into an electrical outlet.

The Power LED is green when the charger/adapter is powered.

**NOTE:** You cannot charge batteries while the power module cable is connected.

### Powering Your Camera using a Battery

#### Charging Batteries

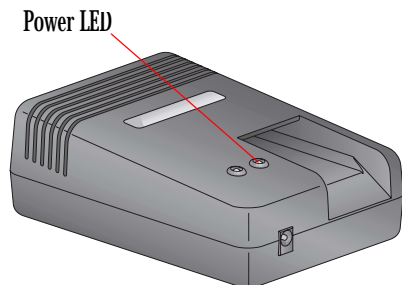

1. Remove the power module cable from the charger/adapter if it is connected.
2. Plug the charger/adapter into an electrical outlet.

The Power LED is green when the charger/adapter is powered.



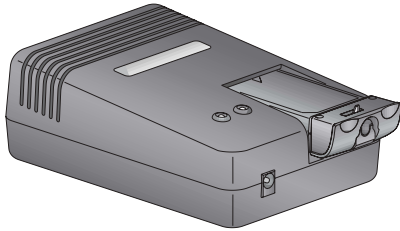

3. Insert a battery in the battery slot on the charger/adaptor.

The appearance of the Charging LED varies, depending on the status of the charging operation:

Color	Action	Charging Status
green	one blink	0 - 50% complete
green	two blinks	50 - 70% complete
green	three blinks	70%+ complete
green	constant	Charge complete
red	blinks about once / sec.	Charge pending
red	blinks rapidly	Error condition

4. Remove the battery when the charge is complete (the green light stays on constantly).
5. Let the battery cool down for 15 to 30 minutes. Put the battery in the charger again until the green light indicates that charging is complete.

**NOTE:** For optimum battery performance, periodically discharge the battery before charging.

## Powering Your Camera

### Inserting/Removing Batteries

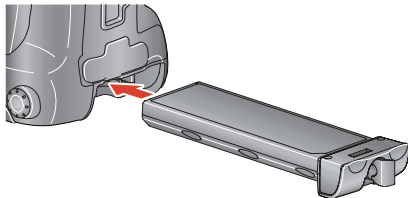

- To insert, slide a charged battery in the battery slot on the camera and turn the latch clockwise.

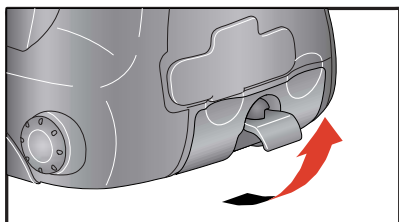

- To remove, lift the latch, turn the latch counterclockwise and slide the battery out.

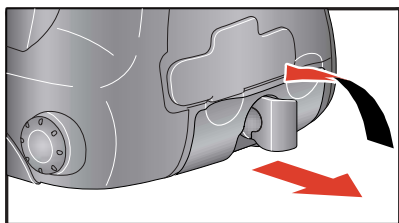

### Checking Battery Status

You can determine the charge status of an inserted battery by viewing the Battery icon on the Top Status LCD. When the icon blinks, you need to replace the battery. The shutter locks when the icon blinks.



Full



Low



Insufficient

## Conserving Batteries

Your camera has battery save features that do the following:

- Puts the camera into a low power mode if you don't touch any controls for a specified period of time (see [page 5-2](#)).
- Turns off the exposure meter if you don't touch any controls for a specified period of time (see [page 5-3](#)).
- Turns off the Image LCD if you don't touch any digital buttons for a specified period of time (see [page 5-2](#)).

To maximize battery performance, turn the camera off or remove the battery when not in use.

For more information on battery conservation, go to <http://www.kodak.com/go/DCS>.

NOTE: You can change the battery save time for the camera or Image LCD or change the Meter Off time (see [page 5-3](#)).

## Situations Using Extra Battery Power

- Use of a telephoto or wide-angle fisheye lens and constant autofocusing
- Frequent use of the Image LCD
- Cold temperatures
- Frequently turning the camera on and off
- Setting the Meter Off Time custom setting to Never

## Powering Your Camera

### CR 2032 Coin Cell

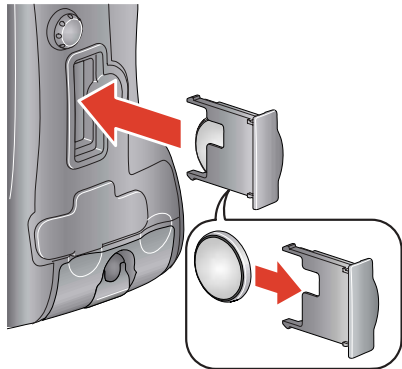

The included CR 2032 coin cell battery maintains the time and date on your camera when it is not powered. This battery has an average life span of one to two years. Purchase replacement batteries from your camera dealer.

1. Slide the coin cell into its carrier so that the + sign on the cell and the carrier are on the same side.

While you can force the cell in the other orientation, it will not work in your camera. Improper insertion will not damage your camera, but the time and date will not be maintained.

2. Slide the carrier into the carrier slot on the camera.

### Disposing of Batteries

For disposal or recycling information, please contact your local authorities or, in the U.S.A., the Electronics Industry Alliance: [www.eiae.org](http://www.eiae.org).



# 4 The Basics

This chapter describes the functions available in Basic mode and provides basic instructions for composing, focusing, and capturing images.

## Basic Mode

Your camera has two modes for accessing digital functions: Basic and Advanced modes. Using Basic mode you can change settings on some digital functions. All other digital functions are set to factory defaults. When you become familiar with your camera, change to Advanced mode and access the entire set of digital functions.

Basic mode functions include:

- ISO
- White Balance
- Raw Resolution
- JPEG Resolution
- Format Card
- Display Contrast
- Overexposure Indicator
- Time/Date
- Firmware
- User Mode

### Setting Basic Mode

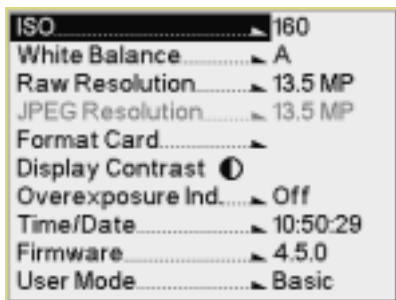

1. If the Image LCD is off, press the Menu button to turn it on.

If the Image LCD is on and images are displayed, press the Menu button to display the Basic Mode menu.

**NOTE:** If the screen at the left appears, the camera is already in Basic mode.

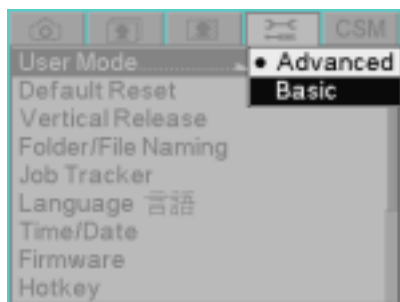

2. If a tabbed menu appears, the camera is in Advanced mode. To change to Basic mode, press and hold the Menu button, and press the right side of the Five-way control to highlight the Tools tab.
3. Press the top or bottom of the Five-way control to highlight User Mode.
4. Press the right side of the Five-way control to enable the User Mode menu.
5. Press the bottom of the Five-way control to highlight Basic.
6. Press the OK button.

The Basic Mode appears.

### Accessing Functions Using the Basic Menu

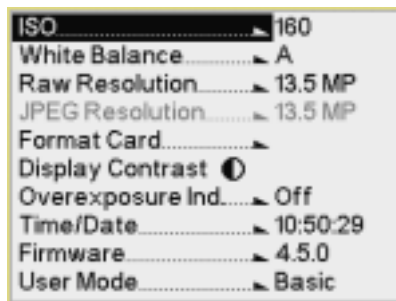

1. Press the top or bottom of the Five-way control to highlight a menu option.

If a pop-up menu appears, press the right side of the Five-way control to enable the menu, then press the top or bottom of the Five-way control to highlight a menu option.

2. Press the OK button.

## Digital Status LCD

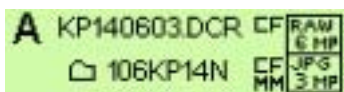

Quarter resolution JPEG:  
- 2 MB files to card.

L/R for hrs-min-sec  
L/D to change values.

## Using the Digital Status LCD to Highlight Menu Options

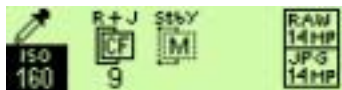
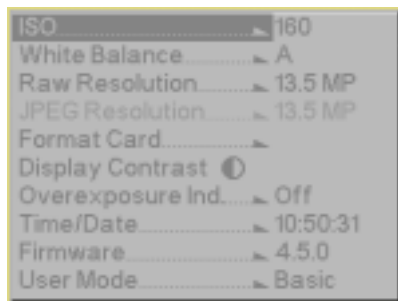

The Digital Status LCD displays shown here appear when the Basic menu is displayed. (In Advanced mode, additional information appears.)

**Capture-related status information:** When the Image LCD is turned off, or when you lightly press the Shutter button, the Digital Status LCD displays capture-related information and provides shortcuts to associated menu options on the Image LCD.

**Review-related status information:** When the Image LCD is in Image mode, the Digital Status LCD displays information about the selected image.

**Helpful messages:** When you highlight a menu option, a brief description appears. When you perform operations, brief procedural instructions appear.

The Digital Status LCD and the Digital Status button provide a shortcut to some menu options.

1. Press and hold the Digital Status button to highlight the last-used function on the Digital Status LCD and to highlight the associated menu option on the Image LCD. (The menu has a disabled appearance.)
2. Continue to press and hold the Digital Status button, and press the right or left of the Five-way control to sequence through the functions on the Digital Status LCD. This highlights the associated menu options on the Image LCD.
3. Release the Digital Status button to enable the menu option on the Image LCD.

### Setting ISO

ISO determines the sensitivity of the camera's imager to light. Increasing or decreasing the ISO increases or decreases sensitivity.

The ISO range is 160 - 1600 (Raw files), or 160 - 800 (JPEG files). See [page 6-4](#).

You can change the ISO setting in 1/3 stop increments.

1. Choose ISO from the Basic menu then highlight the desired setting.
2. Press the OK button.

#### Shortcut:

- You can also access this function using the Digital Status button and the Digital Status LCD.

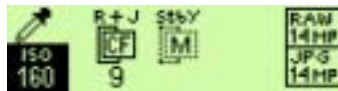
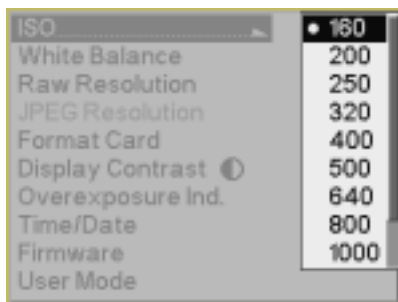

**NOTE:** You can also set ISO using camera controls (see [page 5-22](#)).



## Setting White Balance

White Balance adjusts an image to match the type of lighting used when capturing images. When you specify a White Balance option, that setting is applied to subsequently captured images.

White Balance options include Auto, Daylight, Tungsten, Fluorescent, and Flash.

### Shortcut:

- You can also access this function using the Digital Status LCD shortcut.

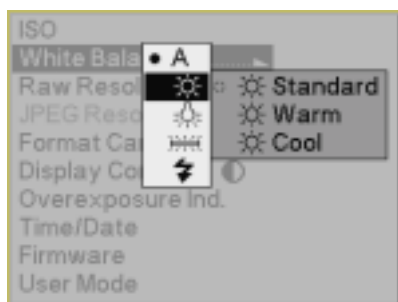

- Choose White Balance from the Capture menu, choose an option, then choose a setting.

	Options	Settings
	Auto	<ul style="list-style-type: none"> <li>Full Auto</li> </ul>
	Daylight	<ul style="list-style-type: none"> <li>Standard Daylight</li> <li>Warm Daylight</li> <li>Cool Daylight</li> </ul>
	Tungsten	<ul style="list-style-type: none"> <li>Standard Tungsten</li> <li>Warm Tungsten</li> <li>Cool Tungsten</li> </ul>
	Fluorescent	<ul style="list-style-type: none"> <li>Standard Fluorescent</li> <li>Cool White</li> </ul>
	Flash	<ul style="list-style-type: none"> <li>Standard Flash</li> <li>Warm Flash</li> <li>Cool Flash</li> <li>Studio Flash</li> </ul>

An approximate Kelvin temperature scale value associated with the selected Preset setting appears in the Digital Status display.

## Setting Raw Resolution

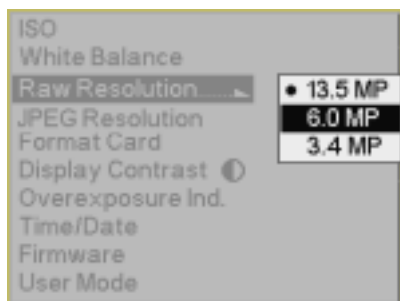

The three resolutions for Raw files are:

**13.5 MP**—Full-resolution Raw images (4500 x 3000)

**6.0 MP**—Half-resolution Raw images (3000 x 2000)

**3.4 MP**—Quarter-resolution Raw images (2250 x 1500)

1. Choose Raw Resolution from the Capture menu, then highlight a resolution.
2. Press the OK button.

**NOTE:** The number of pixels varies, depending on the crop aspect ratio.

### Shortcut:

- You can also access this function using the Digital Status LCD shortcut.

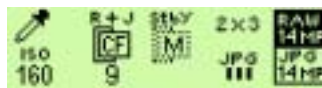

## Setting JPEG Resolution

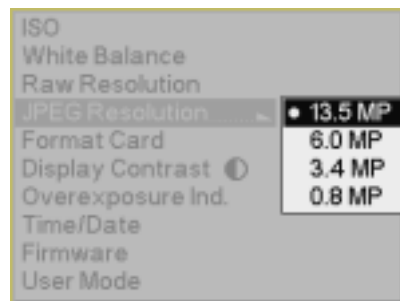

The four resolutions for JPEG files are:

**13.5 MP**—Full-resolution JPEG images (4500 x 3000)

**6.0 MP**—Half-resolution JPEG images (3000 x 2000)

**3.4 MP**—Quarter-resolution JPEG images (2250 x 1500)

**0.8 MP**—0.8 resolution JPEG images (1125 x 750)

1. Choose JPEG Resolution from the Basic menu, then highlight a resolution.
2. Press the OK button.

### Shortcut:

- You can also access this function using the Digital Status button and the Digital Status LCD.

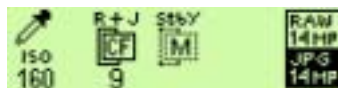

## Formatting a Card

Format a card if it was formatted incorrectly or if the data on the card becomes corrupted. If you have used a card for several sessions (for example, two or three dozen), you may want to format it on the camera you will be using so that the full capacity of the card is available. (Deleting images does not reclaim all space on the card.)

Cards are formatted in PC DOS format.

**NOTE:** In Advanced mode, both Quick Format and Secure Erase are available. In Basic mode, Quick Format is available.

1. Insert a card.
2. Choose Format Card from the Basic menu, then choose CF Card or MM Card.

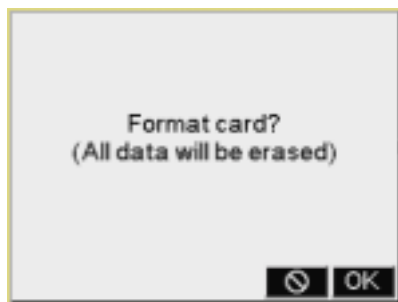
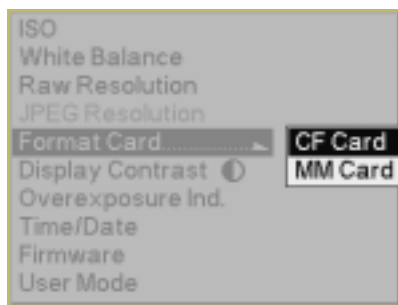

3. Press the OK button. (Press the Cancel button to close the confirmation screen without formatting the card.)

The Card Busy LCD and the Card icon on the Digital Status LCD blink during formatting. When the blinking stops, formatting is complete.

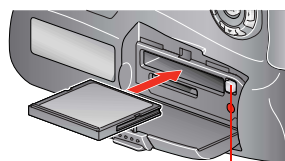

Card Busy LED

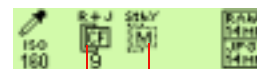

Card icons

### Shortcut:

- You can also access this function using the Hotkey shortcut.

### Changing the Display Contrast

You can change the contrast and lighten or darken the images displayed on the Image LCD.

**NOTE:** Changing the contrast does not affect the stored images, only the view of the images on the Image LCD.

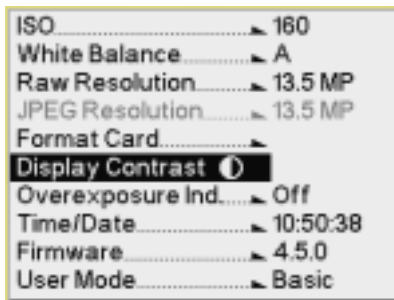

1. Choose Display Contrast from the Basic menu.

2. Press the OK button.

Two slider bars and a gray scale appear.

3. Press the top or bottom of the Five-way control to lighten or darken the displayed image.
4. Press the left or right of the Five-way control to adjust the displayed image's contrast.

Use the gray scale bar as a guide in adjusting contrast.

## Turning the Overexposure Indicator On and Off

You can indicate areas of overexposure in images in Single or Multiple Image Display modes.

1. Choose Overexposure Indicator from the Basic menu, then highlight On.

Highlight Off to turn the Overexposure Indicator off.

2. Press the OK button.

When the overexposure indicator is turned on, areas of overexposure flash on and off.

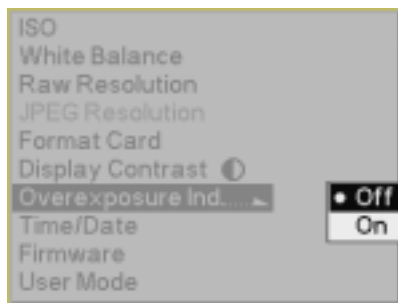

### Firmware

Firmware is the software program that runs within your camera and controls its operation. If a new firmware version becomes available, you can download it from the Kodak Web site and update the firmware in your camera.

**NOTE:** The first time you attempt to download KODAK PROFESSIONAL DCS firmware, you must supply an email address and register your camera. From then on, you only need to enter your email address on the DCS Firmware and Software page to obtain access to the firmware download page. If you are not skilled in web navigation, downloading files and opening compressed software files, you may want to ask for help from a friend who has experience.

### Checking the Firmware Version

You can view information about your current firmware version.

1. Choose Firmware from the Basic menu, then highlight the firmware version.

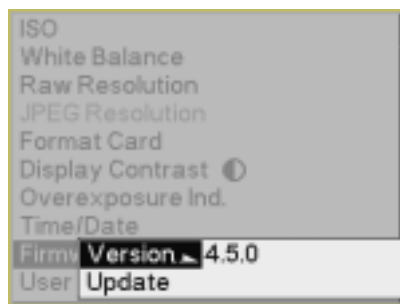

2. Press the OK button.



## Updating Firmware

1. Using your computer's web browser, go to [www.kodak.com/go/dcssoftware](http://www.kodak.com/go/dcssoftware).
2. Enter your email address and click the Continue button.
3. Register your camera if the registration page appears.
4. Select Firmware: DCS Pro SLR/c and click the Download Software button.
5. Read all of the information on the firmware download page. It contains important information about the firmware update, including data about compatible KODAK PROFESSIONAL DCS host software, bug fixes, new features and other pertinent information.
6. Select the download file for your operating system. For WINDOWS machines, click the filename ending in .exe. For MACINTOSH machines, click the filename ending in .hqx.
7. Follow the instructions that appear.

**IMPORTANT:** *Pay attention to the filename and the location where the file is saved. You will need to find and access this file once the download is complete.*

8. **MACINTOSH:** The browser changes the .hqx file into a .sit file. Double-click the .sit file to expand it into a folder containing a readme file and a proslrc.bin file.

**WINDOWS:** Double click the downloaded .exe file and unzip the file to a folder on your computer. After unzipping, a readme.pdf file and a proslrc.bin file appear in the folder.

9. Read the information in the readme file.
10. Copy the firmware file (proslrc.bin) to the root directory of a memory card.

**IMPORTANT:** *You must update the camera firmware using a memory card. You cannot update the firmware using the IEEE 1394 interface.*

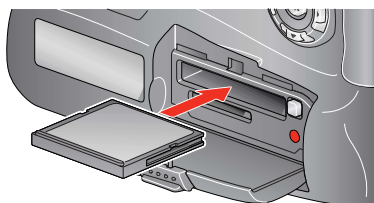

11. Insert the card straight into your camera.
12. Put a fully charged battery in your camera and turn the camera on.

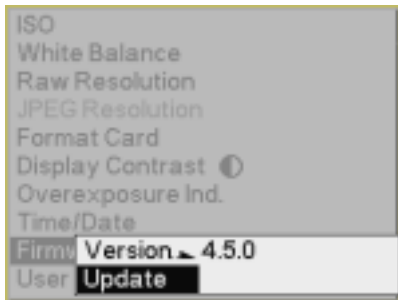

13. Choose Firmware from the Basic menu, then highlight Update.

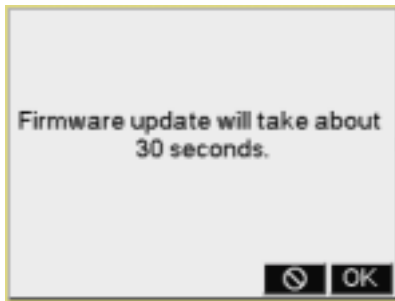

14. Press the OK button.

A progress screen appears while the firmware is updating. The update takes about 30 seconds.

**IMPORTANT:** *After the firmware has been written to the camera memory, the camera reboots and loads the new firmware. This may take up to fifteen seconds, during which time the camera does not appear to be functioning. Do not adjust camera controls or turn the camera off and on while the rebooting procedure is in progress.*

15. When the Image LCD turns back on, press the OK button to acknowledge the update message.
16. Repeat steps 12 - 14 to update the second firmware copy in your camera. When this second update completes, you will not receive the firmware update message.



## Setting the Time/Date

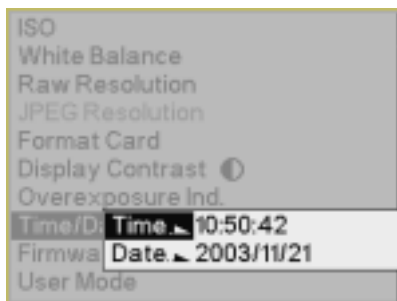

A time and date stamp is associated with each image file.

A CR 2032 coin cell battery maintains the time and date for approximately one to two years. If this battery loses its charge, you must replace the battery and reset the time and date.

1. Choose Time/Date from the Basic menu.
2. Press the right or left side of the Five-way control to select hours, minutes, or seconds. Press the top or bottom of the Five-way control to change the value.
3. Repeat step 2 for year, month, and day.
4. Press the OK button.

Shortcut:

- You can also access this function using the Hotkey shortcut.

## Setting User Mode

Follow the steps on [page 4-2](#) to choose Basic or Advanced mode.

### Using the Hotkey button to Highlight Menu Options

The Hotkey button provides a shortcut to frequently used digital functions. You cannot change Hotkey settings in Basic mode. Advanced mode provides five Hotkey positions and the option to change their settings. To access functions using the Hotkey while in Basic mode, the functions must be assigned to Hotkey positions in Advanced mode (see [page 5-9](#)).

To access a function using the Hotkey button:

1. Press the Hotkey button to highlight the menu option associated with the first Hotkey position.
2. Press and hold the Hotkey button, and press the right or left side of the Five-way control to highlight the menu option associated with the next or previous Hotkey position.
3. Release the Hotkey button to enable the menu option.

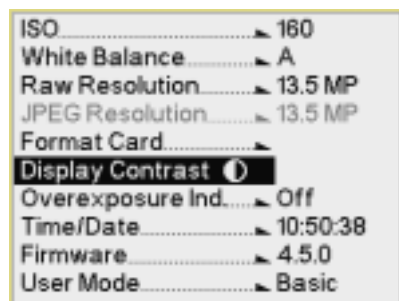
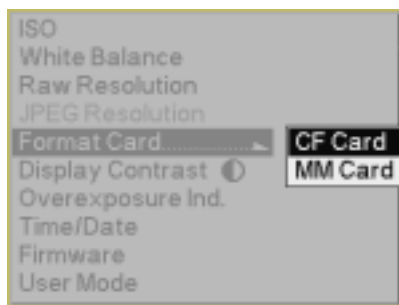

## Composing, Focusing, and Capturing Images



1. Hold the camera properly.
  - Use your left hand to cradle the camera with your elbow propped against your body for support.
  - Grasp the camera hand grip with your right hand.
  - Stand with one foot forward a half step and keep your upper body still.

2. Center your subject in the Viewfinder and lightly press the Shutter button.

If the subject is in focus, the focus indicator ● appears in the viewfinder.

If the camera cannot focus using autofocus, the focus indicator blinks. Use Manual focus.

### Tips:

- To capture a subject outside the focus area, shift the focus area or use Focus Lock (see [page 8-5](#)).
- See [page 8-2](#) for situations where autofocus may produce unexpected results.

3. Slowly press the Shutter button.

NOTE: You can capture images in a vertical orientation (see [page 5-18](#)) using Advanced mode (see [page 4-2](#)).

NOTE: The last three digits of the image number appear on the Top Status LCD in the Frame Counter location.



# 5 Configuring your Camera

This chapter describes features and methods for configuring your KODAK PROFESSIONAL DCS Pro SLR/c Digital Camera (DCS Pro SLR/c). Access most of the tools through the Tools menu on the Image LCD. You must be in Advanced mode for the menus to appear. See below.

## Setting the User Mode

Your camera has two user modes:

**Advanced mode**—provides access to all digital functions

**Basic mode**—provides access to some digital functions.

- If the camera is in Advanced mode, choose User Mode from the Tools menu, then choose Basic.

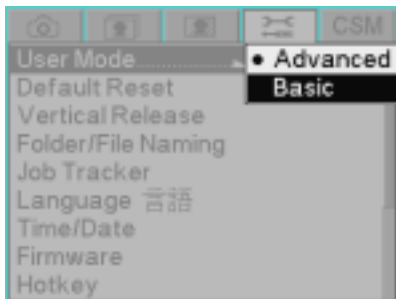

- If the camera is in Basic mode, choose User Mode, then choose Advanced.

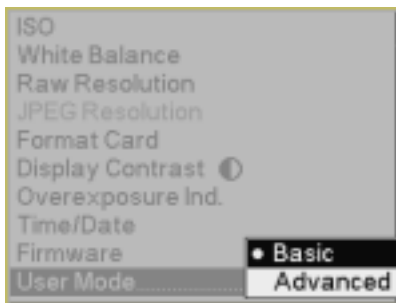

### Setting Battery Save

You can set separate battery save times for the camera and the Image LCD.

#### Camera

To conserve battery power, your camera goes into a low-power mode if not used for a specified amount of time.

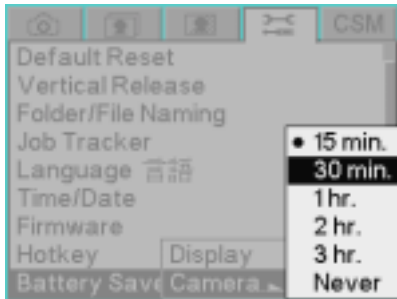

1. Choose Battery Save from the Tools menu, choose Camera, then highlight the desired time-out.
2. Press the OK button.

**NOTE:** When the Camera Battery Save time elapses, both the Image LCD and the Top Status LCD turn off. To exit the Battery Save state, turn the D-Dial to OFF, then turn it to Single Frame shooting. Alternatively, lightly press the Shutter Release button.

**NOTE:** If the camera has an IEEE 1384 connection to a computer that is turned on, the camera never enters the Battery Save state. As long as the IEEE 1394 connection remains, the camera stays "awake", checking to see if the DCS Camera Manager software is running on the computer.

#### Image LCD

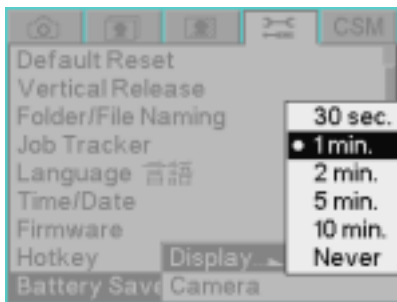

1. Choose Battery Save from the Tools menu, choose Display, then highlight the desired time-out.
2. Press the OK button.

The Image LCD turns off when the Display Battery Save time elapses.

## Custom Settings

You can change Custom Settings using the Custom Settings menu. See the table below for a complete list of custom settings.

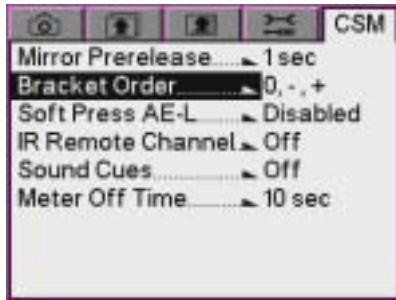

1. Choose the desired setting from the Custom Setting menu (CSM), then highlight an option.
2. Press the OK button.

### Custom Settings Table

Custom Setting	Description	Option
Mirror Prerelease	Time delay for Mirror Lock-Up function (see <a href="#">page 5-26</a> )	0.5 sec.
		1 sec. (default)
		2 sec.
		5 sec.
Bracket Order	Ordered sequence of frames for exposure bracketing	0, -, + (default)
		0, +, -
		-, 0, +
Soft Press AE-L	Auto Exposure Lock with soft press of Shutter button	Disabled (default)
		Enabled

Custom Setting	Description	Option
IR Remote Channel	Assignment of channels to infrared Remote Control	Off (default)
		1
		2
		3
Sound Cues	Assignment of sound cues to various camera functions  NOTE: You can also turn the AF Lock sound cue on or off using the Electronic Sound function (see <a href="#">page 5-30</a> ).	AF Complete <ul style="list-style-type: none"> <li>Off</li> <li>1 beep (default)</li> </ul>
		Card full <ul style="list-style-type: none"> <li>Off (default)</li> <li>1 beep</li> <li>2 beeps</li> <li>3 beeps</li> </ul>
Meter Off Time	Time delay for camera's exposure metering system to switch off	10 seconds (default)
		30 seconds
		1 minute
		5 minutes
		Never



## Firmware

Firmware is the software program that runs within your camera and controls its operation.

You can:

- View information about your current firmware version
- Download new firmware versions from the Kodak Web site and update the firmware in your camera (see [page 5-6](#))
- Enable optional firmware features

**NOTE:** You must register your camera (see [page 1-1](#)) before you can download firmware.

### Checking the Firmware Version

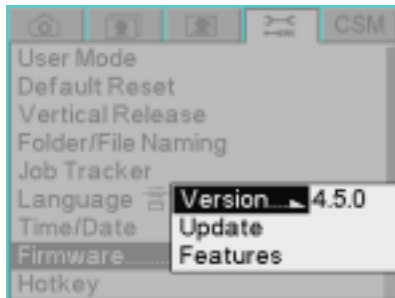

1. Choose Firmware from the Tools menu, then choose the firmware version.



2. Press the OK button.

### Downloading Firmware to your Computer

- On your computer, go to <http://www.kodak.com/go/dcssoftware> and follow the instructions.

### Firmware Features

A few specialized features are built into the firmware and are only available with a key.

To enable a firmware feature on your camera you must first purchase a kit containing instructions and a certificate number (one kit for each camera where firmware features are to be enabled). The included instructions describe how to enable the feature on your camera.

### Updating Firmware

1. Using your computer's web browser, go to <http://www.kodak.com/go/dcssoftware>.
2. Enter your email address and click the Continue button.
3. Register your camera if the registration page appears.
4. Select Firmware: DCS Pro SLR/c and click the Download Software button.
5. Read all of the information on the firmware download page. It contains important information about the firmware update, including data about compatible KODAK PROFESSIONAL DCS host software, bug fixes, new features and other pertinent information.
6. Select the download file for your operating system. For WINDOWS machines, click the filename ending in .exe. For MACINTOSH machines, click the filename ending in .hqx.
7. Follow the instructions that appear.

**IMPORTANT:** *Pay attention to the filename and the location where the file is saved. You will need to find and access this file once the download is complete.*

8. **MACINTOSH:** The browser changes the .hqx file into a .sit file. Double-click the .sit file to expand it into a folder containing a readme file and a proslrc.bin file.  
**WINDOWS:** Double click the downloaded .exe file and unzip the file to a folder on your computer. After unzipping, a readme.pdf file and a proslrc.bin file appear in the folder.
9. Read the information in the readme file.
10. Copy the firmware file (proslrc.bin) to the root directory of a memory

card.

**IMPORTANT:** *You must update the camera firmware using a memory card. You cannot update the firmware using the IEEE 1394 interface.*

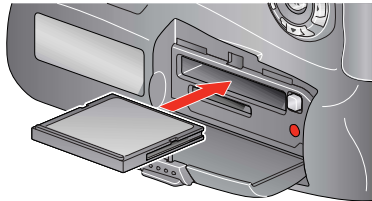

11. Insert the card straight into your camera.
12. Put a fully charged battery in your camera and turn the camera on.

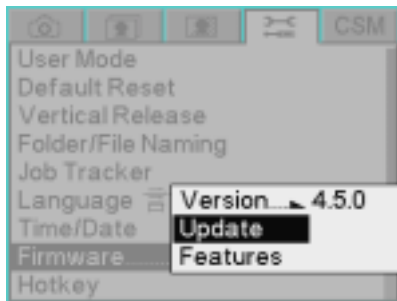

13. Choose Firmware from the Tools menu, then highlight Update.

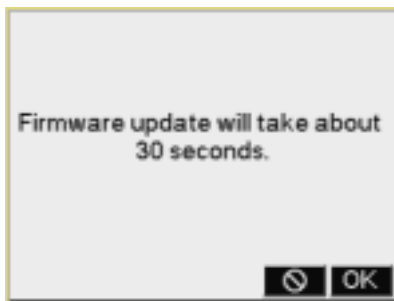

14. Press the OK button.

A progress screen appears while the firmware is updating. The update takes about 30 seconds.

**IMPORTANT:** *After the firmware has been written to the camera memory, the camera reboots and loads the new firmware. This may take up to fifteen seconds, during which time the camera does not appear to be functioning. Do not adjust camera controls or turn the camera off and on while the rebooting procedure is in progress.*

15. When the Image LCD turns back on, press the OK button to acknowledge the update message.
16. Repeat steps 12 - 14 to update the second firmware copy in your camera. When this second update completes, you will not receive the firmware update message.

### Folder and File Naming

You can choose how to number files and folders on the camera. You can also specify the maximum number of changes allowed in a folder.

**Continuous**—Names are assigned in a continuous sequence and are not reset to 0 when a new card is inserted.

**Auto Restart**—Names are reset to 0 when a new card is inserted.

**Manual Restart**—Names are reset to 0 on the current card or cards when you press the OK button.

**Folder Limit**—When the specified folder limit has been reached, no more images will be saved in a folder.

1. Choose Folder/File Name from the Tools menu, then highlight Continuous, Auto Restart, Manual Reset, or Folder Limit.
2. If you chose Folder Limit, choose 100 or 10000.
3. Press the OK button.

**NOTE:** You can also create and name new folders.

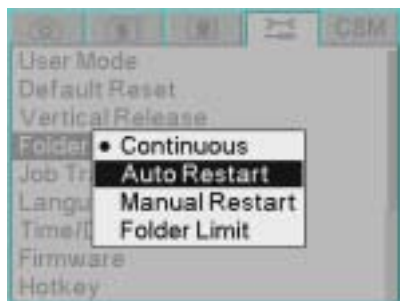

## Setting Hotkeys

Hotkeys provide shortcuts to frequently used digital functions. Your camera has built-in settings for five Hotkeys. You can clear settings or reset the Hotkeys to different digital functions, according to your own workflow.

**NOTE:** The Digital Status button provides shortcuts to specific capture-critical functions. Use Hotkeys for functions not already available through the Digital Status button.

1. Choose Hotkey from the Tools menu, choose Reset or Clear, then choose a Hotkey position (1 - 5).

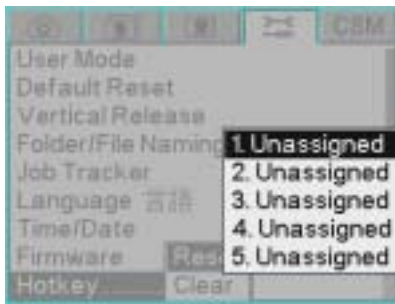

2. If you chose Clear, press the OK button. The Hotkey position will be unassigned.  
If you chose Reset, the instructions at the left appear. Press the OK button.
3. Navigate through the menus and highlight the function to be assigned.
4. Press the Hotkey button.

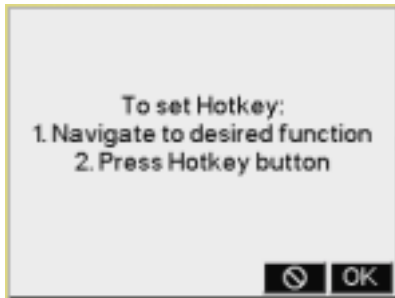

5. Press the OK button.



### Using Job Tracker

You can enter International Press Telecommunication Council (IPTC) data on your computer using KODAK PROFESSIONAL DCS Photo Desk Software, then load the data into camera memory where it can be included in image headers. The data follows the IPTC standard. Job tracker files have a .IPT extension.

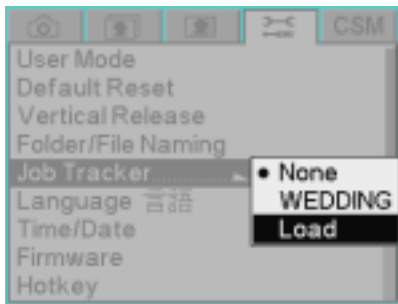

1. Choose Job Tracker from the Tools menu, then choose one of the following:

**None**—No job tracker data is written to the image headers.

**<job tracker file>**—Choosing this option writes the job tracker data from the active file to the header of subsequently captured images. This file must have been previously loaded. If no file has been loaded, this option does not appear in the menu.

**Load**—There can be one active job tracker file at a time. This file can be loaded from a memory card or from camera memory.

2. Press the OK button.

### Saving a Job Tracker File to a Card

You create and save job tracker files on the computer. Do the following to save a job tracker file to a card so that it can be loaded in your camera:

#### On the computer:

1. Place a CF card in the computer's card reader.
2. Using KODAK PROFESSIONAL DCS Photo Desk Software, save the .IPT file to the card.

Alternatively, you can save the file to your hard drive and copy it to a card later.

## Loading a Job Tracker File from a Card

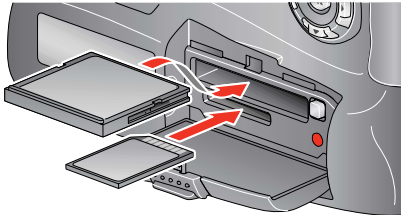

1. Insert the card in the camera.

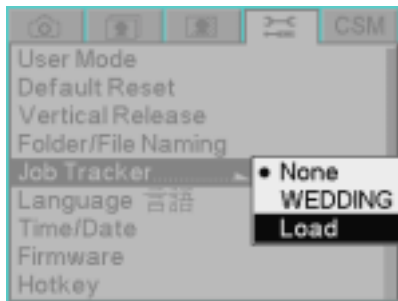

2. Choose Job Tracker from the Tools menu then highlight Load.

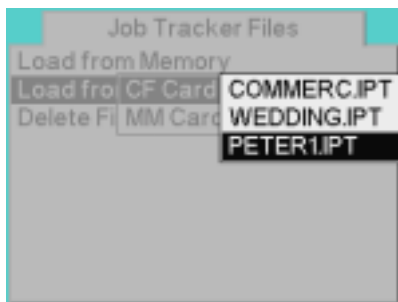

3. Choose Load from Card.

If you chose Load from Card and there are two cards in the camera, highlight a card.

4. Highlight the file to be loaded.

5. Press the OK button.

The file is loaded into camera memory and becomes the active job tracker file.

## Configuring your Camera

### Loading a Job Tracker File From Camera Memory

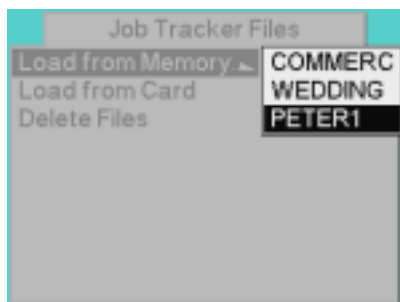

1. Choose Job Tracker from the Tools menu then highlight Load.
2. Choose Load from Memory then highlight a file.
3. Press the OK button.

The file becomes the active job tracker file.

### Selecting a Language

You can select the language that appears in the Image LCD and Digital Status LCD (English, Japanese, French, Italian, German, Spanish, Simplified Chinese, Portuguese, or Korean).

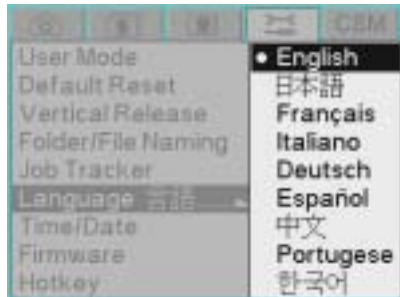

1. Choose Language from the Tools menu then highlight a language.
2. Press the OK button.



## Resetting Defaults

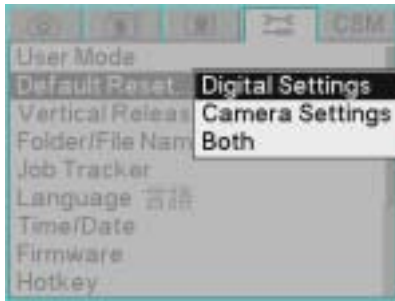

You can restore digital settings and camera settings to the factory defaults.

1. Choose Default Reset from the Tools menu, then highlight Digital Settings, Camera Settings, or Both.
2. Press the OK button.
3. Press the OK button to accept the change and dismiss the confirmation screen.

### User Setups

Using User Setups, you can save a "snapshot" of camera settings and menu options. You can then select this collection of settings and the camera is configured accordingly.

User Setups are useful when more than one individual uses the same camera. Each user can save their preferences for easy reuse.

User Setups are also useful for different applications, for example, setups for wedding ceremony, wedding reception, wedding family shots, or wedding outdoor scenes.

You can transfer setups from one KODAK PROFESSIONAL DCS Pro SLR/c Digital Camera (DCS Pro SLR/c camera) to another (see [page 5-17](#)).

### Creating a New User Setup

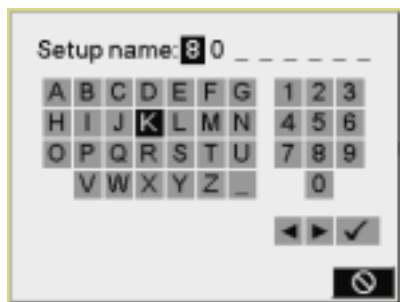

1. If there are ten setups saved in camera memory, delete one or more to make room for the new setup (see [page 5-16](#)).
2. Prepare your camera with the settings to be saved.
3. Choose User Setups from the Tools menu, then choose New.
4. This screen appears where you can name the setup. Enter a name (up to eight characters). Trailing underscores are dropped.
  - a. To enter a character, press the right or left side of the Five-way control to highlight the character, then press the OK button.
  - b. To change a character, highlight > or <, then press the OK button to move to the next or previous character in the folder name.
  - c. When finished, highlight ✓ and press the OK button.
5. Press the OK button.

The setup is saved to camera memory.

## Saved Setups

You can do the following with saved setups:

- Load a setup from a memory card into camera memory
- Save a setup from camera memory to a memory card
- Delete setups from camera memory

**Loading a Setup from a Card** You can load a setup from the root directory of a memory card into camera memory. This setup might have been saved on your camera or on a different DCS Pro SLR/c camera.

1. If there are ten setups saved in camera memory, delete one or more to make room for the new setup (see [page 5-16](#)).
2. Insert the memory card containing the setting to be loaded (see [page 6-2](#)).
3. Choose User Setups from the Tools menu, then choose Saved.
4. Choose Load From Card, choose CF Card or MM Card, then choose the setting to be loaded.
5. Press the OK button.

The setup is loaded into camera memory and the camera is configured to that setup.

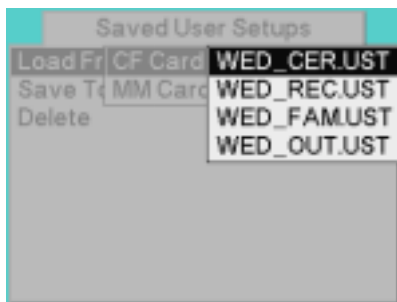

## Saving a Setup to a Card

Once a setup is in camera memory, you can save it to a card.

1. Insert a memory card (see [page 6-2](#)).
2. Choose User Setups from the Tools menu, then choose Saved.
3. Choose Save to Card, then choose the setting to be saved.
4. Press the OK button.

The setup is saved to the card's root directory.

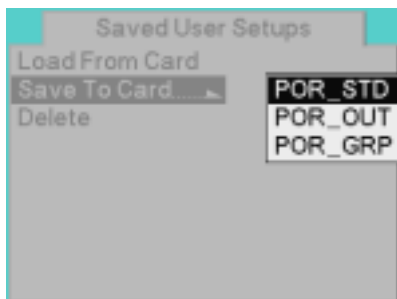

## Configuring your Camera

### Deleting Setups from Camera Memory

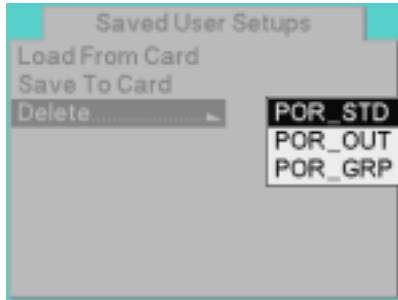

You can save up to ten setups in camera memory. If there are already ten setups saved, you must delete one or more setups before new setups can be saved or loaded.

1. Choose User Setups from the Tools menu, then choose Saved.
2. Choose Delete, then choose the setup to be deleted.
3. Press the OK button.
4. Press the OK button again to respond to the confirmation screen.

### Selecting a User Setup



You can select setups that are in camera memory. Once selected, the camera is configured according to that setup.

1. Choose User Setups from the Tools menu, then choose the desired setup.
2. Press the OK button.

It takes about two seconds for the camera to be configured to the new setup.

### Editing an Existing Setup

1. Select a User Setup.
2. Change camera settings, as needed.
3. Create a new User Setup (see [page 5-14](#)).
4. When the name entry screen appears, it shows the current setup name. Highlight ✓ and press the OK button.

The setup is changed and saved to memory. (You can save it to a card, if needed.)

## Using Setups on More than One Camera

Most settings are transferred when you load User Setups that have been saved to a card using a different DCS Pro SLR/c camera. The exceptions are Click Balance and Job Tracker settings, but you can work around these exceptions.

Before saving a User Setup on one camera and loading it on another:

1. Set up Click Balance identically on both cameras.
  - a. Capture the same image using both cameras, then perform the same Click Balance on both images (see [page 7-3](#)).
  - b. Save the Click Balance setting (see [page 7-6](#)). The settings must have the same names on both cameras.
  - c. Repeat for all need Click Balance settings.
2. Load identical Job Tracker files into the memory of both cameras (see [page 5-10](#)). The settings must have the same names on both cameras.

**NOTE:** If the Job Tracker file named in the User Setup is no longer in camera memory, Job Tracker will be disabled.

## Time and Date

A time and date stamp is associated with each image file.

Inside your camera, a CR 2032 Coin Cell battery maintains the time and date for one to two years. If this battery loses its charge, you must replace the battery and reset the time and date.

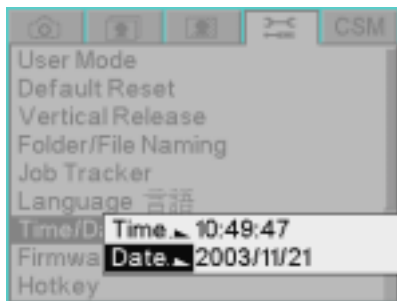

1. Choose Time/Date from the Tools menu, then choose Time or Date.
2. If you chose Time, press the right or left side of the Five-way control to select hours, minutes, or seconds. Press the top or bottom of the Five-way control to change the value.  
If you chose Date, press the right or left side of the Five-way control to select year, month, or day. Press the top or bottom of the Five-way control to change the value.
3. Press the OK button.

### Using the Vertical Release

You can lock or unlock the camera's vertical shutter release or set it to Auto.

**Auto**—The vertical shutter release operates when the camera is in portrait orientation (turned 90° clockwise or counterclockwise).

**Unlock**—The vertical shutter release operates when the camera is in any orientation.

**Lock**—The vertical shutter release does not operate.

1. Choose Vertical Release from the Tools menu, then choose Auto, Unlock, or Lock.
2. Press the OK button.

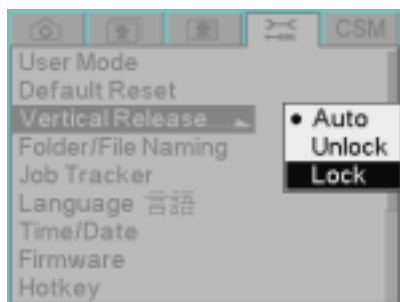

## Long Exposure

You can enable or disable a long exposure feature on your camera. When enabled, this feature reduces noise in long exposures.

The choices are:

**Off**—If you use a long shutter speed to capture an image while this feature is Off, a message suggests that you enable it.

**Long**—Suggested for exposures up to 1/2 sec.

**Longer**—This choice allows you produce high quality images during longer exposures by specifying an ISO and a shutter speed setting. Use Longer with either the Manual or Shutter Speed Priority AE exposure mode.

1. Choose Long Exposure from the Capture menu.
2. Choose Off, Long, or Longer.
3. Press the OK button.

If you chose Off or Long, the setting has been changed.

If you chose Longer, the following screen appears:

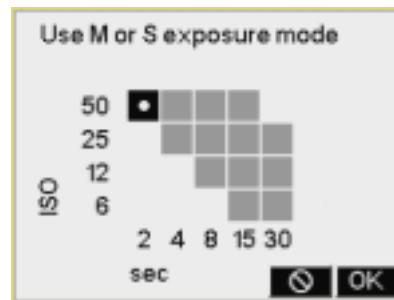
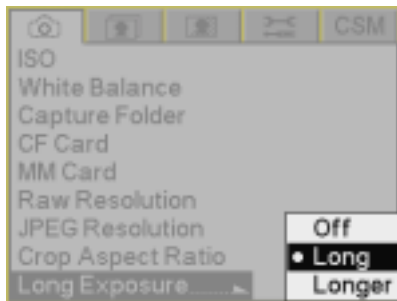

- a. Press the top or bottom of the Five-way control to change the ISO setting. Press the left or right of the Five-way control to change the shutter speed setting. (In the example above, ISO is set to 50 and shutter speed is set to 2 seconds.)

**NOTE:** While Longer is enabled, its exposure settings override the existing exposure setting. Do not change the exposure mode, shutter speed, or ISO setting using the camera controls.

- b. Press the OK button.

The camera's metering system is now enabled. Use the Viewfinder's Exposure meter for assistance when setting the aperture.

### Intervalometer

The Intervalometer automatically captures a sequence of images at specified intervals over a specified time period. You might use the Intervalometer to capture a flower bud opening or for unattended surveillance.

The Intervalometer is disabled automatically after the specified time period, even if the specified number of images have not been captured. For example, if you set the Intervalometer for 60 exposures at one second intervals, the buffer will eventually fill, and the camera cannot maintain the one second interval. The camera would stop capturing images after 60 (60 x 1) seconds even though 60 images had not been captured.

You can change the following Intervalometer settings:

**Enable**—Enable or disable the Intervalometer

**Count**—Number of images to be captured during the specified interval

**Interval**—Interval between exposures

**Delay**—Onset of the Intervalometer function

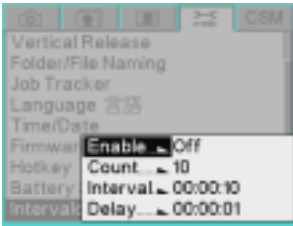
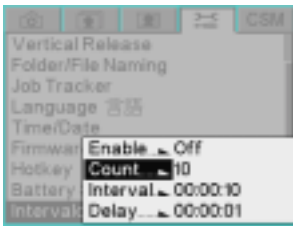
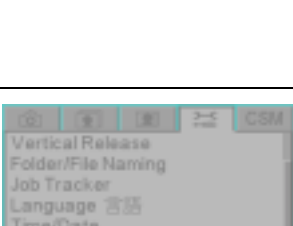
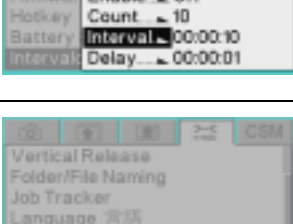

## Changing Intervalometer Settings

Option	Menu	Procedure	Range	Default
Enable		<ol style="list-style-type: none"> <li>1. Choose Intervalometer from the Tools menu, choose Enable, then highlight Yes or No.</li> <li>2. Press the OK button.</li> </ol>		
Count		<ol style="list-style-type: none"> <li>1. Choose Intervalometer from the Tools menu, then highlight Count. The current count appears with the first digit highlighted.</li> <li>2. Press the top or bottom of the Five-way control to change the first digit.</li> <li>3. Press the right of the Five-way control to highlight the next digit, then repeat step 2.</li> <li>4. Press the OK button.</li> </ol>	1 - 9999	10
Interval		<ol style="list-style-type: none"> <li>1. Choose Intervalometer from the Tools menu, then choose Interval.</li> <li>2. Press the right or left of the Five-way control to access hours, minutes, or seconds. Press the top or bottom of the Five-way control to change the number.</li> <li>3. Press the OK button.</li> </ol>	3 seconds to 23:59:59 (HH:MM:SS)	10 seconds
Delay		<ol style="list-style-type: none"> <li>1. Choose Intervalometer from the Tools menu, then choose Delay.</li> <li>2. Press the left or right of the Five-way control to access hours, minutes, or seconds. Press the top or bottom of the Five-way control to change the number.</li> <li>3. Press the OK button.</li> </ol>	1 second to 23:59:59 (HH:MM:SS)	1 second

### ISO

ISO sets the sensitivity of the camera system to light. Increasing or decreasing the ISO increases or decreases sensitivity.

The ISO range is 160 - 1600 (Raw files), or 160 - 800 (JPEG files). See [page 6-4](#).

You can change the ISO in 1/3 stop increments.

You can set ISO using the Image LCD (see below) or using camera controls.

#### Setting ISO using the Image LCD

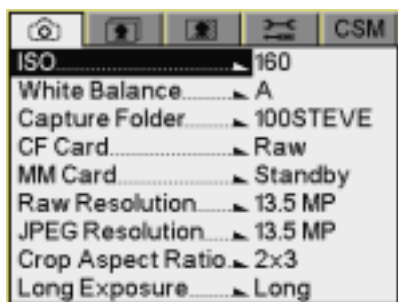

1. Choose ISO from the Capture menu, then choose the desired setting.
2. Press the OK button.

#### Shortcut:

- You can also access this function using the Digital Status LCD shortcut.

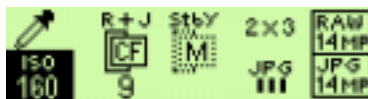

#### Setting ISO using Camera Controls

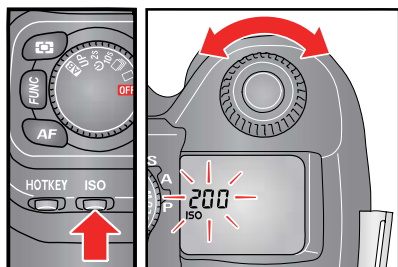

1. Press and hold the ISO button and rotate the C-Dial to select the ISO value. Release the button when the desired value appears.

The ISO settings are in 1/3 stop increments.

2. To confirm the ISO setting, press the ISO button.

The ISO icon and the current ISO setting appear in the Top Status LCD.

**NOTE:** A lower ISO setting generally produces images with less digital noise (compared with images with higher ISO settings). However, lower ISO image captures require slower shutter speeds, wider apertures, more light, or some combination of the three. The higher ISO settings provide greater photosensitivity, which is advantageous when capturing images in dim lighting conditions, but the images contain more noise. You must analyze the scene and the desired results when choosing the ISO setting.

## Drive Mode

### Drive Area of the D-Dial

Use the Drive area of the D-Dial to access the following functions: Mirror Lock-Up, Self Timer, Continuous shooting, and Single Frame shooting.

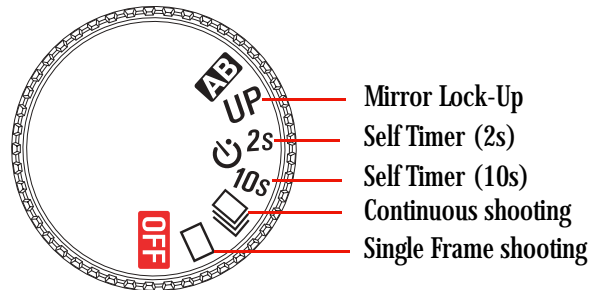

### Single Frame Shooting

When you press the Shutter button in Single Frame Shooting mode, only one image is captured. You must press the Shutter button for each image capture.



- Rotate the D-Dial to .

### Continuous Shooting

When you keep the Shutter button fully depressed in Continuous Shooting mode, the camera continuously captures images at the rate of 1.7 images/sec. (as long as there is room in camera memory).

- Rotate the D-Dial to .

#### Continuous Shooting Drive mode Notes:

- When AF mode is set to AF  (Single AF mode) mode and the focus indicator in the viewfinder is on, focus distance and exposure values are fixed at the setting for the first image. If the subject moves or the scene brightness changes, the lens focus and camera's exposure may not be correct for subsequent images. When AF mode is set to AF  mode (Continuous AF mode), the camera continuously focuses on the subject. However, you can release the Shutter button even if the Auto Focus function has not completed. Therefore, images may be out of focus.
- When you use Continuous Shooting mode with external flash on the Hot shoe, the camera's frame rate may slow down. This is because the camera will not capture images while the flash is re-charging.
- Images captured in rapid succession are initially stored in the camera's internal memory buffer. This lets you continue shooting without having to wait for images to be written to the CF card. The internal memory buffer can store about 20 images (at Raw 13.5 MP resolution). Once the memory buffer is full, the shutter will be disabled until some images have been transferred to the CF card.

## Self Timer

Use the Self Timer to include yourself in the picture or to avoid camera shake. Use a tripod or place the camera on a stable surface before using the Self Timer.

When you set the Self Timer to **10s**, the shutter will be released 10 seconds after you fully press the Shutter button.

When you set the Self Timer to **2s**, then the shutter will be released 2 seconds after you fully press the Shutter button.

After you compose the picture, lightly press the Shutter button and adjust the focus. When you fully press the Shutter button, the viewfinder display disappears and the Self Timer is activated. During the Self Timer countdown, you hear an electronic beeping sound which speeds up during the last two seconds. The Top Status LCD displays a countdown of the remaining time.

1. Rotate the D-Dial to either **2s** or **10s**.
2. If you are using an Exposure mode other than Manual, cover the eyepiece with the supplied viewfinder cap (see [page 2-23](#)) or with your hand before pressing the Shutter button. This helps achieve correct exposure by preventing interference from stray light.
3. Compose the picture, focus by lightly pressing the Shutter button, then fully press the Shutter button.

**NOTE:** Once the Self Timer is activated, the shutter releases in two or ten seconds. The electronic sound operates during Self Timer operation, even if you set the Electronic Sound option to OFF.

## To Cancel the Self Timer

- Rotate the D-Dial to another position.

### Mirror Lock-Up

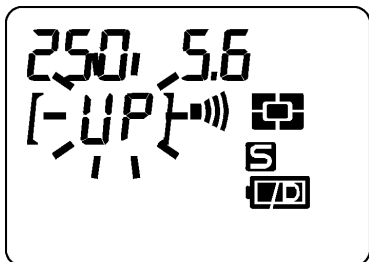

The Mirror Lock-Up function raises the mirror, but delays tripping the shutter until after a fixed delay. Use Mirror Lock-Up when performing close-up photography or when using a long telephoto lens.

1. Rotate the D-Dial to **UP**.
2. Lightly press the Shutter button to set autofocus and exposure.
3. Fully press the Shutter button.

The mirror raises and the exposure values are fixed.

4. Release the Shutter button.

After a fixed time interval, the image is captured and the mirror returns home. See [page 5-3](#) for information on setting the time interval of the Mirror Prerelease function.

#### Notes:

- You can use Mirror Lock-Up with the IR Remote Controller (see [page 5-27](#)).

## Remote Controller

With this included accessory you can release the camera's shutter from up to 16 ft (5 m) away from in front of the camera, or up to 9.8 ft (3 m) away if you are 30 degrees to either side. (Depending on the lens, there may be some restrictions when using it from the left side of the camera.)

**NOTE:** Before using the Remote Controller, cover the Viewfinder eyepiece with the Viewfinder cap (see [page 2-23](#)) to prevent stray light from entering the viewfinder. The Remote Controller already has batteries installed.

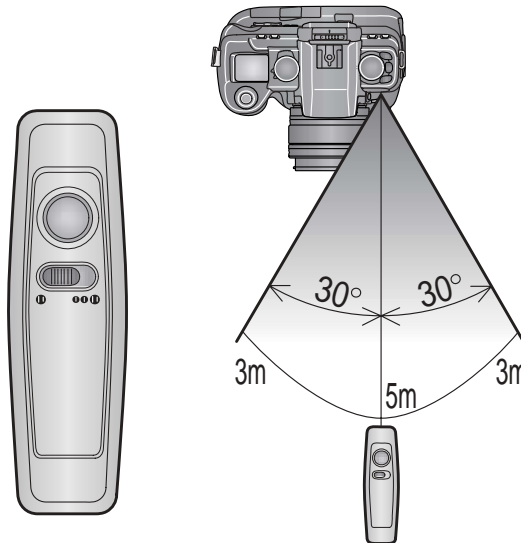

## Setting the Remote Controller

On the Remote Controller:

1. Select the delay time.

If you select ●, the shutter releases immediately after you press the the Transmit button.

If you select ●●●, the shutter releases 3 seconds after you press the the Transmit button. The electronic sound beeps during the 3 second countdown.

2. Select channel 1, 2, or 3 by sliding the switch on the side of the Remote Controller.

### Setting the Camera to Remote Control Mode

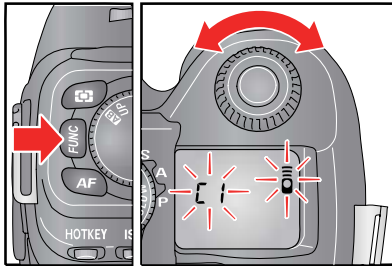

When using the Remote Controller, use either AF or Manual focus to set the lens focus for the scene, then switch the lens to the MF position. If the lens is left in AF, the camera performs an autofocus when it receives the signal from the Remote Controller and you will not be able to verify the correct focus.

1. Press and hold the FUNC button.

The Top Status LCD shows the  mark.

2. Continue pressing the FUNC button and rotate the C-Dial to select the channel (same channel as the Remote Controller). Release the FUNC button.

After you set the channel, the  mark appears on the Top Status LCD.

3. Check that the subject is framed correctly.
4. Lightly press the Shutter button to set the focus, then set the lens switch to MF.
5. Point the transmitting diode at the camera and press the Transmit button.

#### Notes:

- The Remote Controller cannot be used with Continuous Shooting mode. If the D-Dial is set to Continuous Shooting, the camera captures only a single image for each activation by the Remote Controller.
- The Remote Controller may not work properly if strong sunlight is shining directly on the camera's remote control sensor.
- The camera's Meter Off time changes to a fixed five minutes when Remote Control mode is enabled. To reactivate the camera, lightly press the Shutter button.
- After capturing the image, repeat steps 1 and 2 (above), choosing - - to cancel the remote control function.

### Cancelling Remote Control Mode



## Using the Mirror Lock-Up with the Remote Controller

When using Mirror Lock-Up mode with the Remote Controller, use either AF or Manual focus to set the lens focus for the scene, then switch the lens to the MF position. If the lens is left in AF, the camera performs an autofocus when it receives the signal from the Remote Controller, and you will not be able to verify the correct focus.

1. Rotate the D-Dial to **UP**.
2. Set the camera to Remote Control mode.
3. Lightly press the Shutter button to set the focus, then set the lens switch to **MF**.
4. Aim the Remote Controller at the camera's Remote Control sensor and press the Transmit button.

After a fixed time interval, the image is captured and the mirror returns home. See [page 5-3](#) for information on setting the time interval of the Mirror Prerelease function.

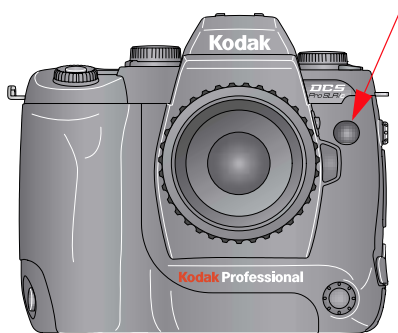

## Replacing the Remote Controller Battery

Use two CR 1220 3V Lithium coin type batteries.

1. Remove the bottom cover screws with a screwdriver.
2. Open the bottom cover and replace the batteries.
3. Replace the cover and tighten the screws. Be careful not to over-tighten.

Check the Remote Controller operation after replacing the batteries.

### Setting the Electronic Sound

Your camera can emit a beep for a variety of functions. This section discusses setting the focus confirmation beep. The Sound Cues Custom function (see [page 5-3](#)) provides information on the other functions.

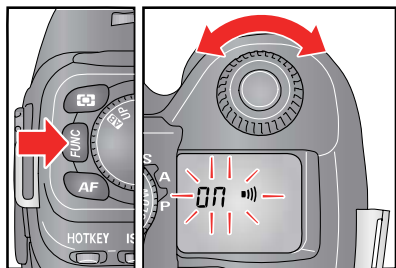

1. Press the FUNC button two times (press and hold the button the second time). The Top Status LCD shows a  .
2. While continuing to press the FUNC button, rotate the C-Dial until **On** appears in the Top Status LCD.

To cancel the focus confirmation Electronic Sound, choose " - - ".

**NOTE:** You can also turn Electronic Sound on or off, and specify the number of beeps using the Sound Cues Custom Setting (see [page 5-3](#)).

**NOTE:** The camera beeps when focus is confirmed (when the Viewfinder Focus indicator illuminates).

#### Tips:

- When the  appears in the Top Status LCD, the focus confirmation Electronic Sound function is on.
- You cannot turn off the Electronic Sound when using the Self Timer or the Remote Controller with the 3 second delay.

## Lens Optimization

### Overview

Some lenses produce a color shift in the corners of images. Your camera has a feature that corrects this color shift to create a more uniform image. There are three methods for controlling the strength of this correction.

**Method one: Auto**—(see [page 5-32](#)) This method automatically determines the correction strength for each image based on analysis of the image data. This feature works with most lenses and may be the only method you ever need to use. When the camera is in Auto, all of the work is done for you.

**NOTE:** The Auto method is recommended if your images are not showing anomalies.

**Method two: Manual**—(see [page 5-33](#)) This method allows you to directly input the correction strength. This method is provided for testing, and is not for daily use.

**Method three: Lens Selection**—(see [page 5-33](#)) This method determines the correction strength by selecting the specific lens you are using. Since the camera cannot uniquely identify every lens attached, you must select the lens from a list. Your camera contains a master list of commonly used, current model lenses from several manufacturers. You can easily add additional lenses to the master list. There is a conveniently accessible user list for the lenses you use most often. The camera can usually automatically identify and select the current lens if it is in the user list. It is easy to maintain this list by adding and removing lenses.

The master list includes default correction strengths for each lens. Sometimes these defaults are not ideal. You can adjust the strength for any lens in the master list. If you define new lenses (see [page 5-39](#)), you will need to set the strengths for them as well.

We recommend that you try the Auto method first and only use the Lens Selection method if you are not satisfied with the results of the automatic optimization.

## Configuring your Camera

### Selecting the Method of Lens Optimization

There are three methods for optimizing your lens:

#### Auto



1. Choose Lens Optimization from the Capture menu.



2. Choose Auto.
3. Press the OK button.

**NOTE:** Auto is the factory default. If you reset defaults (see [page 5-13](#)), the camera resets to the Auto method.

## Manual

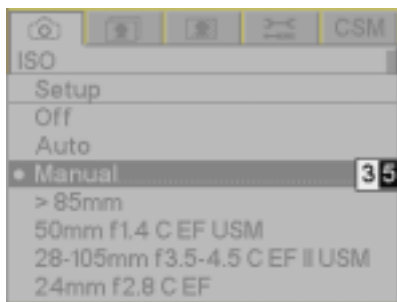
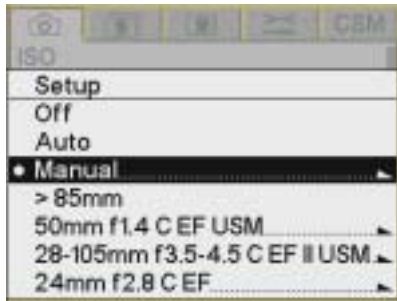

1. With the appropriate lens mounted on the camera, determine the optimum strength for the current focal length and aperture using Photo Desk Software (see [page 5-44](#)).
2. Choose Lens Optimization from the Capture menu, then choose Manual.

3. Press the right side of the Five-way control to display the edit boxes.
4. Press the right or left side of the Five-way control to highlight a box. Press the top or bottom of the Five-way control to change a value.

NOTE: The strength must be between zero and 99.

5. Press the OK button.

## Select a Lens from the User List



Once you add a lens to the user list (see [page 5-35](#)) or define a new lens (see [page 5-39](#)), you can select it.

1. Choose Lens Optimization from the Capture menu, then choose a lens.
2. Press the OK button.

### When you Change Lenses

If you have selected a lens from the user list and you later change the lens, you should select the new lens before shooting. If you capture an image and the lens does not match your selection, the camera will attempt to automatically select the new lens. The camera will ask you for help if it is uncertain which lens you are using. One of the following events will occur:

- If there is one possible match in the user list or the master list, that lens is automatically selected.
- If there are two or more possible matches in the user list or the master list, the list of possible matches appears.
- If there are no possible matches in the user list or the master list, the camera switches to Auto.

**NOTE:** If you use the wrong lens in Basic mode, the Auto method will be used.

#### With two or more matches:

1. Press the OK button to dismiss the screen.

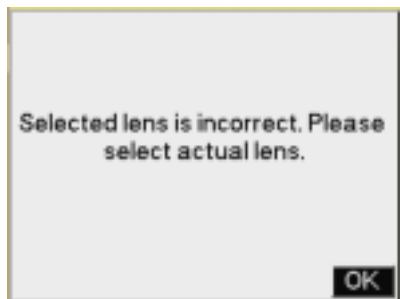

2. Select a lens and press the OK button.



## Maintaining the User List

The camera maintains a master list of lenses. You can create your own user list of frequently used lenses.

You can do the following with the user list:

- Add lenses from the master list (see [page 5-35](#))
- Remove lenses (see [page 5-37](#))
- Select lenses (see [page 5-33](#))
- Save the user list (see [page 5-38](#))
- Load the user list (see [page 5-38](#))

## Adding Lenses from the Master List

Use this option to move a lens from the master list to the user list.



1. Choose Lens Optimization from the Capture menu, choose Setup, then choose Add Lens.

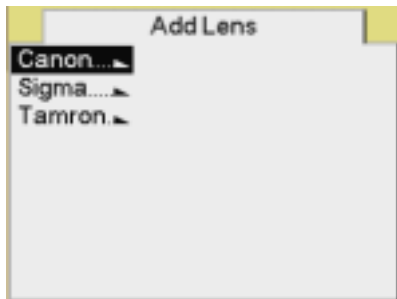

2. Choose the appropriate lens manufacturer.

## Configuring your Camera



3. Choose the lens that is mounted on your camera.

NOTE: If your lens does not appear in the master list, add a new fixed (see [page 5-39](#)), or a new zoom lens (see [page 5-40](#)).

4. Press the OK button.



The lens is moved from the master list to the user list.



## Removing Lenses from the User List

Use this option to move a lens from the user list to the master list.



1. Choose Lens Optimization from the Capture menu, choose Setup, then choose Remove Lens.

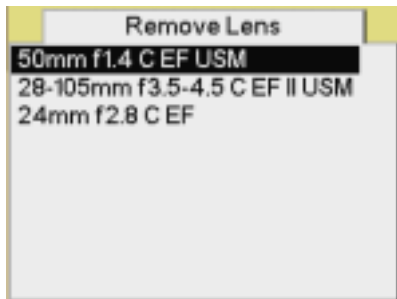

2. Select the lens to be removed.
3. Press the OK button.

The lens is moved from the user list to the master list.

### Saving a List

If you have made any changes to a list in the camera, we recommend that you save it to a memory card. This combines the user list and master list and provides a backup copy. If your camera needs repair and the original list cannot be saved, your backup copy can be loaded.

If you use more than one KODAK PROFESSIONAL DCS Pro SLR/c Digital Camera, you can save time by creating the user list of commonly used lenses on one camera, then loading it into the others.

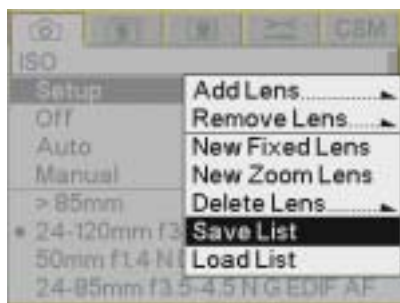

1. Insert a memory card in the camera.
2. Choose Lens Optimization from the Capture menu, choose Setup, then choose Save List.
3. Press the OK button.

The list is saved to the root directory of the memory card as lens.txt.

**IMPORTANT:** *Do not edit or rename this file. If you do, it may not work properly in the camera.*

### Loading a List

**IMPORTANT:** *Save your current user list to your computer before loading a new one. The new list will be merged with your current list and new lenses or changes not already in the camera will be applied. If you change the strengths for a lens, and there are changes for that lens in the new list, your changes will be overwritten.*



1. Insert the memory card containing the list in the camera.
2. Choose Lens Optimization from the Capture menu, choose Setup, then choose Load List.
3. Press the OK button.
4. Press OK in response to the confirmation screen.

If a file named lens.txt is in the root directory of the memory card, it is saved to the camera.

## Defining New Lenses

If you use a lens that is not in the camera's master list, you can define a new lens and add it to the user list.

You can:

- Define a new fixed lens (see [page 5-39](#))
- Define a new zoom lens (see [page 5-40](#))
- Delete a defined lens from the user list (see [page 5-41](#))
- Edit the name of a defined lens (see [page 5-42](#))

## Defining New Fixed Lenses



1. Mount the appropriate lens on the camera.
2. Choose Lens Optimization from the Capture menu, choose Setup, then choose New Fixed Lens.

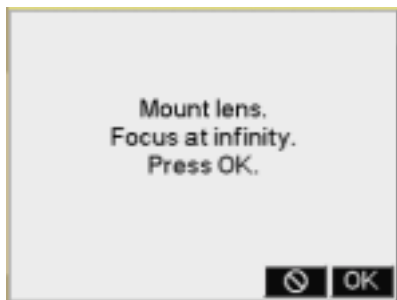

3. Focus at infinity and press the OK button.



4. Press the OK button.  
The lens is selected and appears at the top of the user list.
5. Change the strengths for the lens (see [page 5-44](#)).

## Configuring your Camera

### Defining New Zoom Lenses

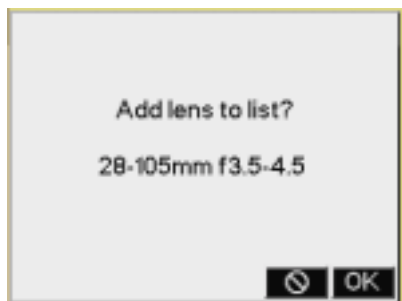

1. Mount the appropriate lens on the camera.
2. Choose Lens Optimization from the Capture menu, choose Setup, then choose New Zoom Lens.
3. Focus at infinity, set the lens to its shortest focal length, then press the OK button.
4. Set the lens to its longest focal length then press the OK button.
5. Press the OK button.  
The lens is selected and appears at the top of the user list.
6. Change the strengths for the lens (see [page 5-44](#)).

## Deleting Defined Lenses

Use this option to delete a lens that you defined.



1. Choose Lens Optimization from the Capture menu, choose Setup, then choose Delete Lens.

A list of user-defined lenses appears.

2. Select the lens to be removed.

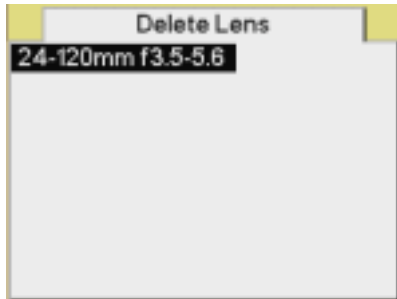

3. Press the OK button.

The lens is removed from the user or master list, and all information about the lens is deleted from the camera.

### Editing the Lens Name

**NOTE:** This feature is available for lenses that you defined. It is not available for lenses that you added from the master list.

In addition to assigning strength values to lenses in the user list you can add information to help you identify the lens. While you can add any text, we recommend that the first letter be the first letter of the lens manufacturer. Predefined first letters are:

**C**—CANON

**K**—TOKINA

**N**—NIKON

**Q**—QUANTARAY

**S**—SIGMA

**T**—TAMRON

**V**—VIVITAR

Select an appropriate first letter for other lenses.

1. Choose Lens Optimization from the Capture menu, then highlight the lens in the user list.



2. Press the right side of the Five-way control to display the Strength screen. Choose Edit Name.

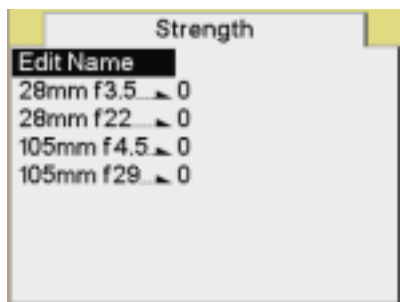

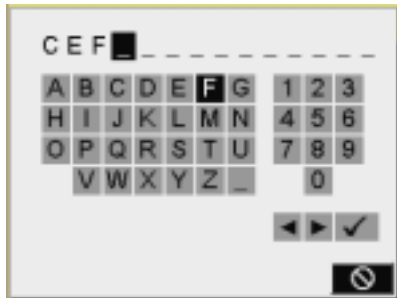

### 3. Enter text.

- a. To enter a character, press the right or left side of the Five-way control to highlight the character, then press the OK button.
- b. To change a character, highlight > or <, then press the OK button to move to the next or previous character in the folder name.
- c. When finished, highlight ✓ and press the OK button.

### Changing the Strength

You can change the strength of a lens in the user list two ways:

- Reset the lens to factory defaults (see [page 5-46](#)). (This feature is available only for lenses that were in the master list.)
- Determine the optimum strengths using Photo Desk (see [page 5-44](#)), then assign the strengths to the camera (see [page 5-45](#)).

### Determining the Optimum Strength

Do the following when you are changing the strengths of a lens in the user list or when you are using the Manual method (see [page 5-32](#)):

1. Capture an image of a gray card at normal exposure. (Fill the frame with the gray card.)
2. On your computer, open the image in Photo Desk.  
If the lens optimization strength is too low, the corners of the image appear green or yellow.  
If the lens optimization strength is too high, the corners of the image appear blue or magenta.
3. In Photo Desk, use Click Balance at the center of the image.
4. Click Lens Optimization, then adjust the slider to make the corners neutral. The number for the appropriate strength appears. Click OK.
5. Make a note of this number so you can assign it to the lens (see [page 5-45](#)).
6. Repeat steps 1 - 5 for all combinations of minimum/maximum focal length, and minimum/maximum aperture.

**NOTE:** Refer to the Help for Photo Desk for more information.



## Assigning Optimum Strengths to Lenses in the User List

Once you determine the optimum strengths for a lens in Photo Desk (see [page 5-44](#)) and add the lens to the user list, you can assign the strengths to the lens in the user list.

If you remove the lens from the user list (see [page 5-37](#)), the new values are moved to the master list. You can always reset to the default strengths, if needed (see [page 5-46](#)). If you delete the lens (see [page 5-41](#)), the changes are not saved in the master list.



1. With the appropriate lens mounted and set to infinity, choose Lens Optimization from the Capture menu, then highlight the lens in the user list.

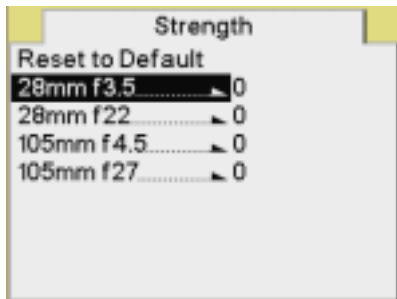

2. Press the right side of the Five-way control to display the Strength screen.
3. Select the focal length and aperture.

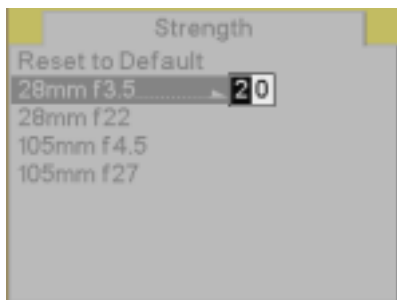

4. Press the right side of the Five-way control to display boxes where you can enter the strength determined in Photo Desk.
5. Press the right or left side of the Five-way control to highlight a box. Press the top or bottom of the Five-way control to change a value.

**NOTE:** The strength must be between zero and 99.

6. Press the OK button.

The assigned strength is applied whenever you capture an image with the lens selected in the user list.

## Configuring your Camera

### Resetting to Defaults

**NOTE:** This feature is available for lenses that you added from the master list. It is not available for lenses that you have defined.

You can reset strength values for a lens in the user list to the values in the master list.

1. Choose Lens Optimization from the Capture menu, then highlight the lens in the user list.
2. Press the right side of the Five-way control to display the Strength screen.
3. Choose Reset to Default.
4. Press the OK button.

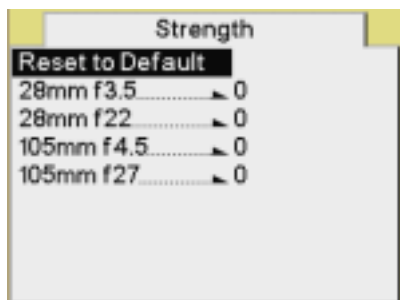

# 6 Setting up Cards, Folders, and Files

Your KODAK PROFESSIONAL DCS Pro SLR/c Digital Camera (DCS Pro SLR/c) has slots for two memory cards.

Before capturing images to the memory cards, you can do the following:

- Select a folder to hold captured images
- Create and name new folders
- Set up file type and characteristics for subsequently captured images

## Memory Cards

You can insert one or two cards at a time. One slot holds a COMPACTFLASH (CF) card. The other slot holds either a SECURE DIGITAL (SD) or a MULTIMEDIA (MMC) card. With two cards, you can capture images to both cards (providing a backup) or designate one card as standby until the other card is filled.

CF card

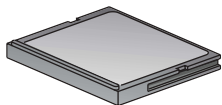

SD or MMC card

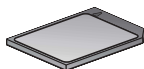

**COMPACTFLASH (CF) card**—Solid state or IBM MicroDrive COMPACTFLASH+ Type II card

**SECURE DIGITAL (SD) card**—Memory card with write-protect lock

**MULTIMEDIA (MMC) card**—Same size as SD card but no write-protect lock

## Setting up Cards, Folders, and Files

### Inserting Cards

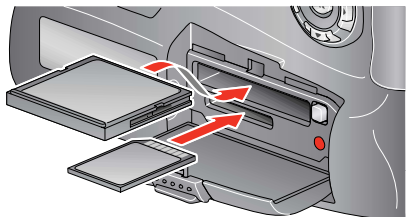

1. Open the Media door.
2. If using a CF card, insert it in the top slot, label side up.  
If using an SD or MMC card, insert it in the bottom slot, label side down.  
With two cards, insert either card first.
3. Close the Media door.

### Removing Cards

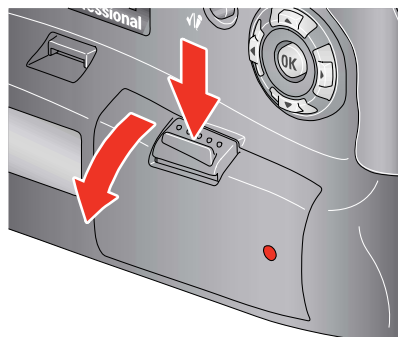

1. Open the Media door.



#### CAUTION:

The Card Busy LED and the Card icon on the Digital Status LCD blink when images are being accessed. Do not remove a card until the blinking stops. Doing so could destroy all image files on the card.



Card icons

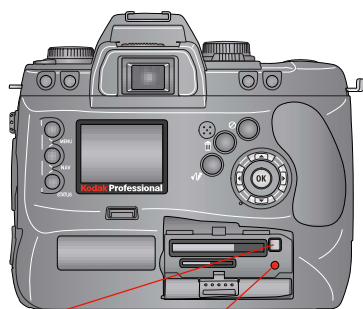

Eject button

Card Busy LED

2. To remove a CF card, press the Eject button. To remove an SD or MMC card, press and release the end of the card.  
If removing two cards, remove either card first.
3. Close the Media door.

## File Types

Your camera can save images as Raw or JPEG files.

**Raw** (.dcr) files can be opened by KODAK PROFESSIONAL DCS Photo Desk. Raw images can be thought of as "digital negatives." They preserve all image information so you can apply the DCS-specific image enhancements available in DCS Photo Desk.

**JPEG** (.jpg) files are smaller and can be opened directly by any image editing software. You can choose ERI (Extended Range Imaging) JPEG or Standard JPEG.

NOTE: Repeated saves of any JPEG image can degrade image quality.

NOTE: No more than 2000 files, including hidden system files, can be stored on memory cards inside the camera.

## Choosing the File Type to be Written to a Card

When you use one memory card, you can specify that captured images are saved to the card as Raw, JPEG, or Raw+JPEG. (With Raw+JPEG, both file types are written to the card.)

When you use two cards, you can specify that one card is standby or that captured images are saved to both cards as Raw, JPEG, or Raw+JPEG. When one card is set to standby, no images are written to that card until the other card is full. When the other card is full, subsequently captured images are written to the standby card using the same file type. When neither card is standby, captured images are written to both cards. (You can write different file types to two cards, for example, Raw to one card and JPEG to the other.) You can also choose the JPEG file type.

The following table provides examples of some ways to set up file types:

	CF Card	SD/MMC Card
No redundancy	JPEG Raw	Standby Standby
Multi-purpose redundancy	Raw	JPEG
Complete redundancy	Raw Raw+JPEG	Raw Raw+JPEG

## Setting up Cards, Folders, and Files

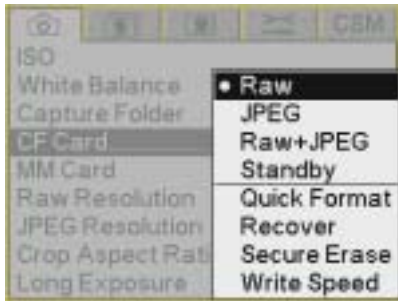

1. When using one card, choose the appropriate card (CF Card or MMC/SD Card) from the Capture menu, then choose Raw, JPEG, or Raw+JPEG.

When using two cards, choose the appropriate card from the Capture menu, then choose Raw, JPEG, Raw+JPEG, or Standby.

2. Press the OK button.
3. With two cards, repeat steps 1 and 2 for the second card.

NOTE: Only one card can be standby.

### Shortcut:

- You can also access this function using the Digital Status LCD shortcut.



## File Type and ISO

The ISO range for Raw files is 160 to 1600. The ISO range for JPEG files is 160 to 800. This difference can affect your ISO settings when you change file types.

This effect is demonstrated in the following example:

1. Choose Raw and set an ISO greater than 800 (for example, 1600).
2. Choose JPEG or Raw + JPEG.

The ISO changes to 800 for the Raw and the JPEG files.

3. Choose Raw.

The ISO remains at 800. You will need to reset the ISO if you want a higher setting.

**Choosing the JPEG File Type** If JPEG files are being written to a card, you can further specify whether the files are ERI (Extended Range Imaging) JPEG or Standard JPEG.

- **ERI JPEG** files offer enhanced image editing capability. The included KODAK PROFESSIONAL DCS Extended Range Imaging File Format Module lets you apply many DCS-specific image enhancements before acquiring them into PHOTOSHOP.

For more information on the ERI JPEG file format, visit <http://www.kodak.com/go/dcs> and select the "Extended Range Imaging Technology (ERI)" link.

- **Standard JPEG** files are slightly smaller and do not offer the post-capture DCS-specific image enhancement capability of ERI JPEG files.
- Choose JPEG File Type from the Image menu, then choose ERI or Standard.

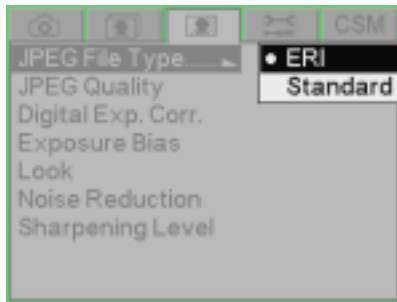

### Formatting Cards

You may need to format a card if it was formatted incorrectly or if the data on the card becomes corrupted. If you have used a card for several sessions (for example, two or three dozen), you may want to format it on the camera you will be using so that the full capacity of the card is available. (Deleting images does not reclaim all space on the card.)

There are two ways to format a card:

**Quick Format**—Removes the directory structure but does not erase data. This type of format takes relatively little time to complete. It may be possible to recover files after a quick format if they have not been overwritten.

**Secure Erase**—Erases all information and "cleans up" the card. This type of format takes longer to complete. You cannot recover files after a secure erase.

**NOTE:** Cards are formatted in PC DOS format.

1. Choose CF Card or SD Card from the Capture menu, then highlight Quick Format or Secure Erase.

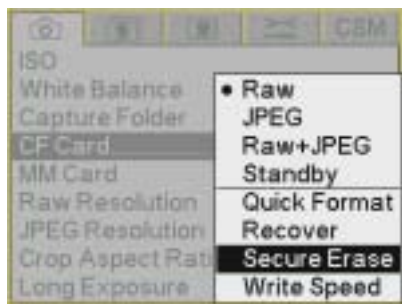

2. Press the OK button to format the card and dismiss the confirmation screen. (Press the Cancel button to dismiss the confirmation screen without formatting the card.)

The Card Busy LCD and the appropriate Card icon in the Digital Status LCD blink while the format is taking place. When the blinking stops, the format is complete.



## Recovering Deleted Files

The Recover feature lets you recover image files recently deleted from a memory card. You can recover files if:

- The card was last formatted using your DCS Pro SLR/c camera.
- The files have not been overwritten.

When you recover files, a folder named "Recover" is created and the recovered files are saved there.

NOTE: You cannot capture images to the Recover folder.

NOTE: Only insert one memory card in your camera when using the Recover feature.

1. Choose CF Card or SD Card from the Capture menu, then highlight Recover.

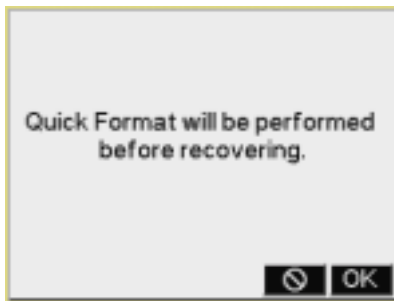
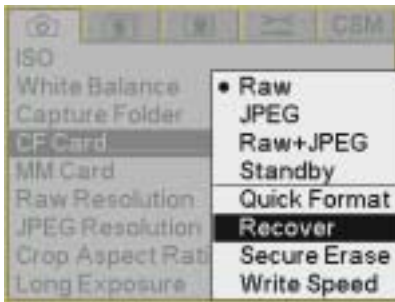

2. Press the OK button.  
A "Recovering files" message appears followed by a "Recovery complete" message.
3. Press the OK button.

### Determining Write Speed

You can determine the speed at which your camera writes data to the CF card. Write speeds are measured in Megabytes per second (Mbytes/sec).

**NOTE:** Write speed improves if you turn the Image LCD off when capturing images.

### For the Most Accurate Write Speed Measurement

1. If an SD or MMC card is inserted, set the card to Standby and remove the card.
2. Insert a CF card.
3. Select RAW file type.
4. Set the RAW resolution to 13.5.
5. Select Single Image review mode.
6. Turn off the Image LCD.
7. Capture one or more images.
8. Turn on the Image LCD and choose Write Speed from the Capture menu.

The write speed for the last saved image appears.

**NOTE:** Repeat steps 6 - 8 at least 3 times and average the results as readings can vary slightly.

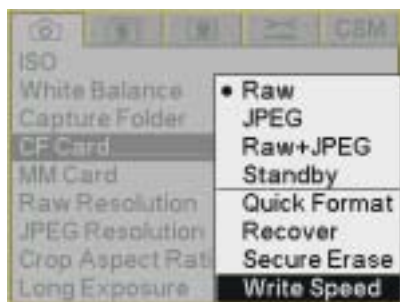

## Folders for Captured Images

You can select a folder to hold captured images. You can also create and name new folders.

**IMPORTANT:** *When you select or create a folder and there are two cards in the camera, the same folder is selected or created on both cards.*

### Selecting a Capture Folder



1. Choose Folder from the Capture menu, then highlight a folder.
2. Press the OK button.

### Creating a New Folder

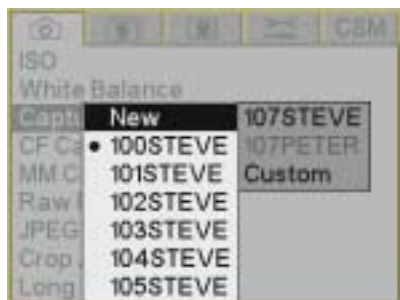

1. Choose Folder from the Capture menu, choose New, then choose one of the following:

- The name of a new folder associated with the current naming scheme
- The name of a new folder associated with the default naming scheme
- A Custom option for creating a new naming scheme

NOTE: All naming schemes follow the DCF (Digital Camera File) standard.

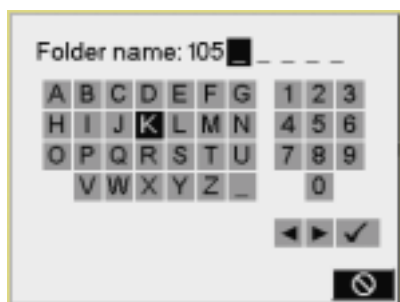

2. If you chose Custom, this screen appears where you can name the folder.

The name must consist of three numeric characters followed by five alphanumeric characters. (You cannot change the numeric characters.)

- To enter a character, press the right or left side of the Five-way control to highlight the character, then press the OK button.
- To change a character, highlight > or <, then press the OK button to move to the next or previous character in the folder name.
- When finished, highlight Done and press the OK button.

3. Press the OK button.

Press OK button for each character. ✓ to finish.

## Image Files

You can capture Raw, JPEG, or Raw+JPEG files. In addition, you can specify resolution, crop aspect ratio, quality, and other image enhancements.

### Setting the Crop Aspect Ratio

You can select a crop aspect ratio to apply to JPEG images. Crop aspect ratio is not applied to Raw images on the camera. Rather, the information is saved and applied when the images are processed in the DCS Photo Desk software. (You can also change the setting in the DCS Photo Desk software.)

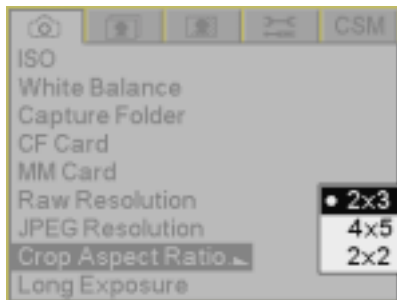

1. Choose Crop Aspect Ratio from the Capture menu, then highlight 2 x 3, 4 x 5, or 2 x 2.
2. Press the OK button.

With the 4 x 5 or 2 x 2 options, a crop overlay appears on the thumbnail (on the camera in Image mode and in the DCS Photo Desk software).

#### Shortcut:

- You can also access this function using the Digital Status LCD shortcut.

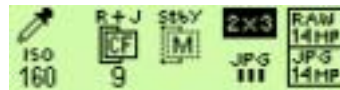

### Setting Raw Resolution

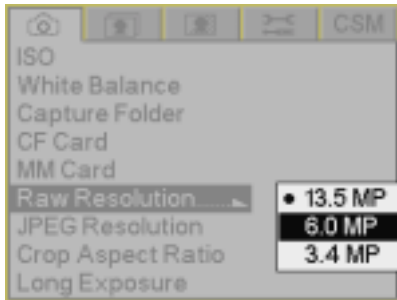

There are three resolutions available for Raw files:

**13.5 MP**—Full-resolution Raw images (4500 x 3000)

**6.0 MP**—Half-resolution Raw images (3000 x 2000)

**3.4 MP**—Quarter-resolution Raw images (2250 x 1500)

1. Choose Raw Resolution from the Capture menu, then highlight a resolution.
2. Press the OK button.

**NOTE:** The number of pixels varies, depending on the crop aspect ratio.

#### Shortcut:

- You can also access this function using the Digital Status LCD shortcut.



### Setting JPEG Resolution

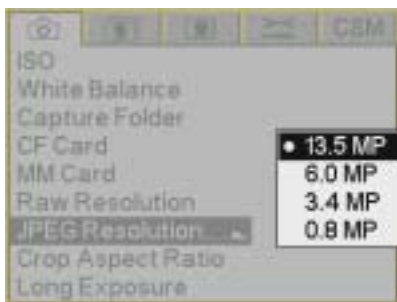

There are four resolutions available for JPEG files:

**13.5 MP**—Full-resolution JPEG images (4500 x 3000)

**6.0 MP**—Half-resolution JPEG images (3000 x 2000)

**3.4 MP**—Quarter-resolution JPEG images (2250 x 1500)

**0.8 MP**—0.8 resolution JPEG images (1125 x 750)

**NOTE:** The number of pixels varies, depending on the crop aspect ratio.

1. Choose JPEG Resolution from the Capture menu, then highlight a resolution.
2. Press the OK button.

#### Shortcut:

- You can also access this function using the Digital Status LCD shortcut.

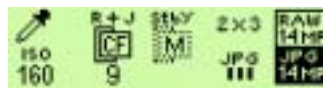

## Setting JPEG Quality

You can specify the compression level applied to JPEG files.

**Best**—Images have lowest compression, larger file size, and highest quality

**Better**—Images have moderate compression, smaller file size, and moderate quality

**Good**—Images have highest compression, smallest file size, and lowest quality

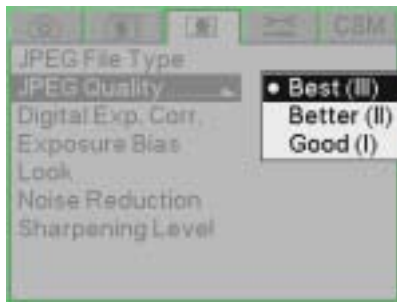

1. Choose JPEG Quality from the Image menu, then highlight Best, Better, or Good.
2. Press the OK button.

### Shortcut:

- You can also access this function using the Digital Status LCD shortcut.



### Correcting Digital Exposure

Use Digital Exposure Correction to correct errors in exposure.

This feature helps correct errors but is not a substitute for proper exposure settings (shutter speed, aperture, and ISO).

**NOTE:** Do not confuse Digital Exposure Correction with Exposure Compensation, which modifies exposure.

Digital Exposure correction is applied to JPEG images on the camera. It is not applied to Raw images on the camera. Rather, the information is saved and applied when the images are processed in the DCS Photo Desk software. (You can also change the setting in the DCS Photo Desk software.)

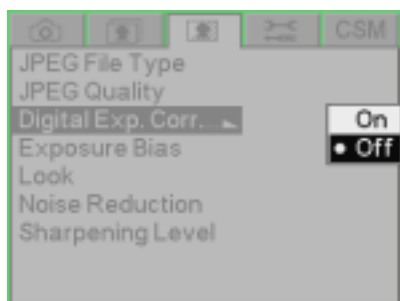

1. Choose Digital Exp. Corr. from the Image menu, then highlight Off or On.
2. Press the OK button.

### Setting Exposure Bias

If you use more than one KODAK PROFESSIONAL DCS Pro SLR/c Digital Camera in your studio, you may want to adjust the exposure so that all of your cameras produce consistent output. You can set the Exposure Bias in -0.5 to +0.5 in 1/10 stop increments. Exposure Bias is applied to JPEG images on the camera. It is not applied to Raw images on the camera. Rather, the information is saved and applied when the images are processed in the KODAK PROFESSIONAL DCS Photo Desk software.

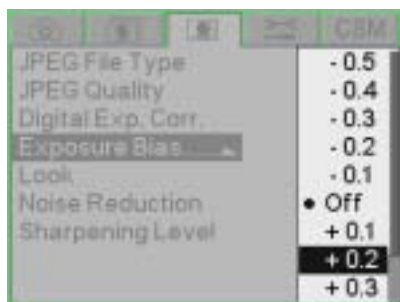

1. Choose Exposure Bias from the Image menu, then highlight the desired setting.
2. Press the OK button.



## Setting Look

Look applies a tone scale adjustment to JPEG images and tags Raw images for adjustment in the DCS Photo Desk software.

Look is applied to JPEG images on the camera. It is not applied to Raw images on the camera. Rather, the information is saved and applied when the images are processed in the DCS Photo Desk software. (You can also change the setting in the DCS Photo Desk software.)

**Portrait**—Lower contrast with more detail in highlights and shadows

**Product**—More contrast and higher levels of color saturation

**Wedding**—Product with neutral shadows

**Event**—High saturation with optimized skin tones

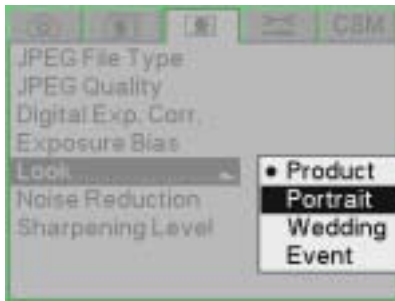

1. Choose Look from the Image menu, then highlight Portrait, Product, Wedding, or Event.
2. Press the OK button.

## Setting Noise Reduction

Noise Reduction reduces noise that can occur when images are captured at high ISO settings.

Noise Reduction is applied to JPEG images on the camera. It is not applied to Raw images on the camera. Rather, the information is saved and applied when the images are processed in the DCS Photo Desk software. (You can also change the setting in the DCS Photo Desk software.)

1. Choose Noise Reduction from the Image menu, then highlight Normal or Strong.
2. Press the OK button.

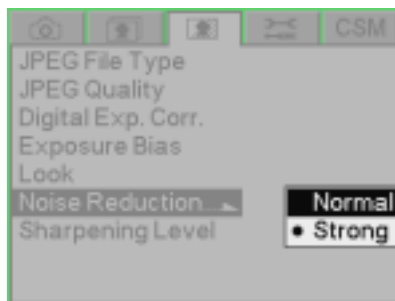

### Selecting the Sharpening Level

You can specify the sharpening level applied to images.

Sharpening is applied to JPEG images on the camera. It is not applied to Raw images on the camera. Rather, the information is saved and applied when the images are processed in the DCS Photo Desk software. (You can also change the setting in the DCS Photo Desk software.)

**None**—No sharpening is applied

**Low**—Minimal sharpening is applied

**Medium**—Moderate sharpening is applied

**High**—Substantial sharpening is applied

1. Choose Sharpening Level from the Image menu, then highlight None, Low, Medium, or High.
2. Press the OK button.

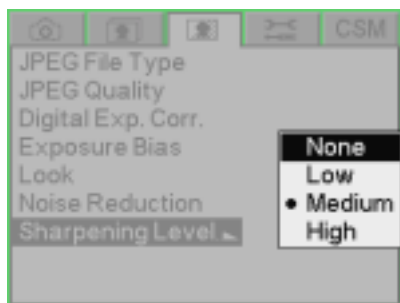

# 7 Controlling Exposure

## White Balance

White Balance adjusts an image to match the type of lighting used when capturing images. Your KODAK PROFESSIONAL DCS Pro SLR/c Digital Camera (DCS Pro SLR/c) offers two types of White Balance: Preset and Click. When you specify a Preset or Click Balance option, that setting is applied to subsequently captured images.

Preset options include Auto, Daylight, Tungsten, Fluorescent, and Flash. Click Balance lets you:

- Specify an area on the currently selected image from which the RGB values are used to color balance subsequently captured images
- Use a previously saved setting
- Save a click balance setting
- Load a click balance setting from a card
- Delete a click balance setting from the camera

### Shortcut:

- You can also access this function using the Digital Status LCD shortcut.

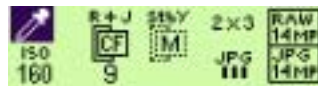





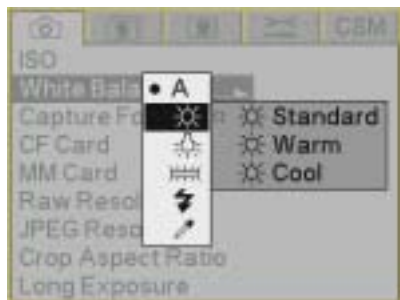

## Controlling Exposure

### Preset White Balance



- Choose White Balance from the Capture menu, choose a Preset option, then choose a setting.

	Preset Category	Preset Options
	Auto	<ul style="list-style-type: none"><li>• Full Auto</li></ul>
	Daylight	<ul style="list-style-type: none"><li>• Standard Daylight</li><li>• Warm Daylight</li><li>• Cool Daylight</li></ul>
	Tungsten	<ul style="list-style-type: none"><li>• Standard Tungsten</li><li>• Warm Tungsten</li><li>• Cool Tungsten</li></ul>
	Fluorescent	<ul style="list-style-type: none"><li>• Standard Fluorescent</li><li>• Cool White</li></ul>
	Flash	<ul style="list-style-type: none"><li>• Standard Flash</li><li>• Warm Flash</li><li>• Cool Flash</li><li>• Studio Flash</li></ul>
	Click Balance	See <a href="#">page 7-3</a> .

An approximate Kelvin temperature scale value associated with the selected Preset setting appears in the Digital Status display.

## Click Balance

Click Balance takes RGB values from the current image or from previously saved or loaded settings and applies them to subsequently captured images.

**NOTE:** The Click Balance feature is only available for Raw files. It is not available for JPEG files.

## Using the Current Image for Click Balance

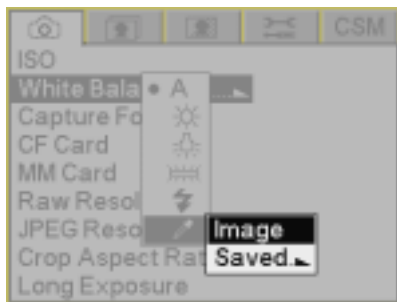

1. Select a Raw image.
2. Choose White Balance from the Capture menu, choose Click Balance  then highlight Image and press the OK button.

The selected image appears.



3. Press any side of the Five-way control to move the eyedropper over a neutral (gray) area of the image.
4. Press the OK button.

The pixel values in the area under the eyedropper are sampled.

## Controlling Exposure

### Displaying the Saved Settings Menu

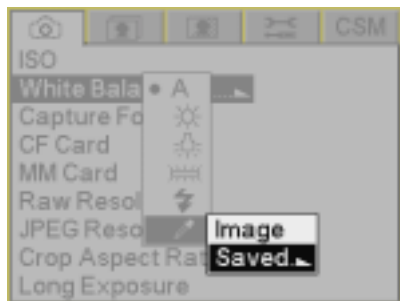

1. Choose White Balance from the Capture menu, choose Click Balance , then highlight Saved.

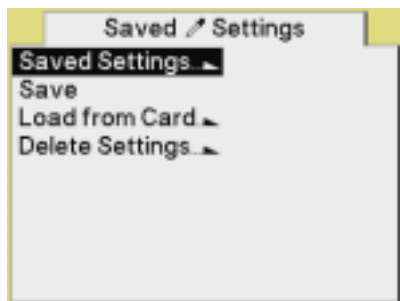

2. Press the OK button to display the Saved Settings menu.

### Using a Saved Setting

For saved settings to appear in the list, you must first do one of the following:

- Save a setting on the camera
- Save a setting to a card using the KODAK PROFESSIONAL DCS Photo Desk software on your computer, then load the setting from the card.

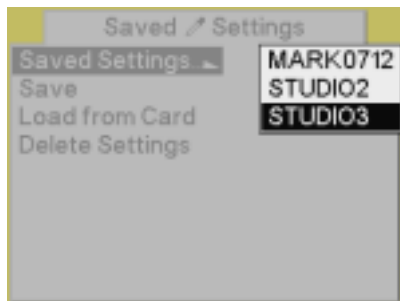

1. Choose Saved Settings from the Saved Settings menu, then highlight a setting.
2. Press the OK button.

## Saving a Setting on the Camera

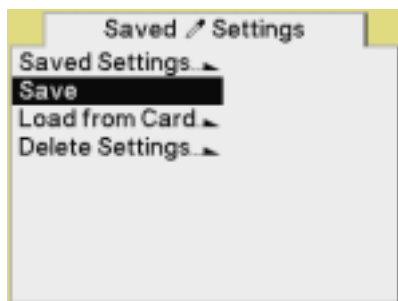

1. Select an image.
2. Choose Save <image #> from the Saved Settings menu, then press the OK button.

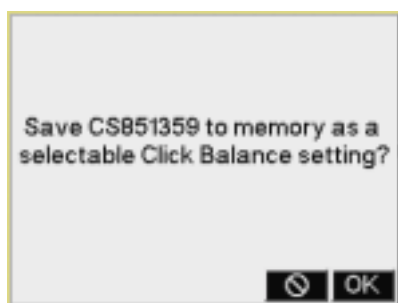

3. Press the OK button to save the setting and close the confirmation screen.

## Controlling Exposure

### Loading Settings from a Card

Using the DCS Photo Desk software, you can save settings to the root directory of a card. (These filenames have .WB extension.)

**IMPORTANT:** *Settings must be saved to the root directory or you will not be able to load them into your camera.*

You can then put the card in your camera and load the settings into camera memory. A maximum of 10 settings can be stored in camera memory.

1. Choose Load from Card from the Saved Settings menu, choose a card (if two are inserted), then highlight a setting.
2. Press the OK button to load the setting.

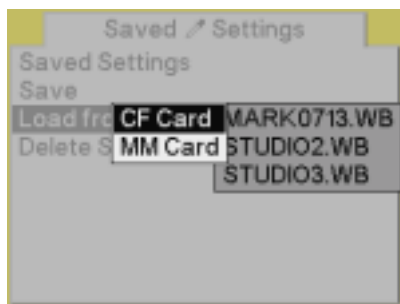

### Deleting Settings

To make room in camera memory for new settings, you can delete settings that you no longer use.

1. Choose Delete Settings from the Saved Settings menu, then highlight a setting.
2. Press the OK button to delete the setting and close the confirmation screen.

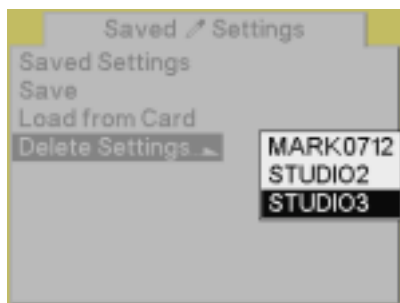





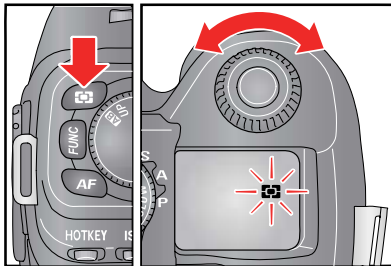

## Exposure

**Exposure Metering Modes** You can choose from three Exposure metering modes. Select the mode which best suits your subject's lighting and the exposure effect you desire.

### Choosing a Metering Mode



- Press and hold the Metering Mode button, then turn the C-Dial to select a Metering mode.

	<p><b>8 Segment metering:</b> Your camera measures the scene brightness by independently measuring eight areas of the scene. It then analyzes the data and sets the correct exposure for the main subject. Even under strong back lighting or complex lighting situations, your camera will give you the correct exposure.</p>
	<p><b>Center Area metering:</b> Your camera measures the scene brightness only within the circle in the viewfinder. This mode is suitable when you wish to base the exposure on a very small portion of the scene and ignore the lighting or brightness of rest of the scene.</p>
	<p><b>Average metering:</b> Your camera measures the average brightness of the entire scene with special emphasis on the center area. It then calculates the best exposure for this average brightness.</p>

## Exposure Modes

In selecting the Exposure mode, you can choose whether you want to set the shutter speed and/or lens aperture automatically or manually.

Your camera has four exposure modes:

- Program Auto Exposure (**P**)
- Aperture Priority AE (**A**)
- Shutter Speed Priority AE (**S**)
- Manual (**M**)

## Controlling Exposure

### Program Auto Exposure Mode

In Program AE mode, the camera automatically selects an appropriate combination of shutter speed and aperture values. The combination is based on a variety of factors, including the selected Exposure Metering mode, the brightness of the scene, and the ISO setting.

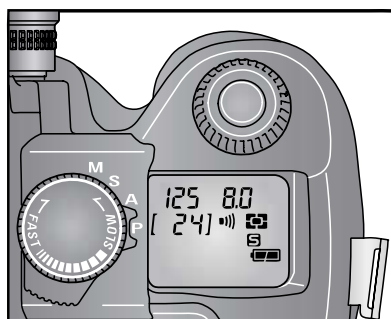

1. Rotate the D-Dial to the desired setting in the Drive area.
2. Set the Mode Selector lever to **P**.
3. Lightly press the Shutter button to verify the focus and exposure display in the viewfinder.

If the subject is too bright or dark, both shutter speed and aperture value indicators blink and will show the limit values. If you capture an image with these settings, the image will be overexposed or underexposed.

When the ⚡ blinks, the shutter speed is slow and the image can be blurred. In this case, increase the ISO or use a flash.

The following graph shows exposure control in Programmed Auto Exposure mode

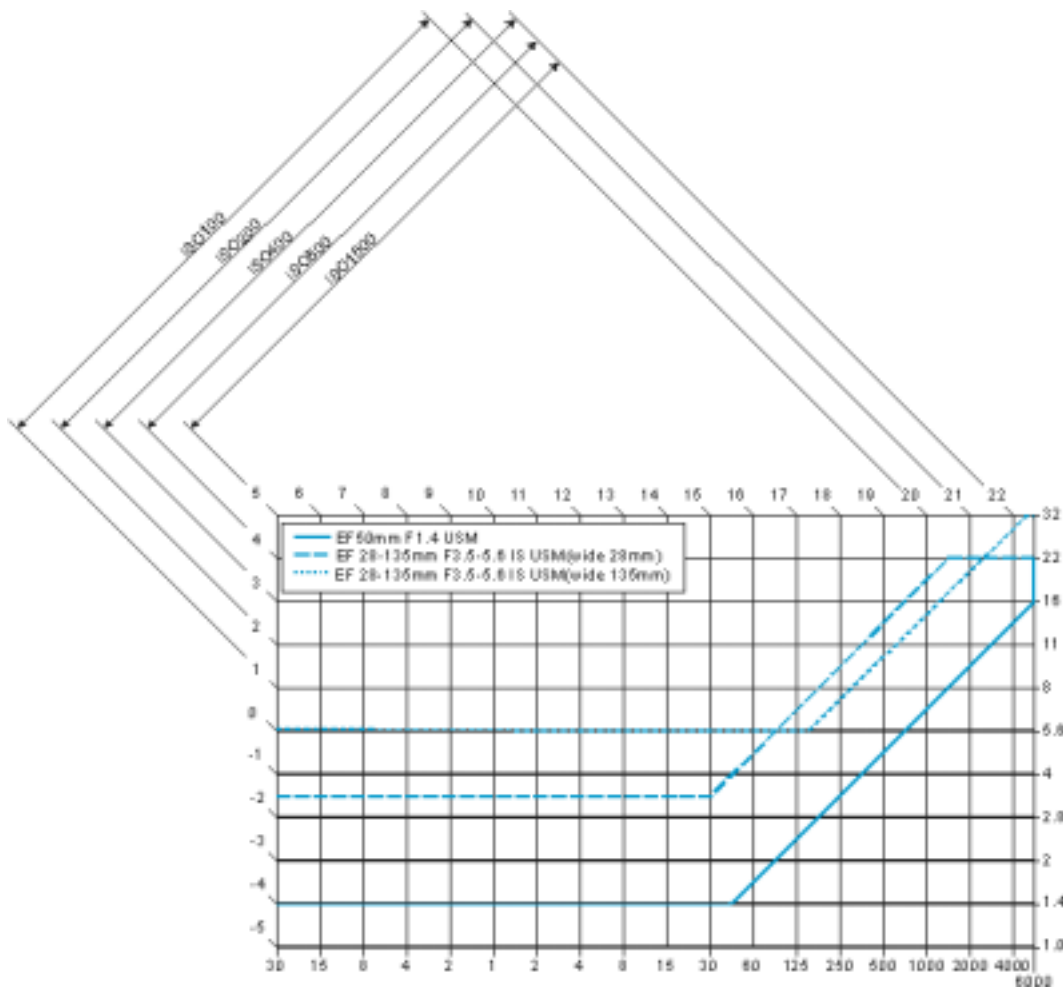

## Controlling Exposure

### Program Shift

You can change the combination of shutter speed and aperture value selected by the camera to combinations that give the equivalent exposure. Program shift is cancelled after you capture an image.

- Turn the C-Dial and observe the shutter speed and aperture values change on the Viewfinder display.

**NOTE:** You can't perform a program shift while using the flash.

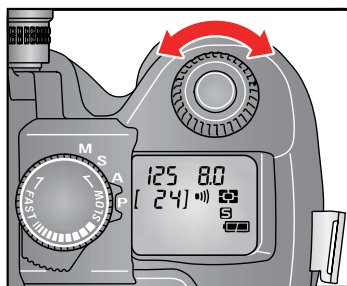

•	500	4.0
•	250	5.6
•	125	8.0
•	60	11
•	30	16

## Aperture Priority Auto Exposure Mode

In Aperture Priority AE mode, you control the depth of field by varying the aperture. After you set the aperture, the camera determines the appropriate shutter speed. When you select smaller apertures (larger f-numbers), the depth of field is greater, which is desirable for landscape photography. A larger aperture has a smaller depth of field, tending to blur the background. This would be appropriate for portrait photography.

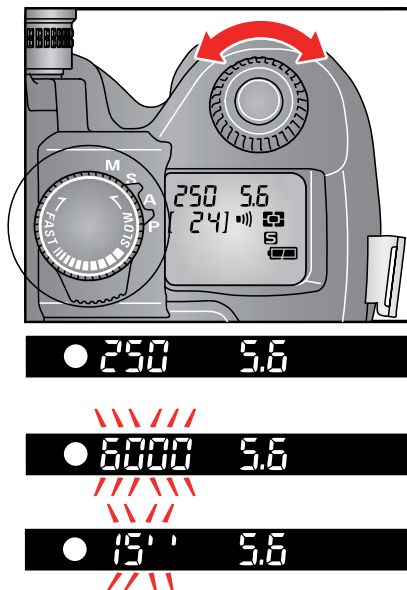

1. Rotate the D-Dial to the desired setting in the Drive area.
2. Set the Mode Selector lever to A.
3. Lightly press the Shutter button to verify the focus, and select the desired aperture value by rotating the C-Dial.
4. Verify the setting in the viewfinder.

If the appropriate shutter speed is out of the range due to the subject being too bright or too dark, the shutter speed indicator blinks. If the subject is too bright, set the aperture value to a smaller one (larger f-number). If the subject is too dark, set the aperture value to a larger one (smaller f-number) until the indicator stops blinking. You may also adjust the ISO setting, which causes the exposure value to change.

## Controlling Exposure

### Shutter Speed Priority Auto Exposure Mode

When you set the desired shutter speed in Shutter Speed Priority AE mode, the camera selects the appropriate aperture value for correct exposure. You can achieve stop action effects by selecting a fast shutter speed, or express the feeling of motion speed for a moving subject by selecting a slow shutter speed.

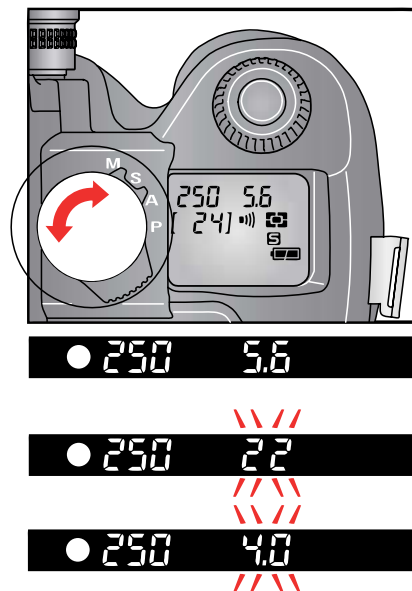

1. Rotate the D-Dial to the desired setting in the Drive area.
2. Set the Mode Selector lever to **S**.
3. Lightly press the Shutter button to verify the focus, and rotate the S-Dial to set the shutter speed.
4. Verify the setting in the viewfinder.

If the appropriate aperture value is beyond the range of the lens in use, due to the subject being too bright or too dark, the aperture value indicator blinks. If the subject is too bright, set the shutter speed to a faster one. If the subject is too dark, set the shutter speed to a slower one until the indicator stops blinking. You may also adjust the ISO setting, which causes the exposure value to change.

### Manual Exposure Mode

Use the Viewfinder's Exposure meter to help you set both the shutter speed and aperture value for the scene's lighting.

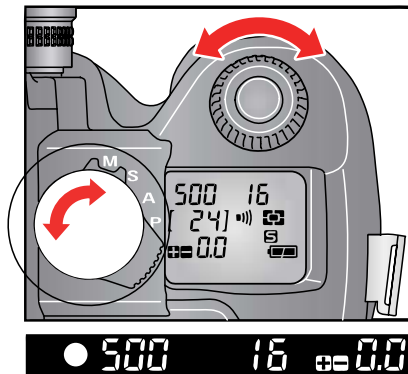



1. Rotate the D-Dial to the desired setting in the Drive area.
2. Set the Mode Selector lever to **M**.
3. Lightly press the Shutter button to verify the focus. Select the desired aperture value by rotating the C-Dial, and set the shutter speed by turning the S-Dial.
4. Verify the setting in the viewfinder.

## Controlling Exposure

### To Determine the Exposure Value Using the Camera's Exposure Meter

Rotate the Mode Selector lever to **M**. When you lightly press the Shutter button, the shutter speed and aperture value appear in the Viewfinder, and the Viewfinder's Exposure meter indicates the difference between the selected exposure and the correct exposure. For example:

 <b>1.7</b>	1.7 stops below (under exposure)
 <b>0.0</b>	Correct exposure
 <b>3.0</b>	3.0 stops over (over exposure)

The Exposure Meter can display the exposure error up to  $\pm 3$  stops from correct exposure in  $1/3$  stop increments. If the exposure error is more than 3 stops, the Exposure Meter blinks.



## Bulb Setting

Use the Bulb setting when a long exposure time is required for a night scene or a very dark subject. Use a tripod when capturing images with the Bulb setting.

**NOTE:** Choose Long as the Long Exposure setting when using Bulb. Choose Longer for times longer than two seconds (see [page 5-19](#)).

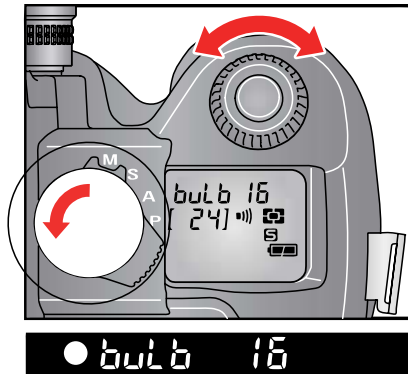

1. Rotate the D-Dial to Single Frame shooting.
2. Set the Mode Selector lever to **M**.
3. Rotate the S-Dial counterclockwise until "bulb" appears in the Top Status LCD. Rotate the C-Dial to set the aperture value.
4. Press and hold the Shutter button to open the shutter. The shutter remains open until you release the Shutter button.

### Auto Exposure Lock

Auto Exposure Lock is used to lock the camera's exposure values on an off-center subject. It is available when the camera is in Manual Focus or Continuous Autofocus mode. In Single Autofocus mode, the exposure is locked when the lens autofocus is completed. It is recommended that you use the AEL function with Center Area Metering mode.

1. Set the Exposure Metering mode to Center Area metering (see [page 7-7](#)).
2. Center the subject inside the viewfinder, then press and hold the AEL button.

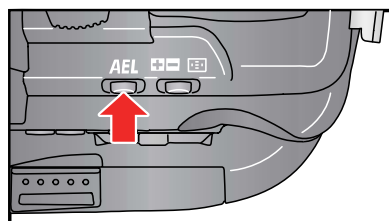

3. Continue to hold the AEL button, then lightly press the Shutter button. During AE lock, the shutter speed and aperture value displays in the Viewfinder are locked and **AEL** appears.



4. Continue to press the AEL button while you compose the picture and complete the focus operation. Then press the Shutter button to capture the image.

**NOTE:** When the final subject is out of focus during the AE lock operation, remove your finger from Shutter button, then lightly press the Shutter button to perform a new AF.

## Exposure Compensation

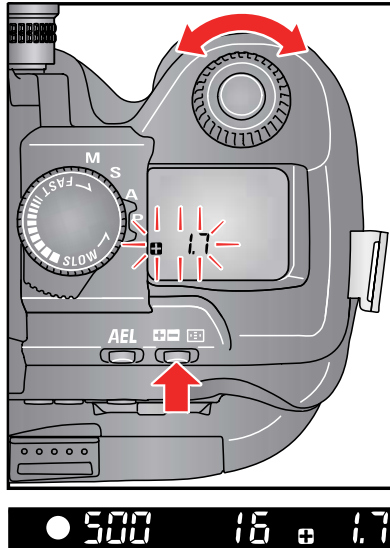

Use Exposure Compensation to intentionally overexpose or underexpose an image.

- Press and hold the Exposure Compensation button and turn the C-Dial to set the desired compensation value.

The Top Status LCD shows **0.0** when you initially press the Exposure Compensation button. A final setting of **+** indicates an overexposure compensation, and a **-** indicates an underexposure compensation.

You can set Exposure Compensation in 1/3 EV increments from +3.0 to -3.0 stops.

For example, if you are in the Aperture Priority AE mode and set Exposure Compensation to +1.0, the shutter speed changes to one stop slower. In Shutter Speed Priority AE mode, the aperture will be one stop larger (smaller f-number). In Program AE mode, both the shutter speed and aperture value changes add up to a +1.0 stop.

**NOTE:** You cannot use the Exposure Compensation function with Manual Exposure mode.

## Cancelling Exposure Compensation

Exposure Compensation remains in effect until you cancel it.

- Press and hold the Exposure Compensation button and turn the C-Dial until **0.0** appears in the Top Status LCD.

**NOTE:** If you have an approved flash installed on the camera's Hot Shoe, the Exposure Compensation setting affects the flash output. In addition, the Exposure Compensation setting sums with a Flash Exposure Compensation setup on the flash. For example, if Exposure Compensation is set to +1.0 and Flash Exposure Compensation is set to -.07, the total compensation is +0.3.

## Auto Bracketing

Auto Bracketing is useful when you're having difficulty determining the proper exposure. This function lets you capture a sequence of images of the same subject at three different exposure levels: appropriate exposure, underexposure and overexposure.

You can use Auto Bracketing with four exposure modes. The following table indicates the effect of Auto Bracketing in each mode:

Mode	Changed by Auto Bracketing
<b>P</b> mode	shutter speed and aperture value
<b>A</b> mode	shutter speed
<b>S</b> mode	aperture value
<b>M</b> mode	shutter speed

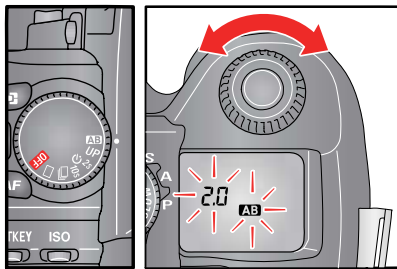

1. Rotate the D-Dial to **AB**.
2. Rotate the C-Dial to set the bracketing amount.  
It can be set in 1/3 EV step increments up to  $\pm 3$  EV. The Auto Bracketing function continues until you set the amount to 0.
3. Rotate the D-Dial to the desired Drive mode.

The camera captures three images in the following sequence: appropriate exposure, underexposure and overexposure.

For example: If you set the bracketing amount to 2.0, the indicator in the viewfinder appears as in the following table:

	P,A,S mode	M mode
First frame	<b>0.0</b>	* Measured value
Second frame	<b>2.0</b>	-2.0 EV deviation from Measured value
Third frame	<b>2.0</b>	+2.0 EV deviation from Measured value

\* Measured value is the difference between the correct exposure value for the camera and your setting value.

**NOTE:** The default Auto Bracketing sequence is: appropriate exposure, underexposure and overexposure. You may change the sequence using the Bracket Order Custom Setting. See [page 5-3](#).

**Notes:**

- For the first frame the **AB** mark is displayed continuously in the Top Status LCD. For the second frame the **AB** mark blinks slowly. For the third frame it blinks quickly.
- In Self Timer mode, the camera automatically captures three consecutive images.
- You can change the Drive mode during the Auto Bracketing operation.
- You cannot use Auto Bracketing mode with flash photography. Auto Bracketing will not affect the output level of the flash.

**Cancelling Auto Bracketing**

1. Rotate the D-Dial to **AB**.
2. Rotate the C-Dial to set the bracketing amount to 0.0.
3. Rotate the D-Dial to the Drive area.

**Using Auto Bracketing with Exposure Compensation**

You can capture images with both the Auto Bracketing and Exposure Compensation modes set. The combined values of Exposure Compensation and Auto Bracketing appears on the Viewfinder display. For example: If you set Exposure Compensation to +1.0 and Auto Bracketing to 0.7, the viewfinder displays the values seen in the following table.

First frame	<b>■1.0</b>	Exposure Compensation +1.0 & shift value 0.0
Second frame	<b>■0.3</b>	Exposure Compensation +1.0 & shift value -0.7
Third frame	<b>■1.7</b>	Exposure Compensation +1.0 & shift value +0.7

**NOTE:** The table show a bracketing exposure sequence of appropriate, under, over. You may change the sequence using a the Bracketing Order Custom Setting (see [page 5-3](#)).



# 8 Focusing

You can set up your KODAK PROFESSIONAL DCS Pro SLR/c Digital Camera (DCS Pro SLR/c) to focus automatically (described below) or, in situations where autofocus or focus lock are not effective, you can focus manually (see [page 8-5](#)).

## Autofocus

With autofocus, the camera does much of the work required to properly focus an image.

**NOTE:** You can only use Autofocus with AF Lenses. With mirror lenses and some specialized lenses, you can use the camera only in Manual Focus mode.

## Autofocus Modes

Your camera has two autofocus modes:

**Single AF with Focus Priority**—When you lightly press the Shutter button, focus tracking occurs until the subject stops moving. Focus then locks, and the focus indicator appears in the Viewfinder. You cannot release the shutter until focus locks.

**Continuous AF with Release Priority**—When you lightly press the Shutter Release button, focus tracking occurs until you release the button.

## Setting Autofocus

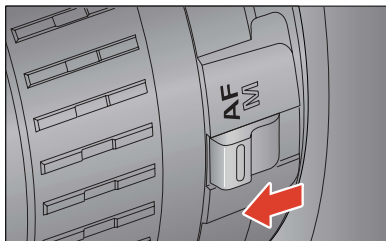

1. Set the lens' Focus Mode switch to AF
2. Lightly press the Shutter button and autofocus starts. When it completes, check the sharpness of the subject on the focusing screen.

### Situations where Autofocus May Not Work as Expected

Although your camera is equipped with highly precise AF system, in some cases autofocus does not work as expected.

- Low-contrast subjects, such as a blue sky or a blank wall or when the color of the subject is same as the background.
- The subject is located in a very low light environment
- Overlapping near and far objects, such as an animal behind a fence
- A subject moving at a high speed
- Subjects, with repeated patterns such as windows in a building

In such situations, please use one of the following focusing methods:

- Use Focus Lock (see [page 8-5](#)) to focus on another subject that is about the same distance from the camera as your subject.
- Set the lens to **M** mode and focus manually.

### Selecting the Autofocus Mode

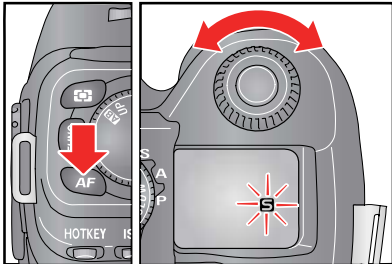

- Press the AF Mode button and turn the C-Dial to select either the **S** (Single AF Mode) or **C** (Continuous AF Mode) icon on the Top Status LCD.



## Selecting the Autofocus Zone

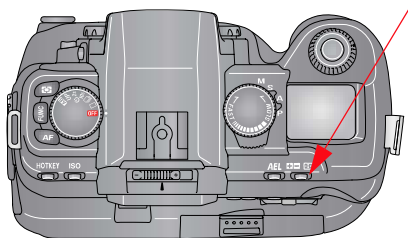

You can set the active Autofocus zone.

1. Lightly press the Shutter button to wake up the camera.
2. Press the Exposure Compensation / AF Zone button twice in quick succession. Continue pressing the button after the second press.  
The current active AF zone brackets are illuminated on the Viewfinder focus screen.
3. Rotate the C-Dial clockwise to select the desired zone (center, right, left, up, down, or all), then release the Exposure Compensation / AF Zone button.

If you set the Autofocus zone to All, the camera focuses on the closest object that a single zone detects.

4. Lightly press the Shutter button to enable your selection and exit the AF Zone function.

### Capturing Images in Single AF Mode

Single AF mode is useful when you recompose a picture with the main subject off-center.

1. Lightly press and hold the Shutter button to activate autofocus.
2. Continue lightly pressing the Shutter button until the subject is in focus (focus priority).

When the subject is in focus, the focus indicator appears in the viewfinder and the focus is locked.

When the focus indicator appears, the exposure values are locked (shutter speed and aperture values).

When the subject is in focus, the focus zone's brackets flash.

If the AF Electronic Sound is enabled (see [page 5-30](#)), an electronic sound confirms correct focus.

When the camera is unable to focus on the subject, the focus indicator blinks. Remove your finger from the Shutter button and lightly press again.

3. Fully press the Shutter button to capture the image.

**NOTE:** If the distance between the camera and the subject changes, you must refocus.

### Capturing Images in Continuous AF Mode

Continuous AF mode is useful for photographing moving subjects where you may want to capture an image even before the subject is in focus.

1. Lightly press the Shutter button to activate autofocus.

If the subject is in motion, the camera focuses continuously.

The focus indicator does not appear in the viewfinder and focus lock does not work.

2. Fully press the Shutter button to capture the image, even if the subject is not precisely in focus.

**NOTE:** Depending on the situation, (for example, speed and direction of a moving subject, the lens, and shutter speed) there is a possibility that the picture may be out of focus.

## Locking Focus

To capture an image of a subject that is out of the focus detecting area, use Focus Lock. You can use this function only in  (Single AF mode)

1. Compose the picture with the subject in the center of the viewfinder, then lightly press the Shutter button.
2. Continue lightly pressing the Shutter button while you compose the picture as desired. Then fully press the Shutter button to capture the image.

## Manual Focus

In situations where autofocus or focus lock are not effective, you can focus manually.

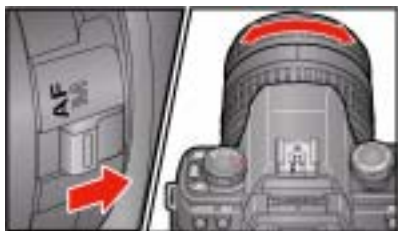

1. Set the Focus Mode switch on the lens to **M**.  
The AF Mode icon disappears from the Top Status LCD.
2. While looking through the viewfinder, turn the lens Focusing ring until your subject is clear and sharp.

**NOTE:** When you use a lens, with a maximum aperture of F5.6 or faster, the focus indicator in the viewfinder appears when correct focus is attained.



# 9 Capture Workflow

This chapter outlines two general workflows to help you manage images captured on your KODAK PROFESSIONAL DCS Pro SLR/c Digital Camera (DCS Pro SLR/c). The workflows may vary between studio sessions and between different types of photography jobs on locations.

The following workflows are described:

- Image capture when the camera is not connected to a computer
- Image capture when the camera is connected to a computer

## Capture Workflow when the Camera is Not Connected to a Computer

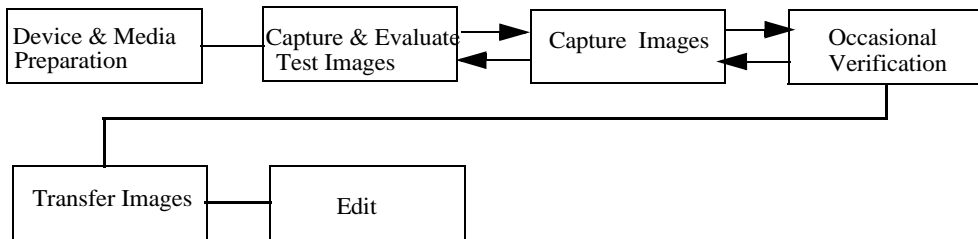

### Device and Media Preparation

- Install the included software.
- Calibrate your monitor and printers regularly, for example, weekly.
- Charge one or more batteries. Insert a battery.
- Set the time and date, if needed.
- Set the Exposure mode.
- Choose an Exposure Metering mode.
- Set the Autofocus mode.
- If you have used a memory card for several sessions (two or three dozen), you may want to format it on the camera you will be using so that the full capacity of the card is available and the Recover Card feature will function.
- Insert each memory card to be used and check the Back Status LCD to be sure there is adequate space available. Delete images if necessary.
- Choose a capture folder and a file type.
- Set ISO based on available light.
- Set up White Balance.  
To set up White Balance on the camera, select an image with a MACBETH color chart, a gray card or a neutral area in the image, then perform Click Balance.  
To set up White Balance in the KODAK PROFESSIONAL DCS Photo Desk software, capture an image of a MACBETH color chart, a gray or white card, then adjust later using the software.
- Set up Job Tracker, if needed.

**NOTE:** Custom RGB slider values in DCS Photo Desk software are not saved as part of custom White balance files generated by the DCS Photo Desk software.

## Capturing and Evaluating Test Images

Before your photo session begins, and occasionally during a session, you should capture and evaluate images to be sure that the lighting and camera setup are producing the desired results.

Image Attribute	DCS Pro SLR/c Tool	Suggested Action
Exposure	Appearance of image on Image LCD	View images and interpret information from the tool. Adjust camera settings (aperture, shutter speed, ISO) and/or lighting. Recapture image, if needed.
	Histogram Image mode provides exposure information about the overall image.	
	Luminometer provides exposure information about a specific area of the image. It shows the level of luminance channel saturation of pixels below the crosshairs on the Image LCD.	
Focus	Zoom Image mode	View the image at 1:1 and evaluate sharpness and edge definition in high-contrast areas (for example, eyes). Adjust lens focus and/or check and adjust the depth of field.
Color	Click Balance neutralizes color shifts in subsequently captured images.	Repeat, as necessary, when lighting conditions change.
Scene content and composition	Appearance of image on Image LCD	Look for undesirable details such as closed eyes. Recapture image, if needed.
	Zoom Image mode	

## Capturing Images

Set up any of the following, as needed:

- Vertical Release
- Intervalometer
- Job Tracker
- Self Timer

Press the Shutter button (or the Vertical Shutter button) to capture the image.

### Occasional Verification

To assure the highest image quality, evaluate test images at each location and at the various illuminance conditions. Also use the Image LCD regularly to verify that images are captured and stored correctly.

You may want your customer to review images while still on location. View images using one of the following:

- Image LCD using one of several Image modes
- Connected video monitor. (The Image LCD is disabled when this is in use.)
- Remove the memory card from the camera and plug it into a laptop computer. View the images using KODAK PROFESSIONAL DCS Photo Desk software.

### Transferring Images

When the photo session is complete, insert the memory card in a card reader connected to your computer. You can then open, edit, transfer, copy, and save images using the included software, or you can send them to a lab.

- Create folders on the computer hard drive for storing images. Use meaningful names to help you locate the images.
- Backup your original images on a CD or Zip disk.

### Editing Images

If you save images as JPEG on your camera, you can open and edit them in any image editing application.

Two editing applications are included with your camera. These applications allow you to do enhanced DCS-specific image editing. Refer to each application's associated Help.

**KODAK PROFESSIONAL DCS Photo Desk**—Allows you to open Raw (.dcr) or JPEG (.jpg) files, perform DCS-specific image edits, then save the images in a variety of formats.

**KODAK PROFESSIONAL Extended Range Imaging File Format Module**—Allows you to open ERI JPEG files. It reconstructs extended dynamic range/color gamut images and displays a preview. You can perform a limited set of DCS-specific image edits, then acquire the images into ADOBE PHOTOSHOP or ADOBE PHOTOSHOP Elements.



**KODAK PROFESSIONAL DCS  
Photo Desk**

Platforms: WINDOWS and MACINTOSH

When you open Raw images in DCS Photo Desk you can do the following:

- Crop and rotate
- Color balance
- Sharpen
- Reduce noise
- Check camera settings
- Create IPTC data
- Print
- Correct color moiré
- Perform Exposure compensation
- Manage color

**KODAK PROFESSIONAL  
Extended Range Imaging  
File Format Module**

Platforms: WINDOWS and MACINTOSH

When you open ERI JPEG files in the Extended Range Imaging File Format Module you can do the following before acquiring into ADOBE PHOTOSHOP:

- Rotate
- Color balance
- Perform Exposure compensation
- Manage color

### Capture Workflow when the Camera Is Connected to a Computer

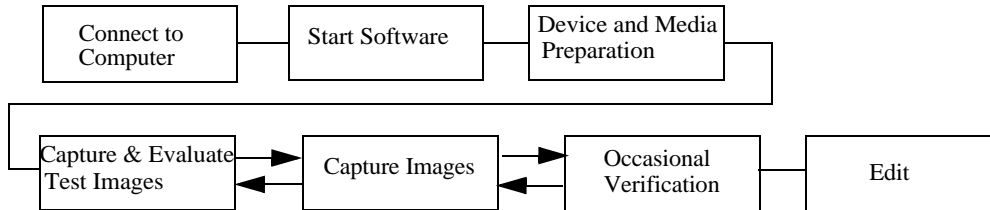

#### Connecting to a Computer and Power Supply

Connect the DCS Pro SLR/c to your computer and power supply. Use the included AC adapter as your power supply. (You can use a battery, but the AC adapter provides an unlimited source of power.)

#### Starting the Capture Software

KODAK PROFESSIONAL DCS Camera Manager is included with your camera. Start this software and use it to capture images when your camera is connected to a computer. Refer to its associated Help.

#### Device and Media Preparation

- Install the included software.
- Calibrate your monitor and printers regularly, for example, weekly.
- Set up folders on your computer to hold images as they are captured. Name folders according to studio needs or procedures.

#### Capturing and Evaluating Test Images

Review and evaluate images and make necessary adjustments using:

- Included software.
- Camera tools.

#### Capturing Images

Specify whether you want files saved as Raw, JPEG, or Raw+JPEG. (If you expect to edit the file, it is recommended that you choose Raw or Raw + JPEG. Consider Raw files as your “digital negative.”)

Refer to DCS Camera Manager Help for instructions on capturing images.

#### Occasional Verification

Captured images appear on the computer monitor when you are running DCS Photo Desk.

#### Editing Images

See [page 9-4](#).

# 10 Flash Photography

This section covers general instructions for performing flash photography with the KODAK PROFESSIONAL DCS Pro SLR/c Digital Camera (DCS Pro SLR/c). Your flash's operation may be different from what is described here. Refer to its instructions manual for more information.

## Compatible Flash Units

The DCS Pro SLR/c is compatible with the following flash models:

SIGMA Electronic Flash	EF-500 DG SUPER
CANON EOS Speedlites	220EX
	420EX
	550EX
CANON	MacroLite Ring MR-14EX
	Macro Twin Lite MT-24EX
	ST-E2 E-TTL Transmitter



### CAUTION:

**Flashes with excessive trigger circuit voltage will damage your camera. Your camera is not compatible with sync voltages of 250V or higher.**

### Mounting a Hot Shoe Flash

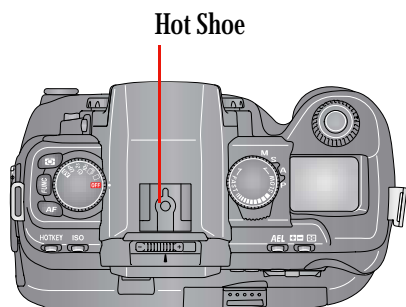

- Mount an optional CANON EX-series Speedlite or a SIGMA EF-500 DG Super flash to the Hot Shoe. See your strobe's instruction manual for mounting information.

### Connecting a Studio Flash

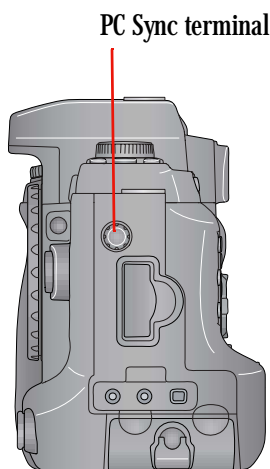

- Attach the sync cord from your studio strobe system to the PC Sync terminal. The terminal is threaded to provide a secure connection.
- NOTE:** When using the PC Sync terminal, you can obtain the fastest flash sync speed of 1/180 sec. by rotating the S-Dial until "SYC" appears on the Top Status LCD. You must be in Manual or Shutter Speed Priority Exposure mode to obtain this setting.
- NOTE:** The center post on your flash sync cord must be the positive terminal.

## Available Features

The following features are available when you use a compatible flash unit with the DCS Pro SLR/c:

- E-TTL autoflash
- High-Speed sync (see [page 10-4](#))
- Flash Exposure lock (see [page 10-4](#))
- Flash Exposure compensation (see [page 10-5](#))
- Flash Exposure bracketing (see [page 10-5](#))
- E-TTL wireless autoflash with multiple flash units (see [page 10-5](#))

**NOTE:** The maximum flash sync speed is at a shutter speed of 1/180 sec. When you are performing flash photography using a flash mounted on the Hot Shoe, if the Top Status LCD displays a value of 200, the actual shutter speed is 1/180 sec.

## E-TTL Autoflash

With E-TTL (Evaluative Through the Lens) Autoflash, the correct flash exposure is determined by the DCS Pro SLR/c. The E-TTL Autoflash works in any Auto Exposure mode. However, you may want to use a tripod to avoid camera shake for situations where a slow sync speed has been set. The standard shutter speed range for all flash units is 30 sec. to 1/180 sec.

1. Select one of the following:
  - Program AE mode (see [page 7-8](#))
  - Aperture Priority AE mode (see [page 7-11](#)).
  - Shutter Speed Priority AE mode (see [page 7-12](#))
  - Manual mode (see [page 7-13](#))
2. Turn on the flash and verify that the flash charges and its ready light comes on. Follow the instructions in the flash manual to put it into E-TTL mode.

The Viewfinder Flash indicator should be on and not flashing.
3. In Program Auto Exposure mode:
  - Focus the subject.In Aperture Priority AE, Shutter Speed Priority AE, or Manual mode:
  - Lightly press the Shutter button to verify settings.
4. Fully press the Shutter button to capture the image.

### High Speed Sync Mode

Use High Speed Sync mode (FP Flash) when you want a shutter speed higher than 1/180 sec. For example, you might use this mode in daylight to blur the background by using a larger aperture, to create a catchlight in the subject's eyes, or to fill in the shadows on the subject's face.

1. Set the flash to High Speed Sync mode.
2. Set the Exposure mode to either **S** or **M**, then set the desired shutter speed.

### Flash Exposure Lock

Use Flash Exposure Lock (FE Lock) to control the exposure of a specific area within a scene.

1. Select Normal or High Speed Sync mode on your hot shoe mounted flash.
2. Turn on the flash and verify that the flash charges and its ready light, turns on.
3. Focus on the subject.
4. Aim the camera so that the area of the scene where flash exposure is to be locked appears in the Center Area Metering circle in the Viewfinder.
5. Press and hold the AEL button on the camera and lightly press the Shutter button.

The flash fires and the camera calculates the Flash Exposure Lock.

6. Continue to press the AEL button and release the Shutter button.  
The AEL icon in the viewfinder will be on.
7. Recompose the scene. Lightly press the Shutter button, then capture the image.

**NOTE:** If the Custom Setting "Soft Press AE-L" is enabled when a compatible flash unit is installed on the DCS Pro SLR/c, a soft press of the Shutter button performs the Flash Exposure Lock function. See "[Custom Settings Table](#)" on page 5-3 and "[Compatible Flash Units](#)" on page 10-1.

## Flash Exposure Compensation

You can use Flash Exposure Compensation to adjust the flash's output. Generally, the compensation setting remains enabled until you set it back to zero. The incremental and total amount are a function of your flash. See its instruction manual. If you have a compatible flash installed, you may also adjust the flash output by using the Exposure Compensation function on the camera.

## Flash Exposure Bracketing

With Flash Exposure Bracketing, you can capture bracketed images of the same subject at three different flash exposure levels. The order of the bracketed images, the total bracket range, and the bracket increment are controlled by your flash.

See the instructions included with your flash.

## Previewing Flash Results

You can preview the effects of your flash setup using the camera's Depth of Field Preview button.

1. Set up your camera and hot shoe mounted flash for flash photography.
2. Press the Depth of Field Preview button and look through the viewfinder to determine the effects of flash lighting on the scene.

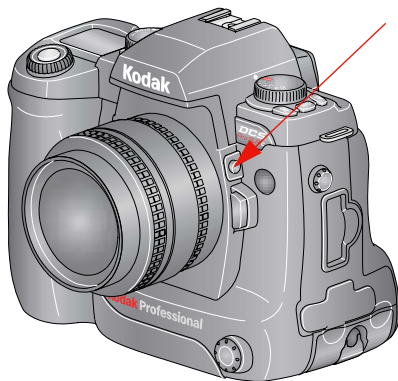

### **⚠ CAUTION:**

**Consult your flash manual for information on how often you can use this feature. Overuse will damage your strobe.**

## Wireless Flash with One or More Flash Units

With some flash units, for example, the CANON 550EX Speedlite, you can set up multiple wireless flash units. Refer to the instructions included with your flash for more information.





# 11 Working with Images on the Camera

## Reviewing Images

To review images on the Image LCD:

1. Select an Image mode.
2. Select a review folder (see [page 11-6](#)).
3. Browse through the images (see [page 11-7](#)).

## Selecting an Image Mode

- Single Image
- Histogram
- Zoom
- Multiple Image

1. If the Image LCD is off, press the OK button to turn it on in Image mode.

If a menu appears in the Image LCD, press the Menu button one or more times to change to Image mode.

The last-accessed Image mode appears.

2. Press the top or bottom of the Five-way control to sequence through the Image modes in the following order: Single Image, Histogram, Zoom, and Multiple Image.

The Image Mode menu appears briefly. It shows the four Image modes with the selected mode highlighted.



## Working with Images on the Camera

### Changing the Duration of the Image Mode Menu Display

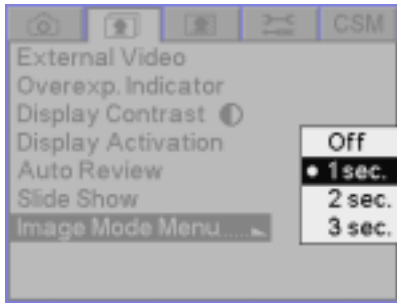

The Image Mode menu appears for one second after you select an Image mode. You can change the duration of its display or turn it off.

1. Choose Image Mode Menu from the Review menu, highlight Off, 1 sec, 2 sec, or 3 sec.
2. Press the OK button.

### Single-Image Mode



The selected image appears.

## Histogram Mode



When Histogram mode is active, the selected image, its histogram, and the following information appear:

- Exposure mode
- Aperture
- Shutter speed
- Exposure compensation (when relevant)
- Time/date of image capture
- Tag icon (if image has been tagged)
- Sound icon (if sound file has been recorded)

**NOTE:** Highlight data in the "ERI" zone of the histogram is clipped with normal processing. Recover ERI data using Exposure / Tone in KODAK PROFESSIONAL DCS Photodesk software.

## Interpreting a Histogram



Overexposure

Underexposure



High key

Low key

- A histogram that is clipped at the right indicates overexposure and one that is clipped at the left indicates underexposure.
- A histogram that peaks towards the right indicates a high-key image without many dark tones. One that peaks on the left indicates a low-key image without many light tones.

### Zoom Mode



The selected image appears with a region of interest (ROI) box and a highlighted center square. The region of interest box includes the area of the image that appears when you zoom in.

**NOTE:** You can only Zoom Raw image files. Zoom Mode is not available when reviewing JPG files

### Enabling or Disabling the Region of Interest Box

- Press the OK button to enable the region of interest box.  
You can pan or zoom when the region of interest box is enabled.
- Press the Cancel button to disable the region of interest box.  
You can navigate to a different image when the region of interest box is disabled.

### Zooming

- With the region of interest box enabled, press the OK button.  
There are three zoom levels. The first actuation zooms to 1:4 (one pixel displayed for every four in the image), the second to 1:1, and the third returns to the un-zoomed 1:16.

**NOTE:** When zoomed to 1:1, the crosshairs appear but the region of interest box does not. You can still pan.

### Panning

- With the region of interest box enabled, press any side of the Five-way control.  
If you reach the edge of the thumbnail, the image moves in the opposite direction.

## Luminometer

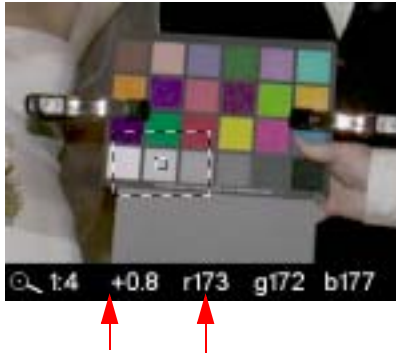

The center square, which appears when the region of interest box is enabled in Zoom mode, indicates the level of luminance channel saturation of pixels below the center of the crosshairs. This level is indicated in stops (-3 to 3.25) and RGB values.

## Multiple Image Mode



Four image thumbnails appear with the Status bar at the bottom. The selected image is highlighted.

## Status Bar



The Status bar appears at the bottom of the Image LCD in Single Image and Multiple Image modes. A tag icon appears if the image has been tagged, and a microphone icon appears if a sound file has been recorded.

**Selecting a Review Folder** The Nav+ button provides a shortcut for quickly navigating among folders and images within a folder.



**NOTE:** If there are two cards in the camera, the Nav+ button navigates on the card containing the currently selected folder.

1. Press the Nav+ button.

If the Image LCD is off, it turns on.

The last-accessed Image mode appears with the Nav+ overlay. The Nav+ overlay shows the selected folder highlighted and the location bar indicates the position of the currently selected image.

2. Press and hold the Nav+ button, then press the top or bottom of the Five-way control to highlight other folders on the memory card.

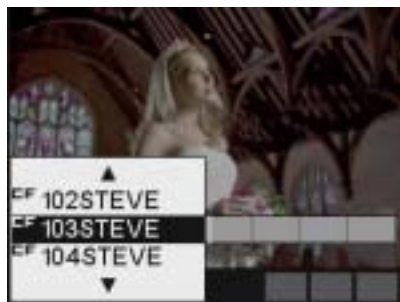

- Browsing Through Images**
- Press the left or right side of the Five-way control to navigate through images in the selected folder.

**NOTE:** In Zoom mode, with the region of interest box enabled, first press the Cancel button to disable the region of interest box.

The right side of the Five-way control navigates “forward” to higher-numbered images in the folder; the left side navigates “backward.”

If you continue navigating forward after the last image in the folder, the first image appears. If you continue navigating backward after the first image in the folder, the last image appears. (A blank screen appears before the first or last image to indicate that the display is wrapping.)

### Browsing Through Images Using the Nav+ Button

- Press and hold the Nav+ button, then press the right or left of the Five-way control to display every tenth higher or lower-numbered image in the selected folder.

### Location Bar



The Location bar appears at the bottom of the Image LCD in Single Image mode, in Multiple Image mode, or in Zoom mode when the Region of Interest box is disabled. The bar indicates the position of the current image relative to the other images in the selected folder.

### Selecting an Image

As you navigate through the images in Multiple Image mode, the images are highlighted one at a time. Release the Five-way control when the desired image is highlighted.

As you navigate in other Image modes, the displayed image is selected when you release the Five-way control.

### Overexposure Indicator

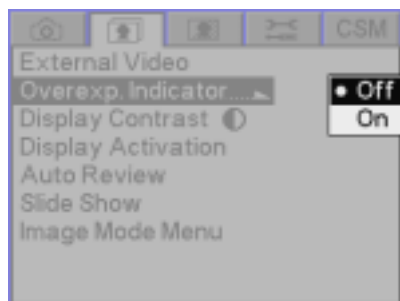

You can indicate areas of overexposure in Single or Multiple Image Display modes.

1. Choose Single or Multiple Image mode.
2. Choose Overexp. Indicator from the Review menu, then highlight Off or On.
3. Press the OK button.

When the overexposure indicator is turned on, areas of overexposure flash on and off.

### Changing Display Contrast and Brightness

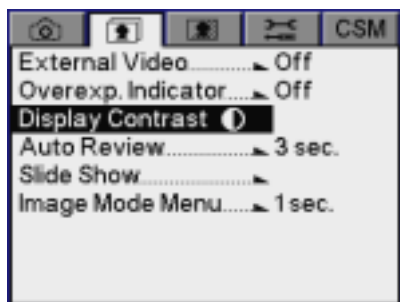

You can change the contrast and lighten or darken the images displayed on the Image LCD.

**NOTE:** Changing the contrast does not affect the stored images, only the view of the images on the Image LCD.

1. Choose Single Image mode.
2. Choose Display Contrast from the Review menu.



3. Press the OK button.  
Two slider bars and a gray scale appear.
4. Press the top or bottom of the Five-way control to lighten or darken the image.
5. Press the left or right of the Five-way control to adjust contrast.  
Use the gray scale bar as a guide in adjusting contrast.



## Auto Review

When you enable the Auto Review feature, the Image LCD turns on when you capture an image then displays the image for the amount of time you specify. After the specified amount of time, the Image LCD turns off.

If you lightly press the Shutter button while the image is displayed, the Image LCD turns off.

If you manipulate any digital buttons while the image is displayed, the Image LCD stays on and the display changes appropriately.

**NOTE:** If the Image LCD is on when you capture an image, the Auto Review feature has no effect.

1. Choose Auto Review from the Review menu, then highlight Off, 3 sec, 5 sec, or 10 sec.
2. Press the OK button.

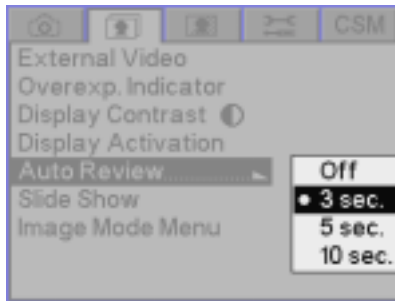

## Slide Show

You can run a slide show of camera images on the Image LCD and video monitor, or just on the Image LCD.

1. Connect and enable external video if you want the slide show to appear on a video monitor (see [page 12-1](#)).
2. Select the mode: choose Slide Show from the Review menu, then highlight Off, Continuous Loop, or Single Show.

In Continuous Loop mode all specified images appear, then the sequence is repeated until you press the Cancel button.

In Single Show mode, the slide show continues until all selected images have appeared once or until you press the Cancel button.



## Working with Images on the Camera

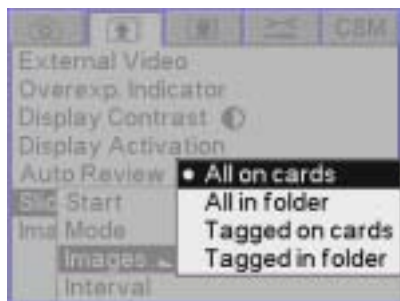

3. Select the images to appear in the slide show: Choose Slide Show from the Review menu, then highlight All on cards, All in folder, Tagged on cards, or Tagged in folder.

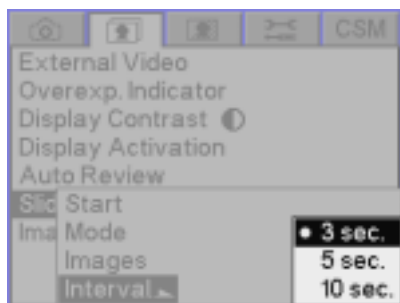

4. Select the length of time for each image to display: choose Slide Show from the Review menu, then highlight 3 sec., 5 sec., or 10 sec.

## Starting/Stopping a Slide Show

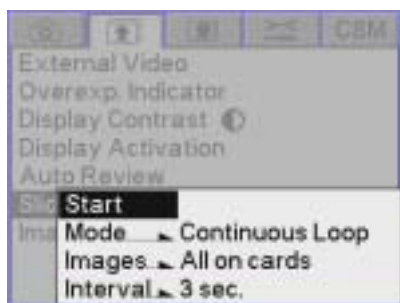

- Choose Slide Show from the Review menu, then highlight Start to start the show.
- Press the Cancel button at any time to stop the show.

## Deleting Images

You can delete a single image, all images in a folder or on a card, or all untagged images in a folder or on a card. Associated sound files are also deleted.

**IMPORTANT:** *When you capture a JPEG, Raw, or Raw+JPEG image to one or two cards, up to four copies of the image are saved. If you delete the image, all copies are deleted. To retain backup copies of the image, remove the second card before deleting.*

1. If the Image LCD is off, press the OK button to turn it on in Image mode.  
If the Image LCD is in Menu mode, press the Menu button one or more times to change to Image mode.
2. To delete images in a folder, select a review folder. To delete a single image, select the image.
3. Press the Delete button.
4. Press any side of the Five-way control to highlight the desired option.
5. Release the Five-way control to delete a single image or to display a confirmation screen when more than one image is to be deleted.
6. Press the OK button to accept the change and dismiss the confirmation screen.



**NOTE:** You may be able to recover deleted files if they have not already been overwritten.

### Tagging Images

You can tag one or more images for a variety of operations:

- On the camera, you can specify that the tagged images are not deleted.
- In the KODAK PROFESSIONAL DCS Photo Desk software, you can use tags as a selection mechanism for a variety of operations.
- Printers adhering to the DPOF (Digital Print Order File) standard will recognize and print images tagged for print. Your camera complies with the DPOF standard for printing files from a memory card. DPOF capability applies to JPEG images only. The option is disabled for RAW images.

**IMPORTANT:** *When you capture a JPEG, Raw, or Raw+JPEG image to one or two cards, up to four copies of the image are saved. If you tag the image, all copies are tagged.*

1. If the Image LCD is off, press the OK button to turn it on in Image mode.

If the Image LCD is on and a menu is displayed, press the Menu button one or more times to change to Image mode.

2. Select an image.
3. Press and release the Tag/Record button (less than one second) to display the Tag options.

A check mark (✓) appears next to options if the image has not been tagged for those options. If the image has already been tagged for an option, a slash appears through the check mark.

**NOTE:** If you hold the Tag/Record button for more than one second, you access the Record option.

4. Press any side of the Five-way control to highlight the desired option.
5. Release the Five-way control to tag or uncut the image.

When an image is tagged, a check mark (✓) appears on the Status bar when that image is selected. A check mark also appears in the histogram for the image.



## Recording Sound Files

You can record a sound file to annotate the selected image, either immediately after you capture it or later when you review it. If you delete the image using camera controls, or copy or delete it using the DCS Photo Desk software, the sound file will also be copied or deleted. If you copy or delete images without using the DCS Photo Desk software, you must also copy or delete the sound (.WAV) files.

1. If the Image LCD is off, press the OK button to turn it on in Image mode.

If the Image LCD is in Menu mode, press the Menu button one or more times to change to Image mode.

2. Select an image.

3. Press and hold the Tag/Record button (longer than one second).

**NOTE:** If you release the Tag/Record button in less than one second, you access the Tag option.

A microphone icon appears in the Digital Status LCD.

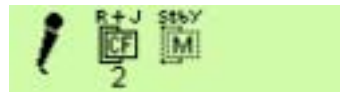
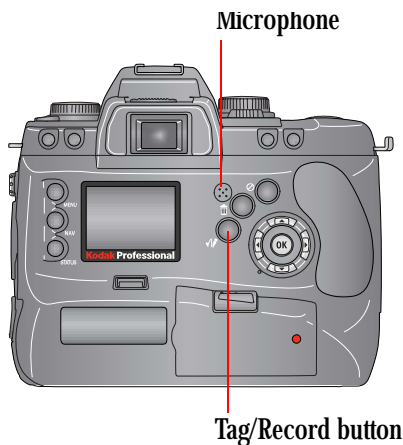

4. Record your message into the microphone.
5. Release the Tag/Record button.

The microphone icon disappears from the Digital Status LCD.



# 12 Viewing Image LCD Information on External Video

You can display images and menus on an external video monitor.

After you capture an image, it automatically appears on a connected video monitor where you can review it and decide if camera adjustments are necessary.

**NOTE:** Check that the Video Format is set properly.

## Connecting

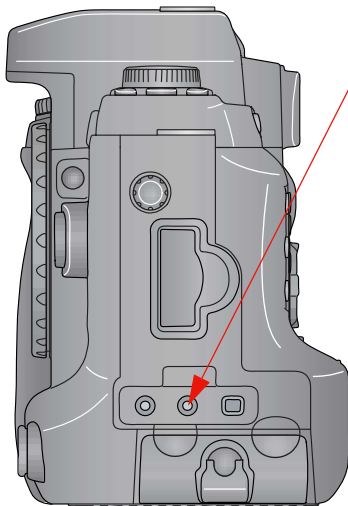

1. Connect a video cable (not included) with a 2.5mm phone plug to the Video port.

2. Connect the other end of the video cable to your monitor.

**NOTE:** Your dealer has a compatible KODAK video cable (catalog number 1817774).

### Enabling External Video

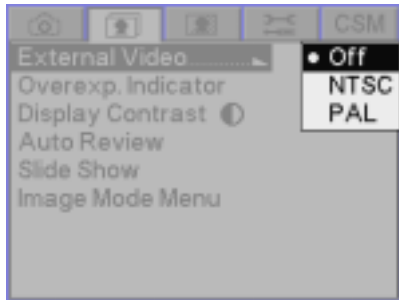

1. Choose External Video from the Review menu.
2. Choose NTSC or PAL to enable the Video port. Choose Off to disable the port.
3. Press the OK button.

**NOTE:** The selection of NTSC or PAL must match the capabilities and setup of your video monitor.

**NOTE:** When the External Video is set to PAL, a smaller font size appears on the Image Display LCD. Deactivate PAL video to return to a larger font size.





# 13 Connecting to Your Computer

There are two ways to access KODAK PROFESSIONAL DCS Pro SLR/c Digital Camera (DCS Pro SLR/c) images from your computer:

- Connect the camera to the computer using an IEEE 1394 cable, then capture images using the KODAK PROFESSIONAL DCS Camera Manager software. If you use DCS Camera Manager's Capture Preview mode, you can view images on your computer as they are captured. Once DCS Camera Manager transfers images to your computer, you can open, adjust, and process them using the KODAK PROFESSIONAL DCS Photo Desk software.
- Remove the memory card from the camera, insert it into a card reader, then open the images using DCS Photo Desk.

## Advantages to an IEEE 1394 Connection

- You can capture images and then view them on your computer within seconds.

## Advantages to a Card Reader

- You do not need a camera present to access images from your computer.
- Many laptop computers do not have IEEE 1394 connections; however, they do have card readers.
- You do not need to be connected to a computer when you originally take the picture.

### Connecting Your Camera to the Computer

**⚠ CAUTION:**

**Do not use IEEE 1394 repeaters when connecting your camera. Doing so can damage the camera.**

Connect your camera to the computer using an IEEE 1394 cable. This cable is needed to quickly transfer images from the camera to the computer. You can leave the camera and computer on while connecting or disconnecting the two.

You must have an IEEE 1394 connection available on your computer.

1. Connect the KODAK PROFESSIONAL DCS Pro Charger/AC Adapter or charge and insert the KODAK PROFESSIONAL DCS Pro Battery.

**NOTE:** Although you can use a battery, it is highly recommended that you use the charger/adapter as insurance against possible loss of data if the battery should lose its charge.

2. Install the KODAK PROFESSIONAL DCS Host Software for Macintosh or Windows-based computers if you have not already done so.
3. Connect the 6-pin end of the cable into any available port on the IEEE 1394 adapter card on your computer.

**⚠ CAUTION:**

**Be sure the connector orientation is correct when you connect the IEEE 1394 cable to the computer. Connecting incorrectly can damage your camera or computer. At the computer connection, the point on the 6-pin plug must align with the point on the computer port.**

**NOTE:** The adapter card may have multiple ports.

4. Connect the 4-pin end of the IEEE 1394 cable to the IEEE 1394 port on your camera.

**NOTE:** If the camera has an IEEE 1394 connection to a computer that is turned on, the camera never enters the Battery Save state. As long as the IEEE 1394 connection remains, the camera stays "awake", checking to see if the KODAK PROFESSIONAL DCS Camera Manager is running on the computer.

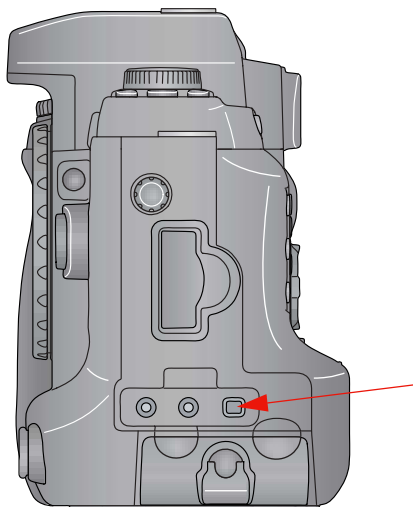

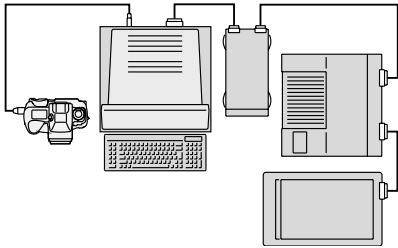

You may connect more than one camera or other IEEE 1394 devices to the card as long as you avoid a closed loop configuration. (The drawing indicates an acceptable configuration.)

The camera's IEEE 1394 port does not support a second pass-through connector and is meant to be the last device on the "daisy chain."

You can now access your camera from the computer. See the Help for the DCS Host Software on the DCS Host Software CD included with your camera.

## Quitting—Disconnecting from the Computer

Complete these steps when your work with the camera and the computer is complete. You can connect or disconnect the camera without turning the camera or the computer off.

**NOTE:** WINDOWS OS only. Do not disconnect the camera from the computer while KODAK PROFESSIONAL DCS Camera Manager is running. Doing so can cause your computer to "hang".

### CAUTION:

**Do not disconnect the camera from the computer while images are being transferred from the camera to the computer. Doing so can corrupt images on the computer.**

1. Quit the KODAK PROFESSIONAL DCS Camera Manager software if is running.
2. Disconnect the camera from the computer.

## Using the Card Reader

If your computer has a card reader, you can access images by placing a memory card containing camera images in the reader. If you have a new card reader, install it using the instructions accompanying the reader.

1. Remove the memory card from your camera.
2. Insert the memory card into the card reader on your computer.

### CAUTION:

**Do not remove a card from the card reader while KODAK PROFESSIONAL DCS Photo Desk is running. If images on the card are open in DCS Photo Desk, removing the card can cause you to lose data.**





# 14 Camera Care

## Handling

With careful handling, your KODAK PROFESSIONAL DCS Pro SLR/c Digital Camera (DCS Pro SLR/c) should produce images of the highest quality for years to come.

- Be careful not to drop your camera or subject it to shock. (While the camera has been designed for durability, it is a precision instrument and should be handled with care.)
- Keep the camera out of salt spray and protect it from excessive moisture. If you use it at the beach, clean it thoroughly afterward with a dry cloth.
- Do not leave the camera in an excessively hot place.
- Do not touch the camera's electronic contacts with your fingers. Touching the contacts can cause corrosion and affect proper camera operation.
- After removing a lens from the camera, place the lens face down on a flat surface to avoid damaging the electronic contacts on the lens mount.
- Condensation is a problem when bringing cold equipment into a warm place. If the autofocus optics cloud over, accuracy may be seriously affected. Before entering a warm place, put equipment in a plastic bag so that condensation forms on the outside of the bag.
- A spray gun-type blower may damage the optical glass if used to clean the lens. To avoid damage, hold the blower upright with its nozzle more than 30 cm (approximately 12 in.) from the lens surface, and keep the nozzle moving so that the stream of air is not concentrated in one spot.

## Cleaning



### **CAUTION:**

**Remove the lens from the camera before cleaning.**

1. Turn off the camera.
2. Disconnect the camera from the AC adapter and from the computer.
3. Using a clean, damp cloth, clean only the outside of the camera body, the Top Status LCD, the Back Status LCD, and the Image LCD.

**NOTE:** Do not use liquid cleaners or aerosol cleaners on the outside of the camera.

4. Clean the viewfinder eyepiece with a soft, clean cloth. Do not use alcohol.
5. To remove dust from the mirror or the focusing screen, gently blow the dust away using a commercially available bulb-type blower. Avoid directly touching any of these surfaces.
6. Clean the lens surface with a blower brush. To remove dirt and smudges, remove the lens from the camera, then use a soft, clean cotton cloth or lens tissue moistened with lens cleaner. Wipe in a circular motion from center to outer edge, taking care not to leave traces and not to touch the other lens parts.

**NOTE:** Do not lubricate the camera, lens, or lens contacts.

## The Imager

Light from the scene you are photographing strikes the imager when the camera's shutter is open. The imager converts this light into a digital image. If the imager's cover glass gets dirty, the quality of your images will be affected.

### Determining if the Imager is Dirty

Even though the imager is located inside the camera, it can get dirty. There are two ways to determine whether it needs cleaning:

- Examine a test image and look for imperfections that indicate dirt on the imager.
- Visually inspect the imager for dirt.

### Examining a Test Image

1. Capture an image of a plain white object, such as a clean, white wall.
2. Examine the image on the computer using the KODAK PROFESSIONAL DCS Photo Desk software. Imperfections in the image, such as dark clusters or streaks, may indicate a dirty imager.

### Inspecting and Cleaning the Imager



#### CAUTION:

**The imager is very delicate. It is important that you follow these instructions when inspecting and cleaning the imager. Failure to do so can damage your camera.**

1. Turn off the camera.
2. Remove the lens from the camera.
3. Power on your camera using a fully charged battery.



#### CAUTION:

**If the battery loses charge or the camera power is turned off during the cleaning procedure, the shutter can close and damage your camera.**

4. Put the camera in Manual Exposure mode (M). See [page 7-13](#).
5. Choose Imager Clean from the Tools menu, then choose Open.



6. Press the OK button.  
The mirror raises and the shutter opens.
7. Inspect the imager according to the TIB procedure at [www.kodak.com/go/dcs](http://www.kodak.com/go/dcs).
8. Choose Imager Clean from the Tools menu then choose Close.
9. Press the OK button.  
The shutter closes and the mirror returns.
10. Turn off the camera.
11. Replace the lens.



## Storing

Carefully check the camera's operation after lengthy storage, when the camera has not been used for a long time, or before an important trip or shooting assignment.

- When storing your camera, wrap it in a clean, soft cloth and place it in a well-ventilated, cool, dry, dust-free place.
- Keep the camera out of direct sunlight and away from hot spots such as the trunk or rear window shelf of a car.
- Avoid places where chemical agents such as moth balls are used.
- To prevent corrosion, avoid storing the camera in a laboratory or other location where chemicals are used.
- Do not store the camera in a drawer or other non-ventilated place.
- Remove the battery if you do not expect to use the camera for several days.
- Take the camera out and release the shutter occasionally to assure camera function.
- In a humid environment, store the camera inside a vinyl bag with a desiccant to keep out dust, moisture and salt.

**IMPORTANT:** *A minute amount of battery power is used even when the camera is turned off. This will affect the camera's shooting capacity after several days of storage.*

## Top Status and Image LCDs

Liquid crystal may respond relatively slowly in temperatures below 32° F (0° C). It may also darken in temperatures of around 140° F (60° C). The LCD panels return to normal function when the temperature returns to normal.



# 15 Serial Data Collection and Global Positioning System

The Serial port is used to exchange data with a variety of other digital products.

The following Serial Port settings are available:

- Serial In
- Serial Out
- Baud Rate

NOTE: All Serial Port settings persist across power cycles.

## Serial Data Collection

### Connecting a Device to the Serial Port

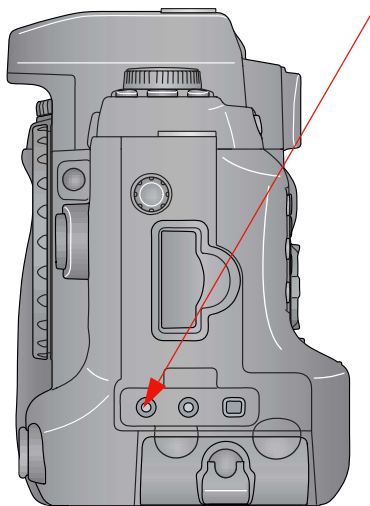

Use the Serial Port for connecting all devices except GPS units. See [page 15-5](#) for instructions on connecting and using GPS units.

1. Connect the appropriate end of the serial cable to the Serial port on your camera.
2. Connect the other end of the cable to the device.

NOTE: Your dealer has a compatible KODAK serial cable (catalog number 1157619).

## Serial In Mode

Using Serial In mode, your camera accepts text strings from a connected external device. The information is then added to specified image headers. Serial In and Serial Out modes can work simultaneously.

**NOTE:** The Scan-Shoot and Scan-Shoot Multi features allow connectivity of serial bar code scanners. To enable, contact your dealer of Kodak products.

1. Choose Serial Port from the Tools menu then choose Serial In.
2. Select a Serial In option, described below.

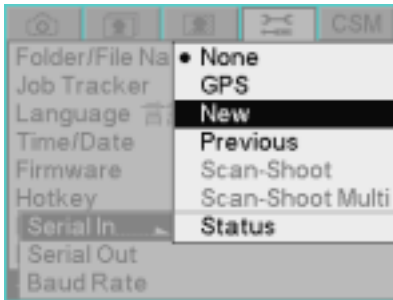

Menu Choice	Action	Comments
None	No data transmitted.	Serial port is unavailable.
GPS	A text string from the connected GPS device is written to the header of the just-captured image.	If a TRIMBLE GPS card is inserted in the camera, the TRIMBLE card overrides the serial port GPS functionality.
New	The text string from the connected device is written to the header of subsequent images.	Text string must be 250 valid characters, or less. Valid characters consist of ASCII characters, carriage return, and line termination.
Previous	A text string from the connected device is written to the header of previously captured images.	When you select New Images or Previous Image, a Serial In Status option becomes available.
Scan-Shoot	A scanned bar code value is written to the image header.	File type must be RAW. Select Scan-Shoot, scan a bar code, then capture an image.
Scan-Shoot Multi	Up to eight scanned bar code values are written to the image header.	File type must be RAW. Select Scan-Shoot Multi, scan up to eight bar codes, then capture an image.
Status	This option appears when you select New or Previous.	See <a href="#">page 15-3</a> .

## Serial In Status

When you choose New Images or Previous Image from the Serial In menu, the Serial In Status choice becomes available. When you choose Status, one of two screens appears.

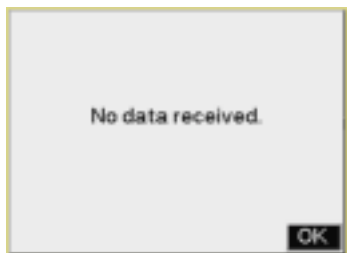
	<p>If the connected device is sending data, a message indicates the most recent data received.</p>
	<p>If there is no device connected or if a connected device is not currently sending data, this message appears.</p>

## Serial Out Mode

When the serial port is in Serial Out mode, your camera sends data to a remotely connected device.

NOTE: Serial In and Serial Out modes can work simultaneously.

1. Choose Serial Port from the Tools menu then choose Serial Out.
2. Select a Serial Out option, described below.

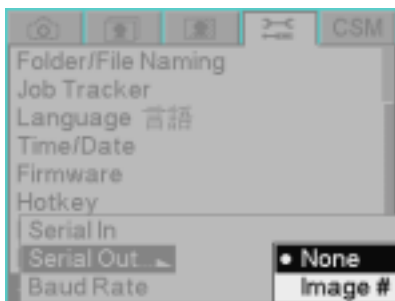

Menu Choice	Action
None	No data transmitted.
Image #	A text string containing the image number of the just-captured image is sent to the connected device.

### Setting the Baud Rate

Before transmitting data between the camera and a connected device, you must set the baud rate required by the device.

**NOTE:** Follow the device manufacturer's recommendations for baud rate.

1. Choose Serial Port from the Tools menu, then choose Baud Rate.
2. Select the required baud rate.



### Global Positioning System

Your camera has a Global Positioning System (GPS) feature which receives GPS data from a connected GPS unit and writes information about the current camera location to the image header.

### Requirements for Using the GPS Feature

To use the GPS feature on your camera, you need the following:

- GPS unit that supports standard NMEA data transfer
- GPS serial cable (from vendor supplying GPS units)
- RS232 3.5 mm cable to connect to the camera

## Using the GPS Feature

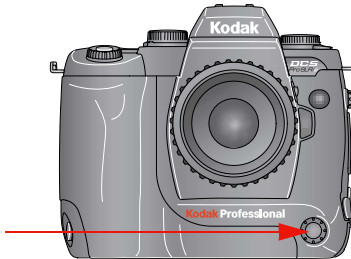

1. Connect the appropriate end of the GPS serial cable to the Remote Release Accessory port on your camera.
2. Connect the other end of the cable to the GPS unit.
3. On the GPS unit, set the output format to NMEA.
4. On the GPS unit, check the baud rate.
5. On the camera, set the baud rate to that shown on the GPS unit.



6. Choose GPS from the Tools menu.



7. GPS information appears. Press the OK button.

GPS information is written to the header of images captured while the GPS unit is connected.





# Appendix A: Specifications

Dimensions	Height: 136.5 mm (5.375 in.) Width: 149.2 mm (5.875 in.) Depth: 76.2 mm (3.0 in.)
Weight	895 g (1.97 lbs) without lens, battery or power module, or storage media
Image sensor	36 x 24 mm, 12 bit, RGB CMOS Imager Total pixels: 13.85 million Effective pixels: 13.7 million
ISO range	160 - 1600 (Raw) in 1/3 EV increments or 160 - 800 (JPEG, or Raw + JPEG) in 1/3 EV increments
Lens mount	CANON EF lenses and CANON tilt and shift lenses. Go to <a href="http://www.canoneos.com/">http://www.canoneos.com/</a> SIGMA lenses with CANON mount. Go to <a href="http://www.sigmaphoto.com/">http://www.sigmaphoto.com/</a>
Autofocus system	TTL phase difference detection system
Number of focus points	5
Autofocus sensitivity (ISO 100 with f/1.4)	-1 to 18 EV
Focus lock	Available
Shutter	Vertical-travel metal focal plane shutter, electronically controlled through entire speed range
Shutter speeds	30 sec. to 1/6000 sec. in 1/3-stop increments, Bulb mode, Flash Sync mode
Maximum flash synchronization speed	1/180 sec. 1/6000 sec. with a high speed flash (FP Flash)
Metering system	TTL full exposure metering
Metering modes	8 Segment, Average, Center Area

## Specifications

Metering sensitivity	-1 to 20 EV (ISO 100 with f/1.4)
Exposure Compensation	±3EV in 1/3 EV steps
AE Lock	Yes
Exposure modes	Program AE (shiftable), Aperture Priority AE, Shutter Speed Priority AE, Manual
Viewfinder	Pentaprism
Viewfinder magnification (50 mm lens @ infinity)	0.77X
Diopter adjustment	-3 to +1 dpt
Viewfinder eyepoint	18 mm
Viewfinder coverage	Approximately 92% horizontal and vertical. Focal length magnification: 1.0x
Viewfinder information	Center Area metering, Autofocus frame, Flash indicator, Focus indicator, Shutter speed, AE Lock indicator, Aperture value, Exposure meter, Auto bracketing
Top Status LCD	Sound setting, Shutter speed, Frame count, Auto bracketing, ISO, Exposure meter, Aperture value, Metering mode, Remote control, AF mode, Battery indicator
Digital Status LCD (backlit)	Capture information (interactive): White Balance, ISO, CF and SD/MMC Cards, Estimated images remaining on cards, Crop aspect ratio, JPEG quality, Raw and JPEG resolution Review information (read only): Current image number, current folder number, Crop aspect ratio, White Balance, Resolution, ISO Tool tips
Image LCD	1.8", 130,000-dot, low temperature polysilicon TFT LCD
Custom Settings	Mirror Prerelease Bracket order Soft press AE-L IR Remote Channel Sound Cues Meter Off Time

AE Bracketing	3EV, 1/3 EV steps, (normal, under, over)
Depth-of-Field Preview	Yes
Remote Control	3-channel Infrared (included)
Self timer	Yes (2 sec. or 10 sec.)
Electronic Strobe	E-TTL autoflash with compatible strobes PC Sync Terminal provided
Standard or ERI JPEG image resolution	13.5 MP: 4500 x 3000; 6 MP: 3000 x 2000; 3.4 MP: 2250 x 1500; .8 MP: 1125 x 750
Raw resolution	13.5 MP: 4500 x 3000, 6 MP: 3000 x 2000, 3.4 MP: 2250 x 1500
Image file formats	DCR (Raw archive file), user-selectable compression level (Standard or ERI JPEG)
Burst rate	1.6 images / second
Burst depth	See <a href="#">page A-4</a> .
White Balance	Automatic, Daylight, Fluorescent, Tungsten, Flash, Click Balance
Video output	NTSC or PAL selectable (Use KODAK cable, catalog number 1817774)
Host interface	IEEE 1394 (single 4-pin IEEE 1394 port, 400 MB/s)
Accessory interface	Remote Release cable GPS Serial cable
Removable storage	1 Type II CF+ compatible CF card, 1 SD/MMC card
Orientation sensor	Detects $\pm 90^\circ$ rotation about optical axis
Host software	KODAK PROFESSIONAL DCS Photo Desk, KODAK PROFESSIONAL DCS Camera Manager, KODAK PROFESSIONAL Extended Range Imaging File Format Module
PC Sync Terminal	Threaded, polarity insensitive, 1/180 sec. maximum sync speed
Drive mode	Single or Continuous
Date and time	Date and time is associated with each image file. Can be reset.

## Specifications



Power source	KODAK PROFESSIONAL DCS Pro Battery or KODAK PROFESSIONAL DCS Pro Charger / AC Adapter
Exposure meter	Activated by lightly pressing the Shutter button
Battery power confirmation	In Top Status LCD when camera is on
Tripod mount	1/4 inch

## Burst Depth

The burst depth (maximum number of images in a burst) varies, depending on the image resolution and the file format.

The following table shows approximate burst depth.

<b>Resolution and File Format</b>	<b>Number of Images</b>
13.5 MP Raw	19
13.5 MP Raw + 13.5 MP JPEG	6
13.5 MP JPEG	12
6.0 MP Raw	19
3.4 MP Raw	20

# Appendix B: Lens Compatibility

Your camera uses CANON EF-compatible lenses or SIGMA lenses with a CANON EF mount.

## SIGMA Lenses

For more information, go to  
<http://www.sigmaphoto.com/html/lenschart.htm>.

SIGMA Lenses
8mm F4 EX CIRCULAR FISHEYE
14mm F2.8 EX ASPHERICAL HSM
15mm F2.8 EX DIAGONAL FISHEYE
20mm F1.8 DG ASPHERICAL RF
24mm F1.8 EX DG ASPHERICAL MACRO
28mm F1.8 EX DG ASPHERICAL MACRO
MACRO 50mm F2.8 EX
MACRO 105mm F2.8 EX
APO MACRO 180mm F3.5 EX IF HSM
APO 300mm f2.8 EX HSM
APO 500mm f4.5 EX HSM
MIRROR 600mm F8
APO 800mm F5.6 EX HSM
15-30mm F3.5-4.5 EX DG ASPHERICAL
17-35mm F2.8-4 EX ASPHERICAL HSM
20-40mm F2.8 EX DG ASPHERICAL

<b>SIGMA Lenses</b>
24-70mm F2.8 EX DG ASPHERICAL DF
24-70mm F3.5-5.6 ASPHERICAL HF
28-70mm F2.8 EX SPHERICAL DF
28-70mm F2.8-4 HIGH SPEED ZOOM
MINI ZOOM MACRO 28-80mm F3.5-5.6 ASPHERICAL HF
MINI ZOOM MACRO 28-80mm F3.5-5.6 II ASPHERICAL
28-105mm F2.8-4 ASPHERICAL
28-105mm F3.8-5.6 UC-III ASPHERICAL I
28-135mm F3.8-5.6 ASPHERICAL IF MACRO
COMPACT HYPERZOOM 28-200mm F3.5-5.6 ASPHERICAL MA
COMPACT HYPERZOOM 28-300mm F3.5-6.3 ASPHERICAL
APO 50-500mm F4-6.3 EX RF HSM
APO 70-200mm F2.8 EX HSM
APO MACRO SUPER II 70-300mm F4-F5.6
70-300mm F4-5.6 MACRO SUPER
APO 100-300mm F4 EX IF HSM
100-300mm F4.5-6.7 DL
APO 120-300mm F2.8 EX IF HSM
APO 135-400mm F4.5-5.6 ASPHERICAL RF
APO 170-500mm F5-6.3 ASPHERICAL RF
APO 300-800mm F5.6 EX IF HSM

## CANON Lenses

For more information go to  
<http://www.usa.canon.com/eflenses/pdf/spec.pdf>

<b>CANON Lenses</b>	
EF 14mm F2.8	EF 600mm F4L IS USM
EF 15mm F2.8L USM	EF 1200mm F5.6L USM
EF 20mm F2.8 USM	EF 400mm F5.6L USM
EF 24mm F1.4L USM	EF 500mm F4L IS USM
EF 24mm F2.8	EF 16-35mm F2.8L USM
EF 28mm F1.8 USM	EF 20-35mm F3.5-4.5 USM
EF 28mm F2.8	EF 24-85mm F3.5-4.5 USM
EF 35mm F1.4L USM	EF 28-70mm F2.8L USM
EF 35mm F2	EF 28-80mm F3.6-5.6 type-5 USM
EF 50mm F1.4 USM	EF 28-90mm F4-5.6 USM
EF 50mm F1.8 type-2	EF 28-105mm F3.5-4.5 type-2 USM
EF 50mm F2.5 MACRO	EF 28-135mm F3.5-5.6 IS USM
MP 65mm F2.8 1.5XMACRO	EF 28-200mm F3.5-5.6 USM
EF 85mm F1.2L USM	EF 35-350mm F3.5-5.6L USM
EF 85mm F1.8 USM	EF 70-200mm F2.8L IS USM
EF 100mm F2.8 MACRO USM	EF 70-200mm F2.8L USM
EF 135mm F2L USM	EF 70-200mm F4L USM
EF 135mm F2.8 SOFT	EF 75-300mm F4-5.6 IS USM
EF 180mm F3.5L MACRO USM	EF 75-300mm F4-5.6 type-3 USM
EF 200mm F1.8L USM	EF 100-300mm F4.5-5.6 USM
EF 200mm F2.8L type-2 USM	EF 100-400mm F4.5-5.6 IS USM
EF 300mm F2.8L IS USM	TS-E 24mm F3.5

## Lens Compatibility



<b>CANON Lenses</b>	
EF 300mm F4L IS USM	TS-E 45mm F2.8
EF 400mm F2.8L IS USM	TS-E 90mm F2.8
EF 400mm F4 DO IS USM	



# Appendix C: Troubleshooting

## Problems, Causes, and Remedies

Problem	Cause	Remedy
Camera does not power on		Use a fully charged battery or the power module. Remove the memory card from the camera and try to turn the camera on.
Camera does not power on when the power module is used	The power module may not be fully inserted.	Be sure the cable is fully inserted into the power module (see <a href="#">page 3-2</a> ). <ul style="list-style-type: none"><li>You will feel and hear a soft "click" as the cable is inserted properly in place.</li><li>You may have to use a considerable amount of push to "click" the cable in place.</li></ul>
Nothing appears in the Top Status LCD	Battery is exhausted.	Replace the battery (see <a href="#">page 3-4</a> ).
	Battery is improperly installed.	Insert the battery properly.
Part of the Battery icon is off in the Top Status LCD	Battery is low.	Have a fresh battery ready.
The Battery icon blinks in the Top Status LCD	Battery is exhausted.	Replace the battery (see <a href="#">page 3-4</a> ).
	Battery is not functioning for unknown reason	Remove, then insert the battery and turn the camera on.

## Troubleshooting

Problem	Cause	Remedy
Shutter does not release.	Battery is exhausted.	Replace the battery (see <a href="#">page 3-4</a> ).
	D-Dial is set outside of the Drive area.	Set the D-Dial to one of the settings in the Drive area (see <a href="#">page 5-23</a> ).
	Camera cannot get proper focus in Single AF mode.	Focus on a different subject or use Manual focus (see <a href="#">page 8-5</a> ).
	Memory card is not inserted or is inserted incorrectly.	Insert the memory card correctly (see <a href="#">page 6-2</a> ).
	The camera is busy writing to the memory card.	Wait until the Card Busy light turns off (see <a href="#">page 6-2</a> ).
	Memory card is full.	Insert a new card (see <a href="#">page 6-2</a> ) or delete unwanted images (see <a href="#">page 11-11</a> ).
Shutter does not release. Camera seems to be locked. Cannot get out of custom settings.		Try resetting defaults (see <a href="#">page 5-13</a> ).
The buttons on the camera back don't work.	Battery Save is activated.	Lightly press the Shutter button. Change the Battery Save time (see <a href="#">page 5-2</a> ).
Camera seems to contain hidden information. There is less space on the card than there should be.	There can be hidden recycle bin folders on large cards if you have deleted images from your card using WINDOWS OS 2000. Hidden recycle bin folders can make your card seem smaller than it should be.	Format the card in your camera (see <a href="#">page 6-6</a> ).
Camera does not recognize the card in the camera.	The card may be malfunctioning. The card may not work properly with the camera.	Try a different card. If you have access to the Image LCD menus, format the card in the camera (see <a href="#">page 6-6</a> ).

Problem	Cause	Remedy
Card Busy LED and Card icon on the Digital Status LCD are blinking.	Data is being written to the memory card.	Do not remove the card until the blinking stops.
Accidentally deleted an image.		Use the Recover function (see <a href="#">page 6-7</a> ) to recover all images that have not been overwritten.
Can't recover deleted images.		Copy any images on the card to your computer, do a quick format (see <a href="#">page 6-6</a> ), then use the Recover function (see <a href="#">page 6-7</a> ). If the images have not previously been overwritten, it may be possible to recover them.
Color is not right.		Change the white balance setting to match the current lighting (see <a href="#">page 7-2</a> ). Consider capturing an image of a gray card and using Click Balance (see <a href="#">page 7-3</a> ).
Images have low contrast.		Use the histogram (see <a href="#">page 11-3</a> ) to see if you are using the full dynamic range. Consider changing ISO (see <a href="#">page 5-22</a> ) or using flash.
Some subject matter is out of focus.		Consider changing depth of field (see <a href="#">page 2-21</a> ), or increasing the f-number.
Images are blurry.	The Focus Mode switch on the lens is set to <b>M</b> .	Set the Focus Mode switch on the lens to <b>AF</b> (see <a href="#">page 8-1</a> ).
	Hand movement or camera shake occurred when the Shutter button was pressed.	Press the Shutter button more gently or use the Remote Controller or a tripod.
Images in the viewfinder look blurry.		Adjust the Viewfinder Diopter (see <a href="#">page 2-20</a> ).
The wrong language appears on camera screens.		Select the correct language (see <a href="#">page 5-12</a> ).
Incorrect date and time appears	Date and time setting may be incorrect.	Enter the correct time and date (see <a href="#">page 5-17</a> ).

## Troubleshooting

Problem	Cause	Remedy
Image contrast is wrong in the Image LCD.		Adjust using the Display Contrast feature (see <a href="#">page 11-8</a> ).
Exposure is off.		Capture a test image, use the histogram (see <a href="#">page 11-3</a> ) and zoom to 1:1 (see <a href="#">page 11-4</a> ) to view luminometer readings and determine if exposure adjustments (aperture, shutter speed, ISO) are necessary.
Exposure Meter icon blinks in the Top Status LCD.	The Exposure setting is out of range.	Choose an appropriate exposure value (see <a href="#">page 7-7</a> ).
Shutter Speed display shows "Err" in the Top Status LCD.	Lens aperture reset switch is defective.	Replace or repair lens.
	Main mirror is out of sequence with camera firmware.	Turn the camera off, then on.
The Top Status LCD does not light up.	Battery is exhausted.	Replace the battery (see <a href="#">page 3-4</a> ).
Autofocus does not work.	The Focus Mode switch on the lens is set to <b>M</b> .	Set the Focus Mode switch on the lens to <b>AF</b> (see <a href="#">page 8-1</a> ).
	The lens is not properly mounted.	Mount the lens correctly (see <a href="#">page 2-18</a> ).
Difficulty seeing images on the Image LCD	Image LCD is dirty.	Clean the Image LCD (see <a href="#">page 14-2</a> ).
	Image LCD is worn out.	Contact your camera dealer.
No image appears on the external video monitor.	Video cable is not inserted correctly	Insert the video cable correctly (see <a href="#">page 12-1</a> ).



# Appendix D: Warranty

CAREFULLY READ THE FOLLOWING WARRANTY TERMS AND CONDITIONS BEFORE USING YOUR CAMERA. USE OF YOUR CAMERA INDICATES YOUR ACCEPTANCE OF THESE TERMS AND CONDITIONS. IF YOU DO NOT AGREE WITH THEM, PROMPTLY RETURN THE CAMERA, UNUSED, ALONG WITH THE ACCOMPANYING MATERIALS, IN THE ORIGINAL PACKAGING.

## **KODAK PROFESSIONAL DCS Pro SLR/c Digital Camera**

THIS WARRANTY APPLIES ONLY TO EQUIPMENT PURCHASED IN THE UNITED STATES.

Kodak warrants your KODAK PROFESSIONAL DCS Pro SLR/c Digital Camera to be free from defects in material and workmanship for 1 year from the day of purchase.

## **Warranty Repair Coverage**

If this equipment does not function properly during the warranty period due to defects in material or workmanship, Kodak will, at its option, either repair or replace the equipment without charge, subject to the conditions and limitations stated herein. Such repair service will include all labor as well as any necessary adjustments and/or replacement parts.

If replacement parts are used in making repairs, these parts may be remanufactured, or may contain remanufactured materials. If it is necessary to replace the entire system, Kodak may replace it with a remanufactured system. Repair or replacement carries a 30-day warranty effective at the time of service problem resolution. This warranty will not extend the original warranty period, and in the case of parts replacement, will only apply to parts and labor performed to repair the equipment.

## Limitations

### **REPAIR OR REPLACEMENT WITHOUT CHARGE IS KODAK'S ONLY OBLIGATION UNDER THIS WARRANTY.**

**Warranty service will not be provided without dated proof of purchase.** Please return the Warranty Registration card within 30 days of purchase.

As a condition of warranty service, before sending in your equipment to a Kodak authorized service center for repair, you must first contact a Kodak representative for return authorization and instructions.

Should you need to return equipment to Kodak, Kodak is not responsible for the loss or damage of equipment while in transport to a Kodak authorized service center. You may, at your option, choose to insure equipment for loss or damage with the carrier of your choice.

This warranty becomes null and void if, during shipment, you fail to pack your KODAK PROFESSIONAL DCS Pro SLR/c Digital Camera in a manner consistent with the repacking instructions.

This warranty does not cover the following:

- Circumstances beyond Kodak's control
- Service or parts to correct problems resulting from the use of attachments, accessories or alterations not marketed by Kodak
- Unauthorized modifications or service
- Misuse
- Abuse
- Failure to follow Kodak's operating, maintenance, or repacking instructions
- Failure to use Kodak supplied items (such as cables)

**KODAK MAKES NO OTHER WARRANTIES, EXPRESS OR IMPLIED, AND SPECIFICALLY DISCLAIMS THE IMPLIED WARRANTIES OF MERCHANTABILITY AND FITNESS FOR A PARTICULAR PURPOSE. KODAK WILL NOT BE RESPONSIBLE FOR ANY CONSEQUENTIAL OR INCIDENTAL DAMAGES RESULTING FROM THE PURCHASE, USE, OR IMPROPER FUNCTIONING OF THIS EQUIPMENT EVEN IF THE LOSS OR DAMAGE IS CAUSED BY THE NEGLIGENCE OR OTHER FAULT OF KODAK. SUCH DAMAGES FOR WHICH KODAK WILL NOT BE RESPONSIBLE INCLUDE, BUT ARE NOT LIMITED TO, LOSS OF REVENUE OR PROFIT, DOWNTIME COSTS, LOSS OF USE OF YOUR CAMERA, COST OF ANY SUBSTITUTE EQUIPMENT, FACILITIES, OR SERVICES, OR CLAIMS OF YOUR CUSTOMERS FOR SUCH DAMAGES.**

## Outside the United States

In countries other than the United States, warranty terms may be different. Unless a specific Kodak warranty is communicated to the purchaser in writing by Kodak, no warranty or liability exists even though defect, damage or loss may be by negligence or other act of Kodak.

## How to Obtain Service

In the United States, call 1-800-23-KODAK (1-800-235-6325).

In Canada, call 1-800-GO-KODAK (1-800-465-6325).

In other countries, call your nearest Kodak representative.

If service is required, your Kodak representative will instruct you to return the unit to the nearest service center for repair and will issue a return authorization number.

When returning a KODAK PROFESSIONAL DCS Pro SLR/c Digital Camera for repair, you should pack the unit in its original packing materials according to the repacking instructions located on the shipping container. Packing will be the purchaser's responsibility if the original packaging has been discarded or is not available.

Return of the repaired or replaced equipment to the customer can be expected five to seven business days from the date the equipment is received by the service center.

### Product Support Options

During the warranty period for the KODAK PROFESSIONAL DCS Pro SLR/c Digital Camera, you are entitled to product support for both hardware and software, provided your camera is registered with Eastman Kodak Company. You may register with Kodak via mail, fax, or through Kodak's World Wide Web site: <http://www.kodak.com/go/DCSRegister>.

Support is provided through a variety of options:

1. **Technical Support through the Web site (<http://www.kodak.com>):**  
Support includes FAQs (Frequently Asked Questions), downloadable software updates, and technical topic articles for reading and downloading.
2. **FaxBack Documents on a variety of subjects.** In North America, the FaxBack system is available at the following phone number:  
1-800-508-1531
3. **Authorized Dealers:**  
Contact your authorized KODAK PROFESSIONAL dealer for help with camera operation and connection to your computer. Many dealers can also provide training for your graphics application software, integration consulting, and optional equipment. Authorized dealers can also provide help in purchasing a service maintenance agreement.
4. **Telephone Support:**  
Telephone support is available without charge during your warranty period only, by calling:

United States:            Call 1-800-23-KODAK (1-800-235-6325)

Outside United States:    Contact your local Kodak service representative

Your camera must be registered with Kodak to qualify for no-charge support. You will be asked to provide the serial number of your camera, and proof of purchase also may be requested to verify the current status of your warranty. Cameras found to be out of warranty will require a credit card payment for each call incident. There is no charge to register your camera with Kodak.



#### 5. Out-of-Warranty Support Options:

There will be a charge for out-of-warranty call incidents if you wish to speak to a Kodak support representative. A call incident is defined to include only those issues raised during the first telephone or email contact. Follow-up telephone calls by Kodak's representative, and callbacks to Kodak's Support Center to resolve the call incident will not be charged, provided a valid, active call number is provided. Calls to report bugs or anomalies will have any charges cancelled. Calls to arrange for service will have the charges cancelled or applied as a credit against the repair estimate or invoice.

Service maintenance agreements, which cover the repair and support of the DCS Pro SLR/c Camera and software, are available. In North America, please contact the regional Service Marketing group at: 1-800-645-6325.

No-charge options include:

- KODAK PROFESSIONAL World Wide Web site:  
<http://www.kodak.com/go/support>
- FaxBack documents
- Your KODAK PROFESSIONAL dealer





# Glossary

## **AE (Automatic Exposure)**

By using a built-in exposure meter, the camera determines the correct exposure value, which is combinations of shutter speed and/or aperture value.

## **AE (Automatic Exposure) lock**

The camera fixes and memorizes the exposure value with AE lock. For example, if a photographic subject is placed in the center and exposure value of the composition is fixed, the brightness of the background will not influence the exposure, even if the composition changes and the subject is moved from the center of a screen. (Use the AE lock button.)

## **AF (Auto Focus) AF Lock**

Using a built-in sensor, the camera adjusts the focusing automatically. In AF mode, you can lock the focus on the main subject. For example, compose the desired subject in the center of the viewfinder. With the focus locked at the same setting, you can re-compose the picture with the subject off-center and capture images. (Press the Shutter button half-way to use this feature.)

## **Aperture**

The lens opening of the iris diaphragm inside the lens. The amount of light, which strikes the image sensor, is adjusted by the iris diaphragm. The f-number (focal length/diameter of the aperture) indicates the size of this opening. The aperture size can be made larger or smaller. A large aperture (low f-number) gives bright results and a small aperture (high f-number) gives darker results.

## **Auto Power-Off**

For saving the battery power, your camera automatically turns off if you do not touch any camera controls.

## **CMOS**

Complementary Metal Oxide Semiconductor (CMOS) can perform signal amplification on a per-pixel basis. Significant current flows only during the switching operation. Therefore a CMOS image sensor can scan data rapidly, sustain high-speed operation and consume less energy.

## **Color temperature**

The numerical expression of the tone of the light, produced by a light source. The standard unit for color temperature is degrees Kelvin (K). Low color temperature implies warmer, more yellow/red light while high color temperature implies a colder, more blue light. The typical color temperature of tungsten light is 3200 K, a personal computer is 9300 K.

**Depth of field**  
**EV (Exposure value)**

The zone of sharpest focus in front of, behind, and around the subject.

A numeric value that expresses the amount of light for a given exposure. It depends on the brightness of the photographic subject and the sensitivity of the imager. If a photographic subject is bright, the EV will be large, and if the subject is dark, the EV will be small. If twice the amount of light reaches the imager's surface, the difference in exposure value will be +1, and if half the amount of light reaches the imager's surface, the exposure value changes by -1.

**Exposure**

The amount of light reaching the image's surface. The exposure is controlled by the combination of aperture and shutter speed.

**Exposure Compensation**  
**Exposure modes**

This function lets you intentionally overexpose or underexpose a picture.

**Program Auto:** Camera sets both shutter speed and aperture for correct exposure.

**Shutter Priority Auto:** You select the shutter speed and the camera sets the appropriate aperture for correct exposure.

**Aperture Priority Auto:** You select the aperture and the camera sets appropriate shutter speed for correct exposure.

**Manual:** You select both shutter speed and aperture, according to indications on the exposure meter

**f-number**

The numbers on the lens aperture ring that indicate the relative size of the lens aperture opening.

**Histogram**

The image histogram shows the range and distribution of tonal values for an image. The tick marks at the bottom of the histogram represent photographic stops relative to the factory-determined 18% gray level. The range of stops is from +3 to -7. The double bar tick mark indicates the exposure value associated with 18% gray. Tick marks to the right of the double mark indicate one-stop increments brighter than 18% gray, and tick marks to the left indicate one-stop increments darker than 18% gray.

**ISO**

ISO is the international standard for representing film sensitivity. The higher the number, the greater the sensitivity, and vice versa. For example, ISO 200 is twice as sensitive as ISO 100, and half that of ISO 400. When you change the ISO setting on your camera, you adjust the sensitivity of the imager equivalent to the corresponding film sensitivity.

**JPEG**

Joint Photographic Experts Group has established a standard method for compressing and decompressing digitized images. If the rate of compression is high, the file size will be small but picture quality will be decreased.



<b>LCD</b>	Liquid Crystal Display. Your camera has four: the Top Status LCD panel, Back Status LCD panel, Image LCD panel, and the LCD inside the viewfinder.
<b>Microdrive</b>	Developed by IBM, Microdrives are small, hard disks that can fit in a CompactCard memory slot. The Microdrive is built into a Type II CompactFlash form factor.
<b>NTST</b>	National Television Standards Committee (NTSC) video format is primarily used in the United States, Japan, Canada etc. NTSC is a standard for television and videos, which defines a composite video signal with a refresh rate of 60 half-frames (interlaced) per second. Each frame contains 525 lines and can contain 16 million different colors.
<b>PAL</b>	Phase Alternating Line (PAL), video format primarily used in Europe, excluding France, as well as Australia and parts of the Far East. PAL delivers 625 lines at 50 half-frames per second.
<b>RAW</b>	The RAW image format is the data as it comes directly from the image sensor of the camera. No in-camera processing is performed before transferring the image to computer.
<b>Shutter Speed</b>	The camera's shutter opens for a length of time to control the amount of light that reaches the imaging element. The length of time the shutter blinds are open allowing light to strike the image sensor is called shutter speed.
<b>White balance</b>	The human eye and brain adapt to changes in lighting conditions, not only to intensity, but also to the color characteristic of the light source, so that colors of the objects look normal or accurate. For example, a white object will appear white whether it is viewed under sunlight, tungsten or fluorescent illumination. Your camera must be adjusted, so that colors will be represented accurately, under different types of illumination. This adjustment is called white balance.



# Index

## A

- aperture-priority auto exposure mode, 7-11
- auto exposure bracketing, 7-18
- auto exposure lock, 7-16
- autofocus, 8-1
  - situations where autofocus may not work as expected, 8-2

## B

- basic camera operations, 4-15
- basic menu, using, 4-2
- basic mode, 4-1
  - changing display contrast, 4-8
  - checking the firmware version, 4-10
  - digital status lcd, 4-3
  - formatting a card, 4-7
  - hotkey button shortcut to menu options, 4-14
  - setting, 4-2
  - setting ISO, 4-4
  - setting resolution, 4-6
  - setting time and date, 4-13
  - setting user mode, 4-13
  - turning overexposure indicator on and off, 4-9
  - updating firmware, 4-11
- batteries
  - battery save time, 5-2
  - charging, 3-2
  - checking status, 3-4
  - conserving, 3-5
  - CR 2032 coin cell, 3-6
  - disposing of, 3-6
  - inserting, 3-4
- bracketing, 7-18
- browsing through images, 11-7

## C

- camera
  - back, 2-2

- bottom, 2-3
- cleaning, 14-2
  - front, 2-1
  - handling, 14-1
  - media door, 2-4
  - side, 2-3, 2-4
  - storing, 14-5
  - top, 2-2
  - turning on and off, 2-6
- camera care, 14-1
- camera straps, 2-24
- cancel button, 2-8
- capturing images
  - vertical orientation, 5-18
- card reader, 13-3
- CF cards, 6-1
- charging batteries, 3-2
- cleaning the imager, 14-3
- cleaning your camera, 14-2
- click balance, 7-3
  - deleting saved settings, 7-6
  - loading a setting from a memory card, 7-6
  - saved settings menu, 7-4
  - saving a setting on the camera, 7-5
  - using a saved setting, 7-4
  - using the current image, 7-3
- COMPACTFLASH cards, 6-1
- computer
  - connecting to, 13-1, 13-2
  - disconnecting from, 13-3
- configuring your camera, 5-1
- connecting camera to computer, 13-1
- CR 2032 coin cell, 3-6
- crop aspect ratio, 6-11
- custom settings, 5-3
- custom settings table, 5-3

# Index



- D**
  - DCS Pro SLR/c
    - back, 2-2
    - bottom, 2-3
    - front, 2-1
    - media door, 2-4
    - side, 2-3, 2-4
    - top, 2-2
    - turning on and off, 2-6
  - defaults, resetting, 5-13
  - delete button, 2-9
  - deleting images, 11-11
  - depth of field preview button, 2-21
  - digital buttons, 2-7
  - digital exposure correction, 6-14
  - digital status button, 2-9
    - shortcut to menu options, 2-16
    - shortcut to menu options in basic mode, 4-3
  - digital status lcd, 2-13
    - basic mode, 4-3
  - diopter, 2-20
  - display contrast
    - changing in basic mode, 4-8
  - display contrast, changing, 11-8
  - disposing of batteries, 3-6
  - drive mode, 5-23
- choosing the type, 6-3
  - JPEG resolution, 6-12
  - naming, 5-8
  - RAW resolution, 4-6, 6-12
  - recovering after deletion, 6-7
  - types, 6-3
- firmware
    - downloading to your computer, 5-6
    - updating in basic mode, 4-11
  - firmware version
    - checking, 5-5
    - checking in basic mode, 4-10
  - flash photography, 10-1
  - focus, 8-1
    - locking, 8-5
  - focus modes, 8-1, 8-2
    - manual, 8-5
  - folders
    - creating, 6-10
    - naming, 5-8
    - selecting for captured images, 6-9
    - setting crop aspect ratio, 6-11
  - formatting memory cards, 6-6
  - four-way switch, 2-7
- G**
  - glossary, 1-1
- H**
  - handling your camera, 14-1
  - histogram mode, 11-3
  - histogram, interpreting, 11-3
  - hot shoe, 2-22
  - hotkey button, 2-9
    - shortcut to menu options, 2-17
    - shortcut to menu options in basic mode, 4-14
  - hotkeys
    - setting, 5-9
- I**
  - image lcd, 2-10
    - turning on, 2-11
  - image mode menu, changing the duration of its display, 11-2
  - image, selecting, 11-7
- F**
  - files



imager, 2-19  
   cleaning, 14-3  
 images  
   deleting, 11-11  
   reviewing. *see* reviewing images  
   tagging, 11-12  
 inserting batteries, 3-4  
 intervalometer, 5-20  
   changing settings, 5-21  
 ISO, 5-22  
   setting in basic mode, 4-4  
   setting using camera controls, 5-22  
   setting using the image lcd, 5-22  
  
**J**  
 job tracker, 5-10  
   loading file from a memory cad, 5-11  
   loading file from camera memory, 5-12  
   saving a computer file to a memory card, 5-10  
 JPEG  
   quality, 6-13  
   resolution, 6-12  
  
**K**  
 KODAK PROFESSIONAL DCS Pro Battery, 3-2  
 KODAK PROFESSIONAL DCS Pro Charger/Adapter, 3-2  
   using to charge batteries, 3-2  
   using to power camera, 3-2  
 KODAK PROFESSIONAL DCS Pro Power Module, 3-2  
  
**L**  
 language, selecting, 5-12  
 LCDs  
   digital status LCD, 2-13  
   image LCD, 2-10  
   response time in colder temperatures, 14-5  
   top status LCD, 2-10  
 lens, 2-18  
   compatibility, B-1  
   mounting, 2-18  
   removing, 2-19  
 lens optimization, 5-31  
 locking focus, 8-5  
 long exposure, 5-19  
 look

portrait, 6-15  
 product, 6-15

**M**

manual exposure mode, 7-13  
 manual focus mode, 8-5  
 memory cards, 6-1  
   formatting, 6-6  
   formatting in basic mode, 4-7  
   inserting, 6-2  
   removing, 6-2  
 menu button, 2-8  
 menus, 2-14  
   navigating, 2-15  
 MMC cards, 6-1  
 MULTIMEDIA cards, 6-1  
 multiple image mode, 11-5

**N**

naming folders and files, 5-8  
 nav+ button, 2-8  
 noise reduction, 6-15

**O**

ok button, 2-8  
 overexposure indicator, 11-8  
   turning on and off in basic mode, 4-9

**P**

panning, 11-4  
 pc sync terminal, 2-22  
 powering your camera, 3-1  
   using KODAK PROFESSIONAL DCS Pro Battery, 3-2  
   using KODAK PROFESSIONAL DCS Pro Power  
   Module, 3-2  
 programmed auto exposure mode, 7-8

**R**

recording sound files, 11-13  
 recovering files, 6-7  
 region of interest box in zoom mode  
   enabling and disabling, 11-4  
 remote release accessory port, 2-22  
 removing batteries, 3-4

# Index

---

resetting  
  defaults, 5-13

resolution  
  JPEG, 6-12  
  raw, 4-6, 6-12  
  setting in basic mode, 4-6

reviewing images, 11-1  
  browsing, 11-7  
  histogram mode, 11-3  
  multiple image mode, 11-5  
  on external video, 12-1  
  selecting an image mode, 11-1  
  zoom mode, 11-4  
    enabling and disabling the region of interest  
    box, 11-4  
    luminometer crosshairs, 11-5

**S**

safeguards and precautions, 1-3

SD cards, 6-1

SECURE DIGITAL cards, 6-1

selecting an image, 11-7

sharpening images, 6-16

shortcuts  
  digital status lcd, 2-16  
  hotkey button, 2-17

shutter-priority auto exposure mode, 7-12

software  
  KODAK PROFESSIONAL DCS Camera Manager, 9-6  
  KODAK PROFESSIONAL DCS Extended Range Imaging  
  File Format Module, 9-5  
  KODAK PROFESSIONAL DCS Photo Desk, 9-5

sound files, 11-13

specifications, A-1

status bar, 11-5

storing your camera, 14-5

system requirements, 1-1

**T**

tag/record button, 2-9

tagging images, 11-12

time/date  
  setting, 5-17  
  setting in basic mode, 4-13

top status lcd, 2-10

tracking jobs, 5-10

troubleshooting, C-1

turning the camera on and off, 2-6

## U

user mode  
  setting, 5-1

user modes  
  basic mode for digital functions, 4-1

## V

VCCI, 1-6

vertical release  
  locking and unlocking, 5-18

viewfinder, 2-6

viewfinder diopter, 2-20

## W

warnings, 1-2

warranty, D-1

white balance, 7-1  
  click balance. see click balance  
  preset, 7-2

workflow, 9-1  
  when camera is connected to a computer, 9-6  
    capturing and evaluating test images, 9-6  
    capturing images, 9-6  
    connecting to a computer and power supply, 9-6  
    editing images, 9-6  
    occasional verification, 9-6  
    preparing devices and media, 9-6  
    starting the capture software, 9-6  
    transferring images, 9-4  
  when camera is not connected to a computer, 9-1  
    capturing and evaluating test images, 9-3  
    capturing images, 9-3  
    editing images, 9-4  
    occasional verification, 9-4  
    preparing devices and media, 9-2  
    transferring images, 9-4

## Z

zoom mode, 11-4

zooming, 11-4



EASTMAN KODAK COMPANY  
Rochester, New York 14650  
[www.kodak.com/go/dcs](http://www.kodak.com/go/dcs)  
© Eastman Kodak Company, 2003.  
TM: Kodak, Kodak Professional  
P/N 6B8773

## Free Manuals Download Website

<http://myh66.com>

<http://usermanuals.us>

<http://www.somanuals.com>

<http://www.4manuals.cc>

<http://www.manual-lib.com>

<http://www.404manual.com>

<http://www.luxmanual.com>

<http://aubethermostatmanual.com>

Golf course search by state

<http://golfingnear.com>

Email search by domain

<http://emailbydomain.com>

Auto manuals search

<http://auto.somanuals.com>

TV manuals search

<http://tv.somanuals.com>