

INVACARE®

Standard Manual

Wheelchairs



Yes, you can.®

INVACARE®

Standard Manual Wheelchairs

For over 30 years, Invacare has set the standard for manual wheelchairs by empowering people with disabilities to achieve their goals. Invacare's programs and services have helped providers operate more successfully and efficiently while meeting their clients' needs. The "can-do" attitude and commitment to quality from Invacare is represented in the full product line of standard manual wheelchairs. Today Invacare continues to work on design improvements while maintaining the characteristics that have become tradition: **durability, interchangeability and value.**



Why Invacare® Standard Manual Wheelchairs?

As the premier brand in the home health care industry, Invacare continues to be committed to meeting both the needs of customers and consumers worldwide with standard wheelchair products.

- Low-maintenance designs that meet RESNA standards for manual wheelchair performance.
- Many models available as ready to ship for quick delivery.
- Consumer custom configurability available.
- Full assortment of bariatric manual wheelchair solutions.

Table of Contents

Transport Chair	4	Invacare® Insignia® Wheelchair	15
Lightweight Aluminum Transport	5	Invacare® Patriot™ Wheelchair	16
Heavy-Duty Transport	6	Invacare® Tracer® IV Wheelchair	17
Invacare® Veranda™ Wheelchair	7	Invacare® 9000 XDT Wheelchair	18
Invacare® Tracer® EX2 Wheelchair	8	Invacare® 9000 Topaz™ Wheelchair	19
Invacare® Tracer® SX5 Wheelchair	9	Invacare® 9000 Jymni™ Wheelchair	20
Invacare® Tracer® SX5 Recliner	10	Invacare® 9000 Jymni™ Recliner	21
Invacare® 9000 SL Wheelchair	11	Invacare® Backs & Cushions	22-23
Invacare® 9000 XT Wheelchair	12	Accessories	24-25
Invacare® 9000 XT Recliner	14	Ramps, CLD & Color Guide	26

Invacare Customer Service (800) 333-6900 www.invacare.com

LOGO LOOK-OUT!

Bariatric/Heavy-Duty Designation

Invacare products with the Bariatric/Heavy-Duty icon are designed for your bariatric patients whose height and weight require the use of a heavy-duty model. These products provide the same quality that all Invacare products possess. They also demonstrate Invacare's commitment to this product category.



Seating Options

Invacare general use seat cushions and backs are available **without a qualifying diagnosis**. * Invacare products with the cushion logo are available to be purchased with a seat cushion or back to provide maximum comfort.

**Providers are responsible for determining the appropriate billing codes when submitting to the Medicare Program and should consult an attorney or other advisor to discuss specific situations in further detail. This information is subject to change without notice.*



Builder Chair

Invacare products with the configurable logo are available as stock models and are also able to be custom configured. Select from many options to personalize a chair to a user's specific wants and needs.



**People with disabilities want more than wheelchair mobility.
What they really want is access, integration, and jobs - they want to do all the same things able-bodied people want to do.**



Invacare® Transport Chair

FEATURES

- Stylish, Silver Vein, powder-coated carbon steel frame
- Footrests are included with the chair and match frame finish
- Black nylon upholstery is flame retardant and bacteria resistant
- Full-length arms are padded for comfort
- Carry straps on seat allow for ease of folding and lifting
- Fold-down back makes transport and storage easy

SPECIFICATIONS

Model Numbers	TRAN17FR	TRAN19FR
HCPCS	E1038	E1038
Chair Dimensions		
Seat width	17"	19"
Seat depth	16"	16"
Back height	19" fold-down	19" fold-down
Seat-to-floor height	19"	19"
Overall Dimensions		
Overall width	19"	21"
Folded width	7.25"	7.75"
Overall depth w/o Riggings	27"	27"
Overall height	39"	39"
Weight w/o riggings	24.5 lb.	25 lb.
Weight capacity	250 lb.	250 lb.
Limited warranty (mo.)	12 months	12 months
Casters and Wheels		
Caster height	8"	8"
Wheel height	8"	8"
Shipping		
Box weight	34"	34"
Box dimensions (LxWxH)	23"x12"x31"	25"x12"x32"

Note: All specifications are approximate

Invacare® Transport chair is designed for safe and efficient patient transport. The Transport chair has the added advantage of sharing interchangeable parts with the other chairs in the transport series. The Transport chair is compact and lightweight.



Ask For It!



Invacare® Lightweight Aluminum Transport Chair

FEATURES

- Black nylon upholstery is flame retardant and bacteria resistant
- Full-length arms are padded for comfort
- Carry straps on seat allow for ease of folding and lifting
- Footrest painted to match frame finish
- Fold-down back makes transport and storage easy
- Weighs 19 lb. (w/o riggings)

SPECIFICATIONS

	ALR19HBFR ALB19HBFR	LTTR19FR LTTB19FR	LTTB17FR
Model numbers			
HCPCS	E1038	E1038	E1038
Chair Dimensions			
Seat width	17", 19"	19"	17"
Seat depth	15.5", 16"	15.5"	15.5"
Back height	17.5"	17.5"	17.5"
Seat-to-floor height	19.25"	19.25"	19.25"
Overall Dimensions			
Overall width	23.5"	21.5"	23.5"
Folded width	8.5"	8.5"	7.75"
Overall depth w/o riggings	24.25"	24.25"	24.25"
Overall height	37.5"	36.5"	36.5"
Weight w/o riggings	19 lb.	19 lb.	19 lb.
Weight capacity	250 lb.	250 lb.	250 lb.
Limited warranty (mo.)	13 months	13 months	13 months
Casters and Wheels			
Caster height	8"	8"	8"
Wheel height	12"	8"	8"
Shipping			
Box weight	30 lb.	27 lb.	27 lb.
Box dimensions (LxWxH)	27"x10"x 31"	26" x10" x 32"	26"x 10"x 31"

Note: All specifications are approximate

Invacare® Lightweight Aluminum Transport chairs are designed for safety, ease and comfortable patient transport. The lightweight frames weigh only 19 lb. and incorporate a fold-down back, making these chairs easy to transport and store.



Invacare® Heavy-Duty Transport Chair

FEATURES

- Removable padded desk arms
- Carbon steel frame with dual crossbraces
- Swingaway footrest with aluminum footplates



SPECIFICATIONS

Model Numbers	TRHD22FR
HCPCS	E1039
Chair Dimensions	
Seat width	22"
Seat depth	18"
Back height	20"
Seat-to-floor height	19.5"
Overall Dimensions	
Overall width	28"
Folded width	—
Overall depth w/o riggings	36.5"
Overall height	—
Weight w/o riggings	—
Weight capacity	400 lb.
Limited warranty (mo.)	13 months
Casters and Wheels	
Caster height	8"
Wheel height	12"
Shipping	
Box weight	51lb.
Box dimensions (LxWxH)	29" x 11" x 33"

Note: All specifications are approximate

Invacare® Heavy-Duty Transport chair

is designed for safe and efficient patient transport. The Transport chair has the added advantage of sharing interchangeable parts with the other chairs in the transport series. The Transport chair is compact and lightweight.



Ask For It!



Invacare® Veranda™ Wheelchair

FEATURES

- Stylish powder-coated frame includes front riggings
 - Footrests match chair
 - Legrests are chrome
- Carry pocket on back
- Large step-tube end cap
- Padded nylon upholstery
- Comfortable padded arms



SPECIFICATIONS

Model numbers	V16, V18, V20
HCPCS	K0001/K0002
Chair Dimensions	
Seat width	16", 18", 20"
Seat depth	16", 18"
Back height	18"
Seat-to-floor height	19.25"
Overall Dimensions	
Overall width	23", 25", 27"
Folded width	14"
Overall depth w/o riggings	30"
Overall height	36"
Weight w/o riggings	—
Weight capacity	250 lb.
Limited warranty (mo.)	12 months
Casters and Wheels	
Caster height	8"
Wheel height	24"
Shipping	
Box weight	54 lb.
Box dimensions (LxWxH)	33" x 12" x 36"

Note: All specifications are approximate

Invacare® Veranda™ wheelchair provides comfort and mobility in an economical package. Complete with front riggings packaged with the chair, the Invacare Veranda wheelchair combines style and durability at an affordable price.



Ask For It!

Invacare® Tracer® EX2 Wheelchair

FEATURES

- Durable, low-maintenance, triple chrome-plated carbon steel frame is long-lasting
- Dual axle positions allow variation of seat-to-floor heights
- Offset permanent arms available in 16", 18" and 20" widths
- 14-gauge crossbraces add strength and durability
- Urethane rear tires mounted on "no flex" wheels offer superior performance
- Low-maintenance, dual-sealed precision bearings
- Heavy-duty inner liners keep seat and back from stretching
- Upholstery is dual-embossed
- Meets RESNA standards for manual wheelchairs in product performance



SPECIFICATIONS

Model Numbers	TREX20, TREX26, TREX28
HCPCS	K0001/K0002
Chair Dimensions	
Seat width	16", 18", 20"
Seat depth	16"
Back height	16"
Seat-to-floor height	17.5", 19.5"
Overall Dimensions	
Overall width	23.25", 24.25", 25.25", 26.25", 27.25", 28.25"
Folded width	13"
Overall depth w/o riggings	31.88"
Overall height	34"
Weight w/o riggings	36 lb.
Weight capacity	250 lb.
Limited warranty (mo.)	60 months
Casters and Wheels	
Caster height	8"
Wheel height	24"
Shipping	
Box weight	43 lb.
Box dimensions (LxWxH)	32" x 13" x 38"

Note: All specifications are approximate

Invacare® Tracer® EX2 wheelchair sets the benchmark in manual wheelchairs. A true dual axle position allows for repositioning the 24" rear wheels and 8" casters for adult and hemi seat-to-floor heights. Offset permanent arms offer full seat width up to 20" with a permanent arm, hemi-spaced footrest and full range of accessories. Incorporating the design and technology of the Invacare 9000 series, the Tracer EX2 wheelchair has interchangeable components with the 9000 series chairs.



Ask For It!

Invacare® Tracer® SX5 Wheelchair

K0003/K0006

FEATURES

- Durable, low-maintenance, triple chrome-plated carbon steel frame is long-lasting
- Dual axle positions allow variation of seat-to-floor heights
- 14-gauge crossbraces add strength and durability
- Urethane rear tires mounted on "no flex" wheels offer superior performance
- Sectional back available in 16" and 18" back heights
- Low-maintenance, dual-sealed precision bearings
- Heavy-duty inner liners keep seat and back from stretching
- Meets RESNA standards for manual wheelchairs in product performance



SPECIFICATIONS

Model Numbers	TRSX50, TRSX52, TRSX56, TRSX58
HCPCS	K0003/K0006
Chair Dimensions	
Seat width	14", 16", 18", 20", 22"
Seat depth	16"
Back height	16", 18"
Seat-to-floor height	17.5", 19.5"
Overall Dimensions	
Overall width	22.5", 24.5", 26.5", 28.5", 30.5"
Folded width	
Overall depth w/o riggings	34"
Overall height	
Weight w/o riggings	36 lb.
Weight capacity	250 lb., 300 lb.
Limited warranty (mo.)	60 months
Casters and Wheels	
Caster height	6", 8"
Wheel height	20", 22", 24"
Shipping	
Box weight	43 lb.
Box dimensions (LxWxH)	32" x 13" x 37"

Note: All specifications are approximate

Invacare® Tracer® SX5 wheelchair's

lightweight frame, weighing less than 36 lb., makes this chair perfect for rental and long- or short-term use. This wheelchair offers multiple seat widths, arm styles, sectional back and seat-to-floor heights by utilizing the dual axle position frame base. The 20" and 22" widths include a semi-pneumatic caster to accommodate a weight capacity of 300 lb. Combining the design and technology of the Invacare®9000 series wheelchairs makes it possible to interchange components with the Tracer SX5 wheelchair.



Invacare® Tracer® SX5 Recliner Wheelchair

FEATURES

- Dynamic range of recline from 90° to 180°
- Durable, low-maintenance, triple chrome-plated carbon steel frame
- Urethane rear tires, mounted on "no flex" wheels, offer superior performance
- Low-maintenance, dual-sealed precision bearings
- Heavy-duty inner liners keep seat and back from stretching
- Upholstery is dual-embossed
- Meets RESNA standards for manual wheelchairs in product performance



SPECIFICATIONS

Model Numbers	TRSX5RC6, TRSX5RC8
HCPCS	K0003 & E1226/K0006 & E1226
Chair Dimensions	
Seat width	14", 16", 18", 20", 23"
Seat depth	16"
Back height	34" (24" Back, 10" Removeable Headrest)
Seat-to-floor height	17.5", 19.5"
Overall Dimensions	
Overall width	—
Folded width	—
Overall depth w/o riggings	30.25"
Overall height	—
Weight w/o riggings	—
Weight capacity	250 lb., 300 lb.
Limited warranty (mo.)	60 months
Casters and Wheels	
Caster height	8"
Wheel height	20", 22", 24"
Shipping	
Box weight	62 lb.
Box dimensions (LxWxH)	36" x 13" x 44"
Note: All specifications are approximate	

Invacare® Tracer® SX5 Recliner wheelchair

offers the durability of a lightweight manual wheelchair frame with the added versatility and comfort of a full reclining back. The Tracer SX5 Recliner wheelchair offers dynamic recline range from 90° to 180°. This chair is available with multiple seat widths, arm styles, front riggings, a full range of accessories and a 300 lb. weight capacity on 20" and 22" widths.



Ask For It!

Builder Option

Invacare® 9000 SL Wheelchair

FEATURES

- Stylish, contemporary carbon steel frame is long-lasting
- Multiple frame color variations for customizing
- Dual axle positions allow variations of seat-to-floor heights
- Urethane rear tires mounted on "no flex" wheels offer superior performance
- Urethane casters for better ride and lighter weight
- Low-maintenance, dual-sealed precision bearings
- Heavy-duty inner liners keep seat and back from stretching
- Space-saver arms reduce overall frame width without limiting seat width
- Meets RESNA standards for manual wheelchairs in product performance



K0004

SPECIFICATIONS

Model Numbers	9SL
HCPCS	K0004
Chair Dimensions	
Seat width	16", 18", 20"
Seat depth	16", 18"
Back height	15"-17", 17"-19"
Seat-to-floor height	15.5", 16.5", 17.5", 18.5", 19.5"
Overall Dimensions	
Overall width	23", 25"
Folded width	15"
Overall depth w/o riggings	30"
Overall height	36"
Weight w/o riggings	33 lb.
Weight capacity	250 lb.
Limited warranty (mo.)	60 months
Casters and Wheels	
Caster height	6", 8"
Wheel height	20", 22", 24"
Shipping	
Box weight	43 lb.
Box dimensions (LxWxH)	32" x 13" x 37"

Note: All specifications are approximate

Invacare® 9000 SL wheelchair is the perfect high-strength lightweight rental product for those who want quality and durability at a moderate price. This low-maintenance wheelchair also has a full complement of options and accessories. Its contemporary design and high-performance frame make the 9000 SL wheelchair a superior value.



Invacare® 9000 XT Wheelchair

FEATURES

- Stylish, contemporary carbon steel frame with aluminum crossbraces
- Multiple frame color variations for customizing
- Dual axle positions allow variation of seat-to-floor heights
- Offset axle position allows adjustment of center-of-gravity to increase maneuverability or stability to meet each user's skill level
- Urethane rear tires mounted on "no flex" wheels offer superior performance
- Urethane casters for better ride and lighter weight
- Adjustable caster journal can be used with or without offset axle option (Refer to service manual for a complete list of seat-to-floor heights and angles that are reconfigurable only by the provider)
- Meets RESNA standards for manual wheelchairs in product performance



SPECIFICATIONS

Model Numbers	9XT
HCPCS	K0004
Chair Dimensions	
Seat width	14", 15", 16", 17", 18", 19", 20", 22"
Seat depth	16", 17", 18"
Back height	15", 16", 17", 18", 19"
Seat-to-floor height	13.5", 14.5", 15.5", 16.5", 17.5", 18.5", 19.5"
Overall Dimensions	
Overall width	21", 22", 23", 25", 27", 29"
Folded width	12"
Overall depth w/o riggings	28"
Overall height	36"
Weight w/o riggings	31 lb.
Weight capacity	250 lb.
Limited warranty (mo.)	60 months
Casters and Wheels	
Caster height	6", 8"
Wheel height	20", 22", 24"
Shipping	
Box weight	39 lb.
Box dimensions (LxWxH)	32" x 13" x 37"

Note: All specifications are approximate

Invacare® 9000 XT wheelchair is a high performance, low maintenance and low total lifetime cost product. The 9000 XT wheelchair is simply the most versatile lightweight wheelchair available from Invacare, boasting an extensive offering of frame styles, seat-to-floor heights, back styles, widths, depths, frame colors and a wide range of options and accessories. The 9000 XT wheelchair components are interchangeable with all other 9000 series and Invacare® Tracer® series chairs.







Invacare® 9000 XT Recliner Wheelchair

FEATURES

- Stylish, contemporary carbon steel frame is long lasting
- Dynamic recline range from 95° to 175°, +/- 5°
- Rear axle base moves, providing stable center-of-gravity in recline position
- Multiple frame color variations for customizing
- Multiple wheel offerings allow variation of seat-to-floor heights
- Urethane rear tires mounted on "no flex" wheels offer superior performance
- Urethane casters for better ride and lighter weight
- Low-maintenance, dual-sealed precision bearings
- Heavy-duty inner liners keep seat and back from stretching
- Stocked with attendant (standard) or patient-operated wheel locks
- Meets RESNA standards for manual wheelchairs in product performance

SPECIFICATIONS

Model Numbers	9RC
HCPCS	K0004 & E1226
Chair Dimensions	
Seat width	14", 16", 18", 20", 22"
Seat depth	16", 17", 18"
Back deight	34" (24" Back, 10" Removeable Headrest)
Seat-to-floor Height	17.5", 18.5", 19.5"
Overall Dimensions	
Overall width	23", 25", 27", 28", 29", 31"
Folded width	17"
Overall depth w/o riggings	32"
Overall height	52"
Weight w/o riggings	50 lb.
Weight capacity	250 lb.
Limited warranty (mo.)	60 months
Casters and Wheels	
Caster height	8"
Wheel height	20", 22", 24"
Shipping	
Box weight	42 lb.
Box dimensions (LxWxH)	32" x 13" x 37"
Note: All specifications are approximate	

Invacare® 9000 XT Recliner wheelchair

is the number one choice for individuals who demand a truly versatile, yet moderately priced, lightweight wheelchair. The 9000 XT Recliner wheelchair can be configured into an endless number of seat widths, depths and heights, and has multiple frame and upholstery options. Components and accessories are interchangeable with the other 9000 series chairs.



Ask For It!

Builder Option

Invacare® Insignia™ Wheelchair

K0004

FEATURES

- Lightweight, aluminum frame
- Quick release axles
- Swingaway footrests
- Push-button, height adjustable arms that offer desk-to-full length convertibility
- Height and angle adjustable back includes spring-loaded, flip-up anti-tippers
- Adjustable angle caster journal
- Stock models for quick ship convenience



SPECIFICATIONS

Model Numbers	IN66AHAN, IN86AHAN, IN88AHAN, IN08AHAN
HCPCS	K0004
Chair Dimensions	
Seat width	16", 18", 20"
Seat depth	16", 18"
Back height	15", 16", 17", 18", 19"
Seat-to-floor height	16.5", 17.5", 18.5", 19.5"
Overall Dimensions	
Overall width	23.5", 25.5", 27.5"
Folded width	12"
Overall depth w/o riggings	31"
Overall height	—
Weight w/o riggings	33 lb.
Weight capacity	250 lb.
Limited warranty (mo.)	60 months
Casters and Wheels	
Caster height	6", 8"
Wheel height	22", 24"
Shipping	
Box weight	52 lb.
Box dimensions (LxWxH)	33" x 12.5" x 35"

Note: All specifications are approximate

Invacare® Insignia™ wheelchair is soon to become the high-strength lightweight chair of choice for providers and patients alike. The simplicity of the arm design allows them to be converted from desk to full length with ease. Providers can now stock one chair that functions as two. Other standard features include a robust wheel lock, intuitive adjustable head tube design, sleek caster fork and adjustable angle back. Patients will enjoy having a stylish, lightweight chair that is easy to use and adjusts to their specific needs. The Insignia wheelchair has it all in one package.



Invacare® Patriot™ Wheelchair

FEATURES

- Lightweight, aluminum frame
- Adjustable seat-to-floor height and rear axle positions
- Adjustable angle head tubes
- Durable center mount riggings
- Extra smooth precision head tube bearings
- Compact for transport (11.75" wide folded with wheels)
- Adjustable-height back available in 1" increments, 15"-19"
- Multiple arm, footplate and tire options
- 21 color options
- Quick-release axle option



SPECIFICATIONS

Model Numbers	PATRIOT
HCPCS	K0004
Chair Dimensions	
Seat width	14", 16", 17", 18", 20"
Seat depth	16", 18"
Back height	15" - 20"
Seat-to-floor height	15.5", 16.5", 17.5", 18.5", 19.5"
Overall Dimensions	
Overall width	—
Folded width	21.5", 23.5", 24.5", 25.5", 27.5"
Overall depth w/o riggings	11.75"
Overall height	—
Weight w/o riggings	29 lb.
Weight capacity	250 lb.
Limited warranty (mo.)	LIFETIME
Casters and Wheels	
Caster height	6", 8"
Wheel height	20", 22", 24"
Shipping	
Box weight	29 lb.
Box Dimensions (LxWxH)	40" x 13" x 26"

Note: All specifications are approximate

Need a lightweight folding chair with adjustability and reliable performance at an economical price? The **Invacare® Patriot™ wheelchair** is the model of choice. The classic manual rehab wheelchair offers valuable features including a lightweight, aluminum frame; adjustable seat-to-floor heights; durable center mount front riggings; and adjustable angle head tubes all in compact folding design.



Invacare® Tracer® IV Wheelchair

FEATURES

- Dual axle position allows variation of seat-to-floor heights
- Durable, low-maintenance, triple chrome-plated carbon steel frame is long-lasting
- Reinforced frame includes gusseted sides, caster journals and dual crossbraces
- Corded urethane rear tires (350 lb.) and pneumatic flat free tires (450 lb.) mounted on "no flex" wheels offer superior performance
- Low-maintenance, dual-sealed precision bearings
- Heavy-duty inner liners keep seat and back from stretching
- Upholstery is dual-embossed



SPECIFICATIONS

Model Numbers	T420, T422, T424, T4X22, T4X24
HCPCS	K0007
Chair Dimensions	
Seat width	18", 20", 22", 24"
Seat depth	18", 20"
Back height	16"
Seat-to-floor height	17.5", 19.5"
Overall Dimensions	
Overall width	29"
Folded width	13"
Overall depth w/o riggings	30"
Overall height	36"
Weight w/o riggings	42 lb.
Weight capacity	350 lb., 450 lb.
Limited warranty (mo.)	60 months
Casters and Wheels	
Caster height	8"
Wheel height	24"
Shipping	
Box weight	53 lb.
Box dimensions (LxWxH)	32" x 13" x 37"
Note: All specifications are approximate	

Invacare® Tracer® IV wheelchair features superior durability, rollability and streamlined looks. It is designed for the active individual who needs the strength of a reinforced heavy-duty frame. Its many options include components interchangeable within the Tracer series. The Tracer IV wheelchair is long-lasting and low-maintenance.



K0007

Invacare® 9000 XDT Wheelchair

FEATURES

- Durable, low-maintenance carbon steel frame is long-lasting
- Tall frames are designed to accommodate taller individuals and provide a more comfortable ride
- Multiple frame color variations for customizing
- Triple-axle positions allow wide variation of seat-to-floor heights
- Urethane rear tires mounted on "no flex" wheels offer superior performance
- Urethane casters for better ride and lighter weight
- Low-maintenance, dual-sealed precision bearings
- Heavy-duty inner liners keep seat and back from stretching



SPECIFICATIONS

Model Numbers	9XDT
HCPCS	K0007
Chair Dimensions	
Seat width	16", 17", 18", 19", 20", 22"
Seat depth	16", 17", 18", 19", 20"
Back height	15"-19", 14"-18"
Seat-to-floor height	17.5", 19.5", 21.5"
Overall Dimensions	
Overall width	23", 25", 27", 29"
Folded width	13"
Overall depth w/o riggings	29"
Overall height	36"
Weight w/o riggings	37 lb.
Weight capacity	350 lb.
Limited warranty	60 months
Casters and Wheels	
Caster height	8"
Wheel height	24"
Shipping	
Box weight	55 lb.
Box dimensions (LxWxH)	34" x 13" x 39"

Note: All specifications are approximate

Invacare® 9000 XDT wheelchair is designed for individuals who demand an extra wide, heavy-duty or tall chair with seat-to-floor heights ranging from hemi through tall. The high-performance 9000 XDT wheelchair provides a 350 lb. weight capacity and the components are interchangeable with the other 9000 series wheelchairs.



Ask For It!



Builder Option



Invacare® 9000 Topaz™ Wheelchair

FEATURES

- Available in vinyl or nylon upholstery
- Durable low-maintenance, carbon steel frame is long-lasting
- Reinforced frame includes gusseted sides, caster journals and dual heavy-duty crossbraces
- Multiple frame color variations available for customizing
- Heavy-duty front riggings provide proper positioning for feet with footrest and elevating legrest
- Heavy-duty arms designed to accommodate weight capacity and provide proper positioning
- Dual axle positions allow for quick and simple seat-to-floor height variations, 17.5" and 19.5"
- HDPG option for 1,000 lb. weight capacity
- Heavy-duty triple inner liners keep seat and back from stretching



K0007

SPECIFICATIONS

Model Numbers	9TPZ
HCPCS	K0007
Chair Dimensions	
Seat width	20", 22", 24", 26", 28", 30"
Seat depth	18", 20"
Back height	16"-18"
Seat-to-floor height	15.5", 17.5", 19.5"
Overall Dimensions	
Overall width	39"
Folded width	16"
Overall depth w/o riggings	30"
Overall height	32"
Weight w/o riggings	85 lb.
Weight capacity	700 lb., 1000 lb.
Limited warranty	36 months
Casters and Wheels	
Caster height	6", 8"
Wheel height	20", 24"
Shipping	
Box weight	97 lb.
Box dimensions (LxWxH)	35" x 15" x 46.5"

Note: All specifications are approximate

Invacare® 9000 Topaz™ wheelchair is designed specifically to suit the unique needs of bariatric patients. The Topaz wheelchair combines the strength and durability of a carbon steel frame with the comfort of heavy-duty front riggings and arms for proper positioning. With a variety of seat widths and depths, frame reinforcements that include gusseted sides, caster journals and dual heavy-duty crossbraces, this chair provides not only ease in maneuverability but proven stability.



Ask For It!



Builder Option





Invacare® 9000 Jymni™ Wheelchair

FEATURES

- Durable, carbon steel frame is long-lasting
- Stroller handles provide ergonomic positioning for caregiver and remove for ease in transporting
- Adjustable front riggings provide ideal positioning for pediatric clients
- Urethane rear tires mounted on "no flex" wheels offer superior performance
- Virtually no-maintenance, dual-sealed precision bearings
- Dual-axle positions allow for quick and simple seat-to-floor height adjustments of 15" and 16"
- Seat width and depth options provide proper positioning
- Adjustable angle back easily changes from -5° to 20° in 5° increments
- Meets RESNA standards for manual wheelchairs in product performance

SPECIFICATIONS

Model Numbers	9JYLT
HCPCS	E1236
Chair Dimensions	
Seat width	10", 12", 14", 16"
Seat depth	10", 12", 14"
Back height	14"-15"
Seat-to-floor height	15", 16", 17"
Overall Dimensions	
Overall width	21"
Folded width	14"
Overall depth w/o riggings	30"
Overall height	32"
Weight w/o riggings	31 lb.
Weight capacity	125 lb.
Limited warranty	60 months
Casters and Wheels	
Caster height	6"
Wheel height	20", 22"
Shipping	
Box weight	54 lb.
Box dimensions (LxWxH)	32" x 14" x 38"

Note: All specifications are approximate

Invacare® 9000 Jymni™ wheelchair offers your growing list of pediatric clients versatility, functionality and maneuverability. This chair is specifically designed to suit the needs of your smaller clients and offers features like a durable carbon-steel frame and easy adjustability.



Ask For It!



Builder Option



Invacare® 9000 Jymni™ Recliner

FEATURES

- Durable, carbon steel frame is long-lasting
- Dynamic recline from 95° to 160°
- Stroller handles provide ergonomic positioning for caregiver and remove for ease in transporting
- Adjustable front riggings provide ideal positioning for pediatric clients
- Seat width and depth options provide proper positioning
- Meets RESNA standards for manual wheelchairs in product performance

SPECIFICATIONS

Model Numbers	9JYLTR
HCPCS	E1236/E1226
Chair Dimensions	
Seat width	10", 12", 14", 16"
Seat depth	10", 12", 14"
Back height	27" (16" Back, 11" Removeable Headrest)
Seat-to-floor height	15", 16", 17"
Overall Dimensions	
Overall width	—
Folded width	—
Overall depth w/o riggings	—
Overall height	—
Weight w/o riggings	40 lb.
Weight capacity	125 lb.
Limited warranty	60 months
Casters and Wheels	
Caster height	8"
Wheel height	24"
Shipping	
Box weight	54 lb.
Box dimensions (LxWxH)	32" x 14" x 38"

Note: All specifications are approximate

Invacare® 9000 Jymni™ Recliner

wheelchair offers your growing list of pediatric clients versatility, functionality and maneuverability, with the added comfort of a reclining back. This chair is specifically designed to suit the needs of your smaller clients and provides features like a variety of width and depth options, a recline range of 95° to 160° and multiple frame color options.



Ask For It!

Builder Option

E1236/E1226



INVACARE®

Backs & Cushion Options

The new adjustable tension **Invacare® Versair™ Back** is designed for positioning and comfort, offering versatile and clinically beneficial solutions when standard sling upholstery does not meet an individual's need. Wide tension straps are easily adjustable to accommodate positioning requirements with maximum support. They can be adjusted taut in the lower back for optimal sacral support or relaxed in the upper back to accommodate a thoracic kyphosis. The padded back upholstery uses mesh fabric for added comfort and improved airflow between the user and the back.

Why Invacare® General Use Backs and Cushions?

As the premier brand in the home health care industry, Invacare continues to be committed to meeting both the needs of customers and consumers worldwide with Invacare's standard wheelchair products. Invacare general use seat cushions and backs are available without a qualifying diagnosis.

The **Invacare® Versair™ Back** is designed for positioning and comfort, offering versatile and clinically beneficial solutions when standard sling upholstery does not meet an individual's need.

HCPCS Code
E2611/E2612



Mesh fabric effectively dissipates heat and moisture.

Specifications

Width	16" - 26"
Height	
Regular	15" - 17"
Tall	17" - 19"
Weight limit	
16"-21"	300 lb.
21"-26"	500 lb.
Limited warranty	2 years

For individuals with mild to moderate seating needs, the **Invacare® Absolute™ Cushion** offers simple, but highly functional solutions. This cushion is designed to provide basic comfort using highly resilient foam and is intended for individuals who are able to do their own weight shift for pressure relief.

HCPCS Code
E2601



Specifications

Width:	16"-20"
Depth:	16"-18"
A. Height at adductor	3.25"
B. Height at abductor	2.25"
C. Height at rear	2"
Cushion weight approximately	2 lb.
Limited warranty	1 year

The **Invacare® Matrix® Genera™ Back** provides support and comfort at a price so affordable that no wheelchair user needs to make do with sling upholstery.

HCPCS Code
E2611



Specifications

Width	16" 18" 20"
Height	
16"	16" - 20"
20"	16" - 20"
Weight capacity	300 lb.
Limited warranty	1 year

For individuals with mild to moderate seating needs, the **Invacare® Single Density Cushion** offers simple, but highly functional solutions. This cushion is designed to provide basic comfort using highly resilient foam for pediatrics to geriatrics who are able to do their own weight shift for pressure relief.

HCPCS Code
E2601/E2602



Specifications

Width	10"-24"
Depth	7"-20"
A. Height at rear	2"
B. Height at rear (center)	1.5"
C. Height at front	2.5"
Cushion weight approximately	2 lb.
Limited warranty	1 year

The **Invacare® Propel™ Back** is so lightweight and comfortable consumers will forget it's there. Hardware installation is no longer a hassle: just grab it, set it and go. The Invacare Propel Back provides a stable surface for propulsion and completion of daily living activities.

HCPCS Code
E2611



Specifications

Width	16" - 21"
(in 1" increments)	
Height	16.5"
Depth adjustment	1.75"
Angle adjustment	up to 27°
Weight limit	300 lb.
Limited warranty	2 years

For individuals with mild to moderate seating needs, the **Invacare® Comfort-Mate Extra Cushion** goes one step further with a comfortable, molded design and a durable moisture-resistant coating. Ideal for individuals who are able to do their own weight shifts for pressure relief, who need comfort, stability, gentle positioning and some protection.

HCPCS Code
E2603/E2604



Specifications

Width	14" - 22"
Depth	14" - 20"
A. Height at adductor	2.625"
B. Height at abductor	3.0"
C. Height at leg trough	2.25"
Cushion weight approximately	2.3 lb.
Limited warranty	1 year

INVACARE® Standard Manual Wheelchair Accessories



Front Riggings
1820: Front Rigging Non-removable Device



Non-folding Device
 • **1335:** (14"-22" w)
 • **1335XL:** (24"-30" w)



Axles
1. 1577QR: Quick Release
2. 9357SH: Super Low Amputee Attachment
3. 9357L: Amputee Attachment
4. OFFAXL: Off Axle



Overhead Anti-Theft Device
1514



Accessories
1. 1300: Utility Tray
2. 1209: Tire Pump
3. 1305L: Crutch & Cane Carrier
4. 1100: Tool Kit
5. 1571: Fabric Clothing Protectors



Seat/Chest Positioning Straps
1. 1321BK/7321BK: Hook and Loop
2. 1515: Auto Style Buckle
3. 1311BK/7311BK: Airline Buckle



Anti-Tippers
1. 9758: Rear Anti-Tippers
2. 1360SH: Super Low Adjustable
3. 1360A: Adjustable Rear Anti-Tippers
4. 1360: Adjustable Rear Anti-Tippers
5. 2226: Front Anti-Tippers



IV/O2 Holders
1. 1497: O2 Holder Package Assembly
2. 1496: IV/O2 Holder Package Assembly
3. 2218: IV Rod, Telescopic
4. 2219: IV Rod, Telescopic
1322SXR: IV Rod and Bracket



Upholstery
1. ImpactG: Impact Guards
2. STC: Stencil Back Upholstery
3. 1160: Seat Pouch
4. BP-02: Backpack
(shown in Large 16" and Small 14"-16")

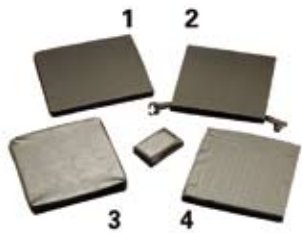

Upholstery
1. 9130: Solid Back Insert
2. 9662L: Solid Seat Insert
3. 9120: Solid Seat Insert
4.1608: Solid Back Insert



Tires

- 1. Urethane
 - 2. Urethane - High Profile
 - 3. Pneumatic - Flat-Free
- All tires available in 20", 22" and 24" sizes.
Available on all chairs.

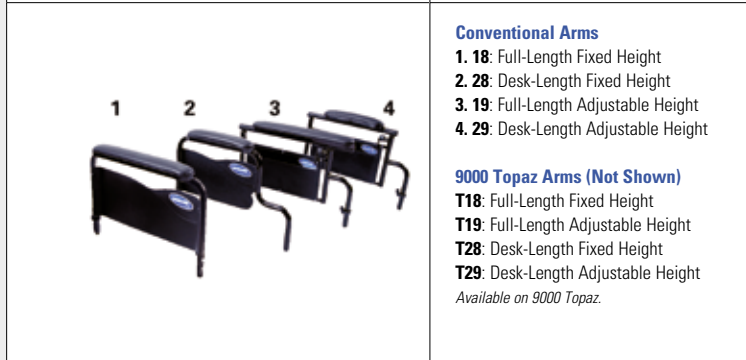

Conventional Arms

- 1. 18: Full-Length Fixed Height
- 2. 28: Desk-Length Fixed Height
- 3. 19: Full-Length Adjustable Height
- 4. 29: Desk-Length Adjustable Height

9000 Topaz Arms (Not Shown)

- T18: Full-Length Fixed Height
 - T19: Full-Length Adjustable Height
 - T28: Desk-Length Fixed Height
 - T29: Desk-Length Adjustable Height
- Available on 9000 Topaz.



Footrests

- 1. T963A/C: 60° Elevating Footrest Aluminum/Composite
- 2. T93HA/C/S: Aluminum/Composite

9000 Topaz Front Riggings (Not Shown)

- TZ33A: Swingaway Footrest
- TZ34A: Swingaway Elevating Legrest



Footrests

- 1. SH93F: Superlow Extension Swingaway, Aluminum
- 2. H93M: Hemi Minimum Swingaway, Aluminum
- 3. H93E: Hemi Extension Swingaway, Aluminum
- 4. SH93ES: Super Low Extension Swingaway, Aluminum



Footplates

- 1. 1350: Extra Large Aluminum
- 2. AT5543: Adjustable Angle
- 3. C: Composite
- 4. A: Aluminum

Straps (Not Shown)

- 1346: Heel Loops
- 1345: Toe Loops
- 1600 BK: Heel Loops with

Ankle Straps (Not Shown)

- 9342: H Strap
- 1337: Calf Strap
- 1348: Legrest Panel



Handrims

- 1. CHDRM: Chrome-Plated
- 2. COM: Composite
- 3. AHDRM: Aluminum
- 4. 1512: Plastic Coated
- 5. 1225-8: 8 Aluminum Vertical Projection Handrim Plastic Coated
- 6. 1225-12: 12 Aluminum Vertical Projection Handrim Plastic Coated
- 7. 1224-8: 8 Aluminum Oblique Projection Handrim Plastic Coated

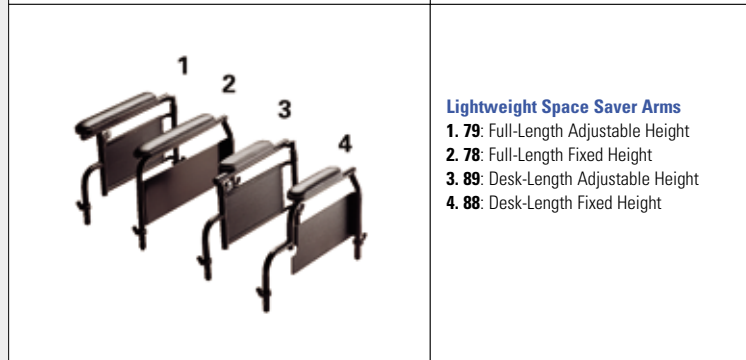

Lightweight Space Saver Arms

- 1. 79: Full-Length Adjustable Height
- 2. 78: Full-Length Fixed Height
- 3. 89: Desk-Length Adjustable Height
- 4. 88: Desk-Length Fixed Height

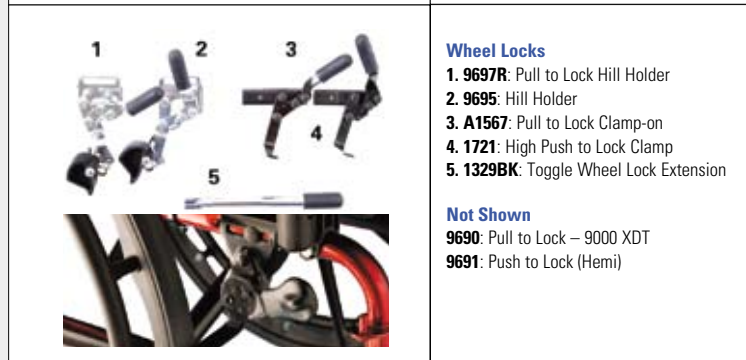

Wheel Locks

- 1. 9697R: Pull to Lock Hill Holder
- 2. 9695: Hill Holder
- 3. A1567: Pull to Lock Clamp-on
- 4. 1721: High Push to Lock Clamp
- 5. 1329BK: Toggle Wheel Lock Extension

Not Shown

- 9690: Pull to Lock – 9000 XDT
- 9691: Push to Lock (Hemi)



Legrests

- 1. AHS4A: Hemi Smartleg® Articulating Legrest, Aluminum
- 2. T94HA/C: Hemi Elevating Legrest Aluminum/Composite
- 3. SH904MS: Superlow Elevating Legrest, Aluminum
- 4. AHL4A/C: Hemi Articulating Legrest, Aluminum/Composite

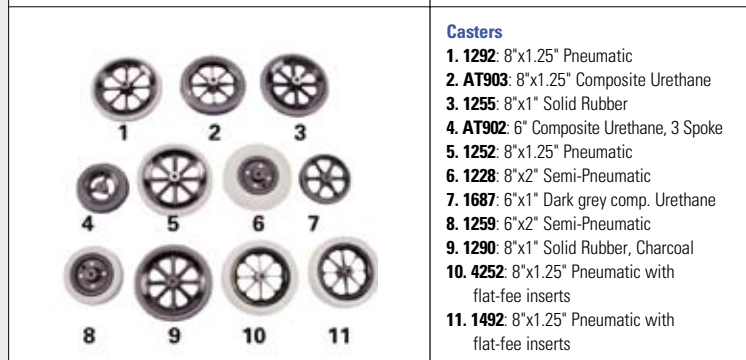

Casters

- 1. 1292: 8"x1.25" Pneumatic
- 2. AT903: 8"x1.25" Composite Urethane
- 3. 1255: 8"x1" Solid Rubber
- 4. AT902: 6" Composite Urethane, 3 Spoke
- 5. 1252: 8"x1.25" Pneumatic
- 6. 1228: 8"x2" Semi-Pneumatic
- 7. 1687: 6"x1" Dark grey comp. Urethane
- 8. 1259: 6"x2" Semi-Pneumatic
- 9. 1290: 8"x1" Solid Rubber, Charcoal
- 10. 4252: 8"x1.25" Pneumatic with flat-free inserts
- 11. 1492: 8"x1.25" Pneumatic with flat-free inserts

INVACARE® Folding Ramps

Folding ramps offer an ideal solution for manual and power wheelchairs as well as scooters.

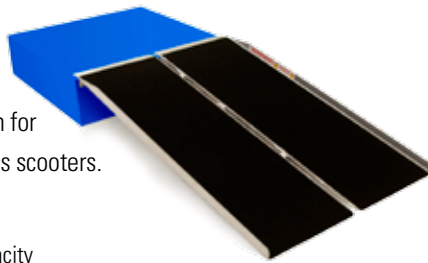

Features

- Sturdy and dependable 600 lb. weight capacity
- Ideal for manual or power wheelchairs and 3- or 4-wheel scooters
- Convenient carrying handle is standard on all ramps
- Stocked in Invacare's warehouse
- Heavy-duty industrial Velcro® strap ensures ramp security during transportation
- Transports and stores like a suitcase
- High-traction tape on the surface is long-lasting and maintenance-free

Specifications

Model Numbers	ICR630	ICR330
Size	6' L x 30" W	3' L x 30" W
Style	Multifold	Single fold
Folded size	40.625" L x 16" W x 8.5" D	36" L x 16" W x 4" D
Product weight	28 lb.	14 lb.
Weight capacity	600 lb.	600 lb.
Limited warranty	1 year	1 year

Ramps are manufactured by Prairie View Industries and distributed by Invacare Corporation.

INVACARE® Cyclical Lever Drive

Invacare® CLD (Cyclical Lever Drive) provides users with the ability to self-propel themselves with one arm, enabling an active, mobile and independent lifestyle.



With its front caster steering mechanism, simple rowing motion design and adjustability in height and stroke length, the Invacare CLD is an easy to use one-arm drive.

There are no service requirements for the CLD mechanism, although service requirements for the wheelchair apply. Kits available for provider installation. Right- or left-handed configuration. Provider installed kits for Invacare 9000 XT, 9000 SL and Patriot wheelchairs. See 9000 XT price list (95-66) for availability. These are not compatible with U2222 rear wheel and the 9000 SL wheelchair also requires space saver arms.

Specifications

Mechanism weight	9.1 lb.
Added width to chair	1.5"
Stroke length	15"-16"
Grip height adjustment	15"-18"
Mechanism color	Black/Chrome
Installation	Right- or Left-hand
Weight capacity	250 lb.
Limited warranty	2 years



**Add personality
to your Standard Wheelchair.**
Available Color Swatches

For upholstery and frame color availability, please refer to the corresponding wheelchair price list.

Frame

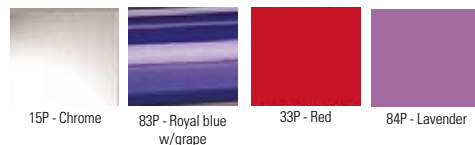
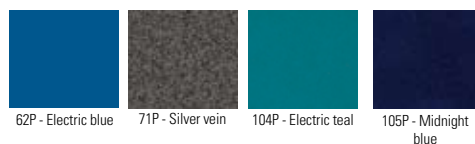
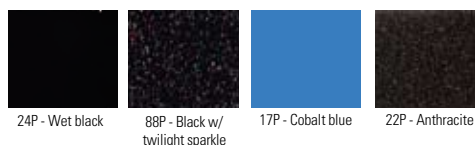

Upholstery











INVACARE®
Standard Manual
Wheelchairs



INVACARE® Standard Manual Wheelchair Chart

	TRANSPORT			STANDARD		
						
	Invacare® Transport Wheelchair	Invacare® Aluminum Transport Wheelchair	Invacare® Heavy-Duty Transport Wheelchair	Invacare® Veranda™ Wheelchair	Invacare® Tracer® EX2 Wheelchair	Invacare® Tracer® SX5 Wheelchair
HCPCS Codes	E1038	E0138	E1039	K0001/K0002	K0001/K0002	K0003/K0006
SPECIFICATIONS						
SEAT WIDTH	17", 19"	17", 19"	22"	16", 18", 20"	16", 18", 20"	14", 16", 18", 20", 22"
SEAT DEPTH	16"	15.5", 16"	18"	16"	16"	16"
BACK HEIGHT	19"	17.5"	20"	18"	16"	16", 18"
SEAT-TO-FLOOR HEIGHT	19"	19.25"	19.5"	19.5"	17.5", 19.5"	17.5", 19.5"
OVERALL WIDTH	19", 21"	23.5"	28"	23", 25", 27"	23.5-28.5	22.5-30.5
FOLDED WIDTH	7.25", 7.75"	8.5"	—	14"	13"	11.5
OVERALL DEPTH W/O RIGGINGS	27"	24.25"	36.5"	30"	32"	34
OVERALL HEIGHT	39"	37.5"	—	36"	34"	35
WEIGHT W/O RIGGINGS	24.5 lb., 25 lb.	19 lb.	—	—	36 lb.	—
WEIGHT CAPACITY	250 lb.	250 lb.	400 lb.	250 lb.	250 lb.	250 lb., 300 lb. available
LIMITED WARRANTY	12 months	13 months	13 months	12 months	60 months	60 months
CASTER HEIGHT	8"	8"	8"	8"	8"	6, 8
WHEEL HEIGHT	8"	12"	12"	24"	24"	20, 22, 24
BOX WEIGHT	34 lb.	30 lb.	51 lb.	54 lb.	43 lb.	43 lb.
BOX DIMENSIONS (LxWxH)	23" x 12" x 31"	27" x 10" x 21"	29" x 11" x 33"	33" x 12" x 36"	32" x 13" x 38"	32x13x37
RECLINER AVAILABLE						x

INVACARE® General Use Cushions and Backs

For individuals with mild to moderate seating needs, the **Invacare® Absolute™ Cushion** offers simple, but highly functional solutions. This cushion is designed to provide basic comfort using highly resilient foam and is intended for individuals who are able to do their own weight shift for pressure relief.

HCPCS Code
E2601



Specifications

Width:	16"-20"
Depth:	16"-18"
A. Height at adductor	3.25"
B. Height at abductor	2.25"
C. Height at rear	2"
Cushion weight approximately	2 lb.
Limited warranty	1 year

For individuals with mild to moderate seating needs, the **Invacare® Single Density Cushion** offers simple, but highly functional solutions. This cushion is designed to provide basic comfort using highly resilient foam for pediatrics to geriatrics who are able to do their own weight shift for pressure relief.

HCPCS Code
E2601/E2602

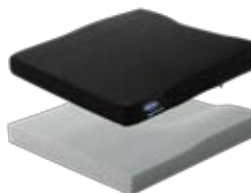

Specifications

Width	10"-24"
Depth	7"-20"
A. Height at rear	2"
B. Height at rear (center)	1.5"
C. Height at front	2.5"
Cushion weight approximately	2 lb.
Limited warranty	1 year

For individuals with mild to moderate seating needs, the **Invacare® Comfort-Mate Extra Cushion** goes one step further with a comfortable, molded design and a durable moisture-resistant coating. Ideal for individuals who are able to do their own weight shifts for pressure relief, who need comfort, stability, gentle positioning and some protection.

HCPCS Code
E2603/E2604



Specifications

Width	14"-22"
Depth	14"-20"
A. Height at adductor	2.625"
B. Height at abductor	3.0"
C. Height at leg trough	2.25"
Cushion weight approximately	2.3 lb.
Limited warranty	1 year



LIGHTWEIGHT

HEAVY-DUTY

PEDIATRIC



Invacare® 9000 SL Wheelchair

Invacare® Patriot™ Wheelchair

Invacare® 9000 XT Wheelchair

Invacare® Insignia™ Wheelchair

Invacare® Tracer® IV Wheelchair

Invacare® 9000 XDT Wheelchair

Invacare® 9000 Topaz™ Wheelchair

Invacare® Jymni™ Wheelchair

	K0004	K0004	K0004	K0004	K0007	K0007	K0007	E1236
16", 18", 20"	14", 16", 17", 18", 20"	14"-20", 22"	16", 18", 20"	18", 20", 22", 24"	16"-20", 22"	20"-30" (2" increments)	10", 12", 14", 16"	
16", 18"	16", 18"	16", 17", 18"	16", 18"	18", 20"	16"-20"	18", 20"	10", 12", 14"	
15"-19"	15"-20"	15"-18"	15"-19"	16"	14"-19"	16"-18"	14"-15"	
17.5", 19.5", 15.5", 16.5", 18.5"	15.5", 16.5", 17.5", 18.5", 19.5"	17.5", 18.5", 19.5", 15.5", 16.5"	17.5", 18.5", 19.5", 16.5"	17.5", 19.5"	17.5", 19.5", 21.5"	17.5", 19.5", 15.5"	15", 16", 17"	
23", 25"	21.5"-27.5" (2)	21"-29" (2)	23.5"-27.5"	—	23-29	34"	21"	
15"	11.75"	12"	12"	—	13	16"	14"	
30"	43", 45"	28"	31"	—	29	30"	30"	
36"	—	36"	33"	—	36	32"	32"	
33 lb.	29 lb.	31 lb.	33 lb.	42 lb.	37 lb.	85 lb.	31 lb.	
250 lb.	250 lb.	250 lb.	250 lb.	350lb., 450lb. available	350 lb.	700 lb., 1000 lb.	125 lb.	
60 months	LIFETIME	60 months	60 months	60 months	60 months	36 months	60 months	
6", 8"	6", 8"	—	6", 8"	8"	8	6", 8"	6"	
20", 22", 24"	20", 22", 24"	6", 8"	22", 24"	24"	24	20", 24"	20", 22"	
43 lb.	29 lb.	42 lb.	52 lb.	53 lb.	55 lb.	97 lb.	54 lb.	
32" x 13" x 37"	40" x 13" x 26"	32" x 13" x 27"	33" x 12.5" x 35"	32" x 13" x 27"	34x13x39	35" x 15" x 46.5"	32" x 14" x 38"	
		x					x	



The **Invacare® Versair™ Back** is designed for positioning and comfort, offering versatile and clinically beneficial solutions when standard sling upholstery does not meet an individual's need.

HCPCS Code E2611/E2612



Mesh fabric effectively dissipates heat and moisture.

Specifications

Width	16"-26"
Height	
Regular	15"-17"
Tall	17"-19"
Weight capacity	
16"—21"	300 lb.
21"—26"	500 lb.
Limited warranty	2 years

The **Invacare® Genera™ Back** provides support and comfort at a price so affordable that no wheelchair user needs to make do with sling upholstery.

HCPCS Code E2611



Specifications

Width	16" 18" 20"
Height	
16"	16"-20"
20"	16"-20"
Weight capacity	300 lb.
Limited warranty	1 year

The **Invacare® Propel™ Back** is so lightweight and comfortable consumers will forget it's there. Hardware installation is no longer a hassle: just grab it, set it and go. The Invacare Propel Back provides a stable surface for propulsion and completion of daily living activities.

HCPCS Code E2611



Specifications

Width	16"-21"
(in 1" increments)	
Height	16.5"
Depth adjustment	1.75"
Angle adjustment	up to 27°
Weight capacity	300 lb.
Limited warranty	2 years

Invacare Corporation
www.invacare.com

USA

One Invacare Way
Elyria, Ohio
44035-4190
(800) 333-6900

Canada

570 Matheson Blvd. E.
Unit 8
Mississauga, Ontario
L4Z 4G4 Canada
(800) 668-5324

© 2011

Invacare Corporation
All rights reserved.
Trademarks are
identified by the symbols
™ and ®. All trademarks
are owned by or licensed
to Invacare Corporation
unless otherwise noted.
Velcro is a registered
trademark of Velcro
Industries B.V.

All references to HCPCS
codes: Providers are
responsible for determining
the appropriate billing
codes when submitting
claims to the Medicare
program, and should
consult an attorney or other
advisor to discuss specific
situations in further details.

Form No. 00-261
Rev. 04-11
101123



Yes, you can.®

Free Manuals Download Website

<http://myh66.com>

<http://usermanuals.us>

<http://www.somanuals.com>

<http://www.4manuals.cc>

<http://www.manual-lib.com>

<http://www.404manual.com>

<http://www.luxmanual.com>

<http://aubethermostatmanual.com>

Golf course search by state

<http://golfingnear.com>

Email search by domain

<http://emailbydomain.com>

Auto manuals search

<http://auto.somanuals.com>

TV manuals search

<http://tv.somanuals.com>