

**Jabra**<sup>®</sup>

# Jabra GO<sup>™</sup> 6470

**User Manual**

# WELCOME

Congratulations on purchasing your new Jabra GO 6470. We are sure you will enjoy its wide range of features, and find the headset comfortable to wear and easy to use.

Jabra GO 6470 includes a touchscreen base, enabling connectivity with desk phones and softphones (PC), and the Jabra GO headset is compatible with nearly all types of *Bluetooth*® mobile phones.

The Jabra GO 6470 package also includes the Jabra LINK™ 350 USB *Bluetooth*® Adapter and Jabra GO Travel Charger. The Jabra LINK 350 USB *Bluetooth*® Adapter plugs into to your computer and connects to your headset via *Bluetooth*®, enabling you to use your headset together with softphones on your PC. The Travel Charger includes compartments for both the headset and Jabra LINK 350 USB *Bluetooth*® Adapter for easy transportation.

## **Jabra GO 6470 Headset features**

- Dual Noise Blackout microphone.
- Direct *Bluetooth*® mobile phone connectivity.
- Lightweight (under 18g).
- Fast recharge.
- Touch panel volume and mute control.
- Intuitive headset multi-function button for easy call handling.
- Earhook and headband wearing style (neckband accessory available).
- Up to 100 meters range.

## **Jabra GO 6470 base features**

- 2.4" color touchscreen.
- Desk phone, softphone (PC) and *Bluetooth*® mobile phone connectivity.
- Touchscreen-guided setup for desk phone, softphone (PC) and mobile phone connections.
- Touchscreen call control for all connected phones.
- On-screen caller ID (mobile phones and softphones (PC) only).
- Headset recharge docking cradle.

## **Jabra LINK 350 USB *Bluetooth*® Adapter features**

- Enables headset connection to any PC using *Bluetooth*® wireless technology.
- Connects to PC via USB.
- Softphone (PC) support and control.
- Wideband audio.
- LED indicators.
- Up to 100 meters range.

## **Jabra GO Travel Charger features**

- Recharges headset from mains power socket, or car cigarette-lighter socket (when used with car charger).
- Holds the Jabra GO 6470 and the Jabra LINK 350 USB *Bluetooth*® adapter for easy transportation.

# CONTENTS

|  |           |
|--|-----------|
| <b>1. PRODUCT OVERVIEW .....</b>                                     | <b>6</b>  |
| 1.1 Package Contents .....   | 6         |
| 1.2 JABRA GO 6470 Headset.....                                       | 7         |
| 1.3 Headset Attachments.....   | 8         |
| 1.4 Jabra GO 6470 Base.....  | 10        |
| 1.5 Jabra LINK 350 USB <i>Bluetooth</i> <sup>®</sup> Adapter .....   | 11        |
| 1.6 Jabra GO Travel Charger.....                                     | 11        |
| 1.7 Optional Accessories.....  | 12        |
| <b>2. CONNECTING TO A PHONE USING THE SETUP WIZARD ....</b>          | <b>13</b> |
| 2.1 Connect to Power .....   | 13        |
| 2.2 Start the Setup Wizard.....                                      | 13        |
| <b>3. CONNECTING TO A PHONE MANUALLY .....</b>                       | <b>14</b> |
| 3.1 Connect to Power .....   | 14        |
| 3.2 Dock Headset.....  | 14        |
| 3.3 Connect to Softphone (PC).....                                   | 14        |
| 3.4 Connect to Mobile phone with <i>Bluetooth</i> <sup>®</sup> ..... | 16        |
| 3.5 Select and Connect to a Desk Phone .....                         | 17        |
| <b>4. JABRA PC SUITE .....</b>                                       | <b>19</b> |
| 4.1 Install Jabra PC Suite.....                                      | 19        |
| 4.2 PC Call Manager .....  | 19        |
| <b>5. JABRA GO 6470 HEADSET FEATURES .....</b>                       | <b>20</b> |
| 5.1 Headset Multi-function Button.....                               | 20        |
| 5.2 Headset Touch Panel .....  | 20        |
| 5.3 Headset LED Indicator.....                                       | 21        |
| 5.4 Headset Audio Indicators.....                                    | 22        |

|            |   |           |
|------------|---|-----------|
| <b>6.</b>  | <b>JABRA LINK 350 USB <i>BLUETOOTH</i>® ADAPTER FEATURES...</b>       | <b>23</b> |
| 6.1        | Jabra LINK 350 USB <i>Bluetooth</i> ® Adapter Button .....            | 23        |
| 6.2        | Jabra LINK 350 USB <i>Bluetooth</i> ® Adapter Visual Indicators ..... | 23        |
| <b>7.</b>  | <b>TOUCHSCREEN INTRODUCTION.....</b>                                  | <b>24</b> |
| 7.1        | Touchscreen Overview .....  | 24        |
| 7.2        | Change Settings using the Touchscreen.....                            | 25        |
| <b>8.</b>  | <b>CALL MANAGEMENT .....</b>  | <b>29</b> |
| 8.1        | Making a Call or ending a call.....                                   | 29        |
| 8.2        | Accepting or Rejecting an Incoming Call .....                         | 29        |
| 8.3        | Adjust Headset Speaker Volume.....                                    | 30        |
| 8.4        | Adjust Headset Microphone Level .....                                 | 30        |
| 8.5        | Putting a Call on Hold/Audio Hold.....                                | 31        |
| <b>9.</b>  | <b>ADVANCED CALL MANAGEMENT .....</b>                                 | <b>32</b> |
| 9.1        | Switching call(s) between Headset and Handset .....                   | 32        |
| 9.2        | Last Number Redial .....  | 32        |
| 9.3        | Automatic Disconnect Prevention (Unsupported Softphones) .....        | 32        |
| <b>10.</b> | <b>ADVANCED JABRA GO 6470 FEATURES .....</b>                          | <b>33</b> |
| 10.1       | Safetone™ Hearing Protection.....                                     | 33        |
| 10.2       | Wideband Audio.....   | 33        |
| 10.3       | Voice Announcements .....   | 33        |
| 10.4       | Tone Settings .....   | 34        |
| 10.5       | Listening to Music or Audio on PC.....                                | 34        |
| 10.6       | Firmware Updates.....   | 34        |
| 10.7       | Theft Protection.....   | 34        |
| <b>11.</b> | <b>FAQS AND TROUBLESHOOTING.....</b>                                  | <b>35</b> |

|  |           |
|--|-----------|
| <b>12. TECHNICAL SPECIFICATIONS .....</b>                | <b>36</b> |
| 12.1 Jabra GO Headset.....                               | 36        |
| 12.2 Jabra GO Headset Battery .....                      | 37        |
| 12.3 Jabra GO Touchscreen Base.....                      | 37        |
| 12.4 Jabra LINK 350 USB <i>Bluetooth</i> ® Adapter ..... | 38        |
| 12.5 Travel Charger.....                                 | 38        |
| 12.6 Materials and Allergies .....                       | 39        |
| 12.7 Product Disposal.....                               | 39        |
| 12.8 Certifications and Safety Approvals.....            | 39        |

# 1. PRODUCT OVERVIEW

## 1.1 PACKAGE CONTENTS



Headset

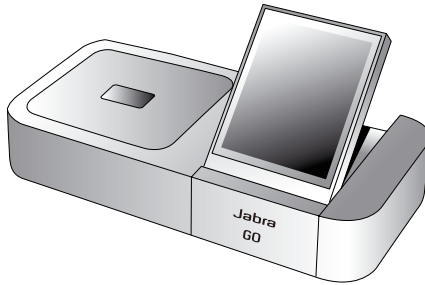

Base and Headset Cradle



Jabra LINK 350 USB Bluetooth® Adapter



Headband Attachment



Base Power Adapter (for Base)



Earhook Attachment (small, medium and large earbuds)

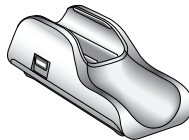

Travel Charger



Telephone Cable



Ear-buds



Warning & Declaration Booklet



USB Cable



Quick Start Guide



Travel Charger Power Adapter

## 1.2 JABRA GO 6470 HEADSET

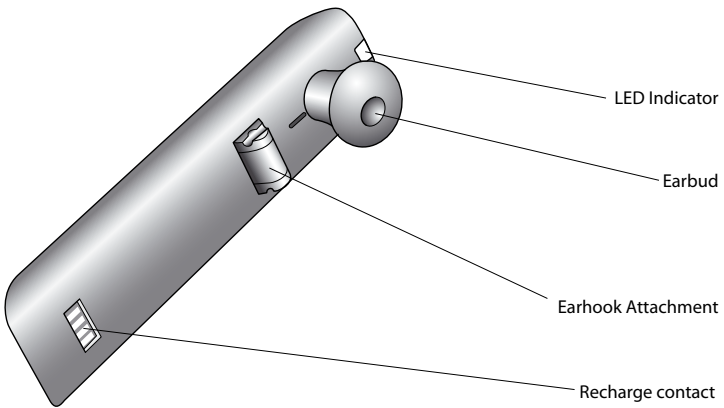
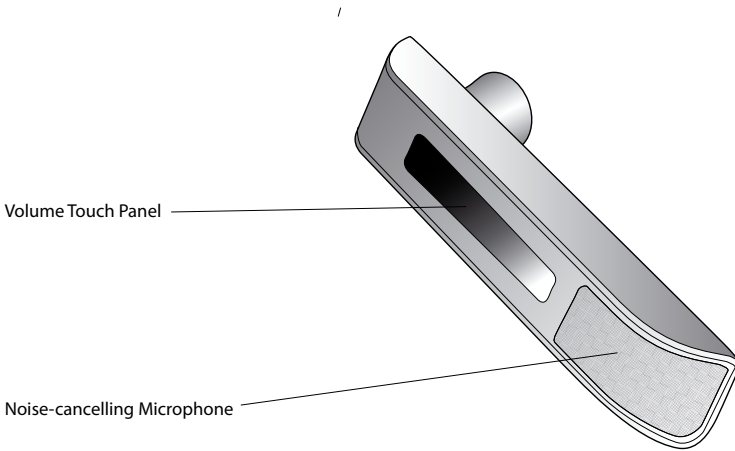
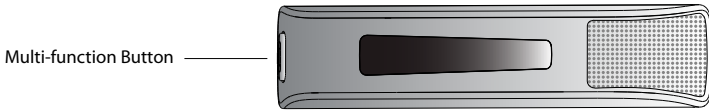

### 1.3 HEADSET ATTACHMENTS

The Jabra GO 6470 headset can be worn in the headband, earhook or neckband wearing-styles. The headband and earhook attachments are included with the Jabra GO 6470. The neckband attachment can be purchased separately.

Wearing-styles can be worn on the left or right ear. Regardless of wearing style, ensure the microphone is positioned close to the mouth to maximise noise-cancelling and speech quality.



#### Attaching the earhook

1. Remove the current wearing style attachment, if any.
2. Assemble the earhook wearing-style attachment for left or right ear use. If necessary, remove the eartube and replace with another size for best fit.
3. Slide the attachment up or down in its fitting until the headset fits comfortably to the ear.

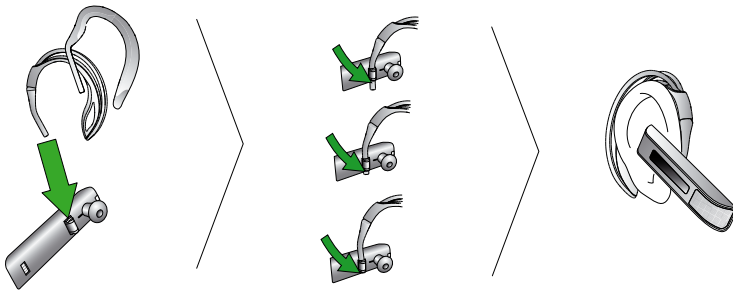



### Attaching the headband

1. Remove the current wearing style attachment, if any.
2. Align the headset earbud with the matching holes of the headband wearing style, as illustrated, and press firmly until they click into place (snap-to-click).
3. Adjust the length of the headband to fit against the head.
4. Position the microphone as close to the mouth as possible.

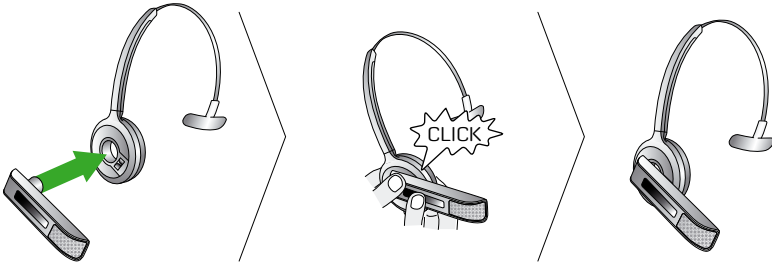

### Attaching the neckband (optional accessory)

1. Remove the current wearing style attachment, if any.
2. Align the headset earbud with the matching holes of the neckband wearing style, as illustrated, and press firmly until they click into place (snap-to-click).
3. Position the microphone as close to the mouth as possible.



# 1.4 JABRA GO 6470 BASE

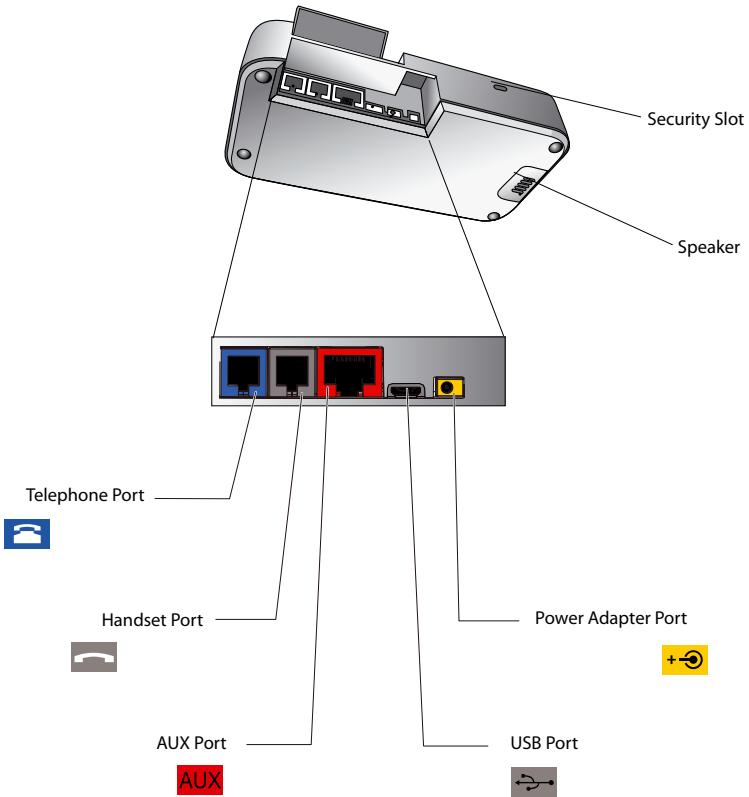
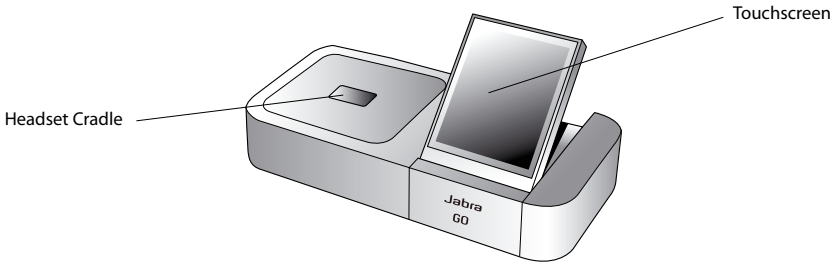

## 1.5 JABRA LINK 350 USB *BLUETOOTH*® ADAPTER

The Jabra LINK 350 USB *Bluetooth*® Adapter connects to a PC and enables the Jabra GO 6470 headset to function with a softphone on the PC.

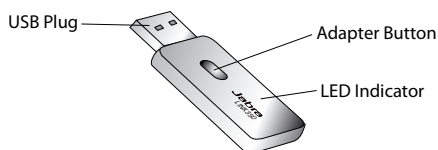

## 1.6 JABRA GO TRAVEL CHARGER

The Jabra GO Travel Charger charges the Jabra GO 6470, and has compartments for storing the Jabra GO 6470 and the Jabra LINK 930 USB *Bluetooth*® Adapter.

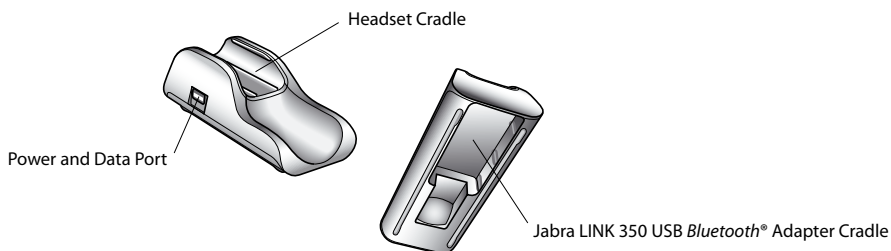

### Storing the Jabra GO 6470 headset and the Jabra LINK 350 USB *Bluetooth*® Adapter

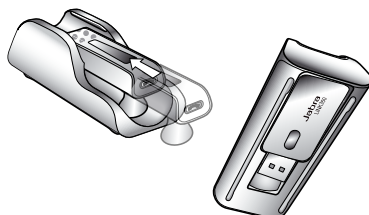

## 1.7 OPTIONAL ACCESSORIES

The following Jabra GO 6470 accessories are available separately.

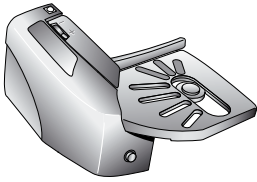

GN1000

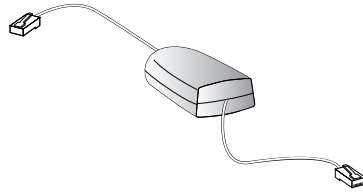

Electronic Hookswitch Adapter  
(adapter may vary from illustration)



Neckband Attachment



Replacement Headband Attachment



Car Charger

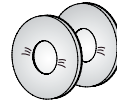

Replacement Ear Cushions

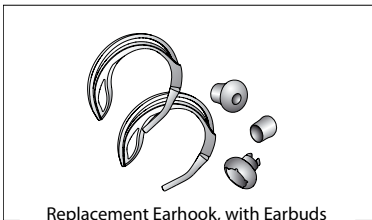

Replacement Earhook, with Earbuds

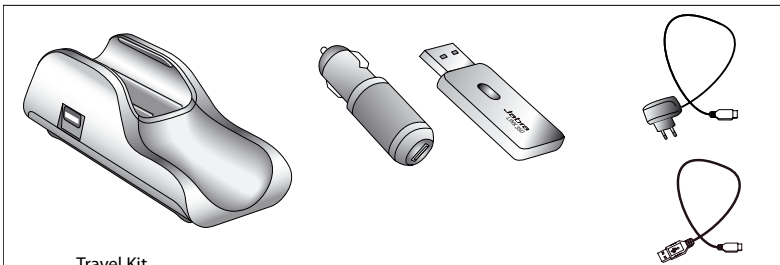

Travel Kit

## 2. CONNECTING TO A PHONE USING THE SETUP WIZARD

The easiest way to connect and configure your Jabra GO product is to use the setup wizard on the touchscreen. The setup wizard will guide you through connecting and configuring the desk phone, softphone and/or mobile phone.

### 2.1 CONNECT TO POWER

#### Connect the power adapter to the base

1. Plug the supplied power adapter into the port marked  on the base.
2. Connect the power adapter to the mains power socket.

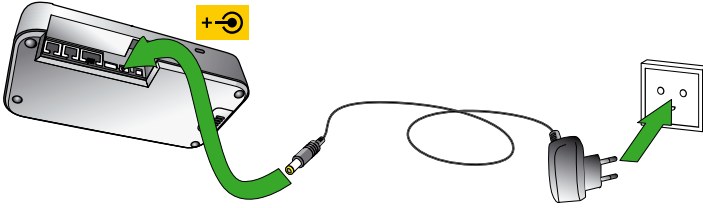

### 2.2 START THE SETUP WIZARD

The setup wizard automatically starts the first time the base is turned on, however the setup wizard can also be accessed at any time via the touchscreen menu.

1. Tap the tool icon  on the touchscreen to open the settings menu.
2. Tap Phone settings > Setup wizard.
3. Tap Confirm to start the Setup wizard, and then follow the instructions.



## 3. CONNECTING TO A PHONE MANUALLY

### 3.1 CONNECT TO POWER

#### Connect the power adapter to the base

1. Plug the supplied power adapter into the port marked  on the base.
2. Connect the power adapter to the mains power socket.

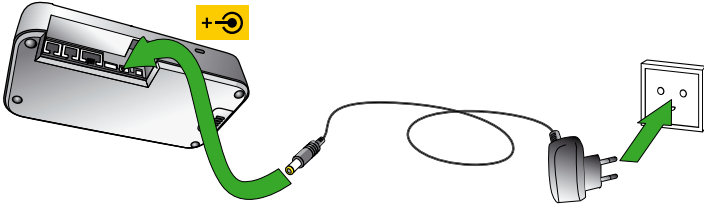

### 3.2 DOCK HEADSET

Dock the headset, as illustrated. When the headset is docked correctly the docking icon will light up, and the headset battery will begin charging, if needed. Keep the headset docked while connecting the Jabra GO, or when not in use.

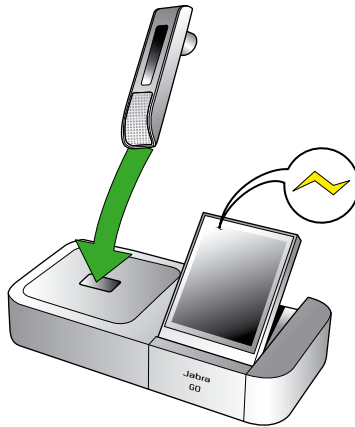



### 3.3 CONNECT TO SOFTPHONE (PC)

Connecting to a PC will allow connectivity with a PC softphone (such as Skype). Supported softphones have full functionality with the Jabra GO headset, such as answering and ending calls with the headset multi-function button. Unsupported softphones have only audio functionality with the Jabra GO headset, and have no interactivity with the Jabra GO headset call functions. For the latest list of supported softphones, please visit the Jabra website at [www.jabra.com/pcsuite](http://www.jabra.com/pcsuite).

There are two ways to connect to a softphone (PC):

- Connect using the Jabra GO base.
- Connect using the Jabra LINK 350 USB *Bluetooth*® Adapter.

### Connect the Jabra GO base to a PC

1. Plug the supplied USB cable into the port marked  on the base.
2. Connect the USB cable to any free USB port on the PC.
3. Download and install Jabra PC Suite from [www.jabra.com/pcsuite](http://www.jabra.com/pcsuite).
4. Tap the tool icon  on the touchscreen to open the settings menu, and tap Phone Settings > Enable Softphone. If your softphone is not supported, select None (audio only) during the setup wizard.
5. Launch softphone software on the PC, and set the Jabra GO as speaker and microphone in the audio configuration. Refer to specific softphone documentation for assistance in setting audio configurations.

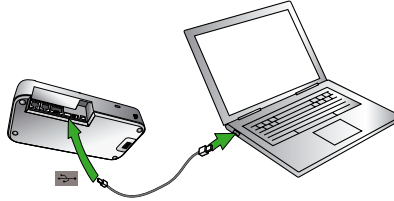

### Connect the Jabra LINK 350 USB Bluetooth® Adapter to a PC

1. Download and install Jabra PC Suite from [www.jabra.com/pcsuite](http://www.jabra.com/pcsuite). Refer to the Jabra PC Suite section of this manual for further information.
2. Plug the Jabra LINK USB 350 Bluetooth® Adapter into any available USB port on the PC. The adapter will install automatically when plugged in.
3. During the first three seconds the adapter LED will flash to indicate the current softphone mode (Microsoft Lync is default-selected). To toggle between Microsoft Lync and standard softphones tap the adapter button during the first three seconds.
4. After three seconds the adapter LED will indicate the current status of the Jabra GO 6470.

| Adapter LED    | Description  |
|----------------|--|
| Solid green    | The headset and adapter are paired and connected and the PC softphone is the current target. Go to step 4.   |
| Solid yellow   | The headset and adapter are paired and connected and the mobile phone is the current target. Go to step 4.   |
| Flashing green | The headset and adapter are paired but not connected. Connection will occur automatically if the headset is powered on and within range. The headset indefinitely attempts connection when powered on, and the adapter LED will change to green or yellow when connected. When connected go to step 4. |
| Solid blue     | The headset and adapter are not paired. The adapter is in pairing mode. To pair the headset and the adapter see the Pairing the Jabra GO 6470 and the Jabra LINK 350 USB Bluetooth® Adapter below. Go to step 4 when successfully paired and connected (solid green or yellow LED).                    |

5. The Jabra GO 6470 is now ready to use with your softphone (PC).

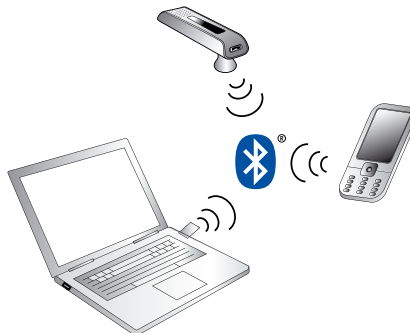

JABRA GO 6470

### Pairing the Jabra GO 6470 and the Jabra LINK 350 USB Bluetooth® Adapter

The Jabra GO 6470 headset and Jabra LINK 350 USB Bluetooth® Adapter are already paired from the factory. The pairing procedure below is only necessary when the pairing is lost.

1. Attach the Jabra LINK 350 USB Bluetooth® adapter to the PC, and turn the PC on.
2. Put the Jabra LINK 350 USB Bluetooth® adapter in pairing mode by pressing holding the adapter button until the adapter LED turns blue.
3. If the Jabra GO 6470 headset is on, turn it off by pressing and holding the headset multi-function button until the headset LED flashes red three times and turns off.
4. Put the Jabra GO 6470 headset into pairing mode by pressing and holding the headset multi-function button until the headset LED turns blue.
5. Place the Jabra GO 6470 close to the Jabra LINK 350 USB Bluetooth® adapter and wait until pairing is successful. When pairing is successful the adapter and headset LEDs will flash blue 5 times.
6. The Jabra GO 6470 and Jabra LINK 350 USB Bluetooth® adapter are now paired and connected.

## 3.4 CONNECT TO MOBILE PHONE WITH BLUETOOTH®

### Connect to a mobile phone using Bluetooth®

1. Tap the tool icon  on the touchscreen to open the settings menu.
2. Tap Phone settings > Mobile phone > Setup mobile phone.
3. Tap Confirm to start the Mobile phone connection wizard, and follow the instructions.

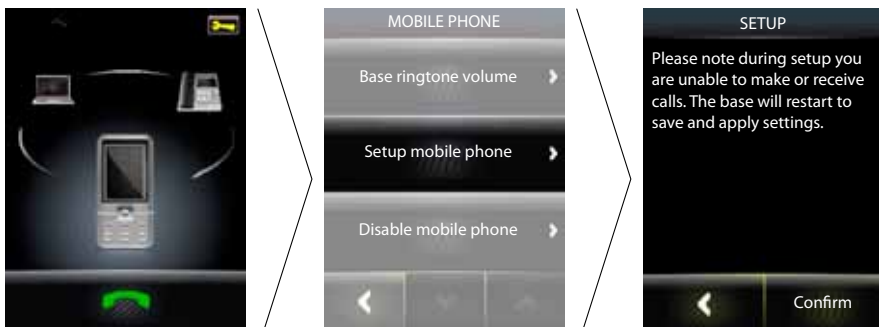

### How to reconnect to mobile phone with Bluetooth®

If the base loses the Bluetooth® connection with the mobile phone it will attempt to reconnect. To force reconnection:

1. Ensure the mobile phone is in range of the base, and that Bluetooth® is activated on the mobile phone.
2. If there is no connection a Bluetooth® logo will be displayed on the mobile phone icon on the touchscreen. Tap the greyed out mobile phone icon to begin re-connecting the mobile phone with the base.
3. When successfully reconnected, the mobile phone icon will appear connected.





### 3.5 SELECT AND CONNECT TO A DESK PHONE

Select which desk phone you are connecting to from the following four options:

#### OPTION 1

##### Desk Phone with Headset Port

This type of desk phone has a dedicated headset port (usually at the back of the phone). These phones typically have a button on the front panel for switching between handset and headset.

1. Plug the supplied telephone cable into the port marked  on the base.
2. Connect the telephone cable to the headset port  on the desk phone.

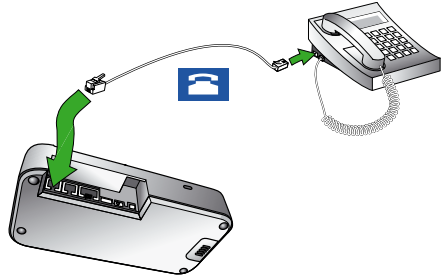

or

#### OPTION 2

##### Desk Phone with Jabra Link adapter

A Jabra Link adapter enables an incoming call to be answered or ended by the headset multi-function button.

Contact your local Jabra dealer to purchase a Jabra Link adapter for your specific desk phone.

1. Connect the Jabra Link adapter as shown in adapter documentation supplied with the Jabra Link. On some phones the telephone cable will also need to be connected.
2. Call your connected desk phone using another phone to enable the Jabra Link adapter. Wait 10 seconds before answering the phone.

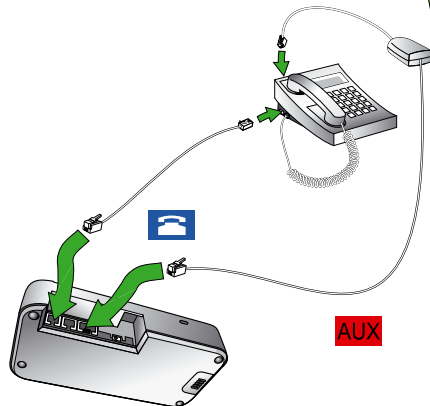

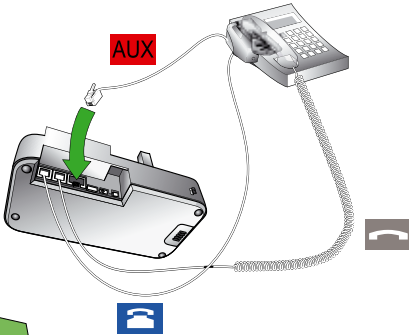

or

## OPTION 3



### Desk Phone with GN1000 Remote Handset Lifter

The GN1000 remote handset lifter manually lifts the desk phone handset to make or answer a call. For mounting instructions refer to documentation supplied with the GN1000.

1. On the desk phone, unplug the handset cable from the phone body.
2. Connect the handset cable to the port marked  on the base.
3. Plug the supplied telephone cable into the port marked  on the base.
4. Connect the telephone cable into the handset port on the desk phone.
5. Connect the GN1000 cable into the port marked  on the base.

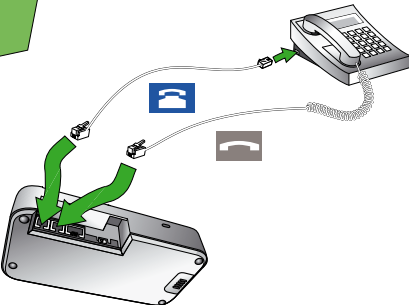

or

## OPTION 4



### Desk Phone without Headset Port

This desk phone does not have a dedicated headset port.

1. On the desk phone, unplug the handset cable from the phone body.
2. Connect the handset cable to the port marked  on the base.
3. Plug the supplied telephone cable into the port marked  on the base.
4. Connect the telephone cable into the handset port on the desk phone.

## 4. JABRA PC SUITE

Jabra PC Suite is a collection of software designed to support the Jabra GO 6470. For optimal functionality and management of the Jabra GO, it is highly recommended to install Jabra PC Suite.

Jabra PC Suite consists of:

### **PC Call Manager**

Manages call handling on your PC monitor, and enables call and settings management via PC.

### **Jabra Control Center**

Settings management and monitoring of the Jabra GO 6470.

### **Jabra Device Service**

Manages the interaction between the Jabra GO 6470 and Jabra Control Center, PC Call Manager, and softphone drivers.

### **Jabra Firmware Updater**

Updates Jabra GO firmware.

### **Online Help**

Jabra PC Suite help section.

Jabra PC Suite additionally includes drivers for various softphones. For a list of supported softphones, visit [www.jabra.com/pcsuite](http://www.jabra.com/pcsuite).

### 4.1 INSTALL JABRA PC SUITE

Download and install Jabra PC Suite from [www.jabra.com/pcsuite](http://www.jabra.com/pcsuite).

### 4.2 PC CALL MANAGER

PC Call Manager is PC software that replicates some of the touchscreen call handling functionality on the PC, allowing the user to make calls, answer calls, merge calls etc using their PC. PC Call Manager is installed as part of Jabra PC Suite.

## 5. JABRA GO 6470 HEADSET FEATURES

### 5.1 HEADSET MULTI-FUNCTION BUTTON

The headset multi-function button can answer calls, end calls, switch between held calls, and more, using a combination of taps, double-taps or presses.

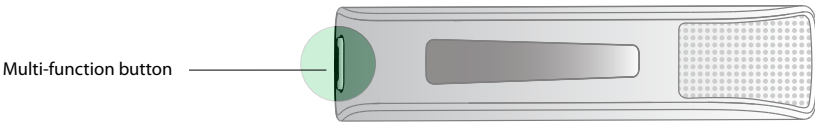

| Function  | Tap | Double-tap | Press<br>(hold 1-2 seconds) |
|---|-----|------------|-----------------------------|
| Answer incoming call  | ✓   |            |                             |
| End current call  | ✓   |            |                             |
| Enable voice-activated dialing<br>(mobile phones only)          | ✓   |            |                             |
| Open phone line on target phone                                 | ✓   |            |                             |
| Call last number dialed   |     | ✓          |                             |
| Reject incoming call (when on a call)                           |     | ✓          |                             |
| Reject incoming call (when not on a call)                       |     |            | ✓                           |
| Put current call on hold, and accept incoming call              |     |            | ✓                           |
| Switch between target phones                                    |     |            | ✓                           |
| Power headset on  |     |            | ✓                           |
| Power headset off   |     |            | ✓ (5 secs)                  |
| Activate <i>Bluetooth</i> ® pairing mode<br>(when power is off) |     |            | ✓ (5 secs)                  |

### 5.2 HEADSET TOUCH PANEL

The touch panel is a touch-sensitive panel that controls the headset speaker volume and microphone mute. Changes made to the speaker volume apply independently to softphone (PC) or mobile phone.

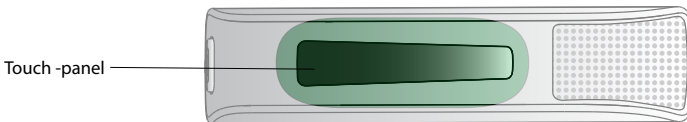

| Increase Speaker Volume                              | Decrease Speaker Volume                                 | Mute Microphone |
|--|---|-----------------|
| Slide finger up the touch panel<br>(away from mouth) | Slide finger down the touch panel<br>(toward the mouth) | Double-tap      |

### 5.3 HEADSET LED INDICATOR

The LED indicator indicates the headset status.

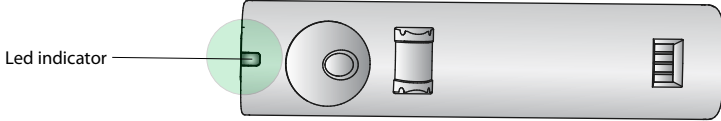

| Headset state     | LED when battery is full<br>(click to view) | LED when battery is low<br>(click to view) |
|-------------------|---|--|
| Idle              | ▶ ○   | ▶ ○  |
| Not connected     | ▶ ○   | ▶ ○  |
| Call active       | ▶ ○   | ▶ ○  |
| Ringing           | ▶ ○   | ▶ ○  |
| Power on          | ▶ ○   | ▶ ○  |
| Power off         | ▶ ○   | ▶ ○  |
| Pairing           | ▶ ○   | ▶ ○  |
| Pairing succeeded | ▶ ○   | ▶ ○  |
| Charging          | ▶ ○   | ▶ ○  |
| Fully charged     | ▶ ○   |  |

## 5.4 HEADSET AUDIO INDICATORS

The headset plays a variety of audio tones to indicate headset status and actions.

| Action                 | Audio Sample<br>(click to listen) | Action  | Audio sample<br>(click to listen) |
|------------------------|-----------------------------------|---|-----------------------------------|
| Power on               |                                   | Incoming softphone call                                       |                                   |
| Power off              |                                   | Incoming mobile phone call                                    |                                   |
| Button tap             |                                   | Incoming call on another phone while on call (call collision) |                                   |
| Button double-tap      |                                   | Target phone changed to mobile phone                          |                                   |
| Button press           |                                   | Target phone changed to softphone                             |                                   |
| Maximum volume reached |                                   | Call ended  |                                   |
| Minimum volume reached |                                   | Battery low   |                                   |
| Microphone muted       |                                   | Call placed on hold (call waiting)                            |                                   |
|                        |                                   | Pairing succeeded   |                                   |

## 6. JABRA LINK 350 USB *BLUETOOTH*<sup>®</sup> ADAPTER FEATURES

The Jabra LINK 350 USB *Bluetooth*<sup>®</sup> Adapter connects to a PC and enables the headset to function with a softphone on the PC.

### 6.1 JABRA LINK 350 USB *BLUETOOTH*<sup>®</sup> ADAPTER BUTTON

The Jabra LINK 350 USB *Bluetooth*<sup>®</sup> Adapter has a single button that has three functions depending on what mode the adapter is in.

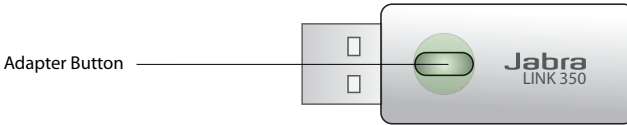

| Function   | Tap | Press (hold 1-3 sec) |
|--|-----|----------------------|
| Switch between Microsoft Lync softphone (default) and the standard softphone mode (first three seconds after adapter is plugged in). | ✓   |                      |
| Enter pairing mode (when not in pairing mode).   |     | ✓                    |
| Cancel pairing (when already in pairing mode).   |     | ✓                    |

### 6.2 JABRA LINK 350 USB *BLUETOOTH*<sup>®</sup> ADAPTER VISUAL INDICATORS

The Jabra LINK 350 USB *Bluetooth*<sup>®</sup> Adapter has an LED to indicate the status of the adapter and its connections.

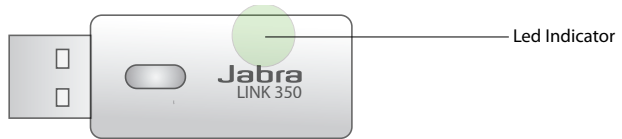

| LED Indicator             | USB Adapter Status  |
|---------------------------|---|
| Flashing red              | Microsoft Lync softphone mode is selected in the adapter    |
| Double-flashing red       | Standard softphone mode is selected in the adapter          |
| Constant green            | Connected and ready for use, softphone is current target    |
| Constant yellow           | Connected and ready for use, mobile phone is current target |
| Slow-flashing green       | Paired but not connected                                    |
| Constant blue             | Pairing mode  |
| Quintuple (5x) blue flash | Pairing succeeded   |
| Moderate blue flash       | On a call or audio streaming                                |
| Triple blue flash         | Ringing   |
| Constant red              | Muted   |

# 7. TOUCHSCREEN INTRODUCTION

The Jabra GO 6470 touchscreen is a color touchscreen that enables you to connect and configure the Jabra GO 6470, manage calls, and manage base, headset and phone settings. Tap the screen with a finger to activate icons, scroll up/down a menu, select a target phone and make, answer or end calls.

**NOTE:** Touchscreen settings may be locked by an IT administrator. Locked settings will not be available on the touchscreen.

## 7.1 TOUCHSCREEN OVERVIEW

The touchscreen is divided into three areas: status bar (top), activity window (middle) and call control bar (bottom).



### 1 Status bar

The status bar is the row of icons at the top of the touchscreen.

| Icon | Description  |
|------|--|
|      | Indicates the current battery level.   |
|      | Indicates the headset is docked.   |
|      | Indicates an open audio connection between the base and the headset. If the headset icon has an WB on it, it indicates wideband audio is active. |
|      | Tap  to open the settings menu. The tool icon is only visible when not on a call.  |
|      | Tap  to open the call options menu. The call options icon is only visible when on a call.  |



## 2 Activity window

The activity window is main area of the touchscreen, and displays the currently connected phones, allows phone selection, and also the merging of multiple calls.



Target phone (foreground icon)

The large foreground phone icon indicates the current target phone. To switch target phone tap on the relevant small background phone icon, or press the headset multi-function button when not on a call to cycle through the available phones. The phone icons will change depending on status (e.g. incoming call, outgoing call).

## 3 Call control bar

The call control bar indicates the options available for the target phone, such as make call, end call, and mute headset.



MSH desk phones have a unique call control bar (see below).



## 7.2 CHANGE SETTINGS USING THE TOUCHSCREEN

There are a number of settings that can be changed using the settings menu on the touchscreen. The setting menu is accessed by tapping the tool icon  on the touchscreen:

- Disconnect headset
- Base settings
- Headset settings
- Phone settings
- About

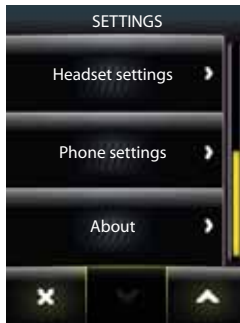
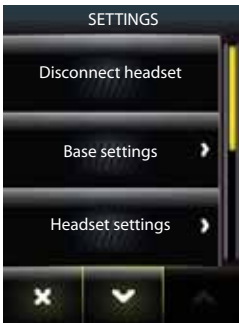

## 1 DISCONNECT HEADSET

Disconnects the primary headset from the base.

## 2 BASE SETTINGS

The base settings allow changes to be made to the touchscreen and base sounds. There are six base settings that can be changed:

| Setting                  | Description  |
|--------------------------|--|
| Screen brightness        | Adjust the screen brightness                               |
| Screen dimmer timeout    | Adjust the base idle time before the touchscreen is dimmed |
| Touchscreen click sounds | Adjust the touchscreen click sounds volume                 |
| Language                 | Set the language for all text on the touchscreen           |
| Enable power save mode   | Enable/disable power save mode                             |

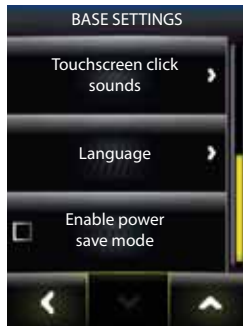
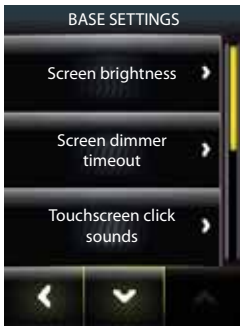

## 3 HEADSET SETTINGS

The headset settings allow changes to be made to the headset. There are six headset settings that can be changed.

| Setting                     | Description  |
|-----------------------------|--|
| Headset intro               | A guided tour of how to use the headset functions, such as answer/end calls and volume control |
| Intellitone                 | Adjust the intellitone noise protection level  |
| Voice announcements         | Select the target phone announcement type  |
| Enable mute reminder tone   | Enable/disable the mute reminder tone  |
| Enable touch volume control | Enable/disable the touch volume control on the Jabra GO headset                                |
| Enable touch mute control   | Enable/disable touch mute control on the Jabra GO headset                                      |

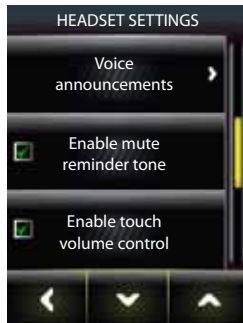

#### 4 PHONE SETTINGS

The headset settings allow changes to be made individually to desk phones, softphones or mobile phone settings, as well as access to the setup wizard and the factory default reset configurations setting.

There are three sub-categories with individual settings specific to the phone type: Desk phone, Softphone (PC) and Mobile phone.



##### Desk phone settings

| Setting                   | Description   |
|---------------------------|---|
| Base ringtone volume      | Adjust the desk phone ringtone on the base.   |
| Open phone line on undock | Automatically open the phone line when the headset is undocked.   |
| Setup desk phone          | Start the setup wizard to connect and configure the desk phone.   |
| Disable desk phone        | Disable the desk phone connection. The desk phone can be connected again by opening the settings menu, and tapping Phone settings > Desk phone > Enable Desk phone. |

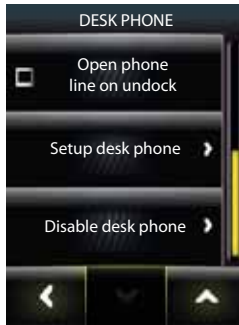

## Softphone (PC) settings

| Setting                   | Description   |
|---------------------------|---|
| Base ringtone volume      | Adjust the softphone (PC) ringtone on the base.   |
| Open phone line on undock | Automatically open the phone line when the headset is undocked.   |
| Enable wideband audio     | Enable/disable wideband audio.  |
| Automatic Audio detection | Enable/disable Automatic audio detection.   |
| Setup softphone (PC)      | Start the setup wizard to connect and configure the desk phone.   |
| Disable softphone (PC)    | Disable the softphone connection. The softphone can be connected again by opening the settings menu, and tapping Phone settings > Softphone (PC) > Enable softphone (PC). |

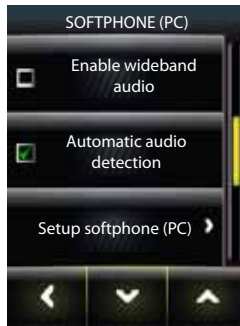

## Mobile phone settings

| Setting              | Description   |
|----------------------|---|
| Base ringtone volume | Adjust the mobile phone ringtone on the base.                     |
| Setup mobile phone   | Start the setup wizard to connect and configure the mobile phone. |



## 5 ABOUT

Firmware version and copyright information.

## 8. CALL MANAGEMENT

### 8.1 MAKING A CALL OR ENDING A CALL

1. Ensure the relevant phone type is selected as the target phone (large foreground icon on touchscreen).  
If necessary lift the desk phone handset and set aside (desk phone without electronic hookswitch or GN1000 only).
2. Put on the headset, and dial the phone number using the desk phone, softphone or mobile phone. Alternatively tap the softphone or mobile phone icon on the touchscreen, and select dial pad in the menu to use the touchscreen dial pad.
3. Tap the green handset icon, or tap the headset multi-function button to make the call.
4. To end a call, tap the red handset icon, or tap the headset multi-function button, or dock the headset.

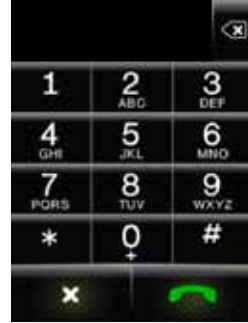

### 8.2 ACCEPTING OR REJECTING AN INCOMING CALL

Tap the ringing phone icon to answer an incoming call, or tap the headset multi-function button. To reject the call tap the red handset icon.



### 8.3 ADJUST HEADSET SPEAKER VOLUME

Adjusting the headset speaker volume when on a call can be done using the headset volume touch panel, or by using the touchscreen.

1. When on a call, tap the call options icon  on the touchscreen to open the call options menu.
2. Tap Speaker Volume, and adjust the volume as needed by tapping the + or - icons.
3. When finished, press the back arrow to exit the menu.



### 8.4 ADJUST HEADSET MICROPHONE LEVEL

Adjusting the headset microphone level when on a call can be done by using the touchscreen.

#### **Adjusting the headset microphone level using the touchscreen**

1. When on a call, tap the call options icon  on the touchscreen to open the call options menu.
2. Tap Microphone level, and adjust the level as needed by tapping the + or - icons.
3. When finished, press the back arrow to exit the menu.



## 8.5 PUTTING A CALL ON HOLD/AUDIO HOLD

To put a current call on hold or audio hold, tap the current call phone icon and tap the pause icon (hold) or the audio hold icon in the touchscreen menu. The phone icon will display the relevant hold symbol to indicate the call is on hold or on audio hold. To resume the call, tap the phone icon again.

| Setting    | Description   |
|------------|---|
| Hold       | When hold is enabled the telephone company will stop all audio between the softphone or mobile phone. The listener on the other end of the call can see they have been put on hold.   |
| Audio hold | When audio hold is enabled the Jabra PRO mutes the headset microphone and the headset speaker. The listener on the other end of the call cannot see they have been put on audio hold. |



## 9. ADVANCED CALL MANAGEMENT

### 9.1 SWITCHING CALL(S) BETWEEN HEADSET AND HANDSET

When on a phone call, it is possible to switch audio between the Jabra GO headset and a desk phone handset or mobile phone without interrupting the call.

#### **Desk phone**

*Switch call from desk phone to the headset*

1. Lift headset from docking cradle. If necessary, press the headset button on your desk phone. The audio will be transferred from the desk phone to the headset.
2. Do not return desk phone handset to receiver as this will hang up the call.

*Switch call from the headset to a desk phone handset (without remote call control)*

1. Lift desk phone handset.
2. Dock headset, or tap the headset multi-function button, or tap the desk phone icon on the touchscreen. The audio will be transferred from the headset to the desk phone.

*Switch call from the headset to a desk phone handset (with remote call control)*

1. Lift desk phone handset.
2. Refer to specific desk phone documentation on how to activate remote call control. In some cases a button must be pressed on the desk phone, while in others it will be automatic.

#### **Mobile phone**

*Switch call from mobile phone to the headset*

1. Tap the headset multi-function button to transfer audio from the mobile phone to the headset.
2. Do not end the call on the mobile phone until the call is finished.

Alternatively audio can be transferred between mobile phone and handset by using the mobile phone's menu. Refer to your mobile phone documentation for further information.

### 9.2 LAST NUMBER REDIAL

The Jabra GO can redial the last number dialed (supported softphones and mobile phones only). Check specific softphone or mobile phone documentation for last number redial compatibility.

#### **Last number redial**

1. If necessary, press the softphone/mobile phone button on the touchscreen to set softphone/mobile phone as target phone.
2. Double-tap the headset multi-function button to redial the last number called.

### 9.3 AUTOMATIC DISCONNECT PREVENTION (UNSUPPORTED SOFTPHONES)

When on a call using an unsupported softphone, any incoming calls on a desk phone or mobile phone will automatically disconnect the softphone call. To prevent disconnection, tap the softphone icon on the touchscreen to open the softphone sub-menu, and then tap PC Audio Communication before making the call.





# 10. ADVANCED JABRA GO 6470 FEATURES

## 10.1 SAFETONE™ HEARING PROTECTION

SafeTone™ provides effective hearing protection against potential risks, such as acoustic shock and noise exposure. SafeTone™ consists of two components, PeakStop™ and IntelliTone™.

### PeakStop™ acoustic shock protection

PeakStop™ automatically suppresses sounds over 118dB(A), protecting hearing from acoustic shock. PeakStop™ is only available from Jabra.

### IntelliTone™ noise-exposure protection

IntelliTone™ offers four levels of protection against acoustic shock and noise-exposure. IntelliTone™ settings can be changed via the Jabra Control Center, under the 'Audio' tab, or via the touchscreen settings menu > Headset settings > Intellitone. IntelliTone™ is only available from Jabra.

| Protection level  | Criteria  |
|-------------------|---|
| Level 0 (default) | Basic protection (over 118dB(A))                  |
| Level 1*          | Less than 4 hours on phone/day                    |
| Level 2*          | 4-8 hours on phone/day                            |
| Level 3*          | More than 8 hours on phone/day                    |
| Level 4 (TT4)     | Recommended Australian protection level (Telstra) |

\*Compliant with Directive 2003/10/EC of the European Parliament and Council of 6 February 2003.

## 10.2 WIDEBAND AUDIO

The Jabra GO 6470 supports both wideband and narrowband audio. Wideband audio is supported for Softphones (PC) and offers better sound quality at a reduced battery time.

### Change wideband audio settings using the touchscreen

1. Tap the tool icon  on the touchscreen to open the settings menu.
2. Tap Phone settings > Softphone (PC)
3. Tap Enable wideband audio to enable.
4. When finished, press the back arrow to exit the menu.

### Change wideband audio settings using Jabra Control Center

1. Launch Jabra Control Center, and select the 'Softphone' tab.
2. Tick the checkbox under 'Enable wideband audio for', and then click Apply.

## 10.3 VOICE ANNOUNCEMENTS

Choose to hear an English voice announcement or a musical tone to indicate switching between a desk phone, softphone or mobile phone.

### Change voice announcement setting using the touchscreen

1. Tap the tool icon  on the touchscreen to open the settings menu.
2. Tap Headset settings > Voice Announcements
3. Tap to select English voice or Off (tones only). Off (tones only) is default-selected.
4. When finished, press the back arrow to exit the menu.

### Change voice announcement setting using Jabra Control Center

1. Launch Jabra Control Center, and select the 'Headset' tab.
2. Tick the relevant setting under 'Target change indication', and then click Apply.

## 10.4 TONE SETTINGS

Choose between three equalizer presets available for all sounds: Treble, Normal (default) and Bass.

### Change tone settings using the touchscreen

1. When on a call, tap the call options icon  on the touchscreen to open the call options menu.
2. Tap Tone Setting to open the tone setting menu.
3. Tick the preferred tone setting. Normal is default-selected.
4. When finished, press the back arrow to exit the menu.

### Change tone settings using Jabra Control Center

1. Launch Jabra Control Center, and select the 'Headset' tab.
2. Tick the relevant setting under 'Tone setting', and then click Apply.

## 10.5 LISTENING TO MUSIC OR AUDIO ON PC

To listen to music or audio played on a PC, an audio link between the Jabra GO base and the PC must be opened. When an audio link is open and no calls are active, any music or audio played on the PC (including music from a media player) will play in the headset. The Jabra device must be selected in Windows Sound and Audio control panel. Automatic audio link is default-enabled.

### Open/Close an audio link between base and PC

1. Launch Jabra Control Center.
2. Click the 'open/close audio link' button in the top toolbar.

Alternatively, right-click the Jabra icon in Windows taskbar, and select 'Open Audio Link' or 'Close Audio Link'.

## 10.6 FIRMWARE UPDATES

Firmware updates improve performance or add new functionality to your Jabra GO 6470 and the Jabra LINK 350 USB Bluetooth® Adapter.

### Update firmware

- Launch the Jabra Firmware Updater installed with Jabra PC Suite, and follow the Firmware Updater wizard, or
- Check for the latest version via Jabra Control Center > Help > Check for Updates.

## 10.7 THEFT PROTECTION

The base includes a Kensington Security Slot for attaching a security cable. To secure the base to your desk, purchase any safety cable usable with the Kensington Security Slot and follow the instructions included with the cable.

# 11. FAQs AND TROUBLESHOOTING

## **Q Why won't my headset pair with my mobile phone?**

A Check the following:

- Make sure that the headset is charged and in pairing mode. If the headset is already turned on, use the multi-function button to turn it off (press and hold down for 4 seconds), then turn it back on in pairing mode (press and hold for 4 seconds). In pairing mode, its LED should be a constant blue color. If the headset LED is red, the headset needs charging.
- Make sure that *Bluetooth*® is active on your mobile phone and put it into *Bluetooth*® pairing mode.

## **Q Why won't my headset pair with the Jabra LINK 350 USB *Bluetooth*® Adapter?**

A Check the following:

- Make sure that the headset is charged and in pairing mode. If the headset is already turned on, use the multi-function button to turn it off (press and hold down for 4 seconds), then turn it back on in pairing mode (press and hold for 4 seconds). In pairing mode, its LED should be a constant blue color. If the headset LED is red, the headset needs charging.
- Make sure the Jabra LINK 350 USB *Bluetooth*® adapter is in pairing mode. Plug the adapter into a PC, and then press and hold the adapter button until the adapter LED turns blue.

## **Q Why doesn't my computer detect the Jabra LINK 350 USB *Bluetooth*® Adapter?**

A Try connecting the USB *Bluetooth*® adapter to another USB port on the PC. Also, please note that it must be a direct connection - i.e. with no USB hub in between.

## **Q Why doesn't the headset work with my mobile phone or softphone (PC)?**

A Check the following:

- Make sure the headset is charged. The LED is a constant green when fully charged.
- Make sure the headset is within range of the USB *Bluetooth*® adapter or mobile phone.
- The adapter/mobile phone and the headset may no longer be paired.

## **Q Why can I not hear anything in my headset when using my mobile phone?**

A Check the following:

- Make sure the headset and mobile phone are paired and within range.
- Increase the speaker volume on the headset by sliding your finger along the touch panel on the headset.

## **Q My earhook/headband/neckband is broken. How do I get another one?**

A Contact your local Jabra supplier to place an order.

## **Q Why do I hear a low noise in the headset when there is silence at the other end?**

A The headset speaker volume might be too high. To decrease the volume, slide your finger down the headset touch panel.

## **Q Why can I not hear any sound, or listen to music from my PC, in my headset?**

A Check the following:

- Make sure the Jabra LINK 350 is selected as the current audio device both in Windows sound control panel and in the application you are using.
- Make sure the audio link to the PC is open. Right-click the Jabra Device icon in the Windows taskbar .
- Make sure softphone (PC) is enabled in Jabra PC Suite.

## **Q Does Wi-Fi interfere with Jabra GO 6470?**

A No. The Jabra GO 6470 uses adaptive frequency hopping, avoiding channels that are blocked by Wi-Fi.

## **Q Is it possible to listen in on calls with the Jabra GO 6470?**

A The risk of unauthorized access to communication via a *Bluetooth*® headset is very limited. The Jabra GO 6470 uses 128-bit encryption.

## **Q What is the range on the Jabra GO 6470?**

A The Jabra GO 6470 headset supports the following maximum ranges:

- When connected to the Jabra LINK 350 the range is up to 100m.
- When talking on (most) mobile phones the range is up to 25m.

## **Q What is the talk time for a Jabra GO headset?**

A Approximately 6 hours. Talk time depends on the device the headset is connected to.

# 12. TECHNICAL SPECIFICATIONS

## 12.1 JABRA GO HEADSET

**Wearing styles:**

Ear hook, headband, neckband (supplied or available as optional accessories).

**Dimensions:**

18mm x 76mm x 22.5mm.

**Weight:**

<18 g.

**Talk time:**

Up to 6 hours.

**Standby time:**

At minimum 100 hours.

**Charge time:**

- Charging from mains power: 0% - 80% in 25 minutes.
- Charging from car cigarette-lighter socket: 0% - 80% in 25 minutes, providing the charger has USB fast charge termination.
- Charging from PC (USB): from 0% - 80% in 60 minutes.

**Operating environment:**

-10°C to +60°C (when charging: 0°C to +45°C); Up to 95% RH non condensing.

**Call control:**

Headset multi-function button support for answer call, end call, voice-activated dialing, reject call, redial, swap held calls.

**Volume control and microphone mute:**

Controlled via touch panel on headset.

**Visual indicator:**

Multi-colored LED indicates call status, battery level, pairing status and other events.

**Audio indicators:**

Tones indicate incoming calls, low battery, volume level, microphone muting and other events; target phone can be indicated by English voice tag or target-specific melody.

**Bluetooth® version:**

BT 2.1.

**Bluetooth® range:**

Up to 100m when paired with a *Bluetooth®* wireless technology Class 1 device; up to 25m when paired with a *Bluetooth®* wireless technology Class 2 device.

**Bluetooth® profiles:**

Headset (HSP 1.1), hands-free (HFP 1.5), device identification (DIP 1.3).

**Bluetooth® pairing table:**

Up to 8 trusted devices.

**Microphone:**

Dual Noise Blackout microphones.

**Sound quality:**

DSP noise reduction; echo cancellation; tone control; narrowband and wideband audio (selectable per phone type).

**Firmware update:**

Downloadable from PC.

**Recharge:**

While docked in the Travel Charger and connected to the mains power, PC or car cigarette-lighter socket.

**PC-based configuration:**

All settings can be stored and loaded from a PC for backup and mass deployment.

## 12.2 JABRA GO HEADSET BATTERY

**Battery type:**

Lithium Ion.

**Battery capacity:**

125 mA/h, typical.

**Battery lifetime:**

Minimum 500 charge cycles (over 3 years when used for 8 hours a day).

**Shelf life:**

The battery holds a charge for at least 6 months in the off state before recharge is required.

**Replacement:**

The battery cannot be replaced..

## 12.3 JABRA GO TOUCHSCREEN BASE

The Jabra GO base meets the following specifications.

**Dimensions:**

160mm x 94mm x 82mm.

**Touchscreen:**

2.4 inch touch-sensitive TFT; Q-VGA resolution.

**Touchscreen functions:**

Advanced call handling, system configuration and setup wizard.

**Recharge cradle:**

Fits supplied Jabra GO headset; features magnetic coupling.

**Audio:**

Built-in speaker provides ring tones and/or audio feedback for touchscreen operation.

**Audio bandwidth:**

Narrowband or wideband.

**Desk phone connections:**

RJ-11 for handset, RJ-11 for phone body (or headset port), RJ-45 for AUX (for electronic hookswitch or GN1000 handset lifter).

**Remote call control standards:**

GN1000, Jabra IQ EHS, Cisco, DHSG and MSH. Each requires additional cabling and/or equipment available separately; more may become available in future and added via firmware upgrade. GN1000 is supported by default and requires no additional configuration.

**Busy light indicator:**

2.5mm jack connector (available as an accessory).

**PC connector:**

Micro USB.

**Firmware update:**

Downloadable from web, or via Jabra PC Suite. Language packs also available for touchscreen.

**PC-based configuration:**

All settings can be stored and loaded from a PC for backup and mass deployment.

**Softphone support:**

Full call handling for Skype, Microsoft Office Communicator and Cisco IP Communicator; for other softphones see headset as a standard sound card; support for additional softphones may be added via driver updates for the PC. For the latest updates, see [jabra.com/pcsuite](http://jabra.com/pcsuite) on the web.

**Theft protection:**

Kensington Security Slot standard.

This product contains font software programs which generate human readable typeface designs on base display. The font software family is Frutiger Next licensed to GN Netcom by Linotype.

## 12.4 JABRA LINK 350 USB *BLUETOOTH*® ADAPTER

**Dimensions:**

18.5mm x 53mm x 7.7mm.

**Operating environment:**

-10°C to +60°C; Up to 95% RH non condensing.

**PC Connection:**

Standard USB

**Bluetooth® version:**

BT 2.1, Class 1.

**Bluetooth® range:**

Up to 100m when paired with a Bluetooth® wireless technology Class 1 device; up to 25m when paired with a Class 2 device.

**Bluetooth® profiles:**

Headset (HSP 1.1), hands-free (HFP 1.5), device identification (DIP 1.3).

**Bluetooth® pairing table:**

Up to 8 trusted devices.

**Simultaneous Bluetooth® connections:**

Up to 2.

**Bluetooth® audio bandwidth:**

Narrowband or wideband.

**Firmware update:**

Downloadable from PC.

**Adapter button:**

Bluetooth® pairing, Bluetooth® connections and some call management.

**Visual indicators:**

Multicolor LEDs indicate pairing status, connection status, on-call status and other details.

**PC-based configuration:**

All settings can be stored and loaded from a PC for backup and mass deployment.

**Softphone support:**

Full call handling for Skype, Microsoft Office Communicator, Avaya and Cisco IP Communicator; for other softphones see headset as a standard sound card; support for additional softphones may be added via driver updates for the PC. For the latest updates, see [jabra.com/pcsuite](http://jabra.com/pcsuite) on the web

## 12.5 TRAVEL CHARGER

**Dimensions:**

34mm x 83.5mm x 26.5mm.

**Storage compartments:**

Holds both Jabra GO headset and Jabra LINK 350 USB Bluetooth® adapter.

**Capacity:**

5V / 500 mA.

**Power and data port:**

Mini USB.

**Connectivity:**

- Mains power socket, using supplied mains power adapter.
- PC (USB), using supplied mini USB-to-USB cable.
- Car cigarette-lighter socket, using car charge adapter (optional accessory).

## 12.6 MATERIALS AND ALLERGIES

The headband attachment is made of stainless steel and does not have a nickel-coated surface. Nickel release from the headband is 0.02 µg/cm<sup>2</sup>/week, which is below the 0.50 µg/cm<sup>2</sup>/week limit established by EU Directive 94/27/EF. The stainless steel alloy was tested for nickel release in accordance with the European standard EN 1811:1998.

Other wearing-style attachments are made of plastic and contain no known allergens. The leatherette ear cushions do not contain vinyl. The products contain no nickel, chrome or natural rubber that can come into contact with users' skin.

## 12.7 PRODUCT DISPOSAL

Please dispose of the headset according to local regulations and recycle when possible. Do not dispose as household waste. Do not dispose of the headset in a fire as the battery may explode. Batteries may also explode if damaged.

## 12.8 CERTIFICATIONS AND SAFETY APPROVALS

### CE

This product is CE marked according to the provisions of the R & TTE Directive (99/5/EC). Hereby, GN declares that this product is in compliance with the essential requirements and other relevant provisions of Directive 1999/5/EC. For further information, please consult <http://www.jabra.com>.

Within the EU, this device is intended for use in Austria, Belgium, Cyprus, Czech Republic, Denmark, Estonia, Finland, France, Germany, Greece, Hungary, Ireland, Italy, Latvia, Lithuania, Luxembourg, Malta, Poland, Portugal, Slovakia, Slovenia, Spain, Sweden, The Netherlands, United Kingdom, and within EFTA in Iceland, Norway and Switzerland.

### FCC

This device complies with part 15 of the FCC Rules. Operation is subject to the following two conditions: (1) This device may not cause harmful interference, and (2) this device must accept any interference received, including interference that may cause undesired operation.

Users are not permitted to make changes or modify the device in any way. Changes or modifications not expressly approved by Jabra will void the user's authority to operate the equipment.

This equipment has been tested and found to comply with the limits for a Class B digital device, pursuant to part 15 of the FCC Rules. These limits are designed to provide reasonable protection against harmful interference in a residential installation. This equipment generates, uses and can radiate radio frequency energy and, if not installed and used in accordance with the instructions, may cause harmful interference to radio communications. However, there is no guarantee that interference will not occur in a particular installation. If this equipment does cause harmful interference to radio or television reception, which can be determined by turning the equipment off and on, the user is encouraged to try to correct the interference by one or more of the following measures:

- Reorient or relocate the receiving antenna.
- Increase the separation between the equipment and receiver.
- Connect the equipment into an outlet on a circuit different from that to which the receiver is connected.
- Consult the dealer or an experienced radio/TV technician for help.

### Industry Canada

Operation is subject to the following two conditions: (1) This device may not cause interference and (2) This device must accept any interference, including interference that may cause undesired operation of the device. The term "IC:" before the certification/registration number only signifies that registration was performed based on a Declaration of Conformity indicating that Industry Canada technical specifications were met. It does not imply that Industry Canada approved the equipment.

### Patents and design registration pending international

# Jabra®

A BRAND BY

**GN Netcom**

© 2011 GN Netcom A/S. All rights reserved. Jabra® is a registered trademark of GN Netcom A/S. All other trademarks included herein are the property of their respective owners. (Design and specifications subject to change without notice).

MADE IN CHINA  
TYPE: 9400HS/BS



32-00683 RevF



## Free Manuals Download Website

<http://myh66.com>

<http://usermanuals.us>

<http://www.somanuals.com>

<http://www.4manuals.cc>

<http://www.manual-lib.com>

<http://www.404manual.com>

<http://www.luxmanual.com>

<http://aubethermostatmanual.com>

Golf course search by state

<http://golfingnear.com>

Email search by domain

<http://emailbydomain.com>

Auto manuals search

<http://auto.somanuals.com>

TV manuals search

<http://tv.somanuals.com>