



GlobalMap 1000

INSTALLATION AND OPERATION INSTRUCTIONS

LITHO IN U.S.A.

988-0134-00

LOWRANCE ELECTRONICS, INC.
12000 E. SKELLY DR., TULSA, OK 74128

WARNING!

USE THIS MAPPING UNIT ONLY AS AN AID TO NAVIGATION. A CAREFUL NAVIGATOR NEVER RELIES ON ONLY ONE METHOD TO OBTAIN POSITION INFORMATION.

The background maps built into this unit are not intended for navigation. The accuracy of these maps has not been verified. The maps are derived from U.S. Government sources which rely on ground and aerial surveys and satellite data. Since there can be inaccuracies in the data used to create the map and the map's resolution, and position inaccuracies in the navigation system, you should use caution when using this product.

CAUTION

When showing navigation data to a position (waypoint), this unit will show the shortest, most direct path to the waypoint regardless of obstacles. Therefore, the prudent navigator will not only take advantage of all available navigation tools when travelling to a waypoint, but will also visually check to make certain a clear, safe path to the waypoint is always available.

NOTICE!

As of this writing, the Department of Defense (DOD) has not declared the GPS navigation system operational. The system is still in a testing phase. Satellites can be turned off or accuracy can be degraded at will by the system operators. Remember this if you use a GPS receiver as the position input to the GlobalMap 1000.

**C-MAP™**

The C-MAP™ database is not intended as a replacement of official nautical charts which are required for safe navigation.

Copyright® 1993 Lowrance Electronics, Inc.
All rights reserved.

All features and specifications subject to change without notice.
All screens in this manual are simulated.

TABLE OF CONTENTS

INTRODUCTION	1
MOUNTING	1
BRACKET MOUNT	1
IN-DASH MOUNT	2
POWER CONNECTIONS	3
DATA INPUT AND OUTPUT CONNECTIONS	4
DGPS BEACON RECEIVER	7
MAPLINK™	10
LOWRANCE GPS MODULE INSTALLATION	11
KEYBOARD	14
GETTING STARTED - INITIALIZATION	15
DGPS SETUP	16
LOWRANCE LGC-1 GPS MODULE	17
COLD START	19
LGC-1 GPS MODULE TEST	19
MAPPING/NAVIGATION/STEERING DISPLAYS	20
MAP SCREEN	21
MAPPING OPTIONS	23
CARTRIDGE SWITCH	25
C-MAP SETUP	25
CURSOR	26
TRAIL PLOTTER	27
EVENT MARKER	29
NAVIGATION SCREEN	31
STEERING SCREEN	32
C.D.I. RANGE	33
SATELLITE/DGPS INFORMATION SCREEN	33
CUSTOMIZE SCREENS	35
WAYPOINT NAVIGATION	37
HOW TO SAVE A WAYPOINT	37
QUICK SAVE METHOD	37
VIEW AND SAVE METHOD	37
EDITING A WAYPOINT	38
WAYPOINT SYMBOLS	39
GOTO A WAYPOINT	40
CANCEL NAVIGATION	40
ERASE A WAYPOINT	41
WAYPOINT DISPLAY	41
ROUTES	42
CREATING A ROUTE	42
NAME A ROUTE	42
WAYPOINT SELECTION	43
REMOVE A WAYPOINT	46
EDIT WAYPOINT	46
ERASE A ROUTE	46
FOLLOWING A ROUTE	47
GPS ALARMS	49
ARRIVAL ALARM	49
XTE (CROSS TRACK ERROR) ALARM	50
ANCHOR ALARM	50
PERPENDICULAR ALARM	51
NMEA OUTPUT	51
UNITS OF MEASURE	52
CONTRAST, VOLUME, AND LIGHT ADJUSTMENT	53
MAN OVERBOARD	53
DATUMS	55
PCF (Position Correction Factor)	56
POSITION FILTER	58
PRESET	58
GPS SIMULATOR	58
LAST-MINUTE CHANGES	59

NOTES:

6. TRAIL PLOT

If you turn the plot trail recording off, (using the Trail Recording function on the "Mapping Setup" menu) then the GlobalMap 1000 will stop plotting your trail. However, it will show your trail on the map up to the point that you turned it off.

7. TRAIL PLOT

There is a maximum of 2000 dots available to plot a trail.

8. EVENT MARKER

Pressing the EVENT MARKER key twice puts the last used marker at your present position or at the cursor position if it's displayed.

9. EVENT MARKER

You can't erase event markers from the display when it's in the "course-up" mode.

10. The storage temperature for your unit is from -4 degrees to +167 degrees Fahrenheit (-20 to +75 degrees Celcius). Extended storage temperatures higher or lower than specified will cause the liquid crystal display to fail. Neither this type of failure nor its consequences are covered by the warranty. For more information, consult the factory customer service department.

INTRODUCTION

The GlobalMap 1000 is a high quality, wide screen mapping unit with performance that is second to none in its class. Using menu features and "soft-key" operation, the GlobalMap 1000 is also one of the easiest-to-use products that Lowrance has ever built. It sets new standards in mapping versatility and performance by combining a built-in reference map (background map) with the ability to read mapping cartridges (requires optional MapLink™ cartridge reader.) The display and keyboard are also lighted for night operation.

The GlobalMap 1000's built-in background map includes virtually the whole world, however, over 70% of the map's detail is in the 48-contiguous states, Hawaii, and southern Canada. If you install the MapLink cartridge reader, the GlobalMap 1000 can display highly detailed charts available on C-Map cartridges, covering most coastal areas around the world. In the future, Lowrance will also have cartridges available that cover many inland areas.

MOUNTING - Bracket Mount

Install the GlobalMap 1000 in any convenient location, provided there is clearance behind the unit when it is tilted for the best viewing angle. Holes in the bracket base allow wood screw or through-bolt mounting. You may need to place a piece of plywood on the back of thin fiberglass panels to secure the mounting hardware. Make certain there is enough room behind the unit to attach the power and MapLink cables (if used).

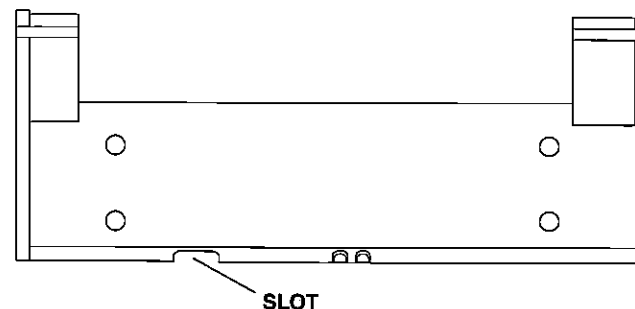

The smallest hole that will pass the power plug is one inch. After the hole is drilled, pass the MapLink connector up through the hole first (if used), then pass the power cable down through it.

After the cables have been routed, fill the hole with a good marine sealing compound. Offset the bracket to cover the hole. Route the power and MapLink cables through the slot in the back of the bracket.

IN-DASH MOUNTING

The GlobalMap 1000 can be installed in the dash with the supplied hardware if the dash is 1/2" thick or less. Determining the dash thickness can be difficult, however, if you remove a gauge from the dash, you can easily measure the thickness. Try this in an area that's close to the location that you wish to install the unit, since the thickness can vary significantly in some boats. Make certain there is clearance behind the dash for the unit and there is enough room to tighten the bolts on both sides of the unit.

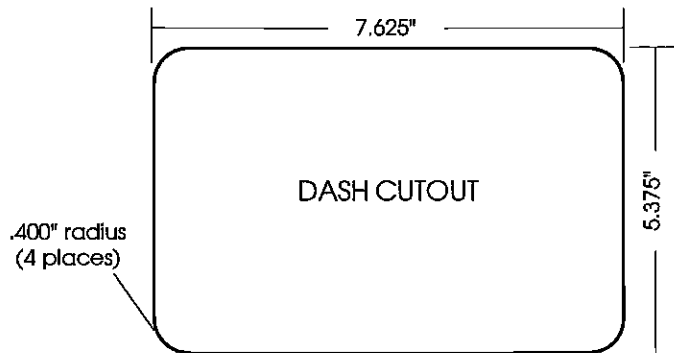

Once you've determined the location for the unit, cut the hole according to the drawing shown above. Measure carefully before cutting! After cutting the dash, place the gasket supplied with the GlobalMap 1000 around the unit and place the unit in the hole.

Supplied with the GlobalMap 1000 are rubber pads, bolts, washers, and cam clamps to attach it to the dash. Peel the adhesive backing off the rubber pads and place one on each side of the unit in the location where the cam clamp will touch the back side of the dash. Using the hardware supplied with the unit, attach the unit to the dash. Looking at the back of the unit, make certain that the cam clamp on the left side of the unit is pointing down and the cam clamp on the right side of the unit is pointing up before you start tightening the bolts.

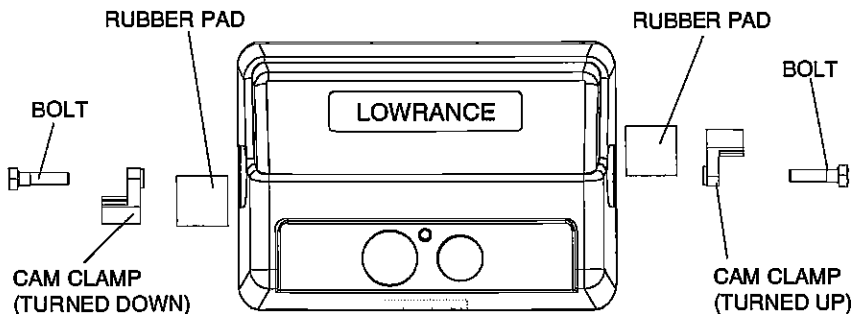

To turn the simulator on, press the MENU key two times. Now press the key next to the "Simulator" label. The screen clears and the simulator begins operation. To turn the simulator off, either repeat the above steps or turn the unit off.

LAST MINUTE CHANGES & ERRATA

1. C-MAP

The GlobalMap 1000 won't operate in the course up mode when the C-Map™ background map is in use.

2. C-MAP

Buoys and other navigational aids have additional information available when using a C-MAP cartridge. To view this data, move the cursor on top of the desired symbol, as shown at right. Now press the ENT key. The screen shown below appears. An information box shows on the screen, giving information about the selected symbol. To erase this message box, press the CLR key.

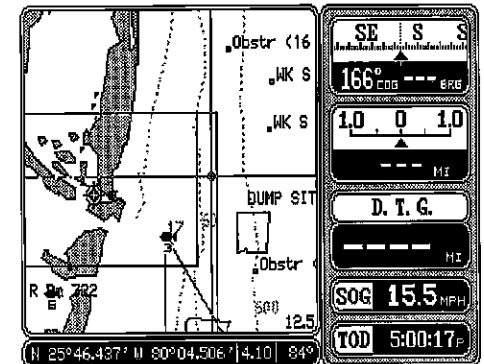

3. ROUTES and WAYPOINTS

If an asterisk * appears next to a waypoint in the list of waypoints used in a route, then that waypoint has changed since it was added to a route. For example, if you use waypoint number one in a route and later change the waypoint's location, then the GlobalMap 1000 will place an asterisk next to the waypoint's number in the route list. This alerts you to any change made to any waypoint used in a route, including name, symbol, and position.

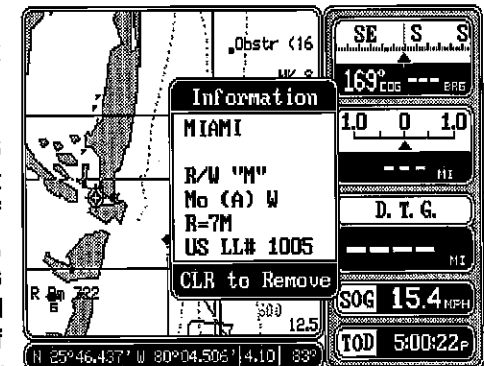

4. CURSOR

The cursor is not available when the map is in the "course up" mode.

POSITION FILTER

No matter what kind of radionavigation input you're using with the GlobalMap 1000, "jitter" or small position changes will show on the display even when you're not moving. For example, if the GPS module or antenna is mounted high above the deck, position changes will occur as the boat rolls in the waves. The position filter will average the jitter, showing a smoother position and navigation display. (The jitter affects not only the position, but all other displays including course over ground and speed over ground.) There are three settings: off, low, and high. When the GlobalMap 1000 is first turned on or is preset, the filter is turned off. To set the filter, press the MENU key twice. The screen shown above appears. Now press the key next to the "Filter" label until the check mark is on the desired setting. Press the CLR key to exit this screen and put your change into effect.

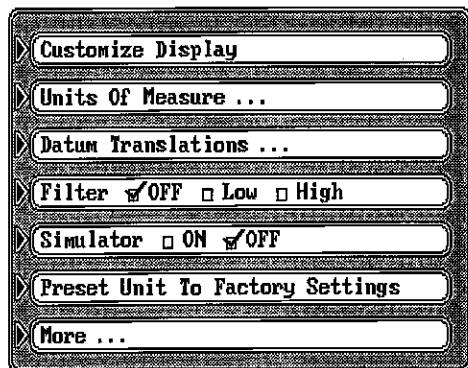

PRESET

The preset feature returns all of the GlobalMap's settings to their original factory settings. This resets the units of measure, speaker volume, display contrast, and more. However, this doesn't erase any event markers, waypoints or routes.

To preset the unit, press the MENU key two times. The screen shown above appears. Now press the key next to the "Preset Unit to Factory Settings" label. A message appears, warning you that this will preset the unit. Press the ENT to preset the unit or the CLR key to exit without presetting. If you press the ENT key, the menu screen disappears and the GlobalMap 1000 returns to the mapping screen. All units will be returned to their factory settings.

SIMULATOR

The GlobalMap 1000 has a simulator feature that shows your present position travelling a preset course from Miami, Florida. All navigation features of the unit operate, also. A recurring message appears alerting you that the simulator mode is enabled. **DON'T USE THIS UNIT FOR NAVIGATION WHEN THE SIMULATOR IS OPERATING!**

POWER CONNECTIONS

The GlobalMap 1000 works from a twelve-volt battery system. For the best results, attach the power cable directly to the battery. You can attach the power cable to an accessory or power buss, however you may have problems with electrical interference. Therefore, it's safer to go ahead and attach the power cable directly to the battery. If the cable is too short, splice #18 gauge wire onto it. The power cable has four wires; red, black, green, and white. Red is the positive lead, black is negative or ground. Make certain to attach the in-line fuse holder to the red lead as close to the power source as possible. For example, if you have to extend the power cable to the battery or power buss, attach one end of the fuse holder directly to the battery or power buss. This will protect both the unit and the power cable in the event of a short. The GlobalMap 1000 uses a 3-amp fuse.

IMPORTANT!

Do not use this product without a 3-amp fuse wired into the power cable! Failure to use a 3-amp fuse will void your warranty.

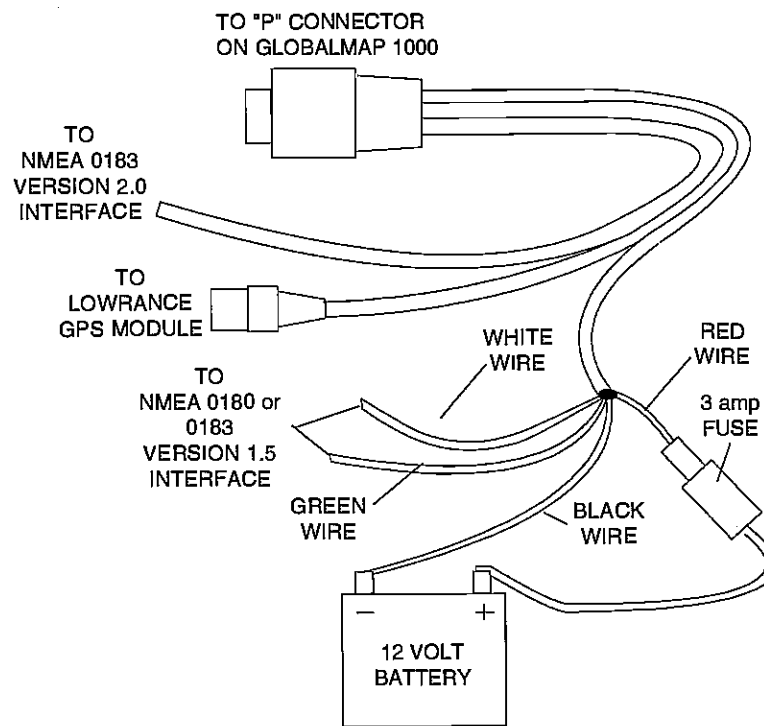

GlobalMap 1000 POWER CONNECTIONS

DATA INPUT AND OUTPUT CONNECTIONS

In order for the GlobalMap 1000 to show position information, it requires navigation data from either a Loran-C, Decca, or GPS receiver than can send the data in NMEA 0183 version 1.5 or 2.0 format. If the NMEA input is not used, then the Lowrance LGC-1 GPS receiver can be used.

The wiring connections for the NMEA 0183 version 1.5 are different than the ones used for the NMEA 0183 version 2.0. If you are using version 1.5, then use the green and black wires on the GlobalMap's power cable. If you are using version 2.0, then you'll be using the four shielded wires on the GlobalMap's power cable.

If you're using the Lowrance LGC-1 GPS module, simply plug its cable directly into the in-line connector on the GlobalMap's power cable. This sends navigation data directly to the GlobalMap without using any NMEA input. You can, if desired, use either NMEA output to drive another device while using the LGC-1 as an input. The GlobalMap 1000 also has the provision for a DGPS beacon receiver for use with the LGC-1 GPS module.

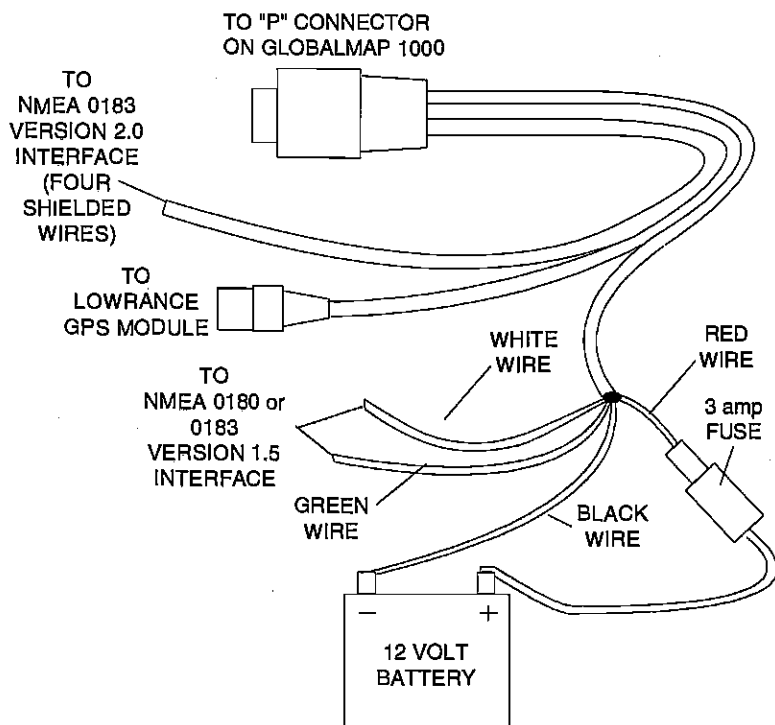

indicates what the possible error is. This feature should always be reset to zero (0) when finished with that chart.

For example, suppose you are stopped at a location that is accurately marked on a chart. Your unit shows a longitude position that is .010 degrees less than the one on the chart. Using the Position Correction Factor (PCF) Offset feature, you make the unit read the same as the chart. If you move, the unit will continuously add the change to all position displays. This makes it more closely match the datum used by the chart. For this reason, you should be careful when entering the PCF offset. This offset is saved in memory. It doesn't change when the unit is turned off. However, a Preset does erase the PCF factor.

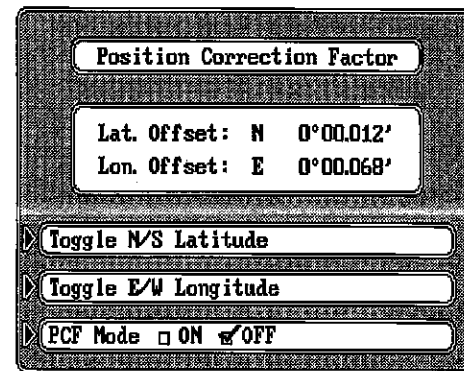

To set the PCF factor, first press the MENU key two times, then press the key next to the "Datum Translations" label. Finally, press the key next to the "PCF" label at the bottom of the display. The screen shown above appears.

Now enter the correction for your location. Remember, this is the difference between the location shown on the present position display and the position shown on the chart. In this example, we have entered 0 degrees, .012 minutes north latitude and 0 degrees, .068 minutes east longitude as the PCF offset. That is the difference between the present position shown on the unit and our position shown by the chart. In other words, our position shown on the unit is 0.012 minutes south and 0.068 minutes west of the position shown on the chart.

After you've entered the desired offset, press the key next to the "PCF Mode ON OFF" label. This turns the PCF correction factor that you entered on. To leave this screen, press the CLR key. This also puts your changes into effect.

To turn these changes off, return to this screen and press the key next to the "PCF Mode ON OFF" label. Remember, presetting the unit also erases any PCF offset, thereby turning it off.

There are two boxes on the left side of the screen. One reads "Source Datum", the other is "Display Datum." Before changing the Datum, you need to know which datum the navigation receiver supplying position data to the GlobalMap 1000 is using. For example, all Lowrance GPS receivers (including the LGC-1 GPS receiver) use WGS 84; all Lowrance Loran-C receivers use WGS 72.

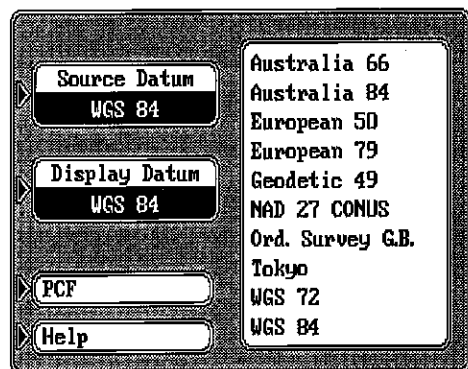

The display datum box shows the datum currently displayed on the mapping screen by the GlobalMap 1000. If the display datum is different from the source datum, the GlobalMap 1000 "translates" the source datum to the displayed one. This lets you display a map using any datum on the list on the right side of the screen.

To change either the source or displayed datum, first press the key on the right side of the screen next to the desired box that you wish to change. Then press the up or down arrow keys to move highlight the datum you wish to use. For example, to change the source datum from WGS 84 to WGS 72, simply press the key next to the "Source Datum" label, then press the down arrow key until "WGS 72" is highlighted. When the source box shows the correct datum, press the ENT key. This saves the datum displayed in the source box.

Once you have the desired datums showing in both the source and the display boxes, press the CLR key. This unit returns to the mapping screen, using the datums you specified.

The default for both the source and display datums is WGS 84.

PCF (Position Correction Factor)

Another method used to reduce the error factor between datum is called PCF, or Position Correction Factor. This unit gives you the capability to move or "offset" the position shown on the display to match the one on the chart. The unit will add this offset or PCF to all position displays at all times.

Remember, the position error on any radionavigation system is very dynamic and the PCF offset should never be used in an attempt to cancel the error. In general terms this feature should only be used if your map

NMEA 0183, VERSION 1.5 WIRING CONNECTIONS

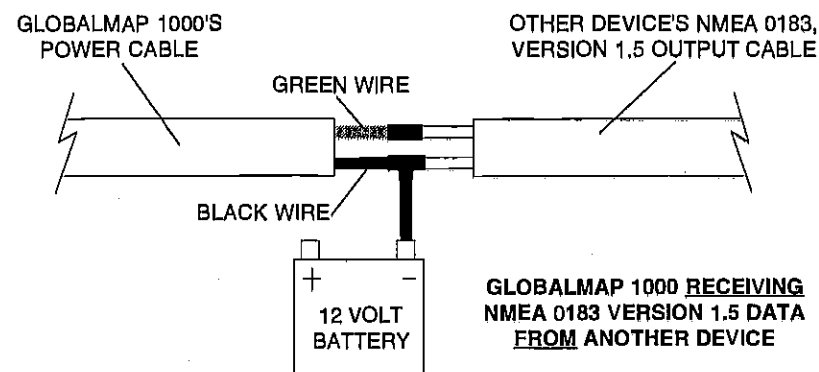

The white and green wires are for a NMEA 0183, version 1.5 interface. The GlobalMap 1000 sends data to other electronic navigation devices through the white wire and receives NMEA data through the green wire. If the white and green wires are not used, tape their ends so that they cannot short.

To connect a device to the GlobalMap 1000's NMEA 0183 version 1.5 **input**, attach a twisted pair cable from the device's NMEA **output** to the green and black wires on the GlobalMap 1000's power cable. Solder the ground conductor of the twisted pair to the black wire on the power cable.

To connect a device to the GlobalMap 1000's NMEA 0183 version 1.5 **output**, attach a twisted pair cable from the device's NMEA **input** to the white and black wires on the GlobalMap 1000's power cable. Solder the ground conductor of the twisted pair to the black wire on the power cable. See the other instrument's manual for more wiring instructions.

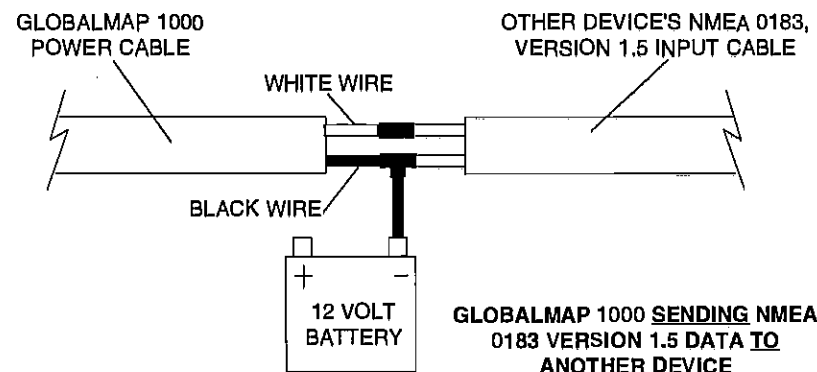

NMEA VERSION 2.0 WIRING CONNECTION

The shielded red, black, white and green wires are for a NMEA 0183, version 2.0 interface. This is a shielded, balanced line interface. Do not use the shield on these wires! Trim the shield back, away from the splice when you attach wires from another device to the GlobalMap 1000. The GlobalMap 1000 sends data (transmits) to another electronic navigation device through the shielded white and green wires and receives NMEA data through the shielded red and black wires. If any of these wires are not used, tape their ends so that they cannot short.

To send data to the GlobalMap 1000, connect the other device's NMEA 0183 version 2.0 **output** to the GlobalMap's NMEA 0183 version 2.0's **input** (GlobalMap receives data) by attaching a twisted pair cable from the other device's NMEA **output** to the shielded red and black wires on the GlobalMap II's power cable.

In order for the GlobalMap 1000 to send data to another device, connect the other device's NMEA 0183 version 2.0 **input** to the GlobalMap's NMEA 0183 version 2.0's **output** (GlobalMap sends data) by attaching a twisted pair cable from the other device's NMEA **input** to the shielded white and green wires on the GlobalMap II's power cable.

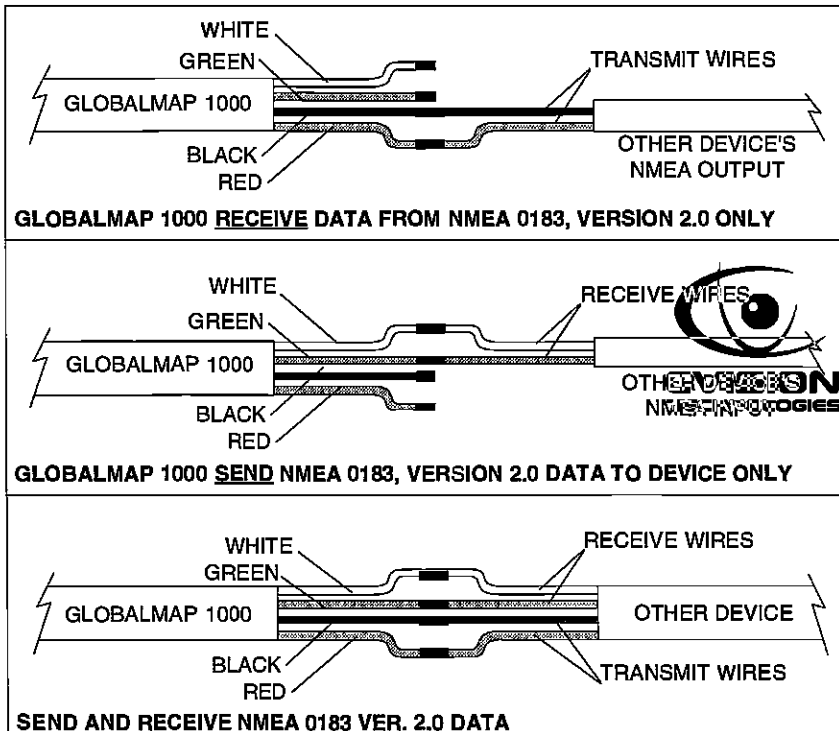

To add the position shown at the top of Man Overboard Information menu to the waypoint table, simply press the key next to the "Covert Man Overboard to Waypoint" label. The GlobalMap 1000 will assign that position to the first available waypoint number in the waypoint table. This waypoint can be edited the same as any other waypoint on the list, including the name, symbol, and position.

Remember, repeated pressing of the Man Overboard key does not repeatedly save your present position! The unit only saves the position the first time the Man Overboard key is pressed. To save a new Man Overboard position, you must first reset Man Overboard by pressing the key next to the "Reset Man Overboard" label on the Man Overboard Information menu.

You can navigate to a waypoint using the Waypoint Recall feature at any time, however this stops the GlobalMap 1000 from navigating to the Man Overboard position.

Remember, saving the victim is the primary goal. Try all options to rescue the person immediately after the accident happens. Training and education are also good accident preventative. The Coast Guard has excellent safety courses. Instruct all members on board your boat on safety procedures before leaving the dock. Make certain all on board know what to do before any emergency occurs.

DATUMS

The GPS navigation system relies on complex mathematical calculations to determine your position based on satellite data and other factors. One factor is the Earth's shape. Since the Earth is not a true sphere, variations in the calculations have to be made to accommodate deviations. To make matters more complex, not everyone uses the same data to determine what the deviations are. The size and shape of the ellipsoids that are used to approximate the earth's surface are improved often. This can lead to errors if your navigation device uses one ellipsoid, while your chart uses a different one. The term used for these ellipsoids is "Datum."

To reduce the error factor between datum, this unit gives you the capability to select the datum used by the GlobalMap 1000 when displaying the map. You can select a new datum from a list or enter a correction offset based on latitude/longitude.

To change the datum, first press the MENU key two times. Now press the key next to the "Datum Translations" label. The screen shown at the top of the next page appears.

you navigate back to the man overboard position.

Man Overboard Information

Once you've saved a Man Overboard position, the unit shows navigation data to that position until you reset the Man Overboard function, turn the unit off, or use the Cancel Navigation feature.

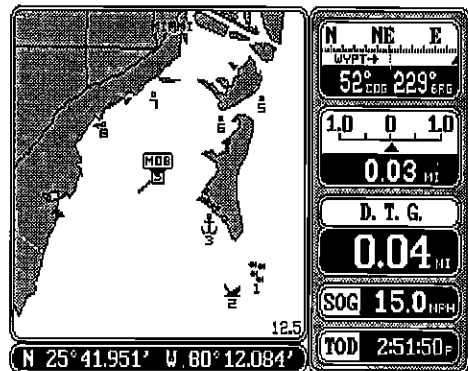

To reset the Man Overboard or view more information about it, press the WAYPT/ROUTE key. Now press the key next to the "Man Overboard Information" label. The screen shown below appears.

Your position, time, and date when the Man Overboard key was pressed shows at the top of the screen. If you wish to save your present position instead of the one shown at the top of the screen, press the key next to the "Save New Man Overboard" label. If you're not currently navigating to the Man Overboard position and wish to do so, press the key next to the "Navigate to Man Overboard Location" label. The GlobalMap 1000 will instantly show navigation data to the position shown at the top of this screen.

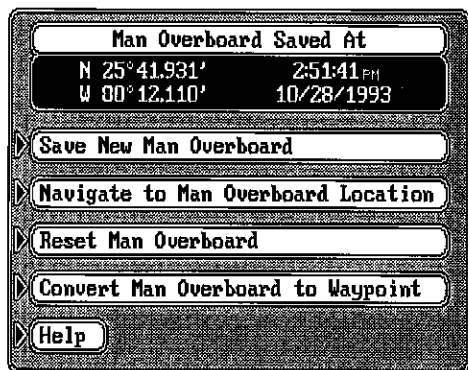

Once the Man Overboard key is pressed, your present position is saved in memory. Pressing the key again won't save your position again, instead a warning message will appear. This prevents the inadvertent loss of the current Man Overboard position by someone accidentally pressing the Man Overboard key. To reset the Man Overboard function which "arms" the key, press the key next to the "Reset Man Overboard" label on the menu shown above.

The GlobalMap 1000 doesn't save the Man Overboard position in the waypoint table. However, it does save the position on the Man Overboard Information screen.

For the GlobalMap 1000 to both send and receive NMEA 0183, version 2.0 data, see the wiring diagram at the bottom of the previous page.

Remember, under no circumstances should the shields on the GlobalMap's wires be connected to the ground on the other device. See the other instrument's manual for more wiring instructions.

NOTE

When using the shielded wires (NMEA 0183 version 2.0), do not connect the black wire to the battery's ground.

DGPS BEACON RECEIVER CONNECTIONS

If the Lowrance LGC-1 GPS receiver is connected to the GlobalMap 1000, a differential (DGPS) beacon receiver can also be connected, giving you higher accuracy positions in the area covered by the beacon receivers. The unshielded green wire (used with the NMEA version 1.5 data) on the power cable is used for the differential (DGPS) beacon receiver input. At this time two DGPS beacon receivers can be connected to the GlobalMap 1000. These are the Starlink model MRB-2A and Magnavox MX-50R. Please note that the GlobalMap 1000 will not send NMEA 0183 data when the Magnavox MX-50R receiver is connected.

To connect a beacon receiver to the GlobalMap 1000, attach a twisted pair cable from the beacon receiver's output to the green and black wires (unshielded) on the GlobalMap 1000's power cable as shown below. Solder the ground conductor of the twisted pair to the black wire on the power cable.

After the beacon receiver is connected to the GlobalMap 1000, see the "Input/Output Setup" section for information on setting the communication parameters for the DGPS receiver.

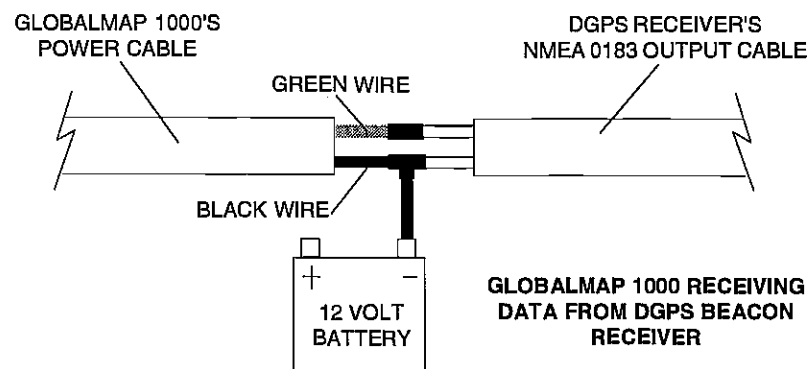

SAMPLE WIRING DIAGRAMS

GLOBALMAP 1000 RECEIVING NMEA 0183, VERSION 1.5 DATA FROM NAVIGATION RECEIVER.

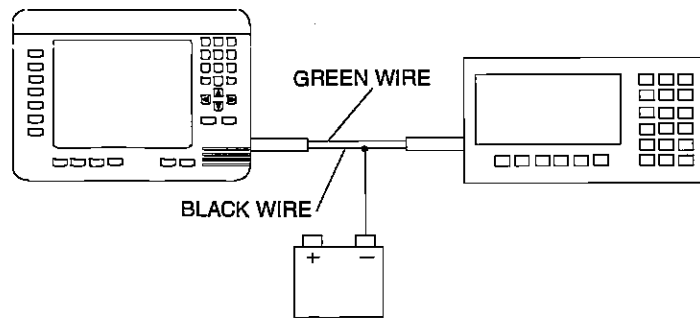

GLOBALMAP 1000 RECEIVING NMEA 0183, VERSION 2.0 DATA FROM NAVIGATION RECEIVER.

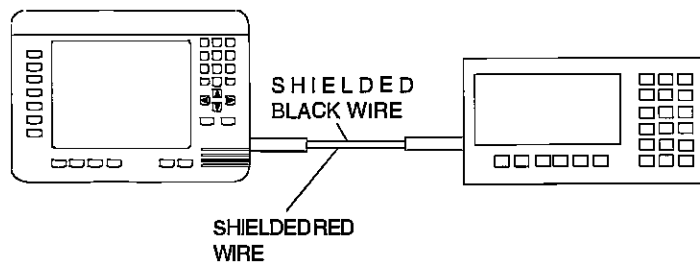

GLOBALMAP 1000 RECEIVING NMEA 0183, VERSION 1.5 DATA FROM NAVIGATION RECEIVER AND SENDING NMEA 0183, VERSION 1.5 DATA TO ANOTHER DEVICE.

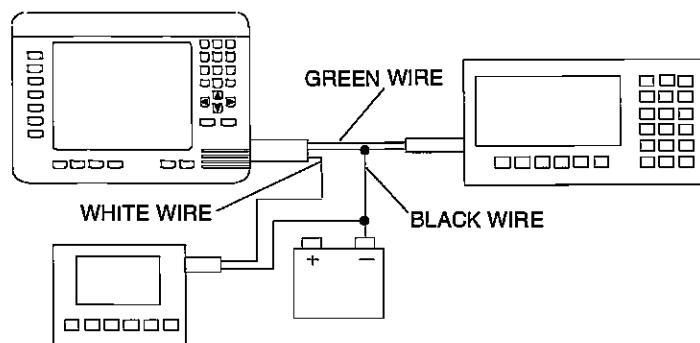

CONTRAST , VOLUME, and LIGHT ADJUST

The GlobalMap 1000's display contrast, speaker volume, and light brightness are adjustable from the same menu screen. To adjust any or all of these features, press the MENU key, then press the key next to the "Contrast, Volume, and Brightness" label. The screen shown at right appears. Three vertical bar graphs appear on this screen. When you first enter this screen, the contrast is ready for adjustment. To change another feature on this screen, simply press the left or right arrow key to highlight the desired feature. Then press the up or down arrow keys to increase or decrease the level. When you have everything on this page adjusted as desired, press the CLR key to exit.

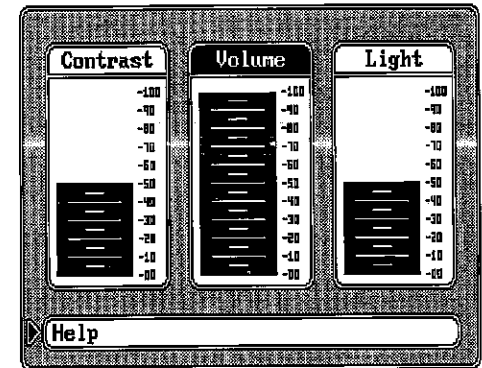

Note: To turn the lights on, simply press the ON key again after turning the GlobalMap 1000 on. To turn the lights off, press the ON key again.

MAN OVERBOARD

One of boating's most terrifying events is having a friend or family member fall overboard. This situation can be deadly on any body of water, fresh or salt. It's particularly dangerous at night or if you're out of sight of land. Of course, the first thing to do is remain calm and try all standard safety measures to try and rescue the person. If you lose sight of the person, you can use the GlobalMap 1000 to help start a search pattern.

Once you're back at the helm after initial rescue efforts have failed, press the GlobalMap 1000's MAN OVERBOARD key. A message appears:

"Now Navigating to Man Overboard Location". A screen similar to the one at right appears. Your position at the time you pressed the Man Overboard key is shown by a box with the letters "MOB" inside. All digital navigation displays including Distance (DTG), Bearing (BRG), Course (COG), Speed Over Ground (SOG), and Time To Go (TTG) show data that let

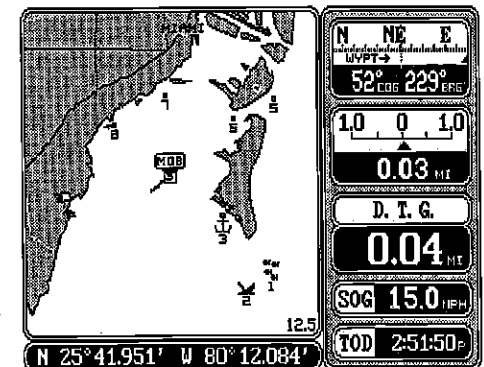

UNITS OF MEASURE

The units of measure used in the GlobalMap 1000 are adjustable. This includes time, distance, altitude, direction, speed, and depth. To change any of the settings, first press the MENU key two times. Now press the key next to the "Units of Measure" label. The screen shown below appears. Simply press the key next to the label that you wish to change until the check mark in that label moves to the desired setting. Press the CLR key to exit this screen and return to a mapping or navigation screen.

Time

Time can be shown on the displays as 12 hour (A.M. - P.M.), 24 hour (2:00 P.M.= 1400 hours), or UTC time. Normally, the GlobalMap 1000 shows your local time in 12 hour format, but you can also display UTC time (which is the time at Greenwich, England).

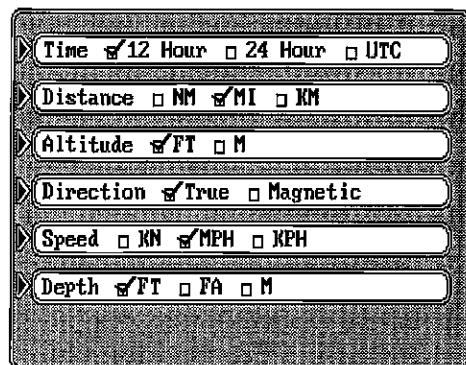

Distance

The distance can be shown in nautical miles (NM), statute miles (MI), or kilometers (KM).

Altitude

Press the key next to the Altitude label to switch it from feet to meters.

Direction (True and Magnetic Position)

True north is the top of the world. It's where all lines of longitude converge. Magnetic north is the location our compasses point. It lies several hundred miles to the south of true north, at a location in Canada.

The GlobalMap 1000 can display navigation information in magnetic or true. When it's turned on for the first time true is used. Press the key next to the "Direction" label to switch it to magnetic.

Speed

The GlobalMap 1000 can display speed in knots (KN), statute miles per hour (M.P.H.), or kilometers per hour (K.P.H.). The default setting for speed is statute miles per hour.

Depth

Water depth readings shown on the C-Map charts can be shown in feet (FT), fathoms (FA), or meters (M).

GLOBALMAP 1000 RECEIVING NAVIGATION DATA FROM LOWRANCE LGC-1 GPS MODULE

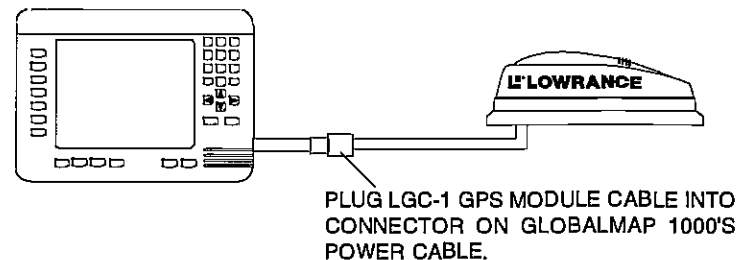

GLOBALMAP 1000 RECEIVING NAVIGATION DATA FROM LOWRANCE LGC-1 GPS MODULE AND DGPS BEACON RECEIVER.

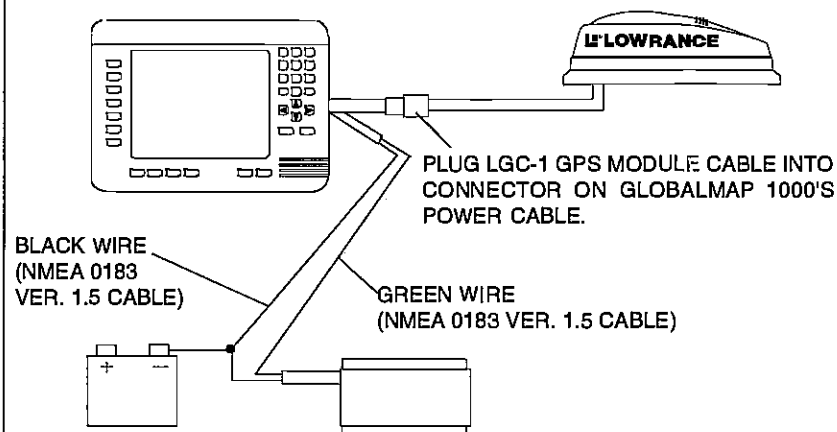

GLOBALMAP 1000 RECEIVING NMEA 0183, VERSION 2.0 DATA FROM NAVIGATION RECEIVER AND SENDING NMEA 0183, VERSION 1.5 DATA TO ANOTHER DEVICE.

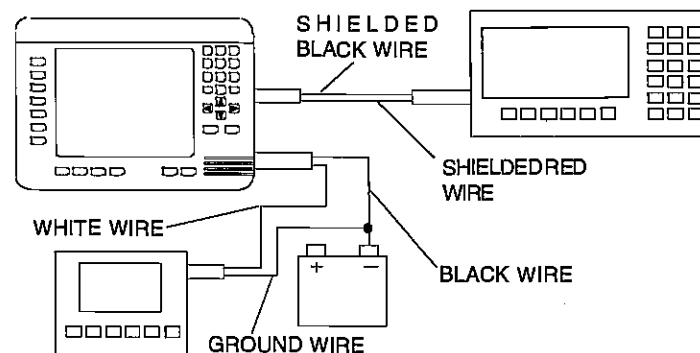

MAPLINK™

The GlobalMap 1000 has an internal "background" map that covers almost the whole world. It also shows southern Canada, all of the continental United States, and Mexico at a higher resolution than other countries. This map is sufficient for most users, however, Lowrance has an optional cartridge reader called the Maplink that accepts both Lowrance and C-Map™ cartridges. These cartridges have small area maps built into them that allows you to "zoom" in and see much more detail than is available on the built-in map. The Maplink also has the C-Map™ background map built into it, so you have the option of using it or the Lowrance background map at any time, even if a cartridge isn't plugged into the Maplink.

To install the Maplink, follow the instructions included with it. It can be mounted on top of the dash, under the dash, or in the dash for a clean, professional look. Once it's installed, route the cable included with the Maplink to the small connector on the back of the GlobalMap 1000. If the supplied cable is too short, an extension cable, model MLXT-12 is available that is 12 feet long. After connecting the cable, the Maplink is ready for use. The Maplink receives its power through the connecting cable, simplifying the installation.

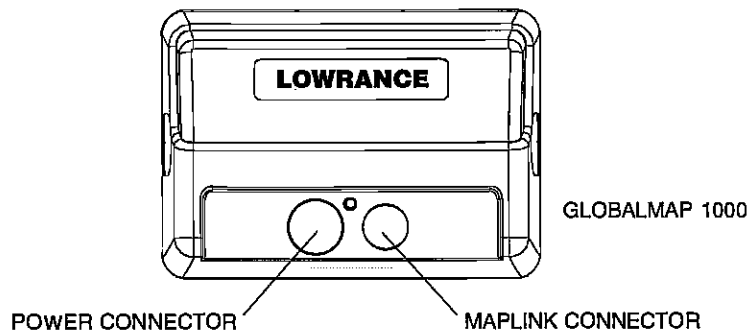

You can attach up to seven Maplink cartridge readers to the GlobalMap 1000. This lets you use different cartridges without having to unplug one and replace it with another when you move out of the first cartridge's area. This also allows the mounting of the Maplinks under the dash, out of sight.

If you're not using the Maplink, connect the small terminator plug supplied with the GlobalMap 1000 into the small connector on the back of the unit. This will protect the connect from the elements.

PERPENDICULAR ALARM

The perpendicular alarm sounds when your course is even with a waypoint and is starting to pass it. The perpendicular alarm has no adjustment. It doesn't care how far from a recalled waypoint you are; it sounds only when you're passing the recalled waypoint. For example, on the map at right, the waypoint is perpendicular to the present position's course.

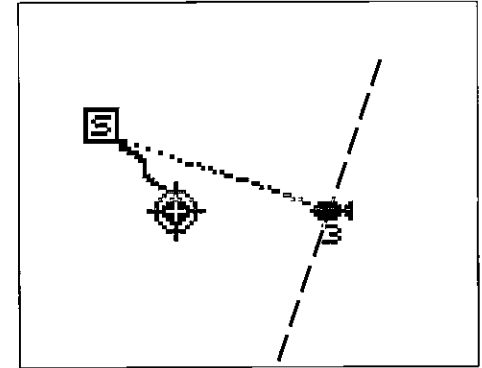

In this example, as soon as the present position crosses the imaginary dashed line, the perpendicular alarm will be "tripped" and sound an alarm.

NMEA OUTPUT

The GlobalMap 1000 sends data out according to standards set by the NMEA (National Marine Electronics Association). This allows the GlobalMap 1000 to send position, and navigation information to "listener" units, such as autopilots and other marine instruments. The GlobalMap 1000 uses the following NMEA data protocols: NMEA 0180 and 0183. NMEA 0180 sends steering information only. It's useful mainly for autopilots. NMEA 0183 sends position, steering, speed, and more. In order to use this feature, the wires on the power cable must be connected to the NMEA data input on the other instrument. See the installation section in the front of this manual for wiring connection information.

Once you connect the wiring properly, the GlobalMap 1000 must be told which data format to use. Consult the owner's manual of the "listener" equipment to see which format it needs. Then set the GlobalMap 1000 as follows: First, press the MENU key. Next, press the key next to the "I/O and Initialization" label. Now press the key next to the "NMEA Output" label until the check mark moves to the desired position - either 0183 or 0180. Press the CLR key to exit this screen. The GlobalMap 1000 will start sending NMEA data.

Note: If the Magnavox DGPS receiver is connected to the GlobalMap 1000, no NMEA data can be sent.

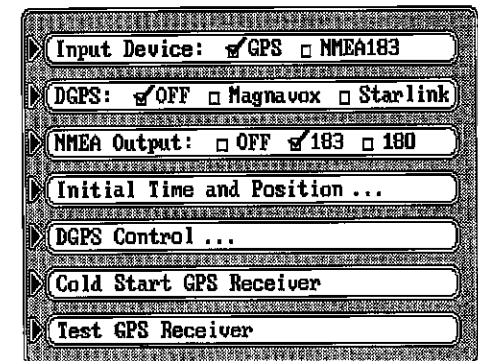

recalled waypoint if the arrival alarm's setting is .1 mile. We've drawn the imaginary arrival alarm radius on the screen at right. As you can see, the present position symbol hasn't reached the circle. When it does, the arrival alarm will sound. The alarm is adjustable from .010 to 9.99 miles.

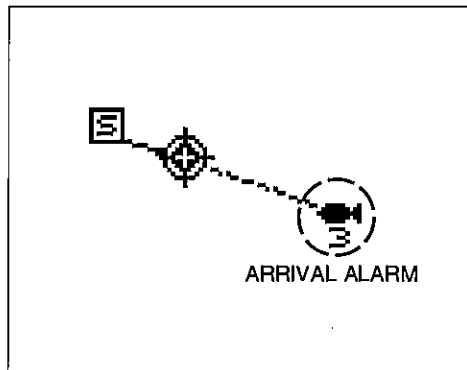

XTE ALARM

The XTE (cross track error) alarm sounds a tone when your cross track error is greater than the alarm's setting. As shown on the map at right, the boat's cross track error is 3/4 mile. If the XTE alarm is set to 1 mile, the alarm sounds, (shown by an imaginary line on the screen at right) letting you know how far off course your present position is. This alarm is adjustable from .010 to 9.99 miles.

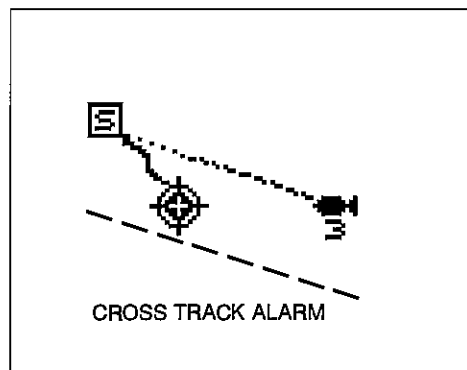

ANCHOR ALARM

The anchor alarm sounds a tone when the present position moves outside a preset radius. For example, if you set the anchor alarm to .1 nautical mile (600 feet), then the alarm will sound if you move more than 600 feet from the location where you set the alarm. It's adjustable from 0.01 to 9.9 miles. On the map at right, the anchor alarm is set to .5 miles. If the boat moves outside the .5 mile circle, the anchor alarm will sound a tone.

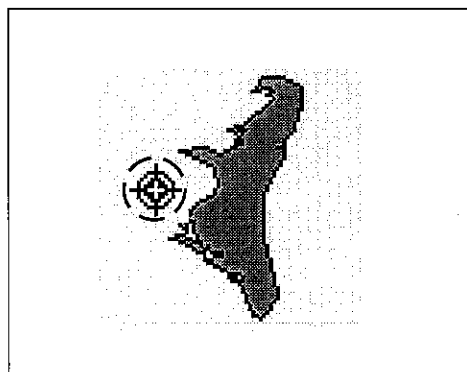

The LOWRANCE LGC-1 GPS MODULE

This optional GPS receiver is currently used with all Lowrance GPS gimbal-mount products. It's small, rugged, and fast. The five channel design lets it track all satellites in view and acquire up to five satellites at one time. It sends position information to the GlobalMap 1000 once every second. By incorporating Rockwell's GPS receiver technology with Lowrance's state-of-the-art design and manufacturing capabilities, Lowrance brings to the consumer one of the most advanced line of GPS marine navigation systems available in the world.

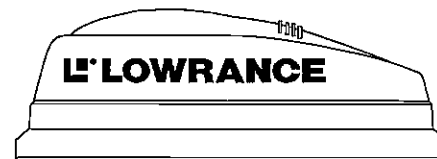

GPS MODULE INSTALLATION

The GPS module can be installed on a flat surface or (with the supplied adapter) on a pole. Mount the module in an area that guarantees a clear view of the sky at all times. In order for the module to receive the signals from the satellites, it must not be obstructed. An ideal location is on a cabin roof, or deck. The gunnels also make a good location. Attaching the pole mounting adapter lets you install the module on a one inch mast. However, for lightning protection, the antenna shouldn't be the highest part of the boat.

Surface Mounting - With Access

If you have access underneath the mounting surface, use the gasket supplied with the GPS module as a template. Drill four 5.5 mm (7/32") holes and one 17 mm (11/16") hole for the module's cable. Attach the cable to the module and pass it down through the hole in the gasket and the mounting surface. Use 5 mm screws, flat washers, and lock washers to fasten the GPS module to the mounting surface. Route the cable to the GlobalMap 1000.

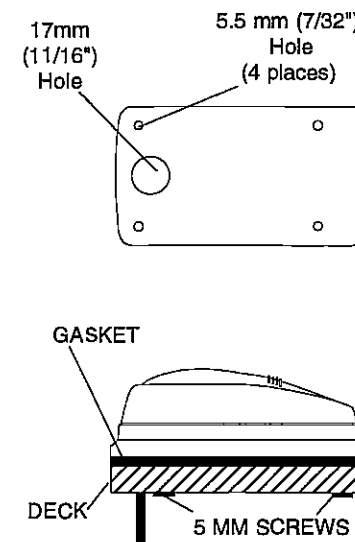

Surface Mounting - Without Access

If you don't have access to the back side of the mounting surface, use the "cleats" supplied with the GlobalMap 1000. (Note: This is assuming you can "snake" the module's cable to a location that is accessible. A hole will still need to be drilled in the mounting surface for the cable.) Using the gasket as a template, mark and drill the 17 mm (11/16") hole for the cable. Attach the cable to the module and drop the other end of the cable through the gasket and down the hole. Place the module on the gasket. Slide the "cleats" onto each end of the module and (using the cleats as templates) mark four holes for 5 mm (#10) mounting screws. Drill the holes, then replace the cleats on the module and fasten them to the mounting surface with 5 mm (#10) screws. Route the cable to the GlobalMap 1000.

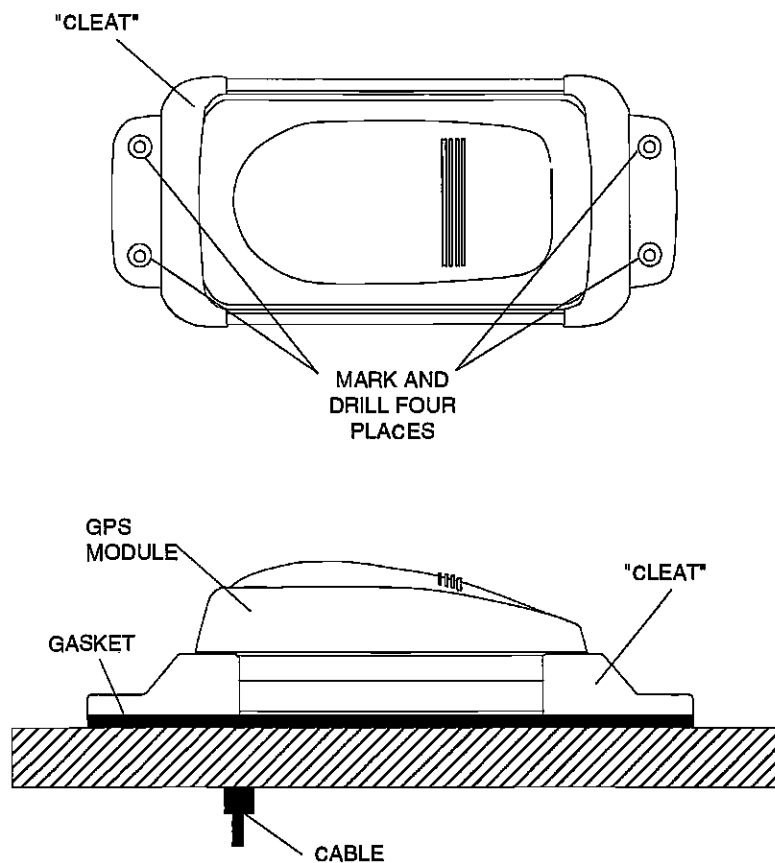

GPS ALARMS

The GlobalMap 1000 has four alarms. One is an arrival alarm that sounds when you come within a preset distance to a waypoint. Another is a cross track error alarm that sounds when you move off course more than the alarm's setting. The anchor alarm sounds when you move outside a preset radius. The last alarm is called the "perpendicular alarm". This alarm sounds when you cross an imaginary line perpendicular to your course that passes through the waypoint. All of these alarms are set identically except the perpendicular alarm which has no adjustment.

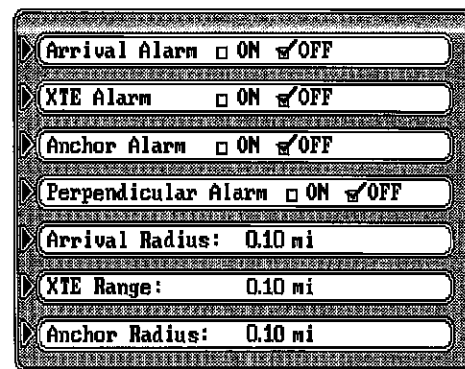

To adjust an alarm, first press the MENU key. Now press the key next to the "Alarms" label.

The screen shown at right appears. This screen is divided into two parts. The top half lets you turn an alarm on or off. The bottom half lets you adjust the arrival, cross track error, and anchor radius alarms. The default for all alarms is "off." To turn an alarm on, simply press the key next to the alarm's label. This moves the check mark from the "off" box to the "on" box. After you've turned the alarm on, simply press the CLR key to exit this screen.

Adjusting Alarm

If you need to adjust the alarm's settings, simply press the key next to the alarm's label at the bottom of the screen, then enter the change using the numbered keys. For example, to change the arrival radius from 0.10 to 0.25 mile, first press the key next to the "Arrival Radius" label. Now enter the following numbers: 0 2 0. Press the ENT key when you're finished. The arrival radius will read 0.20 mi. You can press the left or right arrow keys to move between the numbers or the CLR key to exit without making a change while editing the alarm setting. Press the CLR key to exit this screen.

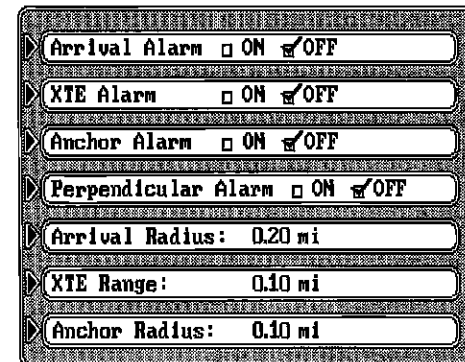

ARRIVAL ALARM

The arrival alarm sounds a tone when your position is within the alarm's radius of a waypoint. For example, the alarm sounds if you come within .1 mile of a

when you reach the last waypoint in the route, the arrival alarm sounds until you turn it off.

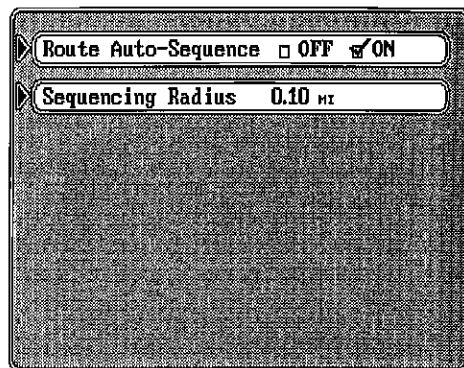

After you decide which direction to run the route, a new menu appears as shown at right. This is the auto-sequencing menu. With auto-sequencing turned on (the default), the GlobalMap will show navigation data to the first waypoint in the route until you come within 0.10 mile of the waypoint. This distance is the sequencing radius. As soon as this happens, the GlobalMap 1000 sounds a tone, letting you know that you are within 0.10 mile of the waypoint's location. It then automatically switches to the next waypoint in the route, showing navigation to the second waypoint location. This process repeats until the route is completed. When you arrive at the last waypoint in the route, the GlobalMap 1000 sounds a tone continuously until you turn the tone off.

If you turn auto-sequencing off, the GlobalMap 1000 won't automatically switch to the next waypoint after arriving at a waypoint. Instead, once you arrive at a waypoint, you'll need to press the WAYPT/ROUTE key, then press the key next to the "Advance Route to Next Waypoint" label as shown on the screen at right.

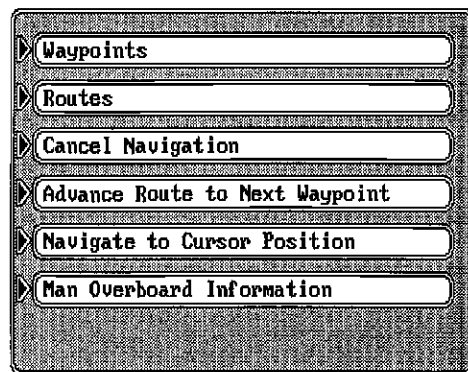

To change the sequencing radius, (distance from the waypoint that will signal the sequence tone and change to the next waypoint in a route) press the key next to the "Sequencing Radius" label. Now enter the desired radius using the numbered keys. Press the ENT key when you're finished or the CLR key to exit without changing the radius.

The auto-sequencing menu can also be found by first pressing the WAYPT/ROUTE key, then the key next to the "Routes" label. Finally, press the key next to the "Setup..." label. The auto-sequencing menu shown at the top of this page appears.

Pole Mount

First, thread the pole mounting adapter onto the mounting pole or ratchet base. Align the pole mounting adapter so the module will face the bow of the boat. Install and tighten the set screw into the pole mounting adapter and tighten it securely. This should prevent the GPS module from unscrewing from the pole. Place the gasket onto the pole mounting adapter. Now attach the cable to the GPS module and pass the cable through the gasket, pole mounting adapter, and pole. Set the GPS module on top of the pole mounting adapter and align the four threaded holes in the module with the holes in the pole mounting adapter. Using the four stainless steel 5 mm screws and lock washers supplied with the LGC-1, attach the pole mounting adapter to the GPS module. This completes the assembly.

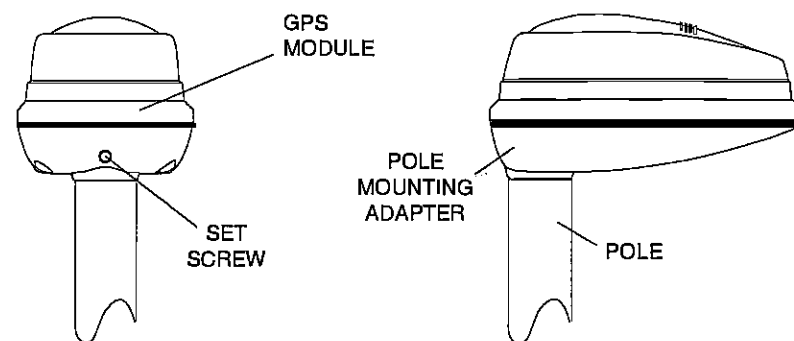

If the pole or mast you're using isn't hollow or if the hole in the middle of the pole is too small for the connectors, use the cable mounting adapter supplied with your unit. Thread the cable mounting adapter into the GPS pole mounting adapter. Then thread the pole into the cable mounting adapter. Route the cable down the outside of the pole.

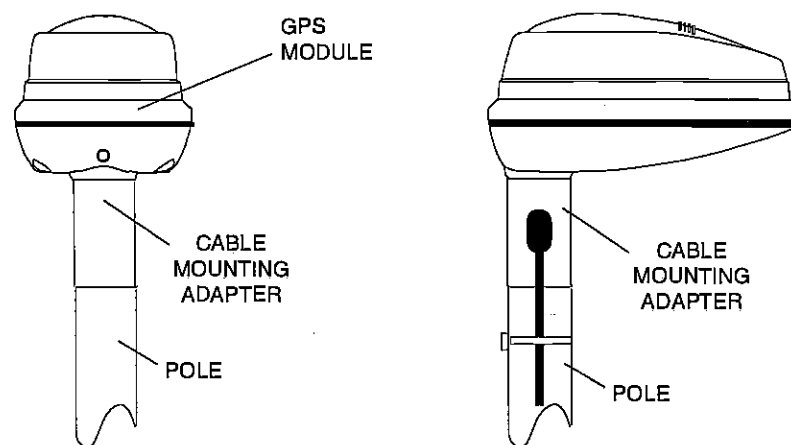

KEYBOARD

The keyboard has keys arranged in a vertical column on the left, plus a horizontal row at the bottom. A ten-key pad and arrow keys on the right side of the screen lets you enter and change data on the screen. The menu key in the bottom left corner of the keyboard activates the first menu page. The keys along the bottom of the screen are used to switch between maps and the digital navigation, steering, and position screens. The Event Marker key lets you place icons on the display, while the Man Overboard key is used for emergencies.

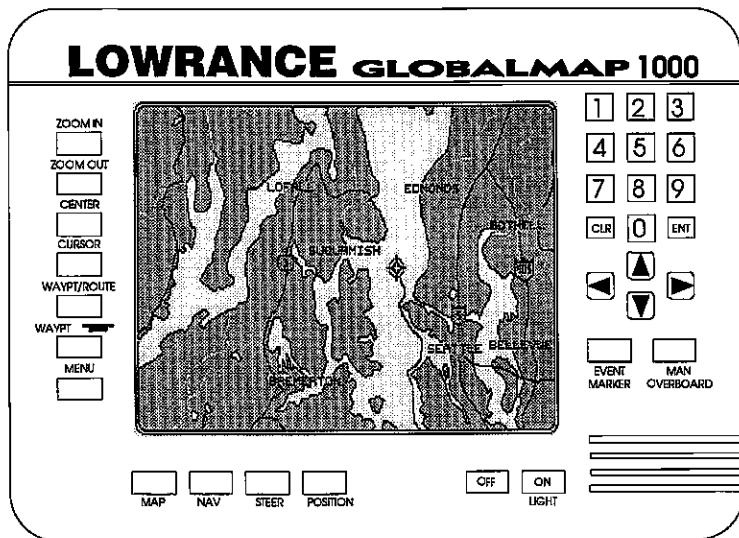

MAP - Press this key to show the Mapping Screen.

NAV - This key shows the digital navigation screen.

STEER - Press this key to show the Steering Screen.

POSITION - This key gives you access to the digital position screen.

ZOOM IN - Expand the map to see more detail by pressing this key.

ZOOM OUT - To see a wider area of the map, press this key.

CENTER - Centers the map around your present position.

CURSOR - Pressing this key activates the moveable cursor lines.

WAYPT/ROUTE - This key lets you save or recall a waypoint or route.

WAYPOINT QUICK SAVE - Pressing this key instantly saves your position.

route you want to remove from the list as shown at right. Now press the key next to the "Erase Route" label. A warning message appears, telling you this route will be permanently erased from memory. Press the ENT key to erase the route, the CLR key to cancel. A new message appears, asking if you want to erase the waypoints used in the route from the waypoint list. If you press the ENT key, all of the waypoints used in this route will be erased from the waypoint list. If you want to keep the waypoints, simply press the CLR key. The GlobalMap 1000 erases the route from the list after the key (ENT or CLR) is pressed.

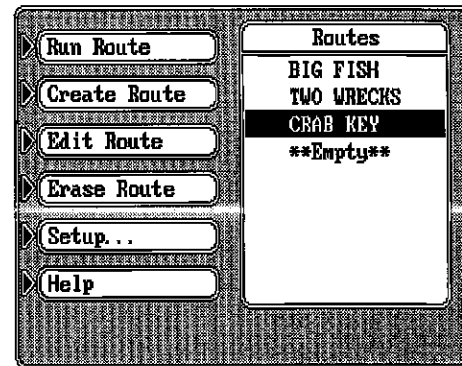

FOLLOW A ROUTE

To follow a route, first press the WAYPT/ROUTE key, then press the key next to the "Routes" label. The screen shown above appears. Now move the black box to the desired route using the arrow keys, then press the key next to the "Run Route" label. The screen shown at right appears.

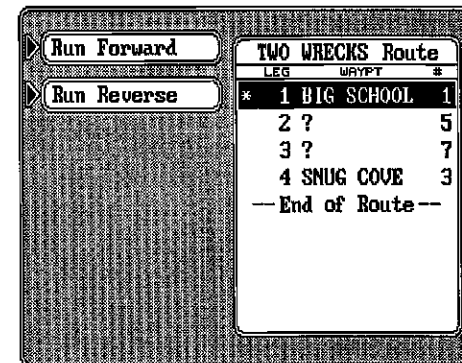

The list of waypoints used in the route shows on the right side of the screen. The black box surrounds the first waypoint in the list. This means the first waypoint on the list will be the first waypoint used in the route. If you want to travel to a different waypoint in the route first, move the black box to the desired waypoint using the arrow keys. Now press the key next to the "Run Forward" or "Run Reverse" labels. To run forward through the route means you travel to the first waypoint in the list first, then all of the others. To run backward through the route means you start at the last waypoint in the list and move backward through the list of waypoints. For example, suppose you have three waypoints in a route and they're numbered 3, 6, and 2. If you travel forward through the route, the unit will show navigation data to waypoint number 3 first, then 6, and finally 2. If you travel backward through the route, the unit will start with waypoint number 2 first, then 6, and end with waypoint number 3. No matter if you travel forward or reverse through the route,

earlier. Next, press the key adjacent to the "Add From Keys" label. The screen shown at right appears. This is identical to the waypoint edit screen shown on page 34. Use the arrow keys to move between fields. Enter the waypoint name, symbol, and position, then press the ENT key to save the waypoint and return to the route edit screen.

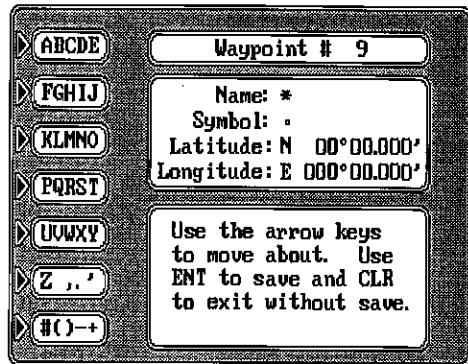

Remove Waypoint

To erase a waypoint from the list of waypoints used in a route, first recall the route by pressing the WAYPT/ROUTE key, then pressing the key next to the "Routes" label. Use the arrow keys to highlight the route you want to change. Now press the key next to the "Edit Route" label. The screen shown at right appears.

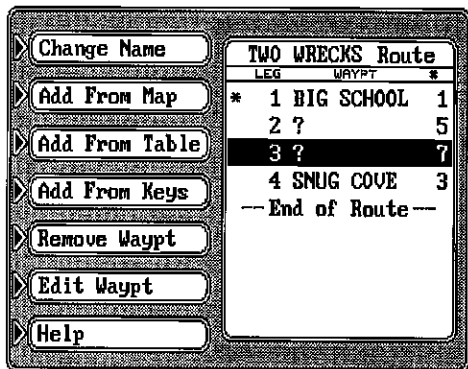

Move the black box to the waypoint you want to erase. Now press the key next to the "Remove Waypt" label. The GlobalMap 1000 erases the waypoint from the list. Press the ENT key to save your changes.

Edit Waypoint

After a waypoint has been added to a route, any of the elements of that waypoint can be changed. To do this, first press the arrow keys to move the black box to the waypoint that you wish to change. Next, press the key adjacent to the "Edit Waypt" label on the "Edit Route" menu shown above. The "Edit Waypt" screen is identical to both the waypoint entry and the "Add from Keys" screens. It lets you change the waypoint's name, symbol, and location. See page 34 for instructions on this screen. After making the desired changes, press the ENT key to save them. The unit returns to the "Edit Route" screen shown above.

Erase Route

To erase a route from the list, first press the WAYPT/ROUTE key, then press the key next to the "Routes" label. Use the arrow keys to highlight the

EVENT MARKER - To mark a location on the plotter screen, use this key.

MAN OVERBOARD - Pressing this key instantly saves your present position and switches the unit into a mode that shows navigation data to the last saved position.

ARROW KEYS - These keys are used to make menu selections and to move the cursor lines on the screen.

CLR - This key clears menus and erases entries from the screen.

ENT - This key is used to enter numbers and make selections.

ON - The ON key turns the GlobalMap 1000 on. Pressing this key after turning the unit on turns the display and keyboard's lights on.

OFF - Press and HOLD the Off key to turn the GlobalMap 1000 off.

GETTING STARTED - INITIALIZATION AND I/O

Once all power and data connections have been made, the next step is to turn the GlobalMap 1000 on. A message appears on the screen. You must press the CLR key to erase this message. Next you need to tell it which data input to use. This only needs to be done once, since it stores this information in battery backed-up memory. The data input choices are NMEA 0183 or Lowrance GPS. When the GlobalMap 1000 is turned on for the first time "out-of-the-box", it expects the LGC-1 Lowrance GPS module to be connected. If this module is connected, then the GlobalMap 1000 sends a "cold-start" message to the module. The module will then start looking for the satellites. It can take up to 15 minutes for the module to determine your position. To speed up this process, you can initialize the module by sending it your present position, time, altitude, and date. See page 17 for details on initializing the LGC-1 GPS module.

If you have an external GPS, Loran-C, or Decca receiver connected to the GlobalMap 1000 through the NMEA cable, you'll need to select the NMEA 0183 input. To do this, first press the MENU key. Now press the key next to the "I/O and Initialization" label. The screen shown at right appears. Next, press the key next to the "Input Device" label. This switches the unit from the Lowrance GPS module (GPS) and

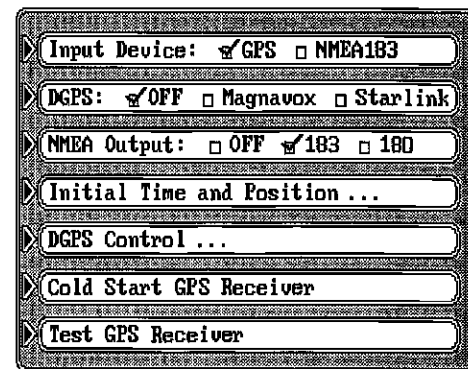

the NMEA 0183 data input (NMEA183). Finally, press the CLR key to exit this screen.

Once you switch to the proper data input, the GlobalMap 1000 should show your present position on the display once the navigation receiver transmits it. If you're certain the navigation receiver is sending position data, but the present position display continues to flash for over 15 seconds, (signifying that it isn't receiving data) then check all wiring connections.

DGPS SETUP

Some areas have installed or are planning to install differential transmitters that send correction data to a special receiver. When this receiver is connected to the GlobalMap 1000 along with a Lowrance LGC-1 GPS module, highly accurate positions can be plotted. If you have a differential (DGPS) beacon receiver connected, you'll need to set some parameters on the GlobalMap 1000. To do this, first press the MENU key, then press the key next to the "/O and Initialization..." label. The screen shown above appears. Turn the DGPS input on by pressing the key next to the "DGPS: Off Magnavox Starlink" label until the check mark moves to the DGPS receiver that you have connected to the GlobalMap 1000. Next, press the key adjacent to the "DGPS Control" label. The screen shown below appears.

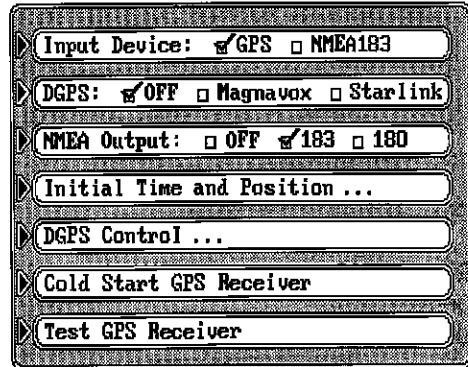

Every DGPS transmitter has a slightly different frequency and bit rate. The GlobalMap 1000 needs to know the frequency of the transmitter and its bit rate that you will be using with the DGPS beacon receiver. To enter the DGPS transmitter's frequency, first press the key next to the "DGPS Beacon Frequency:" label. Now, (using the numbered keys) enter the frequency of the transmitter. Press the ENT key when you're finished. Next, press the key next to the "DGPS Beacon Bit Rate:" label. Enter the bit rate, again using the numbered keys. Press the ENT key when you're finished. If you

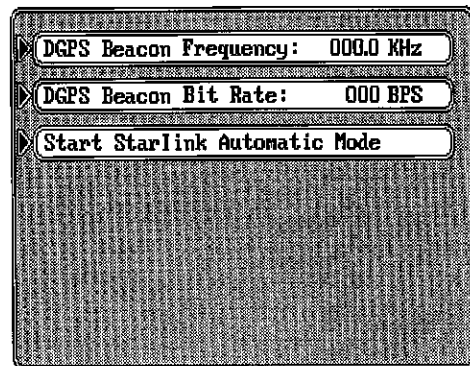

nine are shown. To see more waypoints, simply press the down arrow key. The position of the highlighted waypoint is shown at the bottom of the screen. Bearing and distance from your present position to the waypoint are shown next to the waypoint's latitude/longitude.

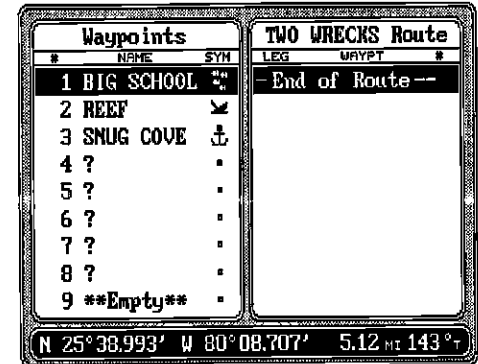

The route name is shown at the top right-hand side of the display. Beneath it is the list of waypoints used in the route. Of course, if you just created the route, the list will be empty.

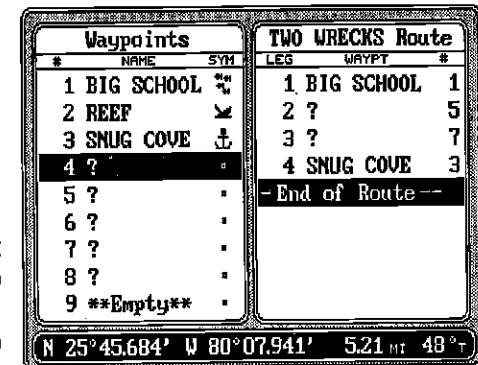

To add a waypoint to the route, press the down arrow key until the black box surrounds the first waypoint that you wish to add to the list, then press the ENT key. The waypoint shows at the top of the list under the route name on the right side of the screen. When all of the waypoints have been added to the route, press the CLR key. This returns you to the edit route menu as shown below. If the route shown on this screen is the way you want it, press the ENT key to save it. The GlobalMap 1000 returns to the route menu with your route shown on the list.

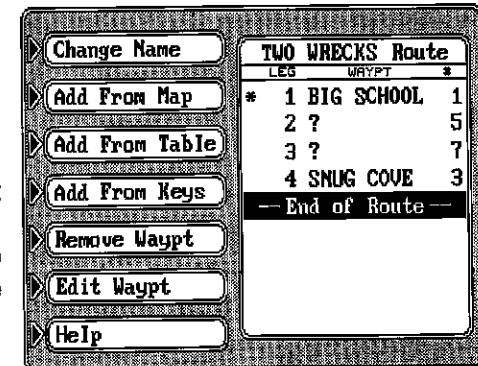

Add From Keys

The GlobalMap 1000 lets you enter each waypoint in the route directly from the keyboard. In other words, you enter the latitude/longitude of each waypoint in the route. This method also lets you choose the waypoint name, number, and symbol.

To add waypoints to a route from the keyboard, first name a route as shown

waypoints in the route have been selected. Press the CLR key when you're finished. A screen similar to the one below right appears.

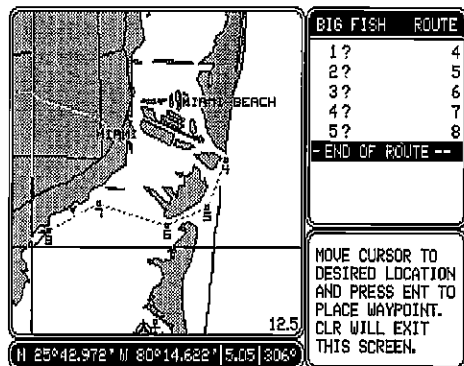

The waypoints used in this route appear on the right side of the screen. In this example route, we saved five waypoints, so there are five "legs" on the route. Question marks appear for the name on all of the waypoints, since you can't name the waypoints while entering them from the map. If you wish to change anything about the waypoint, i.e. name, position, or icon, see the "Edit Waypoint" section. The waypoint's number appears on the far right side of the screen. This is its number in the waypoint list. All of the waypoints that are saved are added to the waypoint list, no matter how you save them. If the route shown on the list is the way you want it, simply press the ENT key to save it. The GlobalMap 1000 returns to the route menu with your new route at the top of the list.

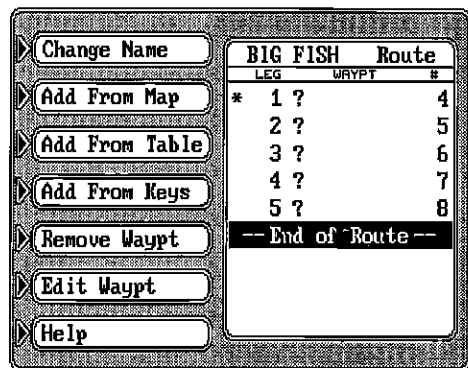

Add From Table

To create a route from the list of waypoints, first name the route as shown on the previous page. You should see the screen at the top of the next page after naming the route. Now press the key next to the "Add From Table" label. The screen shown in the middle of the next page appears.

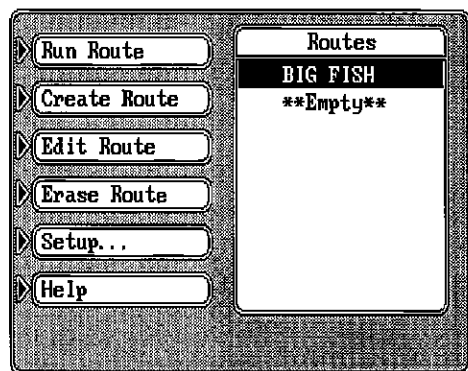

All of the waypoints (including their number, name, and symbol) stored in the GlobalMap 1000 can be viewed on the left side of the screen. The first

have a Starlink model MRB-2A beacon receiver, you don't have to enter the frequency or the bit rate. Simply press the key next to the "Start Starlink Automatic Mode" label and the Starlink receiver will tell the GlobalMap 1000 the transmitter frequency and bit rate, automatically.

When you're finished with this screen, press the CLR key. The GlobalMap should start using the data from the differential beacon receiver. See the "DGPS Beacon Receiver Status" section in this manual for more information.

Initialization - LGC-1 GPS Module

Note: Read this section only if you have a LGC-1 GPS module connected to the GlobalMap 1000. If you are using the NMEA 0183 input for position information, skip this part.

In order for the LGC-1 GPS module to lock onto the satellites, it must first find them. If you simply turn the unit on and wait, the unit will find the satellites by itself in 15 minutes or less. This is called "Cold Start." If you let it find the satellites, the time display will probably be wrong, since it will be showing UTC time or the time at Greenwich, England. However, all other navigation displays, including the position display will be correct. (You can set the time to your local time.) To speed up the satellite acquisition process, you can initialize the LGC-1 or "tell it where it is" the first time it's turned on. This initialization process is usually done only once and requires the following data:

1. Your present position in latitude/longitude.
2. Your elevation above sea level (altitude).
3. Today's date and time.

The unit usually only takes a few minutes or less to find the satellites once it's been initialized by the user.

After the power cable and GPS antenna module are installed, press the ON key, then press the MENU key. Now press the key next to the "I/O and Initialization" label. Finally, press the key next to the "Initial Time and Position" label. The screen shown at right appears next.

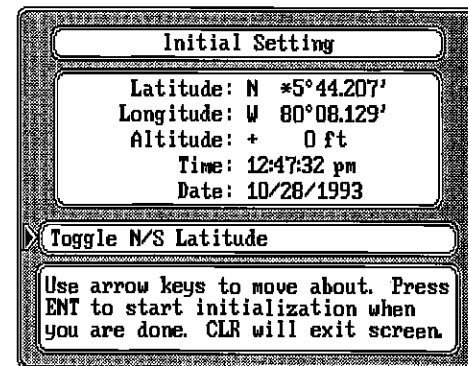

This is the GPS module initialization screen. The settings now in use are shown at the top of the display. The first number in the latitude display should be flashing. If you're using the unit for the first time, these settings are probably wrong for your position and time. To change any of the numbers on this display, simply press the arrow keys to move to the desired

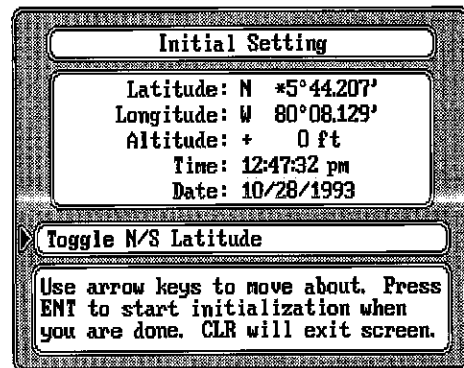

number that you wish to change. For example, to change the latitude to 41° 18.023', first press the 4 key while the "3" in the latitude is flashing. This changes the "3" to a "4". It also moves one digit to the right, making the number "6" start flashing. Now press the 1 key. Continue until all of the numbers in the latitude have changed. If you need to change the latitude from north to south, press the key next to the "Toggle N/S latitude" label in the middle of the screen. When you're finished with the latitude, press the down arrow key once. This moves you to the longitude field. An asterisk (*) flashes in front of the "9" in the longitude. If your longitude is less than 100 degrees, simply press the right arrow key to move to the "9", then enter your present longitude the same way you entered the latitude. If your longitude is over 100 degrees, simply enter your present longitude. The label at the middle of the screen now shows "Toggle E/W Longitude". Press the key next to this label to change the longitude from west to east, if necessary.

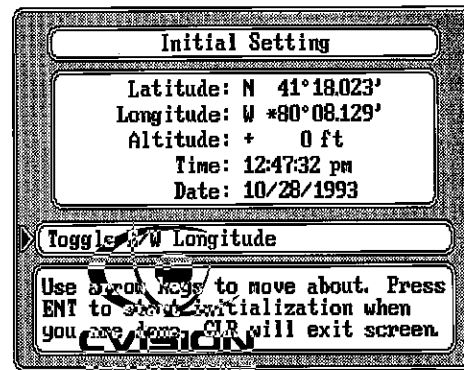

Continue entering your altitude, present time and date the same way you entered your present position. If you make a mistake entering a number, simply move back to the number that you wish to change using the arrow keys, then enter the correct number.

When all of the numbers on the screen have been changed to their correct values for your present position and time, press the "ENT" key. This sends the values you entered to the GPS module which should shorten the time required for it to find the satellites and return your present position. If you

press the right arrow key again. Continue in this manner until the route name has been entered. (Note: To enter a space, press the key next to the "Z," label. The space is the character after the "Z.") When the name appears as you wish, press the ENT key. The screen shown at right appears.

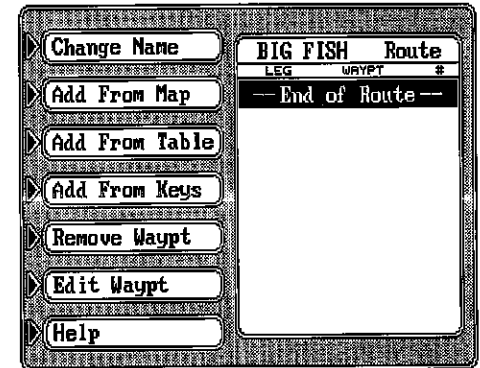

Waypoint Selection

You're now ready to place the waypoints into the route, using any of three different methods. You can place waypoints using the cursor on the map, from the list of waypoints, or enter the latitude/longitude of each waypoint from the keyboard.

IMPORTANT!

You must select waypoints in the order they are to be used in the route. In other words, suppose you want a route that consists of waypoint numbers 1, 3, and 5. However, you wish to travel to 3 first, then 1, and finally 5. In this case, you must select waypoint 3, 1, and 5 in that order when making the route.

Add From Map

To create a route using the cursor on the map, press the key next to the "Add From Map" label. A screen similar to the one at right appears.

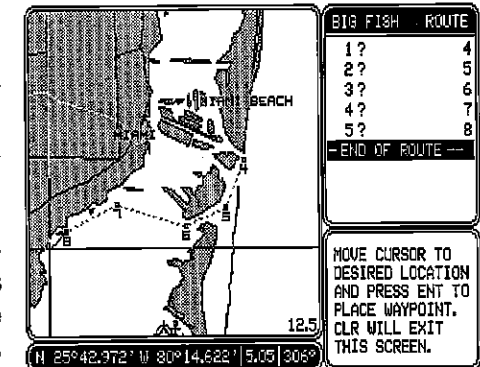

To save the first waypoint location in the route, simply press the arrow keys to move the cursor to the desired location. The latitude/longitude of the cursor shows at the bottom of the screen. When the cursor is at the desired location, press the ENT key. This saves the cursor position as a waypoint. A box appears on the screen with the waypoint's number beneath it. Now move the cursor to the next location on the route. As you move the cursor, a line stretches from the first waypoint to the cursor position. When the cursor is at the desired location, press the ENT key again. A dashed line extends from the first waypoint to the second, showing the first leg of the route. Continue moving the cursor and saving waypoints until all of the

ROUTES

A route gives you the ability to navigate to several waypoints without having to reprogram the unit after arriving at each one. A route consists of two or more waypoints. When you travel on a route, the GlobalMap 1000 shows navigation information to the first waypoint in the route. When you reach the first waypoint, (signalled by the Arrival Alarm), the GlobalMap 1000 automatically sequences to the next waypoint. Navigation information is shown to this waypoint and the process repeats. When you reach the last waypoint in a route, the arrival alarm sounds until you turn it off.

There are four steps required to create and follow a route. First, you must create and name the route. Next, select the waypoints used in the route. Then determine the starting waypoint. Next, tell the unit to follow the route. Finally, the unit will ask you if you wish to run the route forward or backward. After these steps are completed, the GlobalMap 1000 will start showing navigation data to the first waypoint on the route.

The GlobalMap 1000 allows creating a route from the list of waypoints or directly from the map.

CREATING A ROUTE

Name a Route

To create a route, first press the WAYPT/ROUTE key. Next, press the key next to the "Routes" label. The screen shown at right appears.

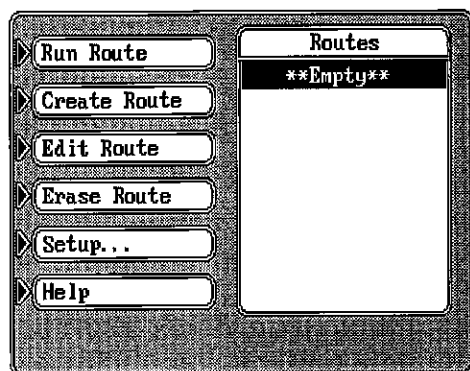

This menu lets you create a route, edit an existing route, run a route, erase it, and set the auto-sequencing and arrival radius. To create the route, press the key next to the "Create Route" label. The screen shown at right appears. This is the "name route" menu. Press a key next to the label that has the desired letter repeatedly until the first letter in the route name appears. Now press the right arrow key once. Select the next letter in the route name, then

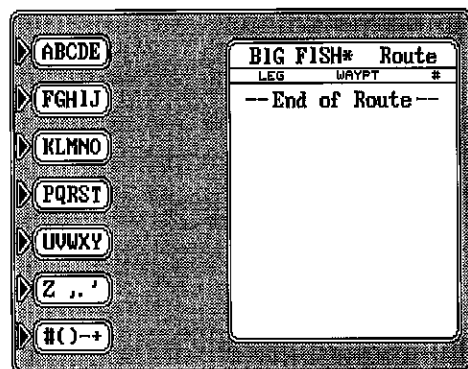

don't move a long distance (over 100 miles) with the unit turned off, then you probably won't need to do the initialization again, since it stores all of the last known position settings in memory each time it's turned off. An internal clock keeps track of the time, even when the unit is turned off, so that it will be correct the next time it's used.

Once the LGC-1 GPS module finds the satellites and displays the correct latitude/longitude for your position, then the GlobalMap 1000 is ready for use.

COLD START

When the GlobalMap 1000 is turned on for the first time "out of the box", it automatically sends a "cold start" message to the Lowrance LGC-1 GPS receiver. You can also send a cold start message to the receiver. If the unit can't lock on to the satellites using the data you've given it, or if it has trouble finding the satellites, perhaps it is using the wrong data. This can happen if you've entered the wrong data by accident. For example, given it east longitude instead of west. Or if you've moved a long distance with the unit turned off.

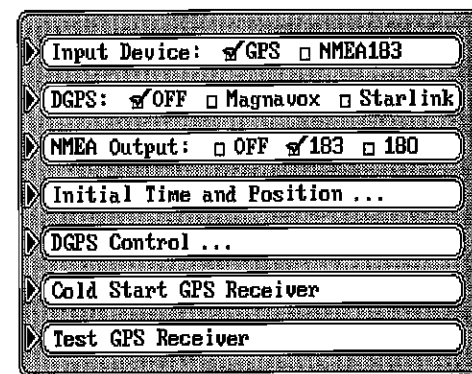

To send a cold start message to the receiver, first press the MENU key. Now press the key next to the "I/O and Initialization" label. Finally, press the key next to the "Cold Start GPS Receiver" label. The unit will begin a cold start technique to find the available satellites. It should lock on to them in 15 minutes or less. Remember, when it does, your local time and possibly date display will probably be wrong. Use the method shown previously to set the time and date to their proper local settings. Once this is done, an internal clock will keep the correct time, even when the unit is turned off. The GPS system updates this clock when the unit is locked on to the satellites.

GPS RECEIVER TEST

If you have the LGC-1 GPS receiver connected to the GlobalMap 1000, a test can be performed on the receiver. This tests many parameters of the receiver, letting you know if there is a malfunction. If the LGC-1 fails any of the tests on the shown on the screen, then contact the Lowrance Factory

Customer Service Department. To activate the receiver test, first press the MENU key, then press the key next to the "I/O and Initialization..." label. Now press the key next to the "Test GPS Receiver" label. The screen shown at right appears. While the GlobalMap 1000 is testing the LGC-1 GPS module, the word "Testing" appears in the box at the top of the screen. This will take several seconds. When the GlobalMap 1000 is finished with the test, the word "PASSED" will appear at the top of the screen if the module passed the test and "FAILED" if the GlobalMap found a problem. The boxes on the screen show the results of each test. These results are coded and will show either "FFFF" or "0000". The version of the software used in the LGC-1 appears at the bottom of the screen.

Test Result	PASSED!
BIT Summary	0000
Low Order RAM	FFFF
High Order RAM	FFFF
Preprocessor Test	0000
Preprocessor RAM	FFFF
Multi Interface	0000
C/C VCO Test	0000
Signal Inj. Test	0000
Software Version	1.00

To exit this screen, press the CLR key.

MAPPING/NAVIGATION/STEERING DISPLAYS

The GlobalMap 1000 has mapping, navigation, steering indicator, and satellite information screens. These displays were designed to show the most important data. However, you can change all of them (except the satellite information screen) to some extent through the "Customize Display" feature on the second GPS menu screen. To change these screens, see the "Customize" section in this manual.

Each of the following screens is available by pressing a key at the bottom of the unit. A detailed description of each screen follows.

IMPORTANT!

If the data shown in digital numbers on any screen on this unit is flashing, then it means that data is invalid. Do not rely on that data if it is flashing. For example, if the present position display is flashing, then the unit has lost the position data from the GPS module or NMEA 0183 data input. The position that is flashing is the last known position, not your present position! Do not navigate with this unit until you have found the reason the unit has lost the position data!

WAYPT/ROUTE key, then press the key next to the "Cancel Navigation" label. The unit returns to the last-used map, navigation, or steering screen.

Erase a Waypoint

To delete a waypoint from the waypoint list, first press the WAYPT/ROUTE key, then press the key next to the "Waypoints" label. The screen shown at right appears. Now move the black box to the waypoint that you wish to erase using the arrow keys. Now simply press the key next to the "Erase Waypt" label. A message appears on the screen that warns you that this waypoint will be permanently erased. If you still wish to erase this waypoint, press the ENT key. The waypoint location will return to "Empty". Press the CLR key to return to the map, steer, or navigation screen.

Waypoints	
#	NAME SYM
1	BIG SCHOOL
2	REEF
3	SMUG COVE
4	Quick Save
5	**Empty**
6	**Empty**
7	**Empty**
8	**Empty**
9	**Empty**

N 25° 39.478' W 80° 10.334' 0.04 Hz 159 ° T

WAYPOINT DISPLAY

There are a number of options available when showing the waypoint location on the map. You can show all waypoints or turn them off, show only the symbols, names, or number, or any combination of these.

Display all Waypoints	<input type="checkbox"/> OFF <input checked="" type="checkbox"/> ON
Waypoint Symbols	<input type="checkbox"/> OFF <input checked="" type="checkbox"/> ON
Waypoint Name	<input checked="" type="checkbox"/> OFF <input type="checkbox"/> ON
Waypoint Number	<input type="checkbox"/> OFF <input checked="" type="checkbox"/> ON
More ...	

To change the waypoint display, first press the MENU key, then press the key next to the "Mapping Setup" label. Now press the key next to the "More..." label. The screen shown above appears. Press the key next to the desired option, then press the CLR key to exit this screen.

The defaults for this screen are: all waypoints on, waypoint symbols on, waypoint names off, and waypoint numbers on.

GlobalMap 1000 returns to the mapping screen. If the waypoint location is within the area shown on the map, a box appears on the map with the waypoint's number beneath it. If a symbol was assigned to the waypoint, the symbol will show on the screen instead of the box.

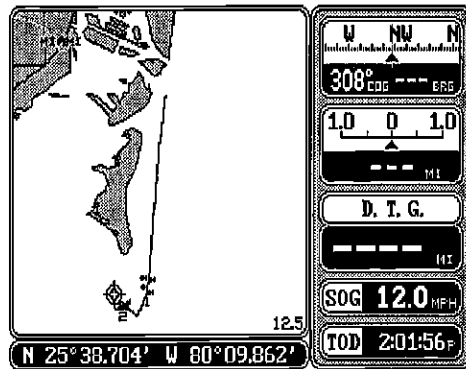

Navigate to a Waypoint

To show navigation data to a waypoint location, first press the WAYPT/ROUTE key, then press the key next to the "Waypoints" label. The screen shown below appears. Select the waypoint by pressing the up or down arrow keys until the desired waypoint is highlighted by the black box. The waypoint's position, distance from your present position, and bearing from your position to the waypoint show at the bottom of the screen. Now simply press the key next to the "Go To Waypt" label. The GlobalMap 1000 returns to the mapping screen. It draws a "S" with a box around it showing your position when you recalled the waypoint. (see below.) A dotted line extends from this box to the recalled waypoint. This line is the shortest path to the waypoint. If you steer the boat along this line, you'll travel directly to the recalled waypoint. Navigation data also appears in all digital displays which show your course over ground (COG), speed over ground (SOG), distance to waypoint (DTG) and much more. Switch to the navigation or steering screens for more navigation information.

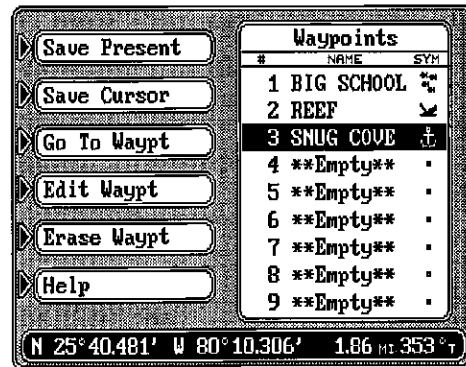

As you travel, the circle showing your present position moves on the screen, too. A line extends from the circle showing the path you've taken.

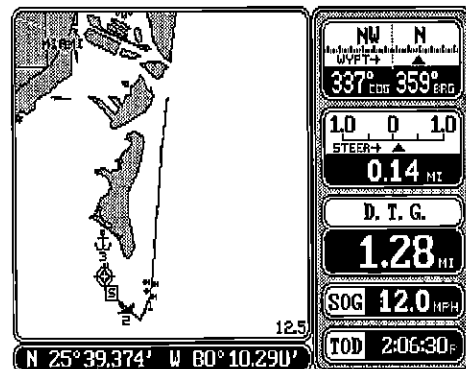

Cancel Navigation

To stop the GlobalMap 1000 from showing navigation data to a waypoint, first press the

MAP SCREEN

The Map screen automatically appears the first time the GlobalMap 1000 is turned on. You can also view this screen at any time by pressing the MAP key. A screen similar to the one at right appears. Your present position appears as a circle with a cross on the screen. The latitude/longitude of your present position shows at the bottom of the screen.

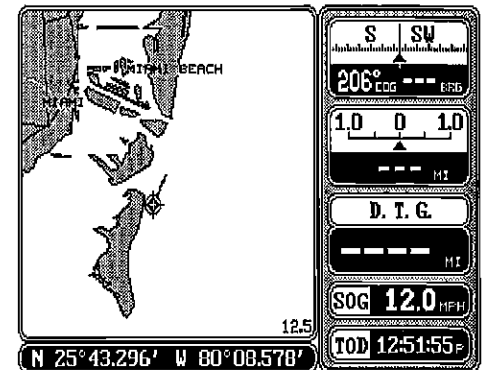

Each time you switch to this screen, the GlobalMap centers your present position and the map on the display. To zoom in for a closer look, press the ZOOM IN key in the upper left corner. To zoom out and see a wider area around your present position, press the ZOOM OUT key. The range, or approximate distance from one side of the screen to the other is shown in the lower right corner of the map. Each time you press the ZOOM IN or ZOOM OUT key, the range changes, typically showing you more detail when you're zoomed in or a wider area when you've zoomed out.

As you travel, the circle showing your present position moves on the screen, too. A line extends from the circle showing the path you've taken.

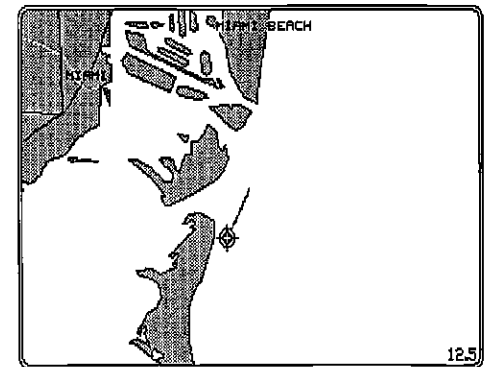

Pressing the MAP key while the map is displayed causes the whole display to be used by the map as shown below. The digital boxes disappear. Press the MAP key again to return to the original mapping display.

Boxes on the right side of the screen shown at the top of this page show your course over ground (COG), or direction you're heading, boat speed (SOG), present time (TOD or Time Of Day), and navigation information if you recall a waypoint. All of the boxes on the right side of the screen can be replaced with others. In this manner you can customize the screen to your needs.

See the Customization section for a detailed description of the boxes not shown on this screen.

To center the map around your present position, placing it in the middle of the screen, simply press the CENTER key.

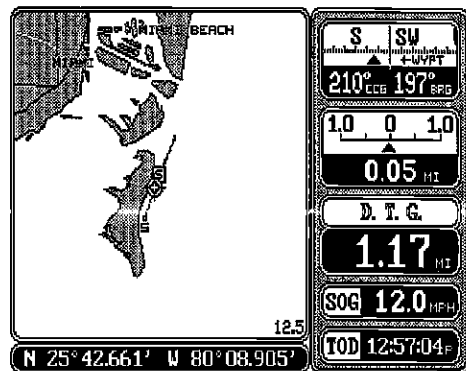

The box in the upper right corner of the screen is a combination navigation display. A compass shows your current course over ground at the top of the box. This is the direction you're travelling. Your course over ground (COG) is also shown in digital numbers in the bottom left corner of this box. The course over ground in this example is 210 degrees.

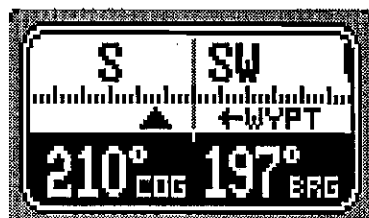

When a waypoint is recalled (see the waypoint navigation section), the direction to the waypoint, or bearing, is shown in the bottom right corner of this box (BRG).

The arrow that points up always shows in the middle of this box. This arrow points to the bearing of the recalled waypoint on the compass. In this example, the bearing is 197 degrees. If you steer the boat so that the arrow that points up is always in line with your course over ground, then you'll always steer the shortest, most direct route to the waypoint.

If you move to the left or right of the optimum course to the waypoint, another arrow appears on the display with the letters "WYPT". This arrow points in the direction you should steer the boat to get back on course. In the example shown above, you need to steer the boat to the left to get back on course.

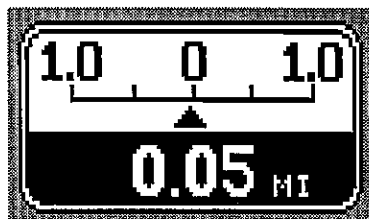

The box shown beneath the compass box is a course deviation indicator, or C.D.I. This box has a pointer that moves to the left or right, depending if you are left or right of the optimum course line. The pointer represents the course line. For example, if you are one-half of a mile to the left of the desired

press the right arrow key once to move to the next location. Press the ZOOM IN key until the "E" appears. Continue in this manner until the waypoint name is completed.

Waypoint Symbols

If you want a symbol placed on the map, press the down arrow key to the "Symbol" location on the waypoint screen. The letters on the left side of the screen disappear and symbols appear in the labels. (see below) Press the key next to the desired symbol to assign it to the waypoint number shown at the top of the screen. There are 28 different symbols available.

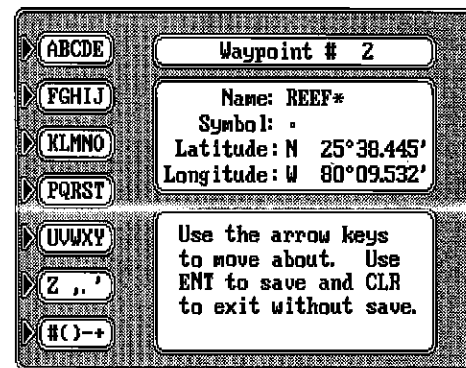

Enter Latitude/Longitude

If there is no latitude/longitude position showing, or if you wish to change the position shown on the waypoint screen, press the down arrow key until the first number starts flashing in the latitude field. Now enter the desired latitude. If you need to change the latitude from north to south, press the key next to the "S" label. After you've made the desired changes to the latitude, press the down arrow key to move to the longitude. Now enter the new longitude. Press the key next to the "E" or "W" if you need to change the longitude from west to east or vice-versa. Anytime you make a mistake entering a number, simply press the left or right arrow keys to move to the number you wish to change, then enter the correct one.

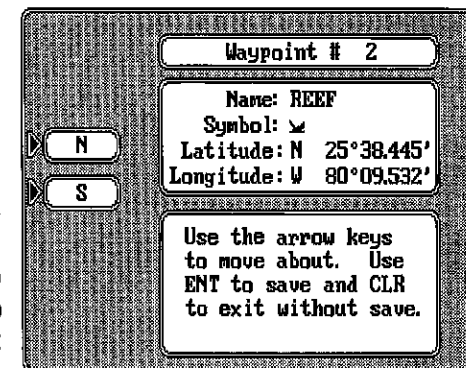
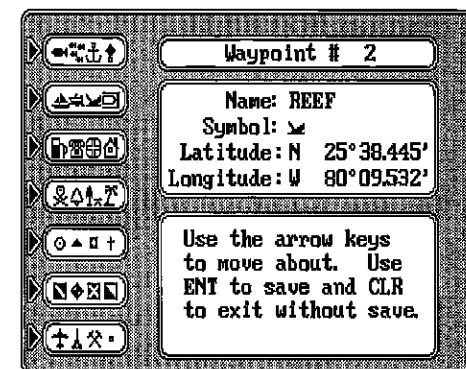

Once everything on this screen is correct, press the ENT key. The

The list of waypoints shows on the right side of the screen. The first waypoint number in the list appears at the top of the page. It's highlighted by a black box. This is the number that the position will be stored under. To switch to a different number, simply press the down arrow key. If the waypoint says "Empty", then you can store a position there. A row of menu labels appear on the left side of the screen. Pressing a key next to these labels let you save your present position, the cursor position, select a waypoint destination, edit the waypoint elements, and erase a waypoint from the list. The steps required to save a waypoint, either your present position, cursor position, or any other position are the same.

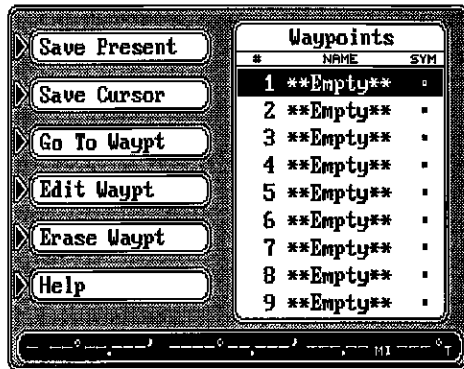

To save a waypoint, first move the black box to the waypoint number you wish to save the location in by using the up or down cursor keys. Now simply press the key next to the "Save Present" label to save your present position. To save the position at the cursor cross marks, press the key next to the "Save Cursor". If you wish to enter a location other than these, press the key next to the "Edit Waypt" label. You can also change anything on an existing saved waypoint by using the "Edit Waypt" label.

Editing a Waypoint

After you've pressed the key next to the "Save Present", "Save Cursor", or "Edit Waypt" labels, a new screen appears as shown below. The position at the time you pressed the "Save Present" or "Save Cursor" label is shown in the box in the middle of the screen. (No position shows if you pressed the "Edit Waypt" key on an empty waypoint.) The waypoint number you are currently editing shows at the top of the screen. A question mark flashes in the "Name" field. If you wish to name this waypoint, enter the letters of the name using the keys on the left side of the screen. For example, to enter the name "REEF", first press the CURSOR key until the letter "R" appears. Now

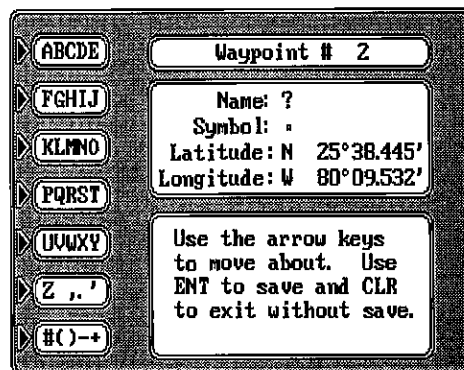

course, the pointer will move to the right, and an arrow pointing to the right appears with the word "STEER" next to it. This means you need to steer to the right to get back on the correct course. The distance from your present position to the course line appears at the bottom of this box. This is called "cross track error". In this example, the cross track error is 0.05 miles.

Beneath the C.D.I. indicator are the distance to go (DTG), speed over ground (SOG), and time of day (TOD) boxes.

Using these displays along with the mapping display makes it easy to precisely steer a course to a recalled waypoint or cursor position.

MAPPING OPTIONS

The map screen has a number of choices available that let you optimize this screen for your own particular boating or navigation situations. To change the mapping display, first press the MENU key, then press the key next to the "Mapping Setup..." label. A screen similar to the one at right appears.

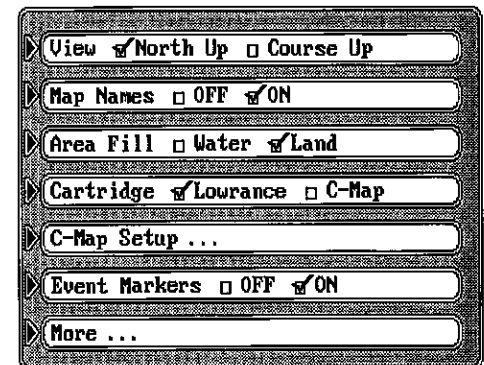

North Up - Course Up

The GlobalMap 1000 can display the map in the conventional "north-up" presentation when it's first turned on or after a preset. This means north is always at the top of the screen. If you're using the Lowrance background map built into the GlobalMap 1000 or a Lowrance cartridge, you can change to the "course-up" orientation. In this mode, the map rotates as you change directions. It always keeps your trail moving straight towards the top of the screen, no matter what your actual heading is.

For example, in the traditional "north-up" mode as shown at right, no matter which way you turn, north is always at the top of the display. If you're travelling due south, a turn to the left (east) will look like a turn to the right on the display. However, with a "north-up" display, your

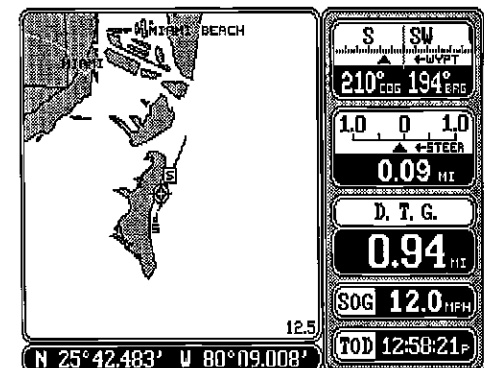

course line is always straight up, and the map rotates around your present position. Although this may look confusing at first, it actually makes reading the map easier. For example, if you're travelling due east, features on the map should match your view outside: an inlet on your left will be shown on the left on the map, an island on your right will show on the right on the map, etc.

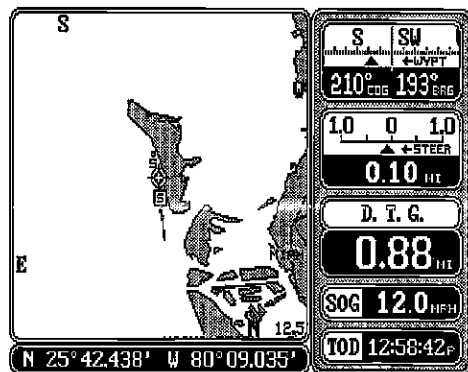

To change from the north-up to the course-up mode, simply press the MENU key, then press the key next to the "Mapping Setup..." label. Now press the key next to the "View North Up Course Up" label. This switches the check mark to the "Course Up" box. Press the CLR key to return to the map screen. To switch back to the north-up view, simply repeat the above steps.

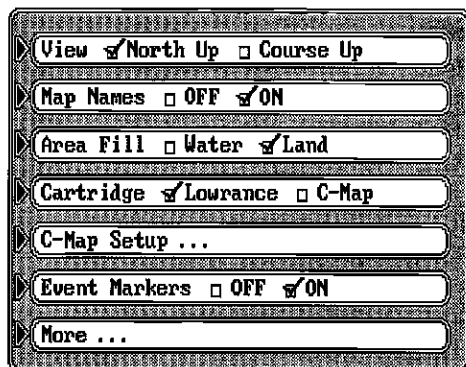

Map Names

Major cities, highways, rivers, lakes, states, and more are shown on the Lowrance background map and Lowrance cartridges. (C-Map™ cartridges and background map also show the names of many of these landmarks, but can't be turned off.) When the GlobalMap is first turned on or after it's preset, these names are shown on the map. To turn the names off, press the MENU key, then press the key next to the "Mapping Setup..." label. Now press the key next to the "Map Names" label. This moves the check mark from the "ON" to the "OFF" box. Press the CLR key to return to the map screen.

Area Fill

The GlobalMap 1000 gives you the option of filling land masses or water with a gray background. The land mass is gray when the unit is first turned on or after a preset. To fill the water with gray and leave the land white, press the MENU key, then press the key next to the "Mapping Setup" label. Now press the key next to the "Area Fill" label to move the check mark from "Land" to "Water". Now press the CLR key. The unit returns to the map screen with the water filled with gray.

WAYPOINT NAVIGATION

HOW TO SAVE A WAYPOINT

Waypoints are locations on the earth's surface that you wish to go or return to. Waypoints are useful for marking shipwrecks, hot fishing spots, buoys, and other fishing or navigation locations. Storing waypoints in the GlobalMap 1000's memory makes it easy to return to any point in the world by simply pressing a few buttons. The GlobalMap 1000 can store up to 250 waypoints. You can store your present position or the cursor position as a waypoint or enter latitude/longitude positions as waypoints.

(Quick Save Feature)

The GlobalMap 1000 lets you save your present position as a waypoint with only one key press. This "Quick Save" feature lets you easily save the position of a wreck or other locations.

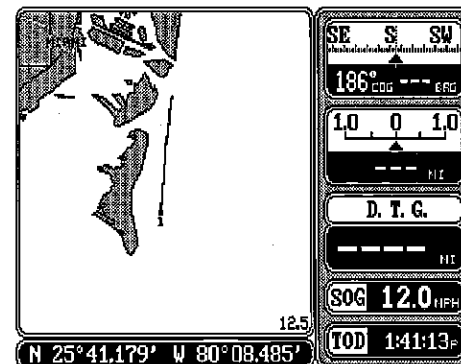

To save your present position as a waypoint, simply press the WAYPT QUICKSAVE key. The GlobalMap 1000 takes your present position and assigns the first available waypoint number to it. (see above.) It displays the waypoint on the map and stores the position in the waypoint list. See the view and same method below for more information on storing waypoints.

Waypoint Save - View and Save Method

The "Quick Save" feature doesn't let you select the waypoint number. You have to use the next available number when using that method, plus you can only save your present position. The View and Save method gives you far more options. (Note: You can store a position under a waypoint number that already has a position assigned to it using this method.) To save a location as a waypoint, first press the WAYPT/ROUTE key. A screen similar to the one at right appears. Now press the key next to the "Waypoints" label. The screen shown at the top of the next page appears.

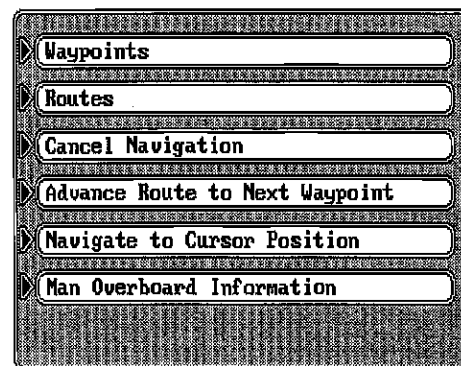

to choose from. Pressing the MENU key changes to the next page.) Once the arrow is pointing to the desired box, press the ENT key. This returns the GlobalMap 1000 to the screen you're changing (in this example, it's the navigation screen), and places the new box on the screen. Compare the navigation screen on the previous page with the one below right.

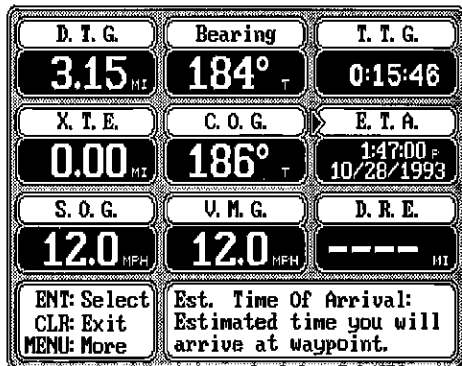

To change another box, simply repeat the above steps. When you're finished customizing the screen, simply press the CLR screen. This erases the arrow from the display and locks in your changes. These changes are held in memory and are saved even if power is turned off.

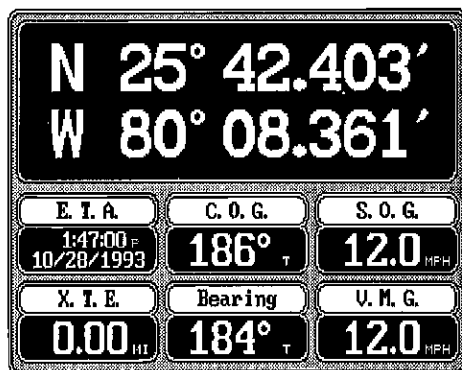

NAVIGATION SCREEN

Since the Navigation and Steering screens have two different sets of digital boxes available, you can customize each set with different digital boxes, then switch between the screens by simply pressing the appropriate key. For example, customize the navigation screen with one set of digital boxes as shown above. While the navigation screen is showing, press the NAV key. This shows a different set of digital boxes which can also be customized as shown at right.

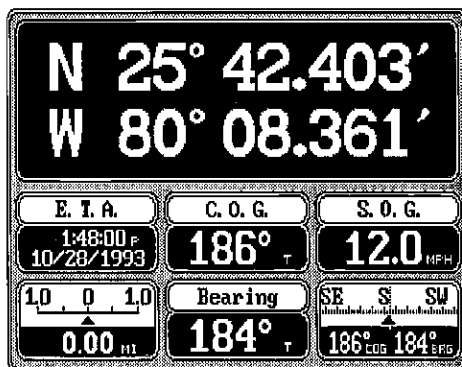

NAVIGATION SCREEN

Cartridge Switch

The GlobalMap 1000 can use either Lowrance or C-Map™ cartridges. If you wish to use the C-Map cartridge, you'll need to purchase the Lowrance MapLink cartridge reader. The GlobalMap 1000 has a Lowrance map of the world built into it. This is called the "background" map. C-Map uses their own background map which is built into the MapLink cartridge reader. Information from a C-Map cartridge can't be displayed while the Lowrance background map is showing and vice-versa. You must use the C-Map background with a C-Map cartridge and the Lowrance background map with the Lowrance cartridge. The default setting for the GlobalMap 1000 is the Lowrance background map and cartridge.

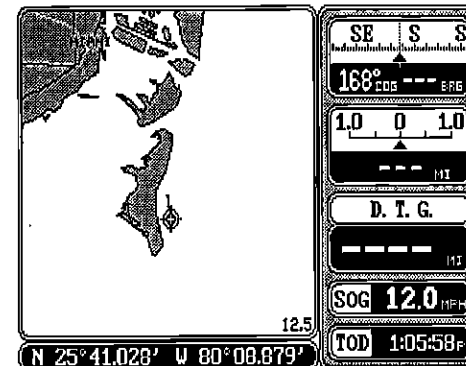

LOWRANCE BACKGROUND MAP

To switch between the Lowrance and C-Map maps, press the MENU key, then press the key next to the "Mapping Setup..." label. Now press the key next to the "Cartridge Lowrance C-Map" label. A message appears, warning you that your trail will be erased. This happens each time you switch mapping systems. Press the ENT key to proceed or press the CLR key to quit. If you pressed the ENT key, the C-Map background map should now be displayed. If you have a C-Map cartridge plugged into the MapLink, a box will appear on the map in the area covered by the cartridge. This area lets you "zoom-in" much closer than the standard background map, typically allowing much more detail to be shown. Note: It is normal for zooming in or out with C-Map to be much slower than with the Lowrance maps. To switch back to the Lowrance map, repeat the above steps.

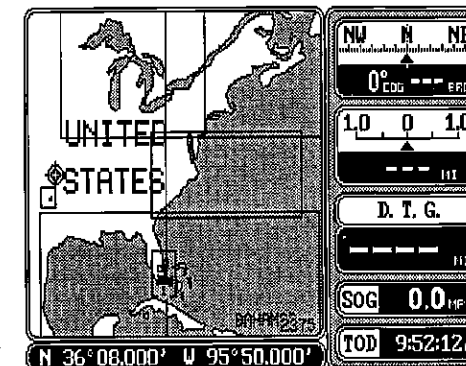

C-MAP™ BACKGROUND MAP

C-Map Setup

There are several options available to you if you're using the C-Map system. C-Map gives you the capability to turn off or on the map boundaries, navigation aids, coastal features, restricted areas, and depth lines.

To change any of these features, press the MENU key, then press the key next to the "Mapping Setup..." label. Now press the key next to the "C-Map Setup..." label. This screen shown above appears. Simply press the key next to the label of the feature you wish to change. When you're finished, press the CLR key to return to the map screen or press the key next to the "More" label to return to the mapping setup menu.

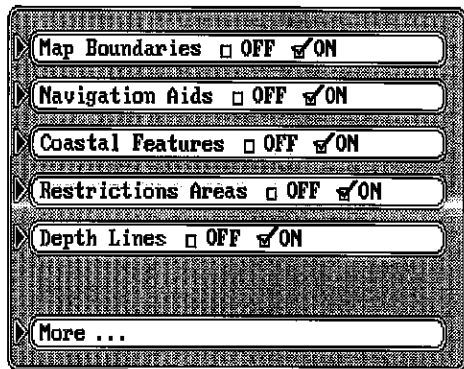

CURSOR

The GlobalMap 1000 has moveable cursor lines that let you pinpoint locations on the map, create waypoints, routes, and more.

There are two ways to activate the cursor lines. The first is to press the CURSOR key. The second is to simply press any arrow key while the map is displayed. Either way, you'll see a screen similar to the one above. When first turned on, the cursor lines intersect your present position on the screen. The latitude/longitude box at the bottom of the screen changes from your present position to the position of the cursor lines on the screen at the same time. The distance and bearing from the cursor lines to your present position show next to the position at the bottom of the screen.

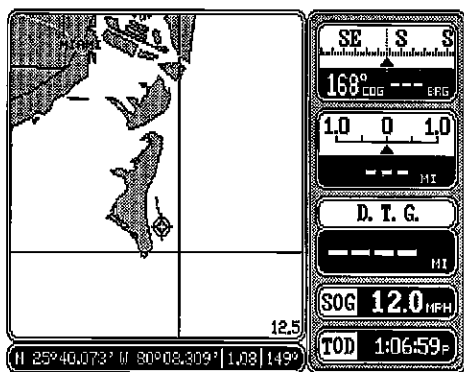

To move the cursor lines anywhere on the screen, simply press the arrow keys. You can press two keys at the same time to move the cursor lines diagonally. In the screen shown above, the cursor lines are 1.08 miles and 149 degrees from the present position.

If you press the CENTER key while the cursor lines are displayed, the unit will center the map at the position of the cursor lines - not the present position.

If you want the GlobalMap 1000 to show navigation information to the cursor lines, first move the cursor lines to the desired location, then press

The status of the DGPS receiver shows at the top of the screen. Beneath the status are the station identification (ID), station frequency (Freq), station transmission rate (Rate), signal strength (Sig), signal-to-noise ratio (SNR), and station health (Hlth).

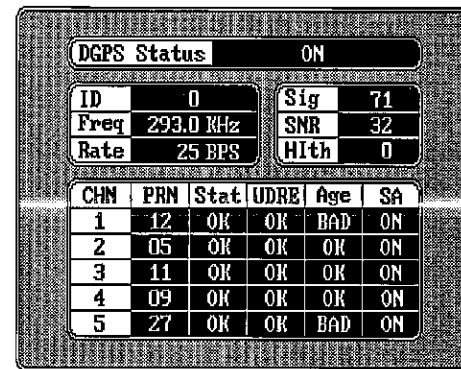

At the bottom of the screen are the statistics for the GPS receiver's five channels. This includes the satellite number (PRN), its status (STAT), the User Differential Range Error (UDRE), Age status (Age), and if Selective Availability (SA) is on for each satellite. The UDRE is the range error from your position to the satellite. If there is an "OK" in this field, then the range error to that satellite is 8 meters or less 68 percent of the time.

CUSTOMIZE SCREENS

The digital displays on the mapping, navigation, and steering screens, plus the displays on the Plotter screen can be changed as desired. To show how this is done, we'll use the Navigation screen as an example.

To customize the Navigation screen, first make certain it is showing by pressing the NAV key. Next, press the MENU key two times. Now press the key next to the "Customize Display" label at the top of the screen. The unit returns to the Navigation Screen with an arrow pointing to the top left hand corner box as shown at right. In this case, the arrow is pointing to the D.T.G. box. The arrow identifies the box as "ready for change." To move the arrow to a different box, simply press the arrow keys until it's pointing to the desired box. In this example, we'll change the distance to go (DTG) to the estimated time of arrival (ETA) display. With the arrow pointing to the "DTG" box, press the ENT key. The screen shown at the top of the next page appears. Using the arrow keys, move the arrow to the "E.T.A." box. (If the digital box you want is not on this screen, press the MENU key until you see it. There are four pages of different digital boxes

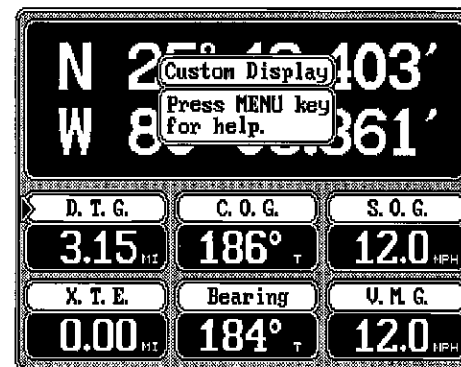

Beneath the date display is the GPS status display. This tells you if the unit is in the 2D mode (position only), 3D mode (position and altitude), or if DGPS is operational.

Position	N 36° 09.498'	W 96° 17.965'	Fix	9
Altitude	375 FT		GDOP	2.08
Time	12:41:37 PM		HDOP	1.17
Date	7/09/1993		VDOP	1.54
Status	3D Navigation		PDOP	1.94
			TDOP	0.75

CHN	PRN	TRK	ELV	AZM	SNR	Sat. In View
1	24	T	9°	205°	34	7, 2, 13,
2	14	T	13°	86°	38	27, 14, 12,
3	15	T	9°	38°	37	15, 24, 26
4	7	T	70°	340°	42	
5	12	T	10°	328°	35	

The Fix status and "DOPS" show in the upper right portion of the display. The fix quality has a range from 0-9. 9 is the best, 0 the worst. As the fix number decreases, the position's "jitter" increases. Jitter is the small position changes your present position symbol makes when you're not moving. This movement is normal and happens in all electronic navigation equipment. Beneath the fix display are the "DOPS" - GDOP (Geometric), HDOP (Horizontal), VDOP (Vertical), PDOP (Position), and TDOP (Time). DOP stands for "Dilution Of Precision". The smaller the number in these fields, the better. In other words, the smaller numbers mean the GlobalMap1000 is showing more accurate data than when large numbers are showing.

The satellites that are in view of the receiver in the bottom right corner of the screen. The LGC-1 GPS receiver will track all of the satellites in view. Using a five channel GPS receiver, it will use up to four satellites to calculate position. The fifth channel tracks the remaining satellites. Data on each channel from the LGC-1 is shown at the bottom left corner of the display. The channels are numbered one through five on the left side of the screen. Every satellite in the constellation has a number assigned to it, called the PRN. The PRN is the first number in the channel's row. TRK stands for "track." If the GlobalMap 1000 is tracking the satellite, then a "T" is placed in this column. If the GlobalMap 1000 is searching for the satellite, then a "S" appears. ELV is the elevation (height) of the satellite above the horizon from your position. AZM is the azimuth or direction of the satellite from your position. For example, if the azimuth of a satellite is 180 degrees, then it is due south. SNR is the signal-to-noise ratio. This tells you how strong the satellite's signal is. The higher the SNR number, the better.

DGPS BEACON RECEIVER STATUS

If you have a Lowrance LGC-1 GPS module and a DGPS beacon receiver connected to the GlobalMap 1000, then you can view the DGPS receiver status by pressing the POSITION key twice. A screen similar to the one at the top of the next page appears.

the WAYPT/ROUTE key. Now press the key next to the "Navigate to Cursor Position" label. The GlobalMap returns to the mapping screen with navigation data showing in the digital boxes. A dotted line appears on the map from your present position to the cursor, showing the shortest, most direct line to the cursor position. A box with the letter "S" appears at the location you were in when you pressed the "Navigate to Cursor Position" label. The cursor position is marked by a small box and the letters "XX" which remain on the screen, even if you turn the cursor lines off. For more information, see the waypoint navigation section.

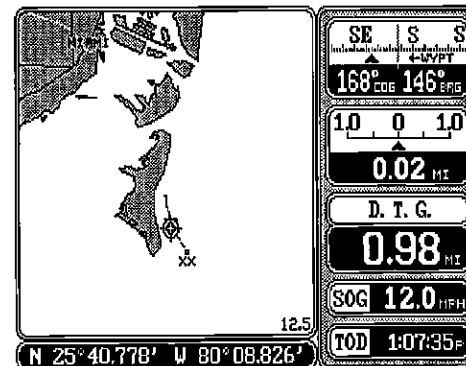

To turn the cursor lines off, simply press the CURSOR key.

TRAIL PLOTTER

Your present position marker leaves a line or "trail" behind as it moves across the map, according to the boat's movement. This makes it easy to determine the path you've taken. There are several ways you can customize the trail plotter. To do so, first press the MENU key. Now press the key next to the "Trail Plotter" label. The screen shown at the top of the next page appears. There are seven menu selections on this screen, all of which relate to the trail plotter. After you've made a selection on this screen, press the CLR key to exit.

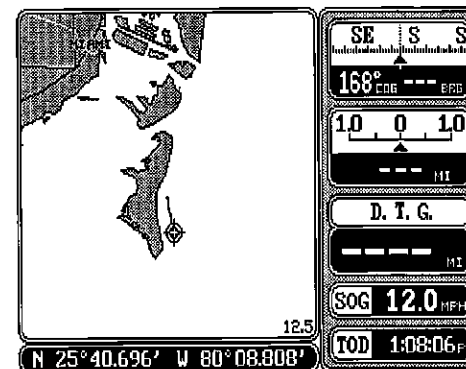

The first item at the top of the screen is "Clear Trail." This erases the plot trail from the screen. This is only temporary, the GlobalMap 1000 will continue to draw your trail from the location it was in when the key next to the "Clear Trail" label was pressed.

If you wish to change the plot trail from a solid line to a dotted one, or a solid one that flashes about once every two seconds, then press the key next to the "Trail Type" label until the check mark is on the desired box.

To stop the GlobalMap 1000 from drawing the plot trail, press the key next to the "Trail Recording" label. The GlobalMap 1000 not only will stop drawing the plot trail, but also will not keep track of it in memory. If you wish to temporarily stop the plot trail, but wish to resume its display at a later time, showing the path you've taken, then press the key next to the "Trail Display" label. This turns the plot trail off, but the GlobalMap keeps it in memory. If you turn the trail display on again, it will show your entire plot trail (if there's enough memory.)

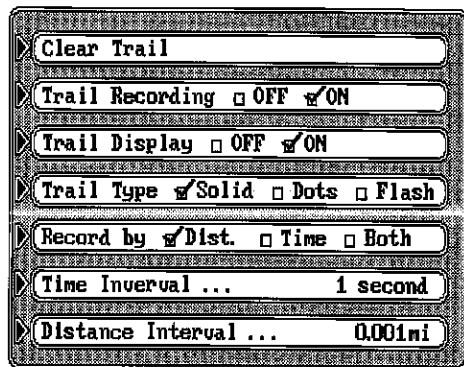

The GlobalMap 1000 has a certain amount of memory reserved for the plot trail. If it runs out of memory, then it will continue to draw the plot trail, but for every dot it places at the end of the trail, it will erase one at the beginning. When the unit is turned on for the first time, the unit's plot trail settings are optimized for the typical user. The trail is recorded by the distance travelled, which is preset to draw one dot every 0.001 mile. In other words, every time you move .001 mile, the unit places a dot on the trail behind your present position. The distance can be changed from 0.001 to 10 miles by pressing the key next to the "Distance Interval" menu. The number at the far right of that label shows the distance interval currently in use. Once you press the key next to that label, a new menu appears. Press the key next to the desired distance interval. The unit returns to the Trail Plotter menu.

If you wish to update the plot trail based on time instead of distance, press the key next to the "Record by" label to move the check mark from "Dist." (distance) to "Time". The default time update is one second. The GlobalMap 1000 will place a dot on the trail once every second, regardless of distance travelled. This update time is changeable from one second to 30 minutes by pressing the key next to the "Time Interval" label. The time shown in this label shows the interval currently selected. Once you press the key next to that label, a new menu appears with the time selections. Press the key next to the desired time. The unit returns to the Trail Plotter menu.

The GlobalMap 1000 can also update the plot trail using both distance and time. For example, if the time interval is one second and the distance is one-tenth mile, it will place a dot on the trail every second and every tenth-mile travelled.

C.D.I. Range

To change the C.D.I. range, press the MENU key, then press the key next to the "Steering Range" label. The screen shown at right appears. Now press the key next to the desired distance. The GlobalMap returns to the steering display with the new C.D.I. range in use.

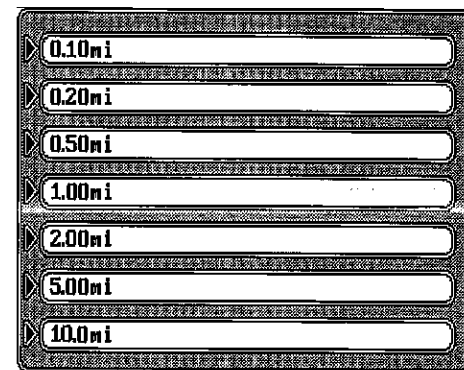

A faster way to change the C.D.I. range is to simply press the ZOOM IN or ZOOM OUT keys while the steer screen is displayed. Each time you press one of these keys, the C.D.I. range increases or decreases, depending on which key you press.

To clear the plot trail on the steering screen, simply press the CLR key.

Pressing the STEER key at the bottom of the unit while the steering screen is displayed changes all of the boxes shown at the top of the display. Again, all of these displays can be changed or rearranged by the user in virtually any combination.

SATELLITE INFORMATION/DGPS SCREENS

Note: These screens will have only partial or no data if the GlobalMap 1000 is receiving its data from another navigation receiver through the NMEA 0183 input. You must have a Lowrance LGC-1 GPS receiver connected to the GlobalMap 1000 in order to fully use the satellite information screen.

The satellite information screen shows technical data about each satellite in view. This includes data from all five channels of the LGC-1 GPS receiver which shows the location of each satellite in the sky, its identification number and more. To see this display, press the POSITION key. A screen similar to the one at right of the next page appears.

Position	N 36°09.498' W 96°17.965'	Fix	9			
Altitude	375 FT	GDOP	2.08			
Time	12:41:37 PM	HDOP	1.17			
Date	7/09/1993	VDOP	1.54			
Status	3D Navigation	PDOP	1.94			
		TDOP	0.75			
CHN	PRN	TRK	ELV	AZM	SNR	Sat. In View
1	24	T	9°	205°	34	7, 2, 13, 27, 14, 12, 15, 24, 26
2	14	T	13°	86°	38	
3	15	T	9°	38°	37	
4	7	T	70°	340°	42	
5	12	T	10°	328°	35	

Your present position, altitude, time, and date are shown in the upper left corner of the display.

STEERING SCREEN

The steering screen shows a pictorial view of your boat and course travelled. This is called a Course Deviation Indicator or C.D.I. It also shows Distance To Go (DTG), Course Over Ground (COG), Speed Over Ground (SOG), Bearing to Waypoint (Bearing), Cross Track Error (XTE), and Velocity Made Good (VMG). All of the digital boxes on this screen are customizable. Press the STEER key to view this screen.

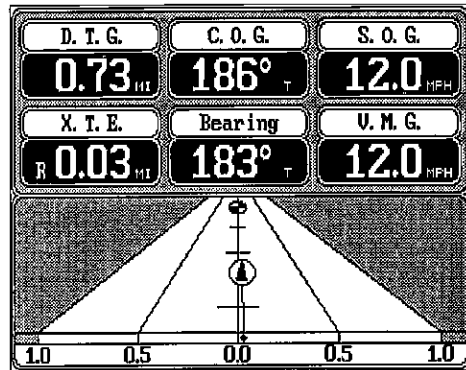

Your present position is shown by the arrow. The arrow shows the direction the boat is heading relative to the waypoint. In theory, if you steer the boat with the arrow always pointing towards the waypoint, then you will arrive at the waypoint. The solid line extending from the arrow is your track or path you've taken. To travel directly to a waypoint, try to keep the arrow on the center line. The waypoint is depicted by a circle at the top of the CDI display. As you approach the waypoint, the arrow and the box will move closer together. If you travel past the waypoint, the waypoint's box will move to the bottom of the display. Using the digital displays at the bottom of the screen with the graphical display at the top let you accurately steer the boat to a waypoint.

The numbers immediately below the C.D.I. are the C.D.I. range in miles. This gives you an idea of how far off course you are. For example, if the arrow is halfway between the course line and the outside left line and the C.D.I. range is 0.5 miles, then your cross track error is to the left 0.25 miles. The C.D.I. range can be changed from .1 miles to 10 miles.

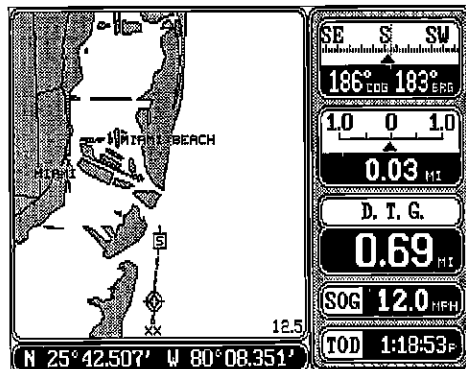

Compare the map screen shown above with the steering screen at the top of this page. The picture of the steer screen and the map screen were taken at the same time. You can see the cross track error, track, distance to waypoint, and the direction you need to steer to the waypoint easily.

EVENT MARKER

The GlobalMap 1000 can place event markers or "icons" on the plotter to mark fishing spots, shallow water, or other special locations. There are five different icons to choose from. You can place up to 1000 event markers, total. You can erase a single icon or all that you can see on the screen at one time.

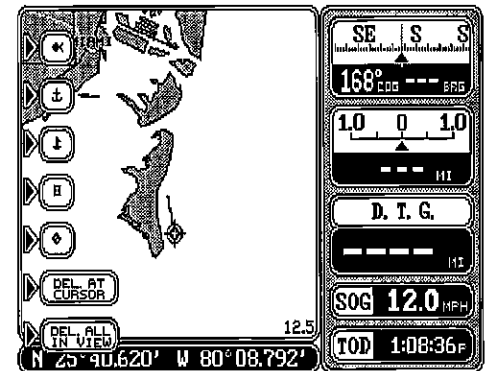

To place an icon, first press the EVENT MARKER key. The screen shown above appears.

Now select one of the five markers shown on the left side of the screen by pressing the key next to the desired marker. As soon as you press the key, the GlobalMap 1000 places the marker at your present position. This marker always stays in this location. It's saved in memory so it will always show on the display, even if the unit is turned off and on again.

Note: When you place an event marker, first make certain the event markers are on. When the GlobalMap is first turned on or after a preset, the markers are automatically turned on. However, if you turn them off (using the "Event Markers On/Off" label on the first "Mapping Setup" menu screen), then the markers won't show when you place them. The unit will place the marker each time you press the key next to the desired marker's label, however it won't show until you turn the event markers on.

Using the Event Marker with the Cursor

Normally, when you select a marker, it's placed on the map at your present position. However, you can place a marker anywhere on the map using the cursor. To do this, first press one of the arrow keys. This makes the map's cursor lines appear on the display. Now move the lines to the desired position on the display by pressing the arrow keys. When it's at the desired location, press the EVENT MARKER key, then select an

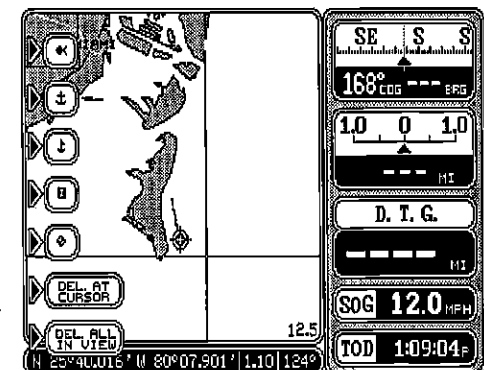

event marker. The GlobalMap 1000 places the marker at the intersection of the cursor lines. To erase the cursor lines, press the CURSOR key.

Erasing the Icons

You can erase event markers one at a time or all of the markers that you can see on the screen with one key press.

To erase one event marker, press the EVENT MARKER key, then move the cursor to the icon that you wish to erase as shown on the screen at right. Now press the key next to the "DEL AT CURSOR" label. This erases the event marker from the screen. The event marker labels automatically clear from the screen. Press the CURSOR key to erase the cursor lines.

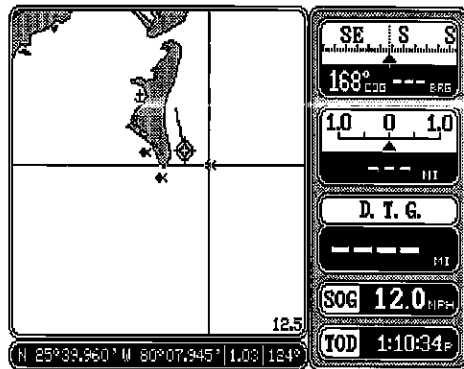

To erase all of the event markers from the screen, first cursor to the area that has the event markers that you wish to erase. Of course, if the event markers are in the area of your present position, then you don't need to use the cursor. If necessary, zoom in or zoom out until all of the event markers that you want to erase are shown on the display. Remember, using this function will erase all of the event markers that are visible on the screen, so if there are event markers showing that you don't want to erase, use the cursor or zoom function to move them off the screen. Once you have the desired event markers showing that you wish to erase, press the EVENT MARKER key, then press the key next to the "DEL ALL IN VIEW" label. A message

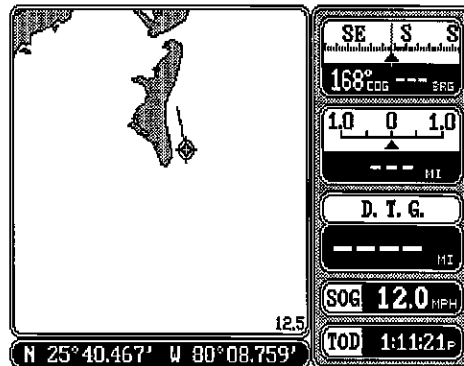
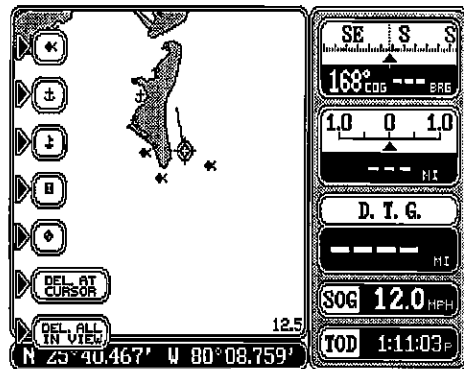

appears, warning you that this will erase all of the event markers that are in view. If you want to erase them, press the ENT key. If not, press the CLR key. If you pressed the ENT key, the GlobalMap 1000 erases all of the event markers from the screen.

NAVIGATION SCREEN

The navigation screen shows all data in digital numbers. You can view this screen at any time by pressing the NAV key. The navigation display shows your present position in large numbers at the top of the screen and Speed Over Ground (SOG), Course Over Ground (COG), Distance To Go (DTG) to waypoint, Bearing to waypoint, and velocity made good (VMG) beneath the present position.

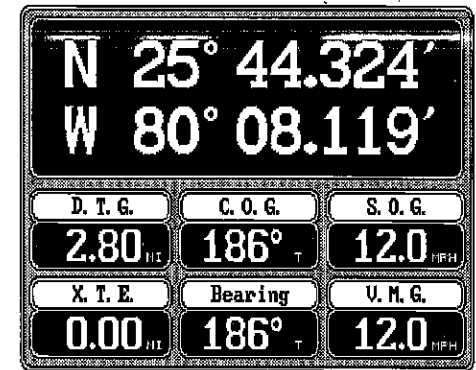

Your present position shows at the top of the screen in latitude/longitude coordinates. This is shown in degrees, minutes, and thousandths of a minute. For example, on this page, the present position is 25 degrees, 44.324 minutes latitude and 80 degrees, 08.119 minutes longitude.

Please note that you must recall a waypoint to use the Bearing, Distance To Go, and Velocity Made Good displays. See the Waypoint Navigation section for information on recalling a waypoint.

For example, a waypoint was recalled on the map screen at right. The navigation screen at the top of the page shows all of the navigation data from our present position on the map.

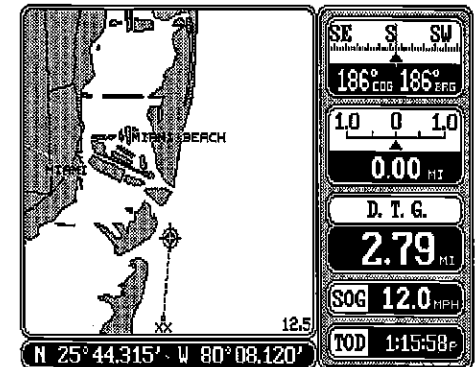

Pressing the NAV key at the bottom of the unit while the navigation screen is displayed changes all of the boxes shown at the bottom of the display. Of course, all of these displays can be changed or rearranged by the user in virtually any combination. See the Customize Screens section for more information.

Free Manuals Download Website

<http://myh66.com>

<http://usermanuals.us>

<http://www.somanuals.com>

<http://www.4manuals.cc>

<http://www.manual-lib.com>

<http://www.404manual.com>

<http://www.luxmanual.com>

<http://aubethermostatmanual.com>

Golf course search by state

<http://golfingnear.com>

Email search by domain

<http://emailbydomain.com>

Auto manuals search

<http://auto.somanuals.com>

TV manuals search

<http://tv.somanuals.com>