

marantz®

Network Audio Player
NA8005

Quick Start Guide

Kurzanleitung

Guide de démarrage rapide

Guida di avvio rapido

Guía de inicio rápido

Snelhandleiding

Snabbstartsguide

Краткое руководство пользователя

Skrócona instrukcja obsługi

ENGLISH

DEUTSCH

FRANÇAIS

ITALIANO

ESPAÑOL

NEDERLANDS

SVENSKA

РУССКИЙ

POLSKI

Welcome

Thank you for choosing a Marantz network audio player. This guide provides step-by-step instructions for setting up your network audio player.

Please do not return this unit to the store – call for assistance.

If you need help... :

If you need additional help in solving problems, contact Marantz customer service in your area.

For details, see the Marantz homepage. www.marantz.com

Before You Begin

Required for Basic connections

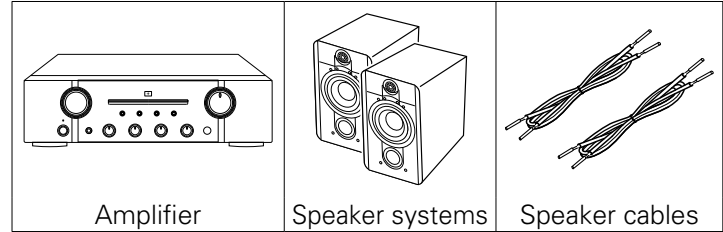

Required for Network connections

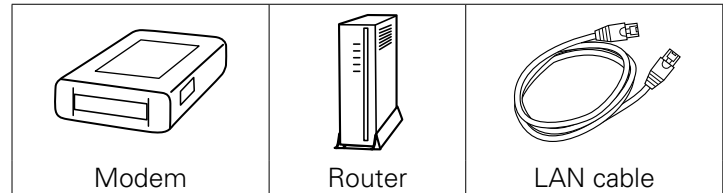



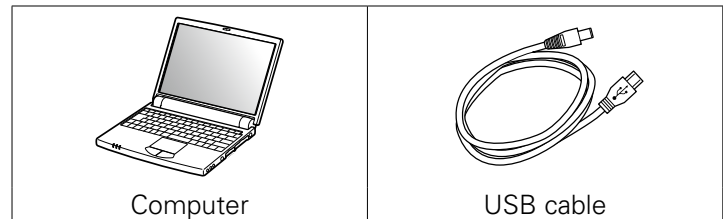





Required for PC or Mac Audio connections



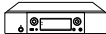

These drawings are for illustrative purposes only and may not represent the actual product(s).

What's In the Box

Quick Start Guide		Audio cable	
Owner's Manual		Remote connector cable	
Safety Instructions		Remote control unit	
Network audio player		R03/AAA batteries	
Power cord			

Setup Steps

There are six steps to the setup process.

- 1** Before using the remote control unit
- 2** Connect to the amplifier
- 3** Operate this unit with an iPad, iPhone or Android smartphone
- 4** Enjoying music using Network
- 5** Enjoying music using PC or Mac
- 6** Enjoying music using Apple AirPlay®

1 Before using the remote control unit

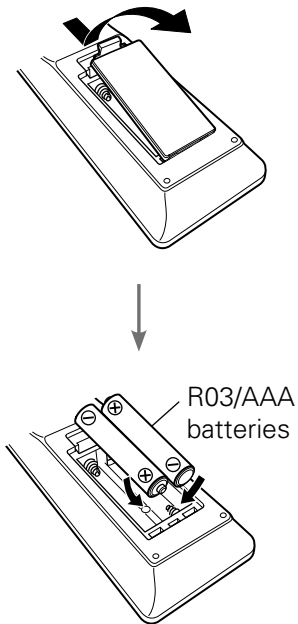

2 Connect to the amplifier

This unit

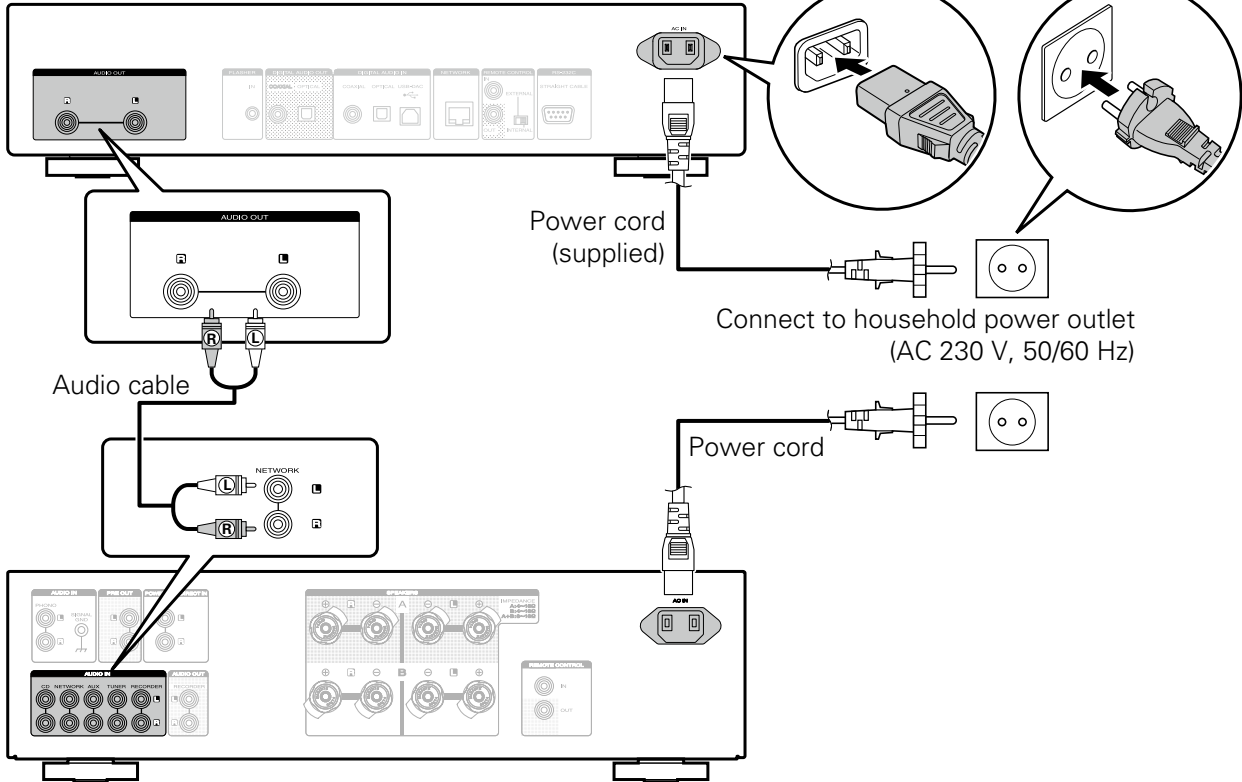

Power cord
(supplied)

Connect to household power outlet
(AC 230 V, 50/60 Hz)

Power cord

Audio cable

Amplifier

3 Operate this unit with an iPad, iPhone or Android smartphone

When this unit is connected to a Marantz amplifier or CD player, the amplifier or CD player can be operated using the Marantz Remote App.

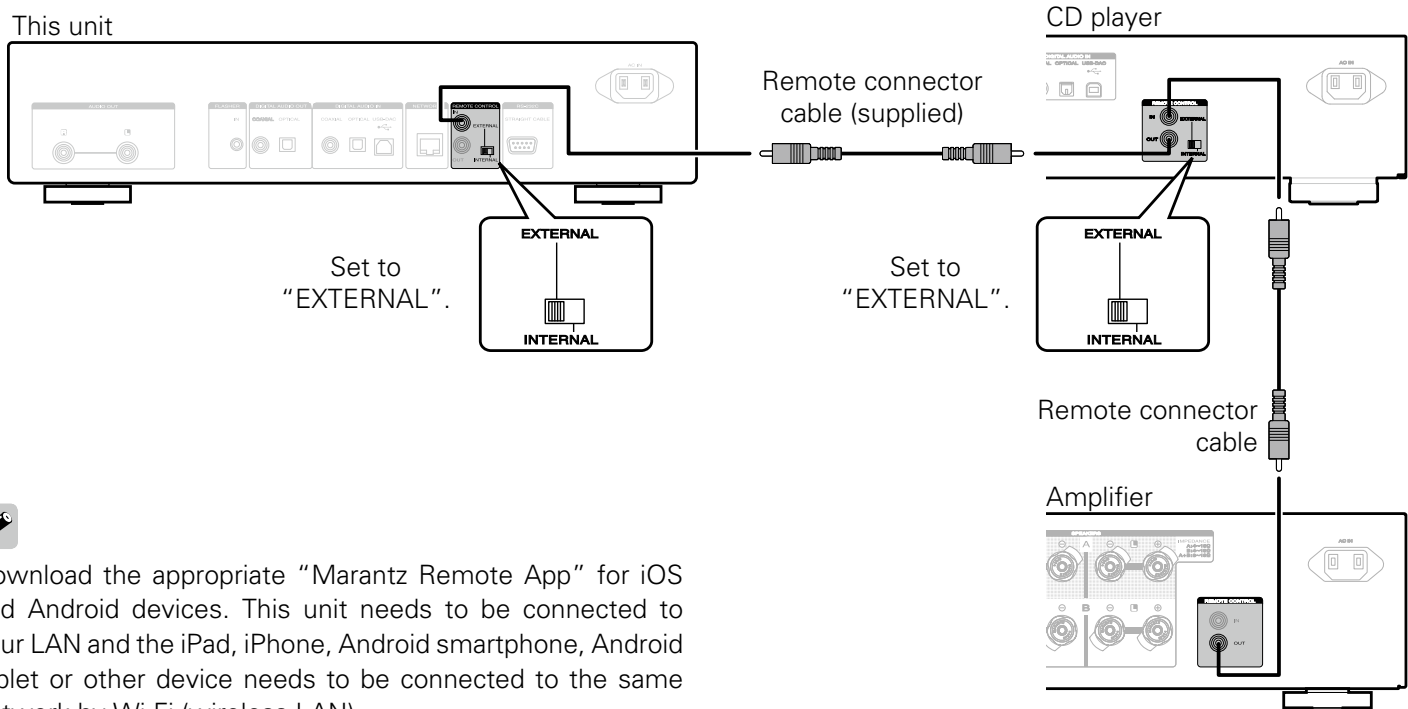

Download the appropriate "Marantz Remote App" for iOS and Android devices. This unit needs to be connected to your LAN and the iPad, iPhone, Android smartphone, Android tablet or other device needs to be connected to the same network by Wi-Fi (wireless LAN).

4 Enjoying music using Network

□ Connect to Network

1 Connect a LAN Cable between the NA8005 and your router.

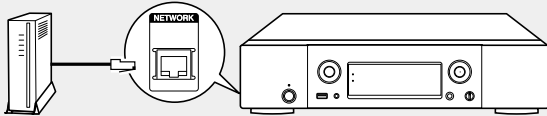

2 Power on.



3 Select language.

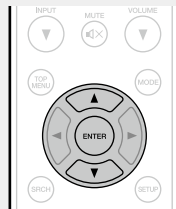

4 Select Network Control.

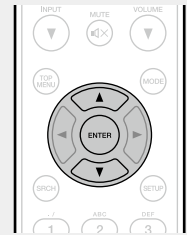
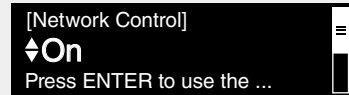

- Select "On" to control NA8005 from your smartphone, use Apple AirPlay® and maintain constant network access. Power consumption during standby power will be slightly higher.
- Select "Off" to reduce power consumption during standby. You can not turn on NA8005 or use Apple AirPlay from your smartphone until NA8005 is powered on manually and then connects to your network.

5 Setup is complete.

Setup Complete!

❑ Listen to Internet Radio

1 Press **INTERNET RADIO**.

2 Select the item, then press **ENTER**.

3 Repeat step **2** to select the station, then press **ENTER**.

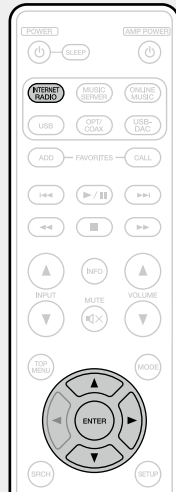

You can play back music files stored on a PC or NAS within the same network. For instructions on how to play back these files, see “Playing files stored on a PC and NAS” in the Owner’s Manual.

5 Enjoying music using PC or Mac

□ Connect to PC or Mac

1 Download the driver for this unit from the Marantz web site and install it on your PC.

- Drivers do not need to be installed for Mac OS.
- Download the driver software from the Marantz website.
- Operation will not occur correctly if connected to the computer before the dedicated driver has been installed.
- For instructions on operation, refer to the owner's manual.

2 Connect to PC or Mac.

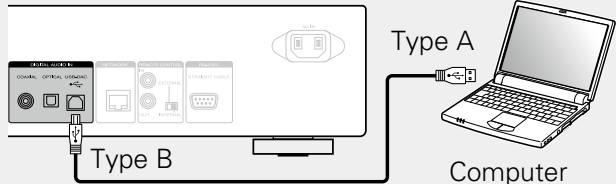

Plug that fits the shape of the connection device connector

Computer installed with a media player

3 Power on.



When you turn on the power of this unit for the first time, the Quick Setup menu is displayed. Perform settings according to the instructions shown on the display.

❑ Listen to PC or Mac Audio

1 Press **USB-DAC** to change the input source to “USB-DAC”.



2 Play back a music file with music playback software such as Windows Media Player, iTunes, foobar2000, Audirvana Plus and JRiver Media Center.



The type and sampling frequency of the music file are displayed.

NOTE

- Adjust the volume to an appropriate level on the computer.
- When using this unit with headphones connected, turn the headphone volume adjustment knob to adjust the volume.
- Further settings might be required in your dedicated media player software such as JRiver to enable high resolution audio playback. Please refer to the owner’s manual of the software.



Please refer to the Owner’s manual about the required specifications of suiting Computer.

6 Enjoying music using Apple AirPlay®

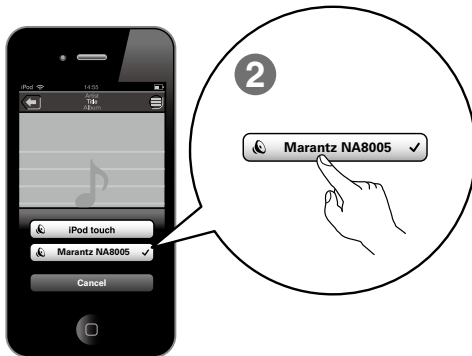
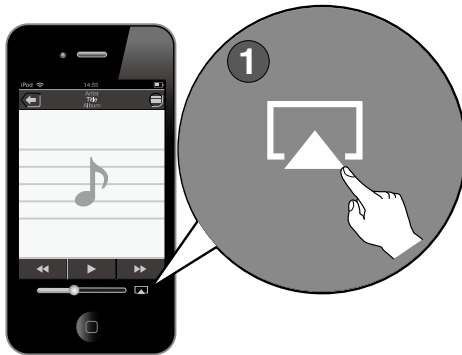

- 1** Tap the AirPlay icon from within any music app that supports AirPlay.
- 2** Select the “Marantz NA8005” from the AirPlay Device list.

NOTE

- When using AirPlay, a router with the Wi-Fi function is required.
- Make sure your iOS device is on the same network as this unit.

Owner's Manual

Please reference these manuals for more details about the setup and operation of the receiver and it's features.

❑ Web Manual

To read it on your tablet or PC, please access to Web Manual site.

manuals.marantz.com/NA8005/EU/EN/



This Web Manual is optimized for tablets and mobile devices.

Web Manual

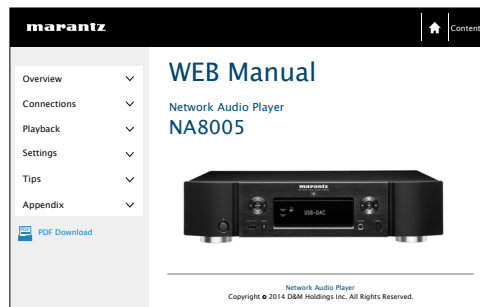

❑ PDF Manual

To read the owner's manual on your computer or to print it out, please open the included CD-ROM or select the "PDF Download" link from the Web Manual.

1

Insert the disc into your PC.

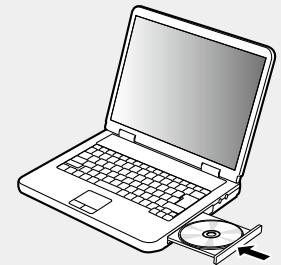

2

Follow the screen or double click on the PDF file.

www.marantz.com

You can find your nearest authorized distributor or dealer on our website.

marantz[®] is a registered trademark.

D&M Holdings Inc.
Printed in China 5411 11122 01AM

Free Manuals Download Website

<http://myh66.com>

<http://usermanuals.us>

<http://www.somanuals.com>

<http://www.4manuals.cc>

<http://www.manual-lib.com>

<http://www.404manual.com>

<http://www.luxmanual.com>

<http://aubethermostatmanual.com>

Golf course search by state

<http://golfingnear.com>

Email search by domain

<http://emailbydomain.com>

Auto manuals search

<http://auto.somanuals.com>

TV manuals search

<http://tv.somanuals.com>