

*Marshall*



MF350  
OWNERS MANUAL



## From Jim Marshall

*I would like to personally thank you for selecting one of my new MF350, 350 Watt, MODE FOUR amplifier heads.*

*The very first Marshall amplifier, the JTM45, was built in 1962 as a direct result of my listening to the requests of the guitarists who frequented my music shop at that time. Forty years later, we are still listening to the thoughts and wishes of guitar players from all walks of life. The amplifier you have just acquired is, once again, the direct result of us paying attention to feedback from guitarists, coupled with the latest innovations in amplifier technology from my Research and Development team. By continually building on our heritage of classic guitar tones and always keeping our ears and minds open, we are able to bring you the next generation of Marshall amplifier.*

*The MODE FOUR is completely designed, engineered and manufactured in the UK and like all of our products, the most rigorous quality control procedures are followed to ensure that it meets the standard of build and reliability you have come to expect from Marshall Amplification.*

*I would like to wish you every success with your new amplifier and welcome you to the ever-growing Marshall family.*

A stylized, handwritten signature in black ink that reads "Jim Marshall". The signature is fluid and cursive, with a long, sweeping underline that extends to the right.

A large, stylized, white-outlined logo of the word "Marshall" in a classic cursive script. The logo is set against a dark, circular background that resembles a vinyl record, with the center hole visible at the bottom. The logo is positioned vertically on the right side of the page.



## WARNING! - Important safety instructions

### WARNING: THIS APPARATUS MUST BE EARTHED!

- A PLEASE read this instruction manual carefully before switching on.
- B ALWAYS use the supplied mains lead, if a replacement is required please contact your authorised Marshall Dealer.
- C NEVER attempt to bypass the fuses or fit ones of the incorrect value.
- D DO NOT attempt to remove the amplifier chassis, there are no user serviceable parts.
- E Refer all servicing to qualified service personnel including replacement of fuses and valves. Servicing is required when the apparatus has been damaged in any way, such as when the power supply cord or plug is damaged, liquid has been spilled or objects have fallen into the apparatus, the apparatus has been exposed to rain or moisture, does not operate normally or has been dropped.
- F NEVER use an amplifier in damp or wet conditions. No objects filled with liquids should be placed on the apparatus. When cleaning, only use a dry cloth.
- G ALWAYS unplug this apparatus during lightning storms or if unused for long periods of time.
- H PROTECT the power cord from being walked on or pinched particularly at plugs, convenience receptacles and at the point where they exit from the apparatus.
- I DO NOT switch the amplifier on without a loudspeaker connected.
- J ENSURE that any extension cabinets used are of the correct impedance.

 - Note: This equipment has been tested and found to comply with the requirements of the EMC directive (Environments E1, E2 and E3 EN 55103-1/2) and the Low Voltage directive in the E.U.

 - Note: The Peak Inrush current for the MF350 is 30 amps.

Note: This equipment has been tested and found to comply with the limits for a Class B digital device, pursuant to part 15 of the FCC rules.

These limits are designed to provide reasonable protection against harmful interference in a residential installation. This equipment generates, uses and can radiate radio frequency energy and, if not installed and used in accordance with the instructions, may cause harmful interference to radio communications. However, there is no guarantee that interference will not occur in a particular installation. If this equipment does cause harmful interference to radio or television reception, which can be determined by turning the equipment off and on, the user is encouraged to try to correct the interference by one or more of the following measures:

- ◆ Reorient or relocate the receiving antenna.
- ◆ Increase the separation between the equipment and the receiver.
- ◆ Connect the equipment into an outlet on a circuit different from that to which the receiver is connected.
- ◆ Consult the dealer or an experienced radio/TV technician for help.

 CAUTION: Any changes or modifications not expressly approved by the party responsible for compliance may void the users authority to operate the equipment.

 Note: It is recommended that all audio cables used to connect the MF350, with the exception of the heavy duty speaker lead, are of a high quality screened type. These should not exceed 10 metres in length. Always use a non-screened Marshall approved heavy duty speaker lead (CABL-00031) with the MF350 head and extension cabinets.

 WARNING: Do not obstruct ventilation grilles and always ensure free movement of air around the amplifier!

 USA ONLY - DO NOT defeat the purpose of the polarised or grounding type plug. A polarised plug has two blades with one wider than the other. A grounding type plug has two blades and a third grounding prong. The wide blade or the third prong are provided for your safety. When the provided plug does not fit into your outlet, consult an electrician for replacement of the obsolete outlet.

FOLLOW ALL INSTRUCTIONS AND HEED ALL WARNINGS

KEEP THESE INSTRUCTIONS !



Over the years a great many amplifiers have claimed to offer both classic and modern tones but, in truth, have fallen well short of the mark. While designing the MODE FOUR we quickly realised that in order to truly produce both modern and classic performances within the same amplifier, we would have to go a lot further than simply switching a few pre-amp components when changing channels. Instead we needed to switch the whole amplifier.....

### Two in One

As a result of this simple but undeniable truth, the MODE FOUR boasts a true 'Two Amplifiers in One' design. AMP 1 (Classic) takes you from clean through to front-ended 2203 crunch, while AMP 2 (Modern) takes you into modern, high/extreme gain. To make this possible, not only do AMP 1 and AMP 2 have totally separate valve (a.k.a. tube) pre-amplifier circuits, but the MODE FOUR also completely reconfigures its power amplifier section depending on the AMP type selected.

### Four Modes

To further add to the flexibility of the MODE FOUR's revolutionary design, each of the two amplifier types it features, boasts two, footswitchable gain stages. AMP 1 offers CLEAN and CRUNCH modes while AMP 2 has OD1 and OD2.

### AMP 1

As already mentioned, AMP 1 is effectively the 'Classic' side of the MODE FOUR. Whenever AMP 1 is selected, the power amplifier reconfigures to recreate the unmistakable sound and feel of our world renowned, 100 Watt Super Lead Plexi. By using this as a sonic foundation, AMP 1 has the characteristic Marshall openness and roar that have made amps like the aforementioned Plexi, the 2203 and the Silver Jubilee 2555, timeless classics.

While AMP 1's CLEAN Mode produces incredibly dynamic, three-dimensional clean and bluesy crunch sounds, its CRUNCH Mode unleashes the unbridled aggression and bite of the JCM800 2203, but with levels of gain never imagined in 1981, when this much-lauded model was first launched.

### AMP 2

In terms of sheer gain, AMP 2 takes over from where AMP 1 leaves off, with OD2 Mode offering more gain than any other Marshall before. This said, thanks to the MODE FOUR's radical design, the player retains maximum control while searching for their ultimate high-gain signature sound.

### The Power to Deliver

Whenever AMP 2 is selected, the MODE FOUR's power section reconfigures itself so it can create the deep, dark-sounding, loose low-end that has proved itself to be so popular with many modern players who either detune regular six-strings, or use 7-string or detuned Baritone guitars.

Due to the unique design and the incredibly high headroom that the MODE FOUR's 350 Watt power stage possesses, AMP 2's impressively wide bottom-end not only has the sound and feel of an all-valve amp, it also doesn't lose definition at high stage volumes – a problem that many other similar sounding, all-valve systems suffer from.

## Fully Loaded For Professional Use

From the very start, the MODE FOUR was created with the professional guitarist in mind. To this end it boasts a host of carefully thought out features that have been designed to give you, the player, the ultimate in professional flexibility and control. These include:

- Two independent, footswitchable amplifiers – AMP 1 and AMP 2.
- Each amp type offers two footswitchable modes, giving you four in total: CLEAN, CRUNCH, OD1 & OD2.
- Each AMP has separate controls for GAIN, VOLUME, BASS, MIDDLE and TREBLE.
- Each AMP has a front panel SCOOP switch.
- AMP 2 has a three-way TONE MATRIX control.
- Footswitchable, built-in Digital Reverb with separate REVERB controls for AMP 1 and AMP 2.
- A Parallel / Series FX Loop with individual FX LEVEL controls for AMP 1 and AMP 2.
- A footswitchable SOLO LEVEL control.
- Master controls for RESONANCE, PRESENCE and VOLUME.
- The power stage is fan cooled to ensure reliable and efficient operation.
- A TUNER OUT jack with a front panel TUNER MUTE switch for 'silent' tuning between songs.
- XLR and 1/4" jack EMULATED LINE OUTPUTS.
- LOAD PROTECTION CIRCUITRY.
- 6-way LED footcontroller supplied that controls CLEAN, CRUNCH, OD1, OD2, SOLO and REVERB.

## MODE FOUR Front Panel Features - see panel page 70

### 1. INPUT Jack

Use a good quality guitar cable (i.e. one that's screened) to plug your guitar in here. The quality of your guitar cable is particularly important in a very high gain amplifier design such as the MODE FOUR. Any fault in the cable could lead to unwanted hum, noise, or high-pitched feedback.

In common with most high gain designs and in order to avoid unwanted noise, the MODE FOUR is automatically muted when there is nothing inserted into the INPUT Jack. This means that if no guitar is plugged in, the amp will be very quiet regardless of the settings.

**TONE TIP:** For using a separate pre-amp with the power amp section of the MODE FOUR, see **Frequently Asked Questions** (page 12)

**TONE TIP:** Microphonic (i.e. loose) guitar pickups can lead to unwanted low-end feedback at high gain settings. If your guitar suffers from this, we would suggest you visit a qualified guitar service technician to remedy the problem so you can get the optimum performance from your MODE FOUR at all Gain settings.

## AMP 1 CONTROLS

### 2. CLEAN Mode Select Switch

Push this switch to select the CLEAN Mode of AMP 1. When this mode is selected via the front

panel or the supplied 6-way footcontroller, the red LED within this switch will be illuminated.

### 3. CRUNCH Mode Select Switch

Push this switch to select the CRUNCH Mode of AMP 1. When this mode is selected via the front panel or the supplied 6-way footcontroller, the LED within this switch will light up.

### 4. GAIN Control

When AMP 1 is in CLEAN Mode, this control will take you from shimmering, bell-like, clean tones at low settings, to edgy, valve generated bluesy distortions at higher settings.

When CRUNCH Mode is selected you enter the hallowed world of a front-ended JCM800, which will give you classic Marshall metal and alternative rock tones. Low GAIN settings will yield the truly dynamic, touch sensitive, overdriven valve roar that made the JCM800 2203 a hard rock legend. Higher levels of GAIN give you dense, saturated tone with endless sustain and a slamming, low-end thump without losing any of that all-important note definition, even when playing complex chords.

**AMP 1 GAIN CONTROL SWEET SPOT:** The CLEAN and CRUNCH Modes of the MODE FOUR offer a huge degree of flexibility in terms of gain.

As the GAIN Control is shared between the CLEAN and CRUNCH Modes some change in

## MODE FOUR Front Panel Features - see panel page 70

level may be experienced when switching between these modes, especially at extreme settings.

The diagram below shows the 'Sweet Spot' area of the AMP 1 GAIN Control where the levels of CLEAN and CRUNCH are well balanced.

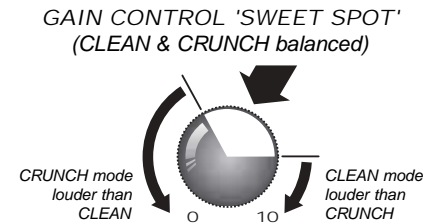

Obviously, when using GAIN settings on either side of this 'sweet spot', if you switch between AMP 1's CLEAN and CRUNCH modes, you're going to have to compensate for the resulting level differences with your guitar's volume control &/or pickup selection.

**TONE TIP:** At low CRUNCH settings, ballys crunch can be transformed into wonderfully rich clean tones by merely reducing the guitar volume control.

### 5. BASS Control

This controls the amount of low frequencies (bottom end) in your tone. Adjusting this control in conjunction with the RESONANCE control (12) will drastically affect the size and tightness of your low end. The more BASS and RESONANCE you dial in, the fatter your bottom end will become.

### 6. VOLUME Control

This control determines how loud or quiet AMP 1 is. This control should be used in conjunction with AMP 2's VOLUME control (19) to set the relative levels of the two amps. Once this is done you can use the MASTER volume control (16) to set the overall output level of the amplifier.

### 7. MIDDLE Control

This controls the all-important mid-range of your sound. Higher settings will make your guitar sound fatter and fuller. Conversely, lower settings will reduce the mids in your sound, giving you a more aggressive, 'scooped' sound.

### 8. SCOOP Switch

This control has been specifically fine-tuned to give the most crushing mid 'scoop' sound imaginable. By reconfiguring the entire post-EQ voicing of AMP 1, the tone becomes extremely aggressive – tight, punchy and focused with the highs and lows accentuated and the mids 'scooped' out.

### 9. REVERB Control

This controls the level of the MODE FOUR's specially designed, built-in, digital Reverb for AMP 1.

### 10. TREBLE Control

This control determines the amount of high-end and makes your guitar's tone brighter and more cutting as it is turned up. Adjusting the TREBLE Control will allow you to fine-tune upper-end 'shimmer' on your CLEAN sounds and aggressive bite on your CRUNCH – especially when used in conjunction with the PRESENCE Control (13).

**TONE TIP:** AMP 1's tone network is highly interactive and altering one control can change the shape of the sound in relation to the other tone controls. Experimentation is the best way to achieve your desired sounds.

### 11. FX LEVEL Control

When you're using an external effects device in the MODE FOUR's Parallel to Series FX loop, this control adjusts the amount of the chosen effect that will be mixed in with AMP 1's dry (unaffected) signal. Please refer to the FX Loop section on page 8 for further details.

## MASTER SECTION

MASTER SECTION Controls (12 - 16) are common to both AMP 1 and AMP 2.

### 12. RESONANCE Control

This control operates in the power amp section of the MODE FOUR and adds a low-end breadth and 'thump' to your sound that cannot be produced via EQ alone. When used in conjunction with the BASS control of AMP 1 (5) or AMP 2 (20), the RESONANCE control, affects the low-end rumble and overall tightness of your sound. Higher settings will give your tone a fatter, fuller bottom end.

### 13. PRESENCE Control

This control also operates in the power amp section of your amp and adds high frequencies to your tone, increasing edge and bite. Higher settings will make your sound become crisper and more cutting.

### 14. TUNER MUTE Switch

Engaging the TUNER MUTE switch mutes the speaker outputs and line outputs of the MODE FOUR, but allows signal to pass through the TUNER OUT jack on the rear panel (see page 8) for 'silent' tuning.

### 15. SOLO LEVEL Control

This control allows you to select a volume boost on all four modes when the BOOST switch is engaged on the included footcontroller. The SOLO LEVEL control will, when switched on, cause a volume increase of up to 6dB (i.e. twice the volume).

### 16. MASTER Volume Control

The MASTER Volume control determines the overall volume of your amplifier. We suggest you use the AMP 1 and AMP 2 Volume Controls ((6) and (19), respectively) to set the relative volume of the two amps and then use the MASTER to adjust the overall output of your MODE FOUR.

## AMP 2 CONTROLS

### 17. GAIN Control

This GAIN Control is shared by AMP 2's two selectable modes, OD1 & OD2. At low gain settings the valve generated overdrive will be dynamic and punchy. Increasing the GAIN Control will make the sound thicker and the

bottom-end more full. At high gain settings the pre-amp valve is driven into saturation as the sound becomes more compressed and there is an increase in the aggressive high end.

### 18. TONE MATRIX

The three way rotary TONE MATRIX Switch selects one of three fully independent tone control networks.

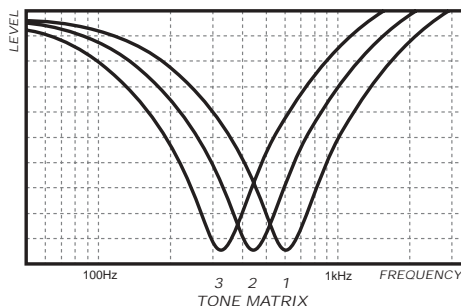

Each of the three positions entirely reconfigures the tone network for three different middle frequency responses (see above graph). This is different than a parametric equalisation in that the treble and bass controls remain completely interactive with the middle control.

The three positions give very different pre-amplifier distortion tones and hence experimentation is essential. The interactivity between the three tone controls (BASS, MIDDLE and TREBLE) cannot be overemphasised as this relationship varies between the three positions and again experimentation will allow you to dial your exact signature sound as required.

**TONE MATRIX Setting 1** – This has the highest mid frequency value of the three settings and produces that instantly recognisable 'woody knock' associated with high-gain Marshall valve amps.

**TONE MATRIX Setting 2** – This tightens up the low-mid frequencies and, as a result, your tone becomes heavier with less 'woodiness'.

**TONE MATRIX Setting 3** – This is the lowest of the three settings and is also the most extreme sounding. It removes the low-mid frequencies from your sound, giving you an exaggerated bottom-end that has tremendous width and 'thump'.

### 19. VOLUME Control

This control determines how loud or quiet AMP 2 is. This control should be used in conjunction with AMP 1's VOLUME control (6) to set the relative levels of the two amps. Once this is done you can use the MASTER volume control (16) to set the overall output level of the amplifier.

### 20. BASS Control

This controls the amount of low frequencies (bottom end) in AMP 2's tone. Adjusting this control in conjunction with the RESONANCE control (12) will drastically affect the size and tightness of your low end. The more BASS and RESONANCE you dial in, the fatter your bottom will become.

**TONE TIP:** Due to the unique nature of AMP 2's design, the low end becomes even bigger and also has an incredible 'thump' at high volumes – especially when TONE MATRIX Setting 3 is selected. Adjust BASS (20) and RESONANCE (12) according to taste.

### 21. REVERB Control

This controls the level of the MODE FOUR's specially designed, built-in, digital Reverb for AMP 2.

### 22. MIDDLE Control

This control adjusts the level of the all-important mid-range in your sound once AMP 2's mid-frequency has been selected with the TONE MATRIX switch (18). Turning this control up will make your guitar sound fatter and fuller. Conversely, turning it down will reduce the mids in your sound, giving you an aggressive 'scooped' tone.

### 23. SCOOP Switch

This control is voiced differently to the SCOOP switch on AMP 1 and has been meticulously fine-tuned to work with the sonic characteristics of AMP 2, reconfiguring the entire post-EQ voicing to give you the most uncompromising and brutal 'scoop' sound.

### 24. FX LEVEL Control

This controls the amount of external effect that is mixed in with the dry (unaffected) signal of AMP 2. Please refer to the FX Loop section (page 8) for further details.

### 25. TREBLE Control

This controls the amount of treble and makes your guitar's tone brighter as it is turned up.

**TONE TIP:** As is the case with AMP 1, AMP 2's tone network is highly interactive and because of this, altering one control can have a significant impact on your overall sound. As always, experimentation is the best way to achieve the tone(s) you desire.

### 26. OD1 Mode Select Switch

Push this switch to select the OD1 mode of AMP 2. When this mode is selected via the front panel or the supplied 6-way footcontroller, the LED within this switch will light up.

OD1 produces a modern, high gain tone with a slightly accentuated treble response and a large, tight bottom-end.

### 27. OD2 Mode Select Switch

Pushing this switch selects the OD2 mode of AMP 2. When this mode is selected via the front panel or the supplied 6-way footcontroller, the LED within this switch lights up.

OD2 produces a staggering amount of gain and also boasts an incredibly full and wide low-end thump – especially when TONE MATRIX Setting 3 is selected and the MODE FOUR is at high volume.

### 28. POWER Switch

This is the On/Off switch for the mains power to the amplifier. When it is switched 'On', the switch will light. Please ensure the amplifier is switched off and unplugged from the mains electricity supply before being moved.

**IMPORTANT NOTE:** As is the case with an all-valve amplifier, there will be no signal heard until the amp's ECC83 pre-amp valves warm-up and start to pass signal. This can take up to 30 seconds so don't panic!

## 1. MAINS INPUT

Your amp is provided with a detachable mains (power) lead that is connected here. The specific mains input voltage rating that your amplifier has been built for is clearly marked on the back panel. Before connecting for the first time, please ensure that your amplifier is compatible with your electricity supply. If you have any doubts, please get advice from a qualified person. Your Marshall dealer can help you in this respect.

## 2/3. SPEAKER OUTPUTS

The MODE FOUR Head has two speaker sockets for connection to either 1 or 2 external cabinets.

Always use a non-screened Marshall approved heavy duty speaker lead when connecting an extension cabinet to these units.

Please refer to **Cabinet Options Section** (page 10), for full details on choice of cabinet(s) and how to correctly connect them.

## 4. FOOTSWITCH

Connect the supplied six-way LED footcontroller here. When the footcontroller is connected you can select the amp's four modes by either the front panel switches or the footcontroller. In addition to allowing you to switch between the amp's four modes – CLEAN, CRUNCH, OD1 and OD2 – the footcontroller also facilitates REVERB on/off and SOLO on/off switching.

**NOTE:** Always tighten the screws on each end of the footcontroller's cable to ensure correct operation.

## 5. TUNER OUT

This where you connect the input of the tuner you're using.

**TONE TIP:** For 'silent' tuning engage the MUTE switch on the front panel (14).

## 6. LOAD PROTECTION CIRCUIT ACTIVE LED

The MODE FOUR is designed to produce its maximum rated power of 350 Watts into an 8 Ohm load.

Using a load of less than 8 Ohms could damage the MODE FOUR and loudspeaker cabinet.

If you use the MODE FOUR with a load of less than 8 Ohms the LOAD PROTECTION CIRCUIT will become active, there will no longer be sound, and the LOAD PROTECTION CIRCUIT LED will light (please refer to the **Cabinet Impedance Section** - page 10).

## EFFECTS LOOP (PARALLEL / SERIES)

To increase the flexibility of your MODE FOUR even further you may choose to connect external effects units to the built-in Parallel to Series FX LOOP. The effects loop allows direct connection of either floor pedals (stomp boxes) or rack processors. The FX LEVEL switch (8), provides the correct operating level to match your external effects device(s) (+4dB for rack units and -10dB for pedals). The amount of the chosen effect you add to AMP 1 and AMP 2 is determined by their respective FX LEVEL controls.

Since the MODE FOUR's FX LOOP is parallel, it means that the direct ('dry') signal is not passed through the loop and that your all-important tone is not at risk of being degraded by being sent through any external devices. Only a relatively small amount of signal is sent to the processor being used.

When either of the effects level controls are turned up full, the FX LOOP of that AMP becomes a Series Loop. This means that the entire signal is sent through the loop.

**FX LOOP TONE TIP 1:** As a rule, effects involving Distortion or Wah are not used in an FX loop; they're normally connected between the guitar and amp. They were specifically designed for use in front of the amp and, as a result, sound best when used that way. Time based effects such as Chorus, Flange, Reverb and Delay are best suited for Parallel FX loop use. This said remember, THERE ARE NO RULES so if you think your Wah and Fuzz pedals sounds best in the FX loop then go for it!

**FX LOOP TONE TIP 2:** When using time based effects such as Delay, Chorus, Flange and Reverb in the FX LOOP, for optimum performance the direct signal in the processor should be set to zero so that only the effect signal is returned to the amp. Doing this

ensures the most effective control of the effect level (via FX LEVEL Control 11 & 24) and that the tonal integrity of the amp's direct (dry) signal is unimpaired in any way by the processor.

**FX LOOP TONE TIP 3:** When using an effect such as Noise Reduction in the FX LOOP you're going to want it to work on the whole signal so the FX LEVEL of each AMP should be turned up full so that the loop becomes a Series one.

**FX LOOP TONE TIP 4:** If you decide to use a stomp box in the FX LOOP, unless the unit has a Dry/Wet mix control (or is a stereo device that has an output that only carries a 'wet' signal), in order to make the effect sound its best you're probably going to have to set the FX LEVEL Controls on maximum, or very close to it. Remember though, by doing this you are putting the tonal integrity of the MODE FOUR at risk because you're sending the entire signal through the effect box(s) being used. Let your ears decide what's good and what's not!

**FX LOOP TONE TIP 5:** Always use high quality, screened patch cables . . . and the shorter the better. Long cables can reduce top end and overall punch.

**FX LOOP TONE TIP 6:** If the processor being used has an input level control, ensure that it is set correctly.

## 7. FX RETURN Jack

This is where you connect the output of the external effects device you're using. As already stated, the amount of the chosen effect you'll hear on AMP 1 and AMP 2 will be determined by how you set their respective FX LEVEL controls on the front panel.

## 8. FX LEVEL Switch

This switch allows you to select the correct operating level for the effects unit you're using. As a rule the +4dB setting (switch in) is for rack devices and the -10dB setting (switch out) is for pedals (stomp boxes).

## 9. FX SEND Jack

This is where you connect the input of the external effects device you're using.

## RECORDING / D.I. OUTPUTS

### 10. EMULATED LINE OUTPUT Jack and XLR

Thanks to our critically acclaimed speaker emulation circuitry, the line level signal these outputs carry is perfect for both live and studio applications. As the EMULATED LINE OUT circuit is pre-MASTER Volume, it means it still operates when the MODE FOUR's MASTER volume control is turned all the way down – making 'silent' recording possible. The signal from both of these sockets is muted when the TUNER MUTE switch (14) is engaged.

Cabinet Impedance

The MODE FOUR must be connected to a minimum load of 8 Ohms. Connecting a load of less than 8 Ohms and playing the amp will trigger the LOAD PROTECTION (rear panel 6) and could damage the Mode Four or the speaker cabinet.

The recommended set-ups are shown below:



8 Ohm Half Stack



16 Ohm Half Stack



Full Stack

Note: these are the only impedance combinations allowed.

MF280 & MF400 4x12" Cabinets

Countless hours of Research and Development went in to the development of the MF350 and it became clear at an early stage that special cabinets would be needed to get the most from it. The MF280 (280W) and MF400 (400W) cabinets are the result of this parallel design process. Designed specifically to reproduce the balanced mid range and huge bottom end that are a prerequisite for extreme hard rock and nu-metal sounds, these cabinets feature:

- Sonically optimised Celestion loudspeaker designs
- Pro-gauge internal wiring
- Increased internal volume

The ultra-rugged construction has been underpinned with literally hundreds of hours of extreme endurance (soak) testing using real life signals in real life conditions. This has assured us that these cabinets are not only ready for the sonic demands of a high performance head like the MF350, but also the extreme physical abuse they may receive on the road.

We recommend the MF280A (angled) and B (base) for full stack operation and the MF400A or B for half stack operation.

Full Stack versus Half Stack

The MODE FOUR can be used either as a full stack (two cabinets) or half stack (one cabinet) configuration. The rig you choose is a matter of personal taste and as always when it comes to sound we recommend you try both to see which suits your style best. Below is a guide to the major attributes of each:

**Full Stack:**

Enhanced on stage spread.  
More 'cut through' due to accentuated treble and high mids.  
Iconic stage presence.

**Half Stack:**

More controllable spread of sound on stage (especially base type)  
Convenient and portable.

**Half Stack Options**

If the full 350W is to be delivered using a single cabinet it must have an impedance of 8 Ohms. Equally important is that the cabinet must have a nominal power rating of 350W or above if 8 Ohms, or 235W or above if 16 Ohms.

The MF400A and MF400B are 8 Ohm/400W cabinets specifically voiced for use in half stack configurations with the Mode Four.

Whether you choose an angled or base half stack configuration is a personal choice between the different tonal qualities of each set up.

The MF400A (angled) is, in keeping with other angled 4x12" cabinets, tonally more aggressive than the base option. The angled cabinet is the usual choice for those who want a more prominent upper mid and treble response that really cuts through in a live situation.

Alternatively, the MF400B (base) delivers a more even mid range with less spread of the aggressive treble response. Marshall 4x12" base cabinets are more often used by professionals as they have a more focused bottom end and a smoother mid range and treble response. They are often easier to deal with in terms of sound reinforcement and monitoring in a live situation.

Rear Panel Connections

Shown below is the Loudspeaker Connection chart from the MF350 rear panel.

OUTPUT	I	II
235W	16 Ω	X
350W	X	8 Ω
350W	16 Ω	16 Ω

**Half Stack Connection**

SPEAKER OUTPUTS I and II are specifically designed to provide the optimum damping on 8 or 16 Ohm cabinets in half stack operation.

We recommend connection of a single 16 Ohm cabinet to SPEAKER OUTPUT I or connection of a single 8 Ohm cabinet to SPEAKER OUTPUT II.

**Full Stack Connection**

Connect two 16 Ohm cabinets to SPEAKER OUTPUTS I and II.

ENGLISH

ENGLISH

**Can I use the MF350 power amp with another pre-amp?**

Yes, follow these simple steps:

Connect the output of your pre-amp to the MF350 FX RETURN jack socket.

Turn GAIN to MINIMUM on AMP 1 and AMP 2

Turn the FX LEVEL to maximum on AMP 1 and AMP 2

Insert a jack plug into the INPUT jack socket to release the automatic muting facility.

Note: You can use the footcontroller to select either the AMP 1 or AMP 2 power amp configurations.

**Can I connect any cabinet to my MF350 head?**

Yes, so long as the total impedance into the amplifier is equal or more than 8 Ohms (check the impedance selector on your cabinet). Please be aware that the MF350 can deliver 350 Watts and if, for example, your cabinet is only rated 280 Watts, there is a chance that you might damage your speakers by playing at high volume.

**Can I run my amp without a speaker cabinet connected, while doing silent recording for example?**

Yes, unlike a valve amplifier the MF350 allows you to do this. We recommend however that you turn the MASTER VOLUME to minimum, as it does not affect the output level on the EMULATED OUTPUTS.

**What does emulated out mean?**

This means that the line output is emulating the sound a good quality microphone located in front of your cabinet would produce. This allows you not only to record silently, but also provides an easy and reliable way of getting a good sound through a P.A.

**Can I use headphones in the EMULATED LINE OUTPUT?**

No, the LINE OUTPUT is a mono signal, whereas you would need a stereo output for headphones.

**Where is the best place for connecting my effects, front end or in the effects loop?**

Please refer to the section entitled Parallel to Series Effects Loop (page 8) for detailed explanations.

**What instruments can I use with my amplifier?**

The MF350 has been designed for use with an electric guitar, including baritone and detuned guitars.

**Can I disconnect the fans for recording when using the speaker cabinet mic'ed up?**

No, there are no user servicable parts in the MF350 and the fans are extremely important for the reliability of this product. The fans are the quietest available, but if you want to minimise any residual fan noise during your recording we recommend applying the favourite studio technique of buying a long speaker lead and connecting the head in a different room to where the cabinet is mic'ed up.

**What would happen if I connected a single 16 Ohm speaker cabinet to loudspeaker output II of the Mode Four?**

No damage would be caused connecting a single 16 Ohm cabinet to output II or connection of a single 8 Ohm cabinet to output I. However, the damping would be mismatched and this would have a negative effect on the sound.

**TONE TIP:** Damping refers to the amount of feedback applied to the power amplifier of the MODE FOUR from the speakers. It is important the damping is correctly matched to the load impedance used for optimum sound.

Before calling the service department, check the following:

If the unit does not seem to operate properly, read the instructions again, then check the table below. Under no circumstances should you attempt to repair an amplifier yourself, as this could be dangerous and would void the warranty.

Symptom	Cause	Solution
No power	The mains power cord is disconnected.	Ensure the mains power cord is correctly connected to the rear of the unit and then plug the power cord into the wall outlet securely.
No sound	Power is off	Ensure the MF350 is correctly connected to the mains supply and turn the ON/OFF button to the ON position. Wait 30 seconds for the valves to warm up.
	Volume control off	Make sure that all Gain, Volume and Master Volume controls are not on zero (also ensure that the guitar volume is up!)
	Guitar lead	Ensure your guitar lead is inserted fully at both ends and that the lead isn't damaged. It is always good practice to have a spare guitar lead.
	MUTE Switch is on (amber light is on)	First turn the MASTER VOLUME down and then turn the MUTE button off. Slowly increase the MASTER VOLUME.
	Direct signal in FX LOOP is interrupted while the FX LEVEL is on full	Disconnect all cables from SEND and RETURN on the rear panel. If the sound comes back, check your cables and outboard effects units.
	Speaker cable is disconnected	Ensure the speaker cable is in good condition and is fully inserted into the MF350 and the speaker cabinet.
Low frequency feedback	LOAD PROTECTION CIRCUIT active – the red LED will be lit on the back of the unit	Switch the amplifier off and check the total minimum impedance of your speaker cabinet(s) and that your speaker cable is correctly connected. Turn the MF350 on, if the problem is solved the red LED will be off.
	Microphonic (i.e. loose) pick-ups	Contact a qualified guitar technician for more information.
High frequency feedback and 'squeals'	Acoustic feedback	Increase the distance/orientation between the speakers and the guitar pickup, or alternatively decrease the gain or volume of the amplifier.
No Digital Reverb even with the level control on full	Reverb Footswitch is off	Ensure the red LED above the REVERB switch on the supplied footcontroller is on.
LOAD PROTECTION ACTIVE LED is on and the sound stops while playing	Minimum impedance not respected	Ensure the minimum impedance of your speaker(s) configuration is not below 8 Ohms; please refer to the Cabinet Options guide on page 10.



## Block Diagram

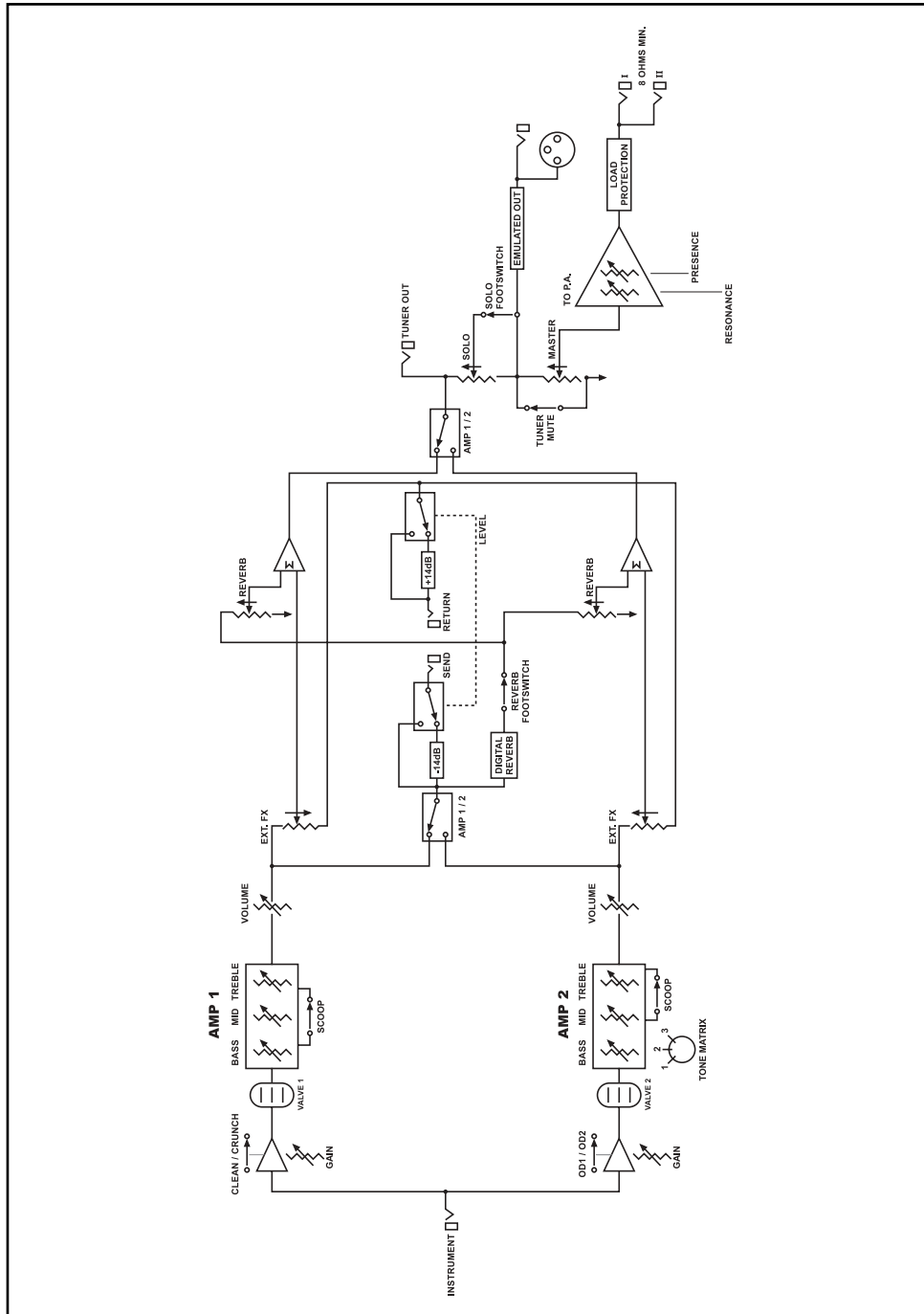

## Technical Specification

<b>Power Output</b>	<b>350W RMS into 8Ω</b>
Potencia de salida	350W RMS sobre 8Ω
Ausgangsleistung	350W RMS an 8Ω
Puissance de sortie	350W RMS sous 8 Ohms
<b>パワー出力</b>	<b>350W RMS / 8Ω 接続</b>
<b>Main Guitar • Input Impedance</b>	<b>1 MΩ</b>
Impedancia de entrada principal de guitarra	1 MΩ
Guitar • Input Eingangsimpedanz	1 MΩ
Impédance d'entrée	1 MΩ
<b>メインギター・入カインピーダンス</b>	<b>1 MΩ</b>
<b>Emulated Output • Level</b>	<b>-10dBV * see Note 1</b>
Nivel de salida de línea simulada	-10dBV * ver nota 1
Emulated Output • Ausgangspegel	-10dBV * siehe Hinweis 1
Niveau de sortie	-10dBV voir note 1
<b>エミュレート出力・レベル</b>	<b>-10dBV * 注1 参照</b>
<b>FX Send • Level Switchable</b>	<b>-10dBV, +4dBV * see Note 2</b>
Nivel de envío FX	-10dBV, +4dBV * ver nota 2
FX Send • Ausgangspegel	-10dBV, +4dBV * siehe Hinweis 2
Niveau de sortie d'effet	-10dBV, +4dBV * voir note 2
<b>エフェクト・センド・レベル切り替え</b>	<b>10dBV, +4dBV * 注2 参照</b>
<b>Weight</b>	<b>18kg</b>
Peso	18kg
Gewicht	18kg
Poids	18kg
<b>重量</b>	<b>18kg</b>
<b>Size (mm)</b>	<b>746 x 310 x 215</b>
Tamaño (mm)	746 x 310 x 215
Maße (mm)	746 x 310 x 215
Taille (mm)	746 x 310 x 215
<b>サイズ</b>	<b>746 x 310 x 215</b>
<b>Valves</b>	<b>2 x ECC83 (Dual Triode)</b>
Válvulas	2 x ECC83 (Triodo doble)
Röhres	2 x ECC83 (Dual Triode)
Lampes	2 x ECC83 (double triode)
<b>バルブ</b>	<b>2 x ECC83(デュアルトライオード)</b>

\* Note 1: Recommended for connection to inputs with input impedance >20KΩ

\* Nota 1: Se recomienda conectar a entradas con impedancia superior a 20KΩ

\* Hinweis 1: Empfohlen für Inputs mit eine Eingangsimpedanz >20KΩ

\* Note 1: Recommandée pour une impédance d'entrée supérieure à 20KΩ

\* 注1: 接続する入力の推奨インピーダンス >20kΩ

\* Note 2: Recommended for use with line level equipment (i.e. rack processor etc.)

\* Nota 2: Se recomienda utilizar con equipo con nivel nominal de línea ( como procesadores de rack, etc...)

\* Hinweis 2: Empfohlen für die Benutzung mit Equipment auf Linepegel (z.B.Studioeffektgeräte etc.)

\* Note 2: Recommandée pour des niveaux de ligne de type processeur d'effets en rack.

\* 注2: 接続機器 (ラックプロセッサなど) の推奨ラインレベル

## MODE FOUR FRONT PANEL FEATURES

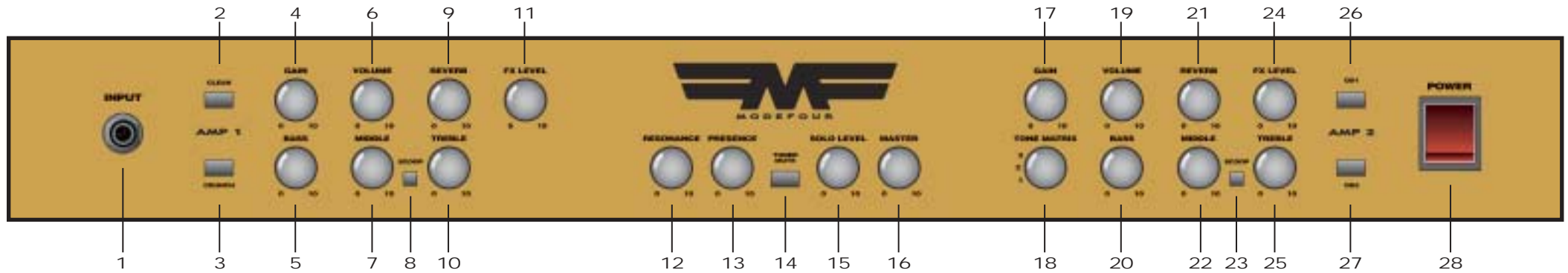

## MODE FOUR REAR PANEL FEATURES

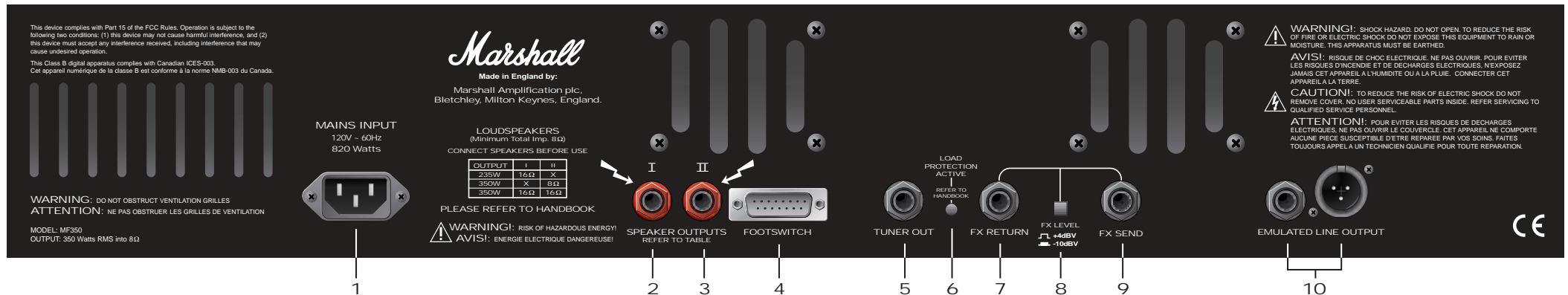

# AMP 1

# AMP 2

Full Bodied Clean

Solid Rhythm

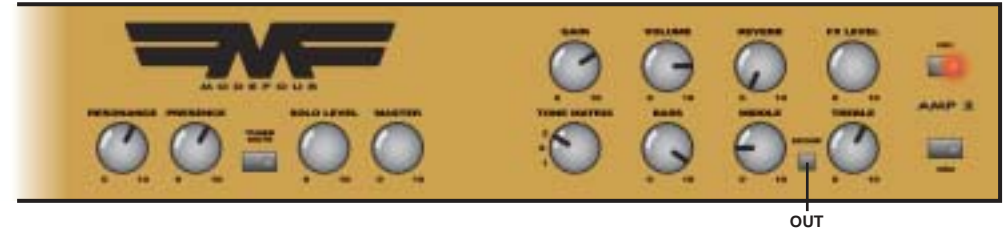
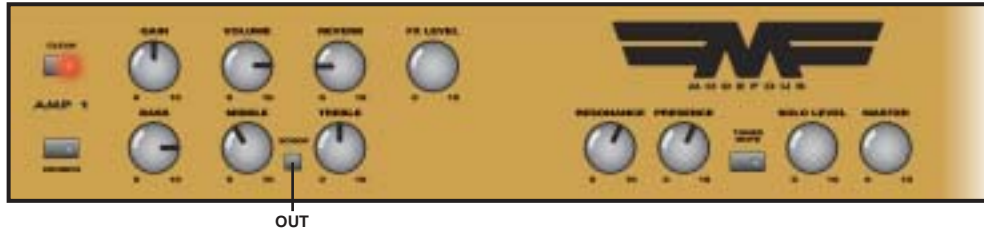

'Plexi' Clean

Classic Metal

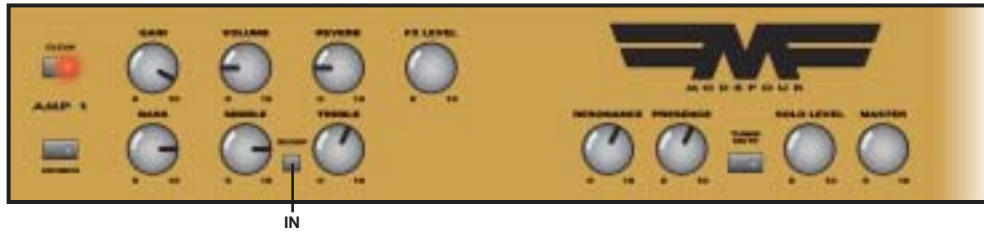

Dynamic Blues Solo

Detuned

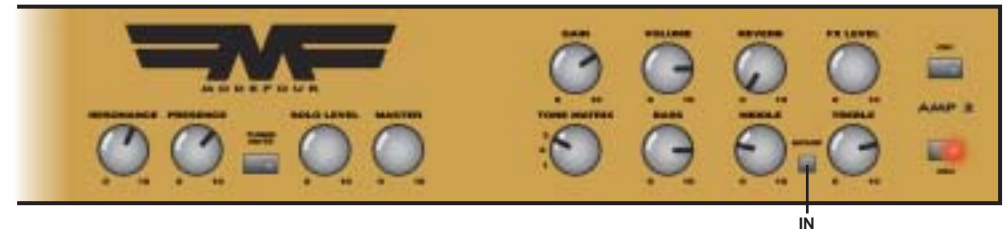
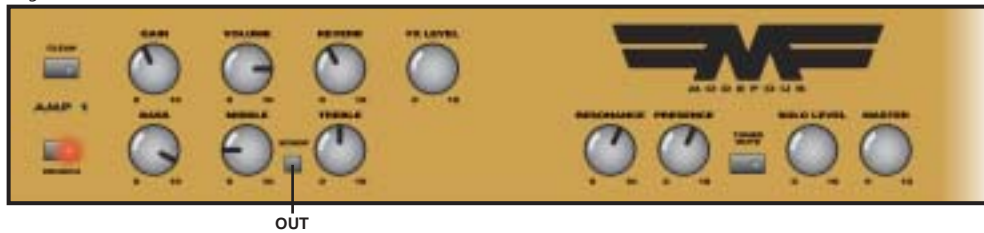

Hotrodded JCM800

Extreme Detuned

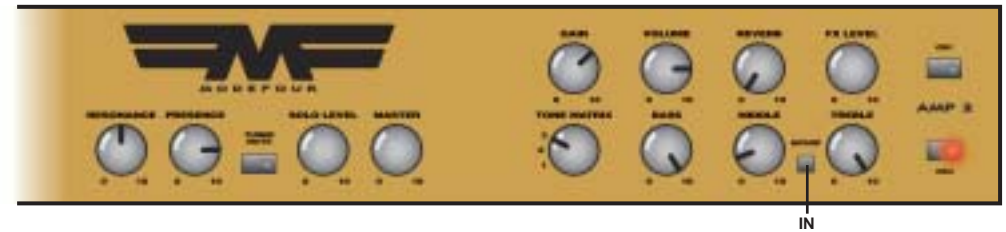
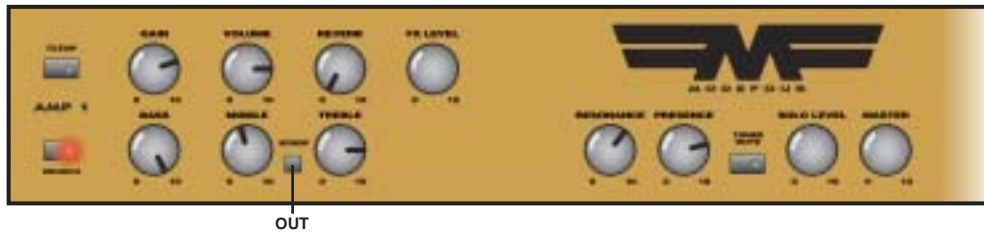

Extreme Thrash

Smooth Shred



## Free Manuals Download Website

<http://myh66.com>

<http://usermanuals.us>

<http://www.somanuals.com>

<http://www.4manuals.cc>

<http://www.manual-lib.com>

<http://www.404manual.com>

<http://www.luxmanual.com>

<http://aubethermostatmanual.com>

Golf course search by state

<http://golfingnear.com>

Email search by domain

<http://emailbydomain.com>

Auto manuals search

<http://auto.somanuals.com>

TV manuals search

<http://tv.somanuals.com>