

mellerware®

Livenza Milk Frother



complies with
INTERNATIONAL
IEC60335
SAFETY SPECIFICATIONS

m
550 W

2 YEAR
GUARANTEE

Model:
29400

PLEASE READ ALL INSTRUCTIONS BEFORE USE

2 year guarantee

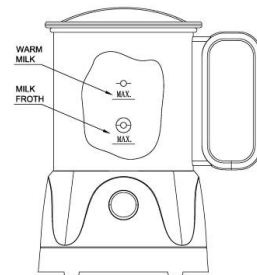
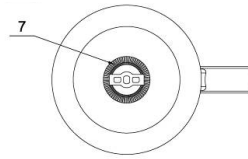
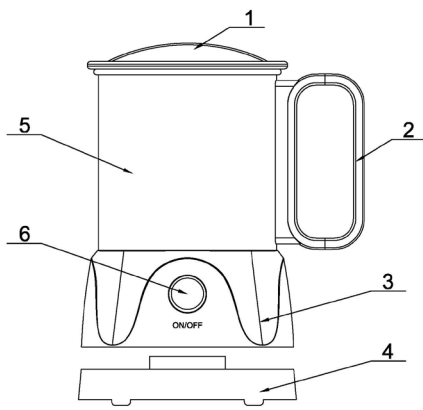

Description:

1. Lid
2. Handle
3. Motor housing
4. Base
5. Jug
6. On/off button
7. Frothing mechanism

Important safeguards:

When using electrical appliances, basic safety precautions should always be followed including the following:

1. Read all the instructions.
2. To protect against electrical hazards, do not immerse the appliance, or its power cord in water or any other liquid.
3. This appliance is not intended for use by persons (including children) with reduced physical, sensory or mental capabilities, or lack of experience and knowledge, unless they have been given supervision or instruction concerning use of the appliance by a person responsible for their safety.
4. Unplug the appliance from the wall socket before undertaking any cleaning task.
5. If the power cord is damaged, it must be replaced by an authorised service centre.
6. Do not use the appliance outdoors.
7. Do not let the power cord hang over the edge of a table or counter, or allow it to touch any hot surface.
8. Do not place the appliance on or near a hot gas or electric burner, or in a heated oven.
9. Extreme caution must be used when moving the appliance while it contains hot milk.
10. To disconnect, press the on/off button (the pilot light will switch off), then remove the plug from the wall socket.
11. **CAUTION:** This appliance generates heat during use. Proper care must be taken to prevent the risk of fire or injury.
12. Do not leave the appliance unattended while it is in use.
13. This appliance is for household use only. Do not use the appliance for anything other than its intended use.

To froth cold milk:

1. Pour the desired amount of fresh milk into the jug (MAX 300ml).
2. Close the lid.
3. Insert the plug into the wall socket. Press and hold the on/off button until the blue pilot light illuminates, then release the on/off button.
4. The milk will now begin to froth, please switch



the appliance off once the froth has reached the desired consistency.

5. You can use the appliance again once it has cooled down (after about 5 minutes).

To heat and froth milk:

1. Pour the desired amount of fresh milk into the jug (MAX 130ml) .
2. Close the lid.
3. Insert the plug into the wall socket. Press the on/off button, the red pilot light will illuminate.
4. The milk will now begin to heat and froth, the appliance will switch off automatically.
5. You can use the milk frother again once the appliance has cooled down (after about 5 minutes).

Cleaning:

1. Always ensure that the appliance is unplugged from the wall socket and that it has cooled down completely before undertaking any cleaning task.
2. After using the appliance, pour clean water and some dish washing liquid into the jug and allow it to stand for a few minutes, then rinse the appliance and wipe it with a clean dry cloth.

CAUTION:

- * Do not immerse the appliance in water or any other liquid.
- * Do not use any abrasive cleaning agents, or any sharp objects (such as knives or hard brushes) when cleaning this appliance.

Environment:



When you are ready to dispose of the appliance, remove the plug from the wall socket, and cut the power cord. Keep the appliance and its parts out of the reach of children. Deliver the appliance to an approved collection point for small appliances.



creative housewares

 20 Tekstiel Street Parow, Cape Town, 7493, South Africa

 P.O. Box 6156 Parow East, 7501, South Africa

 +27 21 931 8117  +27 21 931 4058

Service Centre Helpline: 086 111 5006

 www.creativehousewares.co.za

Free Manuals Download Website

<http://myh66.com>

<http://usermanuals.us>

<http://www.somanuals.com>

<http://www.4manuals.cc>

<http://www.manual-lib.com>

<http://www.404manual.com>

<http://www.luxmanual.com>

<http://aubethermostatmanual.com>

Golf course search by state

<http://golfingnear.com>

Email search by domain

<http://emailbydomain.com>

Auto manuals search

<http://auto.somanuals.com>

TV manuals search

<http://tv.somanuals.com>