

Thank you for purchasing the Olympus C-2100 Ultra Zoom.

This Quick-Start Guide has been designed for those who want to become familiar with the C-2100 Ultra Zoom in a very short time. The "Names of parts" section is especially helpful for identifying parts easily without having to read through the complete Instruction manual.

For detailed operations, please refer to the complete Instruction manual.

## 1 Getting Ready...

### Loading the batteries

1. Follow the procedure below.

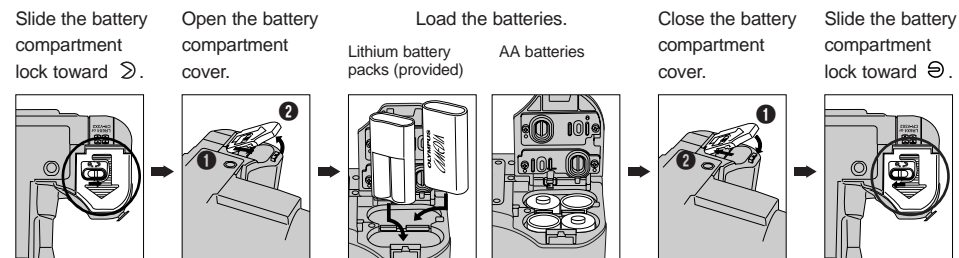

\* Close the battery compartment cover while pressing the batteries with the cover.  
 \* Zinc-carbon batteries cannot be used.

2. Inserting a SmartMedia card.

\* Before inserting, check that the Power switch is off and there are no images on the Viewfinder/Monitor.

Open the Card cover and push in the card\* as shown below.  
 (\*The pictures you take will be stored in the card.)

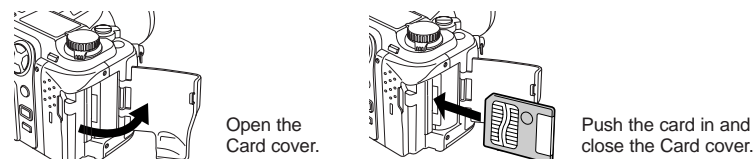

3. Turn on the camera.  
 Set the Power switch to ON.

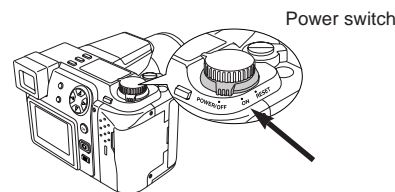

You can select camera functions using the Mode dial. You will probably want to try the Program mode first, which lets you take properly-exposed pictures by simply pressing the Shutter button.

Mode dial

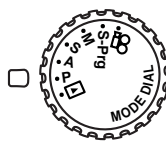

[Still picture recording mode]

- P: Simply press the Shutter button to take a picture.
- A: Set the desired aperture manually.
- S: Set the desired shutter speed manually.
- M: Set the desired aperture and shutter speed manually.
- S-Pr: Take pictures under a variety of conditions. (Portrait/Sports/Landscape/Night Scene)

[Movie recording mode]

- 🎥: Records movies.

[Still picture/Movie display mode]

- ▶: Displays your recording.

### Names of parts

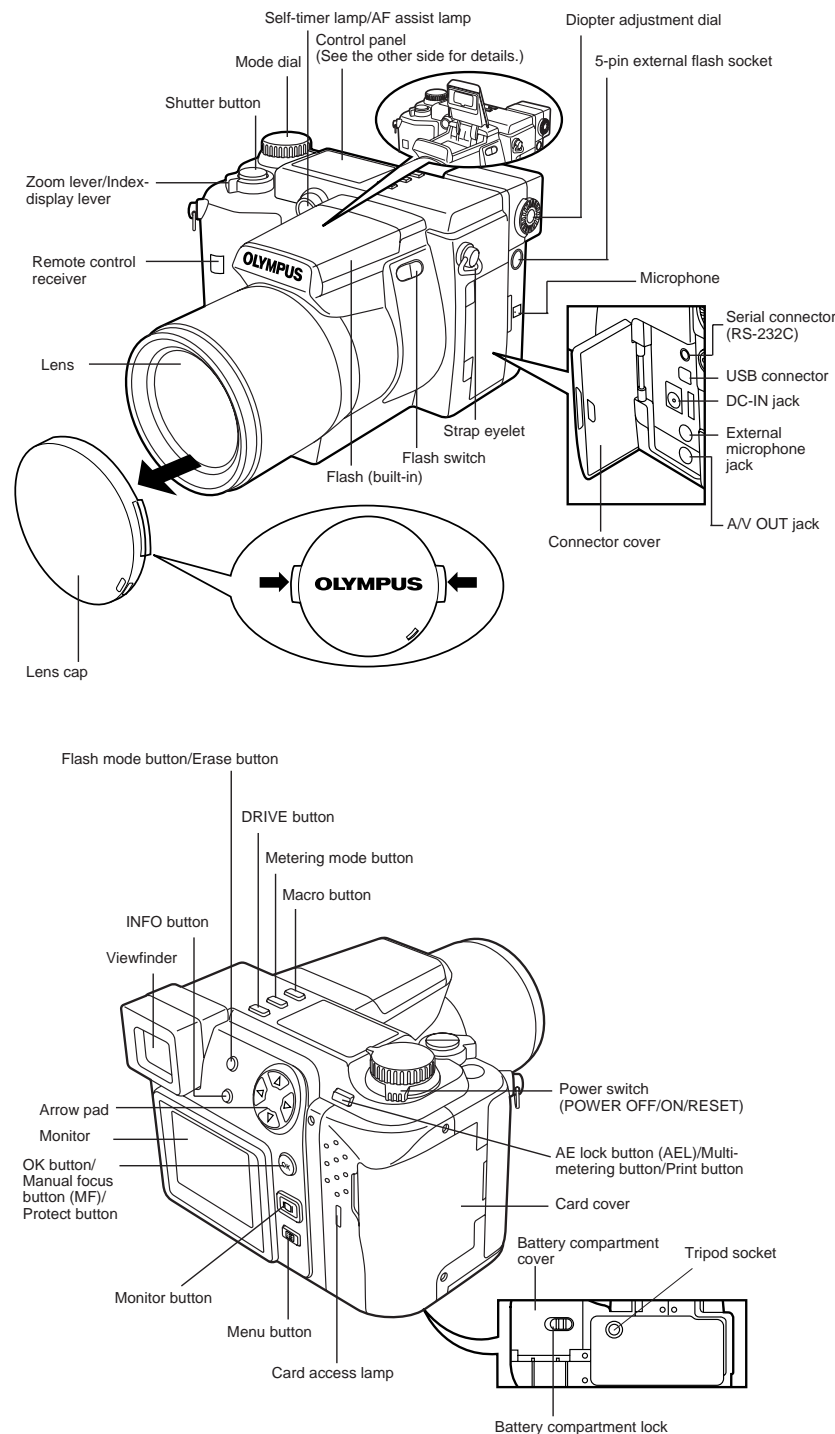

### Adjusting the Diopter

Turn the Diopter adjustment dial until you see the AF target mark clearly in the Viewfinder.

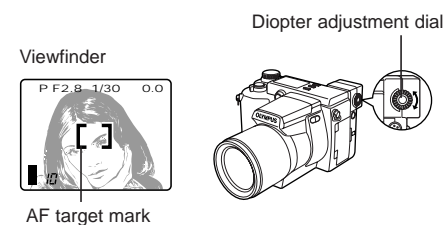

### Setting the date/time

1. Set the Mode dial to P.

2. Press .

The Menu appears on the screen.

Press to select whether to display your image on the Monitor or the Viewfinder.

3. Press on the Arrow pad to move the green frame in the Menu, then select "MODE SETUP".

"SETUP" appears on the screen. The selected item appears in green.

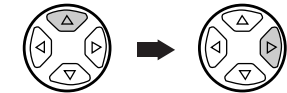

4. Press OK.

The MODE SETUP screen appears.

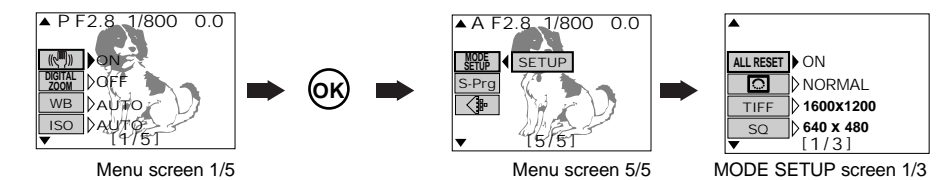

5. Press to select , then press .

"SETUP" appears on the screen.

To go to the previous page, move the cursor to the top item and press the button on the Arrow pad.

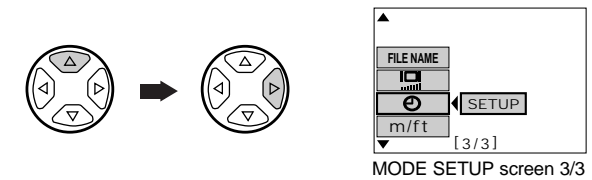

6. Press OK.

The Date/time setting screen appears.

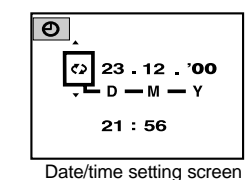

7. Press / on the Arrow pad to select the date order.

(Date order selections: date/month/year, month/date/year, year/month/date)

8. Press , then press / to adjust the date/time.

To go to the next setting (i.e. month to year, etc.), press . To go back to the previous setting (i.e. year to month, etc.), press .

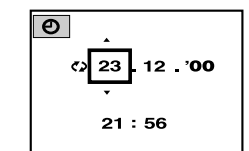

9. Press OK when you complete your settings.

10. To cancel the Menu, press OK until the Menu disappears.

## 2 Taking pictures

### Taking still pictures

1. Set the Mode dial to P.

2. Compose the picture by turning the camera towards the subject and adjusting the AF target mark until you can see it clearly in the Viewfinder.

Press to select whether to display your image on the Monitor or the Viewfinder.

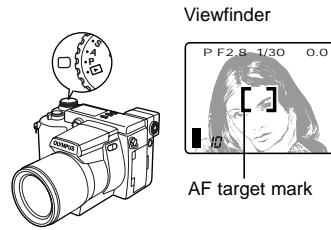

#### [To enlarge your subject]

Press the Zoom lever toward "T" to enlarge your subject. To return to normal magnification, press the Zoom lever back toward "W".

3. Press the Shutter button halfway to focus.

The AF confirmation mark lights up in green in the upper left corner and the camera beeps. Focus and exposure (shutter speed/aperture) become locked.

If the AF confirmation mark blinks, then the camera is out of focus. If this happens, release the Shutter button and move the camera slightly until you see the AF target mark clearly. Then, press the shutter button halfway again.

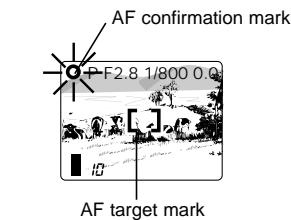
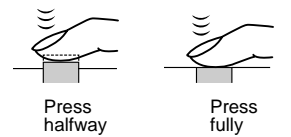

4. Press the Shutter button fully to take a picture.

The camera beeps when the shutter is released.

The free part of the memory gauge lights up and the card access lamp blinks while the picture is being recorded.

Continuous shooting is available even if the card access lamp is blinking, unless the entire memory gauge is lit.

If you are taking a picture in a dark environment, the built-in flash will fire automatically if it has been popped up.

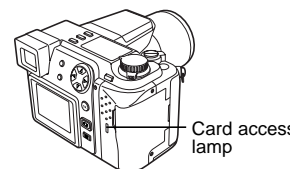

### Control panel indications

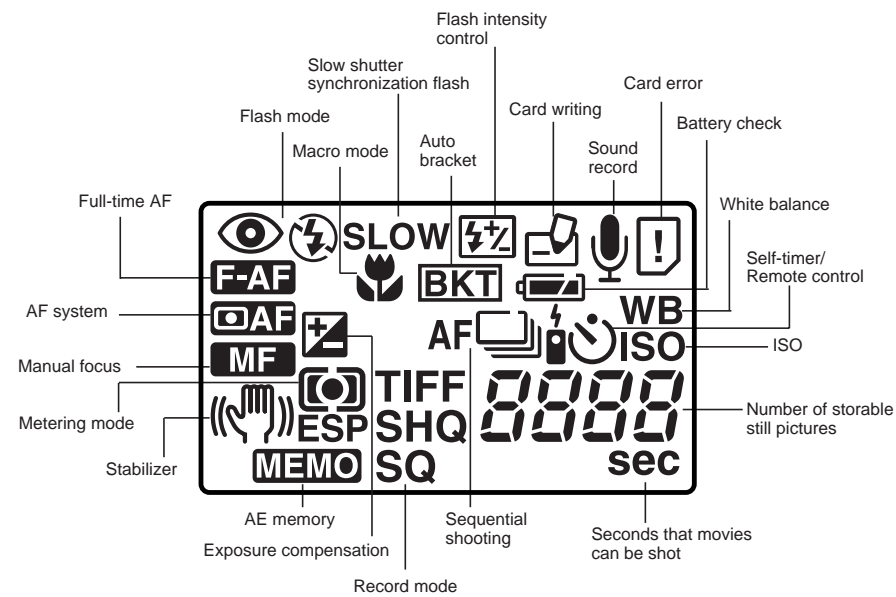

## 3 Displaying pictures

Set the Mode dial to .

The last picture taken is displayed.

- Use the Arrow pad to select the desired picture for display.
  - : Displays next picture.
  - : Displays preceding picture.
  - : Jumps to the picture 10 frames ahead.
  - : Jumps to the picture 10 frames behind.

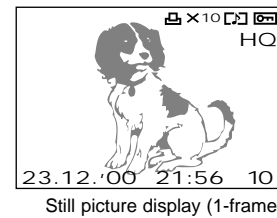

Still picture display (1-frame)



- \*Press the Zoom lever toward "W" to display multiple pictures at the same time (Index-display).
- \*Press the Zoom lever toward "T" to display a close-up.

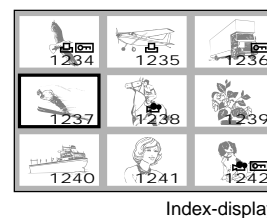

Index-display

#### [Movie pictures]

will appear with pictures that can be displayed as movies.

- Press to display the Menu.
- Select "MOVIE PLAY" and press on the Arrow pad.
- When "START" appears, press the OK button. The card access lamp blinks for a moment, then the movie starts.
- Press when you are finished watching. The Menu reappears. Press again to exit the Menu.

- Use the Arrow pad to select the desired picture for display.

- : Plays movie pictures when held down continuously.
- : Plays movie pictures in reverse when held down continuously.
- : Jumps to the beginning of the movie.
- : Jumps to the end of the movie.

- Press OK to pause the movie.

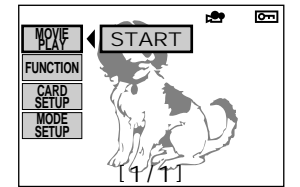

## 4 Erasing pictures

Unwanted images can be erased. You can erase one frame or all frames, depending on your requirements.

To erase an unwanted image, first display it on the screen as described in "3 Displaying pictures" on this page.

### 1-frame erase

Press the button on the camera and select "YES" on the confirmation screen using the Arrow pad. Then, press OK.

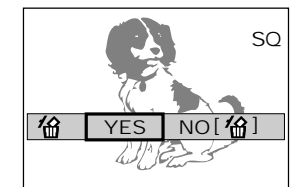

Confirmation screen

### All-frame erase

Press , then select "CARD SETUP"—"". Press OK. Select "YES" on the confirmation screen, then press OK again. (To cancel, select "NO", then press OK.)

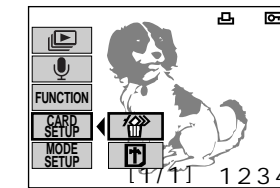

Erasing a still picture

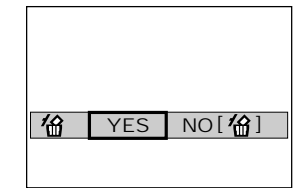

Confirmation screen

## 5 Turning off the power

When you are finished using the camera, turn the power off after checking that the card access lamp is not on.

- The picture on the screen will disappear when you turn the power off.
- If no operation is performed for 1 minute or more, the image on the screen goes off automatically to avoid battery exhaustion (this function is called Sleep). To end Sleep, perform any operation on your camera.
- When you store the camera, make sure to put the lens cap on.

### Taking movie pictures

1. Set the Mode dial to .

The maximum available recording time appears on the Viewfinder.

2. Press the Shutter button halfway to start movie recording and press it again halfway to stop.

The card access lamp blinks while the picture is being recorded.

Continuous shooting is available when the card access lamp stops blinking.

## Free Manuals Download Website

<http://myh66.com>

<http://usermanuals.us>

<http://www.somanuals.com>

<http://www.4manuals.cc>

<http://www.manual-lib.com>

<http://www.404manual.com>

<http://www.luxmanual.com>

<http://aubethermostatmanual.com>

Golf course search by state

<http://golfingnear.com>

Email search by domain

<http://emailbydomain.com>

Auto manuals search

<http://auto.somanuals.com>

TV manuals search

<http://tv.somanuals.com>