

# PENTAX



SLR Digital Camera

# K-7

## Operating Manual



For optimum camera performance, please read the Operating Manual before using the camera.

Download from [www.Somanuals.com](http://www.Somanuals.com). All Manuals Search And Download.

Thank you for purchasing this PENTAX **K-7** Digital Camera. Please read this manual before using the camera in order to get the most out of all the features and functions. Keep this manual safe, as it can be a valuable tool in helping you to understand all the camera capabilities.

### **Lenses you can use**

In general, lenses that can be used with this camera are DA, DA L, D FA and FA J lenses and lenses that have an Aperture **A** (Auto) position. To use any other lens or accessory, see p.53 and p.292.

### **Regarding copyrights**

Images taken using the **K-7** that are for anything other than personal enjoyment cannot be used without permission according to the rights as specified in the Copyright Act. Please take care, as there are cases where limitations are placed on taking pictures even for personal enjoyment during demonstrations, performances or of items on display. Images taken with the purpose of obtaining copyrights also cannot be used outside the scope of use of the copyright as laid out in the Copyright Act, and care should be taken here also.

### **Regarding trademarks**

PENTAX, **K-7** and smc PENTAX are trademarks of HOYA CORPORATION. PENTAX Digital Camera Utility and SDM are trademarks of HOYA CORPORATION.  SDHC logo is a trademark.

This product includes DNG technology under license by Adobe Systems Incorporated.

 The DNG logo is either registered trademarks or trademarks of Adobe Systems Incorporated in the United States and/or other countries.

HDMI, the HDMI logo and High-Definition Multimedia Interface are trademarks or registered trademarks of HDMI Licensing LLC.

All other brands or product names are trademarks or registered trademarks of their respective companies.

### **To users of this camera**

- There is a possibility that recorded data may be erased, noise may appear on recorded images, or the camera may not function correctly when used near broadcast towers or other facilities generating strong electromagnetic radiation or magnetic fields or near sources of strong static electricity.
- The liquid crystal panel used in the monitor is manufactured using extremely high precision technology. Although the level of functioning pixels is 99.99% or better, you should be aware that 0.01% or fewer of the pixels may not illuminate or may illuminate when they should not. However, this has no effect on the recorded image.

This product supports PRINT Image Matching III. PRINT Image Matching enabled digital still cameras, printers and software help photographers to produce image more faithful to their intentions. Some functions are not available on printers that are not PRINT Image Matching III compliant.

Copyright 2001 Seiko Epson Corporation. All Rights Reserved.

PRINT Image Matching is a trademark of Seiko Epson Corporation.

The PRINT Image Matching logo is a trademark of Seiko Epson Corporation.

- There is a possibility that the illustrations and the display screen of the monitor in this manual are different from the actual product.

## FOR USING YOUR CAMERA SAFELY

We have paid close attention to the safety of this product. When using this product, we request your special attention regarding items marked with the following symbols.



### Warning

This symbol indicates that violating this item could cause serious personal injuries.



### Caution

This symbol indicates that violating this item could cause minor or medium personal injuries, or material losses.

## ABOUT THE CAMERA



### Warning

- Do not disassemble or modify the camera. High voltage areas are present inside the camera, with the risk of electric shock.
- If the camera interior is exposed due to dropping or otherwise damaging the camera, never touch the exposed portion. There is a risk of electric shock.
- Wrapping the strap around your neck is dangerous. Take care that small children do not hang the strap over their necks.
- Do not look directly at the sun through the camera with a telephoto lens attached, as viewing the sun may damage your eyes. Viewing the sun directly with a telephoto lens may lead to a loss of eyesight.
- If any irregularities occur during use, such as smoke or a strange odor, stop use immediately, remove the battery or the AC adapter, and contact your nearest PENTAX Service Center. Continuing to use the product can cause a fire or electrical shock.
- Do not place your finger over the flash when discharging the flash. You may burn yourself.
- Do not cover the flash with clothing when discharging the flash. Discoloration may occur.
- Some portions of the camera heat up during use. There is a risk of low temperature burns when holding such portions for long periods.
- Should the monitor be damaged, be careful of glass fragments. Also, be careful not to allow the liquid crystal to get on your skin or in your eyes or mouth.
- Depending on a user's physical condition, some users may experience itching, break out in a rash or suffer from eczema. If an abnormality occurs, immediately discontinue using the camera and seek medical attention.

## About the Battery Charger and AC Adapter



### Warning

- Always use the battery charger and AC adapter exclusively developed for this product, with the specified power and voltage. Using a battery charger or AC adapter not exclusive to this product, or using the exclusive battery charger or AC adapter with an unspecified power or voltage can cause a fire, electric shock, or camera breakdown. The specified voltage is 100 - 240V AC.
- Do not disassemble or modify the product. This can cause a fire or electrical shock.

- If the generation of smoke or strange odor from the product or other abnormality occurs, immediately discontinue using and consult a PENTAX Service Center. Continuing to use the product can cause a fire or electrical shock.
- If water should happen to get inside the product, consult a PENTAX Service Center. Continuing to use the product can cause a fire or electrical shock.
- If thunderstorm should be present during use of the battery charger, unplug the power cord and discontinue use. Continuing to use the product can cause damage to the equipment, fire or electrical shock.
- Wipe off the plug of the power cord if it should become covered with dust. This can cause a fire.
- To reduce the risk of hazards, use only CSA/UL Certified power supply cord set, cord is Type SPT-2 or heavier, minimum NO.18 AWG copper, one end with a molded-on male attachment plug cap (with a specified NEMA configuration), and the other is provided with a molded-on female connector body (with a specified IEC nonindustrial type configuration) or the equivalent.



### Caution

- Do not place or drop heavy objects on or forcefully bend the AC plug cord. Doing so may damage the cord. Should the AC plug cord be damaged, consult a PENTAX Service Center.
- Do not touch or short-circuit the terminal area of the AC plug cord while the cord is plugged in.
- Do not plug or unplug the power cord with wet hands. This can cause an electric shock.
- Do not drop the product, or subject it to violent impact. This can cause equipment breakdown.
- Do not use the battery charger to charge batteries other than the rechargeable lithium-ion battery D-LI90. Attempting to charge other types of batteries may cause an explosion or heating, or may damage the battery charger.

## About the Battery



### Warning

- Be sure to store the battery out of the reach of small children. Placing in mouth may cause an electrical shock.
- If any leakage from the battery should come in contact with your eyes, do not rub them. Flush your eyes with clean water and get medical attention immediately.



### Caution

- Only use the specified battery with this camera. Use of other batteries may cause an explosion or fire.
- Do not disassemble the battery. Disassembling the battery may cause an explosion or leakage.
- The battery should be inserted correctly, observing (+) and (-) marks on the battery and the camera. Not inserting battery correctly may cause an explosion or a fire.
- Remove the battery from the camera immediately if it becomes hot or begins to smoke. Be careful not to burn yourself during removal.
- Keep wires, hairpins, and other metal objects away from the + and - contacts of the battery. When storing a battery removed from the camera, be sure to attach the provided protective cap to avoid shorting.

- Do not short the battery or dispose of the battery in fire. This can cause an explosion or fire.
- If any leakage from the battery should come in contact with skin or clothes, wash the affected areas thoroughly with water.
- Precautions for D-LI90 Battery Usage:
  - USE SPECIFIED CHARGER ONLY.
  - DO NOT INCINERATE.
  - DO NOT DISASSEMBLE.
  - DO NOT SHORT CIRCUIT.
  - DO NOT EXPOSE TO HIGH TEMP. (140°F / 60°C).

---

## About the SD Memory Card



### Warning

- Be sure to store the SD Memory Card out of the reach of small children. The SD Memory Card may be swallowed by mistake. Seek medical attention immediately if a memory card is accidentally swallowed.

---

## Care to be Taken During Handling

---

### Before Using Your Camera

- When traveling, take the Worldwide Service Network that is included in the package. This will be useful if you experience problems abroad.
- When the camera has not been used for a long time, confirm that it is still working properly, particularly prior to taking important pictures (such as at a wedding or when traveling). Pictures and sound cannot be guaranteed if recording, playback or transferring your data to a computer, etc. is not possible due to a malfunction of your camera or recording media (SD Memory Card), etc.

---

### About the Battery and Charger

- Storing the battery fully charged may decrease the battery performance. Avoid storing in high temperatures.
- If the battery is left inserted and the camera is not used for a long time, the battery will over-discharge and shorten the battery's usage span.
- Charging the battery a day before use or on the day of use is recommended.
- The AC plug cord provided with this camera is developed exclusively for the battery charger D-BC90. Do not use it with other devices.

---

### Precautions on Carrying and Using Your Camera

- Do not subject the camera to high temperatures or high humidity. Do not leave the camera in a vehicle, as the temperature can get very high.

- Do not subject the camera to strong vibrations, shocks, or pressure. Use a cushion to protect the camera from vibrations of motorcycles, automobiles, or ships.
- The temperature range for camera use is  $-10^{\circ}\text{C}$  to  $40^{\circ}\text{C}$  ( $32^{\circ}\text{F}$  to  $104^{\circ}\text{F}$ ).
- The monitor may appear black under high temperatures, but will return to normal as temperatures normalize.
- The monitor may respond more slowly at low temperatures. This is due to liquid crystal properties, and is not a fault.
- Sudden temperature changes will cause condensation on the inside and outside of the camera. Place the camera in your bag or a plastic bag, removing the camera after temperature of the camera and surroundings are equalized.
- Avoid contact with garbage, mud, sand, dust, water, toxic gases, or salts. These could cause a camera breakdown. Wipe dry any rain or water drops on the camera.
- Please do not press forcefully on the monitor. This could cause breakage or malfunction.
- Be careful not to over tighten the tripod screw when using a tripod.

---

## Cleaning Your Camera

- Do not clean the product with organic solvents such as thinner or alcohol benzene.
- Use a lens brush to remove dust accumulated on the lens or viewfinder. Never use a spray blower for cleaning as it may damage the lens.
- Please contact PENTAX Service Center for professional cleaning of the CMOS sensor. (This will involve a fee.)

---

## Storing Your Camera

- Do not store the camera with preservatives or chemicals. Storage in high temperatures and high humidity can cause mold to grow on the camera. Remove from the case and store in a dry and well-ventilated location.

---

## Other Precautions

- Periodic inspections are recommended every one to two years to maintain high performance.
- Refer to "Precautions When Using the SD Memory Card" (p.50) regarding the SD Memory Card.
- Please note that deleting the data recorded on an SD Memory Card or formatting an SD Memory Card using a camera or computer will not necessarily delete the data so that they cannot be recovered using off the shelf data recovery software. Such data should be handled and managed at your own risk.

### Regarding Product Registration

In order to better serve you, we request that you complete the product registration, which can be found on the CD-ROM supplied with the camera or on the PENTAX website. Thank you for your cooperation.

Refer to the provided "Quick Guide" for more information.

# Contents

FOR USING YOUR CAMERA SAFELY .....	1
Care to be Taken During Handling .....	3
Contents .....	5
Composition of the Operating Manual .....	11
<b>Before Using Your Camera</b> .....	<b>13</b>
<b><i>K-7</i> Characteristics</b> .....	<b>14</b>
<b>Checking the Contents of the Package</b> .....	<b>16</b>
<b>Names and Functions of Working Parts</b> .....	<b>17</b>
Capture Mode .....	18
Playback Mode .....	20
<b>Display Indicators</b> .....	<b>22</b>
Monitor .....	22
Viewfinder .....	31
LCD Panel .....	33
<b>How to Change Function Settings</b> .....	<b>34</b>
Using the Direct Keys .....	34
Using the Control Panel.....	35
Using the Menus.....	36
<b>Using the Mode Dial</b> .....	<b>39</b>
<b>Getting Started</b> .....	<b>41</b>
<b>Attaching the Strap</b> .....	<b>42</b>
<b>Using the Battery</b> .....	<b>43</b>
Charging the Battery .....	43
Inserting/Removing the Battery .....	44
Battery Level Indicator .....	46
Approximate Image Storage Capacity and Playback Time (Battery Fully Charged).....	46
Using the AC Adapter (Optional) .....	47
<b>Inserting/Removing the SD Memory Card</b> .....	<b>49</b>
Recorded Pixels and Quality Level.....	51
<b>Attaching the Lens</b> .....	<b>53</b>
<b>Adjusting the Viewfinder Diopter</b> .....	<b>55</b>
<b>Turning the Camera On and Off</b> .....	<b>56</b>
<b>Initial Settings</b> .....	<b>57</b>
Setting the Display Language.....	57
Setting the Date and Time .....	61

## Basic Operations

63

<b>Basic Shooting Operation</b> .....	<b>64</b>
Holding the Camera .....	64
Letting the Camera Choose the Optimal Settings .....	66
<b>Using a Zoom Lens</b> .....	<b>71</b>
<b>Using the Built-in Flash</b> .....	<b>72</b>
Setting the Flash Mode .....	72
Compensating Flash Output .....	76
Allowing Shooting while Charging Flash .....	77
<b>Playing Back Images</b> .....	<b>78</b>
Playing Back Images .....	78
Deleting Images .....	79

## Shooting Functions

81

<b>How to Operate the Shooting Functions</b> .....	<b>82</b>
Direct Keys Setting Items .....	82
Rec. Mode Menu Setting Items .....	83
Custom Setting Menu Setting Items .....	85
<b>Setting the Exposure</b> .....	<b>88</b>
Effect of Aperture and Shutter Speed .....	88
Setting the Sensitivity .....	90
Changing the Exposure Mode .....	93
Selecting the Metering Method .....	113
Adjusting the Exposure .....	115
<b>Focusing</b> .....	<b>118</b>
Using the Autofocus .....	118
AF Adjustment .....	121
Selecting the Focusing Area (AF Point) .....	122
Fixing the Focus (Focus Lock) .....	124
Adjusting the Focus Manually (Manual Focus) .....	126
<b>Checking the Composition, Exposure and Focus Before Shooting (Preview)</b> .....	<b>129</b>
Selecting the Preview Method .....	129
Displaying the Optical Preview .....	130
Displaying the Digital Preview .....	131
<b>Preventing Camera Shake during Shutter Release</b> .....	<b>132</b>
Using the Shake Reduction Function .....	132
Shooting with the Self-timer .....	136
Shooting with the Remote Control (Optional) .....	138
Shooting with the Mirror Lock-up Function .....	141
<b>Taking Pictures Continuously</b> .....	<b>143</b>
Continuous Shooting .....	143
Interval Shooting .....	144
Multi-exposure .....	146



<b>Shooting while Adjusting the Settings (Auto Bracket).....</b>	<b>148</b>
Shooting while the Exposure is Automatically Changed (Exposure Bracketing).....	148
Shooting while Adjusting Other Settings (Extended Bracketing).....	151
<b>Taking Pictures Using Digital Filter.....</b>	<b>153</b>
<b>Shooting with the Live View.....</b>	<b>156</b>
Taking Still Pictures .....	157
Recording Movies .....	160
<b>Using the Flash</b>	<b>167</b>
<hr/>	
<b>Flash Characteristics in Each Exposure Mode .....</b>	<b>168</b>
Using the Slow-Speed Sync .....	168
Using the Trailing Curtain Sync .....	170
<b>Distance and Aperture when Using the Built-in Flash .....</b>	<b>171</b>
<b>Lens Compatibility with the Built-in Flash.....</b>	<b>172</b>
<b>Using an External Flash (Optional) .....</b>	<b>173</b>
Using P-TTL Auto Mode .....	174
Using High-Speed Flash Sync Mode.....	175
Using in Wireless Mode .....	176
Red-Eye Reduction.....	179
Trailing Curtain Sync .....	180
Connecting an External Flash with an Extension Cord.....	180
Multiple Flash Shooting Using Extension Cords.....	181
Contrast-Control-Sync Flash .....	182
X-sync Socket.....	183
<b>Shooting Settings</b>	<b>185</b>
<hr/>	
<b>Setting the File Format .....</b>	<b>186</b>
Setting the JPEG Recorded Pixels .....	186
Setting the JPEG Quality Level .....	187
Setting the File Format .....	188
<b>Setting the White Balance .....</b>	<b>191</b>
Fine-tuning the White Balance.....	193
Adjusting the White Balance Manually .....	194
Adjusting the White Balance with Color Temperature .....	196
Saving the White Balance Setting of a Captured Image.....	198
<b>Correcting Images .....</b>	<b>199</b>
Adjusting the Brightness .....	199
Lens Correction .....	201
Adjusting the Composition .....	203
<b>Setting the Image Finishing Tone (Custom Image) .....</b>	<b>205</b>

<b>Storing Frequently Used Settings .....</b>	<b>207</b>
Saving the Settings.....	207
Checking the Saved USER Settings.....	208
Using Saved USER Settings .....	209
Changing the Settings .....	209
Resetting to Default Settings .....	210

## **Playback Functions 211**

---

<b>Playback Functions Operation .....</b>	<b>212</b>
Playback Mode Palette Setting Items .....	212
Playback Menu Setting Items .....	213

### **Enlarging Images .....** **214**

<b>Displaying Multiple Images .....</b>	<b>216</b>
Multi-image Display Screen .....	216
Displaying Images by Folder .....	217
Displaying Images by Shooting Date (Calendar display).....	218
Joining Multiple Images (Index).....	219

<b>Slideshow .....</b>	<b>222</b>
Setting the Slideshow Display .....	222
Starting the Slideshow .....	223

### **Rotating Images .....** **225**

### **Comparing Images.....** **226**

<b>Deleting Multiple Images .....</b>	<b>227</b>
Deleting Selected Images.....	227
Deleting a Folder .....	228
Deleting All Images.....	230

<b>Protecting Images from Deletion (Protect).....</b>	<b>231</b>
Protecting a Single Image.....	231
Protecting All Images.....	232

<b>Connecting the Camera to AV Equipment.....</b>	<b>233</b>
Connecting the Camera to a Video IN Jack.....	233
Connecting the Camera to an HDMI Terminal.....	235

## **Processing Images 237**

---

<b>Changing the Image Size .....</b>	<b>238</b>
Changing the Number of Recorded Pixels and Quality Level (Resize) .....	238
Cutting Out Part of the Image (Cropping).....	239

<b>Processing Images with Digital Filters .....</b>	<b>241</b>
Applying the Digital Filter.....	243
Recreating Filter Effects .....	244
Searching for the Original Image.....	246

<b>Developing RAW Images.....</b>	<b>247</b>
Developing One RAW Image.....	247
Developing Multiple RAW Images .....	248
Specifying the Parameters.....	250
<b>Readjusting Images Shot in JPEG Format .....</b>	<b>252</b>
<b>Changing Additional Settings</b>	<b>253</b>
<hr/>	
<b>How to Operate the Set-up Menu.....</b>	<b>254</b>
Set-up Menu Setting Items .....	254
<b>Formatting the SD Memory Card .....</b>	<b>256</b>
<b>Setting the Beep, Date and Time, and Display Language .....</b>	<b>257</b>
Setting the Beep .....	257
Changing the Date Display .....	258
Setting the World Time .....	258
Setting the Display Language.....	261
<b>Adjusting the Monitor and the Menu Display .....</b>	<b>262</b>
Setting the Text Size.....	262
Setting the Guide Display Time .....	262
Setting the Status Screen Display .....	262
Setting the Display for Instant Review .....	263
Adjusting the Brightness of the Monitor .....	264
Adjusting the Color of the Monitor .....	265
Setting the Electronic Level Display .....	266
<b>Setting the Folder Name/File Number Naming Convention ...</b>	<b>267</b>
Selecting the Folder Name .....	267
Selecting the File Number Setting .....	267
Setting the File Name .....	268
<b>Setting the Power Setting.....</b>	<b>270</b>
Setting Auto Power Off .....	270
Selecting a Battery.....	270
<b>Setting the DPOF Settings .....</b>	<b>273</b>
<b>Setting USB Connection Mode .....</b>	<b>275</b>
<b>Setting the Photographer Information Saved to Exif.....</b>	<b>277</b>
<b>Setting the Color Space .....</b>	<b>279</b>
<b>Correcting Defective Pixels in the CMOS Sensor (Pixel Mapping) .....</b>	<b>280</b>
<b>Selecting Settings to Save in the Camera (Memory) .....</b>	<b>281</b>

---

<b>Default Settings</b> .....	<b>284</b>
Resetting the Menu.....	290
<b>Functions Available with Various Lens Combinations</b> .....	<b>292</b>
Notes on [37. Using Aperture Ring].....	294
<b>Cleaning the CMOS Sensor</b> .....	<b>295</b>
Removing Dust with Ultrasonic Vibrations (Dust Removal).....	295
Detecting Dust on the CMOS Sensor (Dust Alert).....	296
Removing Dust with a Blower .....	297
<b>Optional Accessories</b> .....	<b>299</b>
<b>Error Messages</b> .....	<b>305</b>
<b>Troubleshooting</b> .....	<b>307</b>
<b>Main Specifications</b> .....	<b>309</b>
<b>Glossary</b> .....	<b>314</b>
<b>Index</b> .....	<b>319</b>
<b>WARRANTY POLICY</b> .....	<b>326</b>

# Composition of the Operating Manual

This Operating Manual contains the following chapters.

## 1 Before Using Your Camera

Explains camera characteristics, accessories and the names and functions of various parts.

## 2 Getting Started

Explains your first steps from purchasing the camera to taking pictures. Be sure to read it and follow the instructions.

## 3 Basic Operations

Explains the procedures for taking and playing back pictures.

## 4 Shooting Functions

Explains the shooting-related functions.

## 5 Using the Flash

Explains how to use the built-in flash and the external flash.

## 6 Shooting Settings

Explains the procedures for configuring image processing and setting the file format.

## 7 Playback Functions

Explains the procedures for playing back, deleting, and protecting pictures.

## 8 Processing Images

Explains the procedures for changing the image size, using image filters and processing pictures taken in RAW format.

## 9 Changing Additional Settings

Explains the procedures for changing the camera settings, such as the monitor settings and the image file naming convention.

## 10 Appendix

Explains troubleshooting, introduces optional accessories and provides various resources.

1

2

3

4

5

6



7

8

9

10

The symbols used in this Operating Manual are explained below.

	Shows reference page number explaining a related operation.
	Shows useful information.
	Shows precautions to take when operating the camera.

# 1 Before Using Your Camera

---

Check the package contents and names and functions of working parts before use.

<b><i>K-7</i> Characteristics .....</b>	<b>14</b>
<b>Checking the Contents of the Package .....</b>	<b>16</b>
<b>Names and Functions of Working Parts .....</b>	<b>17</b>
<b>Display Indicators .....</b>	<b>22</b>
<b>How to Change Function Settings .....</b>	<b>34</b>
<b>Using the Mode Dial .....</b>	<b>39</b>

- Features a 23.4×15.6 mm CMOS sensor with approximately 14.6 million effective pixels for high precision and a wide dynamic range.
- Features Shake Reduction (SR), an image sensor shifting shake reduction system. This enables you to capture sharp pictures with minimal camera shake regardless of the lens type.
- Features an AF sensor with 11 focusing points. The central 9 focusing points are wide cross area sensors.
- Features a viewfinder similar to that of a conventional 35 mm camera, with a magnification of approximately 0.9 and field of view of approximately 100%, for easier manual focusing. Also features a superimpose function in which the AF points on the viewfinder illuminate red.
- Features a large 3.0-inch monitor with approximately 921,000 dots, a wide viewing angle and brightness and color adjusting functions for high-precision viewing performance.
- Features a Live View function for shooting while viewing the subject in real-time on the monitor.
- Movies can be recorded by taking advantage of the camera lens properties. The camera can also output composite and HDMI video so that you can watch recorded images and movies on a TV or high-quality monitor.
- A user-friendly design has been implemented in various parts of the camera. The large text, high-contrast monitor and easy-to-use menus make the camera easier to operate.
- The body exterior is magnesium alloy, and the dials, buttons, joints, and retractable parts of the camera are dust-proof and water-resistant.
- Features Dust Removal function to shake the CMOS sensor and remove the collected dust.
- Features Hyper-program and Hyper-manual modes that let you take pictures with the intended exposure. Also features Sensitivity Priority mode **Sv** that automatically adjusts aperture and shutter speed according to the set sensitivity, and Shutter & Aperture Priority mode **TAv** that automatically adjusts sensitivity according to the set aperture and shutter speed.
- Features Digital Filter to internally process the image in the camera. You can use digital filters such as Star Burst or Soft while taking pictures or to process images after taking pictures.
- Features Custom Image which allows you to adjust settings while previewing the edited image, enabling a wider range of expression.



- Records in the versatile JPEG format or the high quality and fully editable RAW format. You can also select JPEG+RAW and record in both formats. Pictures taken in RAW format can be easily processed internally by the camera.
- Features Custom Image and White Balance which allow you to readjust images shot in JPEG format without affecting the image quality.
- Supports the optional Battery Grip D-BG4 with vertical shutter release button. If a battery (D-LI90) is inserted in both the camera and grip, the battery with more power is prioritized. This enables you to get the best camera performance for an extended period. A menu item also allows you to prioritize a battery and use its full power before switching to the other battery.

The captured area (view angle) will differ between the **K-7** and 35 mm SLR cameras even if the same lens is used because the format size for 35 mm film and CMOS sensor are different.

Sizes for 35 mm film and CMOS sensor

35 mm film	: 36×24 mm
<b>K-7</b> CMOS sensor	: 23.4×15.6 mm

Angles of view being equal, the focal length of a lens used with a 35 mm camera must be approximately 1.5 times longer than that of **K-7**. To obtain an angle of view framing the same area, divide the focal length of the 35 mm lens by 1.5.

Example) To capture the same image as a 150 mm lens attached to a 35 mm camera

$$150 \div 1.5 = 100$$

Use a 100 mm lens with the **K-7**.

Inversely, multiply the focal length of the lens used with the **K-7** by 1.5 to determine the focal length for 35 mm cameras.

Example) If 300 mm lens is used with the **K-7**

$$300 \times 1.5 = 450$$

Focal length is equivalent to a 450 mm lens on a 35 mm camera.

## Shake Reduction (SR)

Shake Reduction (SR) on the **K-7** features a PENTAX original system which uses magnetic force to move the image sensor at high speeds, compensating camera shake.

The camera may generate some operating noise when it is shaken, such as when changing the composition of a picture. It is not a malfunction.

# Checking the Contents of the Package

The following accessories are packaged with your camera. Check that all accessories are included.

1

Before Using Your Camera



Hot shoe cover F<sub>K</sub>  
(Installed on camera)



Eyecup F<sub>R</sub>  
(Installed on camera)



ME viewfinder cap



Sync socket 2P cap  
(Installed on camera)

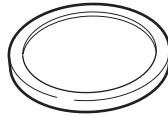

Body mount cover  
(Installed on camera)



Triangular ring and  
protective cover  
(Installed on camera)

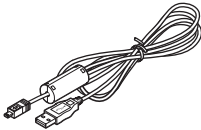

USB cable  
I-USB7

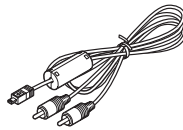

AV cable  
I-AVC7

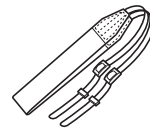

Strap  
O-ST53



Rechargeable lithium-ion  
battery D-LI90

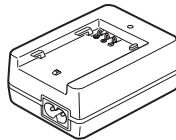

Battery charger  
D-BC90

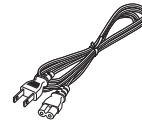

AC plug cord

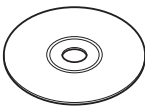

Software (CD-ROM)  
S-SW90



Operating Manual  
(this manual)

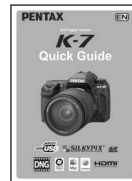

Quick Guide

# Names and Functions of Working Parts

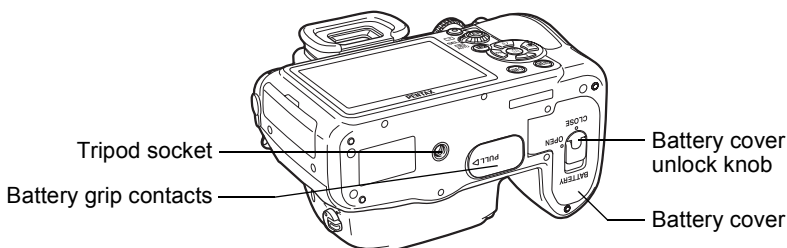
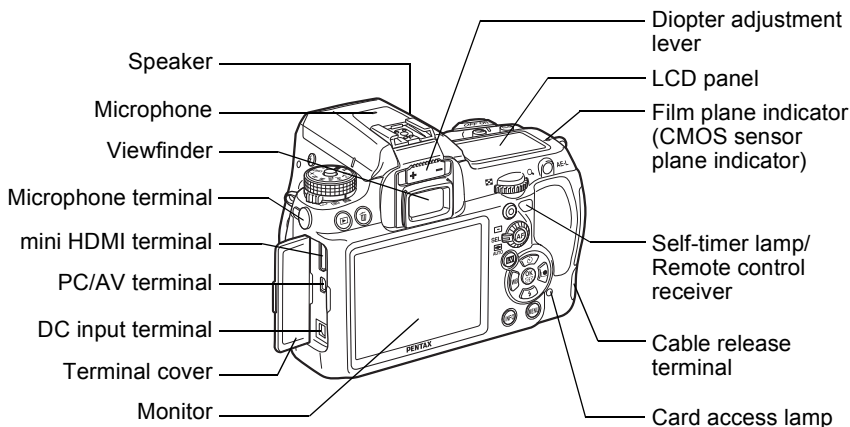
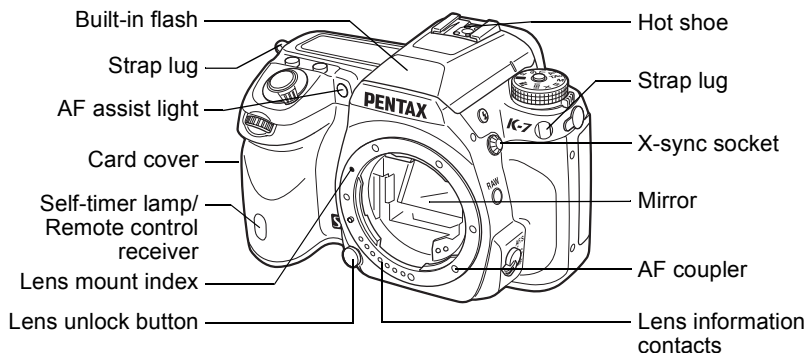

\* In the first illustration, the camera is shown with the Hot shoe cover F<sub>K</sub> removed.

\* In the second illustration, the camera is shown with the Hot shoe cover F<sub>K</sub> and the Eyecup F<sub>R</sub> removed.

## Capture Mode

Functions of buttons, dials and levers used during shooting are noted.

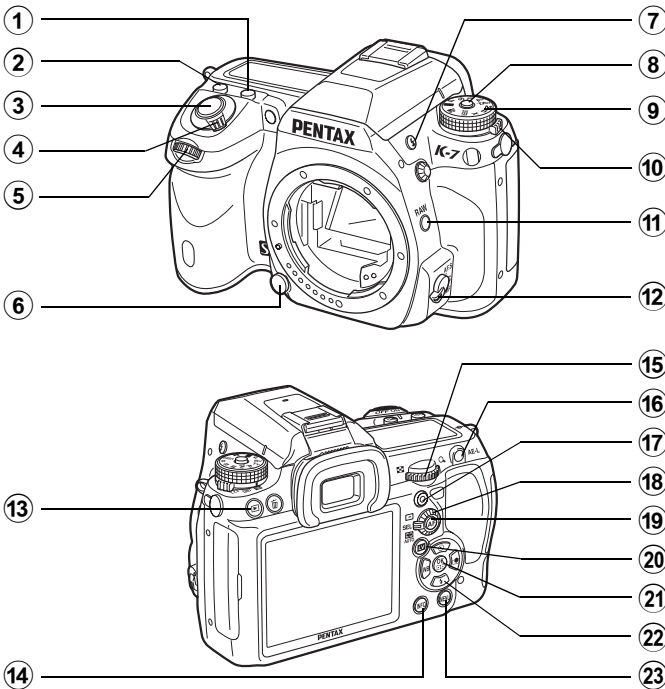

① **EV button**

Turn the rear e-dial while pressing this button to set the EV compensation value. (p.115)

② **ISO button**

Turn the rear e-dial while pressing this button to set the ISO sensitivity. (p.90)

③ **Shutter release button**

Press to capture images. (p.67)

④ **Main switch**

Move to turn the power on/off (p.56) or to preview (p.129).

⑤ **Front e-dial (☀️)**

Changes the settings.

⑥ **Lens unlock button**

Press to detach lens. (p.53)

⑦ **⚡ button**

Press to pop up the built-in flash. (p.74)

- ⑧ **Mode dial lock button**  
Press to allow the mode dial to be turned. (p.39)
- ⑨ **Mode dial**  
Switches the exposure modes. (p.39)
- ⑩ **Metering mode switching lever**  
Changes the metering method. (p.113)
- ⑪ **RAW button**  
Temporarily changes the file format. Saves JPEG and RAW file by default. (p.189)
- ⑫ **Focus mode lever**  
Switches between autofocus modes (**AF.S/AF.C**) (p.118) and manual focus mode (p.126).
- ⑬ **▶ button**  
Switches to the Playback mode. (p.78)
- ⑭ **INFO button**  
Turns the status screen display on the monitor on/off. (p.23)  
Displays the control panel when the status screen is shown. (p.24)
- ⑮ **Rear e-dial (☀️)**  
Changes the settings.
- ⑯ **AE-L button**  
Records the exposure before shooting (p.116) and saves a preview image.
- ⑰ **⦿ (Green) button**  
Sets the exposure mode to Automatic Exposure and resets the settings.
- ⑱ **AF point switching dial**  
Sets focusing area. (p.122)
- ⑲ **AF button**  
Sets focusing area and temporarily provides manual focus. (p.120)
- ⑳ **📺 button**  
Displays the Live View. (p.156)
- ㉑ **OK button**  
When the control panel or a menu screen is displayed, press this button to confirm the selected item. When the AF point switching dial is set to **SEL** (Select), press the button to change the AF point. (p.123)

## 22 Four-way controller

(▲▼◀▶)

Opens the [Drive Mode], [Flash Mode], [White Balance] or [Custom Image] setting screen (p.82). When the control panel or a menu screen is displayed, use this to move the cursor or change items. When the AF point switching dial is set to **SEL** (Select), use this to move the AF point. (p.123)

## 23 MENU button

Displays the [Rec. Mode 1] menu (p.83). Next, press the four-way controller (▶) to display other menus.

## Playback Mode

Functions of buttons, dials and levers used during playback are noted.

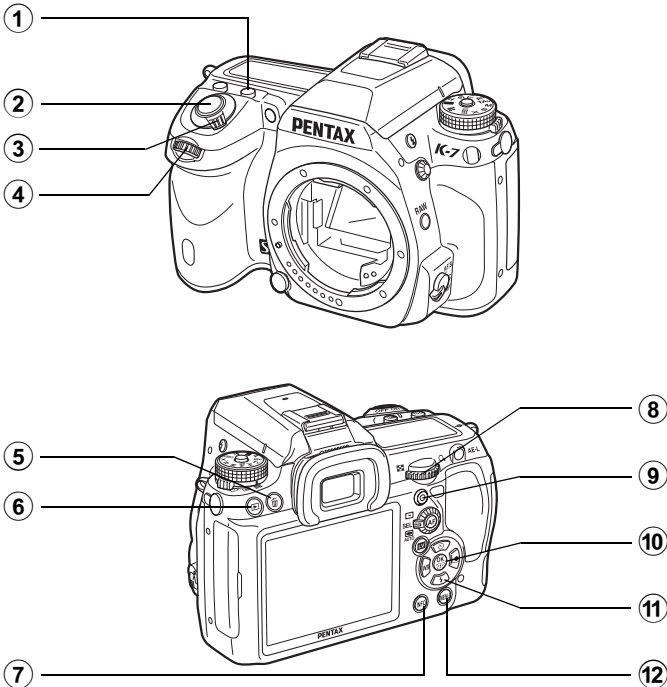

- ① **☒ button**  
Press in the enlarged view to increase the magnification. (p.214)
- ② **Shutter release button**  
Press halfway to switch to Capture mode.
- ③ **Main switch**  
Move to turn the power on/off. (p.56) Set to the  position to switch to Capture mode and preview.
- ④ **Front e-dial (☀️)**  
Displays the next or previous image.
- ⑤ **🗑️ button**  
Press to delete images. (p.79)
- ⑥ **▶️ button**  
Press to switch to Capture mode.
- ⑦ **INFO button**  
Press to display the shooting information on the monitor. (p.25)
- ⑧ **Rear e-dial (☀️)**  
Use this to change the magnification in the enlarged view (p.214) and display multiple images at the same time (p.216).
- ⑨ **⦿ (Green) button**  
Press in the enlarged view to decrease the magnification. (p.214)
- ⑩ **OK button**  
Saves the item you selected in the menu.
- ⑪ **Four-way controller (▲▼◀▶)**  
Press ▼ to display the playback mode palette (p.212). When a menu screen is displayed, use this to move the cursor or change items.
- ⑫ **MENU button**  
Press to display the [▶️ Playback 1] menu (p.213). Next, press the four-way controller (▶️) to display other menus.

## References to Button Names

In this Operating Manual, the buttons of the four-way controller are referred to in the following way.

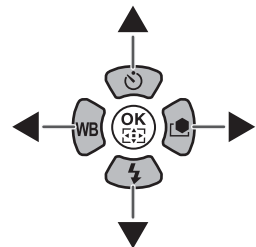

## Monitor

1

Before Using Your Camera

The following indicators appear on the monitor depending on the status of the camera.

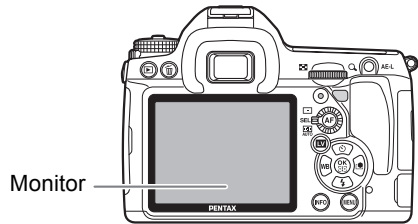

The brightness or the color of the monitor can be adjusted. (p.264)

## At Start-up or when Operating the Mode Dial

Guides appear on the monitor for 3 seconds (default setting) when the camera is switched on or the mode dial is turned.



Select [Off] for [Guide Display] in the [ Set-up 1 ] menu to not show indicators. (p.262)

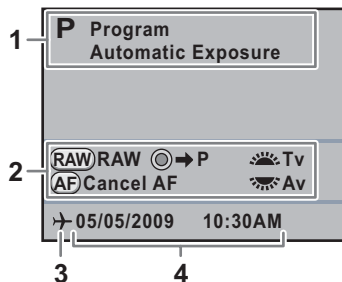

1 Exposure Mode (p.93)

2 Operation guide

3 World Time (p.258)

4 Date and Time (p.61)

\* 3 appears only when [World Time] is set to [Destination].



## Capture Mode

While shooting, the status screen is displayed showing the current shooting function settings.

### ● Status screen

(All of the indications are displayed here for explanatory purposes. The Actual display may differ.)

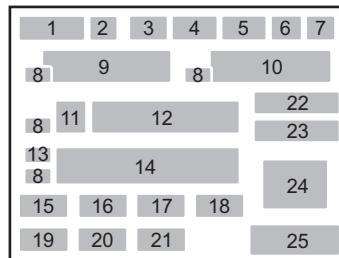
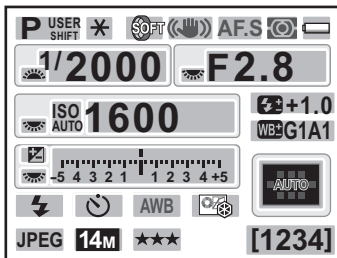

- |   |  |
|---|--|
| <ul style="list-style-type: none"> <li>1 Exposure Mode (p.93)</li> <li>2 AE Lock (p.116)</li> <li>3 Interval Shooting (p.144)/Multi-exposure (p.146)/Extended Bracketing (p.151)/Digital Filter (p.153)/HDR Capture (p.200)</li> <li>4 Shake Reduction (p.132)/Horizon Correction (p.133)</li> <li>5 Focus Mode (p.118)</li> <li>6 Metering Method (p.113)</li> <li>7 Battery level (p.46)</li> <li>8 E-dial guide</li> <li>9 Shutter speed</li> <li>10 Aperture</li> <li>11 ISO/ISO AUTO</li> <li>12 Sensitivity (p.90)</li> </ul> | <ul style="list-style-type: none"> <li>13 EV Compensation (p.115)/Exposure Bracketing (p.148)</li> <li>14 EV bar</li> <li>15 Flash Mode (p.72)</li> <li>16 Drive Mode (p.82)</li> <li>17 White Balance (p.191)</li> <li>18 Custom Image (p.205)</li> <li>19 File Format (p.188)</li> <li>20 JPEG Recorded Pixels (p.186)</li> <li>21 JPEG Quality (p.187)</li> <li>22 Flash Exposure Compensation (p.76)</li> <li>23 Adjust White Balance (p.193)</li> <li>24 AF point (p.122)</li> <li>25 Remaining image storage capacity</li> </ul> |
|---|--|

## ● Control panel

Press the **INFO** button in the status screen to display the control panel and change settings.

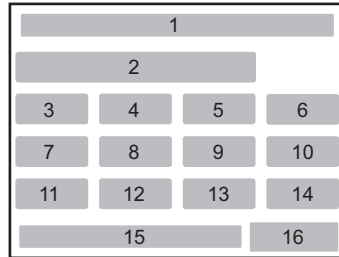
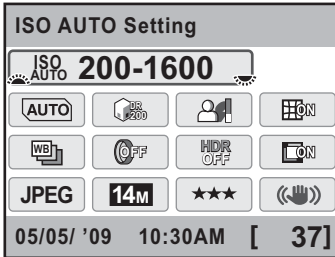

- |  |   |
|--|---|
| <ol style="list-style-type: none"> <li>1 Function name</li> <li>2 Sensitivity</li> <li>3 Program Line</li> <li>4 Highlight Correction</li> <li>5 Shadow Correction</li> <li>6 Distortion Correction</li> <li>7 Extended Bracketing</li> <li>8 Digital Filter</li> <li>9 HDR Capture</li> </ol> | <ol style="list-style-type: none"> <li>10 Lateral Chromatic Aberration Correction</li> <li>11 File Format</li> <li>12 JPEG Recorded Pixels</li> <li>13 JPEG Quality</li> <li>14 Shake Reduction</li> <li>15 Date and Time</li> <li>16 Remaining image storage capacity</li> </ol> |
|--|---|



- Items that cannot be changed due to the current camera setting status cannot be selected.
- The status screen will disappear if no operations are made within 30 seconds after pressing the **INFO** button.
- When [Status Screen] in the [📷 Rec. Mode 3] menu is set to [Off], the status screen is not displayed. The control panel turns on and off each time the **INFO** button is pressed.

## Playback Mode

The camera switches display information when you press the **INFO** button during playback.

Standard	Captured image and indicators are displayed.
Histogram display	Images and histogram (Brightness/RGB) are displayed.
Detailed information display	Detailed showing of how and when the images were taken is displayed.
No info. display	Only captured images are displayed.

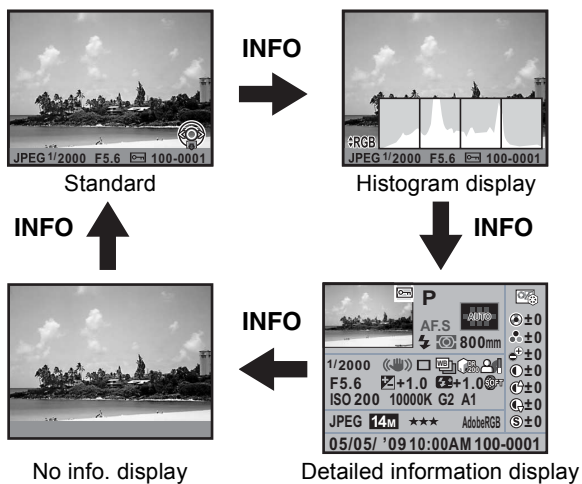

The information that is shown first during playback is the same as that of the last playback in the previous session. The [Standard] screen is displayed every time the camera is turned on by setting [Playback Display] to  (Off) in [Memory] (p.281) in the [Rec. Mode 4] menu.

## ● Detailed information display

Use the four-way controller (▲▼) to switch between pages.

### Page 1

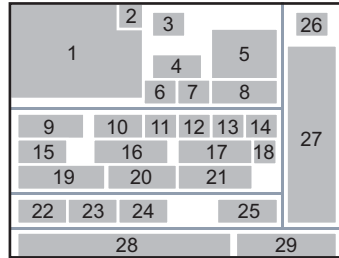
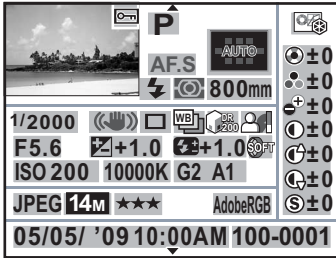

- |    |  |    |                             |
|----|--|----|-----------------------------|
| 1  | Captured image                                 | 15 | Aperture                    |
| 2  | Protect setting                                | 16 | EV Compensation             |
| 3  | Exposure Mode                                  | 17 | Flash Exposure Compensation |
| 4  | Focus Mode                                     | 18 | Digital Filter              |
| 5  | AF point                                       | 19 | Sensitivity                 |
| 6  | Flash Mode                                     | 20 | White Balance               |
| 7  | Metering Method                                | 21 | Adjust White Balance        |
| 8  | Lens focal length                              | 22 | File Format                 |
| 9  | Shutter speed                                  | 23 | JPEG Recorded Pixels        |
| 10 | Shake Reduction/Horizon Correction             | 24 | JPEG Quality                |
| 11 | Drive Mode                                     | 25 | Color Space                 |
| 12 | Extended Bracketing/HDR Capture/Multi-exposure | 26 | Image Tone                  |
| 13 | Highlight Correction                           | 27 | Custom Image parameters     |
| 14 | Shadow Correction                              | 28 | Shooting date/time          |
|    |  | 29 | Folder number-File number   |

\* Indicators 6 and 17 appear only for images in which the flash was discharged.

\* Indicators 12, 13, 14, 18, and 21 appear only for images taken with the corresponding functions enabled.

\* Indicators 23 and 24 do not appear for RAW images.

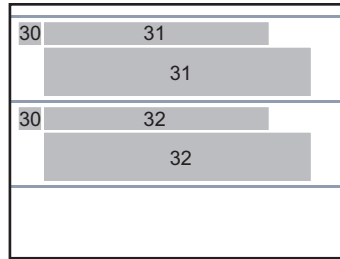

- 30** Information tampering warning  
**31** Photographer (p.277)

- 32** Copyright Holder (p.277)

## ● Movie

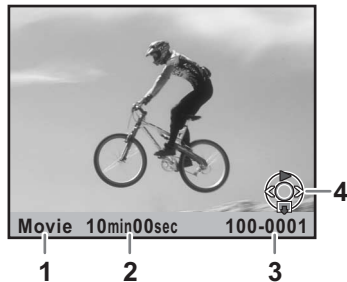

- 1** File Format  
**2** Playback time

- 3** Folder number-File number/  
Volume  
**4** Four-way controller guide

## ● Histogram Display

The following histograms can be displayed when playing back still pictures. The “Brightness histogram” shows the distribution of brightness and the “RGB histogram” shows the distribution of color intensity. Use the four-way controller (▲▼) to switch between Brightness histogram and RGB histogram.

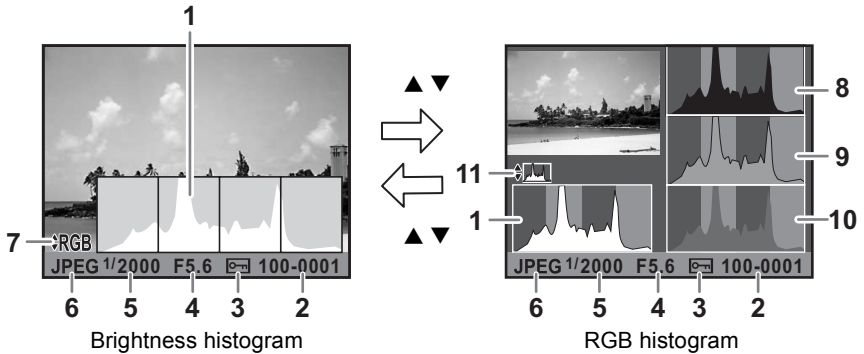

- |                             |  |
|-----------------------------|--|
| 1 Histogram (Brightness)    | 7 Color Space                                    |
| 2 Folder number-File number | 8 Histogram (R)                                  |
| 3 Protect setting           | 9 Histogram (G)                                  |
| 4 Aperture                  | 10 Histogram (B)                                 |
| 5 Shutter speed             | 11 Switch Brightness histogram/<br>RGB histogram |
| 6 File Format               |  |

\* Indicator 3 appears only for images with Protect setting.



Areas affected by bright or dark portions blink if [Bright/Dark Area] warning is set to  (On) in [Playback Display Method] in the [▶ Playback 1] menu. (p.215)

## Using the Histogram

A histogram shows the brightness distribution of an image. The horizontal axis represents brightness (dark at the left and bright at the right) and the vertical axis represents the number of pixels.

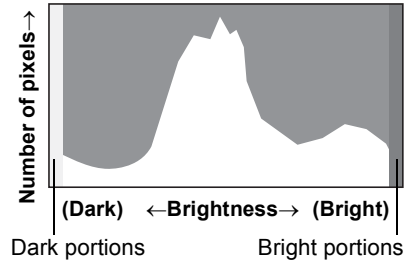

The shape and the distribution of the histogram before and after shooting tells you whether the exposure level and contrast are correct or not, and lets you decide if you need to use EV compensation and take a picture again.

- ☞ Adjusting the Exposure (p.115)
- ☞ Adjusting the Brightness (p.199)

## Understanding Brightness

When the brightness is correct and there are no overly light or dark areas, the graph peaks in the middle. If the image is too dark, the peak is on the left side, and if it is too bright, the peak is on the right side.

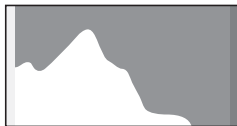

Dark image

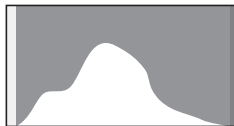
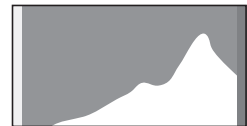

Image with few bright or dark areas



Bright image

When the image is too dark, the part to the left is cut off (dark portions with no detail) and when the image is too bright, the part to the right is cut off (bright portions with no detail).

Bright portions blink red on the monitor and dark portions blink yellow when [Bright/Dark area] is  (On).

- ☞ Playing Back Images (p.78)
- ☞ Setting the Display for Instant Review (p.263)

## Understanding Color Balance









Distribution of color intensity is displayed for each color in the RGB histogram. The right side of the graphs look similar for images that have white balance adjusted well. If only one color is lopsided to the left, that color is too intense.

☞ Setting the White Balance (p.191)

### Operation guide

The following indicators appear on the monitor to indicate the keys, buttons and e-dials that can be operated at that time.

Example:

▲	Four-way controller (▲)		<b>MENU</b> button
▼	Four-way controller (▼)		<b>OK</b> button
◀	Four-way controller (◀)		Green button
▶	Four-way controller (▶)		<b>AE-L</b> button
	Front e-dial		Trash button
	Rear e-dial		Shutter release button

### When holding the camera vertically

If the camera is held vertically while measuring the brightness, the control panel/status screen is displayed vertically. The directions of the four-way controller (▲▼◀▶) also change to match the orientation of the camera.





## Viewfinder

The following information appears in the viewfinder.

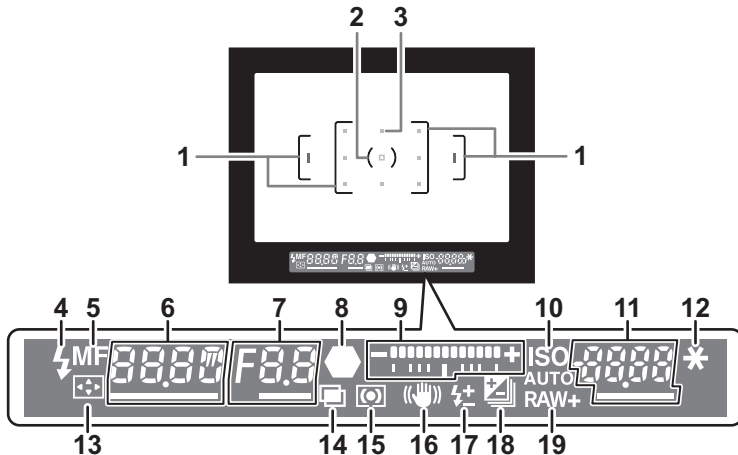

- 1 AF frame (p.55)
- 2 Spot metering frame (p.114)
- 3 AF point (p.122)
- 4 Flash status (p.72)  
Appears when flash is available.  
Blinks when flash is recommended but not set or is being charged.
- 5 Manual focus (p.126)  
Appears when the focus mode is set to **MF**.
- 6 Shutter speed  
Shutter speed when capturing or adjusting (underlined when shutter speed can be adjusted).
- 7 Aperture  
Aperture when capturing or adjusting (underlined when aperture can be adjusted).
- 8 Focus indicator (p.67)  
Appears continuously when image is focused.  
Blinks when the subject is not in focus.
- 9 EV bar (p.115, p.65)  
Shows the EV compensation values or difference between the appropriate and current exposure values when the exposure mode is set to **M**.  
Displays the camera angle when [Electronic Level] is  (On).
- 10 ISO/ISO AUTO  
Appears when the sensitivity is displayed.

- 11 Sensitivity  
Shows the number of recordable images immediately after shooting.
- 12 AE Lock (p.116)  
Appears during AE lock.
- 13 Move AF point (p.123)  
Appears when the AF point is being moved with the AF point switching dial set to **SEL** (Select).
- 14 Multi-exposure (p.146)  
Appears when Multi-exposure is set.
- 15 Metering Method (p.113)
- 16 Shake Reduction (p.132)  
Appears when the Shake Reduction function is activated.
- 17 Flash Exposure Compensation (p.76)  
Appears when the flash exposure compensation is in use.
- 18 EV Compensation (p.115)/Exposure Bracketing (p.148)  
Appears when EV compensation is available or in use.  
Appears when set to [Exposure Bracketing].
- 19 File Format (p.188)  
Displays the image save format in RAW/RAW+ format.  
Not displayed in JPEG format.



- The AF point in use for autofocus appears in red (superimposed) when the shutter release button is pressed halfway. (p.122)
- When [13. AF Button Function] is set to [Cancel AF] in the [C Custom Setting 2] menu, press the **AF** button to display **MF** in the viewfinder. (p.120)
- [9999] is the maximum number of recordable images that can be displayed in the viewfinder. Even if the number of recordable images is 10,000 or more, [9999] is displayed.

## LCD Panel

The following information appears in the LCD panel on top of the camera.

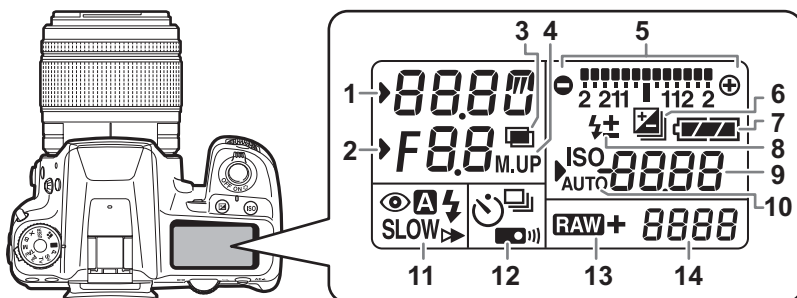

- |    |  |             |  |
|----|--|-------------|--|
| 1  | Shutter speed  | 👁           | : Red-eye reduction function is activated                        |
| 2  | Aperture   | <b>A</b>    | : Auto Flash Discharge   |
| 3  | Multi-exposure (p.146)   | <b>SLOW</b> | : Slow-speed Sync  |
| 4  | Mirror Lock-up shooting (p.141)  | ▶           | : Trailing Curtain Sync  |
| 5  | EV bar (p.115)/Electronic Level (p.65)   | <b>W</b>    | : Wireless   |
| 6  | EV Compensation (p.115)/Exposure Bracketing (p.148)                                    | 12          | Drive Mode (p.82)  |
| 7  | Battery level (p.46)   | □           | : Single Frame Shooting  |
| 8  | Flash Exposure Compensation (p.76)   | 📷           | : Continuous Shooting  |
| 9  | Sensitivity/ISO compensation value   | ⌚           | : Self-Timer shooting  |
| 10 | ISO/ISO AUTO<br>Appears when sensitivity is displayed.                                 | 📡           | : Remote Control shooting  |
| 11 | Flash Mode (p.72)<br>⚡ : Built-in flash is ready (when blinking, flash should be used) | 13          | File Format (p.188)  |
|    |  | <b>RAW</b>  | : RAW capture  |
|    |  | <b>RAW+</b> | : RAW+JPEG capture   |
|    |  | 14          | Remaining image storage capacity/<br>USB connection mode (p.275) |
|    |  | <b>Pc-S</b> | : MSC mode   |
|    |  | <b>Pc-P</b> | : PTP mode   |



LCD panel is illuminated when the exposure metering is performed. You can set it to not illuminate in [29. LCD Panel Illumination] in the [C Custom Setting 5] menu (p.87).

# How to Change Function Settings

Function settings can be changed using the direct keys, the control panel or the menu. Some functions can be changed using both the control panel and menu.

This section explains the basic ways to change function settings.

## Using the Direct Keys

By pressing the four-way controller (▲▼◀▶) in Capture mode you can set [Drive Mode], [Flash Mode], [White Balance] and [Custom Image]. (p.82)

Below, how to set to the flash mode will be explained as an example.

- 1 Press the four-way controller (▼) in Capture mode.

The [Flash Mode] screen appears.

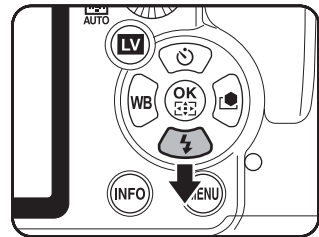

- 2 Use the four-way controller (◀▶) to select a flash mode.

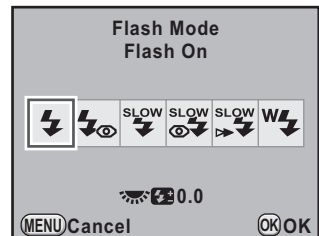

- 3 Press the OK button.

The camera is ready to take a picture.

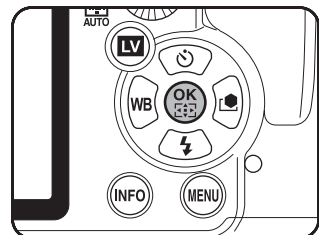

## Using the Control Panel

While shooting, the current settings can be checked on the status screen. You can also switch the display to the control panel and change settings. Following, how to set the JPEG quality will be explained as an example.

### 1 Check the status screen and then press the **INFO** button.

The control panel appears.

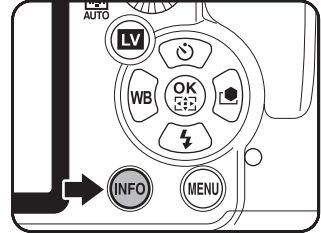

Press the **INFO** button if the status screen is not displayed.

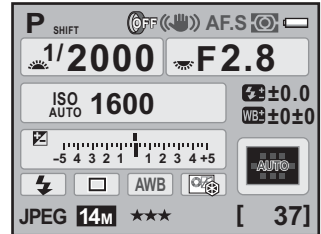

### 2 Use the four-way controller (▲▼◀▶) to select an item you want to change the setting for.

You cannot select an item that cannot be changed.

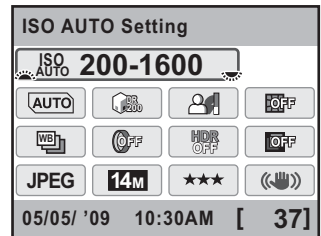

### 3 Use the front e-dial (☀) or rear e-dial (☀) to change the setting.

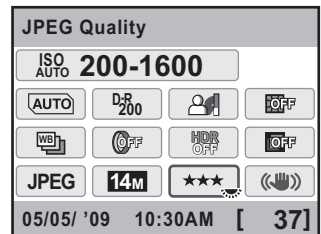

## 4 Press the **MENU** button.

The camera returns to the status screen and is ready to take a picture.

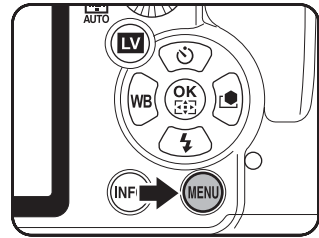

- Press the **OK** button in Step 3 on p.35 to display the setting screen for the selected item. Use the setting screen to set the settings for [Extended Bracketing], [Digital Filter] and other items.
- The status screen and control panel are not displayed when Live View (p.156) is displayed. Make the settings in the [📷 Rec. Mode] menu.

## Using the Menus

This section explains operation methods for the [📷 Rec. Mode], [▶ Playback], [⚙ Set-up] and [⚙ Custom Setting] menus. Following, how to set [Program Line] in the [📷 Rec. Mode 2] menu will be explained as an example.

## 1 Press the **MENU** button in Capture mode.

The [📷 Rec. Mode 1] menu appears on the monitor.

If the **MENU** button is pressed in Playback mode, the [▶ Playback 1] menu appears.

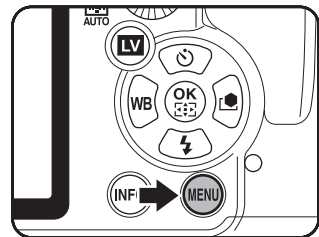

## 2 Press the four-way controller (▶) or turn the rear e-dial (☀) to the right (toward Q).

Each time the four-way controller (▶) is pressed, the menu will change in the following sequence: [📷 Rec. Mode 2], [📷 Rec. Mode 3], [📷 Rec. Mode 4], [▶ Playback 1] ... [📷 Rec. Mode 1].

When the front e-dial (☀) is turned to the right, the menu will change in the following sequence: [📷 Rec. Mode 1], [▶ Playback 1], [🔧 Set-up 1], [C Custom Setting 1].

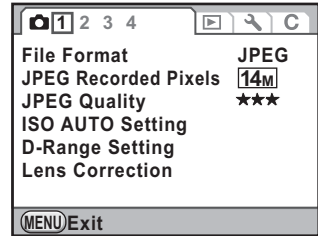

## 3 Use the four-way controller (▲▼) to choose an item.

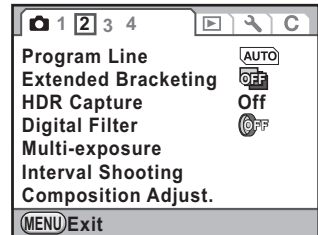

## 4 Press the four-way controller (▶).

Available settings are displayed. Use the pop-up menu if there is one.

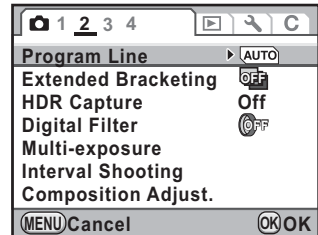

## 5 Use the four-way controller (▲▼) to select a setting.

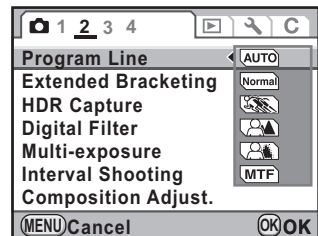

## 6 Press the OK button.

The camera returns to the menu screen. Next, set other items.

Press the **MENU** button to exit the menu and the screen that was displayed before selecting the menu appears again.

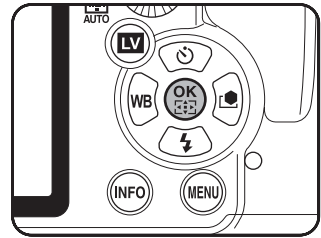

Even after you press the **MENU** button and close the menu screen, your settings will not be saved if the camera is turned off improperly (such as by removing the battery while the camera is on).



Refer to the following pages for details on each menu item.

- [📷 Rec. Mode] menu 📖 p.83
- [📺 Playback] menu 📖 p.213
- [⚙️ Set-up] menu 📖 p.254
- [C Custom Setting] menu 📖 p.85



You can switch the exposure modes by setting the icons on the mode dial to the dial indicator.

Turn the mode dial while pressing the mode dial lock button.

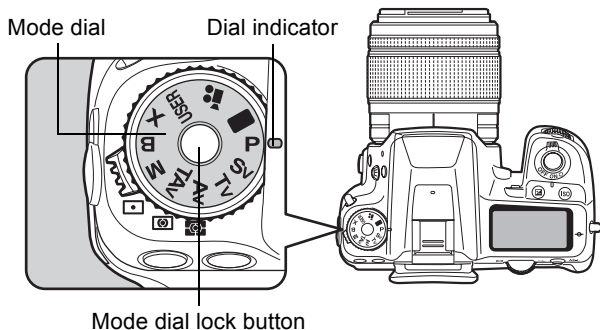

Mode	Characteristics	Page
<b>USER</b> (USER)	Lets you capture images with the saved Capture mode.	p.207
 (Green)	Lets you capture images with fully automatic settings.	p.95
<b>P</b> (Hyper-program)	Automatically sets the shutter speed and aperture to the proper exposure according to Program Line when taking pictures. You can use the front and rear e-dials to switch to shutter priority or aperture priority.	p.96
<b>Sv</b> (Sensitivity Priority)	Automatically sets the shutter speed and aperture to the proper exposure according to the set sensitivity.	p.98
<b>Tv</b> (Shutter Priority)	Lets you set the desired shutter speed for expressing moving subjects.	p.100
<b>Av</b> (Aperture Priority)	Lets you set the aperture for controlling the depth of field.	p.102
<b>TA</b> (Shutter & Aperture Priority)	Automatically sets the sensitivity so that the manually set shutter speed and aperture will give the proper exposure according to the brightness of the subject.	p.104
<b>M</b> (Hyper-manual)	Lets you set shutter speed and aperture to capture the picture with creative intent.	p.107

Mode	Characteristics	Page
<b>B</b> (Bulb)	Lets you capture images that require slow shutter speeds such as fireworks and night scenes.	p.110
<b>X</b> (Flash X-sync Speed)	The shutter speed is locked at 1/180 seconds. Use this when using an external flash that does not automatically change the shutter speed.	p.112
 (Movie)	Use this to record movies.	p.163

# 2 Getting Started

---

This chapter explains your first steps from purchasing the camera to taking pictures. Be sure to read it and follow the instructions.

<b>Attaching the Strap .....</b>	<b>42</b>
<b>Using the Battery .....</b>	<b>43</b>
<b>Inserting/Removing the SD Memory Card .....</b>	<b>49</b>
<b>Attaching the Lens .....</b>	<b>53</b>
<b>Adjusting the Viewfinder Diopter .....</b>	<b>55</b>
<b>Turning the Camera On and Off .....</b>	<b>56</b>
<b>Initial Settings .....</b>	<b>57</b>

# Attaching the Strap

2

Getting Started

- 1 Pass the end of the strap through the protective cover and triangular ring.

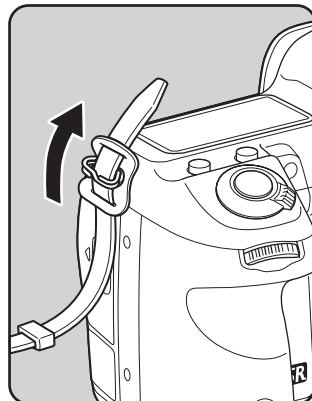

- 2 Secure the end of the strap on the inside of the clasp.

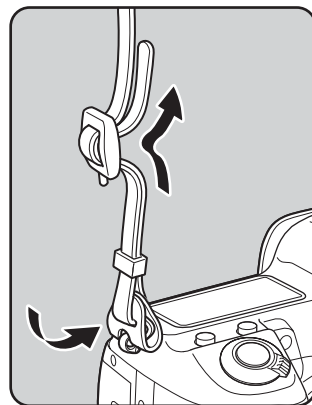
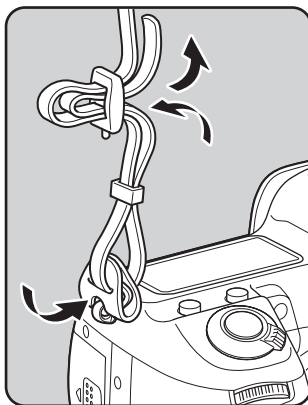

- 3 Attach the other end of the strap in the same manner as described above.

Insert the battery into the camera. Use only a D-LI90 battery.

## Charging the Battery

When using the battery for the first time, or when the battery has not been used in a long time, or when [Battery depleted] appears, recharge the battery.

**Note:** AC plug cord “Listed, Type SPT-2 or NISPT-2, 18/2 flexible cord, rated 125 V, 7A, minimum 6ft (1.8m)”

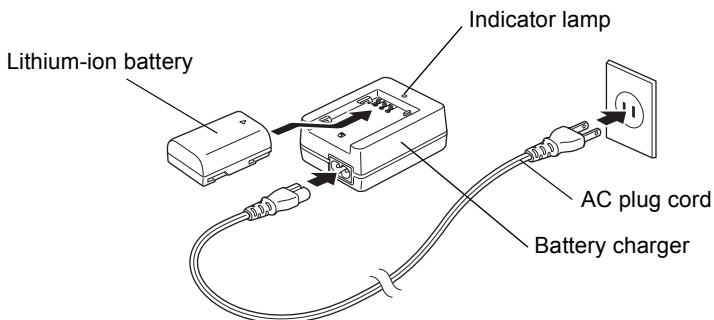

- 1** Connect the AC plug cord to the battery charger.
- 2** Plug the AC plug cord into the power outlet.
- 3** Face the ▲ mark on the exclusive battery up and insert it into the battery charger.  
The indicator lamp is lit during charging.  
The indicator lamp turns off when the battery is fully charged.
- 4** When the battery is fully charged, remove the battery from the battery charger.



- Do not use the provided battery charger to charge batteries other than rechargeable lithium-ion battery D-LI90. Charging other batteries may cause damage or heating.
- If the battery is correctly oriented and inserted into the battery charger but the indicator lamp is not lit, the battery is faulty. Install a new battery in the camera.



- The maximum charging time is approximately 390 minutes. Charge in a location where the temperature is between 0°C and 40°C. (Charge time depends on temperature and remaining battery power.)
- If usage time is reduced even when properly charged, the battery has reached the end of its usage span. Install a new battery in the camera.

## Inserting/Removing the Battery

When using the battery for the first time, charge the battery and insert it into the camera.



- Do not open the battery cover or remove the battery while the power is on.
- Remove the battery when you will not use the camera for a long while. The battery may leak.
- If the date and time settings have been reset when you insert a new battery after a long time, follow the procedure for [Setting the Date and Time]. (p.61)
- Insert the battery correctly. If the battery is inserted incorrectly, it may cause camera breakdown. Wipe the electrodes of the battery with a soft dry cloth before inserting.
- Be careful as the camera or battery may become hot when the camera is used continuously for a long period of time.

### 1

### Open the battery cover.

Lift the battery cover unlock knob, turn towards OPEN (①) to unlock, and then pull the cover open (②).

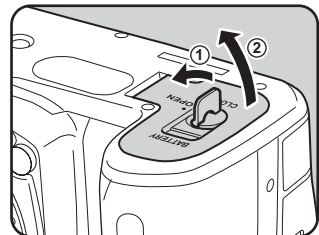

- 2** Face the ▲ mark on the battery towards the outside of the camera, push the battery lock lever in the direction of the arrow (③) and insert the battery.

Insert until the battery locks.

To remove the battery, push the battery lock lever in the direction of the arrow (③) with your hand. Remove the battery when it pops out slightly.

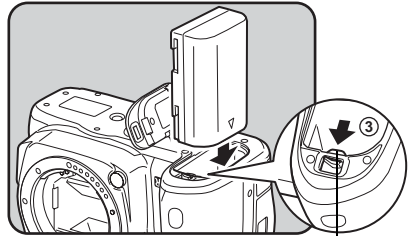

Battery lock lever



- 3** Close the battery cover (④) and turn the battery cover unlock knob towards CLOSE (⑤) to lock.

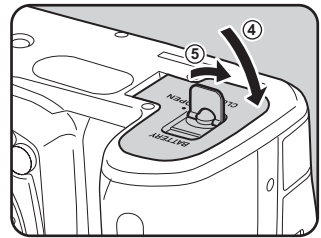









Stow the battery cover unlock knob after closing the battery cover.











Use the AC adapter kit K-AC50 (optional) when using the camera for a prolonged period. (p.47)

## Battery Level Indicator

You can confirm remaining battery level by checking the / displayed on the status screen and LCD panel.

Status screen	LCD panel	Battery level
 (Green)		Battery is full.
 (Green)		Battery is close to full.
 (Yellow)		Battery is running low.
 (Red)	 lit	Battery is almost empty.
"Battery depleted"	 blinks	The camera turns off after displaying the message. (  continues blinking on the LCD panel.)



- , ,  or  may appear even when the battery level is sufficient if the camera is used at low temperatures or when performing continuous shooting consecutively. In this sort of case, turn the camera off and on again. If  or  appears, you can use the camera.
-  and  are not displayed when using the AC adapter.

## Approximate Image Storage Capacity and Playback Time (Battery Fully Charged)

Battery (Temperature)	Normal recording	Flash photography		Playback time
		50% use	100% use	
D-LI90 (23°C)	980	740	610	440 minutes
(0°C)	810	680	560	400 minutes

The picture storage capacity (flash use 50%) is based on measuring conditions in accordance with CIPA standards and the others are based on our measuring conditions. Some deviation from the above figures may occur in actual use depending on shooting mode and shooting conditions.





- Battery performance temporarily decreases as the temperature decreases. When using the camera in cold climates, have extra batteries on hand and keep them warm in your pocket. Battery performance will return to normal when returned to room temperature.
- Have extra batteries ready when traveling overseas, taking pictures in cold climates, or when you will be taking a lot of pictures.
- If usage time is reduced even when properly charged, the battery has reached the end of its usage span. Install a new battery in the camera.

## Using the AC Adapter (Optional)

We recommend using the AC adapter kit K-AC50 (optional) when using the monitor for a long time or when connecting to your PC or AV device.

**1** Make sure that the camera is turned off.

**2** Open the terminal cover.

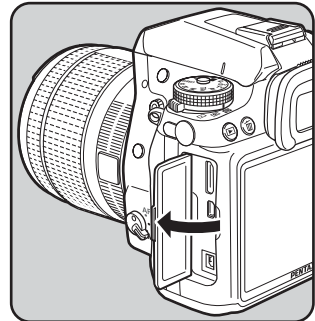

**3** Face the ▲ mark on the DC terminal of the AC adapter towards the ▲ mark on the camera, and connect the DC terminal to the DC input terminal of the camera.

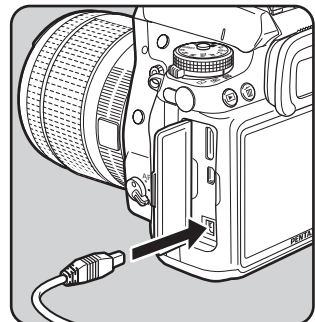

---

## 4 Connect the AC plug cord to the AC adapter.

---

## 5 Plug the AC cord into the power outlet.



- Make sure the camera is turned off before connecting or disconnecting the AC adapter.
- Make sure connections are secure between the terminals. SD Memory Card and data will be corrupted if disconnected while the camera is recording or reading data.



- Be sure to read the AC adapter kit K-AC50 Operating Manual when using the AC adapter.
- The battery in your camera will not charge when connected to the AC adapter.

# Inserting/Removing the SD Memory Card

This camera uses either an SD Memory Card or an SDHC Memory Card. (Both cards are referred to as SD Memory Cards hereafter.) Make sure the camera is turned off before inserting or removing the SD Memory Card (commercially available).



- Do not remove the SD Memory Card while the card access lamp is lit.
- Use this camera to format (initialize) an SD Memory Card that is unused or has been used on other cameras or digital devices. Refer to “Formatting the SD Memory Card” (p.256) for details on formatting.
- Use a high-speed memory card when recording movies. If the write speed cannot keep up with the recording speed, the writing may stop during recording.

**1** Make sure that the camera is turned off.

**2** Slide the card cover in the direction of the arrow (①) and then lift it to open (②).

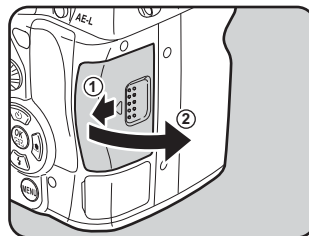

**3** Insert the card all the way with the SD Memory Card label toward the monitor.

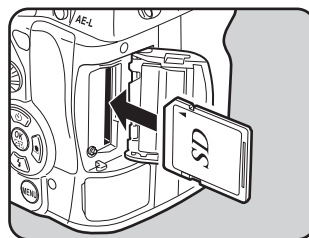

Push the SD Memory Card in once to remove.

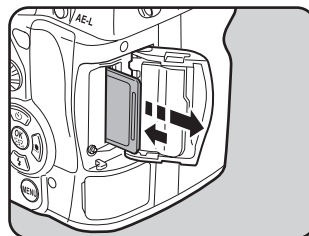

- 4** Close the card cover (③) and then slide it in the direction of the arrow (④).

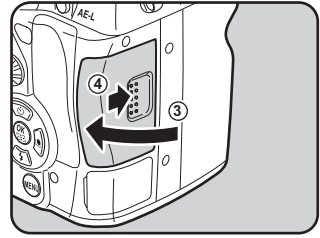

Be sure to fully close the card cover. The camera will not turn on if the card cover is open.

### Precautions When Using the SD Memory Card

- The SD Memory Card is equipped with a write-protect switch. Setting the switch to LOCK prevents new data from being recorded on the card, the stored data from being deleted, and the card from being formatted by the camera or computer.
- Care should be taken when removing the SD Memory Card immediately after using the camera because the card may be hot.
- Do not remove the SD Memory Card or turn the camera off while images are being played back or saved to the card, or the camera is connected to a computer with the USB cable. This may cause the data to be lost or the card to be damaged.
- Do not bend the SD Memory Card or subject it to violent impact. Keep it away from water and store away from high temperatures.
- Do not remove the SD Memory Card while formatting. The card may be damaged and become unusable.
- Data on the SD Memory Card may be deleted in the following circumstances. We do not accept any liability for data that are deleted if
  - (1) the SD Memory Card is mishandled by the user.
  - (2) the SD Memory Card is exposed to static electricity or electrical interference.
  - (3) the SD Memory Card has not been used for a long time.
  - (4) the SD Memory Card is ejected or the battery is removed while the data on the card are being recorded or accessed.
- If it is not used for a long time, the data on the card may become unreadable. Be sure to regularly make a backup of important data on a computer.
- Avoid using or storing the card where it may be exposed to static electricity or electrical interference.

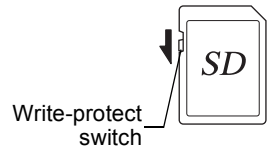

- Avoid using or storing the card in direct sunlight or where it may be exposed to rapid changes in temperature or to condensation.
- Format new SD Memory Cards. Also format SD Memory Cards used with other cameras.
  - ☞ Formatting the SD Memory Card (p.256)
- Please note that formatting the SD Memory Card will not necessarily delete the data so that they cannot be recovered using off the shelf data recovery software. If you are going to discard, give away or sell your SD Memory Card you should ensure that the data on the card are completely deleted or the card itself is destroyed if it contains any personal or sensitive information. There are off the shelf secure data deletion software programs available that will completely delete the data.  
In any case the data on your SD Memory Card should be managed at your own risk.

## Recorded Pixels and Quality Level

### When the File Format is JPEG

Choose the number of pixels (size) and quality level (JPEG data compression rate) of pictures according to how you intend to use the pictures you have taken.

Pictures with larger recorded pixels or more ★s are clearer when printed. The number of pictures that can be taken (the number of pictures that can be recorded on an SD Memory Card) decreases with larger file sizes. The quality of the captured photo or printed picture depends on the quality level, exposure control, resolution of the printer and a variety of other factors so you do not need to select more than the required number of pixels. For example, to print in postcard size, **2M** (1728×1152) is adequate. Set the appropriate recorded size and quality level depending on purpose.

Choose the appropriate number of recorded pixels and quality level for JPEG images in the [ Rec. Mode 1] menu or on the control panel.

- ☞ Setting the JPEG Recorded Pixels (p.186)
- ☞ Setting the JPEG Quality Level (p.187)

## ● JPEG Recorded Pixels, JPEG Quality and Approximate Image Storage Capacity

(When using a 1 GB SD Memory Card)

JPEG Quality JPEG Rec. Pixels	★★★★ Premium	★★★ Best	★★ Better	★ Good
<b>14M</b> (4672×3104)	73	117	206	408
<b>10M</b> (3936×2624)	102	163	289	564
<b>6M</b> (3072×2048)	167	267	468	902
<b>2M</b> (1728×1152)	516	805	1373	2518

- The number of storable images may vary depending on the subject, shooting conditions, shooting mode and SD Memory Card, etc.



When the number of storable images exceeds 500, captured images are divided into folders of 500 images each. However, in Auto Bracket, images will be stored in the same folder until shooting is completed, even if the number of images exceeds 500.

### When the File Format is RAW

With the **K-7**, you can record in the versatile JPEG format or the high quality and editable RAW format. For RAW file format, you can select the PENTAX original PEF format or general-purpose DNG (Digital Negative) format designed by Adobe Systems. On a 1 GB SD Memory Card, you can record up to 40 images in PEF format or DNG format.

- ☛ Setting the File Format (p.188)

Attach a proper lens to the camera's body.

When you use one of the following lenses with the **K-7**, all the camera's exposure modes will be available.

- (a) DA, DA L, D FA, FA J lenses
- (b) Lenses with an Aperture **A** (Auto) position, when used in the **A** position



Turn the camera off before attaching or removing the lens to prevent unexpected lens movement.



- When lenses described in (b) are used in a position other than **A**, some functions will be restricted. See "Notes on [37. Using Aperture Ring]" (p.294).
- With factory default settings, the camera will not work with other lenses and accessories. Set [37. Using Aperture Ring] in the [C Custom Setting 6] menu to [Permitted] to use them. (p.294)

**1**

**Make sure that the camera is turned off.**

**2**

**Remove the body mount cover (①) and lens mount cover (②).**

Be sure to put the lens down with the lens mount side facing upward to protect the lens mount from damage after removal.

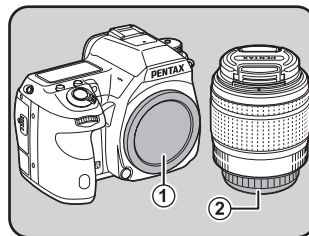
**3**

**Align the Lens mount index (red dots; ③) on the camera and the lens, and secure by turning the lens clockwise until it clicks.**

After attaching, turn the lens counterclockwise to check that the lens is locked in place.

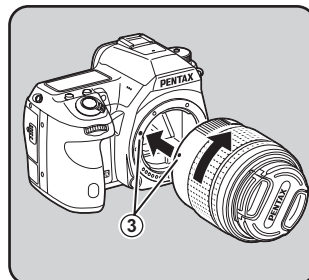

- 4** Remove the front lens cap by pushing the indicated portions inward.

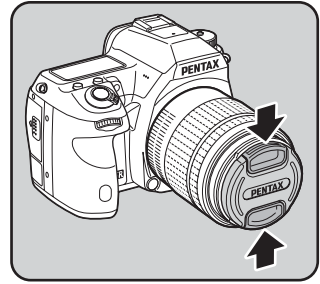

To detach the lens, hold down the lens unlock button (④) and turn the lens counterclockwise.

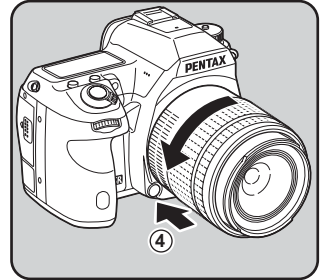

- We assume no responsibility nor liability for accidents, damages and malfunctions resulting from the use of lenses made by other manufacturers.
- The camera body and lens mount incorporate lens information contacts and an AF coupler. Dirt, dust, or corrosion may damage the electrical system. When necessary, clean the contacts with a soft dry cloth.



The body mount cover (①) is a cover to prevent scratches and block dust when shipped. Body Mount Cap K is sold separately and has a lock function. (p.304)



Adjust the viewfinder to suit your eyesight.

If it is difficult to see the viewfinder image clearly, slide the diopter adjustment lever sideways.

You can adjust the diopter from approximately  $-2.5$  to  $+1.5$  m<sup>-1</sup>.

## 1 Look through the viewfinder and slide the diopter adjustment lever left or right.

Adjust the lever until the AF frame in the viewfinder appears sharply focused.

Point the camera at a white wall or other bright and consistent surface.

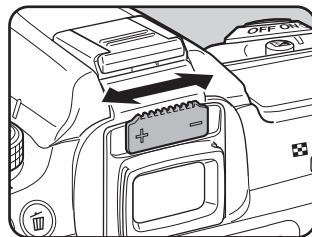

AF frame



- The Eyecup FR is attached to the viewfinder portion when the camera leaves the factory. Diopter adjustment is available with the Eyecup FR attached. However, adjustment is easier with the eyecup removed.

- To remove the Eyecup FR, press in one side and pull it out in the direction of the arrow.

To attach the Eyecup FR, align it with the groove on the viewfinder eyepiece and push it into position.

- If it is difficult to see the viewfinder image clearly even if you set the diopter adjustment lever, use an optional diopter correction lens adapter M. However, the Eyecup FR must be removed to use this adapter. (p.302)

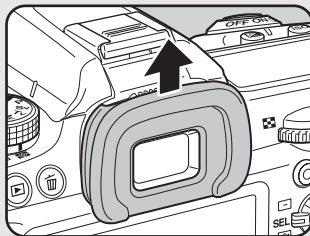



## 1 Turn the main switch to [ON].

The camera will turn on.

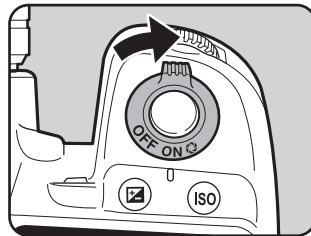
Set the main switch to the position [OFF] to turn off the camera.



- Always turn the camera off when not in use.
- The power will automatically turn off when you do not perform any operations within a set period of time. To reactivate the camera after it turns off automatically, turn it on again or perform any of the following.
  - The shutter release button is pressed halfway
  - The  button is pressed
  - The **INFO** button is pressed
- By default, the camera is set to power off automatically after 1 minute of inactivity. You can change the setting in [Auto Power Off] in the [ Set-up 3] menu. (p.270)

The first time the camera is turned on after purchasing, the [Language/言語] screen appears on the monitor. Follow the procedure below to set the language displayed on the monitor and the current date and time. Once setting is done, these will not need to be set again when turning your camera on.

If the [Date Adjustment] screen appears, set the date and time by following the procedure in "Setting the Date and Time" (p.61).

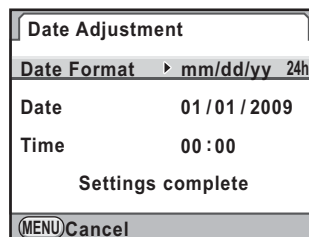

## Setting the Display Language

You can choose the language in which the menus, error messages, etc. are displayed from the following: English, French, German, Spanish, Portuguese, Italian, Dutch, Danish, Swedish, Finnish, Polish, Czech, Hungarian, Turkish, Greek, Russian, Korean, Chinese (traditional/simplified) and Japanese.

- 1 Use the four-way controller (▲▼◀▶) to select the desired language.**



## 2 Press the OK button.

The [Initial Setting] screen for the selected language appears.

Press the four-way controller (▼) twice and proceed to Step 10 on p.59 if [Hometown] does not have to be changed.

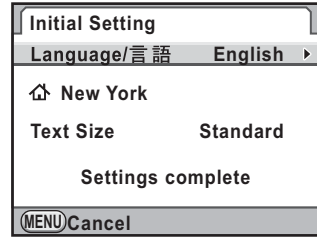

## 3 Press the four-way controller (▼).

The cursor moves to ↕.

## 4 Press the four-way controller (▶).

The [↕ Hometown] screen appears.

## 5 Use the four-way controller (◀▶) to select a city.

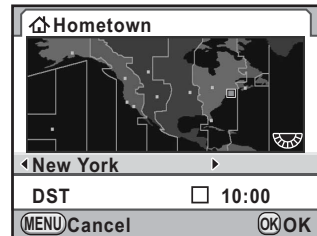

## 6 Press the four-way controller (▼).

The cursor moves to [DST] (daylight saving time).

## 7 Use the four-way controller (◀▶) to select or .

## 8 Press the OK button.

The camera returns to the [Initial Setting] screen.

## 9 Press the four-way controller (▼).

The cursor moves to [Text Size].

- 10** Press the four-way controller (▶) and use the four-way controller (▲▼) to select [Standard] or [Large].

Selecting [Large] magnifies the selected menu item.

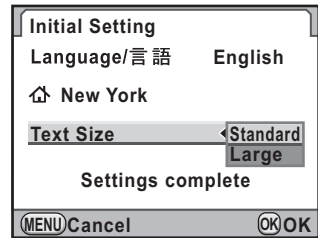

- 11** Press the OK button.

- 12** Use the four-way controller (▼) to select [Settings complete].

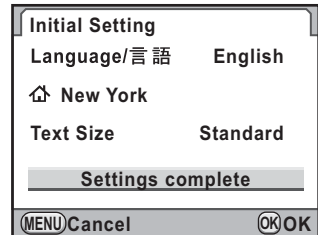

- 13** Press the OK button.

The [Date Adjustment] screen appears.



In this manual, the menu screens hereafter are described with [Text Size] set to [Standard].

## When an Incorrect Language is Set

When you mistakenly select a language in the [Language/言語] screen and proceed to the [Date Adjustment] screen, you can perform the following operations to set the correct language.

If you have proceeded to switch the camera to Capture mode (and the camera is ready to take a picture), perform the following operations from Step 2 to set the correct language.

### 1 Press the MENU button once to display the guides on the monitor.

The screen shown on the right is an example of the guides displayed. The displayed screen will vary depending on the selected language.

The guides appear on the monitor for 3 seconds.



### 2 Press the MENU button once.

[ 1] is displayed in the upper tab.

### 3 Press the four-way controller (▶) five times.

[ 1] is displayed in the upper tab.

### 4 Press the four-way controller (▼) to select [Language/言語].

### 5 Press the four-way controller (▶).

The [Language/言語] screen appears.

### 6 Use the four-way controller (▲▼◀▶) to select a desired language and press the OK button.

The [ Set-up 1] menu in the selected language appears.

Refer to the following pages and set the desired city for [Hometown] and the current date and time as necessary.

- To change the hometown: "Setting the World Time" (p.258)
- To change the date and time: "Changing the Date Display" (p.258)



- When the hometown and the date and time are not set, the [Initial Setting] screen or [Date Adjustment] screen will be displayed when the camera is turned on again.
- If you have not proceeded to the [Date Adjustment] screen, you can reselect a language using the four-way controller (▶) in the [Language/言語] screen.

## Setting the Date and Time

Set the current date and time and the display style.

### 1 Press the four-way controller (▶).

The frame moves to [mm/dd/yy].

### 2 Use the four-way controller (▲▼) to choose the date format.

Choose [mm/dd/yy], [dd/mm/yy] or [yy/mm/dd].

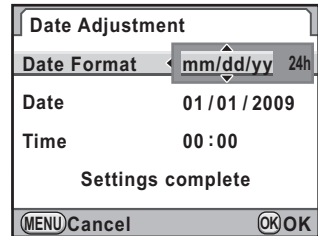

### 3 Press the four-way controller (▶).

The frame moves to [24h].

### 4 Use the four-way controller (▲▼) to select 24h (24-hour display) or 12h (12-hour display).

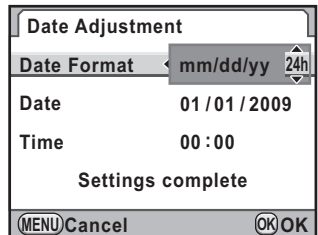

### 5 Press the four-way controller (▶).

The frame returns to [Date Format].

## 6 Press the four-way controller (▼).

The frame moves to [Date].

## 7 Press the four-way controller (▶).

The frame moves to the month.

## 8 Use the four-way controller (▲▼) to set the month.

Set the day and year in the same manner.

Next, set the time.

If you select [12h] in Step 4, the setting switches between am and pm depending on the time.

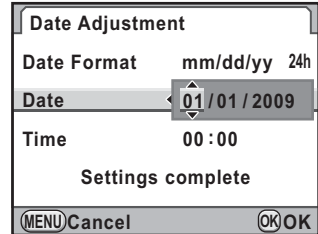

## 9 Use the four-way controller (▼) to select [Settings complete].

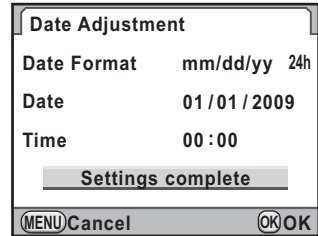

## 10 Press the OK button.

The camera returns to the status screen and is ready to take a picture.

If you set the date and time with the menu operations, the screen will return to the [Set-up 1] menu. In this case, press the **MENU** button.



Pressing the **MENU** button while adjusting the date and time cancels the settings made so far and switches the camera to Capture mode. If the power is turned on without the date and time set, the [Date Adjustment] screen is displayed if the initial settings have been completed. You can also set the date and time later by menu operations. (p.258)



- When you press the **OK** button in Step 10, the camera clock is reset to 00 seconds. To set the exact time, press the **OK** button when the time signal (on the TV, radio, etc.) reaches 00 seconds.
- You can change the language and the date and time settings with the menu operations. (p.258, p.261)



# 3 Basic Operations

---

This chapter explains basic operations for shooting by setting mode dial to Green mode (automatic exposure according to the program line set to **AUTO**) to ensure successful capturing.

For information about advanced functions and settings for taking pictures, refer to chapter 4 and onward.

<b>Basic Shooting Operation .....</b>	<b>64</b>
<b>Using a Zoom Lens .....</b>	<b>71</b>
<b>Using the Built-in Flash .....</b>	<b>72</b>
<b>Playing Back Images .....</b>	<b>78</b>

## Holding the Camera

How you hold the camera is important when taking pictures.

- Hold the camera firmly with both hands and keep your elbows close to your body.
- Press the shutter release button gently when taking a picture.

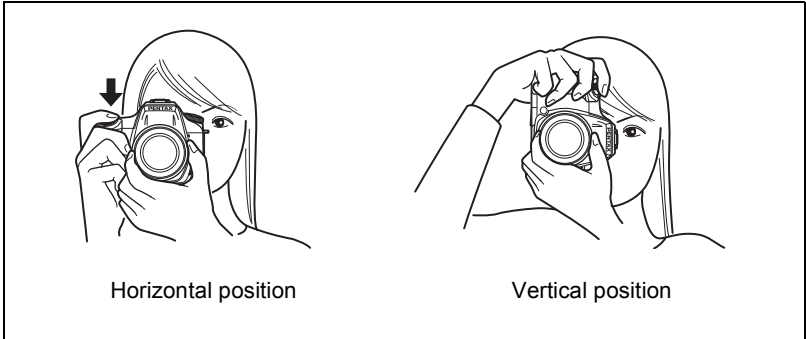

- To reduce camera shake, support your body or the camera on a solid object such as a table, tree, or wall.
- Although there are individual differences among photographers, the shutter speed for a handheld camera is generally  $1/(\text{focal length} \times 1.5)$ . For example, it is  $1/75$  of a second for a focal length of 50 mm and  $1/150$  of a second for 100 mm. Use a tripod or the Shake Reduction function (p.132) when using a lower shutter speed.
- When using a telephoto lens, a tripod that is heavier than the total weight of the camera and lens is recommended to avoid camera shake.
- Do not use the Shake Reduction function when using the camera on a tripod. (p.132)

## When the Camera is not Level

This camera is equipped with an electronic level for detecting whether the camera is level. When the camera is not level, this is indicated on the bar graph in the viewfinder and on the LCD panel. This is useful when holding the camera.

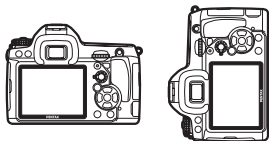

When level (at 0°)



When tilted 5° to the left



When held vertically and tilted 3° to the right



[Electronic Level] is  (Off) by default. Set in the [📷 Rec. Mode 3] menu. (p.266)

The composition can also be adjusted in the camera when the camera is stabilized using a tripod. (p.203)

## Letting the Camera Choose the Optimal Settings

The **K-7** features various capture modes, focus modes, and drive modes for expressing your photographic vision. This section explains how to take pictures by simply pressing the shutter release button.

### 1 Set the mode dial to **■**.

Turn the mode dial while pressing the mode dial lock button.

The exposure mode changes to **■** (Green) mode. In **■**, the proper exposure is determined by the camera and the shutter speed and aperture are automatically set.

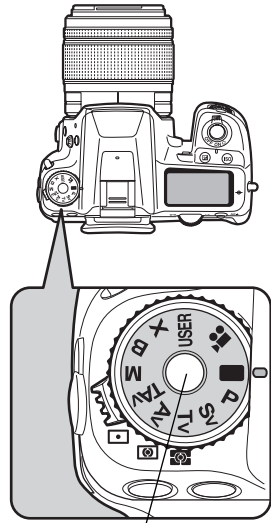

Mode dial lock button

### 2 Set the focus mode lever to **AF.S**.

The focus mode changes to **AF.S** (Autofocus/Single) mode. In **AF.S**, the lens automatically focuses when the shutter release button is pressed halfway. When the image is focused, the shutter can be released. (p.118)

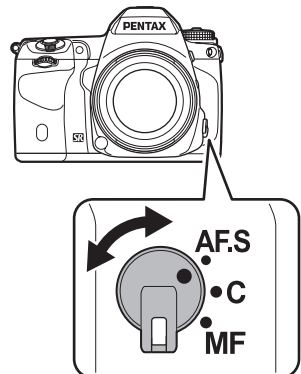



### 3 Look through the viewfinder to view the subject.

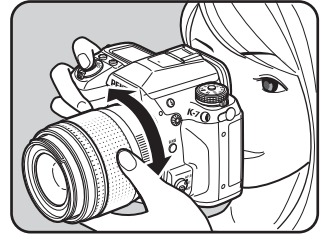



A zoom lens can be used to change the size of the subject in the viewfinder. (p.71)



### 4 Position the subject inside the AF frame and press the shutter release button halfway.

The autofocus system operates. The focus indicator  appears in the viewfinder when focused.

AF assist light turns on in a dark or backlit location, but the flash does not pop up automatically. If the flash is necessary, the flash status  blinks in the viewfinder. Press the  button to pop up the flash.

-  Operating the shutter release button (p.69)
-  Subjects that are Difficult to Focus on (p.70)
-  Using the Built-in Flash (p.72)
-  Selecting the Focusing Area (AF Point) (p.122)

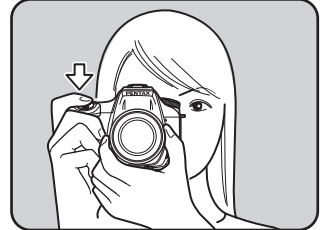

Flash status

Focus indicator

### 5 Press the shutter release button fully.

The picture is taken.





## 6

## Review the captured image on the monitor.

The image appears for 1 second on the monitor shortly after capturing (Instant Review).

- Setting the Display for Instant Review (p.263)

You can magnify the image during Instant Review with the rear e-dial (  ). (p.214)

You can delete the image during Instant Review by pressing the  button. (p.79)

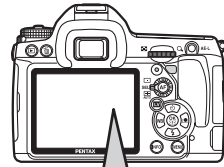

- For details on using  (Green) mode, see p.95.
- You can set the camera so that pressing the **AF** button will focus automatically, in the same way as pressing the shutter release button halfway. (p.120)
- You can preview the image on the monitor and check composition, exposure, and focus before taking pictures. (p.129)

## Operating the shutter release button

The shutter release button has two working positions.

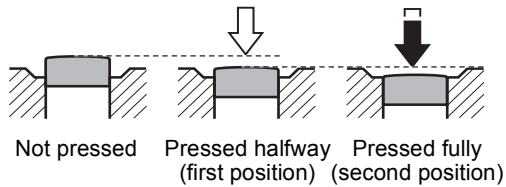

Pressing it down halfway (first position) turns on the viewfinder indicators and the autofocus system operates. Pressing it fully (second position) takes a picture.



- Press the shutter release button gently when taking a picture to prevent camera shake.
- Practice pressing the shutter release button halfway/fully to learn where the first position and second position are.
- The viewfinder indicators stay on while the shutter release button is pressed halfway. The indicators stay on for about 10 seconds (default setting) while the exposure metering timer is on after the button is released. (p.31, p.114)

## Subjects that are Difficult to Focus on

The autofocus mechanism is not perfect. Focusing may be difficult when taking pictures under the following conditions. These also apply to manual focusing using the focus indicator  in the viewfinder.

- (a) Extremely low-contrast subjects such as a white wall in the focusing area.
- (b) Subjects which do not reflect much light within the focusing area.
- (c) Fast moving objects.
- (d) Strongly reflected light or strong backlighting (bright background).
- (e) If repeating vertical or horizontal line patterns appear within the focusing area.
- (f) Multiple subjects in the foreground and background within the focusing area.

If the subject cannot be focused automatically, set the focus mode lever to **MF** and use the manual focus mode to focus on the subject with the aid of the matte field in the viewfinder. (p.127)



Subject may not be focused even when  (focus indicator) is displayed when (e) and (f) above apply.



Enlarge the subject (telephoto) or capture a wider area (wide angle) with a zoom lens. Adjust it to the desired size and take the picture.

## 1 Turn the zoom ring to the right or left.

Turn the zoom ring clockwise for telephoto and counterclockwise for wide angle.

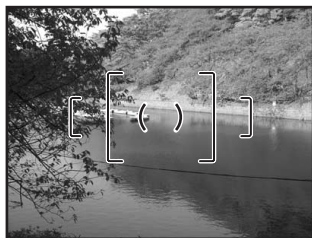
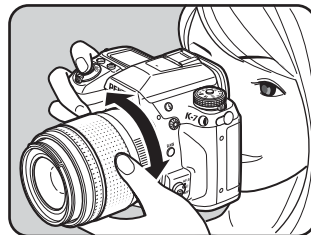

Wide Angle

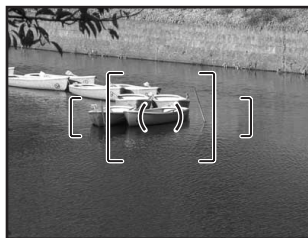

Telephoto



- The smaller the number of the displayed focal length, the wider the angle. The larger the number, the more magnified the image appears.
- Power Zoom (Auto Zoom) is available if a Power Zoom compatible FA lens is used with this camera. (p.292)

Use the following procedures to take pictures in low light or backlit conditions or when you want to manually use the built-in flash. The built-in flash is optimum at about 0.7 m to 5 m from the subject. Exposure will not be properly controlled and vignetting (darkening of the corners of the image due to a lack of light) may occur when used at a distance closer than 0.7 m (this distance varies slightly depending on the lens being used and set sensitivity (p.171)).

## Compatibility of built-in flash and lens

Vignetting may occur depending on the lens being used and the capture conditions. We recommend taking a test shot to confirm this.

 Lens Compatibility with the Built-in Flash (p.172)













- When using the built-in flash, remove the lens hood before shooting.
- The built-in flash fully discharges for lenses without a function to set aperture lens ring to **A** (Auto).







For details on the built-in flash and instructions on how to take pictures with the external flash, refer to the "Using the Flash" (p.167).

## Setting the Flash Mode

Flash Mode	Function
 <b>A</b> Auto Flash Discharge	Discharges the flash automatically in dark or backlit conditions.
 <b>A</b>  Auto Flash+ Red-eye Reduction	Lights a red-eye reduction light before automatic flash.
 Flash On	Discharges the flash for each picture.
  Flash On+ Red-eye Reduction	Lights a red-eye reduction light before discharging the flash with Flash On.
 <b>SLOW</b>  Slow-speed Sync	Sets to a slow shutter speed depending on the brightness. For example, when using this to shoot a portrait with the sunset in the background, both the person and the background are captured beautifully.

Flash Mode	Function
 Slow-speed Sync+ Red-eye	Lights a red-eye reduction light before discharging the flash with Slow-speed Sync.
 Trailing Curtain Sync	Discharges flash immediately before closing the shutter curtain. Capture moving images as if they are leaving a trail behind. (p.170)
 Wireless Mode	You can synchronize a dedicated external flash (AF540FGZ or AF360FGZ) without using a sync cord. (p.176)

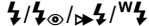
The flash modes that can be selected differ depending on the exposure mode.

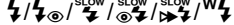

Exposure Mode	Selectable Flash Mode	Restrictions
		No flash compensation
<b>Tv/TAv/M/B</b>		—
<b>X</b>		—
<b>P/Av/Sv</b>		—
<b>USER</b>	According to the saved settings	

## 1 Press the four-way controller (▼) in Capture mode.

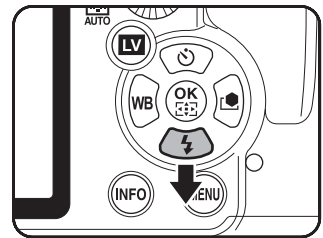
The [Flash Mode] screen appears.



## 2 Use the four-way controller (◀▶) to select a flash mode.

When not in  (Green) mode, turn the rear e-dial () to perform the flash exposure compensation. (p.76)

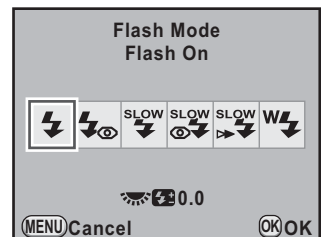

### 3 Press the OK button.

The camera is ready to take a picture.

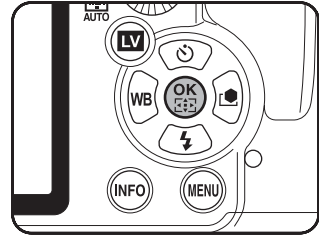

## Using Built-in Flash

### 1 Press the ⚡ button.

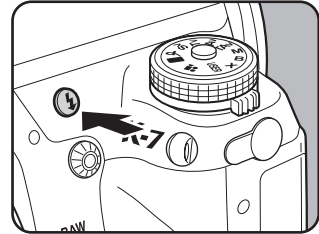

The built-in flash pops up and begins charging. When the flash is fully charged, ⚡ appears in the viewfinder and on the LCD panel. (p.31, p.33)

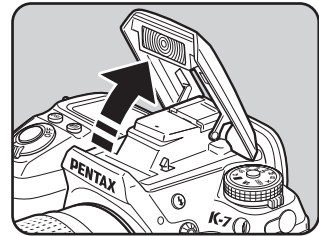

### 2 Press the shutter release button halfway.

The focus indicator ● appears in the viewfinder when focused.

### 3 Press the shutter release button fully.

The picture is taken.

When the mode dial is at ■, the flash is not discharged if the lighting conditions do not require flash for correction even when the flash is popped up.

The Flash On is used if the flash is popped up when the mode dial is at a setting other than ■.

- 4** Push down on the portion indicated in the illustration to retract the flash.

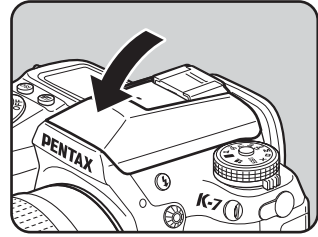



### Using Red-eye Reduction Flash

“Red-eye” is the phenomenon where eyes look reddish in photographs taken in dark environments with a flash. This is caused by the reflection of the electronic flash in the retina of the eye. Red-eye occurs because pupils are dilated in dark environments. This phenomenon cannot be averted but the following measures can be used to combat it.

- Brighten the surroundings when shooting.
- Set to wide angle and move closer to the subject if a zoom lens is in use.
- Use a flash that supports red-eye reduction.
- Position the flash as far away from the camera as possible when using an external flash.

The red-eye reduction function on this camera reduces red-eye by discharging the flash twice. With the red-eye reduction function, the pre-flash is discharged just before the shutter is released. This reduces pupil dilation. The main flash is then discharged while the pupils are smaller, reducing the red-eye effect.

To use the red-eye reduction function, set  in  mode, or  in other modes.

SLOW  

## Daylight-Sync Shooting

In daylight conditions, the flash will eliminate shadows when a portrait picture is taken with a person's face cast in shadow. Use of the flash in this way is called Daylight-Sync shooting. Flash On is used when shooting with Daylight-Sync shooting.

### ● Taking pictures (in P mode)

- 1 Pop up the flash manually and confirm that the flash mode is set to .
- 2 Confirm that the flash is fully charged.
- 3 Take a picture.



Without Daylight-Sync



With Daylight-Sync



The picture may be overexposed if the background is too bright.

## Compensating Flash Output

You can change the flash output in a range of -2.0 to +1.0. The flash compensation values are as follows for 1/3 EV and 1/2 EV.

Step interval	Flash compensation
1/3 EV	-2.0, -1.7, -1.3, -1.0, -0.7, -0.3, 0.0, +0.3, +0.7, +1.0
1/2 EV	-2.0, -1.5, -1.0, -0.5, 0.0, +0.5, +1.0

Set interval of steps in [1. EV Steps] (p.116) in the [C Custom Setting 1] menu.

Set the flash compensation value by turning the rear e-dial (☀️) in the [Flash Mode] screen. Pressing the Ⓞ (Green) button returns the flash exposure compensation to the default setting (0.0).

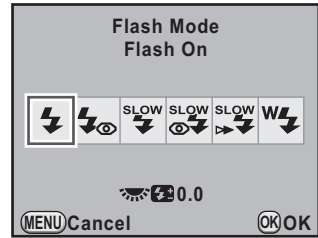

- The flash exposure compensation cannot be set in ■ (Green) mode.
- ⚡ appears in the viewfinder and on the LCD panel during the flash exposure compensation. (p.31, p.33)
- If the maximum flash output is exceeded when corrected to the plus (+) side, no compensation will be effective.
- Compensating to the minus (-) side may not affect the image if the subject is too close, the aperture value is small or the sensitivity is high.
- The flash compensation is also effective for external flash units which support P-TTL auto flash mode.

## Allowing Shooting while Charging Flash

You can also shoot while the flash is being charged.

Select [On] for [30. Release While Charging] in the [C Custom Setting 5] menu (p.87). Pictures cannot be taken while the flash is charging by default.

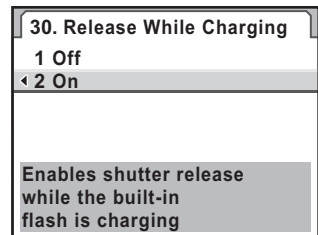

## Playing Back Images

You can play back still pictures and movies shot with the camera.



Use the provided "PENTAX Digital Camera Utility 4" software to play back pictures using a computer. Refer to the provided "Quick Guide" for details on the software.

3

Basic Operations

1

### Press the button.

The camera enters Playback mode and the most recently captured image (image with the highest file number) is displayed on the monitor. (For movies, only the first frame is displayed on the monitor.)

Press the **INFO** button during playback to switch the information display such as the image data for the displayed image.

Refer to p.25 for display information details.

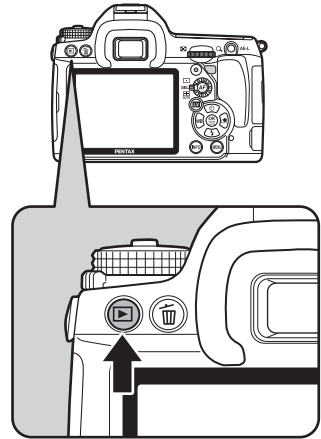

2

### Press the four-way controller ( .

- ◀ : The previous image appears.
- ▶ : The next image appears.

You can display the next or previous image by turning the front e-dial (.

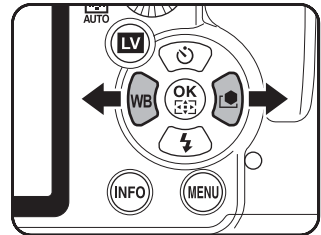

Refer to "Playback Functions" (p.211) for playback function details.



# Deleting Images

You can delete one image at a time.



- Deleted images cannot be restored.
- Protected images cannot be deleted. (p.231)

**1** Press the button and use the four-way controller (◀▶) to select an image to delete.

**2** Press the button.

The delete screen appears.

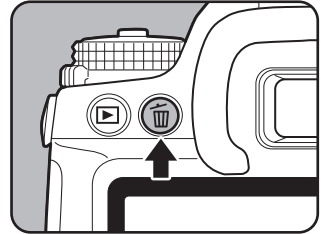

**3** Use the four-way controller (▲▼) to select [Delete].

Select the file format to delete for images saved in RAW+ format.

Delete JPEG	Deletes only the JPEG image.
Delete RAW	Deletes only the RAW image.
Delete RAW+JPEG	Deletes both file formats.



**4** Press the **OK** button.

The image is deleted.



When deleting multiple images at once, refer to “Deleting Multiple Images” (p.227).

**Memo**

# 4 Shooting Functions

---

This chapter describes the various basic and advanced shooting functions available with the *K-7*.

<b>How to Operate the Shooting Functions .....</b>	<b>82</b>
<b>Setting the Exposure .....</b>	<b>88</b>
<b>Focusing .....</b>	<b>118</b>
<b>Checking the Composition, Exposure and Focus Before Shooting (Preview) .....</b>	<b>129</b>
<b>Preventing Camera Shake during Shutter Release .....</b>	<b>132</b>
<b>Taking Pictures Continuously .....</b>	<b>143</b>
<b>Shooting while Adjusting the Settings (Auto Bracket) .....</b>	<b>148</b>
<b>Taking Pictures Using Digital Filter .....</b>	<b>153</b>
<b>Shooting with the Live View .....</b>	<b>156</b>

# How to Operate the Shooting Functions

You can change capture-related settings using the direct keys, control panel, [📷 Rec. Mode] menus or [C Custom Setting] menus.



For details on how to operate the menus, see “Using the Menu” (p.36).

## Direct Keys Setting Items

Press the four-way controller (▲▼◀▶) in Capture mode to set the following items.

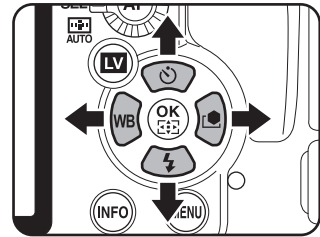



Key	Item	Function	Page
▲	Drive Mode	Sets Continuous Shooting, Self-Timer, Remote Control, Auto Bracket or Mirror Lock-up shooting.	p.143 p.136 p.138 p.148 p.141
▼	Flash Mode	Adjusts the method of flash discharge.	p.72
◀	White Balance	Adjusts the color balance to match the type of the light source illuminating the subject.	p.191
▶	Custom Image	Sets the image finishing tone.	p.205

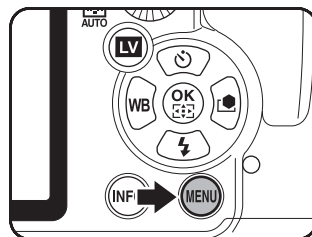

## Rec. Mode Menu Setting Items

Perform the following settings in the [ Rec. Mode 1-4] menu.

Press the **MENU** button in Capture mode to display [ Rec. Mode 1] menu.



Menu	Item	Function	Page
	Exposure Mode * <sup>1</sup>	Sets the exposure mode when the mode dial is set to <b>USER</b> .	p.209
	File Format* <sup>2</sup>	Sets the file format.	p.188
	JPEG Recorded Pixels* <sup>2</sup>	Sets the recording size of images for JPEG shooting.	p.186
	JPEG Quality* <sup>2</sup>	Sets the image quality for JPEG shooting.	p.187
	ISO AUTO Setting* <sup>2</sup>	Sets the range of automatic correction in AUTO.	p.90
	D-Range Setting* <sup>2</sup>	Expands the dynamic range and prevents bright and dark areas from occurring.	p.199
	Lens Correction * <sup>2</sup>	Corrects distortions and chromatic aberrations of magnification occurring due to lens properties.	p.201
	Program Line* <sup>2</sup>	Selects Program Line.	p.94
	Extended Bracketing* <sup>2</sup>	Sets the Extended Bracketing shooting.	p.151
	HDR Capture* <sup>2</sup>	Enables the capture of images at high dynamic range.	p.200
	Digital Filter* <sup>2</sup>	Applies filter effects when taking pictures.	p.153
	Multi-exposure	Sets the Multi-exposure shooting.	p.146
	Interval Shooting	Sets the interval shooting.	p.144
	Composition Adjust.	Adjusts the Shake Reduction unit for a better composition position and a more level camera.	p.203

Menu	Item	Function	Page
 3	Movie	Sets the movie settings.	p.160
	Live View	Sets the Live View display.	p.157
	Status Screen	Sets the status screen display and display color settings.	p.262
	Digital Preview	Sets the Digital Preview settings.	p.129
	Instant Review	Sets the Instant Review display settings.	p.263
	Electronic Level	Sets whether to display a bar graph of the electronic level in the viewfinder and on the LCD panel.	p.266
	Horizon Correction	Corrects the tilt of the image.	p.133
 4	Color Space	Sets the color space to use.	p.279
	RAW File Format	Sets the file format for RAW shooting.	p.189
	RAW Button	Sets the <b>RAW</b> button function.	p.189
	Memory	Sets the settings to save in the camera when the power is turned off.	p.281
	USER	Saves the current camera settings as <b>USER</b> .	p.207
	Shake Reduction*2	Reduces vertical and horizontal camera shake.	p.133
	Input Focal Length	Sets the focal length when using a lens for which focal length information cannot be obtained.	p.135

\*1 Appears only when the mode dial is set to **USER**.

\*2 Can be also set using the control panel.

## Custom Setting Menu Setting Items

Set the [C Custom Setting 1-6] menu to fully use the functions of a SLR camera.

Menu	Item	Function	Page
C1	1. EV Steps	Sets the adjustment steps for exposure.	p.116
	2. Sensitivity Steps	Sets the adjustment steps for ISO sensitivity.	p.90
	3. Expanded Sensitivity	Expands the upper sensitivity limit.	p.90
	4. Meter Operating Time	Sets the exposure metering time.	p.114
	5. AE-L with AF Locked	Sets whether to lock exposure value when focus is locked.	p.126
	6. Link AE to AF Point	Sets whether to link the exposure and AF point in the focusing area during multi-segment metering.	p.114
	7. One-Push Bracketing	Sets whether to shoot all frames with one release when using Exposure Bracketing.	p.150
C2	8. Auto Bracketing Order	Sets the order for Auto Bracket shooting.	p.148
	9. Auto EV Compensation	Sets whether to compensate automatically when the proper exposure cannot be determined.	–
	10. WB When Using Flash	Sets the white balance setting when using flash.	p.192
	11. WB Adjustable Range	Sets whether to automatically fine-tune the white balance when specifying the light source on the white balance setting.	p.192
	12. AWB in Tungsten Light	Sets whether to leave or adjust the tungsten light color tone when the white balance is set to <b>AWB</b> .	–
	13. AF Button Function	Sets the operation for when the <b>AF</b> button is pressed.	p.120
	14. AF with Press Halfway	Sets whether to use the autofocus when the shutter release button is pressed halfway.	–

Menu	Item	Function	Page
<b>C3</b>	15. Superimpose AF Area	Sets whether to display the selected AF point in the viewfinder.	p.122
	16. AF with Remote Control	Sets whether to use the autofocus when shooting with remote control.	p.140
	17. Remote Control in Bulb	While using the remote control in <b>B</b> (Bulb) mode, sets whether to start exposure with a press and stop it with another press of the release button on the remote control, or to keep the shutter open as long as the release button on the remote control is kept pressed.	p.111
	18. Slow Shutter Speed NR	Sets whether to use Noise Reduction when shooting at slow shutter speeds.	p.92
	19. High-ISO Noise Reduction	Sets whether to use Noise Reduction when shooting with a high ISO sensitivity. Select from three levels.	p.92
	20. High-ISO NR Start Level	Sets the ISO start value in High-ISO Noise Reduction.	p.92
	21. Color Temperature Steps	Sets the adjustment steps for color temperature.	p.196
<b>C4</b>	22. e-dial in Program	Sets the front and rear e-dials in <b>P</b> mode.	p.97
	23. e-dial in Sv mode	Sets the front and rear e-dials in <b>Sv</b> mode.	p.99
	24. e-dial in Tv mode	Sets the front and rear e-dials in <b>Tv</b> mode.	p.101
	25. e-dial in Av mode	Sets the front and rear e-dials in <b>Av</b> mode.	p.103
	26. e-dial in TAv & M modes	Sets the front and rear e-dials in <b>TAv</b> or <b>M</b> mode.	p.106
	27. e-dial in B & X modes	Sets the front and rear e-dials in <b>B</b> or <b>X</b> mode.	p.111
	28. Green Button in TAv & M	Selects the exposure adjustment method when the  button is pressed in <b>TAv</b> or <b>M</b> mode.	p.106



Menu	Item	Function	Page
<b>C5</b>	29. LCD Panel Illumination	Sets whether to illuminate the LCD panel.	p.33
	30. Release While Charging	Sets whether to release shutter while the built-in flash is charging.	p.77
	31. Flash in Wireless Mode	Sets the built-in flash discharge method in Wireless Mode.	p.177
	32. AF Assist Light	Provides an assist light when using the autofocus in dark locations.	–
	33. Saving Rotation Info	Sets whether to save rotation information when shooting.	p.225
	34. Auto Image Rotation	Sets whether to automatically rotate images when playing back.	p.225
	35. Catch-in Focus	When set to [On], if the focus mode is set to <b>A.F.S</b> and a manual focus lens is attached, catch-in focus shooting is enabled and the shutter is released automatically when the subject comes into focus.	p.128
<b>C6</b>	36. AF Adjustment	Adjusts the AF focusing position.	p.121
	37. Using Aperture Ring	Sets whether to enable shutter release when the lens aperture ring is set to the position other than <b>A</b> .	p.294
	Reset Custom Functions	Resets all the settings in the [ <b>C</b> Custom Setting 1-6] menu to the defaults.	p.290

## Effect of Aperture and Shutter Speed

Correct exposure of the subject is determined by the combination of shutter speed and aperture setting. There are many correct combinations of shutter speed and aperture for a particular subject. Different combinations produce different effects.

### Effect of Shutter Speed

By changing the shutter speed, you can manipulate how time is expressed in the pictures you create. Unlike with your own naked eyes, in a picture you can capture a fraction of a moment or a whole period of time, creating different effects.

Use the **Tv** (Shutter Priority) mode.

#### ● Using slower shutter speed

If the subject is moving, the image will be blurred because the shutter is open longer.

It is possible to enhance the effect of motion (rivers, waterfalls, waves, etc.) by intentionally using a slower shutter speed.

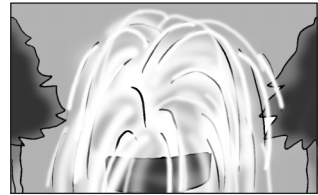

#### ● Using faster shutter speed

Choosing a faster shutter speed will allow freezing the action of a moving subject.

A faster shutter speed also helps to prevent camera shake.

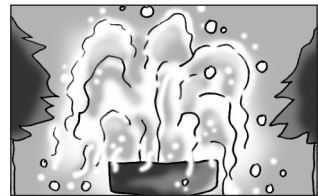

### Effect of Aperture

By changing the aperture, you can control the depth of the area that appears in focus in the picture (the depth of field). By either narrowing the focus to emphasize a single point or giving depth to your picture instead you can completely change the feel of the picture you create.

Use the **Av** (Aperture Priority) mode.

- **Opening the aperture (reduce the aperture value)**

Objects closer and farther than the focused subject will be more out of focus. For instance, if you take a picture of a flower against a landscape with the aperture open, the landscape in front and behind the flower will be blurred, emphasizing only the flower.



- **Closing the aperture (increase the aperture value)**

The range in focus expands forward and backward. For instance, if you take a picture of a flower against a landscape with the aperture narrowed, the landscape in front and behind the flower will be in focus.



## Aperture and Depth of Field

The following table summarizes how the aperture affects the depth of field. The depth of field may also change depending on the lens used and the distance to the subject.

Aperture	Open (Smaller value)	↔	Close (Larger value)
Depth of field	Shallow	↔	Deep
Area of focus	Narrow	↔	Wide
Lens focal length	Longer (Telephoto)	↔	Shorter (Wide-angle)
Distance to the subject	Near	↔	Far

- The depth of field for the **K-7** differs depending on the lens but compared to a 35 mm camera, the value is roughly one aperture setting lower (the focused range becomes narrower).
- The wider the wide-angle lens, and the farther away the subject, the deeper the depth of field is (some zoom lenses do not have a scale for depth of field because of their designs).

## Setting the Sensitivity

You can set the sensitivity to suit the brightness of the surroundings. The sensitivity can be set to [AUTO] or within a sensitivity range equivalent to ISO 100 to 3200. The default setting is [AUTO].

### 1 Turn the rear e-dial (☀️) while pressing the ISO button in Capture mode.

The sensitivity displayed on the status screen and LCD panel and in the viewfinder changes.

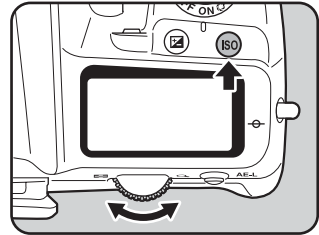

Press the  (Green) button while pressing the **ISO** button to return to [AUTO].



### 2 Take your finger off the ISO button and rear e-dial (☀️).

The sensitivity is set.



- To set the sensitivity, you can also press the **ISO** button once and take your finger off the button, and then turn the rear e-dial (☀️) to change the sensitivity. In this case, press the **ISO** button again or turn off the exposure metering timer (p.114) to set the sensitivity.
- When the exposure mode is set to  (Green), **TA**v (Shutter & Aperture Priority) or  (Movie), the sensitivity is fixed to [AUTO] and the setting cannot be changed.
- When the exposure mode is set to **B** (Bulb), the upper sensitivity limit is ISO 1600.
- When the exposure mode is set to **S**v (Sensitivity Priority), **M** (Hyper-manual), **B** (Bulb) or **X** (Flash X-sync Speed), the sensitivity cannot be set to [AUTO].
- The sensitivity range can be expanded to a range of ISO 100 to 6400 when [3. Expanded Sensitivity] in the [**C** Custom Setting 1] menu (p.85) is set to [On].
- Captured images can show more noise if a higher sensitivity is set. You can reduce image noise by setting [19. High-ISO Noise Reduction] in the [**C** Custom Setting 3] menu. (p.92)
- You can set whether to lock the sensitivity adjustment to increments of 1 EV or to coordinate it with the EV Steps (p.116) in [2. Sensitivity Steps] in the [**C** Custom Setting 1] menu (p.85).

## Setting the Range of Automatic Sensitivity Correction

Set the range in which the sensitivity is automatically adjusted when the sensitivity is set to [AUTO]. The sensitivity is automatically corrected in the range of [ISO 100-800] by default.

- 1 Select [ISO AUTO Setting] in the [📷 Rec. Mode 1] menu and press the four-way controller (▶).

The [ISO AUTO Setting] screen appears.

- 2 Press the four-way controller (▶) and use the four-way controller (▲▼) to set the minimum sensitivity.

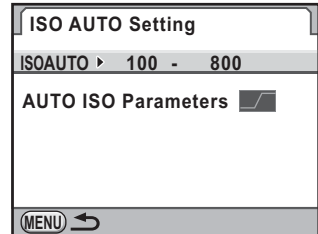

- 3 Press the four-way controller (▶) and use the four-way controller (▲▼) to set the maximum sensitivity.

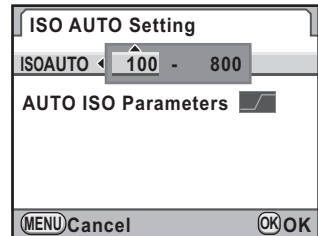

- 4 Press the OK button.

- 5 Use the four-way controller (▲▼) to select [AUTO ISO Parameters].

- 6 Use the four-way controller (◀▶) to select the parameter.

: Increases the sensitivity as little as possible

: Standard (Default setting)

: Actively increases the sensitivity

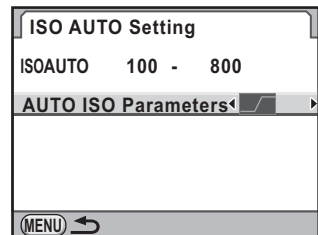

- 7 Press the MENU button twice.

The screen that was displayed before selecting the menu appears again.



When [Highlight Correction] is set to  (On) in [D-Range Setting] in the [📷 Rec. Mode 1] menu (p.199), the minimum sensitivity is ISO 200.

## Expanding the Dynamic Range

Dynamic range is the ratio that indicates the light level expressed by the CMOS sensor pixels from bright areas to dark areas. The larger it is, the better the whole range from dark to bright areas will appear in the picture. By expanding the dynamic range, you can expand the light level expressed by the CMOS sensor pixels, making it more difficult for an overexposed area to occur in the image.

To expand the dynamic range, use [D-Range Setting] in the [📷 Rec. Mode 1] menu. (p.199)

### Noise Reduction

When you use a digital camera to shoot with a long exposure or high sensitivity setting, image noise (image roughness or unevenness) becomes noticeable.

You can reduce image noise by using Noise Reduction. Images shot with Noise Reduction take longer to save.

#### ● Slow Shutter Speed NR

Reduces noise during long exposures.

Set in [18. Slow Shutter Speed NR] in the [C Custom Setting 3] menu (p.86).

On	The camera determines the conditions such as the shutter speed, sensitivity, and internal temperature, and automatically reduces noise as necessary.
Off	Reduces noise only when the exposure mode is set to <b>B</b> and the shutter remains open for 30 seconds or more.

#### ● High-ISO Noise Reduction

Reduces noise at high sensitivity (ISO) settings.

Select [Off], [Low], [Medium], or [High] for [19. High-ISO Noise Reduction] in the [C Custom Setting 3] menu (p.86). You can set the sensitivity at which to start noise reduction by setting [20. High-ISO NR Start Level] in the [C Custom Setting 3] menu (p.86).

## Changing the Exposure Mode

This camera features the following nine exposure modes. Use the mode dial to change the exposure mode. (p.39)







The settings available for each exposure mode are as follows.

Exposure Mode	Characteristics	EV Compensation	Change Shutter Speed	Change Aperture	Change Sensitivity	Page
 (Green)	Lets you capture images with fully automatic settings.	×	×	×	×	p.95
<b>P</b> (Hyper-program)	Automatically sets shutter speed and aperture to the proper exposure according to Program Line when taking pictures. You can use the front and rear e-dials to switch between shutter priority and aperture priority.	✓	✓	✓	✓	p.96
<b>Sv</b> (Sensitivity Priority)	Automatically sets the shutter speed and aperture to the proper exposure according to the set sensitivity.	✓	×	×	Other than AUTO	p.98
<b>Tv</b> (Shutter Priority)	Lets you set the desired shutter speed for expressing moving subjects.	✓	✓	×	✓	p.100
<b>Av</b> (Aperture Priority)	Lets you set the aperture for controlling the depth of field.	✓	×	✓	✓	p.102
<b>TAv</b> (Shutter & Aperture Priority)	Automatically sets the sensitivity so that the manually set shutter speed and aperture will give the proper exposure according to the brightness of the subject.	✓	✓	✓	AUTO only	p.104

Exposure Mode	Characteristics	EV Compensation	Change Shutter Speed	Change Aperture	Change Sensitivity	Page
<b>M</b> (Hyper-manual)	Lets you set the shutter speed and aperture to capture the picture with creative intent.	✓	✓	✓	✓	p.107
<b>B</b> (Bulb)	Lets you capture images that require slow shutter speeds such as fireworks and night scenes.	×	×	✓	Other than AUTO (up to ISO 1600)	p.110
<b>X</b> (Flash X-sync Speed)	The shutter speed is locked at 1/180 seconds. Use this when using an external flash that does not automatically set the sync speed.	✓	×	✓	Other than AUTO	p.112

## Program Line

In [Program Line] in the [📷 Rec. Mode 2] menu, you can choose from the following Program Lines including [AUTO]. When [1. Program Line] is selected for the  (Green) button setting in **TA<sub>v</sub>/M** mode (p.106) or in **P/S<sub>v</sub>** mode, exposure is regulated according to the set Program Line.

Settings	Characteristics
 AUTO	Camera determines the appropriate settings.
 Normal	Basic Program Automatic Exposure. (default setting)
 Hi-speed Priority	Program Automatic Exposure that prioritizes high shutter speeds.
 DOF Priority (deep)	Program Automatic Exposure that closes the aperture as much as possible for a deep depth of field.
 DOF Priority (shallow)	Program Automatic Exposure that opens the aperture as much as possible for a shallow depth of field.
 MTF Priority	Program Automatic Exposure that prioritizes the best aperture settings for the attached lens when a DA, DA L, D FA, FA J or FA lens is used.







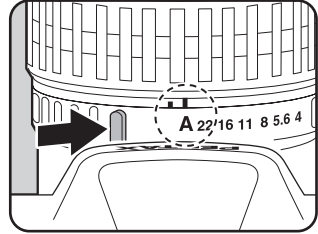







## Using a Lens with an Aperture Ring

When using a lens with an aperture ring, set the aperture to the **A** (AUTO) position while holding down the auto-lock button on the lens.



## Using the (Green) Mode

Lets you capture images with fully automatic settings. In  mode, pictures are taken with the following settings.

- Program Line  (AUTO)
- File Format  JPEG
- JPEG Recorded Pixels  14M
- JPEG Quality  ★★★
- Sensitivity  AUTO
- Metering Method  (Multi-segment Metering)
- AF Point  (Auto)
- White Balance  **AWB** (Auto)
- Custom Image  Bright
- Shake Reduction  (On)
- Color Space  sRGB

### 1 Set the mode dial to .

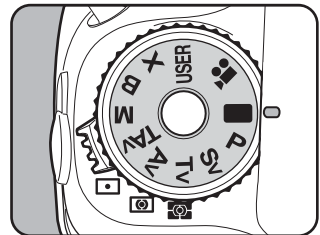

Caution

- In **■** mode, the following functions are not available.
  - Shutter Speed
  - Aperture
  - EV Compensation
  - Flash (Flash On, Slow-speed Sync, Exposure Compensation)
  - Continuous Shooting
  - Focus Mode **A.F.C** (available when **A.F.S** is selected)
  - D-Range setting
  - Lens Correction
  - Exposure Bracketing
  - Mirror Lock-up Shooting
  - Multi-exposure
  - Interval Shooting
  - Extended Bracketing
  - Digital Filter
  - HDR Capture
  - Horizon Correction
  - Save as **USER**
  - **AE-L** and **RAW** button operations
  - Custom menu settings (available when all settings are default values)
- The control panel cannot be displayed in **■** mode.

4

## Using the P (Hyper-program) Mode

Automatically sets shutter speed and aperture to the proper exposure according to Program Line when taking pictures. Use the front and rear e-dials to change the shutter speed and aperture while maintaining the proper exposure (p.97).

### 1 Set the mode dial to P.

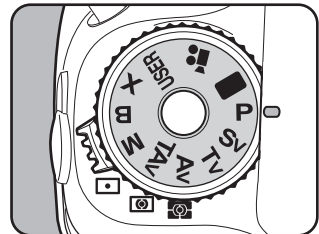

## 2 Confirm the shutter speed and aperture.

Confirm using the status screen, viewfinder or LCD panel.

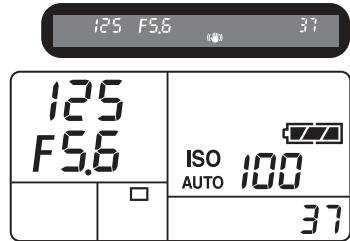
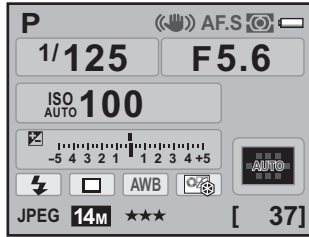

- Set the Program Line to use in [Program Line] in the [Rec. Mode 2] menu (p.94).
- Set the EV compensation in increments of 1/3 EV or 1/2 EV. Set the exposure steps in [1. EV Steps] in the [C Custom Setting 1] menu. (p.116)
- The proper exposure may not be obtained with the selected shutter speed and aperture when the sensitivity is set to other than [AUTO] (p.90).

4

### e-dial in Program

You can set the action for the front and rear e-dials in **P** mode with [22. e-dial in Program] in the [C Custom Setting 4] menu (p.86), and you can change the shutter speed and aperture while maintaining the proper exposure.

Settings	Front e-dial (☀)	Rear e-dial (☀)
1	<b>Tv</b> (Shutter Speed)	<b>Av</b> (Aperture)
2	<b>Av</b> (Aperture)	<b>Tv</b> (Shutter Speed)
3	EV Compensation	P.SHIFT (Program Shift)
4	P.SHIFT (Program Shift)	EV Compensation
5	– (Not Available)	– (Not Available)

- You can only set the shutter speed or aperture to a value that will give a correct exposure with the relative aperture or shutter speed range of the lens being used. If the brightness changes and the shutter speed or aperture is outside the relative range, the shutter speed or aperture will blink on the status screen and LCD panel and in the viewfinder.
- Pressing the (Green) button returns to Automatic Exposure.

## Using the Sv (Sensitivity Priority) Mode

You can set the sensitivity to suit the brightness of the subject. The shutter speed and aperture are automatically set according to the selected sensitivity to obtain the appropriate exposure.

- 1 Set the mode dial to Sv.

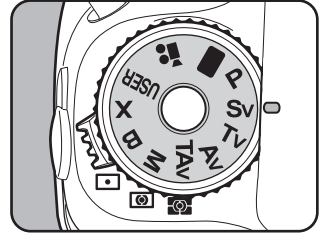

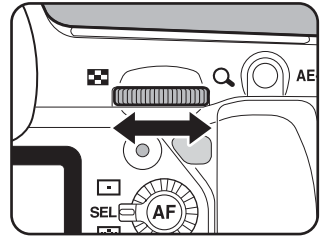

- 2 Turn the rear e-dial (☀️) to adjust the sensitivity.

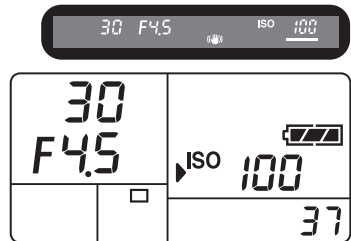
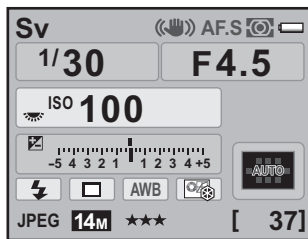

The shutter speed, aperture value and sensitivity are displayed on the status screen and LCD panel and in the viewfinder.







- You can set the sensitivity to values equivalent to ISO 100 to 3200. [AUTO] is not available.
- In **Sv** mode, you cannot change the sensitivity by turning the rear e-dial () while pressing the **ISO** button.
- Turn the rear e-dial () while pressing the  button to change the EV compensation value. (p.115)
- Set the sensitivity in increments of 1/3 EV or 1/2 EV. Set the exposure steps in [1. EV Steps] in the [**C** Custom Setting 1] menu. (p.116)

## e-dial in Sv mode

You can set the functions of the front and rear e-dials in **Sv** mode. Set in [23. e-dial in Sv mode] in the [**C** Custom Setting 4] menu (p.86).

Settings	Front e-dial (  )	Rear e-dial (  )
1	– (Not Available)	Sensitivity
2	P.SHIFT (Program Shift)	Sensitivity
3	Sensitivity	P.SHIFT (Program Shift)
4	EV Compensation	Sensitivity
5	Sensitivity	EV Compensation

## Using the Tv (Shutter Priority) Mode

Lets you set the desired shutter speed for expressing moving subjects. When taking pictures of a fast moving subject, you can increase the shutter speed to make the subject look still or decrease the shutter speed to have the subject show movement.

Aperture value is automatically set to give the appropriate exposure depending on the shutter speed.

- ☞ Effect of Aperture and Shutter Speed (p.88)

### 1 Set the mode dial to Tv.

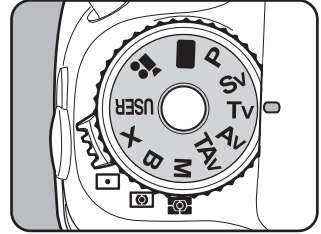

### 2 Turn the front e-dial (☀) to adjust the shutter speed.

The shutter speed can be set within the range of 1/8000 to 30 seconds.

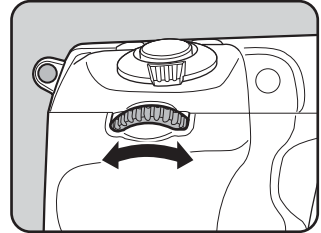

The shutter speed and aperture value are displayed on the status screen and LCD panel and in the viewfinder.

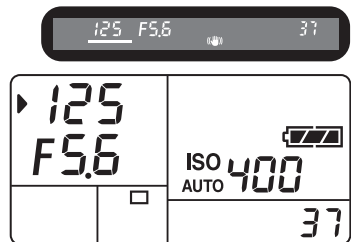
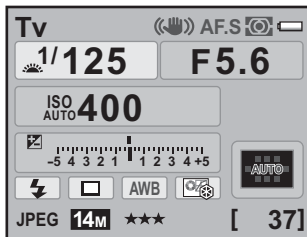



- Turn the rear e-dial (☀️) while pressing the button to change the EV compensation value. (p.115)
- Set the shutter speed in increments of 1/3 EV or 1/2 EV. Set the exposure steps in [1. EV Steps] in the [C Custom Setting 1] menu. (p.116)
- The proper exposure may not be obtained with the selected shutter speed when the sensitivity is set to other than [AUTO] (p.90).

## Exposure Warning

If the subject is too bright or too dark, the aperture value will blink on the status screen and LCD panel and in the viewfinder. If the subject is too bright, choose a faster shutter speed. If it is too dark, choose a slower shutter speed. When the aperture value indication stops blinking, you can take the picture with proper exposure.



Use a commercially available ND (Neutral Density) filter if the subject is too bright. Use a flash if it is too dark.

## e-dial in Tv mode

You can set the functions of the front and rear e-dials in **Tv** mode. Set in [24. e-dial in Tv mode] in the [C Custom Setting 4] menu (p.86).

Settings	Front e-dial (☀️)	Rear e-dial (☀️)
1	<b>Tv</b> (Shutter Speed)	– (Not Available)
2	<b>Tv</b> (Shutter Speed)	EV Compensation
3	EV Compensation	<b>Tv</b> (Shutter Speed)
4	<b>Tv</b> (Shutter Speed)	Sensitivity
5	Sensitivity	<b>Tv</b> (Shutter Speed)

## Using the Av (Aperture Priority) Mode

Lets you set the desired aperture for controlling the depth of field. The depth of field is deeper and the front and back of the focused object is clear when aperture is set to a large value. The depth of field is shallower and the front and back of the focused object is blurred when aperture is set to a small value.

Shutter speed is automatically set to appropriate exposure depending on the aperture value.

- ☞ Effect of Aperture and Shutter Speed (p.88)

### 1 Set the mode dial to Av.

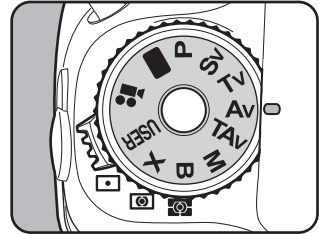

### 2 Turn the rear e-dial (☞) to adjust the aperture.

Aperture range depends on the lens in use.

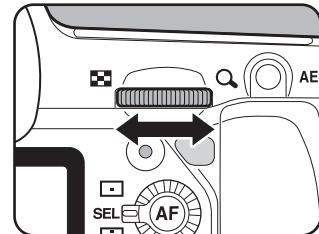

The shutter speed and aperture value are displayed on the status screen and LCD panel and in the viewfinder.

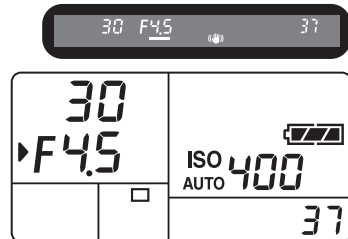
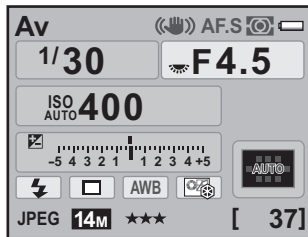





- Turn the rear e-dial (☀️) while pressing the button to change the EV compensation value. (p.115)
- Set the aperture value in increments of 1/3 EV or 1/2 EV. Set the exposure steps in [1. EV Steps] in the [**C** Custom Setting 1] menu. (p.116)
- The proper exposure may not be obtained with the selected aperture when the sensitivity is set to other than [AUTO] (p.90).

## Exposure Warning

If the subject is too bright or too dark, the shutter speed will blink on the status screen and LCD panel and in the viewfinder. When the subject is too



bright, set the aperture smaller (larger number), and when too dark, open the aperture further (smaller number). Once blinking stops, you can take a picture with proper exposure.

Use a commercially available ND (Neutral Density) filter if the subject is too bright. Use a flash if it is too dark.

## e-dial in Av Mode

You can set the functions of the front and rear e-dials in **Av** mode. Set in [25. e-dial in Av mode] in the [**C** Custom Setting 4] menu (p.86).

Settings	Front e-dial (☀️)	Rear e-dial (☀️)
1	– (Not Available)	<b>Av</b> (Aperture)
2	EV Compensation	<b>Av</b> (Aperture)
3	<b>Av</b> (Aperture)	EV Compensation
4	Sensitivity	<b>Av</b> (Aperture)
5	<b>Av</b> (Aperture)	Sensitivity

## Using the TAv (Shutter & Aperture Priority) Mode

You can set both the desired shutter speed and aperture to take the picture.

Automatically sets the sensitivity so that the manually set shutter speed and aperture will give the proper exposure according to the brightness of the subject.

### 1 Set the mode dial to TAv.

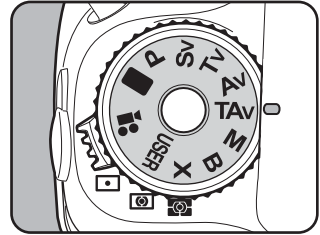

### 2 Turn the front e-dial (☀️) to adjust the shutter speed.

The shutter speed can be set within the range of 1/8000 to 30 seconds.

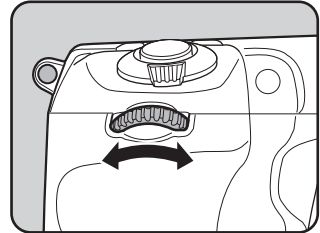

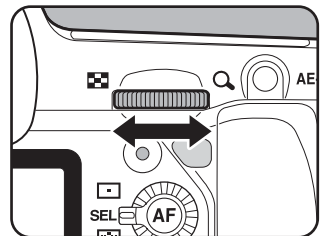

### 3 Turn the rear e-dial (☀️) to adjust the aperture.

Aperture range depends on the lens in use.

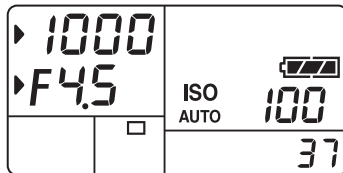
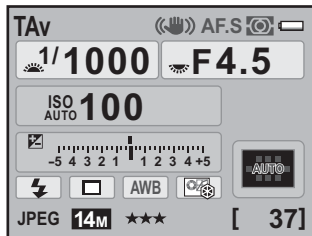

The shutter speed and aperture value are displayed on the status screen and LCD panel and in the viewfinder.



- Turn the rear e-dial (☀️) while pressing the  button to change the EV compensation value. (p.115)
- Set the shutter speed and aperture values in increments of 1/3 EV or 1/2 EV. Set the exposure steps in [1. EV Steps] in the [C Custom Setting 1] menu. (p.116)
- In **TAv** mode, the sensitivity is fixed to [AUTO].

## Exposure Warning

If the subject is too bright or too dark, the sensitivity will blink on the status screen and LCD panel and in the viewfinder. In this sort of situation, change the shutter speed and aperture. When the indication stops blinking, you can take the picture with proper exposure.

Use a commercially available ND (Neutral Density) filter if the subject is too bright. Use a flash if it is too dark.



## e-dial in TAv & M Modes

You can set the functions of the front and rear e-dials in **TAv** and **M** modes. Set in [26. e-dial in TAv & M modes] in the [**C** Custom Setting 4] menu (p.86).

Settings	Front e-dial (☀)	Rear e-dial (☀)
1	<b>Tv</b> (Shutter Speed)	<b>Av</b> (Aperture)
2	<b>Av</b> (Aperture)	<b>Tv</b> (Shutter Speed)

## Green Button in TAv & M

The aperture and shutter speed are automatically adjusted to the appropriate exposure at the moment the  (Green) button is pressed in **TAv** and **M** modes. You can select an exposure adjustment method in [28. Green Button in TAv & M] in the [**C** Custom Setting 4] menu (p.86).

1	Program Line	The aperture and shutter speed are adjusted automatically according to Program Line (p.94).
2	<b>Tv</b> Shift	The aperture is locked and the shutter speed is adjusted automatically.
3	<b>Av</b> Shift	The shutter speed is locked and the aperture is adjusted automatically.
4	Off	Disables Green button operation.

- Shutter speed is adjusted to appropriate exposure according to lens aperture when lens aperture is not set to the **A** (Auto) position.

## Using M (Hyper-manual) Mode

You can set the shutter speed and aperture value. This mode is suitable to take pictures of your choice by combining them. This mode is convenient for taking pictures using the same combination of the shutter speed and aperture settings or taking intentionally underexposed (darker) or overexposed (brighter) photographs.

☞ Effect of Aperture and Shutter Speed (p.88)

### 1 Set the mode dial to M.

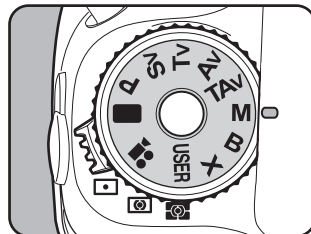

### 2 Press the (Green) button.

Automatically switches shutter speed and aperture to the proper exposure.

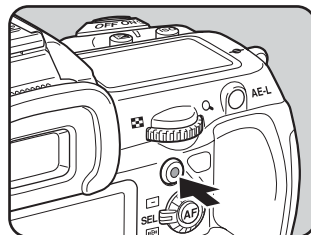

### 3 Turn the front e-dial () to adjust the shutter speed.

The shutter speed can be set within the range of 1/8000 to 30 seconds.

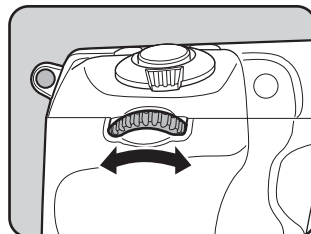

#### 4 Turn the rear e-dial ( ) to adjust the aperture.

Aperture range depends on the lens in use.

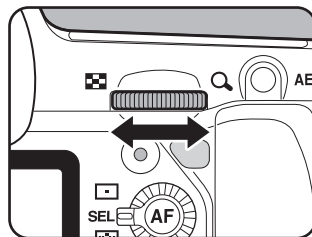

The shutter speed and aperture value are displayed on the status screen and LCD panel and in the viewfinder.

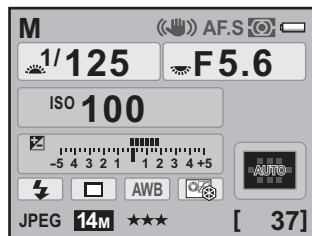

Difference from the appropriate exposure

While adjusting the shutter speed or aperture value, the difference from the appropriate exposure (EV value) is displayed in a bar graph. The appropriate exposure is achieved when the indicator is displayed in the center of the bar graph.



- When the sensitivity is set to [AUTO] and the exposure mode is set to **M** mode, the sensitivity is the lowest sensitivity set in “Setting the Range of Automatic Sensitivity Correction” (p.90).
- Set the shutter speed and aperture values in increments of 1/3 EV or 1/2 EV. Set the exposure steps in [1. EV Steps] in the [C Custom Setting 1] menu. (p.116)

## EV Bar

The EV bar appears on the LCD panel and viewfinder in **M** mode. The appropriate exposure is set when **|** is in the middle of the EV bar. If it is towards -, it is underexposed. If it is towards +, it is overexposed. If the value exceeds the range of the EV bar ( $\pm 5.0$ ), the "+" or "-" blinks.

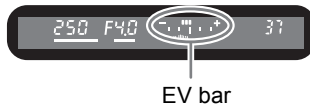

## Exposure Warning

If the subject is too bright or too dark, "+" or "-" in the EV bar will blink in the viewfinder and on the LCD panel.



## Combining with AE-L

Press the **AE-L** button (p.116) to record the exposure value in Hyper-manual. If the shutter speed or aperture is then changed, the combination of shutter speed and aperture changes while the exposure value is retained.

Example:

If the shutter speed is 1/125 seconds and aperture is F5.6 and is recorded by pressing the **AE-L** button, and the shutter speed is changed to 1/30 seconds with the front e-dial (☀️), the aperture automatically changes to F11.

## Using the **B** (Bulb) Mode

This setting is useful for the long exposures required for shooting night scenes and fireworks.

### 1 Set the mode dial to **B**.

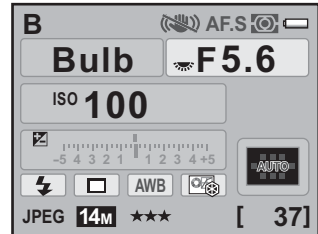
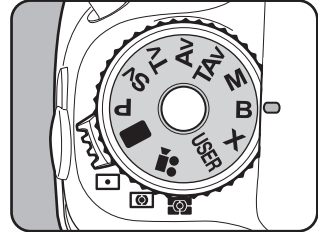

### 2 Press the shutter release button.

The shutter remains open as long as the shutter release button is kept pressed.



EV Compensation, Continuous Shooting and Exposure Bracketing are not available in **B** mode.





- Set the aperture value in increments of 1/3 EV or 1/2 EV. Set the exposure steps in [1. EV Steps] in the [C Custom Setting 1] menu. (p.116)
- The Shake Reduction function is automatically disabled when the exposure mode is set to **B** mode.
- Use a sturdy tripod and the cable switch CS-205 (optional) or Remote Control F (optional) to prevent camera shake when using **B** mode. Connect the cable switch to the cable release terminal (p.17).
- To operate the shutter release button of the remote control, set in [17. Remote Control in Bulb] in the [C Custom Setting 3] menu (p.86).
- When the sensitivity is set to [AUTO] and the exposure mode is set to **B** mode, the sensitivity is the lowest sensitivity set in “Setting the Range of Automatic Sensitivity Correction” (p.90).
- When the exposure mode is set to **B**, the upper sensitivity limit is ISO 1600.
- There is no limit on exposure time for Bulb shooting. However, we recommend using the AC adapter kit K-AC50 (optional) when shooting with a long exposure setting as the battery is used while the shutter remains open. (p.47)

## e-dial in **B** & **X** modes

You can set the functions of the front and rear e-dials in **B** and **X** modes. Set in [27. e-dial in B & X modes] in the [C Custom Setting 4] menu (p.86).

Settings	Front e-dial (☀️)	Rear e-dial (🌑)
1	– (Not Available)	<b>Av</b> (Aperture)
2	<b>Av</b> (Aperture)	– (Not Available)
3	Sensitivity	<b>Av</b> (Aperture)
4	<b>Av</b> (Aperture)	Sensitivity

## Using the X (Flash X-Sync Speed) Mode

The shutter speed is locked at 1/180 seconds. Use this when using an external flash that does not automatically set the sync speed.

### 1 Set the mode dial to X.

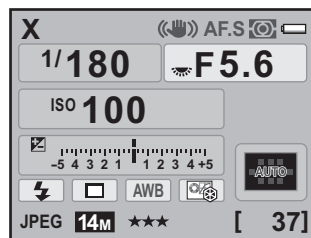
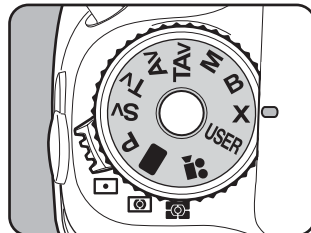





4



- Turn the rear e-dial (☀️) to adjust the aperture value.
- Press the Ⓞ (Green) button to retain the shutter speed at 1/180 seconds and automatically adjust the aperture.
- When the sensitivity is set to [AUTO] and the exposure mode is set to **X** mode, the sensitivity is the lowest sensitivity set in “Setting the Range of Automatic Correction in AUTO” (p.90).

## Selecting the Metering Method

Choose the part of the screen to use for measuring brightness and determining exposure. The following three methods can be selected. The factory default setting is  (Multi-segment metering).

 Multi-segment	Segments the viewfinder in 77 parts, meters each portion and determines the appropriate exposure.
 Center-weighted	Measures the entire viewfinder with an emphasis on the center and determines the exposure.
 Spot Metering	Measures only the center of the viewfinder and determines exposure.

### 1 Turn the metering mode switching lever.

The set metering method is displayed in the viewfinder and status screen.

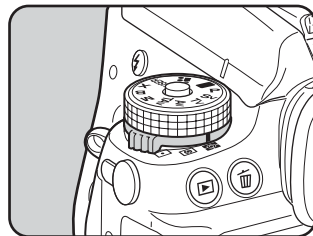

4

### Using the Multi-Segment Metering

The scene in the viewfinder is metered in 77 different zones as shown in the illustration when using the multi-segment metering. Even in backlit locations, this mode automatically determines what level of brightness is in which portion and automatically adjusts exposure.

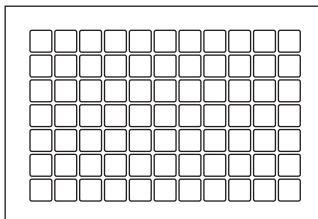

The center-weighted metering mode is automatically set even if you select the multi-segment metering mode when using a lens other than a DA, DA L, D FA, FA J, FA, F or A lens, or when lens aperture ring is set to other than **A** (Auto). (Can only be used if [37. Using Aperture Ring] (p.294) in the [C Custom Setting 6] menu is set to [Permitted].)

## Linking AE to AF Point during Multi-Segment Metering

In [6. Link AE to AF Point] of the [C Custom Setting 1] menu (p.85), you can link the exposure and AF point in the focusing area during multi-segment metering.

1	Off	Exposure is set separately from AF point. (default setting)
2	On	Exposure is set in accordance with AF point.

## Using the Center-Weighted Metering

Metering is weighted at the center of the screen. Use this metering when you want to compensate the exposure by experience, instead of leaving it to the camera. The illustration shows that sensitivity increases as the pattern height increases (center). This mode does not automatically compensate for backlit scenes.

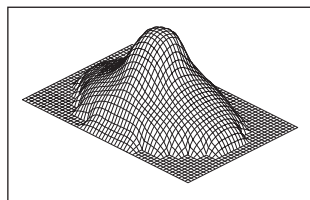

## Using the Spot Metering

With spot metering, brightness is measured only within a limited area at the center of the screen as shown in the illustration. You can use this in combination with the AE lock (p.116) when the subject is extremely small and the proper exposure is difficult to obtain.

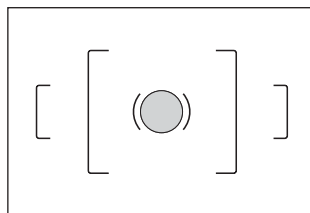

## Setting the Meter Operating Time

You can set the exposure metering time to [10sec.] (default setting), [3sec.] or [30sec.] in [4. Meter Operating Time] in the [C Custom Setting 1] menu (p.85).

## Adjusting the Exposure

This allows you to deliberately overexpose (brighten) or under-expose (darken) your picture.

Select 1/3 EV or 1/2 EV in [1. EV Steps] in the [C Custom Setting 1] menu. You can adjust the EV compensation from -5 to +5 (EV).

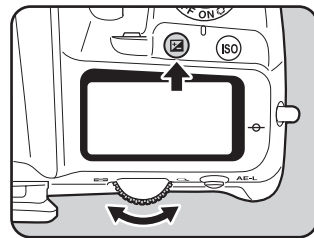

### 1 Turn the rear e-dial (☀️) while pressing the button.

The exposure is adjusted.



 is displayed on the LCD panel and in the viewfinder during compensation.

Press the  button to confirm the compensation value.

The EV compensation value is reset to 0.0 when the  (Green) button is pressed while holding down the  button.



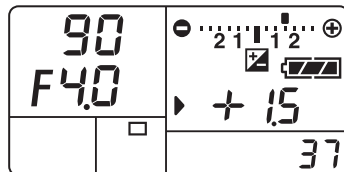

Compensation value



EV compensation is not available when the exposure mode is set to  (Green) or **B** (Bulb) mode.



- To set the EV compensation, you can also press the  button once and take your finger off the button, and then turn the rear e-dial (☀️) to change the EV compensation. In this case, press the  button again or turn off the exposure metering timer (p.114) to set the EV compensation.
- The EV compensation is not canceled by turning the camera off or by setting any other exposure mode.

## EV Compensation for M and X modes

For example, if the EV compensation value is set to +1.5 for **M** (Hyper-manual) and **X** (Flash X-sync speed) modes, an underexposure of 1.5 EV is displayed on the EV bar. If you set the exposure value so that the **|** is displayed at the center of the EV bar, the image will be captured with the compensated value.



## Changing the Exposure Steps

Set the exposure steps in [1. EV Steps] in the [C Custom Setting 1] menu (p.85) to increments of 1/3 EV or 1/2 EV.

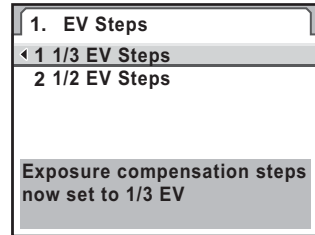

Step interval	Exposure setting value
1/3 EV	±0.3, ±0.7, ±1.0, ±1.3, ±1.7, ±2.0, ±2.3, ±2.7, ±3.0, ±3.3, ±3.7, ±4.0, ±4.3, ±4.7, ±5.0
1/2 EV	±0.5, ±1.0, ±1.5, ±2.0, ±2.5, ±3.0, ±3.5, ±4.0, ±4.5, ±5.0

## Locking the Exposure Before Shooting (AE Lock)

AE lock is a function that locks the exposure prior to taking the picture. Use this when the subject is too small or backlit and a proper exposure setting cannot be obtained.

## 1 Press the **AE-L** button.

The camera locks the exposure (brightness) at that instant.

\* is displayed in the status screen and viewfinder while the AE lock is engaged. (p.23, p.31)

Press it again to unlock.

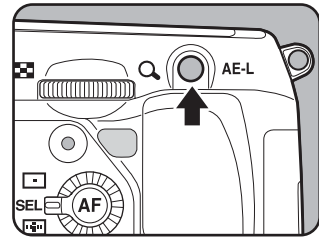

- The exposure remains locked as long as the **AE-L** button is kept pressed or the shutter release button is kept pressed halfway. The exposure remains in memory for a period between 0.5× to 2× the metering timer (p.114) even after taking your finger off the **AE-L** button.
- You will hear a beep when the **AE-L** button is pressed. The beep can be turned off. (p.257)
- AE lock is not available in **■** (Green), **B** (Bulb) or **X** (Flash X-sync Speed) mode.
- When any of the following operations are performed, AE lock is canceled.
  - The **AE-L** button is pressed again
  - The  button, **MENU** button or **INFO** button is pressed
  - The mode dial is turned
  - The lens is changed
  - The lens with an aperture **A** (Auto) position is set to other than the **A** position
- The combination of shutter speed and aperture value changes depending on the zooming position even while the AE lock is engaged when using a zoom lens for which the maximum aperture varies depending on the focal length. However, the exposure value does not change and the picture is taken at the brightness level set by the AE lock.
- Exposure can be locked when the focus is locked. Set in [5. AE-L with AF Locked] in the [**C** Custom Setting 1] menu. (p.126)

## Shooting While the Exposure is Automatically Changed

Auto Bracket is a function for continuously shooting images with the exposure automatically adjusted for underexposure and overexposure. Each time the shutter release button is pressed, 3 or 5 shots are taken. Refer to “Shooting while Adjusting the Settings (Auto Bracket)” (p.148).

You can focus with the following methods.

<b>AF</b> Autofocus	The camera automatically focuses on the subject when the shutter release button is pressed halfway.
<b>MF</b> Manual focus	Manually adjust the focus.

## Using the Autofocus

You can also choose the autofocus mode from **A.F.S** (Single mode) where the shutter release button is pressed halfway to focus on the subject and the focus is locked at that position, and **A.F.C** (Continuous mode) where the subject is kept in focus by continuous adjustment while the shutter release button is pressed halfway. The factory default setting is **A.F.S**.

- 1 Turn the focus mode lever to **A.F.S** or **C**.

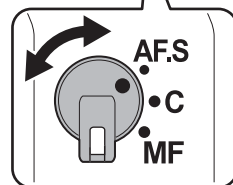
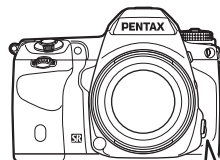



<p><b>A.F.S</b> (Single mode)</p>	<p>When the shutter release button is pressed halfway to focus on the subject, the focus is locked at that position.</p> <ul style="list-style-type: none"> <li>• The focus is locked while  is lit. To focus on another subject, take your finger off the shutter release button first.</li> <li>• The shutter cannot be released until the subject is in focus. If the subject is too close to the camera, move back and take the picture. Adjust the focus manually if it is difficult to focus on the subject (p.70). (p.126)</li> <li>• Press the shutter release button halfway. The AF assist light will flash automatically, making it easier to focus on the subject if the subject is in a dark area. (Effective range: up to 5 m)</li> </ul>
<p><b>A.F.C</b> (Continuous mode)</p>	<p>The subject is kept in focus by continuous adjustment while the shutter release button is pressed halfway. Even if the subject is not in focus, the shutter can be released when the shutter release button is pressed fully.</p> <ul style="list-style-type: none"> <li>• When the shutter release button is pressed halfway to focus, the camera automatically tracks the subject if it is determined to be a moving object. The lens will automatically operate and continuously focus on the subject.</li> </ul>

## 2 Look through the viewfinder and press the shutter release button halfway.

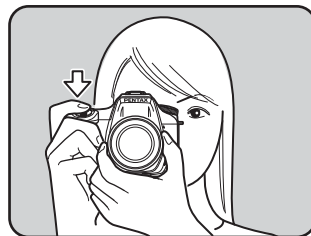

The focus indicator  appears in the viewfinder and you will hear a beep when the subject comes into focus. (When blinking, the subject is not in focus.)

- ☞ Subjects that are Difficult to Focus on (p.70)



Focus Indicator

## Using the AF Button to Focus on the Subject

You can set the camera so that the focusing is performed when the **AF** button is pressed.

- 1 **Select [Enable AF] in [13. AF Button Function] in the [C Custom Setting 2] menu.**

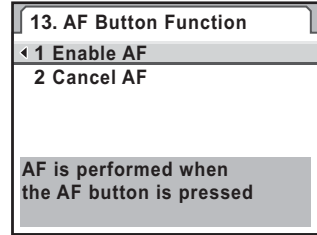

Enable AF	Auto focusing is performed by using the <b>AF</b> button or the shutter release button. (default setting)
Cancel AF	<b>MF</b> appears in the viewfinder while the <b>AF</b> button is pressed. Autofocus does not activate when the shutter release button is pressed. (Take your finger off the <b>AF</b> button to return to normal autofocus mode.)

- 2 **Press the AF button.**

Auto focusing is performed.

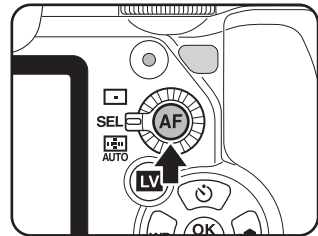

<b>A.F.S</b> (Single mode)	When the subject is focused by pressing the <b>AF</b> button, the focus lock is activated while the button is pressed.
<b>A.F.C</b> (Continuous mode)	The subject is kept in focus when the <b>AF</b> button is pressed.

- 3 **Press the shutter release button.**

The picture is taken.

## AF Adjustment

You can adjust the AF focusing position.



- **Be sure to use [AF Adjustment] only when necessary.** Care should be taken as adjusting the autofocus may make it difficult to capture images with the appropriate focus.
- Any camera shake during test shooting may make it difficult to obtain the accurate focusing position. Therefore, always use a tripod when taking test shots.

- 1** Select [36. AF Adjustment] in the [C Custom Setting 6] menu and press the four-way controller (▶).
- 2** Use the four-way controller (▲ ▼) to select [On] and press the four-way controller (▶).

The [AF Adjustment] screen appears.

- 3** Use the four-way controller (▲ ▼) to select [Apply All] or [Apply One].

Apply All	Applies the same adjustment value to all lenses.
Apply One	This item will appear on the display only when the lens ID is obtained. Saves and applies an adjustment value for each lens type. (Up to 20 lens types)

- 4** Press the four-way controller (▶) and adjust the value with the rear e-dial (☀) or the four-way controller (◀ ▶).

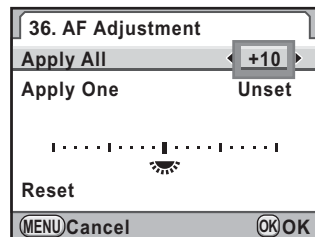

### Available operations

Four-way controller (▶) or rear e-dial (☀) to the right (Q)	Adjusts the focus to a closer position.
Four-way controller (◀) or rear e-dial (☀) to the left (Q)	Adjusts the focus to a farther position.
⊙ (Green) button	Resets the adjustment value to ±0.

## 5 Press the **OK** button.

The adjustment value is saved.

## 6 Press the **MENU** button.

The camera returns to the Capture mode.

## 7 Take a test picture.

You can easily check the focusing position by enlarging the image during Live View (p.156) or Digital Preview (p.131).





- Even when an adjustment value has been saved using [Apply One], if you press the **OK** button with [Apply All] selected in Step 3, the [Apply All] value is used instead of the [Apply One] value.
- To reset a saved adjustment value, select [Reset] in Step 3.

## Selecting the Focusing Area (AF Point)

Choose the part of the viewfinder to set focus to. The factory default setting is  (Auto).

The selected AF point lights red in the viewfinder (Superimpose AF Area).

 Center	Sets the focusing area to the center of the viewfinder.
<b>SEL</b> Select	Sets the focusing area to one of the eleven points in the AF area.
 Auto	The camera selects the optimum AF point even if the subject is not centered.

Set with the AF point switching dial.

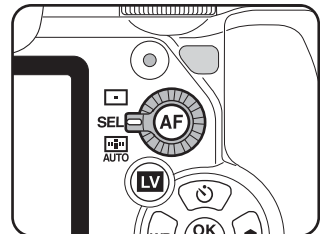

- AF point is not displayed in the viewfinder when [Off] is selected for [15. Superimpose AF Area] in the [C Custom Setting 3] menu (p.86).
- The AF point is fixed to  regardless of this setting when using lenses other than DA, DA L, D FA, FA J, FA or F lens. (p.292)

## Setting the Focus Position in the Viewfinder

- 1 Set the AF point switching dial to SEL.

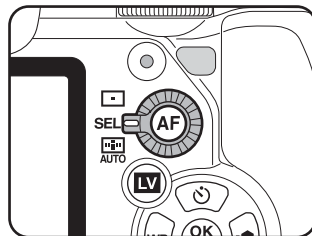

- 2 Look through the viewfinder and check the position of the subject.

- 3 Press the OK button.

 appears in the viewfinder and the AF point can be changed.

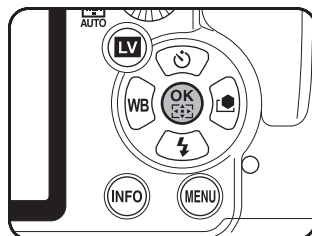

- 4 Use the four-way controller (▲▼◀▶) to select the desired AF point.

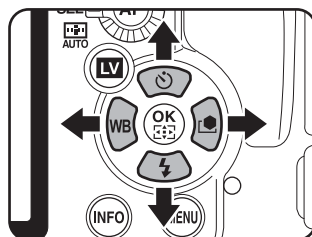

The AF point lights red in the viewfinder (Superimpose AF Area) and you can check where you set the AF point.

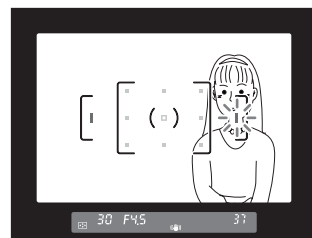



- The position of the changed AF point is stored even if the camera is turned off or the focusing area is switched to or AUTO.
- When any of the following operations are performed, changing of the AF point (in Step 3) is canceled.
  - The main switch is turned off
  - The mode dial is turned
  - The AF point switching dial is turned
  - The **OK** button, button, **MENU** button, **INFO** button or button is pressed

## Fixing the Focus (Focus Lock)

4

Shooting Functions

If the subject is outside the range of the focusing area, the camera cannot automatically focus on the subject. In this situation, you can aim the focusing area toward the subject, use the focus lock and recompose the picture.

1

**Turn the focus mode lever to AFS.**

2

**Frame the desired composition for your picture in the viewfinder.**

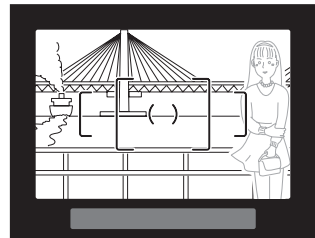

Example:

The person is out of focus and the background is focused instead.

### 3 Center the subject to focus in the viewfinder and press the shutter release button halfway.

The focus indicator ● appears in the viewfinder and you will hear a beep when the subject comes into focus. (When blinking, the subject is not in focus.)

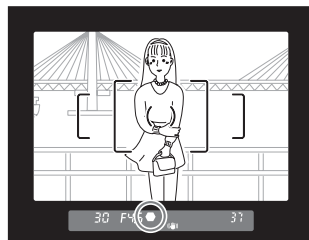

### 4 Lock the focus.

Keep the shutter release button pressed halfway. The focus will remain locked.

### 5 Recompose the picture while keeping the shutter release button pressed halfway.

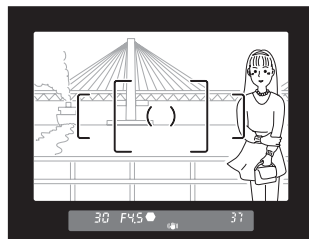

- The focus is locked while the focus indicator ● is displayed.
- Turning the zoom ring with the focus locked may cause the subject to be out of focus.
- The beep that sounds when the image is focused can be turned off. (p.257)

## Locking Exposure when Focus is Locked

Set [5. AE-L with AF Locked] in the [C Custom Setting 1] menu (p.85) to lock the exposure value while the focus is locked.

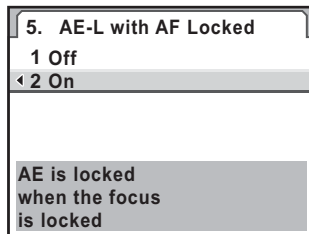



1	Off	Exposure is not locked when the focus is locked. (default setting)
2	On	Exposure is locked when the focus is locked.

## Adjusting the Focus Manually (Manual Focus)

When you adjust the focus manually, you can use either the focus indicator or the matte field in the viewfinder.

### Using the Focus Indicator

The focus indicator  appears in the viewfinder when the subject is in focus even during manual focus.

You can manually adjust the focus using the focus indicator .

### 1 Turn the focus mode lever to **MF**.

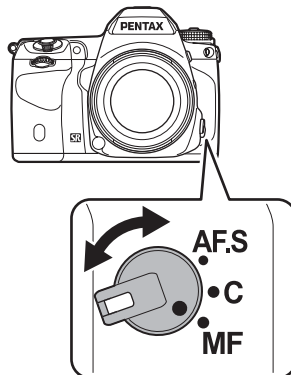



- 2** Look through the viewfinder, press the shutter release button halfway and turn the focusing ring.

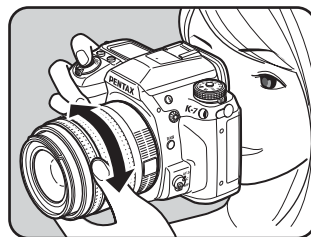

The focus indicator  appears in the viewfinder and you will hear a beep when the subject comes into focus.



Focus Indicator



- Adjust the focus manually using the matte field in the viewfinder when the subject is difficult to focus (p.70) and the focus indicator will not stay lit.
- The beep that sounds when the image is focused can be turned off. (p.257)

## Using the Viewfinder Matte Field

You can manually adjust the focus using the matte field in viewfinder.

- 1** Turn the focus mode lever to **MF**.

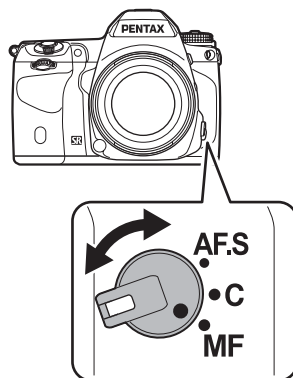

- 2 Look through the viewfinder and turn the focusing ring until the subject is clearly visible on the focusing screen.

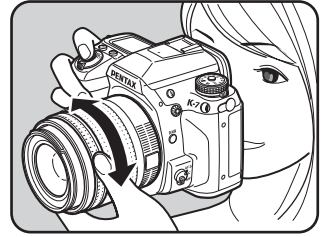

### Shooting in Catch-in Focus Mode

When [35. Catch-in Focus] in the [C Custom Setting 5] menu (p.87) is set to [On], if the focus mode is set to **A.F.S** and one of the following types of lenses is attached, catch-in focus shooting is available and the shutter is released automatically when the subject comes into focus.

- Manual focus lens
- DA or FA lens that has a **AF/MF** switching on the lens (the setting on the lens must be set to **MF** before shooting)

#### ● How to Take Pictures

- 1 Attach a proper lens to the camera.
- 2 Turn the focus mode lever to **A.F.S**.
- 3 Set the focus on a position the subject will pass.
- 4 Press the shutter release button fully.

The shutter is released automatically when the subject comes into focus in the set position.

# Checking the Composition, Exposure and Focus Before Shooting (Preview)

You can use the preview function to check the depth of field, composition, exposure and focus before taking a picture.

There are two preview methods.

Preview Method	Description
Optical Preview	For checking the depth of field with the viewfinder.
Digital Preview	For checking the composition, exposure and focus on the monitor.



You can also use the Live View function to display a real-time image on the monitor and change the shooting function settings during display and check the settings by enlarging the image. Refer to p.156 for details.

## Selecting the Preview Method

Choose whether to use Optical Preview or Digital Preview when the main switch is turned to the preview position (⌚).

The default setting is Optical Preview.

- 1 Select **[Digital Preview]** in the [ Rec. Mode 3] menu and press the four-way controller (▶).

The [Digital Preview] screen appears.

- 2 Press the four-way controller (▶).

- 3 Use the four-way controller (▲▼) to select **[Off (Optical Preview)]** or **[On]**.

Selecting [On] activates Digital Preview.

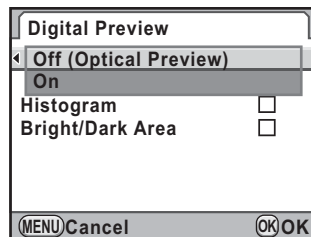

- 4 Press the **OK** button.

- 5** When [On] is selected in Step 2, use the four-way controller (▲▼) to select [Histogram] or [Bright/Dark Area], and use the four-way controller (◀▶) to select  or .

- 6** Press the MENU button twice.



While setting Multi-exposure or shooting with Live View, or during interval shooting, Optical Preview is used regardless of the setting.

4

Shooting Functions

## Displaying the Optical Preview

- 1** Position the subject inside the AF frame and press the shutter release button halfway to focus on the subject.

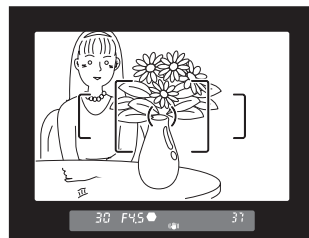

- 2** Turn the main switch to while looking through the viewfinder.

You can check the depth of field in the viewfinder while the main switch is set to the position .

During this time, no shooting information is displayed in the viewfinder, and the shutter cannot be released.

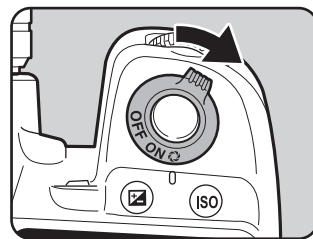



- 3** Take your finger off the main switch.

Optical Preview is ended and the camera is ready to take a picture.

## Displaying the Digital Preview

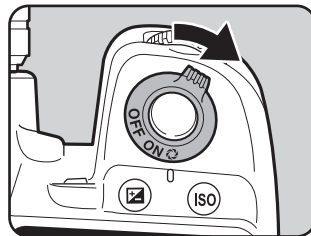
- 1 **Focus on the subject, then compose the picture in the viewfinder and turn the main switch to .**



The icon () appears on the monitor during preview and you can check the composition, exposure and focus.



### Available operations

Rear e-dial (  )	Enlarges the preview image. (p.214)
<b>AE-L</b> button	Saves the preview image. Select [Save as] and press the <b>OK</b> button.

- 2 **Press the shutter release button halfway.**

Digital Preview is ended and the autofocus system operates.



The maximum display time for Digital Preview is 60 seconds.

# Preventing Camera Shake during Shutter Release

## Using the Shake Reduction Function

The Shake Reduction function reduces camera shake that occurs when the shutter release button is pressed. This is useful for taking pictures in situations where camera shake is likely to occur. The Shake Reduction function allows you to take pictures at approximately 4 steps slower shutter speed without the risk of the camera shake.

The Shake Reduction function is ideal when taking pictures in the following situations.

- When taking pictures in dimly lit locations, such as indoors, at night, on cloudy days and in the shade
- When taking telephoto pictures

Blurred picture



Picture taken with the Shake Reduction function



The Shake Reduction function can be used to reduce horizontal and vertical camera shake or keep the image level.



- The Shake Reduction function does not compensate for blurring caused by subject movement. To take pictures of a moving subject, increase the shutter speed.
- The Shake Reduction function may not fully reduce camera shake when taking close-up shots. In this case, it is recommended that the Shake Reduction function be turned off and the camera be used with a tripod.
- The Shake Reduction function will not fully work when shooting with a slower shutter speed, for example when shooting a moving subject or night scenes. In this case, it is recommended that the Shake Reduction function be turned off and the camera be used with a tripod.

## Reducing Vertical and Horizontal Camera Shake

**1** Select [Shake Reduction] in the [**📷** Rec. Mode 4] menu.

**2** Use the four-way controller (◀▶) to select (👉) or (👈).

(👉): Uses Shake Reduction. (default setting)

(👈): Does not use Shake Reduction.

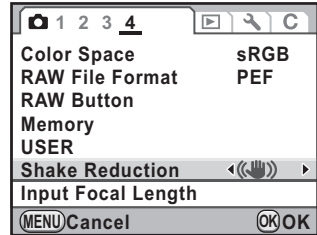

**3** Press the **MENU** button.

The screen that was displayed before selecting the menu appears again.

**4** Aim the camera at the subject and press the shutter release button halfway.

(👉) appears in the viewfinder and the Shake Reduction function is activated.



## Correcting the Tilt of the Images

**1** Select [Horizon Correction] in the [**📷** Rec. Mode 3] menu.

**2** Use the four-way controller (◀▶) to select  or .

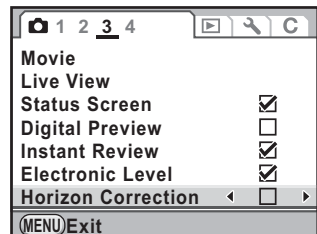

**3** Press the **MENU** button.

The screen that was displayed before selecting the menu appears again.



## 4 Aim the camera at the subject and press the shutter release button halfway.

The following indicators appear on the status screen.

: Shake Reduction On + Horizon Correction On

: Shake Reduction Off + Horizon Correction On



- Set [Shake Reduction] to  (Off) when using the camera with a tripod or when this function is not needed.
- [Shake Reduction] is automatically set to  (Off) and cannot be selected in the following situations.
  - Self-timer shooting
  - Remote control shooting
  - Bulb shooting
  - HDR Capture
  - Mirror lock-up shooting
  - Wireless mode with an external flash



- The Shake Reduction function will not fully work (for about 2 seconds) right after turning on the camera or restoring from Auto Power Off. Wait for the Shake Reduction function to become stable before gently pressing the shutter release button to take a picture. When you press the shutter release button halfway and if  appears in the viewfinder, the camera is ready to take a picture.
- The Shake Reduction function is available with any **K-7** compatible PENTAX lens. However, when the aperture ring is set to other than the **A** (Auto) position or a lens without an **A** position is used, the camera does not operate unless [37. Using Aperture Ring] in the [**C** Custom Setting 6] menu is set to [Permitted]. Set this beforehand. However, in such cases some functions are restricted. Refer to "Notes on [37. Using Aperture Ring]" (p.294) for details.



## When the Focal Length Cannot Be Automatically Detected

The Shake Reduction function operates by obtaining the lens information such as focal length.

If the camera uses a DA, DA L, D FA, FA J, FA or F lens, the lens information is automatically obtained when the Shake Reduction function is activated.

The [Input Focal Length] setting screen appears when the camera is turned on with [Shake Reduction] set to (☞) (On) and a type of lens that does not support automatic obtaining the lens information such as focal length (p.292) is mounted.

Set the focal length manually in the [Input Focal Length] setting screen.



- The [Input Focal Length] setting screen does not appear when using a lens that supports automatic obtaining the lens information such as focal length.
- When using a lens without the **A** position on the aperture or with the aperture set to a position other than the **A** position, set [37. Using Aperture Ring] in the [C Custom Setting 6] menu to [Permitted]. (p.294)

1

### Use the four-way controller (◀▶) or the rear e-dial (☞) to set the focal length.

Select from the following 34 focal length values. (The default setting is [35].)

8	10	12	15	18	20	24	28	30	35
40	45	50	55	65	70	75	85	100	120
135	150	180	200	250	300	350	400	450	500
550	600	700	800						

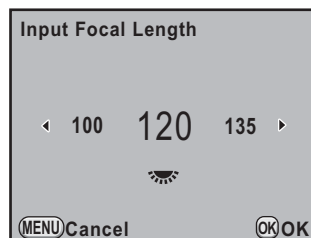

- If the focal length for your lens is not listed above, select the value closest to the actual focal length (example: [18] for 17 mm and [100] for 105 mm).
- When using a zoom lens, select the actual focal length at the zoom setting in the same manner.

2

### Press the OK button.

The camera returns to the status screen and is ready to take a picture.



- To change the focal length setting, use [Input Focal Length] in the [📷 Rec. Mode 4] menu (p.84).
- Effect of Shake Reduction is influenced by the shooting distance as well as focal length information. The Shake Reduction function may not work as effectively as expected when shooting at close ranges.

## Shooting with the Self-timer

This camera has the following two types of self-timers.

	Shutter will be released after about 12 seconds. Use this mode to include the photographer in the picture.
	A mirror pops up immediately after shutter release button is pressed. Shutter is released after about 2 seconds. Use this mode to avoid camera shake when the shutter release button is pressed.

### 1 Mount the camera onto a tripod.

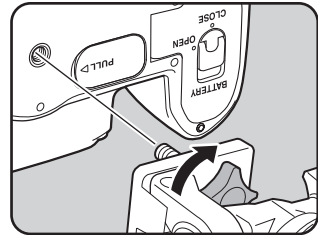



### 2 Press the four-way controller (▲) in Capture mode.

The [Drive Mode] screen appears.

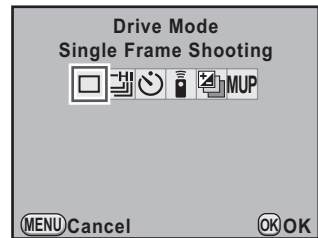
### 3 Use the four-way controller (◀▶) to select ⌚.



- 4** Press the four-way controller (▼) and use the four-way controller (◀▶) to select  or .

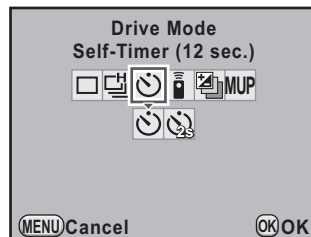

- 5** Press the OK button.

The camera is ready to take a picture.

- 6** Press the shutter release button halfway.

The autofocus system operates. The focus indicator  appears in the viewfinder when focused.



- 7** Press the shutter release button fully.

For , the front and back self-timer lamps start blinking slowly and blink rapidly 2 seconds before the shutter is released. The beep is heard and the rate increases. The shutter will be released about 12 seconds after the shutter release button is pressed fully.

For , the shutter will be released about 2 seconds after the shutter release button is pressed fully.

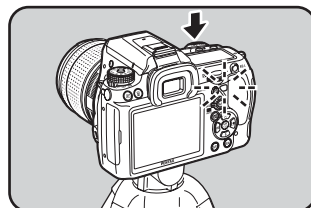
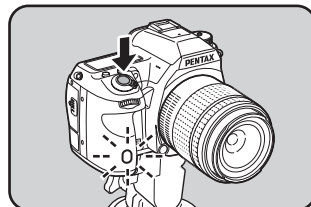



- You can set the camera so that the beep does not sound. (p.257)
- Exposure may be affected if the light enters the viewfinder. Attach the provided ME viewfinder cap or use the AE lock function (p.116). The light entering the viewfinder has no effect on the exposure when the exposure mode is set to **M** (Manual) (p.107).

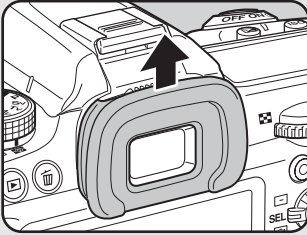

Removing the Eyecup FR

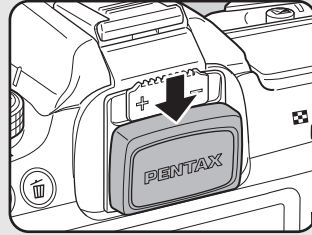

Attaching the ME Viewfinder cap

- Select a mode other than or in the [Drive Mode] screen to cancel the self-timer shooting. The setting is canceled when the camera is turned off if [Drive Mode] in [Memory] (p.281) of the [Rec. Mode 4] menu is set to  (Off).
- [Shake Reduction] is automatically set to (Off) when or is set.

4

## Shooting with the Remote Control (Optional)

The shutter can be released from a distance by using the optional remote control unit. This camera has the following three types of remote control shooting modes.

Remote Control	The shutter will be released immediately after the shutter release button on the remote control unit is pressed.
Remote Control (3s delay)	When the shutter release button on the remote control unit is pressed, the shutter is released after about 3 seconds.
Remote Continuous Shooting	Continuous shooting starts when the shutter release button on the remote control unit is pressed. Press the shutter release button on the remote control unit again to exit continuous shooting.

# 1 Mount the camera onto a tripod.

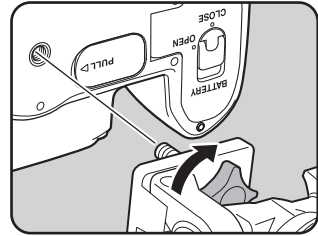

# 2 Press the four-way controller (▲) in Capture mode.

The [Drive Mode] screen appears.

# 3 Use the four-way controller (◀▶) to select .

# 4 Press the four-way controller (▼) and use the four-way controller (◀▶) to select , , or .

 appears on the LCD panel. The self-timer lamp will blink to let you know that the camera is in remote control wait status.

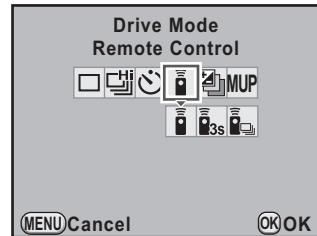

# 5 Press the OK button.

The camera is ready to take a picture.

# 6 Press the shutter release button halfway.

The autofocus system operates. The focus indicator  appears in the viewfinder when focused.

## 7

**Point the remote control unit towards the remote control receiver on the front or back of the camera and press the shutter release button on the remote control.**

The operating distance of the remote control unit is approximately 4 m from the front of the camera and approximately 2 m from the back of the camera.

After the picture is taken, the self-timer lamp lights for 2 seconds and then returns to blinking.

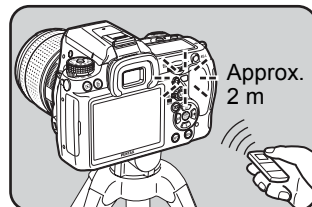
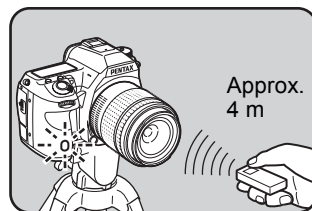

## 4



- You cannot focus with the remote control unit in default settings. Focus on the subject first with the camera before operating with the remote control. You can use the remote control to focus with [16. AF with Remote Control] in the [C Custom Setting 3] menu (p.86).
- Exposure may be affected if the light enters the viewfinder. Attach the provided ME viewfinder cap or use the AE lock function (p.116). The light entering the viewfinder has no effect on the exposure when the exposure mode is set to **M** (Manual) (p.107).

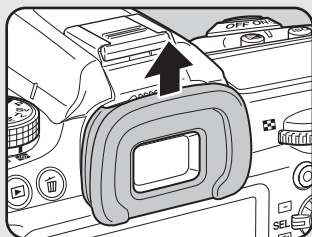

Removing the Eyecup FR

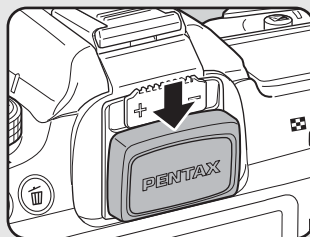

Attaching the ME Viewfinder cap

- Select a mode other than , or in the [Drive Mode] screen to cancel the remote control shooting. The setting is canceled when the camera is turned off if [Drive Mode] in [Memory] (p.281) of the [Rec. Mode 4] menu is set to  (Off).
- [Shake Reduction] is automatically set to (Off) when , or is set.
- The remote control shooting may not be available in blackout conditions.
- The remote control unit battery can send a remote control signal about 30,000 times. Contact PENTAX Service Center to replace the battery (this will involve a fee).

## Shooting with the Mirror Lock-up Function

Use the Mirror Lock-up function if camera shake is evident even when the remote control or cable switch is used with a tripod.

To use the Mirror Lock-up function, press the shutter release button to raise the mirror up. Press it again to release the shutter.

This camera has the following two types of the mirror lock-up shooting.

<b>M.UP</b>	Mirror lock-up	Mirror lock-up shooting with the shutter release button.
<b>M<sub>UP</sub></b>	Mirror lock-up remote control	Mirror lock-up shooting with the remote control. The shutter will be released immediately after the shutter release button on the remote control unit is pressed. (p.138)

### 1 Mount the camera onto a tripod.

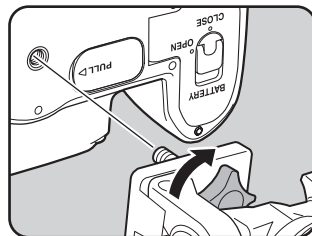

### 2 Press the four-way controller (▲) in Capture mode.

The [Drive Mode] screen appears.

### 3 Use the four-way controller (◀▶) to select M.UP.

### 4 Press the four-way controller (▼) and use the four-way controller (◀▶) to select M.UP or M<sub>UP</sub>.

M.UP appears on the LCD panel.

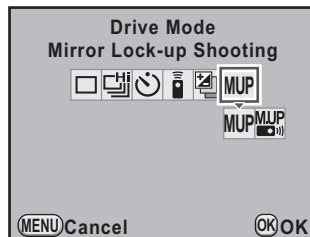

## 5 Press the OK button.

The camera is ready to take a picture.

## 6 Press the shutter release button halfway.

The autofocus system operates. The focus indicator  appears in the viewfinder when focused.

## 7 Press the shutter release button fully.

The mirror pops up. AE lock function is enabled with the exposure value set immediately before the mirror pops up.

## 8 Press the shutter release button fully again.

The shutter is released and the picture is taken.





- The mirror automatically returns to its original position if 30 seconds elapse after the mirror pops up when the shutter release button is pressed for the first time (except while setting Multi-exposure).
- [Shake Reduction] is automatically set to  (Off) when **MUP** or **MUP** is set.
- Select a mode other than **MUP** or **MUP** in the [Drive Mode] screen to cancel the mirror lock-up shooting. The setting is canceled when the camera is turned off if [Drive Mode] in [Memory] (p.281) of the [Rec. Mode 4] menu is set to  (Off).





## Continuous Shooting

Pictures can be taken continuously while the shutter release button is held down.

This camera has the following two types of continuous shooting.

 Continuous Shooting (Hi)	When [JPEG Recorded Pixels] is set to <b>14M</b> and [JPEG Quality] is <b>★★★</b> , pictures are taken continuously at approximately 5.2 frames per second. Up to 40 frames can be shot in one sequence.
 Continuous Shooting (Lo)	When [JPEG Recorded Pixels] is set to <b>14M</b> and [JPEG Quality] is <b>★★★</b> , pictures are taken continuously at approximately 3.3 frames per second. Pictures can be taken continuously until the SD Memory Card is full.



When the file format is [RAW], up to 15 frames (PEF) for  (Continuous Shooting (Hi)) or up to 17 frames (PEF) for  (Continuous Shooting (Lo)) can be taken continuously.

**1**



**Press the four-way controller (▲) in Capture mode.**

The [Drive Mode] screen appears.

**2**

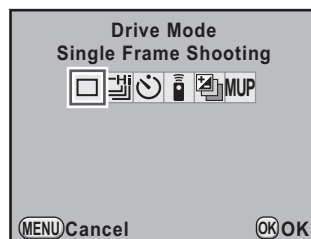
**Use the four-way controller (◀▶) to select .**

**3**

**Press the four-way controller (▼) and use the four-way controller (◀▶) to select  or .**

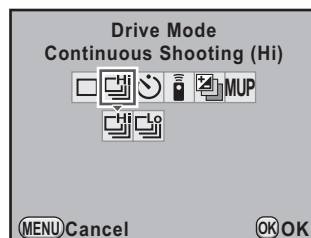

4

Shooting Functions

## 4 Press the OK button.

The camera is ready to take pictures continuously.



## 5 Press the shutter release button halfway.

The autofocus system operates. The focus indicator  appears in the viewfinder when focused.

## 6 Press the shutter release button fully.

Pictures are taken continuously while the shutter release button is fully pressed. Take your finger off the shutter release button to stop.





- If the focus mode is set to **A.F.S** (Single mode), the focus position is locked on the first frame and pictures are taken continuously at the same interval.
- Focusing is continuously active during continuous shooting when the focus mode is set to **A.F.C** (Continuous mode).
- You can also use the remote control for continuous shooting. (p.138)
- The shutter cannot be released until charging is complete when using the built-in flash. You can set the camera to enable shutter release while charging the built-in flash in [30. Release While Charging] in the [C Custom Setting 5] menu. (p.77)
- Select a mode other than  or  in the [Drive Mode] screen to cancel the continuous shooting. The setting is canceled when the camera is turned off if [Drive Mode] in [Memory] (p.281) of the [Rec. Mode 4] menu is set to  (Off).
- The shooting speed may be slower when [Lens Correction] (p.201) is set to  (On).

## Interval Shooting

During interval shooting, pictures are taken at a set interval from a set time.



Interval shooting is not available when the mode dial is set to **USER**,  (Green), **B** (Bulb) or  (Movie), or when Extended Bracketing, Digital Filter or HDR Capture is set.

## 1 Select [Interval Shooting] in the [Rec. Mode 2] menu and press the four-way controller (▶).

The [Interval Shooting] screen appears.

## 2 Use the four-way controller (▲▼) to select [Interval].

When taking two or more pictures, set the wait time until the next picture is taken.

Use the four-way controller (◀▶) to select the number of hours, minutes, and seconds, and use the four-way controller (▲▼) to set the time.

You can set up to 24 hours, 00 minutes, and 00 seconds.

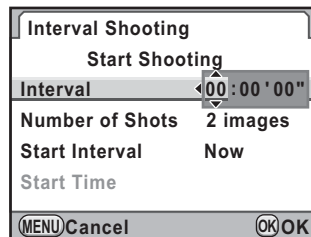

## 3 Use the four-way controller (▲▼) to select [Number of Shots].

Set the number of shots to be taken.

Press the four-way controller (▶) and use the four-way controller (▲▼) to select the number of shots to be taken.

You can select between 1 and 99 shots.

## 4 Use the four-way controller (▲▼) to select [Start Interval].

Set the time when the first picture is taken.

Press the four-way controller (▶) and use the four-way controller (▲▼) to select [Now] or [Set Time].

Now	Shooting starts immediately. You can take two or more pictures.
Set Time	Shooting starts at the set time. Press the four-way controller (▼) to select [Start Time], use the four-way controller (◀▶) to select the time, and use the four-way controller (▲▼) to set the start time.

## 5 Use the four-way controller (▲▼) to select [Start Shooting] and press the OK button.

The camera is ready to take a series of interval pictures.

## 6 Press the shutter release button halfway.

The focus indicator ● appears when the subject is in focus.

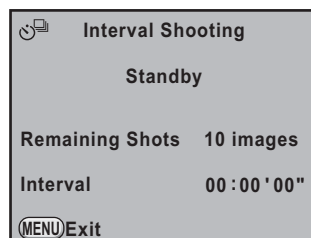

## 7 Press the shutter release button fully.

When [Start Interval] is set to [Now], the first picture is taken. When set to [Set Time], shooting starts at the set time.

For shooting multiple pictures, pictures are taken at the interval set in Step 2. After the set number of pictures is taken, the camera returns to normal Capture mode.



- The camera cannot be operated during interval shooting. To cancel the interval shooting, press any button on the back of the camera or press the shutter release button and the **MENU** button to display the exit confirmation screen, and then use the four-way controller (▲▼) to select [Exit] and press the **OK** button. You can also exit the interval shooting by turning the main switch off or turning the mode dial.
- When the interval shooting is set, Extended Bracketing and Multi-exposure are not available.
- Interval shooting is not available when the exposure mode is set to **B** (Bulb) mode.
- □ (Single Frame Shooting) is selected regardless of the current drive mode setting.
- If the subject is not in focus with the focus mode set to **A/FS** (Single mode) or if the [Interval] setting is too short and the previous image processing cannot be completed before taking the next picture, no picture may be taken.
- Although each shot taken is displayed on the monitor with Instant Review, they cannot be enlarged or deleted.
- The [Interval] setting is disabled when [Number of Shots] is set to [1].
- Interval shooting is canceled when the SD Memory Card has no more available space.
- If Auto Power Off function (p.270) turns the camera off during interval shooting, the camera automatically turns on again when the shooting time approaches.
- It is recommended to use the AC adapter kit K-AC50 (optional) when using the interval shooting over a long period of time. (p.47)

## Multi-exposure

You can take multiple frames while creating a single picture.



Multi-exposure is not available when the mode dial is set to **■** (Green) or **🎬** (Movie), or when Extended Bracketing, HDR Capture or Digital Filter is set.

## 1 Select [Multi-exposure] in the [📷 Rec. Mode 2] menu and press the four-way controller (▶).

The [Multi-exposure] screen appears.

## 2 Use the four-way controller (▲▼) to select [Number of Shots].

### 3 Press the four-way controller (▶) and use the four-way controller (▲▼) to select the number of shots.

Select from 2 to 9 shots.

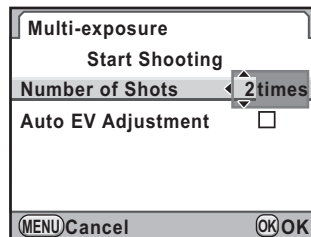

### 4 Press the OK button.

### 5 Use the four-way controller (▲▼) to select [Auto EV Adjustment] and use the four-way controller (◀▶) to select or .

When  (On) is set, the exposure is adjusted automatically according to the number of shots.

### 6 Use the four-way controller (▲▼) to select [Start Shooting] and press the OK button.

The camera returns to the Capture mode.

### 7 Take a picture.

The created picture is displayed in Instant Review each time the shutter release button is pressed. Press the button during Instant Review to discard pictures created up to that point and create again from the first picture.

The picture is saved when the set number of shots has been taken, and then the [Multi-exposure] screen appears again.



- When Multi-exposure is set, Interval Shooting and Extended Bracketing are not available.
- Multi-exposure, Exposure Bracketing and Extended Bracketing cannot be used at the same time. The mode set last is used.
- [Lens Correction] setting (p.201) is disabled when Multi-exposure is set.



- If any of the following operations are performed while shooting, the pictures that have been already taken are saved and Multi-exposure is exited.
  - The button, MENU button, four-way controller (▲▼◀▶), INFO button or RAW button is pressed
  - The mode dial is turned
  - Exposure Bracketing is set
- When shooting in Multi-exposure mode using Live View, a semi-transparent composite image of the pictures taken is displayed. (It is not displayed when outputting to an external monitor.)

# Shooting while Adjusting the Settings (Auto Bracket)

Auto Bracket is a function for shooting while automatically changing the camera settings. There are two Auto Bracket modes: Exposure Bracketing and Extended Bracketing.

You can set Auto Bracketing Order in [8. Auto Bracketing Order] in the [C Custom Setting 2] menu (p.85).

Auto Bracketing Order	0 → - → +, - → 0 → +, + → 0 → -, 0 → + → -
-----------------------	--

## Shooting while the Exposure is Automatically Changed (Exposure Bracketing)

4

Shooting Functions

You can take (3 or 5) continuous pictures with different exposure when the shutter release button is pressed. When taking 3 pictures, the first frame is exposed with no compensation, the second frame is underexposed (negative compensation) and the third is overexposed (positive compensation).



Normal exposure



Underexposure

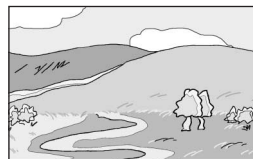





Overexposure

### 1 Press the four-way controller (▲) in Capture mode.

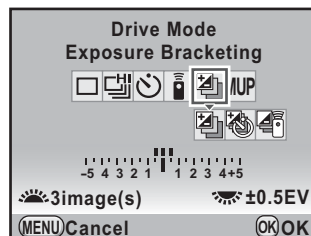



The [Drive Mode] screen appears.

### 2 Use the four-way controller (◀▶) to select .

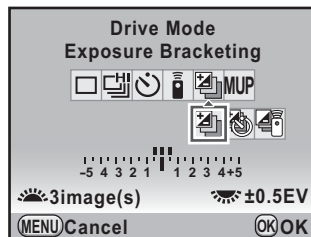

- 3** Press the four-way controller (▼) and use the four-way controller (◀▶) to select , , or .



	Shooting with the shutter release button.
	Shooting with the self-timer. Self-timer operates according to the self-timer (p.136) setting.
	Shooting with the remote control. Remote control operates according to the remote control (p.138) setting. When set to  (Remote Continuous Shooting), the shutter is released immediately.

- 4** Turn the front e-dial () to set the number of shots.

- 5** Turn the rear e-dial () to set the EV compensation value.

The following EV compensation values can be set according to the step interval set in [1. EV Steps] (p.116) in the [C Custom Setting 1] menu.

Step interval	Bracket value
1/3 EV	±0.3, ±0.7, ±1.0, ±1.3, ±1.7, ±2.0
1/2 EV	±0.5, ±1.0, ±1.5, ±2.0

- 6** Press the OK button.

The camera is ready to take a picture.

- 7** Press the shutter release button halfway.

The focus indicator  appears in the viewfinder and EV compensation value appears on the status screen and LCD panel and in the viewfinder when the subject is in focus.

## 8

**Press the shutter release button fully.**

Continue to press the shutter release button until the set number of shots has been captured.

Three or five consecutive images will be taken according to the order set in [8. Auto Bracketing Order] in the [C Custom Setting 2] menu (p.85).



- When the focus mode is set to **AFS** (Single mode), the focus is locked in the first frame position and used for subsequent continuous frames.
- Even if you take your finger off the shutter release button during Auto Bracket, the Auto Bracket exposure setting will remain effective for twice as much time as the exposure metering timer (default setting is approximately 20 seconds) (p.114) and you can take a picture at the next compensation value. In this case, auto focusing works for each frame. After about twice as much time as the exposure metering timer, the camera returns to settings for taking the first picture.
- You can combine Auto Bracket with the built-in flash or external flash (P-TTL auto only) to change only the flash output continuously. However, when using an external flash, holding the shutter release button down to take three continuous frames may cause the second and third frames to be taken before the flash is fully charged. Always take one frame at a time after confirming that charging is complete.
- Exposure Bracketing is not available when the exposure mode is set to **B** (Bulb) mode.
- Exposure Bracketing and Multi-exposure cannot be used at the same time. The mode set last is used.
- When [7. One-Push Bracketing] in the [C Custom Setting 1] menu (p.85) is set to [On], even if the shutter release button is not continuously pressed fully, all frames are automatically shot with one press of the shutter release button.

## 4

## Shooting Functions

**Taking Only Overexposed or Underexposed Pictures**

You can use Auto Bracket mode for only underexposure or overexposure shots by combining the operation with EV compensation (p.115). Auto Bracket is performed in both cases on the basis of the specified EV compensation value. (Up to  $\pm 8$  EV)



## Shooting while Adjusting Other Settings (Extended Bracketing)

You can save pictures with three different White Balance, Saturation, Hue, High/Low Key Adjustment, Contrast and Sharpness levels. Unlike Exposure Bracketing, three pictures are saved each time the shutter is released.

- 1 Select [Extended Bracketing] in the [📷 Rec. Mode 2] menu and press the four-way controller (▶).

The [Extended Bracketing] screen appears.

- 2 Press the four-way controller (▶).

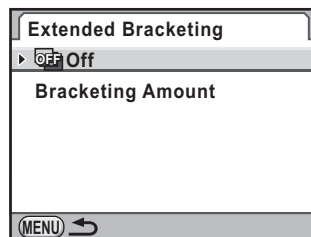

- 3 Use the four-way controller (▲▼) to choose an item.

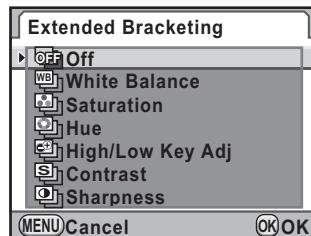

- 4 Press the OK button.

- 5 Use the four-way controller (▲▼) to select [Bracketing Amount] and press the four-way controller (▶).

## 6 Use the four-way controller (▲▼) to select the bracketing amount.

For [White Balance], select from [BA±1] (default setting), [BA±2], [BA±3], [GM±1], [GM±2] or [GM±3].

For other settings, select from [±1] (default setting), [±2], [±3] or [±4].

## 7 Press the OK button.

## 8 Press the MENU button twice.

The camera returns to the Capture mode.

## 9 Take the picture.

Three frames are saved.



- When Extended Bracketing is set, the file format is always set to [JPEG] and cannot be changed. You cannot use Extended Bracketing when the file format is set to [RAW].
- When Extended Bracketing is set, Interval Shooting and Multi-exposure are not available.
- Extended Bracketing, Digital Filter and HDR Capture cannot be used at the same time. The mode set last is used.



- Exposure Bracketing and Extended Bracketing can be used at the same time.
- When [Image Tone] for Custom Image is set to [Monochrome], [Saturation] and [Hue] are not available.
- When [Fine Sharpness] is set for Custom Image, the sharpness of Extended Bracketing operates as Fine Sharpness.
- When [Contrast] is set for Custom Image, the contrast of Extended Bracketing operates according to the [Contrast] setting.

You can apply a filter when taking pictures.  
The following filters can be selected.

Filter name	Effect	Parameter
Toy Camera	For taking pictures that look as if taken with a toy camera.	Shading Level: +1/+2/+3
		Blur: +1/+2/+3
		Tone Break: Red/Green/Blue/Yellow
Retro	For taking pictures with the look of old photos.	Toning: -3 to +3
		Frame Composite: None/Thin/Medium/Thick
High Contrast	For taking pictures with high contrasts.	+1 to +5
Extract Color	For extracting a specific color and taking the rest of the picture in black and white.	Color: Red/Magenta/Blue/Cyan/Green/Yellow
		Color Freq. Range: -2 to +2
Soft	For taking pictures with a soft focus throughout the image.	Soft Focus: +1/+2/+3
		Shadow Blur: On/Off
Star Burst	For taking pictures of night scenes or lights reflected on water with a special sparkling look achieved by adding cross-like effects to the picture's highlights.	Effect Density: Small/Medium/Large
		Size: Short/Medium/Long
		Angle: 0°/30°/45°/60°
Fish-eye	For taking pictures that look as if taken with a fish-eye lens.	Weak/Medium/Strong

Filter name	Effect	Parameter
Custom Filter	Customize and save a filter to your own preferences.	High Contrast: Off/+1 to +5
		Soft Focus: Off/+1/+2/+3
		Tone Break: Off/Red/Green/Blue/Yellow
		Shading Type: 6 types
		Shading Level: -3 to +3
		Invert Color: Off/On
		Distortion Type: 3 types
		Distortion Level: Off/Weak/Medium/Strong



- When Digital Filter is set, the file format is always set to [JPEG] and cannot be changed. You cannot use Digital Filter when the file format is set to [RAW].
- When Digital Filter is set, Interval Shooting, Multi-exposure, Continuous Shooting in the drive mode and Auto Bracket are not available.
- Digital Filter, Extended Bracketing and HDR Capture cannot be used at the same time. The mode set last is used.



Depending on the filter used, images may take longer to save.

## 1 Select [Digital Filter] in the [Rec. Mode 2] menu and press the four-way controller (▶).

The screen to select the filter appears.

## 2 Use the four-way controller (◀▶) to select a filter.

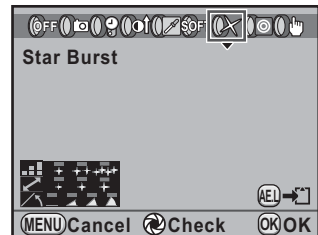

- 3** Use the four-way controller (▲▼) to select the parameter and the four-way controller (◀▶) to adjust the parameter's value.

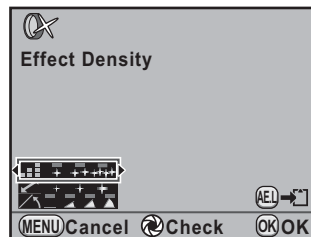

### Available operations

Main switch (⌂)	You can use Digital Preview to preview the background image with the selected filter.
<b>AE-L</b> button	Saves the background image. Select [Save as] and press the <b>OK</b> button.

### 4 Press the **OK** button.

The camera is ready to take a picture.





- Select [Not use any filters] in Step 2 to finish shooting with digital filter.
- You can also apply digital filter effects to images after shooting them in Playback mode (p.241).

# Shooting with the Live View

You can shoot a picture or a movie while displaying the real-time image on the monitor.

## Caution

- The image in Live View may differ from the captured image if the brightness of the subject is low or high.
- If any changes occur in the shooting light source during Live View, the image may flicker.
- If the camera position is changed rapidly during Live View, the image may not be displayed with the appropriate brightness. Wait for the display to become stable before shooting.
- Noise may appear on the Live View image when used in dark locations.
- If you continue shooting with the Live View for a prolonged period, the internal temperature of the camera may increase, resulting in lower quality images. It is recommended that you turn off Live View when not shooting. To prevent a decrease in image quality, allow the camera to cool down between long exposure shots and movie recording.
- If the internal temperature of the camera is high,  (temperature warning) will appear on the monitor and Live View may not be possible.
- If Live View is used in places where the camera may become hot, such as in direct sunlight,  (temperature warning) may appear on the monitor. Cancel Live View, as the internal temperature of the camera is rising.
- Live View can be displayed for up to 5 minutes. However, if Live View is used even after  (temperature warning) appears, Live View may end before 5 minutes elapse. Shooting with the viewfinder is possible even if Live View is ended.
- The higher the sensitivity, the more noise and color unevenness may occur in the Live View image and/or captured image.

## memo

- Shooting while holding the camera by hand and viewing the monitor can cause camera shake. Use of a tripod is recommended.
- The field of view of the image display is nearly 100%.
- You can use the provided AV cable (I-AVC7) or a commercially available HDMI cable to display Live View images on a TV or monitor. (p.233)
- Live View is not displayed when data are being saved to an SD Memory Card.
- When the focus mode is set to **A.F.S** and the **AF** button is pressed during Live View, the displayed image will disappear and the autofocus system operates. Once focused, the image will be displayed in Live View again.
- The aperture value and shutter speed are not displayed on the LCD panel during Live View.

# Taking Still Pictures

## Setting the Live View

You can set the display items and autofocus mode for Live View.

- 1 Select [Live View] in the [📷 Rec. Mode 3] menu and press the four-way controller (▶).

The [Live View] screen appears.

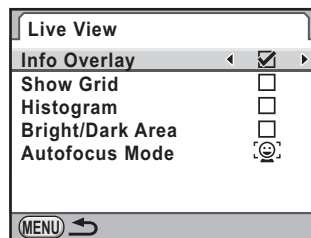

- 2 Use the four-way controller (▲▼) to select [Info Overlay], [Show Grid], [Histogram] or [Bright/Dark Area], and use the four-way controller (◀▶) to select  or .

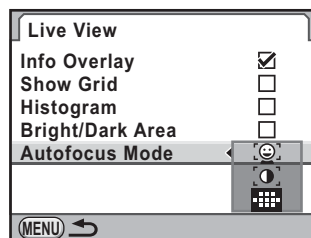

- 3 Use the four-way controller (▲▼) to select [Autofocus Mode] and press the four-way controller (▶).

- 4 Use the four-way controller (▲▼) to select an autofocus mode.



 Face Detection + Contrast AF (default setting)	Gives autofocus priority to detected faces and performs contrast autofocus. A yellow frame appears for the main face (white frames appear for other faces), and autofocus and automatic exposure are performed for the main detected face.
 Contrast AF	Displays Live View and performs autofocus based on the information obtained from the image sensor.
 Phase Difference	Cancels Live View and performs autofocus with the AF sensor.

**5** Press the **OK** button.

**6** Press the **MENU** button twice.

The screen that was displayed before selecting the menu appears again.



- It takes more time to focus on the subject when using [Contrast AF] than when using [Phase Difference]. It is also difficult for the camera to focus on the following objects (or with the following conditions).
  - Objects with poor contrast
  - Objects with no vertical contrast, such as horizontal stripes
  - Objects with constantly changing brightness, shape, or color, such as a water fountain
  - Objects whose distance from the camera is changing
  - Small objects
  - Objects appearing in both the foreground and background
  - When using a special filter
  - Objects at the edge of the screen
- Face detection is not performed when the focus mode is set to **MF**.

## Taking a Still Picture

**1** Set the exposure mode.

Set the mode dial to any mode other than .

**2** Press the **LV** button.

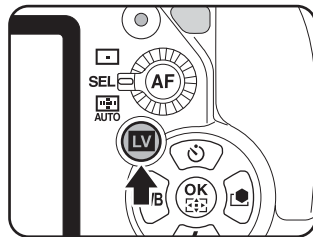

The mirror pops up and a real-time image is displayed on the monitor. Press the **LV** button again to exit Live View.

Live View can be displayed for up to 5 minutes. When the Live View display is cancelled after the elapse of 5 minutes, Live View can be restarted by pressing the **LV** button. If the internal temperature of the camera is high, Live View may end before 5 minutes elapse.



## Live View display

(All of the indications are displayed here for explanatory purposes.)

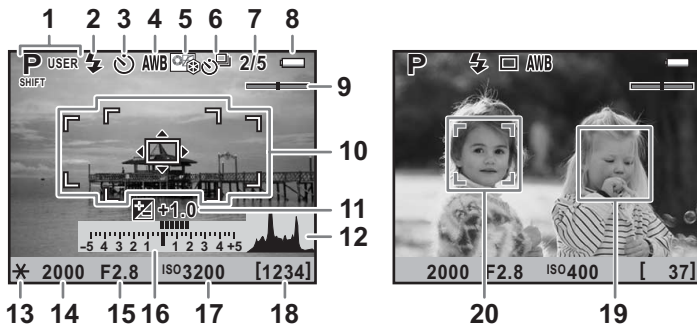

- |   |                                     |
|---|-------------------------------------|
| 1 Exposure Mode   | 10 AF frame                         |
| 2 Flash Mode  | 11 EV Compensation                  |
| 3 Drive Mode  | 12 Histogram                        |
| 4 White Balance   | 13 AE Lock                          |
| 5 Custom Image  | 14 Shutter Speed                    |
| 6 Extended Bracketing/Multi-exposure/Interval Shooting/Digital Filter/HDR Capture | 15 Aperture                         |
| 7 Number of shots using Multi-exposure  | 16 EV bar                           |
| 8 Battery level   | 17 Sensitivity                      |
| 9 Electronic Level  | 18 Remaining image storage capacity |
|   | 19 Face detection frame             |
|   | 20 Main face detection frame        |

\* Indicator 10 is displayed in white during Live View and turns green when the subject is in focus. It turns red when the subject was not in focus. It is not displayed when the focus mode is set to **MF**.

\* Indicators 19 and 20 are displayed when [Autofocus Mode] is set to  and the camera detects person's face(s). (Up to 16 face recognition frames are displayed on the monitor.)

### 3

## Position the subject on the monitor and press the AF button.

The autofocus system operates.

When the focus mode is set to **MF**, turn the focusing ring until the subject is clearly visible on the focusing screen.

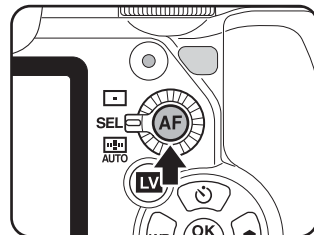

## 4 Press the shutter release button fully.

The picture is taken.



- When the focus mode is set to **A.F.S** and [Autofocus Mode] is set to or , press the **OK** button and use the four-way controller () to change the AF point. Press the **OK** button again to cancel the changing of the AF point.
- When the focus mode is set to **A.F.C** and [Autofocus Mode] is set to or , the camera focuses on the center of the screen when auto focusing starts and then automatically tracks the subject when it is in focus.
- You can enlarge the image to 2, 4, or 6 times during Live View by pressing the **INFO** button. Use the four-way controller () to move the display area, and press the (Green) button to return the display to the center. When the focus mode is set to **MF**, press the **INFO** button to enlarge the image to 2, 4, 6, 8 or 10 times. Images captured in magnified display are recorded at normal size.
- You can change the settings during Live View in the same way as when shooting with the viewfinder.
- You can check the depth of field on the monitor by turning the main switch to during Live View.

4

Shooting Functions

## Recording Movies

You can record movies with a frame rate (number of frames shot per second) at 30 frames per second (fps), monaural audio, and the file format set to AVI.

### Changing the Movie Settings

#### 1 Select [Movie] in the [ Rec. Mode 3] menu and press the four-way controller ().

The [Movie] screen appears.

#### 2 Press the four-way controller () and use the four-way controller () to select the number of recorded pixels.

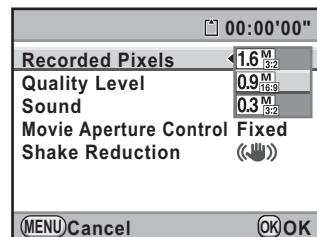

Recorded Pixels	Pixels	Aspect Ratio
1.6M <small>16:9</small>	1536×1024	3:2
0.9M <small>16:9</small> (default setting)	1280×720	16:9
0.3M <small>16:9</small>	640×416	3:2

**3** Press the **OK** button.

**4** Use the four-way controller (▲ ▼) to select **[Quality Level]**.

**5** Press the four-way controller (▶) and use the four-way controller (▲ ▼) to select the quality level.

Select from ★★★ (Best; default setting), ★★ (Better) and ★ (Good). When the recorded pixels and quality level are changed, the amount of recordable time at that setting appears at the top right of the screen.

**6** Press the **OK** button.

**7** Use the four-way controller (▲ ▼) to select **[Sound]**.

**8** Use the four-way controller (◀ ▶) to select  or .

: Records sound. (default setting)

: Does not record sound.

**9** Use the four-way controller (▲ ▼) to select **[Movie Aperture Control]**.

**10** Press the four-way controller (▶) and use the four-way controller (▲ ▼) to select **[Auto]** or **[Fixed]**.

Auto: The aperture is controlled automatically.

Fixed: The movie is recorded at the aperture value set before movie recording starts. (default setting)

**11** Press the **OK** button.

**12** Use the four-way controller (▲▼) to select [Shake Reduction].

**13** Use the four-way controller (◀▶) to select (☞) or (☜).

(☞): Uses Shake Reduction.

(☜): Does not use Shake Reduction. (default setting)

**14** Press the MENU button twice.

The camera is ready to record a movie.



When [Sound] is set to  (On), the camera operation sounds are also recorded. When recording a movie, mount the camera onto a tripod and do not operate the camera while recording.

## Connecting a Microphone

You can connect a commercially available stereo microphone (Ø3.5 mm (1/8 inch) stereo mini plug) to the microphone terminal on the camera and record stereo sound. Using an external microphone can also help to reduce the possibility of recording the camera operation sounds.

**1** Turn off the camera.

**2** Open the microphone terminal cover and connect the plug of the microphone to the microphone terminal on the camera.

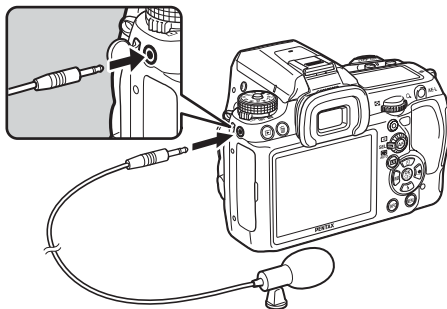

### 3 Turn the camera on.



If the external microphone is disconnected during recording, the camera cannot switch to the internal microphone until recording has stopped. No sound will be recorded.



If you used an external microphone to record movie sound in stereo, the sound can be played back in stereo when you use a commercially available HDMI cable to output the movie to a HDMI-compatible AV device. (p.235) When you use the AV cable to output the movie, monaural sound is played back.

## Recording Movies

### 1 Set the mode dial to .

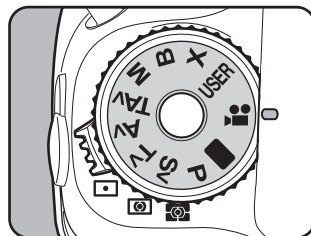

The exposure mode is set to (Movie), and Live View for movie capture is displayed.

Live View can be displayed for up to 5 minutes. When the Live View display is cancelled after the elapse of 5 minutes, Live View can be restarted by pressing the **LV** button. If the internal temperature of the camera is high, Live View may end before 5 minutes elapse.

Sound



Recordable Time  
Shake Reduction

4

Shooting Functions

## 2 Position the subject on the monitor and press the AF button.

The autofocus system operates.

When the focus mode is set to **MF**, turn the focusing ring until the subject is clearly visible on the focusing screen.

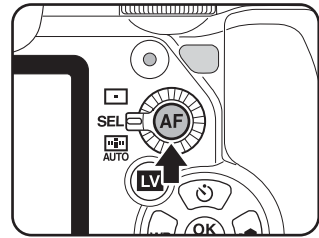

## 3 Press the shutter release button fully.

Recording of the movie starts.

## 4 Press the shutter release button again.

Recording stops.





- When [Sound] is set to  (On), the camera operation sounds are also recorded. When recording a movie, mount the camera onto a tripod and do not operate the camera while recording.
- While recording a movie, the autofocus system does not operate.
- The flash is not available.



- You can record movies continuously up to 4 GB or 25 minutes. When the SD Memory Card is full, recording stops and the movie is saved.
- If you intend to shoot continuously for a long period, use of the AC adapter kit K-AC50 (optional) is recommended. (p.47)
- You can also use the optional remote control to control recording operations. (p.138)
- When recording movies, only the White Balance and Custom Image (other than Fine Sharpness) settings can be used.
- The sensitivity is fixed to [AUTO].
- If a high temperature is reached inside the camera during movie recording, the recording may be terminated for the sake of circuit protection.

## Playing Back Movies

Recorded movies can be played back in Playback mode in the same manner as saved images.

- 1 Press the  button.
- 2 Use the four-way controller ( ) to choose a movie to play back.







The first frame of the movie is displayed on the monitor.

- 3 Press the four-way controller ().

Movie playback starts.



### Available operations

Four-way controller (  )	Pause/Resume
Rear e-dial (  )	Volume control (6 levels)
Four-way controller (  )	Frame advance (when paused)
Press and hold four-way controller (  )	Fast forward playback while pressed
Four-way controller (  )	Reverse playback/ Frame reverse (when paused)
Press and hold four-way controller (  )	Fast reverse playback while pressed
Four-way controller (  )	Stop

When the movie ends, playback stops and the first frame is displayed.



- You can use the provided AV cable (I-AVC7) or a commercially available HDMI cable to play back the recorded movies on a TV or other AV device. (p.233)
- Even if you used an external microphone to record movie sound in stereo, monaural sound is played back when you output the movie via the PC/AV terminal. When you output the movie via the HDMI terminal, sound is played back in stereo.

## Capturing a Still Picture from a Movie

You can capture a single frame from a recorded movie and save it as a JPEG still picture.

**1** Pause the movie in Step 3 on p.165 to display the frame to save as a still picture.

**2** Press the **AE-L** button.

The save confirmation screen appears.

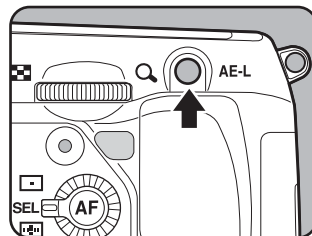

**3** Use the four-way controller (**▲ ▼**) to select **[Save as]**.



**4** Press the **OK** button.

The captured image is saved as a new image.



# 5 Using the Flash

---

This chapter provides details on the built-in flash of **K-7** and describes how to take pictures with the external flash.

<b>Flash Characteristics in Each Exposure Mode</b> .....	<b>168</b>
<b>Distance and Aperture when Using the Built-in Flash</b> .....	<b>171</b>
<b>Lens Compatibility with the Built-in Flash</b> .....	<b>172</b>
<b>Using an External Flash (Optional)</b> .....	<b>173</b>

# Flash Characteristics in Each Exposure Mode

## Using the Flash in Tv (Shutter Priority) Mode

- When taking a moving subject, you can use the flash to change the blur effect.
- Any desired shutter speed 1/180 seconds or slower can be set for taking a flash photograph.
- The aperture value automatically changes according to the ambient brightness.
- The shutter speed is locked at 1/180 seconds when a lens other than DA, DA L, D FA, FA J, FA, F or A is used.

## Using the Flash in Av (Aperture Priority) Mode

- You can set the desired aperture to take a flash photograph when you want to change the depth of field or shoot a subject farther away.
- The shutter speed automatically changes with the ambient brightness.
- The shutter speed shifts automatically anywhere from 1/180 seconds to a slow shutter speed (p.64) that reduces camera shake. The slowest shutter speed depends on the focal length of the lens in use.
- The shutter speed is locked at 1/180 seconds when a lens other than DA, DA L, D FA, FA J, FA or F is used.

## Using the Slow-Speed Sync

You can use slow-speed-sync in **Tv** (Shutter Priority) mode when shooting portraits with the sunset in the background. Both the portrait and the background are captured beautifully.



- Slow-speed Sync shooting slows the shutter speed. Use the Shake Reduction function or turn off the Shake Reduction function and use a tripod to avoid camera shake. The picture will also blur if the subject moves.
- Slow-speed Sync shooting can also be performed with an external flash.

## Using P/Sv/Av mode

- 1 Set the mode dial to **P**, **Sv** or **Av**.
- 2 Press the **⚡** button.  
The built-in flash pops up.
- 3 Press the four-way controller (**▼**).  
The [Flash Mode] screen appears.
- 4 Select **⚡<sup>SLOW</sup>** or **Ⓞ⚡<sup>SLOW</sup>** and press the **OK** button.  
The shutter speed is set slower to give the appropriate exposure for the background.
- 5 Take the picture.

## Using Tv/TAv/M mode

- 1 Set the mode dial to **Tv**, **TAv** or **M**.
- 2 Press the four-way controller (**▼**).  
The [Flash Mode] screen appears.
- 3 Select **⚡** or **⚡Ⓞ** and press the **OK** button.
- 4 Set the shutter speed (for **Tv** mode) or shutter speed and aperture (for **TAv** or **M** mode).  
Set so that proper exposure is obtained in 1/180 seconds or slower.
- 5 Press the **⚡** button.  
The built-in flash pops up.
- 6 Take the picture.

## Using the Trailing Curtain Sync

Trailing Curtain Sync discharges the flash immediately before the shutter curtain closes. When shooting moving objects with a slow shutter speed, Trailing Curtain Sync and Slow-speed Sync produce different effects depending on when the flash is discharged.



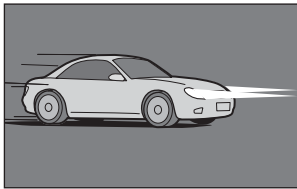

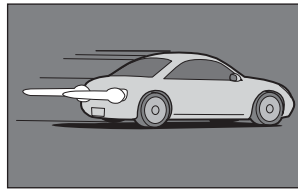

For example, when shooting a moving car with Trailing Curtain Sync, trailing light is captured while the shutter is open and the flash captures the car immediately before the shutter is closed. Therefore, the picture will include a sharp, well-lit car with trailing lights behind it.



Slow-speed Sync



Trailing Curtain Sync

- 1 **Set the mode dial to any mode other than , **X** or .**
- 2 **Press the four-way controller ()**.  
The [Flash Mode] screen appears.
- 3 **Select  or  and press the OK button.**
- 4 **Press the  button.**  
The built-in flash pops up.
- 5 **Take the picture.**



Trailing Curtain Sync slows the shutter speed. Use the Shake Reduction function or turn off the Shake Reduction function and use a tripod to avoid camera shake.

# Distance and Aperture when Using the Built-in Flash

A set criteria is necessary between the guide number, aperture and distance when shooting with the flash to obtain the correct exposure. Calculate and adjust the shooting conditions if the flash output is not sufficient.

ISO sensitivity	Built-in flash guide number
ISO 100	Approx. 13
ISO 200	Approx. 18.4
ISO 400	Approx. 26
ISO 800	Approx. 36.8
ISO 1600	Approx. 52
ISO 3200	Approx. 73.5

## Calculating Shooting Distance from Aperture Value

The following equation calculates the distance of the flash for aperture values.  
Maximum flash distance  $L1 = \text{Guide number} \div \text{Aperture value}$

Minimum flash distance  $L2 = \text{Maximum flash distance} \div 5^*$

\*The value 5 used in the formula above is a fixed value which applies only when using the built-in flash alone.

Example: When the sensitivity is [ISO 100] and aperture value is F2.8

$$L1 = 13 \div 2.8 = \text{approx. } 4.6 \text{ (m)}$$

$$L2 = 4.6 \div 5 = \text{approx. } 0.9 \text{ (m)}$$

Therefore, the flash can be used in a range of about 0.9 m to 4.6 m.

The flash cannot be used when the distance is 0.7 m or less. When the flash is used at closer than 0.7 m, it causes vignetting in the picture corners, the light is distributed unevenly and the picture may be overexposed.

## Calculating Aperture Value from Shooting Distance

The following equation calculates the aperture value for shooting distances.

Aperture value  $F = \text{Guide number} \div \text{Shooting distance}$

Example: When the sensitivity is [ISO 100] and shooting distance is 4 m, aperture value is

$$F = 13 \div 4 = 3.25$$

If the resulting number (3.25, in the above example) is not available as a lens aperture, the smaller number that is closest (2.8, in the above example) is generally used.

# Lens Compatibility with the Built-in Flash

Depending on the lens used with the **K-7**, even if a lens without a hood is attached, the use of the built-in flash may not be possible or may be limited due to vignetting.

DA, DA L, D FA, FA J, and FA lenses not listed below can be used without problems.

\* Following are evaluated without a hood.

## Unavailable due to vignetting

Lens name
DA FISH-EYE 10-17mm F3.5-4.5ED (IF)
DA12-24mm F4ED AL
DA14mm F2.8ED (IF)
FA*300mm F2.8ED (IF)
FA*600mm F4ED (IF)
FA*250-600mm F5.6ED (IF)

## Available depending on other factors

Lens name	Restrictions
F FISH-EYE 17-28mm F3.5-4.5	Vignetting may occur if focal length is less than 20 mm.
DA16-45mm F4ED AL	When the focal length is less than 28 mm or when the focal length is 28 mm and the shooting distance is 1 m or less, vignetting may occur.
DA*16-50mm F2.8ED AL (IF) SDM	When the focal length is 20 mm or less or when the focal length is 35 mm and the shooting distance is less than 1.5 m, vignetting may occur.
DA17-70mm F4AL (IF) SDM	When the focal length is less than 24 mm or when the focal length is 24 mm and the shooting distance is 1 m or less, vignetting may occur.
DA18-250mm F3.5-6.3ED AL (IF)	Vignetting may occur if the focal length is less than 35 mm.
FA*28-70mm F2.8AL	Vignetting may occur if focal length is 28 mm and the shooting distance is less than 1 m.
FA SOFT 28mm F2.8	Built-in flash always discharges fully.
FA SOFT 85mm F2.8	Built-in flash always discharges fully.

Using the optional external flash AF540FGZ, AF360FGZ, AF200FG or AF160FC enables a variety of flash modes, such as P-TTL auto flash mode, depending on the external flash being used. See the chart below for details.

(✓: Available #: Restricted ×: Not available)

Camera function \ Flash	Built-in flash	AF540FGZ AF360FGZ	AF200FG AF160FC
Red-eye reduction flash	✓	✓	✓
Automatic flash discharge	✓	✓	✓
After the flash is fully charged, the camera automatically switches to the flash sync speed.	✓	✓	✓
Aperture is automatically set in <b>P</b> and <b>Tv</b> modes.	✓	✓	✓
Auto check in the viewfinder	×	×	×
P-TTL auto flash (appropriate sensitivity: ISO 100 to 3200)	✓ <sup>*1</sup>	✓ <sup>*1</sup>	✓ <sup>*1</sup>
Slow-speed Sync	✓	✓	✓
Flash exposure compensation	✓	✓	✓
AF Assist Light of the external flash	×	✓	×
Trailing Curtain Sync <sup>*2</sup>	✓	✓	×
Contrast-control-sync flash mode	# <sup>*3</sup>	✓	# <sup>*4</sup>
Slave flash	×	✓	×
Multiple flash	×	×	×
High-speed flash sync	×	✓	×
Wireless flash	# <sup>*4</sup>	✓ <sup>*5</sup>	×

\*1 Available only when using DA, DA L, D FA, FA J, FA, F or A lens.

\*2 Shutter speed of 1/90 seconds or slower.

\*3 When combined with the AF540FGZ or AF360FGZ, 1/3 of the flash discharge can be output by the built-in flash and 2/3 can be output by the external flash.

\*4 Available only when combined with the AF540FGZ or AF360FGZ.

\*5 Multiple AF540FGZ or AF360FGZ units or a combination of an AF540FGZ/AF360FGZ unit and the built-in flash is required.



Flashes with reversed polarity (the center contact on the hot shoe is minus) cannot be used due to the risk of damaging the camera or flash.

## About the Display Panel for AF360FGZ

The AF360FGZ itself does not have the function to set the FORMAT size to [DIGITAL]. However, when it is used with a SLR Digital Camera, the difference in focal length between 35 mm film camera and the **K-7** is automatically calculated based on the difference in angle of view and is displayed on the panel (when using DA, DA L, D FA, FA J, FA or F lens).

The conversion indicator appears and the format size indicator disappears when the exposure metering timer of the **K-7** is on (it returns to 35 mm format display when the exposure metering timer is turned off).

Lens focal length	85mm	77mm	50mm	35mm	28mm	24mm	20mm	18 mm
Exposure metering timer Off	85mm		70mm	50mm	35mm		28mm	24mm*
Exposure metering timer On	58mm		48mm	34mm	24mm		19mm	16mm*

\* Using wide-angle panel

## Using P-TTL Auto Mode

You can use [P-TTL auto] with the AF540FGZ, AF360FGZ, AF200FG or AF160FC flash unit. The flash pre-flashes before the actual flash and confirms the subject (the distance, brightness, contrast, whether it is backlit, etc.) using the camera 77-segment metering sensor. The flash output for the actual flash is adjusted based on the information obtained from the pre-flash, enabling flash photography with more appropriate exposure for the subject than with normal TTL auto.

- 1** Remove the cover of the hot shoe and attach the external flash.
- 2** Turn on the camera and the external flash.
- 3** Set the external flash mode to [P-TTL auto].
- 4** Confirm that the external flash is fully charged and then take the picture.





- P-TTL auto is only available with the AF540FGZ, AF360FGZ, AF200FG or AF160FC flash unit.
- The will light in the viewfinder when the flash is ready (fully charged).
- The flash does not discharge if the subject is bright enough when the flash mode is ^ or . Therefore, it may not be suitable for daylight-sync shooting.
- Never press the button when any external flash unit is attached to the camera. The built-in flash will hit the external flash. If you want to use both at once, set the wireless mode or connect them using the extension cord. (p.180).
- For details such as operation method and effective distance, please read the manual for the external flash.

## Using High-Speed Flash Sync Mode

With the AF540FGZ or AF360FGZ, you can discharge the flash to take a picture at a shutter speed faster than 1/180 seconds.

- 1** Remove the cover of the hot shoe and attach the external flash (AF540FGZ or AF360FGZ) to the camera.
- 2** Set the exposure mode to Tv or M.
- 3** Turn on the camera and the external flash.
- 4** Set the external flash sync mode to HS (High-speed flash sync).
- 5** Confirm that the external flash is fully charged and then take the picture.



- The will light in the viewfinder when the flash is ready (fully charged).
- High-speed flash sync is available only when the shutter speed is faster than 1/180 seconds.
- High-speed flash sync is not available when the exposure mode is set to **B** (Bulb).

## Using in Wireless Mode

By using two external flashes (AF540FGZ or AF360FGZ) or using the built-in flash with an external flash, you can shoot in P-TTL flash mode without connecting the flash units with a cord.



- Set the power switch of the external flash to WIRELESS.
- Two or more AF540FGZ/AF360FGZ external flashes are required to use High-speed flash sync in the wireless mode. This function cannot be used in combination with the built-in flash.
- Set the wireless mode of the external flash not directly connected to the camera to SLAVE.

### Setting the Channel for the External Flash on the Camera

First set the channel for the external flash unit on the camera.

5

Using the Flash

- 1 Set the channel for the external flash unit.**
- 2 Remove the cover of the hot shoe and attach the external flash.**
- 3 Turn on the camera and the external flash, and press the shutter release button halfway.**

The built-in flash is set to the same channel as the external flash unit.



- When set to mode, the channel currently set for the built-in flash is displayed in the viewfinder for 10 seconds.
- Be sure to set all the flashes to the same channel. Refer to the manual of AF540FGZ or AF360FGZ for details on how to set the channel on the external flash.

## Using the Built-in Flash Wirelessly

Set the camera to wireless flash mode when using an external flash in combination with the built-in flash.





### 1 Press the four-way controller (▼).

The [Flash Mode] screen appears.

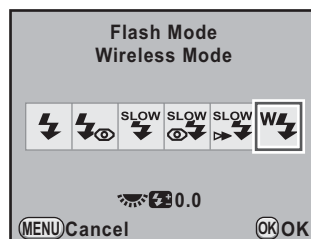
### 2 Select and press the OK button.

The camera is ready to take a picture.



-  cannot be set when the exposure mode is set to  (Green).
- When the drive mode is set to  (Remote Control (3s delay)), **MUP** (Mirror lock-up) or  (Mirror lock-up remote control), or the lens aperture is not set to the **A** position,  cannot be selected.

## Changing the Built-in Flash Discharge Method

You can change the built-in flash discharge method in wireless mode. Set in [31. Flash in Wireless Mode] in the [**C** Custom Setting 5] menu (p.87).

1	On	Discharges the built-in flash as a master. (Default setting)
2	Off	Discharges the built-in flash as a control flash.



HS  (High-speed flash sync) is not available with the built-in flash.

## Wireless Shooting

- Using a Combination of the Built-in Flash and an External Flash Unit

- 1 Remove the external flash unit after the channel was set on the camera, and place at the desired location.
- 2 Set the flash mode of the camera to  $W\downarrow$ , and press the  $\downarrow$  button.
- 3 Confirm that both flashes are fully charged and then take the picture.

- Using a Combination of External Flash Units

- 1 Set the wireless mode of the external flash directly connected to the camera to [MASTER] or [CONTROL].

MASTER	Discharges both the flash directly connected to the camera and the wireless flash unit.
CONTROL	The flash directly connected to the camera is discharged as a control flash only and does not discharge as main flash.

- 2 On the wireless remote flash unit, set the wireless flash mode to [SLAVE] and set the channel to the same channel as the flash directly connected to the camera. Then, place at the desired location.
- 3 Confirm that both flashes are fully charged and then take the picture.



- [Shake Reduction] and [Horizon Correction] are automatically turned off in the wireless mode.
- When using multiple AF540FGZ/AF360FGZ external flashes and performing high-speed flash sync shooting in the wireless mode, set the flash directly connected to the camera to high-speed flash sync mode.

## Wireless Flash Control (P-TTL Flash Mode)

When using external flash units (AF540FGZ or AF360FGZ) for wireless shooting, the following information is exchanged between the flash units before the flash is discharged.

Press the shutter release button fully.



- 1 The flash directly connected to the camera emits a control flash (relays the flash mode of the camera).
- 2 The wireless remote flash emits a control flash (relays confirmation of subject).
- 3 The flash directly connected to the camera emits a control flash (relays flash output to the wireless remote flash).
  - \* The flash directly connected to the camera will emit a control flash one more time after this to relay the flash duration time when HS  $\downarrow$  (High-speed flash sync) is set.
- 4 The wireless remote flash discharges at the same time as the main flash.



When the wireless mode of the external flash directly connected to the camera is set to [MASTER] or [31. Flash in Wireless Mode] (p.177) is set to [On] for the built-in flash, all the flashes will discharge simultaneously.

## Red-Eye Reduction

As with the built-in flash, red-eye reduction is available with an external flash. However, depending on the type of the flash, this function may not be available or may have some restrictions for usage conditions. See the chart on p.173.



- The red-eye reduction function works by discharging the flash twice even when only an external flash is used. (p.75)
- If red-eye reduction of the built-in flash is used when the external flash is set as the slave unit or with the wireless function, the preflash for red-eye reduction will trigger the external flash. Do not use red-eye reduction when using a slave unit.

## Trailing Curtain Sync

When using the built-in flash with an external flash (AF540FGZ or AF360FGZ) that is set to the Trailing Curtain Sync function, the built-in flash will also use this mode. Confirm that both flash units are fully charged before shooting.

## Connecting an External Flash with an Extension Cord

When using the built-in flash with an external flash that does not have wireless flash mode function such as AF200FG, attach the Hot Shoe Adapter F<sub>C</sub> (optional) to the camera hot shoe and an Off-Camera Shoe Adapter F (optional) to the bottom of the external flash, and connect these with the Extension Cord F5P (optional) as shown in the illustration below. The Off-Camera Shoe Adapter F can be mounted using the tripod screw to your tripod.

Only the P-TTL auto flash can be used in combination with the built-in flash.

### When combining with the built-in flash

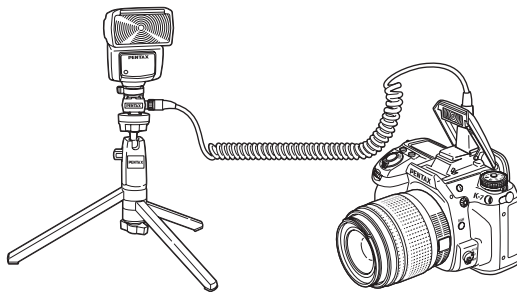

## Multiple Flash Shooting Using Extension Cords

You can combine two or more external flashes (AF540FGZ, AF360FGZ or AF200FG) or you can use two or more external flashes in combination with the built-in flash. You can use the extension cord connection terminal on the flash to connect the AF540FGZ. You can connect AF360FGZ or AF200FG unit as shown in the illustration below. Connect an external flash and the Hot Shoe Adapter F (optional) to the Off-Camera Shoe Adapter F (optional) and then connect another Off-Camera Shoe Adapter F with external flash using the Extension Cord F5P (optional). Refer to the manual of the flash for details.

### When combining two or more external flashes

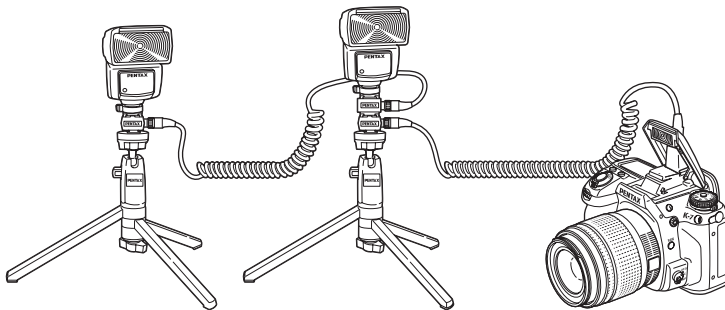

- Do not combine with accessories that have a different number of contacts such as a Hot Shoe Grip as a malfunction may occur.
- Combining with flashes from other manufacturers may cause equipment breakdown. We recommend using the AF540FGZ, AF360FGZ or AF200FG.



When using multiple external flashes or an external flash with the built-in flash, P-TTL is used for flash control.

## Contrast-Control-Sync Flash

Combining two or more external flashes (AF540FGZ, AF360FGZ or AF200FG) or using an external flash in combination with the built-in flash allows multiple flash photography (contrast-control-sync flash photography). This is based on the difference between the amounts of light discharged from multiple units.



- The AF200FG must be combined with the AF540FGZ or AF360FGZ.
- Do not combine with accessories that have a different number of contacts such as a Hot Shoe Grip as a malfunction may occur.
- Combining with flashes from other manufacturers may cause equipment breakdown. We recommend using PENTAX automatic flashes.

**1** Connect the external flash to the camera indirectly. (p.180)

5

**2** Set the sync mode for the external flash to the Contrast-Control-Sync mode.

**3** Set the exposure mode to P, Tv, Av or M.

**4** Confirm that both the external flash and built-in flash are fully charged and then take a picture.



- When using two or more external flashes and the contrast-control-sync mode is set on the external master flash unit, the flash output ratio is 2 (master unit) : 1 (slave units). When external flash is used in combination with the built-in flash, the flash output ratio is 2 (external flash) : 1 (built-in flash).
- When using multiple external flashes or an external flash with the built-in flash, P-TTL is used for flash control.



## X-sync Socket

You can connect an external flash to the camera with a sync cord by using the X-sync socket.

Remove the Sync socket 2P cap and connect a sync cord to the X-sync socket.

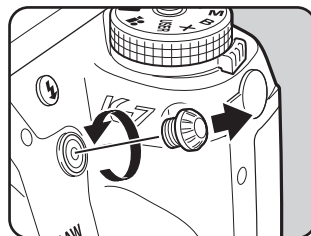

- The use of high-voltage or high-current external flashes may cause a camera breakdown.
- Flashes with reversed polarity (the center of the sync plug is minus) cannot be used due to the risk of damaging the camera or flash.
- When a sync cord is connected to the X-sync socket, linked functions will not work.
- To prevent vignetting caused from Trailing Curtain Sync, it is recommended to take a test shot using a shutter speed one level slower than the flash sync speed.
- The contact of the X-sync socket is not dust-proof and water-resistant. Attach the provided Sync socket 2P cap when not in use.



# 6 Shooting Settings

---

This chapter describes how to set the save format for pictures taken and other settings.

<b>Setting the File Format .....</b>	<b>186</b>
<b>Setting the White Balance .....</b>	<b>191</b>
<b>Correcting Images .....</b>	<b>199</b>
<b>Setting the Image Finishing Tone (Custom Image) .....</b>	<b>205</b>
<b>Storing Frequently Used Settings .....</b>	<b>207</b>

## Setting the JPEG Recorded Pixels

You can select the number of recorded pixels from **14M**, **10M**, **6M** and **2M**. The more pixels there are, the larger the picture and the bigger the file size. The file size will also differ according to the [JPEG Quality] setting. The default setting is **14M**.

Recorded Pixels	Pixels	Paper Size
<b>14M</b>	4672×3104	14"×17" / A2 paper
<b>10M</b>	3936×2624	10"×12" / A3 paper
<b>6M</b>	3072×2048	8"×10" / A4 paper
<b>2M</b>	1728×1152	5"×7" / A5 paper

The paper sizes above are references for optimal printing by recorded pixels. The quality of the captured photo or printed picture depends on the quality level, exposure control, resolution of the printer and a variety of other factors.

6

Shooting Settings

**1** Select [JPEG Recorded Pixels] in the [📷 Rec. Mode 1] menu and press the four-way controller (▶).

**2** Use the four-way controller (▲▼) to select the number of recorded pixels.

When the number of recorded pixels is changed, the number of recordable images appears at the top right of the screen.

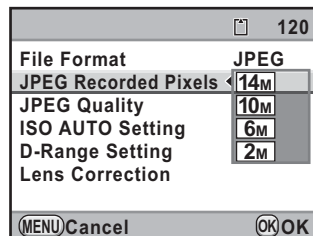

**3** Press the OK button.

**4** Press the MENU button.

The camera is ready to take a picture.

## Setting the JPEG Quality Level

You can set the image quality level. The file size will also differ according to the [JPEG Recorded Pixels] setting. The default setting is ★★★ (Best).

★★★★ Premium	 <p>Images will be clearer but file size will be larger.</p> <p>Images will be grainier but file size will be smaller.</p>
★★★ Best	
★★ Better	
★ Good	

**1** Select [JPEG Quality] in the [📷 Rec. Mode 1] menu and press the four-way controller (▶).

**2** Use the four-way controller (▲ ▼) to select the quality level.

When the quality level is changed, the number of recordable images at that quality level appears at the top right of the screen.

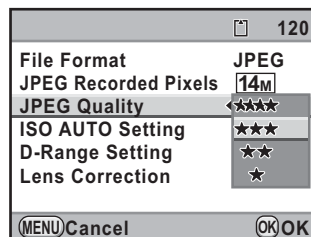

**3** Press the OK button.

**4** Press the MENU button.

The camera is ready to take a picture.

## Setting the File Format

You can set the format of image files.

JPEG	Captures images in JPEG format. You can change the number of recorded pixels in [JPEG Recorded Pixels] and the image quality level in [JPEG Quality]. (default setting)
RAW	RAW data are CMOS sensor output data saved without processing. Effects of White Balance, Custom Image and Color Space are not applied to the images, but they are saved as actual original information. When you perform the development process by using RAW Development function (p.247), or using the provided software (PENTAX Digital Camera Utility 4) after transferring RAW data to a computer, you can create JPEG or TIFF images with these effects.
RAW+	Images are saved in both RAW and JPEG formats. When the <b>RAW</b> button is pressed, images are temporarily captured in both formats. (p.189)



When Extended Bracketing (p.151), Digital Filter (p.153) or HDR Capture (p.200) is set, the file format is set to [JPEG] and cannot be changed. To change the file format, turn these functions off.

6

Shooting Settings

**1** Select [File Format] in the [ Rec. Mode 1] menu and press the four-way controller (▶).

**2** Use the four-way controller (▲▼) to select a file format.

When the file format is changed, the number of recordable image appears at the top right of the screen.

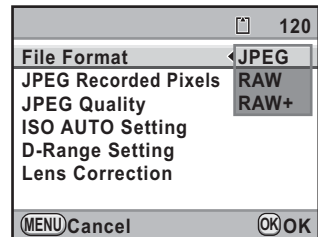

**3** Press the OK button.

**4** Press the MENU button.

The camera is ready to take a picture.

## Setting the RAW File Format

You can select PEF or DNG format in [RAW File Format] in the [📷 Rec. Mode 4] menu (p.84) when images are captured in RAW format.

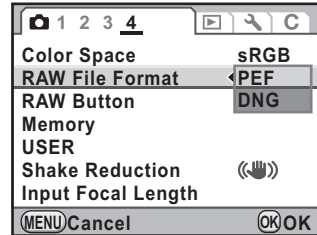

PEF	PENTAX original RAW file format (default setting)
DNG	General-purpose, publicly available RAW file format designed by Adobe Systems

## Setting the RAW Button Function

You can set the function when the **RAW** button is pressed.

- 1 Select [RAW Button] in the [📷 Rec. Mode 4] menu and press the four-way controller (▶).

The [RAW Button] screen appears.

- 2 Use the four-way controller (◀▶) to select  or  for [Cancel after 1 shot].

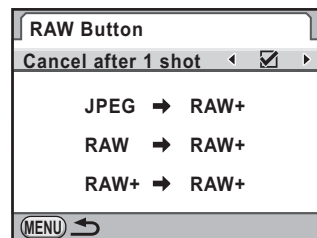

<input checked="" type="checkbox"/>	The recording format returns to the original file format after a picture taken. (default setting)
<input type="checkbox"/>	The setting is canceled when the following operations are performed. <ul style="list-style-type: none"> <li>- the <b>RAW</b> button is pressed again</li> <li>- the <b>▶</b> or <b>MENU</b> button is pressed</li> <li>- the main switch turned off</li> <li>- the mode dial is turned</li> </ul>

### 3 Use the four-way controller (▲▼) to choose a file format.

The left side is the [File Format] setting and the right side is the file format when the **RAW** button is pressed.

### 4 Press the four-way controller (▶), and use the four-way controller (▲▼) to select a file format when the RAW button is pressed.

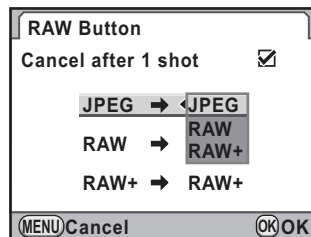







### 5 Press the OK button.

### 6 Press the MENU button twice.

The screen that was displayed before selecting the menu appears again.



White balance is the function for adjusting the color of an image so that white objects appear white. Set the white balance if you are not satisfied with the color balance of pictures taken with white balance set to **AWB** (Auto), or to intentionally apply a creative effect to your images.

Item	Settings	Color Temperature *1
<b>AWB</b> Auto	Automatically adjusts the white balance. (default setting)	Approx. 4,000 to 8,000K
 Daylight	For use when taking pictures in sunlight.	Approx. 5,200K
 Shade	For use when taking pictures in the shade. It reduces the bluish color tones in a picture.	Approx. 8,000K
 Cloudy	For use when taking pictures on cloudy days.	Approx. 6,000K
 Fluorescent Light	For use when taking pictures under fluorescent lighting. Select the type of fluorescent light. <b>D</b> Fluorescent Light Daylight Color <b>N</b> Fluorescent Light Daylight White <b>W</b> Fluorescent Light Cool White <b>L</b> Fluorescent Light Warm White	Approx. 6,500K Approx. 5,000K Approx. 4,200K Approx. 3,000K
 Tungsten Light	For use when taking pictures under light bulb or other tungsten light. It reduces the reddish color tones in a picture.	Approx. 2,850K
 Flash	For use when taking pictures using the built-in flash.	Approx. 5,400K
<b>CTE</b> *2	Use this to keep and strengthen the color tone of the light source in the image.	–
 Manual	Use this to manually adjust the white balance according to the lighting so that white objects appear as a natural white.	–
<b>K</b> Color Temperature	Use figures to set the color temperature. You can save three settings.	–

\*1 The color temperature (K) is an estimate. This does not indicate precise colors.

\*2 CTE= Color Temperature Enhancement

# 1 Press the four-way controller (◀) in Capture mode.

The [White Balance] screen appears.

# 2 Use the four-way controller (▲▼) to select the white balance.

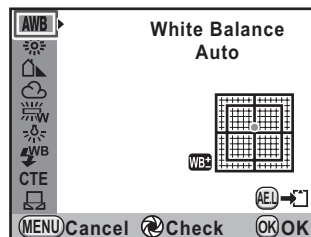

## Available operations

**Main switch** (↻) You can use Digital Preview to preview the background image with the setting applied.

**AE-L button** Saves the background image. Select [Save as] and press the **OK** button.

# 3 Press the OK button.

The camera is ready to take a picture.



- The camera automatically performs fine-tuning even when the light source is specified. The color temperature of the light source is fixed when [11. WB Adjustable Range] in the [C Custom Setting 2] menu (p.85) is set to [Fixed].
- Because the light source changes when the flash discharges, you can set the white balance for when the flash discharges. Select [Auto White Balance], [Unchanged] or [Flash] in [10. WB When Using Flash] in the [C Custom Setting 2] menu (p.85).

## Fine-tuning the White Balance

You can fine-tune the white balance settings.

**1** Perform desired settings in Step 2 on p.192.

**2** Press the four-way controller (▶).

The fine-tuning screen appears.

**3** Fine-tune the white balance.

Seven levels (225 patterns) are available on the G-M and B-A axes.

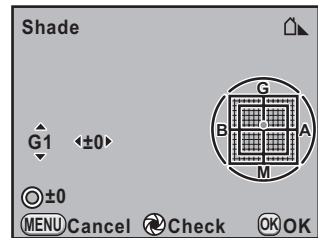

### Available operations

Four-way controller (▲▼)	Adjusts the tone of the colors between green (G) and magenta (M).
Four-way controller (◀▶)	Adjusts the tone of the colors between blue (B) and amber (A).
⊙ (Green) button	Resets the adjustment value.

**4** Press the OK button.

The camera returns to the [White Balance] screen.

**5** Press the OK button.



The camera is ready to take a picture.



When set to , the white balance can also be measured by pressing the shutter release button fully (except while recording a movie).

## Adjusting the White Balance Manually

You can adjust the white balance depending on the light source when taking pictures. With the manual white balance, the camera can store delicate shades that cannot be precisely adjusted with the white balance preset values provided in the camera. This provides the optimum white balance for your surroundings.

- 1 Select /K in Step 2 on p.192 and press the four-way controller (▶).
- 2 Use the four-way controller (▲▼) to select  and press the four-way controller (▶).

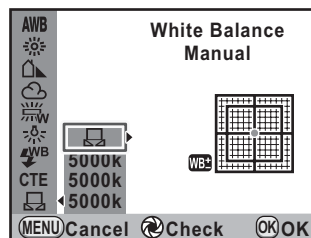

6

Shooting Settings

- 3 Under the light to measure the white balance, fully display a white sheet of paper in the viewfinder or select a white area as the subject.
- 4 Press the shutter release button fully.  
Set the focus mode to **MF** when the shutter cannot be released.  
The screen to select the measuring range is displayed.
- 5 Use the rear e-dial () to select the entire screen or spot area for the measuring range.

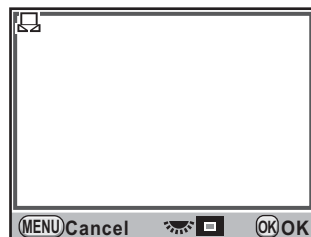

- 6** When a spot area is selected, use the four-way controller (▲▼◀▶) to move the frame to the position you want to measure.

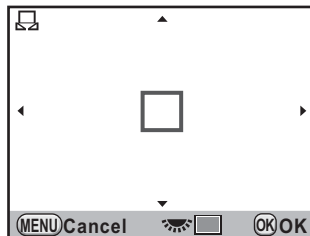

- 7** Press the **OK** button.

The white balance fine-tuning screen appears when measuring is completed. Adjust the white balance if necessary. (p.193)

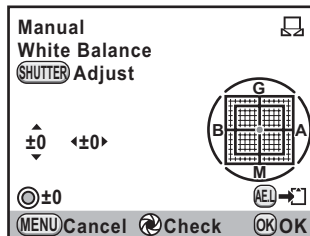

- 8** Press the **OK** button.

The camera returns to the [White Balance] screen.

- 9** Press the **OK** button.

The camera is ready to take a picture.



- No image is recorded when the shutter release button is pressed to adjust the white balance.
- [The operation could not be completed correctly] appears when measuring is unsuccessful. Press the **OK** button while displayed to return to the screen for remeasuring.
- If the picture is extremely overexposed or underexposed, white balance may not be adjusted. In this case, adjust appropriate exposure first and then adjust the white balance.
- When the mode dial is set to (Movie), the white balance cannot be measured. Adjust the white balance in any exposure mode other than (Movie) before recording a movie.

## Adjusting the White Balance with Color Temperature

Use figures to set the color temperature.

**1** Select /K in Step 2 of p.192 and press the four-way controller (▶).

**2** Use the four-way controller (▲▼) to select the color temperature (default setting: 5000K).

You can save three settings. Settings are saved to the location selected here.



**3** Press the four-way controller (▶).

The [Color Temperature] screen appears.

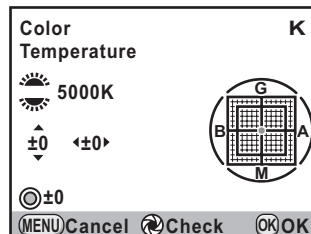
**4** Adjust the color temperature with the front or rear e-dial.



Color temperature steps differ depending on the e-dial.

e-dial	Kelvin	Mired*
Front (  )	1 Step (100K)	1 Step (20M)
Rear (  )	10 Steps (1000K)	5 Steps (100M)

\* The default setting for Color Temperature step units is [Kelvin]. You can change the step units to [Mired] in [21. Color Temperature Steps] in the [C Custom Setting 3] menu (p.86). However, figures are converted to Kelvin and displayed.

You can also use the steps for “Fine-tuning the White Balance” (p.193) for fine-tuning.

## 5 Press the OK button.

The settings are saved and the camera returns to the [White Balance] screen.

Turn the main switch to  to display Digital Preview with the set color temperature.

## 6 Press the OK button.

The camera is ready to take a picture.

### Color Temperature

The color of light shifts towards blue as the color temperature rises, and towards red as the color temperature falls. Color temperature describes this change in light color in terms of absolute temperature (K: Kelvin). This camera is capable of setting the white balance to enable taking pictures with natural coloring under a variety of lighting conditions.

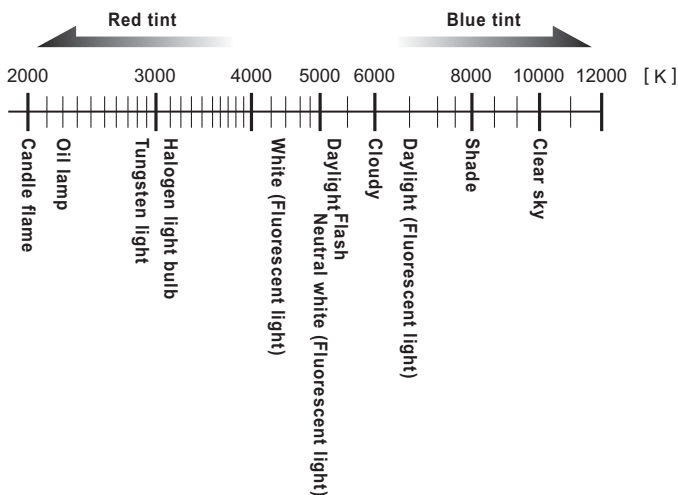

## Saving the White Balance Setting of a Captured Image

You can copy the white balance setting of a captured image and save it as Manual White Balance.

**1** In Playback mode, display the image with the white balance setting you want to copy.

**2** Press the four-way controller (▼).

The playback mode palette appears.

**3** Use the four-way controller (▲▼◀▶) to select  (Save as Manual WB) and press the OK button.

The save confirmation screen appears.

Use the four-way controller (◀▶) to select the image.

**4** Press the four-way controller (▲) to select [Save] and press the OK button.

The white balance setting of the selected image is saved to Manual White Balance and the camera switches to Capture mode. The white balance setting is  (Manual).

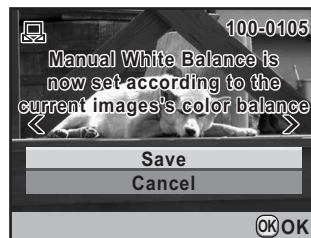

- Only the white balance setting of still pictures captured with this camera can be copied.
- You cannot select a still picture that has been captured from a movie and saved.



The camera and lens properties can be automatically adjusted when taking pictures.

## Adjusting the Brightness

Adjusts the brightness and prevents bright and dark areas from occurring.

### D-Range Setting

Expands the dynamic range and the light level expressed by the CMOS sensor and prevents bright and dark areas from occurring.

- 1** Select **[D-Range Setting]** in the **[📷 Rec. Mode 1]** menu and press the four-way controller (▶).

The [D-Range Setting] screen appears.

- 2** Use the four-way controller (▲▼) to select **[Highlight Correction]**.

- 3** Use the four-way controller (◀▶) to select  or .

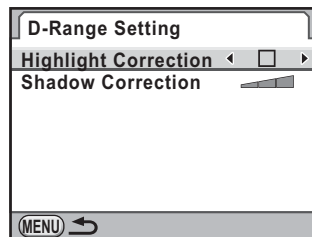

- 4** Use the four-way controller (▲▼) to select **[Shadow Correction]**.

- 5** Use the four-way controller (◀▶) to select **off, low, medium or high.**

- 6** Press the **MENU** button twice.

The camera is ready to take a picture.



When [Highlight Correction] is set to [☑] (On), the minimum sensitivity is ISO 200.

## HDR Capture

Enables the capture of images at high dynamic range. Takes three frames (underexposed, standard (proper exposure) and overexposed) to create a single composite image with them.

**1** Select [HDR Capture] in the [📷 Rec. Mode 2] menu and press the four-way controller (▶).

**2** Use the four-way controller (▲▼) to select [Off], [Standard], or [Strong].

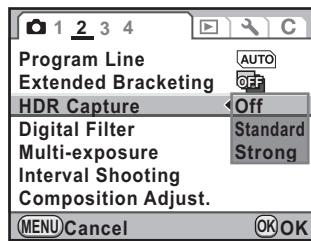

**3** Press the OK button.

**4** Press the MENU button.

The camera is ready to take a picture.



- When HDR Capture is set, the file format is always set to [JPEG] and cannot be changed. You cannot use HDR Capture when the file format is set to [RAW].
- When HDR Capture is set, Interval Shooting and Multi-exposure are not available. Also, the drive modes other than □ (Single Frame Shooting) and 📡 (Remote Control) are not available.
- HDR Capture, Extended Bracketing and Digital Filter cannot be used at the same time. The mode set last is used.
- HDR Capture is not available when the exposure mode is set to **B** (Bulb) or **X** (Flash X-sync Speed) mode.
- During HDR Capture, multiple frames are combined together to create a single image, so it takes time to save an image.
- During HDR Capture, pressing the **MENU** button while an image is being saved cancels the process and saves the image as a standard image.
- [Shake Reduction] is automatically set to 📵 (Off) when HDR Capture is set. In this case, use a tripod to prevent camera shake.

## Lens Correction

Reduces distortions and lateral chromatic aberrations occurring due to lens properties.

### ● Distortion

Distortion is the phenomenon in which the center of the image appears inflated (barrel distortion) or the center of the image appears pinched (pincushion distortion). Distortion occurs more easily when using a zoom lens or a lens with a small aperture, and straight walls or the horizon in the image appears curved.

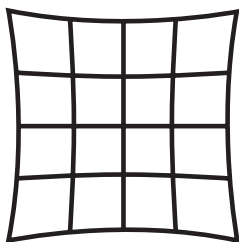

Pincushion distortion

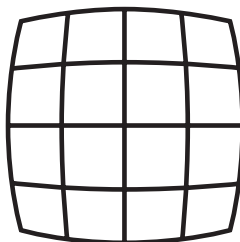

Barrel distortion

### ● Lateral chromatic aberration

Lateral chromatic aberration is the phenomenon in which the magnification of the image varies according to the colors (wavelengths of light) when a picture is taken, and may cause a blurred image. Chromatic aberration occurs more easily at shorter focal lengths.

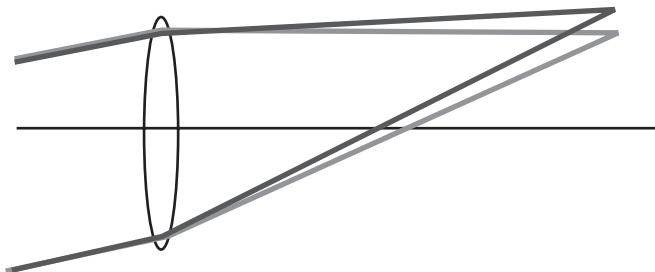



- Corrections can only be made when using a DA, DA L or D FA lens. [Lens Correction] cannot be selected when an incompatible lens is attached.
- [Distortion Correction] is disabled when using a DA FISH-EYE 10-17mm.
- The Lens Correction function is disabled when using an accessory such as a close-up ring or rear converter that is attached between the camera and the lens.
- The shooting speed for continuous shooting may be slower when [Lens Correction] is set to  (On).
- The effects of Lens Correction function may be barely noticeable in some cases due to the shooting conditions or other factors.

## 1 Select [Lens Correction] in the [📷 Rec. Mode 1] menu and press the four-way controller (▶).

The [Lens Correction] screen appears.

## 2 Use the four-way controller (▲▼) to select [Distortion Correction] or [Lat-Chromatic-Ab Adj].

## 3 Use the four-way controller (◀▶) to select or .

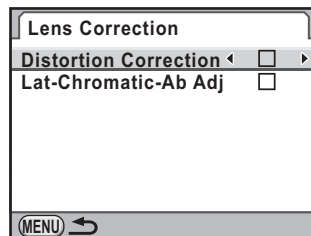

## 4 Press the MENU button twice.

The camera is ready to take a picture.



When a compatible lens is attached and the file format is set to [RAW] or [RAW+], the correction information is saved as a RAW file parameter and you can select on or off when developing RAW images. (p.250)

## Adjusting the Composition

Adjusts the Shake Reduction unit in the X-Y direction or rotation direction for a better composition position and a more level camera. Use this when you want to adjust the composition, such as when using a tripod.

- 1 **Select [Composition Adjust.] in the [📷 Rec. Mode 2] menu and press the four-way controller (▶).**

The screen for adjusting the composition appears.

- 2 **Press the four-way controller (▲) to select [Start Adjustment] and press the OK button.**

Live View is displayed and the composition can be adjusted.

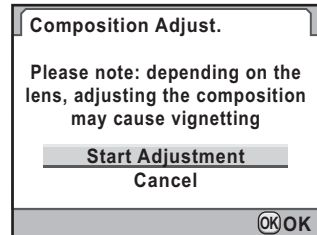

- 3 **Adjust the composition.**

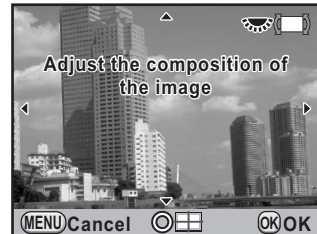

### Available operations

Four-way controller (▲▼◀▶)	Moves the composition up, down, left or right. Adjust from approximately -1 mm to +1 mm on the image sensor.
Rear e-dial (🌀)	Adjusts the level of the composition. Adjust from approximately -1° to +1°.
⊙ (Green) button	Resets the adjustment value.

## 4 Press the OK button.

The camera returns to normal Live View and is ready to take a picture.



The saved adjustment value is reset when the Live View is ended.

# Setting the Image Finishing Tone (Custom Image)

You can set the image finishing tone before shooting. Select from the following seven modes for [Image Tone]: Bright (default setting), Natural, Portrait, Landscape, Vibrant, Muted and Monochrome. You can adjust the following items for [Image Tone].



Item	Settings
Saturation* <sup>1</sup>	Sets the color saturation. (Available settings: -4 to +4)
Hue* <sup>1</sup>	Sets the color. (Available settings: -4 to +4)
High/Low Key Adj	Changes the brightness of the image. (Available settings: -4 to +4)
Contrast	Sets the image contrast. (Available settings: -4 to +4) You can also change the setting to Contrast Highlight Adjustment or Contrast Shadow Adjustment.
Sharpness* <sup>2</sup>	Sets the sharpness of the image outlines. (Available settings: -4 to +4)
Filter Effect* <sup>3</sup>	Changes the contrast to appear as if a B&W color filter was used. Sets the filter color. (Available settings: [None], [Green], [Yellow], [Orange], [Red], [Magenta], [Blue], [Cyan], [Infrared Filter])
Toning* <sup>3</sup>	Sets the level for cold tone adjustment (- direction) and warm tone adjustment (+ direction). (Available settings: -4 to +4)

\*1 This can be set when any mode other than [Monochrome] is selected.

\*2 You can also change the setting to [Fine Sharpness], which makes image outlines even thinner and sharper.

\*3 This can be set when [Monochrome] is selected.



Custom Image cannot be set when the mode dial is set to  (Green) or  (Movie) mode.

## 1

### Press the four-way controller (▶) in Capture mode.

The Custom Image options screen appears.

After the power is turned on, the last image taken is displayed in the background.

- 2** Use the four-way controller (◀▶) to choose the image tone mode.

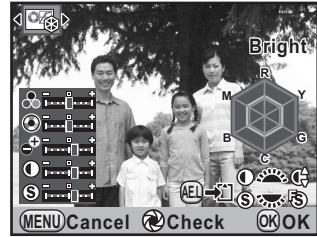

- 3** Use the four-way controller (▲▼) to choose an item.

When [Image Tone] is set to [Monochrome], you can change the settings for [Filter Effect], [Toning], [Contrast] and [Sharpness].

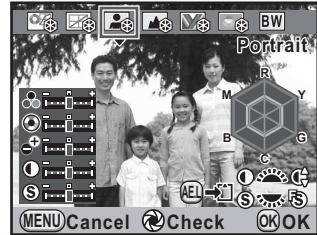

- 4** Use the four-way controller (◀▶) to change the setting.

The background image changes according to the setting.

You can visually check the saturation and hue with the radar chart. (This is not displayed when [Image Tone] is set to [Monochrome].)

#### Available operations

Front e-dial (☀)	Switches between enabling and disabling contrast settings.
Rear e-dial (☀)	Switches between [Sharpness] and [Fine Sharpness]. When set to [Fine Sharpness], image outlines can be captured with more detail.
Main switch (↻)	You can use Digital Preview to preview the background image with the setting applied. (Not available during Live View.)
<b>AE-L</b> button	Saves the background image. Select [Save as] and press the <b>OK</b> button. (Not available during Live View.)

- 5** Press the **OK** button.

The camera is ready to take a picture.





By using **USER** function, you can store the current camera settings and easily retrieve them.

The following settings can be stored.

- Exposure Mode
- Drive Mode
- Flash Mode/Flash Exposure Comp.
- White Balance
- Sensitivity/Sensitivity AUTO Range
- EV Compensation
- Program Line
- Exposure Bracketing
- Extended Bracketing (Bracketing Amount/Type)
- JPEG Recorded Pixels
- JPEG Quality
- File Format
- RAW File Format
- D-Range Setting
- HDR Capture
- Custom Image
- Digital Filter
- Shake Reduction
- Horizon Correction
- Lens Correction
- Color Space
- [C Custom Setting 1-6] menu settings



**USER** function cannot be set when the mode dial is set to  (Green) or  (Movie) mode.

## Saving the Settings

Saves the settings to **USER**.

- 1** **Make the necessary settings.**
- 2** **Select [USER] in the [CAMERA Rec. Mode 4] menu and press the four-way controller (▶).**

The [USER] screen appears.

- 3** Use the four-way controller (▲▼) to select [Save] and press the four-way controller (▶).

The [Save] screen appears.

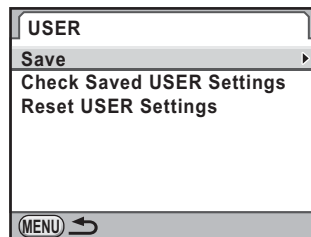

- 4** Press the four-way controller (▲) to select [Save] and press the OK button.

The settings are saved as USER.

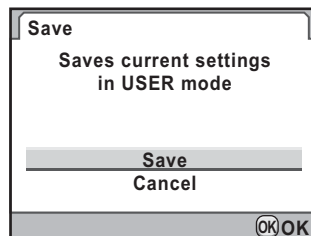

## 6 Checking the Saved USER Settings

- 1** Select [Check Saved USER Settings] in Step 3 of “Saving the Settings” and press the four-way controller (▶).

The current settings saved as USER are displayed.

- 2** Use the four-way controller (◀▶) to navigate the pages.

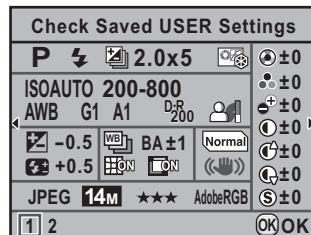

- 3** Press the OK button.

The camera returns to the [USER] screen.

## Using Saved USER Settings

You can easily retrieve saved settings.

### 1 Set the mode dial to USER.

The saved settings are retrieved.

### 2 Change the settings as necessary.

To change the exposure mode, use [Exposure Mode] in the [CAMERA] menu. This menu appears only when the mode dial is set to USER.

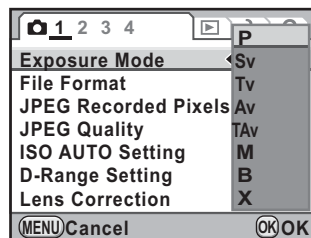

### 3 Take a picture.



The settings changed in Step 2 are not saved as USER. When the camera is turned off, the original saved settings are applied.

## Changing the Settings

Changes the settings saved as USER.

### 1 Perform Steps 1 and 2 of “Using Saved USER Settings”.

### 2 Perform Steps 2 to 4 of “Saving the Settings” (p.207).

The settings are changed and saved again.

## Resetting to Default Settings

Resets the settings saved as **USER** to the default settings.

- 1** Select **[Reset USER Settings]** in Step 3 of “Saving the Settings” (p.207) and press the four-way controller (▶).

The [Reset USER Settings] screen appears.

- 2** Press the four-way controller (▲) to select **[Reset]** and press the **OK** button.

The **USER** settings return to the default values.

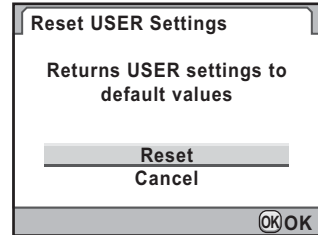

# 7 Playback Functions

---

This chapter describes how to use the various playback functions in Playback mode.

<b>Playback Functions Operation .....</b>	<b>212</b>
<b>Enlarging Images .....</b>	<b>214</b>
<b>Displaying Multiple Images .....</b>	<b>216</b>
<b>Slideshow .....</b>	<b>222</b>
<b>Rotating Images .....</b>	<b>225</b>
<b>Comparing Images .....</b>	<b>226</b>
<b>Deleting Multiple Images .....</b>	<b>227</b>
<b>Protecting Images from Deletion (Protect) .....</b>	<b>231</b>
<b>Connecting the Camera to AV Equipment .....</b>	<b>233</b>

Perform settings related to playing back images in the playback mode palette or [▶] Playback] menu.



For details on how to operate the menus, see “Using the Menus” (p.36).





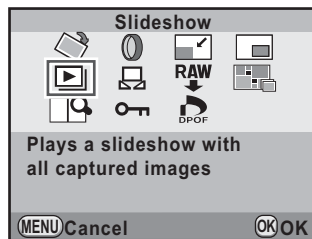
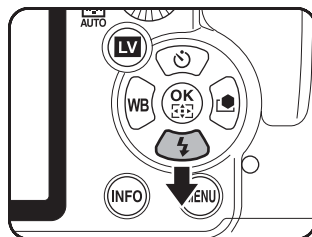

## Playback Mode Palette Setting Items

Press the four-way controller (▼) in Playback mode to display the playback mode palette.

You can display the playback mode palette even when the movie is paused.



Item	Function	Page
◇ Image Rotation	Rotates images.	p.225
⦿ Digital Filter* <sup>1</sup>	Changes the color tone of images, adds softening and slimming effects, or adjusts the brightness.	p.241
☑ Resize* <sup>1</sup>	Changes the number of recorded pixels and quality level and saves it as a new image.	p.238
☒ Cropping	Cuts out only the desired area of the picture and saves it as a new image.	p.239
▶ Slideshow	Plays back the images one after another.	p.222

Item	Function	Page
 Save as Manual WB	You can copy the white balance setting of a captured image and save it as Manual White Balance.	p.198
 RAW Development* <sup>2</sup>	Converts RAW images to JPEG format.	p.247
 Index	Joins a number of images together and creates a new image from them.	p.219
 Image Comparison	Displays two images side-by-side.	p.226
 Protect	Protects images from being accidentally erased.	p.231
 DPOF* <sup>1</sup>	Sets the DPOF settings.	p.273

\*1 This cannot be performed when a RAW image is displayed.

\*2 This cannot be performed when a JPEG image is displayed.

## Playback Menu Setting Items

You can perform the following settings in the [▶] Playback ] menu.

Press the **MENU** button in Playback mode to display the [▶ Playback 1] menu.

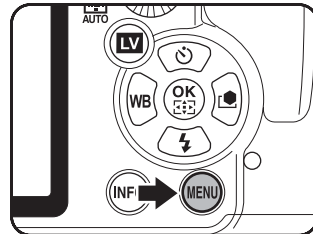

Menu	Item	Function	Page
	Slideshow	Plays back the images one after another. You can set how images will be displayed in the slideshow.	p.222
	Playback Display Method	Sets whether to display the Bright/Dark Area warning in Playback mode and also sets the initial magnification when enlarging images.	p.215
	Delete All Images	You can delete all saved images at once.	p.230

Images can be magnified up to 32 times in Playback mode.

- 1** Use the four-way controller (◀▶) to select an image in Playback mode.



- 2** Turn the rear e-dial (☀️) to the right (🔍).  
The image enlarges at each click (1.2 times to 32 times).



## Available operations

Four-way controller (▲▼◀▶)	Moves area to enlarge.
Rear e-dial (☀️) to the right (🔍)/ ☑️ button	Enlarges image (up to 32 times)
Rear e-dial (☀️) to the left (🔍)/ ⊙ (Green) button	Reduces image (up to 1.2 times*)
<b>OK</b> button	Returns to the original size
Front e-dial (☀️)	Retains the magnification and the position of the magnification area and shows previous/next image
<b>INFO</b> button	Switches information display On/Off

\* The default setting for the first click (minimum magnification) is 1.2 times. You can change this in [Playback Display Method] in [▶ Playback 1] menu. (p.215)





- You can enlarge the image by following the same procedure during Instant Review (p.68), Digital Preview (p.131) or Live View (p.156).
- The initial full display of vertical images is displayed with a magnification of 0.75 times that of horizontal images, therefore, magnification at the first click starts at 1.0 times.

## Setting the Playback Display Method

You can set whether or not to display the Bright/Dark Area warning in Playback mode and set the initial magnification when enlarging images.

- 1 Select [Playback Display Method] in the [▶ Playback 1] menu and press the four-way controller (▶).**

The [Playback Display Method] screen appears.

- 2 Use the four-way controller (◀▶) to select  or  for [Bright/Dark Area].**

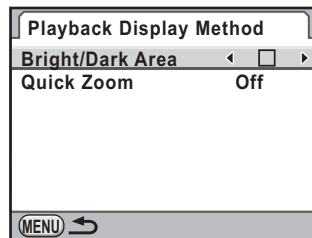

- 3 Use the four-way controller (▲▼) to select [Quick Zoom].**

- 4 Press the four-way controller (▶) and use the four-way controller (▲▼) to select the magnification.**

Select from [Off] (default setting), [×2], [×4], [×8], [×16] or [×32].

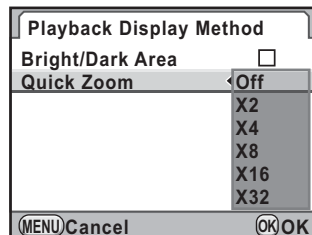

- 5 Press the OK button.**

- 6 Press the MENU button twice.**

The screen that was displayed before selecting the menu appears again.

## Multi-image Display Screen

You can display 4, 9, 16, 36 or 81 images on the monitor at the same time. The default setting is [9].

- 1 Turn the rear e-dial (☀️) to the left (toward 📷) in Playback mode.

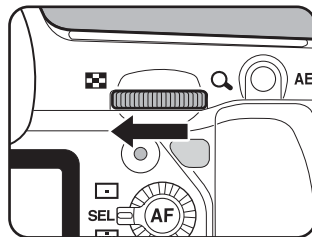

The multi-image display screen appears.

Up to nine thumbnail images will be displayed at once.

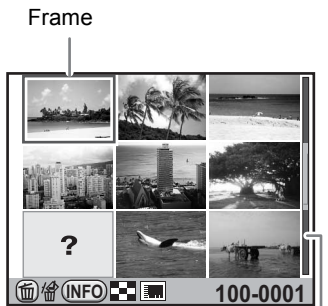

Scroll bar

## Available operations

Four-way controller (▲▼◀▶) Moves selection frame

**INFO** button Displays the [Multi-Img Display Setting] screen. Use the four-way controller (◀▶) to select the number of images to display at the same time.

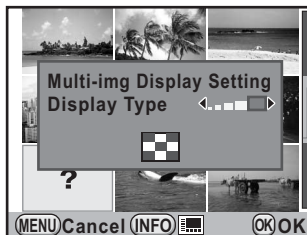

([Display Type] cannot be selected when developing multiple RAW images (p.248).)

Trash button Select the multiple images and press to delete. (p.227)

## 2 Press the OK button.

A full screen display of the selected image appears.

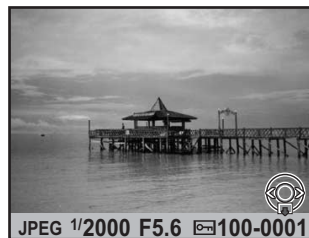

Icons such as and are not displayed with thumbnail images for 81-image display.

## Displaying Images by Folder

Images will be grouped and displayed by the folder in which they are saved.

### 1 On the multi-image display screen, turn the rear e-dial (☀️) again to the left (toward ).

The folder display screen appears.

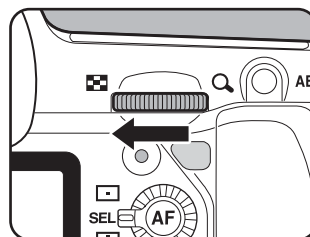

- 2** Select the folder you want to display.

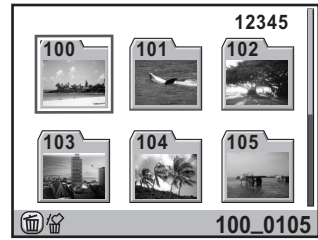

#### Available operations

Four-way controller (▲▼◀▶)	Moves selection frame.
🗑️ button	Deletes the selected folder and all the images in it. (p.228)

- 3** Press the OK button.

The multi-image display screen for the selected folder appears.

## Displaying Images by Shooting Date (Calendar display)

Images will be grouped and displayed by shooting date.

7

Playback Functions

- 1** In the multi-image display screen, press the **INFO** button.

The [Multi-Img Display Setting] screen appears.

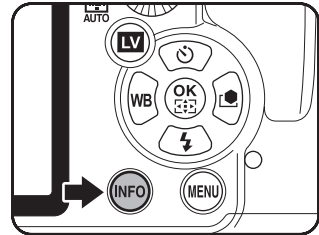

- 2** Press the **INFO** button again.

The calendar display screen appears. Only dates when pictures were taken are displayed.

Number of images shot in this date

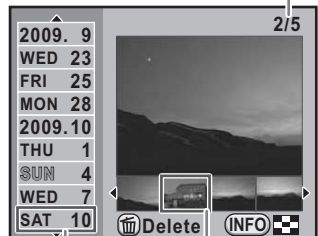

Shooting date

Thumbnail

## Available operations

Four-way controller (▲▼)	Selects shooting date.
Four-way controller (◀▶)	Selects an image of the selected shooting date.
Rear e-dial (☀) to the right (Q)	Displays the selected image. Turn to the left (☒) to return to calendar display.
<b>INFO</b> button	The camera returns to the multi-image display screen.
🗑 button	Deletes selected images.

### 3 Press the OK button.

A full screen display of the selected image appears.

## Joining Multiple Images (Index)

Join a number of saved images together and display them as an index print. You can also save the displayed index print as a new image. You can select the images to include in the index print and have them randomly-arranged.

### 1 Press the four-way controller (▼) in Playback mode.







The playback mode palette appears.

### 2 Use the four-way controller (▲▼◀▶) to select (Index) and press the OK button.

The [Index] screen appears.

### 3 Press the four-way controller (▶).

### 4 Use the four-way controller (▲▼) to select a layout and press the OK button.

You can select  (Thumbnail),  (Square),  (Random1),  (Random2),  (Random3) or  (Bubble).

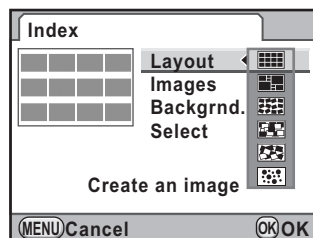

**5** Use the four-way controller (▲▼) to select [Images] and press the four-way controller (▶).

**6** Use the four-way controller (▲▼) to select the number of images and press the OK button.

You can select 12, 24 or 36 images.

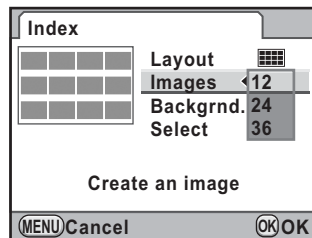

**7** Use the four-way controller (▲▼) to select [Backgrnd.] and press the four-way controller (▶).

**8** Use the four-way controller (▲▼) to select the background color and press the OK button.

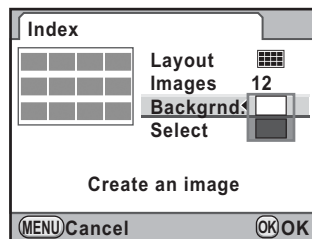

You can select a white or black background.

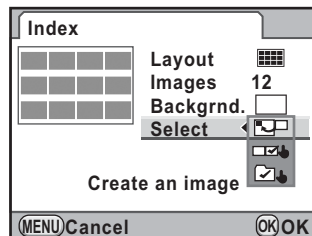

**9** Use the four-way controller (▲▼) to select [Select] and press the four-way controller (▶).

**10** Use the four-way controller (▲▼) to select the type of image selection and press the OK button.



 (All images)	Picks up images automatically from all of the images saved.
 (Manual)	Individually select the images you want to include in the index. Continue by selecting [Select image(s)] and selecting the individual images.
 (Folder name)	Picks up images automatically from the folder selected. Continue by selecting [Select a folder] and selecting the folder.

## 11 Use the four-way controller (▲▼) to select [Create an image] and press the OK button.

The index print is created and a confirmation screen appears.

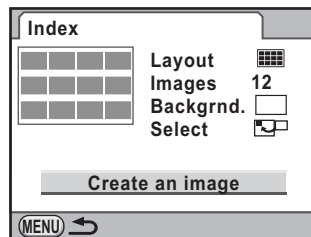

## 12 Use the four-way controller (▲▼) to select [Save] or [Reshuffle] and press the OK button.

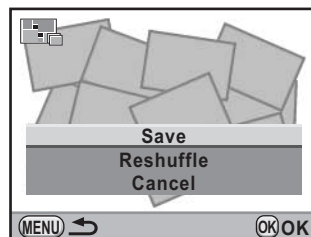

Save	The index image is saved as <b>6M</b> and <b>★★★</b> file.
Reshuffle	Reselects the images included in the index and displays a new index image. If [Thumbnail] is selected for [Layout], this is not displayed.

After the index is saved, the camera returns to Playback mode and the index image is displayed.



- Processing may take a while when creating an index print.
- When the number of saved images is smaller than the number set for [Images], empty spaces will appear in [Thumbnail] layout and some images may be duplicated in other layouts.
- The images are positioned in order starting from the smallest file number when [Thumbnail] or [Square] is selected.

You can play back all images saved on your SD Memory Card successively.

## Setting the Slideshow Display

Sets how images will be displayed during the Slideshow.

### 1 Press the **MENU** button in Playback mode.

The [ Playback 1] menu appears.

### 2 Use the four-way controller (**▲ ▼**) to select [**Slideshow**] and press the four-way controller (**▶**).

The screen to make the slideshow settings appears.

### 3 Use the four-way controller (**▲ ▼**) to select the item you want to change.

The following items can be changed.

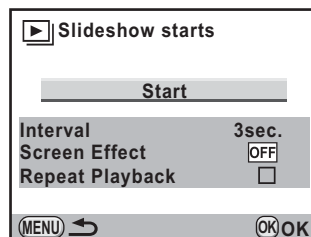

Item	Description	Setting
Interval	Select the image display interval.	3 (default setting)/5/10/30 seconds
Screen Effect	Select the transition effect when the next image is displayed.	Off (default setting)/Fade/Wipe/Stripe
Repeat Playback	Set whether the slideshow will start from the beginning after the last image is displayed.	<input type="checkbox"/> (default setting)/ <input checked="" type="checkbox"/>



- 4** Press the four-way controller (▶) and use the four-way controller (▲▼) to change the setting.

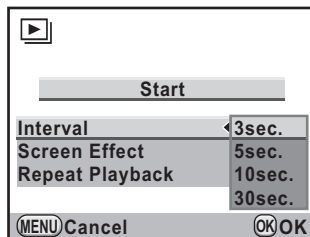

## Starting the Slideshow

- 1** Select [Start] in Step 3 on p.222 and press the **OK** button. Or, select  (Slideshow) in the playback mode palette and press the **OK** button.

The start screen is displayed and slideshow begins.

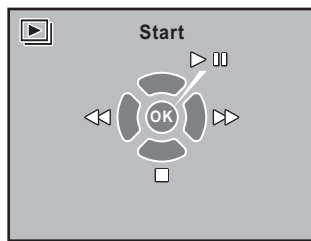



### Available operations

<b>OK</b> button	Pauses playback. Press again to resume playback.
Four-way controller (◀)	Shows previous image.
Four-way controller (▶)	Shows next image.
Four-way controller (▼)	Stops playback.

## 2 Stop the slideshow.

Slideshow ends when one of the following operations is performed during playback or when paused.

- The four-way controller (▼) is pressed\*<sup>1</sup>
- The  button is pressed\*<sup>1</sup>
- The **MENU** button is pressed\*<sup>1</sup>
- The shutter release button is pressed halfway or fully\*<sup>2</sup>
- The mode dial is turned\*<sup>2</sup>
- The **AF** button is pressed\*<sup>2</sup>
- The main switch is turned to \*<sup>2</sup>

\*1 After slideshow ends, the camera switches to normal Playback mode.

\*2 After slideshow ends, the camera switches to Capture mode.



For movies, only the first frame is displayed and then the next image is displayed after the set interval has elapsed. To play a movie during a slideshow, press the **OK** button while the first frame is displayed. After the movie has finished playing, the slideshow will resume.

When pictures are taken with **K-7** held vertically, the vertical position sensor activates and rotation information is added to the image to enable playback with the correct image orientation. You can change the rotation information and save the image using the following procedure.



- The rotation information is not added when [33. Saving Rotation Info] in the [C Custom Setting 5] menu (p.87) is set to [Off].
- During playback, the image is automatically rotated based on the rotation information when [34. Auto Image Rotation] in the [C Custom Setting 5] menu (p.87) is set to [On].

**1** Select the image you want to rotate in Playback mode.

**2** Press the four-way controller (▼).

The playback mode palette appears.

**3** Use the four-way controller (▲▼◀▶) to select ◊ (Image Rotation) and press the OK button.

The selected image is rotated in 90° increments and the four thumbnail images are displayed.

**4** Use the four-way controller (▲▼◀▶) to select the rotation direction and press the OK button.

The image rotation information is saved.

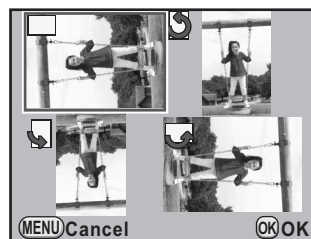

Rotation information cannot be changed for the following cases.

- Protected images
- Images without rotation information
- When [34. Auto Image Rotation] in the [C Custom Setting 5] menu (p.87) is set to [Off]



Images with rotation information are displayed according to the orientation of the camera.

# Comparing Images

You can display two images side-by-side.

## 1 Press the four-way controller (▼) in Playback mode.

The playback mode palette appears.

## 2 Use the four-way controller (▲▼◀▶) to select (Image Comparison) and press the OK button.

The last image displayed will be displayed twice side-by-side.

## 3 Select two images and compare them at left and right.

You can perform the following operations while comparing the images.



### Available operations

<b>OK</b> button	Moves the selection frame to right image, both images, and left image each time the button is pressed.
Four-way controller (▲▼◀▶)	Moves area to enlarge. When the selection frame is placed on both images, you can manipulate both images at the same time.
⊙ (Green) button	Returns the enlarge display position to the center.
Front e-dial (☀️)	When the selection frame is placed on the left or right image, the previous or next image is displayed.
Rear e-dial (🌑)	Enlarges or reduces the image. When the selection frame is placed on both images, you can manipulate both images at the same time.
<b>INFO</b> button	Switches information display On/Off.
🗑️ button	When the selection frame is placed on the left or right image, the selected image is deleted.

## 4 Press the MENU button.

The camera returns to the normal playback mode.

## Deleting Selected Images



You can delete multiple images in the multi-image display at once.



Deleted images cannot be restored.



- Protected images cannot be deleted.
- You can select up to 100 images at a time.

- 1 Turn the rear e-dial (  ) to the left (toward  ) in Playback mode.**

The multi-image display screen appears.

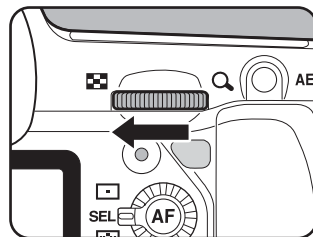

- 2 Press the  button.**

The screen to select the images to delete is displayed.

The screen temporarily changes to 36-image display when [Multi-Img Display Setting] (p.217) is set to 81-image display.

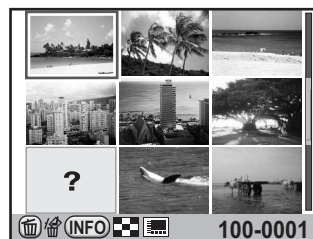

- 3 Select the images to delete.**



## Available operations

Four-way controller (▲▼◀▶)	Moves selection frame
OK button	Adds <input checked="" type="checkbox"/> and selects an image. Press again to return to <input type="checkbox"/> . Protected images (🔒) cannot be selected.
Rear e-dial (🔍)	Displays a full screen display of the image selected with the selection frame. When the image is displayed full screen, press the four-way controller (◀▶) to display the previous or next image.

### 4 Press the button.

The delete confirmation screen appears.

### 5 Press the four-way controller (▲) to select [Select&Delete].

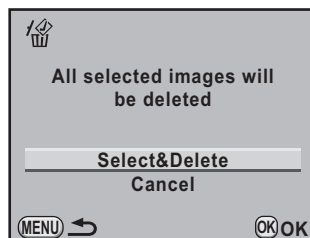

### 6 Press the OK button.

The selected images are deleted.

## Deleting a Folder

You can delete the selected folder and all the images in it.

### 1 Turn the rear e-dial (🔍) two clicks to the left (toward in Playback mode.

The folder display screen appears.

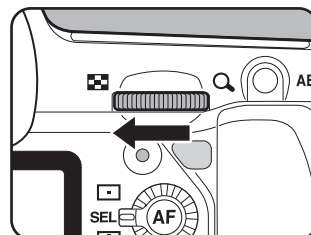

- 2** Use the four-way controller (▲▼◀▶) to select a folder to delete and press the  button.

The delete folder confirmation screen appears.

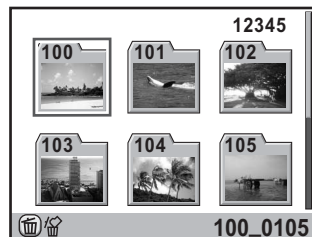

- 3** Press the four-way controller (▲) to select [Delete].

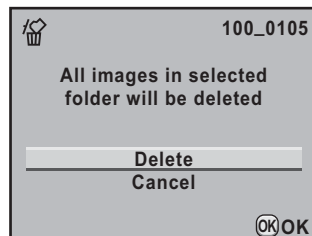

- 4** Press the **OK** button.

The folder and all images in it are deleted.

The confirmation screen appears when there are protected images. Use the four-way controller (▲▼) to select [Delete All] or [Leave All] and press the **OK** button.

When [Delete All] is selected, protected images are also deleted.

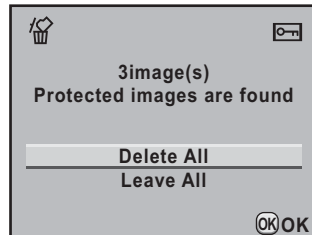

## Deleting All Images

You can delete all saved images at once.



Deleted images cannot be restored.

- 1 Select **[Delete All Images]** in the **[▶ Playback 1]** menu and press the four-way controller (▶).

The confirmation screen for deleting all images is displayed.

- 2 Press the four-way controller (▲) to select **[Delete All Images]**.

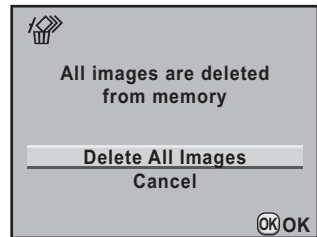

- 3 Press the **OK** button.

All images are deleted.

The confirmation screen appears when there are protected images. Use the four-way controller (▲▼) to select **[Delete All]** or **[Leave All]** and press the **OK** button. When **[Delete All]** is selected, protected images are also deleted.

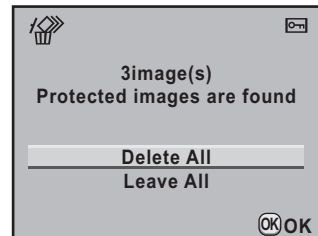



# Protecting Images from Deletion (Protect)

You can protect images from being accidentally deleted.



Even protected images are deleted if the inserted SD Memory Card is formatted.

## Protecting a Single Image

- 1 Press the four-way controller (▼) in Playback mode.**

The playback mode palette appears.

- 2 Use the four-way controller (▲▼◀▶) to select  (Protect) and press the OK button.**

The screen to select the Protect setting method is displayed.

- 3 Use the four-way controller (▲▼) to select [Single Image] and press the OK button.**



- 4 Use the four-way controller (◀▶) to select an image to protect.**

- 5 Press the four-way controller (▲) to select [Protect].**

Select [Unprotect] to cancel the protect settings.



## 6 Press the OK button.

The image is protected and the  icon appears at the top right of the screen.

Repeat Steps 4 to 6 to protect other images.

## Protecting All Images

### 1 Select [All Images] in Step 3 on p.231 and press the OK button.

### 2 Press the four-way controller (▲) to select [Protect] and press the OK button.

All images saved on the SD Memory Card are protected.

Select [Unprotect] to cancel the protect setting on all of the images.



# Connecting the Camera to AV Equipment

You can connect the camera to a TV or other device with a video IN jack or HDMI terminal and play back images.



- If you intend to use the camera continuously for a long period, use of the AC adapter kit K-AC50 (optional) is recommended. (p.47)
- For AV equipment with multiple video IN jacks, check the operating manual of the AV device, and select the video IN jack to which the camera is connected.
- You cannot output composite and HDMI video at the same time.
- You cannot adjust the volume on the camera when connected to an AV device. Adjust the volume on the AV device.

## Connecting the Camera to a Video IN Jack

Use the provided AV cable (I-AVC7) to connect the camera to a device with a video IN jack.

- 1 Turn the AV device and camera off.**
- 2 Open the terminal cover, face the arrow on the provided AV cable toward the ▲ mark on the camera, and connect the cable to the PC/AV terminal.**

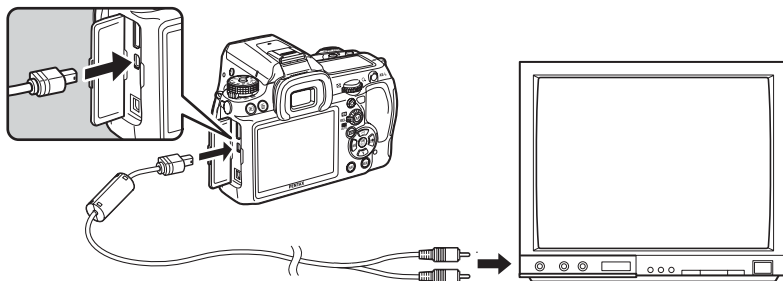

- 3 Connect the other end of the AV cable to the video IN jack on the AV device.**

## 4 Turn the AV device and camera on.

The camera turns on in video mode, and the camera information is displayed on the screen of the connected AV device.



Even if you used an external microphone to record movie sound in stereo, monaural sound is played back.

## Selecting the Video Output Format

When the hometown is set with the default setting (p.57), the video output format is set in accordance with that region. Depending on the country or region, images may fail to be played back with the default video output format. If this happens, change the video output format setting.

**1** Select [Video Out] in the [ Set-up 2] menu and press the four-way controller (▶).

**2** Use the four-way controller (▲▼) to select [NTSC] or [PAL].

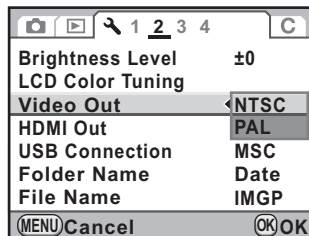

**3** Press the OK button.

**4** Press the MENU button.

The video output format is set.



The video output format differs depending on the region. When you set [Setting the Time] in the World Time setting (p.258) to (Destination), the video output setting changes to the video output format for that city.

## Connecting the Camera to an HDMI Terminal

Use a commercially available HDMI cable to connect the camera to a device with an HDMI terminal.

**1** Turn the AV device and camera off.

**2** Open the terminal cover and connect the HDMI cable to the HDMI terminal.

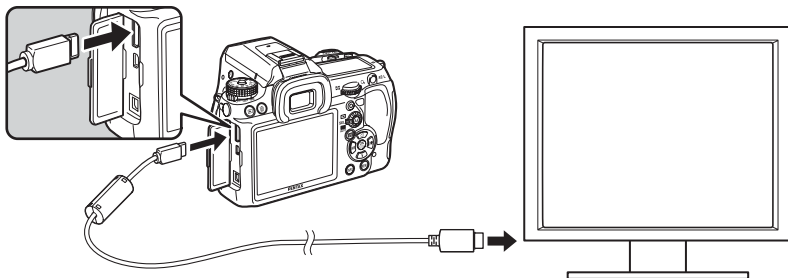

**3** Connect the other end of the HDMI cable to the HDMI IN jack on the AV device.

**4** Turn the AV device and camera on.

The camera turns on in HDMI mode, and the camera information is displayed on the screen of the connected AV device.



- The camera has a Type C (Mini) HDMI terminal. Use a commercially available HDMI cable that matches your AV device.
- Nothing is displayed on the camera monitor during HDMI output.
- If you used an external microphone to record movie sound in stereo, the sound is played back in stereo.

## Selecting the HDMI Output Format

Set the output signal format of the HDMI terminal.

**1** Select [HDMI Out] in the [ Set-up 2] menu and press the four-way controller (▶).

**2** Use the four-way controller (▲▼) to select the HDMI output format.

Auto	The maximum size corresponding the AV device and camera is automatically selected. (default setting)
1080i	1920×1080i
720p	1280×720p
480p <sup>*1</sup>	720×480p

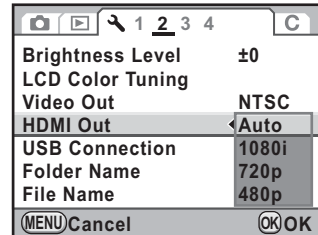

\*1 When [480p] is selected, HDMI output format switches between 480p [NTSC] and 576p (720×576p) [PAL] depending on the video output format setting.

**3** Press the **OK** button.

**4** Press the **MENU** button.

The HDMI output format is set.



- When the HDMI output format is set to [1080i] or [720p], the display may appear with a screen design that differs from that displayed on the camera.
- The Bright/Dark Area warning is not displayed during Live View.
- When the exposure mode is set to (Movie), the output format is fixed to [480p] regardless of the HDMI output format setting.

# 8 Processing Images

---

This chapter describes how to process pictures taken and edit RAW images.

<b>Changing the Image Size .....</b>	<b>238</b>
<b>Processing Images with Digital Filters .....</b>	<b>241</b>
<b>Developing RAW Images .....</b>	<b>247</b>
<b>Readjusting Images Shot in JPEG Format .....</b>	<b>252</b>

Changes the number of recorded pixels and saves it as a new image.

## Changing the Number of Recorded Pixels and Quality Level (Resize)

Changes the number of recorded pixels and quality level and saves it as a new image. The number of recorded pixels can be reduced while still obtaining an image with good quality.



- Only JPEG files captured with this camera can be resized.
- You cannot select a larger resolution than that of the original image.
- Images resized to 640 with this camera cannot be resized.

**1** Select an image to resize in Playback mode.

**2** Press the four-way controller (▼).

The playback mode palette appears.

**3** Use the four-way controller (▲▼◀▶) to select  (Resize) and press the OK button.

The screen to select the recorded pixels and quality level appears.

**4** Use the four-way controller (◀▶) to select a size.

You can select one size smaller than that of the original image. The selectable size differs according to the original image size and aspect ratio.

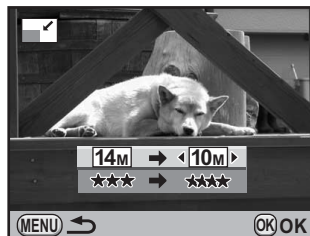

**5** Press the four-way controller (▼) and use the four-way controller (◀▶) to select the quality level.

You can select ☆☆☆, ☆☆☆, ☆☆☆ or ☆.



## 6 Press the OK button.

The save confirmation screen appears.

## 7 Use the four-way controller (▲▼) to select [Save as].



## 8 Press the OK button.

The resized image is saved as a new image.

# Cutting Out Part of the Image (Cropping)

Cuts out only the desired area of the picture and saves it as a new image. The aspect ratio can also be changed.



- Only JPEG and RAW files captured with this camera can be cropped.
- Images resized to **1M** or **640** with this camera cannot be cropped.

## 1 Select an image to crop in Playback mode.

## 2 Press the four-way controller (▼).

The playback mode palette appears.

## 3 Use the four-way controller (▲▼◀▶) to select (Cropping) and press the OK button.

The cropping frame to specify the size and position of the area to crop appears on the screen.

- 4** Specify the size and position of the area to crop by using cropping frame.



### Available operations

Rear e-dial (☀️)	Changes the size of the cropping frame.
Four-way controller (▲▼◀▶)	Moves the cropping frame.
INFO button	Changes the aspect ratio. Select from [3:2], [4:3], [16:9] or [1:1]. The image can also be rotated from -45° to +45° in increments of 1°.

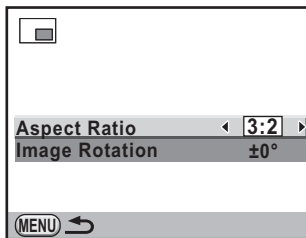

- |                  |   |
|------------------|---|
| ⊙ (Green) button | Rotates the cropping frame in 90° increments.<br>⊙ appears only when the size of the cropping frame can be rotated. |
|------------------|---|

- 5** Press the OK button.

The save confirmation screen appears.

- 6** Use the four-way controller (▲▼) to select [Save as].



- 7** Press the OK button.

The cropped image is saved as a new image.

# Processing Images with Digital Filters

You can edit captured images using digital filters. A processed image is saved as a new image with a size of **14M** and a quality level of **★★★**. The following filters are available.

Filter name	Effect	Parameter
Toy Camera	Creates an image that looks as though it was shot with a toy camera.	Shading Level: +1/+2/+3
		Blur: +1/+2/+3
		Tone Break: Red/Green/Blue/Yellow
Retro	Creates an image with the look of an old photo.	Toning: -3 to +3
		Frame Composite: None/Thin/Medium/Thick
High Contrast	Enhances the contrast in the image.	+1 to +5
Extract Color	Extracts a specific color and shoots the rest of the image in black and white.	Color: Red/Magenta/Blue/Cyan/Green/Yellow
		Color Freq. Range: -2 to +2
Soft	Creates an image with a soft focus throughout the image.	Soft Focus: +1/+2/+3
		Shadow Blur: On/Off
Star Burst	For taking pictures of night scenes or lights reflected on water with a special sparkling look achieved by adding cross-like effects to the picture's highlights.	Effect Density: Small/Medium/Large
		Size: Short/Medium/Long
		Angle: 0°/30°/45°/60°
Fish-eye	Creates an image that looks as though it was shot with a fish-eye lens.	Weak/Medium/Strong
Monochrome	Creates a monochrome image such as a black-and-white photo.	Filter Effect: B&W/Red/Green/Blue
		Toning (B-A): 7 levels
Color	Adds a color filter to the image. Select from 18 filters (6 colors × 3 tones).	Color: Red/Magenta/Cyan/Blue/Green/Yellow
		Color Density: Light/Standard/Dark

Filter name	Effect	Parameter
Water Color	Creates an image that looks as though it was painted.	Intensity: Weak/Standard/Strong
		Saturation: Low/Medium/High
Pastel	Creates an image that looks as though it was drawn with a crayon.	Weak/Standard/Strong
Slim	Changes the horizontal and vertical ratio of images.	±8 levels
Miniature	Blurs part of the image to create a fake miniature scene.	Front/Middle/Back
HDR	Creates an image that looks like a high dynamic range image.	Weak/Standard/Strong
Base Parameter Adj	Adjusts the parameters to create the desired image.	Brightness: ±8 levels
		Saturation: ±3 levels
		Hue: ±3 levels
		Contrast: ±3 levels
		Sharpness: ±3 levels
Custom Filter	Customize and save a filter to your own preferences.	High Contrast: Off/+1 to +5
		Soft Focus: Off/+1/+2/+3
		Tone Break: Off/Red/Green/Blue/Yellow
		Shading Type: 6 types
		Shading Level: -3 to +3
		Invert Color: Off/On
		Distortion Type: 3 types
		Distortion Level: Off/Weak/Medium/Strong



Only JPEG and RAW files captured with this camera can be edited using the Digital Filters.

## Applying the Digital Filter

- 1 Select an image for applying the digital filter in Playback mode.
- 2 Press the four-way controller (▼).  
The playback mode palette appears.
- 3 Use the four-way controller (▲▼◀▶) to select **0** (Digital Filter) and press the OK button.  
The screen to select the filter appears.

- 4 Use the four-way controller (▲▼◀▶) to select a filter and press the OK button.

After selecting a filter, you can check the effects on the screen.

You can turn the front e-dial (☀️) to select a different image.

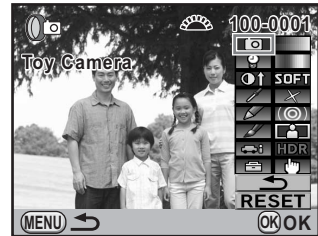

- 5 Use the four-way controller (▲▼) to select the parameter and the four-way controller (◀▶) to adjust the value.

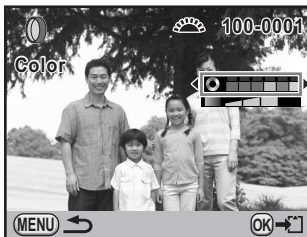

Color Filter

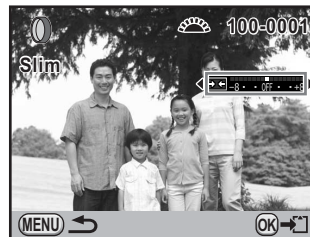

Slim Filter

- 6 Press the OK button.

The save confirmation screen appears.

## 7 Use the four-way controller (▲▼) to select [Uses filters in combination] or [Save as].

Select [Uses filters in combination] when you want to apply additional filters to the same image.



## 8 Press the OK button.

If [Uses filters in combination] was selected, the camera will return to Step 4.

If [Save as] was selected, the filter-processed image will be saved as a new image.



Up to 20 filters, including digital filters during shooting (p.153), can be combined to the same image.

## Recreating Filter Effects

Retrieves the setting of an image with filter effects and apply the same filter effects to other images.

8

Processing Images

### 1 Select a filter-processed image in Playback mode.

### 2 Select [Digital Filter] in the playback mode palette.

### 3 Use the four-way controller (▲▼) to select [Recreating filter effects] and press the OK button.

The history of the filter set for the selected image appears.



#### 4 To check the parameter details, press the INFO button.

You can check the filter parameters.



#### 5 Press the OK button.

The image selection screen appears.

#### 6 Use the four-way controller (◀▶) to select an image for applying the same filter effects and press the OK button.

You can only select an image that has not been processed with a filter.

The save confirmation screen appears.

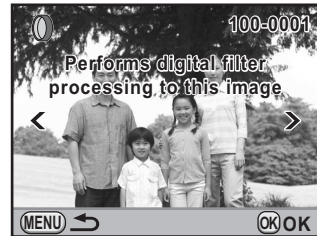

#### 7 Use the four-way controller (▲▼) to select [Save as] and press the OK button.

The filter-processed image will be saved as a new image.



## Searching for the Original Image

Searches for and displays the original image prior to digital filter application.

- 1 Select [Searching for the original image] in Step 3 on p.244 and press the OK button.**

The original image prior to digital filter application is retrieved.

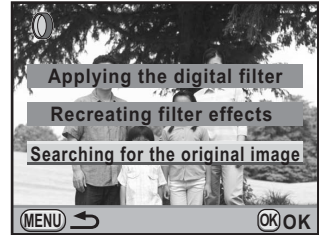

If the original image is no longer stored on the SD Memory Card, the message [Original image, prior to digital filter application, is not found] appears.



You can convert captured RAW files into JPEG or TIFF files.



Only RAW files captured with this camera can be edited. RAW files and JPEG files captured with other cameras cannot be edited on this camera.

## Developing One RAW Image

- 1 Select a RAW image in Playback mode.**
- 2 Press the four-way controller (▼).**  
The playback mode palette appears.
- 3 Use the four-way controller (▲▼◀▶) to select <sup>RAW</sup> (RAW Development) and press the OK button.**  
The screen to select the development method is displayed.
- 4 Use the four-way controller (▲▼) to select [Developing Single Image] and press the OK button.**

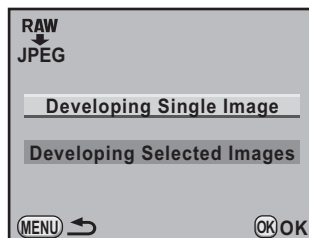

The parameters recorded in the image file appear.

You can turn the front e-dial (☀️) to select a different image.

To specify the parameters before developing, see “Specifying the Parameters” (p.250).

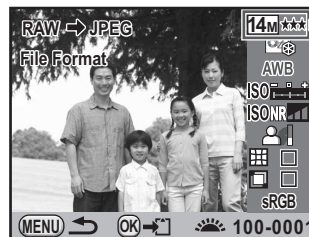

## 5 Press the OK button.

The save confirmation screen appears.

## 6 Use the four-way controller (▲▼) to select [Save as] and press the OK button.

The RAW image is developed and saved as a new image.

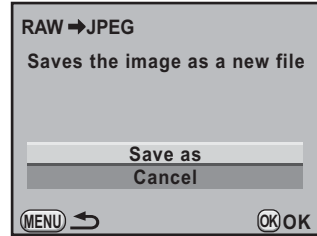

## 7 Use the four-way controller (▲▼) to select [Exit] and press the OK button.

Select [Continue] to edit other images.

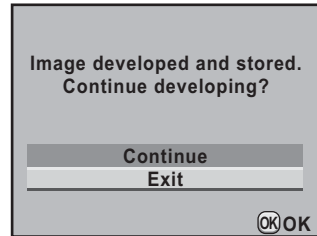

## Developing Multiple RAW Images

8

You can develop multiple RAW images using the same settings.

## 1 Select [Developing Selected Images] in Step 4 on p.247 and press the OK button.

The multi-image display screen appears.

Refer to p.216 for operations in the multi-image display screen.

## 2 Use the four-way controller (▲▼◀▶) to select the RAW images to be developed and press the OK button.

## 3 Press the AE-L button.

The development confirmation screen appears.

#### 4 Use the four-way controller (▲▼) to select [Develop images as shot] or [Develop images with modified settings].

To change the parameters, select [Develop images with modified settings]. For details, see “Specifying the Parameters” (p.250).

The screen to select the parameter appears.



#### 5 Set [File Format], [Recorded Pixels] and [Quality Level].

You can select [JPEG] or [TIFF] for the file format. If [TIFF] is selected, the [Recorded Pixels] and [Quality Level] settings are not available.

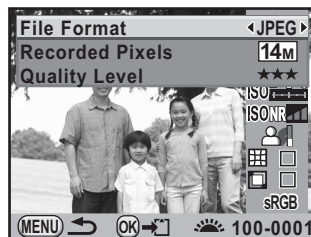

#### 6 Press the OK button.

The save confirmation screen appears.

#### 7 Use the four-way controller (▲▼) to select [Save as] and press the OK button.

The selected RAW images are developed and saved as new images.

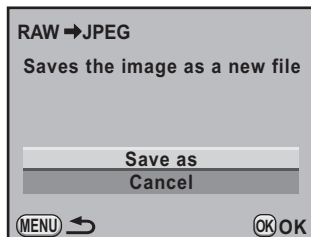

## Specifying the Parameters

Specify the parameters for developing RAW images.  
The following parameters can be changed.

Parameter	Value	Page
File Format	JPEG/TIFF	–
Recorded Pixels* <sup>1</sup>	<b>14M</b> (4672×3104)/ <b>10M</b> (3936×2624)/ <b>6M</b> (3072×2048)/ <b>2M</b> (1728×1152)	p.186
Quality Level* <sup>1</sup>	★★★★ (Premium) / ★★★ (Best) / ★★ (Better) / ★ (Good)	p.187
Custom Image	Bright/Natural/Portrait/Landscape/Vibrant/ Muted/Monochrome	p.205
White Balance* <sup>2</sup>	<b>AWB</b> (Auto), ☀ (Daylight), ☂ (Shade), ☁ (Cloudy), ☀ <b>D</b> (Fluorescent Light Daylight Color), ☀ <b>N</b> (Fluorescent Light Daylight White), ☀ <b>W</b> (Fluorescent Light Cool White), ☀ <b>L</b> (Fluorescent Light Warm White), ☀ (Tungsten Light), ⚡ <b>WB</b> (Flash), <b>CTE</b> , 📷 (Manual), <b>K</b> (Color Temperature)	p.191
Sensitivity	-2.0 to +2.0	–
High-ISO Noise Reduction	Off/Low/Medium/High	p.92
Shadow Correction	Off/Low/Medium/High	p.199
Distortion Correction* <sup>3</sup>	Off/On	p.201
Lat-Chromatic-Ab Adj* <sup>3</sup>	Off/On	p.201
Color Space	sRGB/AdobeRGB	p.279

\*1 This cannot be set when [File Format] is set to [TIFF]. (The setting is fixed to **14M**.)

\*2 This cannot be set for RAW files taken in Multi-exposure mode.

\*3 This can be selected only when a compatible lens is attached. (p.201)

**1** Press the four-way controller (▲▼) in Step 4 on p.247 to choose the parameter you want to change.

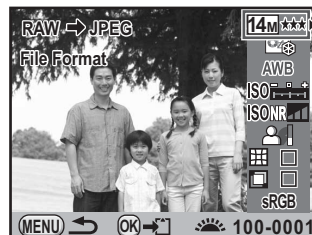

---

## 2 Use the four-way controller (◀▶) to change the value.

Use the four-way controller (▶) to display the setting screen for White Balance and Custom Image.

---

## 3 Press the OK button.



The save confirmation screen appears.

---

## 4 Use the four-way controller (▲▼) to select [Save as] and press the OK button.

The RAW image is developed and saved as a new image.



- You cannot save the background image or use Digital Preview with White Balance/Custom Image.
- When the white balance is set to  (Manual), press the  button to display the measuring screen.

# Readjusting Images Shot in JPEG Format

You can readjust Custom Image and White Balance for images shot in JPEG format immediately after shooting them without deteriorating image quality.

---

## 1 Set the file format to [JPEG] and shoot an image.

Refer to p.188 for setting File Format.

---

## 2 Press the four-way controller (◀) to change White Balance, or press the four-way controller (▶) to change Custom Image.

The [White Balance] or [Custom Image] screen appears.

---

## 3 Set White Balance or Custom Image as desired.

Custom Image or White Balance can be set using the same procedures as before shooting.

Refer to p.191 for setting White Balance and p.205 for setting Custom Image.

---

## 4 Press the AE-L button.

The save confirmation screen appears.

---

## 5 Use the four-way controller (▲▼) to select [Save as] and press the OK button.

The image with the White Balance or Custom Image setting is saved as a new image.



The image can be readjusted only right after being shot. Adjustments cannot be made after new images are shot or the camera is turned off.

# 9 Changing Additional Settings

---

This chapter describes how to change additional settings.

<b>How to Operate the Set-up Menu .....</b>	<b>254</b>
<b>Formatting the SD Memory Card .....</b>	<b>256</b>
<b>Setting the Beep, Date and Time, and Display Language .....</b>	<b>257</b>
<b>Adjusting the Monitor and the Menu Display ..</b>	<b>262</b>
<b>Setting the Folder Name/File Number Naming Convention .....</b>	<b>267</b>
<b>Setting the Power Setting .....</b>	<b>270</b>
<b>Setting the DPOF Settings .....</b>	<b>273</b>
<b>Setting USB Connection Mode .....</b>	<b>275</b>
<b>Setting the Photographer Information Saved to Exif .....</b>	<b>277</b>
<b>Setting the Color Space.....</b>	<b>279</b>
<b>Correcting Defective Pixels in the CMOS Sensor (Pixel Mapping) .....</b>	<b>280</b>
<b>Selecting Settings to Save in the Camera (Memory) .....</b>	<b>281</b>

# How to Operate the Set-up Menu



Perform various settings related to the camera in the [ Set-up] menu.





Refer to “Using the Menus” (p.36) for details on menu operations.

## Set-up Menu Setting Items

Perform the following settings in the [ Set-up 1-4] menu.

Press the **MENU** button in Capture/Playback mode and use the four-way controller ( ) to display the [ Set-up 1-4] menu.

Menu	Item	Function	Page
 1	Language/言語	Changes the language in which menus and messages appear.	p.261
	Date Adjustment	Sets the date format and time.	p.258
	World Time	Sets display of local date and time of a specified city in addition to the present location on the monitor when traveling overseas.	p.258
	Text Size	Sets the size of the text selected in the menus.	p.262
	Guide Display	Sets to display indicators on the monitor.	p.262
	Beep	Switches the beep tone on/off.	p.257
 2	Brightness Level	Changes the brightness of the monitor.	p.264
	LCD Color Tuning	Adjusts the color of the monitor.	p.265
	Video Out	Sets the output format when connecting to an AV device with a video jack.	p.234
	HDMI Out	Sets the HDMI output format when connecting to an AV device with an HDMI terminal.	p.236
	USB Connection	Sets the USB connection mode when connecting to a computer.	p.275
	Folder Name	Sets the method used to assign folder names for storing images.	p.267
	File Name	Sets the method used to assign file names for images.	p.268



Menu	Item	Function	Page
3	Copyright Information	Sets the photographer and copyright information embedded to Exif.	p.277
	Auto Power Off	Sets the time to turn off automatically.	p.270
	Select Battery	Sets the battery to use when the optional battery grip (D-BG4) is attached.	p.270
	Reset	Resets all settings.	p.290
4	Pixel Mapping	Maps out and corrects for any defective pixels in the CMOS sensor.	p.280
	Dust Alert	Detects dust adhering to the CMOS sensor.	p.296
	Dust Removal	Cleans the CMOS sensor using ultrasonic vibrations.	p.295
	Sensor Cleaning	Locks the mirror in the up position for cleaning the CMOS sensor.	p.297
	Format	Formats the SD Memory Card.	p.256

### ● [3] Set-up 1] menu



### ● [3] Set-up 2] menu

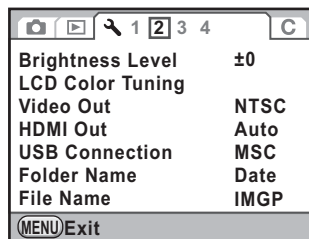

### ● [3] Set-up 3] menu

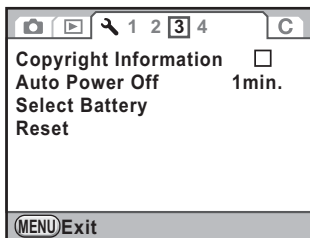

### ● [3] Set-up 4] menu

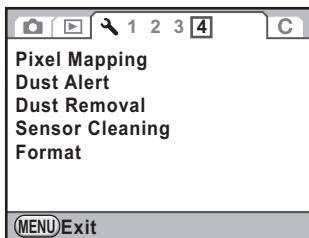

# Formatting the SD Memory Card

Use this camera to format (initialize) an SD Memory Card that is unused or has been used on other cameras or digital devices. Formatting will delete all the data on the SD Memory Card.



- Do not remove the SD Memory Card while formatting. The card may be damaged and become unusable.
- Note that formatting will delete all data, either protected or unprotected.

## 1 Select [Format] in the [ Set-up 4] menu and press the four-way controller (▶).

The [Format] screen appears.

## 2 Press the four-way controller (▲) to select [Format].

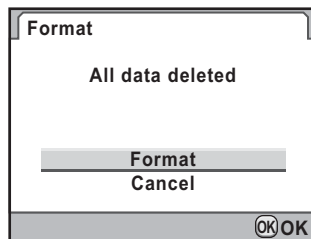

## 3 Press the OK button.

Formatting starts.

When formatting is completed, the screen that was displayed before selecting the menu appears again.

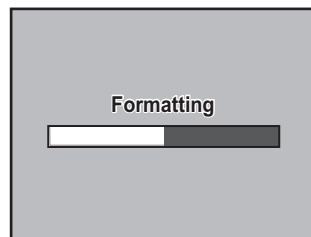

## Setting the Beep

You can turn the camera operation beep on or off.

There are five items that you can set: In-focus, AE lock, **RAW** button operation sound, self-timer and remote control.

The default setting is all  (On).

- 1** Select **[Beep]** in the [**Set-up 1**] menu and press the four-way controller (**▶**).

The [Beep] screen appears.

- 2** Use the four-way controller (**▲ ▼**) to select an item and use the four-way controller (**◀ ▶**) to select  or .

You can turn all the beeps off by selecting  for [Setting].

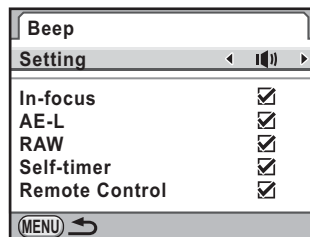

- 3** Press the **MENU** button twice.

The screen that was displayed before selecting the menu appears again.

## Changing the Date Display

You can change the initial date and time settings. You can also set the display style. Choose [mm/dd/yy], [dd/mm/yy] or [yy/mm/dd].

Choose [12h] (12 hour) or [24h] (24 hour) for time display method.

Set in [Date Adjustment] in the [↖ Set-up 1] menu (p.254).

☞ Setting the Date and Time (p.61)

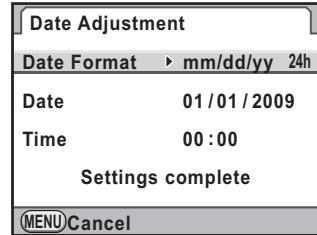

## Setting the World Time

The date and time set in “Initial Settings” (p.57) serve as the date and time of your present location.

Setting the destination in [World Time] enables you to display the local date and time on the monitor when traveling overseas.

- 1 Select [World Time] in the [↖ Set-up 1] menu and press the four-way controller (▶).**

The [World Time] screen appears.

- 2 Use the four-way controller (◀▶) to select → (Destination) or ↻ (Hometown) for [Setting the Time].**

This setting changes the date and time on the guide display screen.

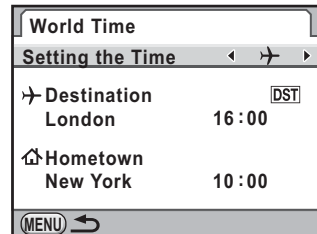

### 3 Press the four-way controller (▲▼).

The selection frame moves to ➔ (Destination setting).

### 4 Press the four-way controller (▶).

The [Destination] screen appears.

### 5 Use the four-way controller (◀▶) to select a destination city.

Turn the rear e-dial (☀) to change the map.

The location, time difference and current time of the selected city appears.

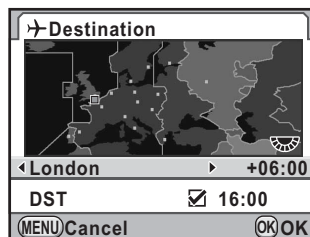

### 6 Use the four-way controller (▲▼) to select [DST].

### 7 Use the four-way controller (◀▶) to select or .

Select  (On) if the destination city uses daylight saving time (DST).

### 8 Press the OK button.

The destination setting is saved.

### 9 Press the MENU button twice.

The screen that was displayed before selecting the menu appears again.



- Refer to “List of World Time Cities” (p.260) for cities that can be specified as a destination.
- Select 🏠 (Hometown) in Step 2 to select the city and DST setting.
- ➔ appears in the guide display and status screen if [Setting the Time] is set to ➔ (Destination). (p.22)
- When you set [Setting the Time] to ➔ (Destination), the video output (p.234) setting changes to the default setting for that city.

## List of World Time Cities

Region	City	Region	City
North America	Honolulu	Africa/West Asia	Dakar
	Anchorage		Algiers
	Vancouver		Johannesburg
	San Francisco		Istanbul
	Los Angeles		Cairo
	Calgary		Jerusalem
	Denver		Nairobi
	Chicago		Jeddah
	Miami		Tehran
	Toronto		Dubai
	New York	Karachi	
	Halifax	Kabul	
Central and South America	Mexico City	Male	
	Lima	Delhi	
	Santiago	Colombo	
	Caracas	Kathmandu	
	Buenos Aires	Dacca	
	Sao Paulo	East Asia	Yangon
	Rio de Janeiro		Bangkok
Europe	Lisbon		Kuala Lumpur
	Madrid		Vientiane
	London		Singapore
	Paris		Phnom Penh
	Amsterdam		Ho chi Minh
	Milan		Jakarta
	Rome		Hong Kong
	Copenhagen		Beijing
	Berlin	Shanghai	
	Prague	Manila	
	Stockholm	Taipei	
	Budapest	Seoul	
	Warsaw	Tokyo	
	Athens	Guam	
	Helsinki		
	Moscow		

Region	City
Oceania	Perth
	Adelaide
	Sydney
	Noumea
	Wellington
	Auckland
	Pago Pago

## Setting the Display Language

You can change the language in which the menus, error messages, etc. are displayed.

You can choose from 20 languages: English, French, German, Spanish, Portuguese, Italian, Dutch, Danish, Swedish, Finnish, Polish, Czech, Hungarian, Turkish, Greek, Russian, Korean, Chinese (Traditional/Simplified) and Japanese.

Set in [Language/言語] in the [↖ Set-up 1] menu (p.254).

- ☞ Setting the Display Language (p.57)



# Adjusting the Monitor and the Menu Display

## Setting the Text Size

You can set the size of the text selected in the menus to [Standard] (normal display) or [Large] (magnified display).

Set in [Text Size] in the [ Set-up 1] menu (p.254).

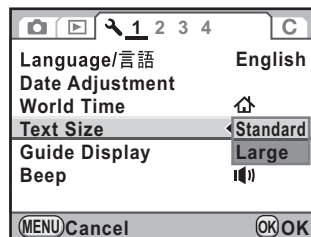

## Setting the Guide Display Time

Set the length of time that the guides are displayed on the monitor when the camera is turned on or the Capture mode is changed. (p.22)

Select from [3sec.] (default setting), [10sec.], [30sec.] and [Off].

Set in [Guide Display] in the [ Set-up 1] menu (p.254).

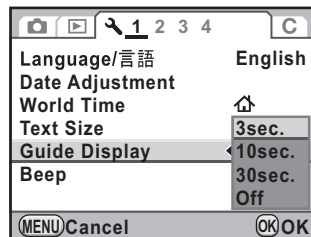

## Setting the Status Screen Display

You can set whether to display the status screen on the monitor and set the display color of the status screen, control panel and playback mode palette.



- 1 Select [Status Screen] in the [📷 Rec. Mode 3] menu and press the four-way controller (▶).

The [Status Screen] screen appears.

- 2 Use the four-way controller (◀▶) to select  or .

: Displays status screen (default setting).

: Does not display status screen.

- 3 Use the four-way controller (▲▼) to select [Display Color].

- 4 Use the four-way controller (◀▶) to select from the six display colors.

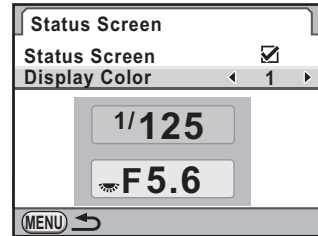

- 5 Press the MENU button twice.

The status screen display and display color settings are changed.

## Setting the Display for Instant Review

You can set the Instant Review display time and whether or not to display the histogram and Bright/Dark Area warning. The default settings are [1sec.] for the [Display Time] and [Off] for [Histogram] and [Bright/Dark Area].

- 1 Select [Instant Review] in the [📷 Rec. Mode 3] menu and press the four-way controller (▶).

The [Instant Review] screen appears.

- 2** Press the four-way controller (▶) and use the four-way controller (▲▼) to select the display time for [Instant Review].

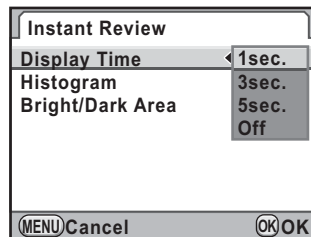

- 3** Press the OK button.

- 4** Use the four-way controller (▲▼) to select [Histogram] or [Bright/Dark Area].

- 5** Use the four-way controller (◀▶) to select  or .

- 6** Press the MENU button twice.

The screen that was displayed before selecting the menu appears again.

## Adjusting the Brightness of the Monitor

You can adjust the brightness of the monitor. Adjust settings when the monitor is hard to see.

- 1** Select [Brightness Level] in the [↖ Set-up 2] menu and press the four-way controller (▶).

The [Brightness Level] screen appears.

- 2** Use the four-way controller (◀▶) to adjust the brightness.

You can adjust the value from the 15 levels.

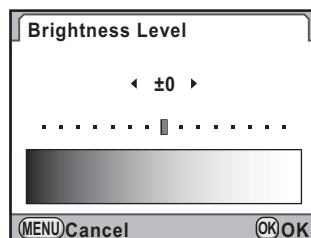

- 3** Press the OK button.

## 4 Press the MENU button.

The screen that was displayed before selecting the menu appears again.

## Adjusting the Color of the Monitor

You can adjust the color of the monitor.

### 1 Select [LCD Color Tuning] in the [↖ Set-up 2] menu and press the four-way controller (▶).

The [LCD Color Tuning] screen appears.

### 2 Adjust the color.

Seven levels (225 patterns) are available on the G-M and B-A axes.

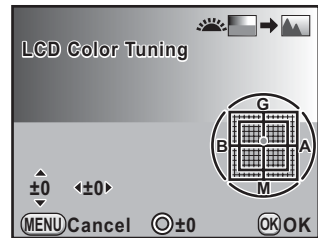

#### Available operations

Four-way controller (▲▼)	Adjusts the tone of the colors between green (G) and magenta (M).
Four-way controller (◀▶)	Adjusts the tone of the colors between blue (B) and amber (A).
⊙ (Green) button	Resets the adjustment value.
Front e-dial (☀)	Displays a saved image in the background so you can adjust the color while viewing the image. This is useful for matching the color of the monitor with that of a computer.

### 3 Press the OK button.

### 4 Press the MENU button.

The screen that was displayed before selecting the menu appears again.

## Setting the Electronic Level Display

This camera is equipped with an electronic level for detecting whether the camera is level, as indicated on the bar graph in the viewfinder and on the LCD panel. Select whether to display the bar graph.

**1** Select [Electronic Level] in the [📷 Rec. Mode 3] menu.

**2** Use the four-way controller (◀▶) to select  or .

- : Displays the bar graph of the electronic level
- : Does not display the bar graph of the electronic level (default setting)

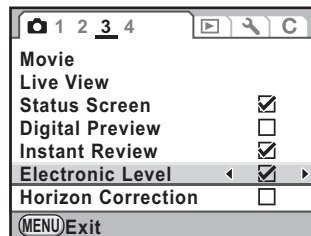

**3** Press the MENU button.

The screen that was displayed before selecting the menu appears again.



The bar graph is also displayed on the LCD panel during Live View. (p.159)

## Selecting the Folder Name

You can select a method for assigning the folder names for storing images.

Date	The two digits of the [month] and [day] on which the picture was taken are assigned as the folder name in the form of [xxx_MMDD]. [xxx] is a sequential number from 100 to 999. [MMDD] (month and day) appears according to the date format set in [Date Adjustment] (p.258). (default setting) Example: 101_0125: for folders with pictures taken on January 25th
PENTX	The folder name is assigned in the form of [xxxPENTX]. Example: 101PENTX

Set in [Folder Name] in the [  Set-up 2] menu (p.254).

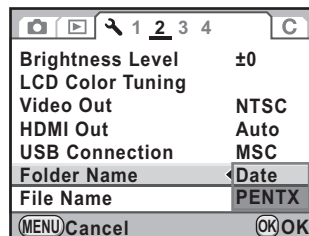

## Selecting the File Number Setting

You can select a method for assigning the file number of an image when saved to a new folder. Select  or  for [File No.] in [Memory] (p.281) in the [  Rec. Mode 4] menu.

<input checked="" type="checkbox"/>	The file number of the last image saved to the previous folder is saved and subsequent images are assigned sequential file numbers even if a new folder is created.
<input type="checkbox"/>	The file number of the first image saved to a folder returns to 0001 each time a new folder is created for saving images.



When the number of storable images exceeds 500, captured images are divided into folders of 500 images each. However, in Auto Bracket shooting, images will be stored in the same folder until shooting is completed, even if the number of images exceeds 500.

## Setting the File Name

You can change the file names of images.

The default naming conventions for the color space (p.279) settings are as follows.

[xxxx] indicates the file number. This is displayed as a four-digit sequential number. (p.267)

Color Space	File Name
sRGB	IMGPxxxx.JPG
AdobeRGB	_IGPxxxx.JPG

For sRGB, you can change [IMGP] (4 characters) to the desired characters.

For AdobeRGB, of the 4 characters you selected, the first 3 are assigned in place of [IGP].

Example: When set to [ABCDxxxx.JPG], files are named  
[\_ABCxxxx.JPG] for AdobeRGB

### 1 Select [File Name] in the [ Set-up 2] menu and press the four-way controller (▶).

The [File Name] screen appears.

### 2 Use the four-way controller (▲▼) to select [Change] and press the four-way controller (▶).

The text-entry screen appears.

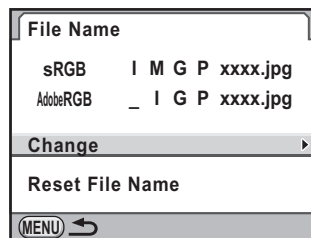

### 3 Change the text.

Text selection  
cursor

Text input  
cursor

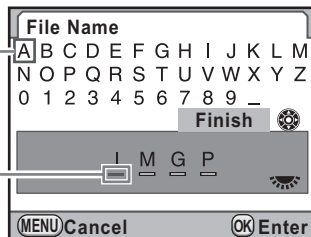

### Available operations

Rear e-dial (☀️)	Moves text input cursor.
Four-way controller (▲▼◀▶)	Moves text selection cursor.
<b>OK</b> button	Enters a character selected with the text selection cursor at the position of the text input cursor.

- 4** After entering the text, move the text selection cursor to [Finish] and press the **OK** button.

The file name is changed.

- 5** Press the **MENU** button twice.

The screen that was displayed before selecting the menu appears again.

### Resetting the File Name

You can reset a changed file name to its default setting.

- 1** Select [Reset File Name] in Step 2 on p.268 and press the **OK** button.

The file name is reset.

- 2** Press the **MENU** button twice.

The screen that was displayed before selecting the menu appears again.

## Setting Auto Power Off

You can set the camera to turn off automatically if unused after a certain length of time. Select from [1min.] (default setting), [3min.], [5min.], [10min.], [30min.] or [Off].

Set in [Auto Power Off] in the [ Set-up 3] menu (p.255).

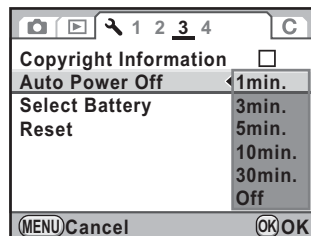

Auto Power Off function does not work in the following situations.

- The Live View is displayed
- The slideshow is played back
- The camera is connected to a computer with the USB cable

## Selecting a Battery

You can set the battery priority to the camera or the battery grip when the optional battery grip D-BG4 (p.299) is attached.

# 1

Select [Select Battery] in the [ Set-up 3] menu and press the four-way controller (▶).

The [Select Battery] screen appears.



- 2** Press the four-way controller (▶).

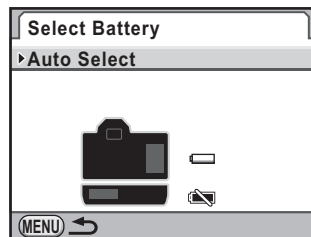

- 3** Use the four-way controller (▲ ▼) to select an item.

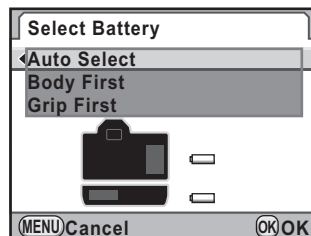

Auto Select	Priority is given to the battery with the most remaining power. (default setting)
Body First/ Grip First	Priority is given to the selected battery.

- 4** Press the OK button.

- 5** When using AA batteries in the battery grip, use the four-way controller (▲ ▼) to select [AA Battery Type] and press the four-way controller (▶).

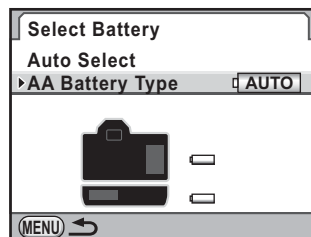

## 6 Use the four-way controller (▲▼) to select the AA battery type.

When set to [Auto-detect], the camera will detect automatically the type of battery used.

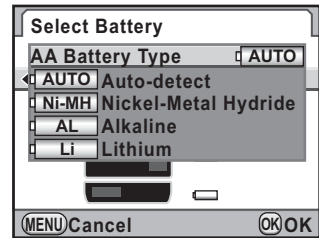

## 7 Press the OK button.

## 8 Press the MENU button twice.

The screen that was displayed before selecting the menu appears again.



- If batteries are inserted into both the body and grip, the battery levels of both are checked when the power is turned on. Regardless of the [Select Battery] setting, both batteries are slightly used.
- When the currently selected battery runs out as a result of the check, [Battery depleted] appears on the monitor. Turn the camera off and on again, and the camera will switch to the remaining battery.
- You can check the battery usage condition on the status screen and LCD panel. (p.46)



When the type of AA batteries inserted in the battery grip differs from the battery type setting in Step 6, the battery level will not be correctly determined. Please set the correct battery type. Usually, there is no problem using [Auto-detect]. However, when using batteries at low temperature, or when using batteries that were stored for long periods of time, set the appropriate battery type so the camera can correctly determine the remaining battery level.

You can order conventional photograph prints by taking the SD Memory Card with recorded images to a store for printing. DPOF (Digital Print Order Format) settings allow you to specify the number of copies and whether to imprint the date.



- DPOF settings cannot be applied to RAW images.
- You can make DPOF settings for up to 999 images.

## 1 Press the four-way controller (▼) in Playback mode.

The playback mode palette appears.

## 2 Use the four-way controller (▲▼◀▶) to select (DPOF) and press the OK button.

The screen to select how to change the settings is displayed.

## 3 Use the four-way controller (▲▼) to select [Single Image] or [All Images] and press the OK button.



## 4 When [Single Image] is selected in Step 3, use the four-way controller (◀▶) to select an image to set DPOF settings.



## 5 Use the four-way controller (▲▼) to select the number of copies.

You can print up to 99 copies.

## 6 Turn the rear e-dial (☀️) to select or for printing the date.

- : The date will be printed.
- : The date will not be printed.

Repeat Steps 4 to 6 to set other images (up to 999).



## 7 Press the OK button.

The DPOF setting for the selected image is saved and the camera returns to Playback mode.



- Depending on the printer or printing equipment at the photo processing lab, the date may not be printed on the pictures even if the DPOF setting is set to .
- The number of copies specified in settings for all images applies to all the images and the settings for single images are canceled. Before printing, check that the number is correct.



To cancel DPOF settings, set the number of copies to [00] in Step 5 and press the **OK** button.

Set the USB connection mode when connecting to a computer via the provided USB cable (I-USB7). The default setting is [MSC].

**1** Select [USB Connection] in the [**Setup 2**] menu and press the four-way controller (**▶**).

**2** Use the four-way controller (**▲ ▼**) to select [MSC] or [PTP].

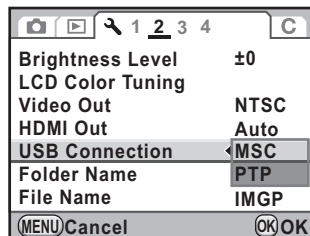

**3** Press the **OK** button.

The setting is changed.

**4** Press the **MENU** button.

The screen that was displayed before selecting the menu appears again.

## MSC and PTP

### MSC (Mass Storage Class)

A general-purpose driver program that handles devices connected to the computer via USB as a memory device. Also indicates a standard for controlling USB devices with this driver.

By simply connecting a device that supports USB Mass Storage Class, you can copy, read, and write files from a computer without installing a dedicated driver.

### PTP (Picture Transfer Protocol)

A protocol that allows transfer of digital images and control of digital cameras via USB, standardized as ISO 15740.

You can transfer image data between devices that support PTP without installing a device driver.

Unless otherwise specified, select MSC when connecting the **K-7** to your computer.

# Setting the Photographer Information Saved to Exif

The camera type, shooting conditions and other information are automatically embedded in captured images in the Exif data format. You can embed photographer information in this Exif.



Use the provided "PENTAX Digital Camera Utility 4" software to check the Exif information.

## 1 Select [Copyright Information] in the [↖ Set-up 3] menu and press the four-way controller (▶).

The [Copyright Information] screen appears.

## 2 Use the four-way controller (◀▶) to select or .

- : Embeds copyright information in the Exif.
- : Does not embed copyright information in the Exif. (default setting)

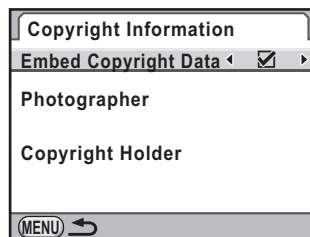

## 3 Use the four-way controller (▲▼) to select [Photographer] and press the four-way controller (▶).

The text-entry screen appears.

## 4 Enter the text.

Text selection cursor

Text input cursor

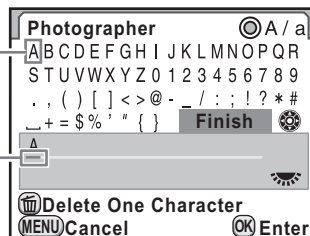

## Available operations

Rear e-dial (☀️)	Moves text input cursor.
Four-way controller (▲▼◀▶)	Moves text selection cursor.
⊙ (Green) button	Switches between upper and lower case letters.
<b>OK</b> button	Enters a character selected with the text selection cursor at the position of the text input cursor.
🗑️ button	Deletes a character at the position of the text input cursor.

### 5 After entering the text, move the text selection cursor to [Finish] and press the OK button.

The camera returns to the [Copyright Information] screen.

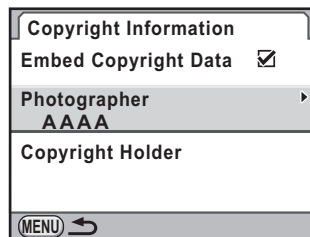

### 6 Use the four-way controller (▲▼) to select [Copyright Holder] and enter the text in the same way as [Photographer].

### 7 Press the MENU button twice.

The screen that was displayed before selecting the menu appears again.



You can set the color space to use.

sRGB	Sets to sRGB color space. (default setting)
AdobeRGB	Sets to AdobeRGB color space.

Set in [Color Space] in the [📷 Rec. Mode 4] menu (p.84).

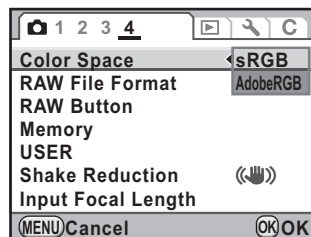

File names differ depending on the color space setting as shown below.

For sRGB : IMGpxxxx.JPG

For AdobeRGB : \_IGPxxxx.JPG

“xxxx” indicates the file number. This is displayed as a four-digit sequential number. (p.267)

## Color Space

Color ranges for various input/output devices, such as digital cameras, monitors, and printers, differ. This color range is called the Color Space.

To recreate different color spaces in different devices, standard color spaces have been proposed. This camera supports sRGB and AdobeRGB.

sRGB is mainly used for devices such as a computer.

AdobeRGB covers a wider range of color than sRGB and is used for occupational uses such as industrial printing.

An image created in AdobeRGB may appear lighter than an image created in sRGB when output from an sRGB compatible device.

# Correcting Defective Pixels in the CMOS Sensor (Pixel Mapping)

Pixel mapping is a function for mapping out and correcting for defective pixels in the CMOS sensor.

- 1 Select [Pixel Mapping] in the [↖ Set-up 4] menu and press the four-way controller (▶).**

The [Pixel Mapping] screen appears.

- 2 Press the four-way controller (▲) to select [Pixel Mapping] and press the OK button.**

Defective pixels are mapped and corrected, and the screen that was displayed before selecting the menu appears again.

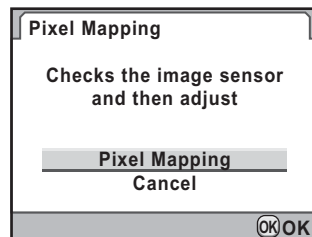

When the battery level is low, [Not enough battery power remaining to activate Pixel Mapping] is displayed on the monitor. Use the AC adapter kit K-AC50 (optional) or change the battery with ample power remaining.

# Selecting Settings to Save in the Camera (Memory)

You can select which function settings to save when the camera is turned off. The following function settings can be saved.

- Flash Mode
- Drive Mode
- White Balance
- Sensitivity
- EV Compensation
- Flash Exposure Compensation
- Extended Bracketing
- HDR Capture
- Digital Filter
- Playback Display
- File number

The default setting is  (On) for all except HDR Capture and Digital Filter.



[Memory] cannot be selected when the mode dial is set to USER.

## 1 Select [Memory] in the [📷 Rec. Mode 4] menu and press the four-way controller (▶).

The [Memory 1] screen appears.

## 2 Use the four-way controller (▲▼) to choose an item.

Turn the rear e-dial (🌀) to display the [Memory 2] screen.

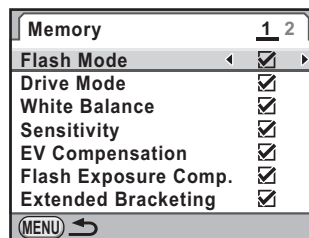

## 3 Use the four-way controller (◀▶) to select or .

- : Settings are saved even when the camera is turned off.
- : Settings are cleared and returned to their default settings when the camera is turned off.

**4****Press the MENU button twice.**

The screen that was displayed before selecting the menu appears again.



- Set [File No.] to  (On) to continue the sequential numbering for the file name even if a new folder is created. See “Selecting the File Number Setting” (p.267).
- When the [  Set-up] menu is reset (p.290), all Memory settings return to the default settings.

# 10 Appendix

---

<b>Default Settings .....</b>	<b>284</b>
<b>Functions Available with Various Lens Combinations .....</b>	<b>292</b>
<b>Cleaning the CMOS Sensor .....</b>	<b>295</b>
<b>Optional Accessories .....</b>	<b>299</b>
<b>Error Messages .....</b>	<b>305</b>
<b>Troubleshooting .....</b>	<b>307</b>
<b>Main Specifications .....</b>	<b>309</b>
<b>Glossary .....</b>	<b>314</b>
<b>Index .....</b>	<b>319</b>
<b>WARRANTY POLICY .....</b>	<b>326</b>

# Default Settings

The table below lists the factory default settings.

The functions set in Memory (p.281) are saved even when the camera is turned off.

## Reset Setting



Yes : The setting returns to the default setting with the reset function (p.290).





No : The setting is saved even after reset.

## Direct Keys

Item	Default Setting	Reset Setting	Page
Drive Mode	<input type="checkbox"/> (Single Frame Shooting)	Yes	p.143 p.136 p.138 p.148 p.141
Flash Mode	Depends on Capture mode	Yes	p.72
White Balance	<b>AWB</b> (Auto)	Yes	p.191
Custom Image	Bright	Yes	p.205

## [ Rec. Mode] Menu

Item	Default Setting	Reset Setting	Page
Exposure Mode <sup>*1</sup>	<b>P</b> (Hyper-program)	Yes	p.209
File Format	JPEG	Yes	p.188
JPEG Recorded Pixels	 (4672×3104)	Yes	p.186
JPEG Quality	★★★ (Best)	Yes	p.187
ISO AUTO Setting	Sensitivity limit	100 - 800	Yes
	AUTO ISO Parameters	 (Standard)	Yes
D-Range Setting	Highlight Correction	<input type="checkbox"/> (Off)	p.199
	Shadow Correction	Off	
Lens Correction	Distortion Correction	<input type="checkbox"/> (Off)	p.201
	Lat-Chromatic-Ab Adj	<input type="checkbox"/> (Off)	

Item		Default Setting	Reset Setting	Page
Program Line		 (Normal)	Yes	p.94
Extended Bracketing	Type	Off	Yes	p.151
	Bracketing Amount	±1	Yes	
HDR Capture		Off	Yes	p.200
Digital Filter		Not use any filters	Yes	p.153
Multi-exposure	Number of Shots	2times	Yes	p.146
	Auto EV Adjustment	<input type="checkbox"/> (Off)	Yes	
Interval Shooting	Interval	1sec.	Yes	p.144
	Number of Shots	2 images	Yes	
	Start Interval	Now	Yes	
	Start Time	12:00AM / 00:00	Yes	
Composition Adjust.	X-Y direction	Center	Yes	p.203
	Rotate	0°	Yes	
Movie	Recorded Pixels		Yes	p.160
	Quality Level	★★★ (Best)	Yes	
	Sound	<input checked="" type="checkbox"/> (On)	Yes	
	Movie Aperture Control	Fixed	Yes	
	Shake Reduction	 (Off)	Yes	
Live View	Info Overlay	<input checked="" type="checkbox"/> (On)	Yes	p.157
	Show Grid	<input type="checkbox"/> (Off)	Yes	
	Histogram	<input type="checkbox"/> (Off)	Yes	
	Bright/Dark Area	<input type="checkbox"/> (Off)	Yes	
	Autofocus Mode	 (Face Detection + Contrast AF)	Yes	
Status Screen	Status Screen	<input checked="" type="checkbox"/> (On)	Yes	p.262
	Display Color	1	Yes	
Digital Preview	Digital Preview	Off (Optical Preview)	Yes	p.129
	Histogram	<input type="checkbox"/> (Off)	Yes	
	Bright/Dark Area	<input type="checkbox"/> (Off)	Yes	
Instant Review	Display Time	1sec.	Yes	p.263
	Histogram	<input type="checkbox"/> (Off)	Yes	
	Bright/Dark Area	<input type="checkbox"/> (Off)	Yes	

Item		Default Setting	Reset Setting	Page
Electronic Level		<input type="checkbox"/> (Off)	Yes	p.266
Horizon Correction		<input type="checkbox"/> (Off)	Yes	p.133
Color Space		sRGB	Yes	p.279
RAW File Format		PEF	Yes	p.189
RAW Button	Cancel after 1 shot	<input checked="" type="checkbox"/> (On)	Yes	p.189
	JPEG/RAW/RAW+ File Format	All RAW+	Yes	
Memory		<input checked="" type="checkbox"/> (On) for all except HDR Capture and Digital Filter	Yes	p.281
USER		—	Yes* <sup>2</sup>	p.207
Shake Reduction		 (On)	Yes	p.133
Input Focal Length		35 mm	Yes	p.135

\*1 Appears only when the mode dial is set to **USER**.

\*2 The saved settings are reset only for [Reset USER Settings] in the [USER] screen.

## Playback Mode Palette

Item	Default Setting	Reset Setting	Page
Slideshow	—	Yes	p.223
Image Comparison	—	—	p.226
Digital Filter	Toy Camera	Yes* <sup>3</sup>	p.241
Resize	Maximum size according to the setting	—	p.238
Cropping	Maximum size according to the setting	—	p.239
Protect	—	No	p.231
DPOF	—	No	p.273
Index	—	—	p.219
RAW Development	File Format: JPEG Recorded Pixels: <b>14M</b> Quality Level: <b>★★★</b>	Yes	p.247
Image Rotation	—	—	p.225
Save as Manual WB	—	—	p.198

\*3 The filter parameter settings can be saved or reset.



## [▶ Playback] Menu

Item		Default Setting	Reset Setting	Page
Slideshow	Interval	3sec.	Yes	p.222
	Screen Effect	Off	Yes	
	Repeat Playback	<input type="checkbox"/> (Off)	Yes	
Playback Display Method	Bright/Dark Area	<input type="checkbox"/> (Off)	Yes	p.215
	Quick Zoom	Off	Yes	
Delete All Images		—	—	p.230

## [↶ Set-up] Menu

Item		Default Setting	Reset Setting	Page
Language/言語		According to default setting	No	p.261
Date Adjustment		According to default setting	No	p.258
World Time	Setting the Time	🏠 (Hometown)	Yes	p.258
	Destination (City)	Same as Hometown	No	
	Destination (DST)	Same as Hometown	No	
	Hometown (City)	According to default setting	No	
	Hometown (DST)	According to default setting	No	
Text Size		According to default setting	No	p.262
Guide Display		3sec.	Yes	p.262
Beep		All <input checked="" type="checkbox"/> (On)	Yes	p.257
Brightness Level		±0	Yes	p.264
LCD Color Tuning		±0	Yes	p.265
Video Out		According to default setting	No	p.234
HDMI Out		Auto	Yes	p.236
USB Connection		MSC	Yes	p.275
Folder Name		Date	Yes	p.267
File Name		IMGP/_IGP	No <sup>*4</sup>	p.268

Item		Default Setting	Reset Setting	Page
Copyright Information		<input type="checkbox"/> (Off)	No	p.277
Auto Power Off		1min.	Yes	p.270
Select Battery	Select Battery	Auto Select	Yes	p.270
	AA Battery Type	Auto-detect	Yes	
Reset		—	—	p.290
Pixel Mapping		—	—	p.280
Dust Alert		—	—	p.296
Dust Removal	Dust Removal	—	—	p.295
	Start-up Action	<input checked="" type="checkbox"/> (On)	Yes	
Sensor Cleaning		—	—	p.297
Format		—	—	p.256

\*4 Reset only for [Reset File Name] in the [File Name] screen.

## [C Custom Setting] Menu

Item		Default Setting	Reset Setting	Page
1. EV Steps		1/3 EV Steps	Yes	p.116
2. Sensitivity Steps		1 EV Step	Yes	p.90
3. Expanded Sensitivity		Off	Yes	p.90
4. Meter Operating Time		10sec.	Yes	p.114
5. AE-L with AF Locked		Off	Yes	p.126
6. Link AE to AF Point		Off	Yes	p.114
7. One-Push Bracketing		Off	Yes	p.150
8. Auto Bracketing Order		0 - +	Yes	p.148
9. Auto EV Compensation		Off	Yes	—
10. WB When Using Flash		Auto White Balance	Yes	p.192
11. WB Adjustable Range		Auto Adjustment	Yes	p.192
12. AWB in Tungsten Light		Subtle Correction	Yes	—
13. AF Button Function		Enable AF	Yes	p.120
14. AF with Press Halfway		On	Yes	—
15. Superimpose AF Area		On	Yes	p.122
16. AF with Remote Control		Off	Yes	p.140
17. Remote Control in Bulb		Mode1	Yes	p.111

Item	Default Setting	Reset Setting	Page
18. Slow Shutter Speed NR	On	Yes	p.92
19. High-ISO Noise Reduction	Medium	Yes	p.92
20. High-ISO NR Start Level	ISO 800	Yes	p.92
21. Color Temperature Steps	Kelvin	Yes	p.196
22. e-dial in Program	Front: <b>Tv</b> Rear: <b>Av</b>	Yes	p.97
23. e-dial in Sv mode	Front: - Rear: <b>ISO</b>	Yes	p.99
24. e-dial in Tv mode	Front: <b>Tv</b> Rear: -	Yes	p.101
25. e-dial in Av mode	Front: - Rear: <b>Av</b>	Yes	p.103
26. e-dial in TAv & M modes	Front: <b>Tv</b> Rear: <b>Av</b>	Yes	p.106
27. e-dial in B & X modes	Front: - Rear: <b>Av</b>	Yes	p.111
28. Green Button in TAv & M	Program Line	Yes	p.106
29. LCD Panel Illumination	On	Yes	p.33
30. Release While Charging	Off	Yes	p.77
31. Flash in Wireless Mode	On	Yes	p.177
32. AF Assist Light	On	Yes	—
33. Saving Rotation Info	On	Yes	p.225
34. Auto Image Rotation	On	Yes	p.225
35. Catch-in Focus	Off	Yes	p.128
36. AF Adjustment	Off	Yes <sup>*5</sup>	p.121
37. Using Aperture Ring	Prohibited	Yes	p.294
Reset Custom Functions	—	—	p.290

\*5 The saved adjustment value is reset only for [Reset] in the [36. AF Adjustment] screen.

## Resetting the Menu

### Resetting Rec. Mode/Playback/Set-up Menu

Settings in [📷 Rec. Mode] menu, [▶ Playback] menu, [⚙ Set-up] menu, direct keys and playback mode palette can be reset to default settings.



Language/言語, Date Adjustment, the city and DST settings for World Time, Text Size, Video Output, Copyright Information and [C Custom Setting] menu settings are not reset.



Reset function is not available when the mode dial is set to **USER**.

- 1 **Select [Reset] in the [⚙ Set-up 3] menu and press the four-way controller (▶).**

The [Reset] screen appears.

- 2 **Press the four-way controller (▲) to select [Reset] and press the OK button.**

The settings are reset, and the screen that was displayed before selecting the menu appears again.

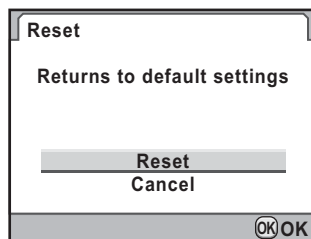

### Resetting the Custom Menu

Reset settings in [C Custom Setting] menu to default settings.

- 1 **Select [Reset Custom Functions] in the [C Custom Setting 6] menu and press the four-way controller (▶).**

The [Reset Custom Functions] screen appears.

## 2 Press the four-way controller (▲) to select [Reset] and press the OK button.

The settings are reset, and the screen that was displayed before selecting the menu appears again.

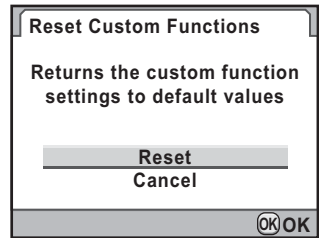

# Functions Available with Various Lens Combinations

Only DA, DA L and FA J lenses and D FA/FA/F/A lenses having an **A** (Auto) position on the aperture ring can be used with factory default settings. Refer to “Notes on [37. Using Aperture Ring]” (p.294) for other lenses and D FA/FA/F/A lenses with aperture ring set to a position other than **A**.

- ✓ : Functions are available when the aperture ring is set to the **A** position.
- # : Some functions are restricted.
- × : Functions are unavailable.

Function	Lens [Mount type]	DA DA L D FA	FA J FA <sup>*6</sup>	F <sup>*6</sup>	A	M P
		[KAF] [KAF2] [KAF3]	[KAF] [KAF2]	[KAF]	[KA]	[K]
Autofocus (Lens only) (With AF adapter 1.7×) <sup>*1</sup>		✓ –	✓ –	✓ –	– # <sup>*8</sup>	– ✓
Manual focus (With the focus indicator) <sup>*2</sup> (With matte field)		✓ ✓	✓ ✓	✓ ✓	✓ ✓	✓ ✓
Quick-Shift Focus System		# <sup>*5</sup>	×	×	×	×
Eleven AF points		✓	✓	✓	# <sup>*8</sup>	×
Multi-segment metering		✓	✓	✓	✓	×
<b>P</b> (Hyper-program) mode		✓	✓	✓	✓	# <sup>*9</sup>
<b>Sv</b> (Sensitivity Priority) mode		✓	✓	✓	✓	# <sup>*9</sup>
<b>Tv</b> (Shutter Priority) mode		✓	✓	✓	✓	# <sup>*9</sup>
<b>Av</b> (Aperture Priority) mode		✓	✓	✓	✓	# <sup>*9</sup>
<b>TAv</b> (Shutter & Aperture Priority) mode		✓	✓	✓	✓	# <sup>*9</sup>
<b>M</b> (Hyper-manual) mode		✓	✓	✓	✓	#
P-TTL Auto Flash <sup>*3</sup>		✓	✓	✓	✓	×
Power Zoom		–	✓ <sup>*7</sup>	–	–	–
Automatic obtaining the lens focal length information when using the Shake Reduction function		✓	✓	✓	×	×
Lens Correction function <sup>*4</sup>		✓	×	×	×	×

- \*1 Lenses with a maximum aperture of f/2.8 or brighter. Only available at **A** position.
- \*2 Lenses with a maximum aperture of f/5.6 or brighter.
- \*3 When using the built-in flash and AF540FGZ, AF360FGZ, AF200FG or AF160FC.
- \*4 Aberration correction is available in [Lens Correction] in the [📷 Rec. Mode 1] menu. The [Distortion Correction] setting is disabled when using the DA 10-17mm FISH-EYE lens.
- \*5 Only available with compatible lenses.
- \*6 To use an F/FA SOFT 85 mm f/2.8 lens or FA SOFT 28 mm f/2.8 lens, set [37. Using Aperture Ring] in the [C Custom Setting 6] menu to [Permitted]. Pictures can be taken with the aperture you set, but only within manual aperture range.
- \*7 Only available with KAF2 mount FA lenses.
- \*8 The AF point is fixed to  (Center).
- \*9 **Av** (Aperture Priority) Automatic Exposure with the aperture open. (Adjusting the aperture ring has no effect on the actual aperture value.)

## Lens names and mount names

DA lenses with an ultrasonic motor and FA zoom lenses with power zoom use the KAF2 mount. DA lenses with ultrasonic motor and no AF coupler use the KAF3 mount.

FA prime lenses (non-zoom lenses), DA and DA L lenses without ultrasonic motors and D FA, FA J and F lenses use the KAF mount. See the lens manual for details.

## Lenses and accessories that cannot be used with this camera

When the aperture ring is set to other than the **A** (Auto) position or a lens without an **A** position or accessories such as an auto extension tube or auto bellows are used, the camera does not operate unless [37. Using Aperture Ring] in the [C Custom Setting 6] menu is set to [Permitted]. Refer to “Notes on [37. Using Aperture Ring]” (p.294) for restriction that apply.

All camera exposure modes are available when using DA/DA L/FA J or lenses with an Aperture **A** position set to the **A** position.

## Lens and Built-in Flash

The built-in flash cannot be regulated and fully discharges when A lenses not set to the **A** (Auto) position, pre A lenses or soft focus lenses are used. Note that the built-in flash cannot be used as an Auto Flash.

## Notes on [37. Using Aperture Ring]

When [37. Using Aperture Ring] in the [C Custom Setting 6] menu is set to [Permitted], the shutter can be released even if the aperture ring of the D FA, FA, F or A lens is not set to the **A** (Auto) position or a lens without an **A** position is attached. However, the features will be restricted as shown below.

37. Using Aperture Ring	
1	Prohibited
2	Permitted
Shutter will release when aperture ring is not set to the "A" position	

### Restrictions on using lenses with aperture ring set to a position other than **A**

Lens Used	Exposure Mode	Restriction
D FA, FA, F, A, M (lens only or with auto diaphragm accessories such as auto extension tube K)	<b>Av</b> (Aperture Priority)	The aperture remains open regardless of the aperture ring position. The shutter speed changes in relation to the open aperture but an exposure error may occur. In the viewfinder, [F--] appears for the aperture indicator.
D FA, FA, F, A, M, S (with diaphragm accessories such as extension tube K)	<b>Av</b> (Aperture Priority)	Pictures can be taken with the specified aperture value but an exposure error may occur. In the viewfinder, [F--] appears for the aperture indicator.
Manual diaphragm lens such as reflex lens (lens only)	<b>Av</b> (Aperture Priority)	
FA, F SOFT 85mm FA SOFT 28mm (lens only)	<b>Av</b> (Aperture Priority)	Pictures can be taken with the specified aperture value in the manual aperture range. In the viewfinder, [F--] appears for the aperture indicator. When depth of field is checked (Optical Preview), exposure metering starts. Exposure check is possible.
All lenses	<b>M</b> (Hypermanual)	Pictures can be taken with the set aperture value and shutter speed. In the viewfinder, [F--] appears for the aperture indicator. When depth of field is checked (Optical Preview), exposure metering starts. Exposure check is possible.



The camera operates in **Av** (Aperture Priority) mode even if the mode dial is at **■**, **P**, **Sv**, **Tv** or **TAv** when the aperture is set to the position other than **A**.



Shadows may appear in the image for white backgrounds and other shooting conditions if the CMOS sensor becomes dirty or dusty. This indicates that the CMOS sensor must be cleaned.

## Removing Dust with Ultrasonic Vibrations (Dust Removal)

Dust adhering to the CMOS sensor is removed by applying ultrasonic vibrations to the filter on the front surface of the CMOS sensor for approximately one second.

- 1 Select [Dust Removal] in the [ Set-up 4] menu and press the four-way controller (▶).**

The [Dust Removal] screen appears.

- 2 Press the OK button.**

The Dust Removal function is activated. Set [Start-up Action] to  (On) to turn the Dust Removal function on every time the camera is turned on. Use the four-way controller (◀▶) to set to  (Off) if you do not want the function to be activated when the camera is turned on.

When the Dust Removal function is completed, the camera returns to the [ Set-up 4] menu.

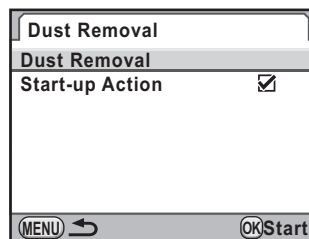

## Detecting Dust on the CMOS Sensor (Dust Alert)

Dust Alert is a function that detects dust adhering to the CMOS sensor and visually displays the location of the dust.

You can save the detected image and display it when performing sensor cleaning (p.297).

The following conditions must be met before using the Dust Alert function:

- A DA, DA L, FA J lens or a D FA, FA and F lens that has an Aperture **A** (Auto) position is attached.
- The aperture is set to the **A** position when using a lens with an aperture ring.
- Set the mode dial to any mode other than  (Movie).
- Set the focus mode lever to **A.F.S** or **C**.

### 1 Select [Dust Alert] in the [ Set-up 4] menu and press the four-way controller (▶).

The [Dust Alert] screen appears.

### 2 Fully display a white wall or uniformly bright subject in the viewfinder and press the shutter release button fully.

After image processing is performed, the [Dust Alert] screen appears.

If [The operation could not be completed correctly] is displayed, press the **OK** button and take another picture.

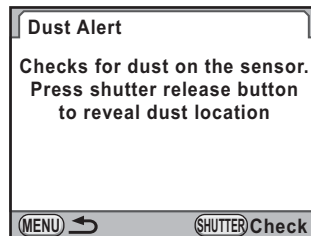

### 3 Press the OK button.

The image is saved and the camera return to the [ Set-up 4] menu.





- The exposure time may be extremely long when using the Dust Alert function. Note that if the direction of the lens is changed before processing is complete, dust will not be detected properly.
- Depending on the subject conditions or temperature, dust may not be detected properly.
- The Dust Alert image can only be displayed during sensor cleaning within 30 minutes from the time the image is saved. If 30 minutes elapse, save a new Dust Alert image and then perform sensor cleaning.
- The saved Dust Alert image cannot be displayed in Playback mode.
- Dust Alert image cannot be saved when an SD Memory Card is not inserted.



- Regardless of the camera settings, Dust Alert image will be taken with specific shooting conditions.
- Press the **INFO** button or turn the rear e-dial (  ) when displaying the Dust Alert image to view it at full screen display.

## Removing Dust with a Blower

Raise the mirror up and open the shutter to clean with a blower. Please contact PENTAX Service Center for professional cleaning because the CMOS sensor is a precision part. Cleaning services involve a fee.

You can use the optional Imagesensor Cleaning Kit O-ICK1 (p.303) when cleaning the CMOS sensor.



- Do not use a spray type blower.
- Do not clean the sensor when the mode dial is set to **B**.
- Always cap the lens mount area to prevent dirt and dust from accumulating on the CMOS sensor when no lens is on the camera.
- When the battery level is low, [Not enough battery power remaining to clean sensor] is displayed on the monitor.
- It is recommended to use the AC adapter kit K-AC50 (optional) when cleaning the sensor. If you are not using the AC adapter kit K-AC50, please use a battery with ample capacity remaining. If the battery capacity becomes low during cleaning, a warning beep will sound. Please stop cleaning immediately.
- Do not put the tip of the blower inside the lens mount area. If the power is turned off, this could cause damage to the shutter, CMOS sensor or the mirror.



- The self-timer lamp blinks and [CIn] appears on the LCD panel while cleaning the sensor.
- The camera may generate a vibration sound while cleaning the CMOS sensor. It is not a malfunction.

**1 Turn the camera off and remove the lens.**

**2 Turn the camera on.**

**3 Select [Sensor Cleaning] in the [↖ Set-up 4] menu and press the four-way controller (▶).**

The [Sensor Cleaning] screen appears.

**4 Press the four-way controller (▲) to select [Mirror Up] and press the OK button.**

The mirror is locked in the up position.

If you used the Dust Alert function to detect dust on the sensor within the last 30 minutes, the Dust Alert image appears on the monitor. It allows you to clean the sensor while checking the location of the dust.

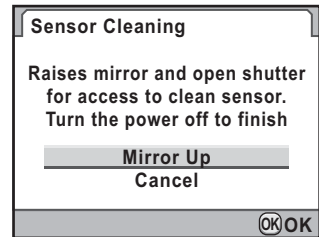

**5 Clean the CMOS sensor.**

Use a brush-less blower to remove dirt and dust from the CMOS sensor. Using a blower with a brush may scratch the CMOS sensor. Do not wipe the CMOS sensor with a cloth.

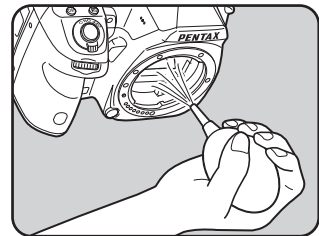

**6 Turn off the camera.**

**7 Attach the lens after the mirror returns to its original position.**

A number of dedicated accessories are available for this camera. Please contact a PENTAX Service Center for details regarding accessories. Products marked with an asterisk (\*) are the same as those supplied with the camera.

## Power Supply Accessories

### Battery Charger kit K-BC90 (\*)

(Set includes Battery charger D-BC90 and AC plug cord.)

### Rechargeable Lithium-ion Battery D-LI90 (\*)

### AC Adapter kit K-AC50

(Set includes AC Adapter D-AC50 and AC plug cord.)

Lets you power your camera with the outlet when combined with the AC plug cord.

### Battery Grip D-BG4

The Battery Grip has features such as a shutter release button, front e-dial, rear e-dial, and **AE-L** button to accommodate shooting vertically. In addition to the rechargeable lithium-ion battery D-LI90, AA lithium/Ni-MH/alkaline batteries can also be used in the battery grip to power the camera.



The AC adapter and battery charger are only sold as a set.

## Flash Accessories

### Auto Flash AF540FGZ

### Auto Flash AF360FGZ

The AF540FGZ and AF360FGZ are P-TTL auto flash units with a maximum guide number of approximately 54 and 36 (ISO 100/m), respectively. Their features include slave-sync flash, contrast-control-sync flash, auto flash, high-speed sync flash, wireless flash, slow-speed sync and trailing curtain sync flash.



AF540FGZ



AF360FGZ

### Auto Flash AF200FG

The AF200FG is a P-TTL auto flash unit with a maximum guide number of approximately 20 (ISO 100/m). It features contrast-control-sync flash and slow-speed sync flash when combined with the AF540FGZ or AF360FGZ unit.



AF200FG

### Auto Macro Flash AF160FC

The AF160FC is a flash system especially designed for macro photography to take close, shadowless pictures of small objects. It is compatible with existing TTL auto flash functions and it can be used with a wide range of PENTAX cameras by using the provided adapter ring.



AF160FC

## Hot Shoe Adapter F<sub>G</sub>

### Extension Cord F5P



Hot Shoe Adapter F<sub>G</sub>

## Off-camera Shoe Adapter F

Use the adapters and cords to use the external flash away from the camera.



Off-camera Shoe Adapter F

## Off-camera Shoe Clip CL-10

When using the AF540FGZ or AF360FGZ as a wireless flash, this large clip is used for setting the external flash on a desk or table.



Off-camera Shoe Clip CL-10

## For Viewfinder

### Magnifier Eyecup O-ME53

This viewfinder accessory is for magnifying up to approximately 1.18 times.

When the eyecup is attached to the **K-7** with a viewfinder magnification of approximately 0.92 times, the combined magnification becomes approximately 1.09 times, making manual focusing much easier.



Magnifier Eyecup O-ME53

### Magnifier F<sub>B</sub>

This viewfinder accessory is for magnifying the central area of the viewfinder 2 $\times$ .

You can see the entire view by simply flipping up the accessory from the eye-piece, as it is a hinge-type magnifier.



Magnifier F<sub>B</sub>

## Ref-converter A

This is an accessory that changes the viewfinder viewing angle at  $90^\circ$  intervals. The viewfinder magnification can be switched between  $1\times$  and  $2\times$ .



Ref-converter A

## Diopter correction lens adapter M

This accessory adjusts the diopter. Install it on the viewfinder.

If it is difficult to see the viewfinder image clearly, choose one of the eight correction of approximately  $-5$  to  $+3\text{m}^{-1}$  (per meter).



Diopter correction lens adapter M

## ME Viewfinder Cap (\*)

## Eyecup FP (\*)

## Interchangeable Focusing Screen

### AF Frame Matte MF-60 (\*)

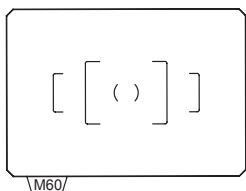

M60

### AF Divided Matte ML-60

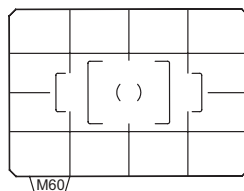

M60

### AF Scale Matte MI-60

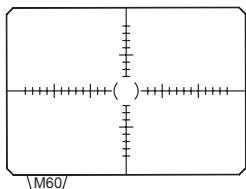

M60

### Plain Matte ME-60

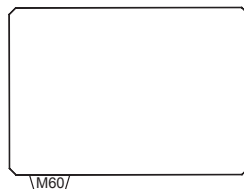

M60



## Cable Switch CS-205

Connect to the cable release terminal and operate the camera shutter release button. The cord length is 0.5 m.



## Remote Control F

Used for remote control shooting.

Operating distance for remote control  
From the front of camera: approx. 4 m  
From the back of camera: approx. 2 m



## Camera Case/Strap

Camera Case O-CC90

Camera Strap O-ST53 (\*)

## Imagesensor Cleaning Kit O-ICK1

Clean the optical parts such as the CMOS sensor and lens of this camera.



**Others**

**Body Mount Cap K**



**Hot Shoe Cover Fκ (\*)**

**USB Cable I-USB7 (\*)**

**AV cable I-AVC7 (\*)**

**Sync Socket 2P Cap (\*)**





Error Message	Description
Memory card full	The SD Memory Card is full and no more images can be saved. Insert a new SD Memory Card or delete unwanted images. (p.49, p.79) Data may be saved when you perform the following operations. <ul style="list-style-type: none"> <li>• Change the file format to [JPEG]. (p.188)</li> <li>• Change the JPEG Recorded Pixels or JPEG Quality setting. (p.186, p.187)</li> </ul>
No image	There are no images for playback on the SD Memory Card.
This image cannot be displayed	You are trying to play back an image in a format not supported by this camera. You may be able to play it back on another brand of camera or on your computer.
No card in the camera	The SD Memory Card is not inserted in the camera. (p.49)
Memory card error	The SD Memory Card has a problem, and image capture and playback are impossible. It may be viewable on a PC but not with this camera.
Card is not formatted	The SD Memory Card you have inserted is unformatted or has been formatted on other device and is not compatible with this camera. Use the card after formatting it with this camera. (p.256)
Card is locked	The write-protect switch on the SD Memory Card you have inserted is locked. Unlock the SD Memory Card. (p.50)
The card is electronically locked	Data are protected by the SD Memory Card security feature.
This image cannot be enlarged	You are trying to enlarge an image that cannot be enlarged.
This image is protected	You are trying to delete an image that is protected. Remove protection from the image. (p.231)
Battery depleted	The battery is exhausted. Install a charged battery in the camera. (p.43)
Not enough battery power remaining to clean sensor	Appears during sensor cleaning if the battery level is insufficient. Replace the battery with a fully charged one or use an AC adaptor kit K-AC50 (optional). (p.47)

Error Message	Description
Not enough battery power remaining to activate Pixel Mapping	Appears during pixel mapping if the battery level is insufficient. Replace the battery with a fully charged one or use an AC adaptor kit K-AC50 (optional). (p.47)
Image folder cannot be created	The maximum folder number (999) and file number (9999) are being used, and no more images can be saved. Insert a new SD Memory Card or format the card. (p.256)
Unable to store image	The image could not be saved because of an SD Memory Card error.
Settings not stored	The DPOF settings or rotation information could not be saved because SD Memory Card is full. Delete unwanted images and perform DPOF settings or rotation again. (p.79)
The operation could not be completed correctly	The camera was unable to measure the manual white balance or detect dust on the sensor. Try the operation again. (p.194, p.296)
No more images can be selected	You cannot select 100 or more images at a time for Index (p.219), Select & Delete (p.227) and Developing Selected Images (p.248).
This image cannot be processed	Appears when Save as Manual WB (p.198), Resize (p.238), Cropping (p.239), Digital Filter (p.241), or RAW Development (p.247) is started for images captured with other cameras, or when Resize or Cropping is started for minimum size images.
The camera failed to create an image	The creation of an index print image failed. (p.219)
Camera overheated. Disabling Live View temporarily to protect circuitry	Live View cannot be used because the camera's internal temperature is too high. Press the <b>OK</b> button and try using Live View again when the camera has cooled down.
This function is not available in the current mode	You are trying to set a function that is not available in  (Green) or  (Movie) mode.

In rare cases, the camera may not operate correctly due to static electricity. This can be remedied by taking the battery out and putting them back in again. When the mirror remains in the up position, take the battery out and put them back in again. Then, turn the power on. The mirror will retract. After these procedures are done, if the camera operates correctly, it does not require any repairs.

We recommend checking the following items before contacting a service center.

Problem	Cause	Remedy
The camera does not turn on	The battery is not installed	Check if a battery is installed. If not, install a charged battery.
	The battery power is low	Replace with charged battery or use the AC adapter kit K-AC50 (optional). (p.47)
The shutter does not release	The lens aperture ring setting is other than the <b>A</b> position	Set the lens aperture ring to the <b>A</b> position (p.95) or select [Permitted] in [37. Using Aperture Ring] in the [ <b>C</b> Custom Setting 6] menu. (p.294)
	The flash is charging	Wait until charging is finished.
	There is no available space on the SD Memory Card	Insert an SD Memory Card with available space or delete unwanted images. (p.49, p.79)
	Recording	Wait until recording is finished.
The autofocus does not work	The subject is difficult to focus on	Autofocus cannot focus well on subjects that have low contrast (the sky, white walls), dark colors, intricate designs, rapidly-moving objects or scenery shot through a window or a net-like pattern. Lock focus on another object located at the same distance as your subject, then aim at target and press the shutter release button fully. Alternatively, use manual focus. (p.126)
	The subject is not in the focusing area	Position the subject in the focus frame in the middle of the viewfinder. If the subject is outside the focusing area, aim the camera at the subject and lock the focus, then compose a picture and press the shutter release button fully. (p.124)
	The subject is too close	Move away from the subject and take a picture.

Problem	Cause	Remedy
The autofocus does not work	The focus mode is set to <b>MF</b>	Set the focus mode lever to <b>A.F.S</b> or <b>C</b> . (p.118)
	The focus mode is set to <b>A.F.C</b>	Autofocus is not locked (focus lock) when the focus mode is set to <b>A.F.C (C)</b> . The camera will continue focusing on the subject while the shutter release button is pressed halfway. If there is a subject that you wish to focus on, slide the focus mode lever to <b>A.F.S</b> and use the focus lock. (p.124)
AE lock function does not operate	AE lock is not available when set to <b>■</b> , <b>B</b> or <b>X</b> mode.	Set the exposure mode to any mode other than <b>■</b> (Green), <b>B</b> (Bulb) or <b>X</b> (Flash X-sync Speed).
The flash does not discharge	The exposure mode is set to <b>■</b> mode	Only  <sup>A</sup> (Auto Flash Discharge) and  (Auto Flash+Red-eye Reduction) are available for the flash mode when the exposure mode is <b>■</b> (Green). The flash will not discharge when the subject is bright in these modes. In the exposure modes other than <b>■</b> , only the flash mode that discharges every time the flash recharges is available. Try different exposure modes.
The USB connection with a computer does not work properly	The USB connection mode is set to [PTP]	Set [USB Connection] in the [  Set-up 2] menu to [MSC]. (p.275) Refer to the provided "Quick Guide" for details on connecting the camera to a computer.
Shake Reduction does not work	The Shake Reduction function is off	Set [Shake Reduction] in the [  Rec. Mode 4] menu to (  ) (On). (p.132)
	The Shake Reduction function is not set properly	If a lens for which focal length information cannot be obtained is used, set [Focal Length] in the [Input Focal Length] menu. (p.135)
	Shutter speed is too low for the Shake Reduction function to be effective when panning or shooting night scenes, etc.	Turn off the Shake Reduction function and use a tripod.
	The subject is too close	Move away from the subject, or turn off the Shake Reduction function and use a tripod.

Type	TTL autofocus, auto-exposure SLR digital-still camera with built-in retractable P-TTL flash
Effective Pixels	Approx. 14.6 megapixels
Image Sensor	Total pixels approx. 15.07 megapixels, CMOS with a primary color filter
Recorded Pixels	<b>14M</b> (RAW: 4672×3104 pixels), <b>14M</b> (JPEG: 4672×3104 pixels), <b>10M</b> (3936×2624 pixels), <b>6M</b> (3072×2048 pixels), <b>2M</b> (1728×1152 pixels)
Sensitivity (Standard output sensitivity)	Auto, ISO 100 to 3200 (Standard output sensitivity) (EV steps can be set to 1 EV, 1/3 EV or 1/2 EV), ISO 6400 is available with the custom function setting, up to ISO 1600 is available during <b>B</b>
File Format	RAW (PEF/DNG), JPEG (Exif 2.21), DCF 2.0 compliant, DPOF compatible, Print Image Matching III compatible, RAW+JPEG simultaneous capturing compatible, Movie: AVI
JPEG Quality	★★★★ (Premium), ★★★ (Best), ★★ (Better), and ★ (Good)
Storage Medium	SD Memory Card, SDHC Memory Card

## Approximate Number of Storable Images

Recorded Pixels	File Format/ JPEG Quality	SD Memory Card capacity					
		4 GB	2 GB	1 GB	512 MB	256 MB	128 MB
<b>14M</b> 4672×3104	<b>RAW</b> (PEF)	162	82	40	20	10	5
	<b>RAW</b> (DNG)	161	82	40	20	10	5
<b>14M</b> 4672×3104	★★★★	292	148	73	36	18	9
	★★★	467	238	117	58	29	15
	★★	826	420	206	103	52	26
	★	1630	830	408	204	102	52
<b>10M</b> 3936×2624	★★★★	409	208	102	51	25	13
	★★★	652	332	163	81	41	21
	★★	1149	585	289	144	72	37
	★	2234	1138	564	282	142	73
<b>6M</b> 3072×2048	★★★★	666	339	167	83	42	21
	★★★	1068	543	267	133	67	34
	★★	1856	945	468	234	118	60
	★	3549	1807	902	450	227	116

Recorded Pixels	File Format/ JPEG Quality	SD Memory Card capacity					
		4 GB	2 GB	1 GB	512 MB	256 MB	128 MB
2M 1728×1152	★★★★	2045	1041	516	258	130	66
	★★★	3176	1617	805	402	203	104
	★★	5485	2793	1373	686	346	177
	★	10057	5121	2518	1258	634	325

JPEG Quality (Compression): ★★★★★ (Premium) = 1/2.8, ★★★ (Best) = 1/4.5, ★★ (Better) = 1/8, ★ (Good) = 1/16

- The number of storable images may vary depending on the subject, shooting conditions, shooting mode and SD Memory Card, etc.

#### Approximate Movie Recording Time

Recorded Pixels	Quality	SD Memory Card capacity					
		4 GB	2 GB	1 GB	512 MB	256 MB	128 MB
1.6M 1536×1024	★★★	7 min. 23 sec.	3 min. 45 sec.	1 min. 51 sec.	55 sec.	28 sec.	14 sec.
	★★	10 min. 22 sec.	5 min. 16 sec.	2 min. 36 sec.	1 min. 18 sec.	39 sec.	20 sec.
	★	14 min. 40 sec.	7 min. 28 sec.	3 min. 40 sec.	1 min. 50 sec.	55 sec.	28 sec.
0.9M 1280×720	★★★	9 min. 26 sec.	4 min. 48 sec.	2 min. 21 sec.	1 min. 10 sec.	35 sec.	18 sec.
	★★	13 min. 19 sec.	6 min. 47 sec.	3 min. 20 sec.	1 min. 40 sec.	50 sec.	25 sec.
	★	18 min. 37 sec.	9 min. 29 sec.	4 min. 41 sec.	2 min. 20 sec.	1 min. 10 sec.	36 sec.
0.3M 640×416	★★★	31 min. 55 sec.	16 min. 15 sec.	7 min. 59 sec.	3 min. 59 sec.	2 min. 00 sec.	1 min. 01 sec.
	★★	44 min. 41 sec.	22 min. 45 sec.	11 min. 11 sec.	5 min. 35 sec.	2 min. 49 sec.	1 min. 26 sec.
	★	1 hr. 00 min. 57 sec.	31 min. 02 sec.	15 min. 29 sec.	7 min. 44 sec.	3 min. 54 sec.	2 min. 00 sec.

- Movie recording time is based on our measuring conditions. The above figures may vary depending on the subject, shooting conditions and SD Memory Card, etc.



White Balance Auto, Daylight, Shade, Cloudy, Fluorescent Light (D: Daylight Color, N: Daylight White, W: Cool White, L: Warm White), Tungsten Light, Flash, CTE, Manual, Color Temperature (3 types), fine tuning available

Monitor 3.0-inch wide viewing field TFT color LCD with approx. 921,000 dots, brightness and color adjustment functions



Playback Function	Single frame, multi-image display, zoom display (up to 32 times, scrolling possible), image comparison, rotating, calendar display, folder display, slideshow, histogram, bright/dark area, resize, cropping, index (Thumbnail/Square/Random1/Random2/Random3/Bubble)
Exposure Mode	<b>USER</b> , <b>■</b> Green, <b>P</b> Hyper-program, <b>Sv</b> Sensitivity priority, <b>Tv</b> Shutter priority, <b>Av</b> Aperture priority, <b>TAv</b> Shutter & Aperture priority, <b>M</b> Hyper-manual, <b>B</b> Bulb, <b>X</b> Flash X-sync Speed, <b>🎬</b> Movie
Shutter	Electronically controlled vertical-run focal-plane shutter, Speed range (1) Auto 1/8000 to 30 sec. (stepless), (2) Manual 1/8000 to 30 sec. (1/2 EV steps or 1/3 EV steps), Bulb, Electromagnetic release, Shutter lock by setting main switch in OFF position
Lens Mount	PENTAX KAF2 bayonet mount (AF coupler, lens information contacts, K-mount with power contacts)
Lens Used	PENTAX KA <sub>F3</sub> mount lenses, KAF2 mount lenses, KAF mount lenses, KA mount lenses
Autofocus System	TTL phase-matching autofocus system (SAFOX VIII+), AF operational brightness range: EV -1 to 18 (at ISO 100 with f/1.4 lens), Focus lock available, Focus Mode: <b>AFS</b> (Single)/ <b>AFC</b> (Continuous)/ <b>MF</b> , Adjustable AF point
Viewfinder	Pentaprism Finder, Interchangeable Natural-Bright-Matte III focusing screen, Field of view: approx. 100%, Magnification: approx. 0.92× (with 50 mm f/1.4 lens at ∞), Diopter: approx. -2.5m <sup>-1</sup> to +1.5m <sup>-1</sup> (per meter)
Viewfinder Indication	Focus information: <b>●</b> is lit when in-focus and blinking when unable to focus, <b>⚡</b> is lit = Built-in flash ready, <b>⚡</b> is blinking = Flash should be used or incompatible lens is being used, Shutter speed, Confirm Sensitivity, Aperture value, e-dial enabled indicator, <b>*</b> = AE lock, Remaining capacity, <b>☒</b> = EV compensation/Exposure Bracketing, <b>±</b> = Flash exposure compensation, <b>MF</b> = Manual focus, <b>(👉)</b> = Shake Reduction display, <b>📷</b> = Multi-exposure, <b>📊</b> = Metering method, <b>📍</b> = Change AF point, EV bar, Electronic Level, RAW/RAW+
LCD Panel Display	<b>⚡</b> is lit = Built-in flash ready, <b>⚡</b> is blinking = Flash should be used or incompatible lens is being used, <b>🔋</b> = Auto flash discharge, <b>👁</b> = Red-eye reduction, <b>SLOW</b> = Slow-speed sync, <b>▶</b> = Trailing Curtain Sync, <b>□</b> = Single frame shooting, <b>📷</b> = Continuous shooting, <b>🕒</b> = Self-timer, <b>📡</b> = Remote control shooting, <b>🔋</b> = Battery exhaustion warning, <b>±</b> = Flash exposure compensation, Confirm sensitivity, Shutter speed, Aperture value, Remaining capacity, <b>☒</b> = EV compensation, <b>Pc-S</b> (mass storage)/ <b>Pc-P</b> (PTP) appears when the USB cable is connected, EV bar, Electronic Level, <b>RAW</b> , <b>RAW+</b>
Preview Function	Live View: TTL method using the image sensor, Zoom Display and Show Grid are usable Optical Preview: Depth of field confirmation (electronically controlled and usable in all exposure modes) Digital Preview: Composition, exposure, focus and white balance confirmation

Continuous Shooting (Hi/Lo)	Up to approx. 5.2 fps, JPEG: up to 40 frames (Hi) / until SD Memory Card is full (Lo), RAW: up to 15 frames (PEF, Hi) / up to 14 frames (DNG, Hi)
Self-timer	Electronically controlled with delay time of 12 sec./2 sec. (with mirror lock-up function). Start by pressing the shutter release button. Operation confirmation: Possible to set beep. Can be cancelled after operation
Remote Control	PENTAX Remote Control F (optional) Release shutter immediately or three seconds after pressing the remote control shutter release button
Mirror	Quick-return mirror, mirror lock-up function
Digital Filter	Toy Camera, Retro, High Contrast, Extract Color, Soft, Star Burst, Fish-eye, Monochrome, Color, Water Color, Pastel, Slim, Miniature, HDR, Base Parameter Adj, Custom Filter
Custom Image	Image Tone (7 types), Saturation, Hue, Contrast, Sharpness/Fine Sharpness, High/Low Key Adj, Filter Effect, Toning
Exposure Bracketing	Three or five frames (underexposed, proper exposure and overexposed) are shot continuously with exposure bracketing. (Selectable between 1/3 EV and 1/2 EV for EV steps)
Extended Bracketing	Three frames are saved continuously with white balance, saturation, hue, high/low key adjustment, contrast and sharpness bracketing.
Multi-exposure	Select the number of shots between 2 and 9 (Auto EV Adjustment can be set according to the number of shots)
Exposure Meter/Exposure Range	TTL multi (77-segment metering), Exposure range from EV 0 to EV 22 at ISO 100, with 50 mm f/1.4 lens, Center-weighted and Spot metering mode can be set
EV Compensation	±5 levels, EV Steps can be selected
AE Lock	Button type (timer type: two times the meter operating time set in Custom Function) Continuous as long as the shutter button is halfway pressed.
Built-in Flash	P-TTL built-in flash with serial control, GN approx. 13 (ISO 100 • m), Angles of coverage: 18 mm lens angle of view, Flash synchronization speed range at 1/180 sec. and slower, Daylight-sync flash, Slow-speed-sync flash, ISO range = P-TTL: 100 to 6400
External Flash Sync	Hot shoe with <b>X</b> -contact, which couples with PENTAX dedicated auto flashes, ISO range = P-TTL: 100 to 1600, Automatic flash, Red-eye reduction flash function, High-speed flash sync and wireless-sync with PENTAX dedicated flash
Custom Function	37 functions can be set
Time Function	World Time settings for 75 cities (28 time zones)
Shake Reduction Function	Image Sensor Shift, effective compensation range = up to 4 EV (dependent on the used lens type and shooting conditions)
Dust Removal	Ultrasonic vibrations for dust removal. Can be set to operate when the camera is turned on.

Power	Rechargeable lithium-ion battery D-LI90, AC adapter kit K-AC50 (optional)
Battery Life (23°C)	<p>Number of recordable images: approx. 980 images (without flash)<sup>*1</sup>/ approx. 740 images (50% flash usage)<sup>*2</sup>, playback time: approx. 440 minutes<sup>*1</sup></p> <p>*1 The number of recordable images (without flash) and playback time are based on our measuring conditions. Some deviation from the above figures may occur in actual use depending on usage conditions.</p> <p>*2 The number of recordable images (50% flash usage) is based on measuring conditions in accordance with CIPA standards. Some deviation from the above figures may occur in actual use depending on usage conditions.</p>
Battery Exhaustion	Battery exhaustion indicator  is lit. (The shutter is locked and no indication appears in the viewfinder when  starts blinking.)
In/Out Port	PC/AV terminal (USB 2.0 (high speed compatible)), mini HDMI terminal, DC input terminal, Cable release terminal, Microphone terminal, X-sync socket
Video Output Format	NTSC/PAL
Dimensions and Weight	Approx. 130.5 mm (W) × 96.5 mm (H) × 72.5 mm (D) (excluding protrusions) 670 g (body only), 750 g (including a battery and an SD Memory Card)
Accessories	Hot shoe cover F <sub>K</sub> , Eyecup F <sub>R</sub> , ME viewfinder cap, Sync socket 2P cap, Body mount cover, USB Cable I-USB7, AV cable I-AVC7, Software (CD-ROM) S-SW90 (PENTAX Digital Camera Utility 4), Strap O-ST53, Rechargeable lithium-ion battery D-LI90, Battery charger D-BC90, AC plug cord, Operating Manual (this book), Quick Guide
Languages	English, French, German, Spanish, Portuguese, Italian, Dutch, Danish, Swedish, Finnish, Polish, Czech, Hungarian, Turkish, Greek, Russian, Korean, Chinese (Traditional/Simplified) and Japanese

**AdobeRGB**

Color space recommended by Adobe Systems, Inc. for commercial printing. Wider range of color reproduction than sRGB. Covers most of the color range so colors only available when printed are not lost when editing images on a computer. When image is opened by non-compatible software, the colors look lighter.

**Aperture**

The aperture increases or reduces the light beam (thickness) passing through the lens to the CMOS sensor.

**Auto Bracket**

For automatically changing exposure. When the shutter release button is pressed, three images are captured. The first one has no compensation, the second is underexposed and the third is overexposed. This camera features Exposure Bracketing that captures images in different exposures, and Extended Bracketing that captures images with set White Balance, Saturation, Hue, High/Low Key Adjustment, Contrast and Sharpness levels.

**Bright portions**

Overexposed area in the image loses contrast and appears white.

**Camera Shake (Blur)**

When the camera moves while the shutter is open, the entire image appears blurred. This occurs more often when shutter speed is low. Prevent camera shake by raising the sensitivity, using the flash, and raising the shutter speed. Alternatively, use a tripod to stabilize the camera. As camera shake is mostly likely to occur when pressing the shutter release button, use the Shake Reduction function, the self-timer or the remote control unit to prevent camera movement.

**CMOS Sensor**

Photography element which converts the light entering through the lens into electric signals that create the image.

## Color Space

A defined range of colors from the spectrum which are used. In digital cameras, [sRGB] is defined as the standard by Exif. In this camera, [AdobeRGB] is also used because of the richer color expression over sRGB.

## Color Temperature

This numerically expresses the color of the light source illuminating the subject. This is indicated in absolute temperature, using Kelvin (K) units. The color of light shifts to a bluish color as the color temperature rises, and to a reddish color as the color temperature falls.

## Dark portions

Underexposed area in the image loses contrast and appears black.

## DCF (Design rule for Camera File system)

A digital camera file system standard established by the Japan Electronics and Information Technology Industries Association (JEITA).

## Depth of Field

Area of focus. This depends on the aperture, lens focal length, and distance to the subject. For example, select a smaller aperture (higher number) to increase the depth of field or use a larger aperture (smaller number) to decrease the depth of field.

## DNG RAW file

DNG (Digital Negative) is a general-purpose RAW file format designed by Adobe Systems. When images captured in proprietary RAW formats are converted to DNG format, support and compatibility for the images increases significantly.

## DPOF (Digital Print Order Format)

Rules for writing information onto a card with recorded images regarding the specific images and number of copies to be printed. Prints can easily be made by taking images to a DPOF photo printing store.

## Dynamic Range (D-Range)

Indicated with a value expressing the light level reproducible in an image. This is the same as the term "latitude" used with silver halide film. Generally, when the dynamic range is wide, it is difficult for bright and dark areas to occur in the image, and when the dynamic range is narrow, a higher contrast image can be achieved.

## **EV (Exposure Value)**

Exposure value is determined by the combination of the aperture value and the shutter speed.

## **EV Compensation**

Process of adjusting the image brightness by changing the shutter speed and/or aperture value.

## **Exif (Exchangeable image file format for digital still camera)**

A standard digital camera file format established by the Japan Electronics and Information Technology Industries Association (JEITA).

## **Exif-JPEG format**

Exif stands for Exchangeable Image File Format. This image file format is based on the JPEG image data format, and allows thumbnail images and image properties to be embedded into the data. Software that does not support this format processes the image as a regular JPEG image.

## **Exif-TIFF format**

Exif stands for Exchangeable Image File Format. This image file format is based on the TIFF image data format, and allows thumbnail images and image properties to be embedded into the data. Software that does not support this format processes the image as a regular TIFF image.

## **Focus point**

Position in the viewfinder that determines focus. In this camera, select from Auto, Select and Center.

## **Histogram**

A graph that shows the darkest and brightest points in an image. The horizontal axis represents the brightness and the vertical axis represents the number of pixels. This is useful when you wish to refer to the exposure status of an image.

## **JPEG**

An image compression format. Although the image quality deteriorates a little, images can be compressed to a smaller file size than with TIFF and other formats. In this camera, select from ★★★★★ (Premium), ★★★ (Best), ★★ (Better), or ★ (Good). Images recorded in JPEG format are suited for viewing on your PC or for attaching to e-mail.

## **Metering Method**

Brightness of subject is measured to determine exposure. In this camera, select from Multi-segment Metering, Center-weighted Metering and Spot Metering.

## **Mired**

Proportional scale of measurement that consistently shows color change per unit. Determined by multiplying the inverse of the color temperature by 1,000,000.

## **ND (Neutral Density) Filter**

A filter with many saturation levels that adjusts the brightness without affecting the color tone of pictures.

## **Noise Reduction**

Process to reduce noise (image roughness or unevenness) caused by slow shutter speed or high sensitivity shooting.

## **NTSC/PAL**

These are video output formats. NTSC is mainly used in Japan, North America, and South Korea. PAL is mainly used in Europe and in China.

## **PNG format**

Images saved using this format can be compressed to a small file size, but the reversible compression of this format makes the file size larger than JPEG. This format is for use with full-color images and prevents quality loss even when re-edited. PNG files, however, cannot be viewed on older browsers (Internet Explorer 3.0 or earlier or Internet Explorer 4.5 on Macintosh). In addition, thumbnail images and image properties cannot be embedded in the data.

## **Quality Level**

This refers to the image compression ratio. The lower the compression, the more detailed the image. The image becomes rougher as the compression rate rises.

**RAW data**

Unedited image data output from the CMOS sensor. RAW data is data before being internally processed by the camera. Camera settings at the time of capture, such as White Balance, Contrast, Saturation, and Sharpness can be set for each frame after shooting. In addition, RAW data are 12 bit data that contain 16 times the information of 8 bit JPEG data. Rich gradations are possible. Transfer RAW data to your computer and use the provided software to create image data with different settings, such as JPEG or TIFF.

**Recorded Pixels**

Indicates the size of the image by the number of pixels. The more pixels that compose a picture, the larger the image size.

**Sensitivity**

The level of sensitivity to light. With a high sensitivity, images can be shot with a high shutter speed even in dark places, reducing camera shake. However, images with high sensitivity are more susceptible to noise.

**Shutter Speed**

The length of time that the shutter is open and light strikes the CMOS sensor. The amount of light that strikes the CMOS sensor can be changed by altering the shutter speed.

**sRGB (standard RGB)**

International standard of color space established by the IEC (International Electrotechnical Commission). This is defined from color space for computer monitors and is also used as the standard color space for Exif.

**Vignetting**

The picture edges are blackened when part of the light coming from the subject is blocked by the hood or filter ring, or when the flash is partially blocked by the lens.

**White Balance**

While shooting, color temperature is adjusted to match the light source so that the subject appears to have correct color.



## Symbols

- ⊙ (Green) button ..... 19, 21
- ⌂ (Preview) button ..... 129
- [C Custom Setting] Menu  
..... 85, 288
- (Green) mode ..... 95
- ▶ (Playback) button  
..... 19, 21, 78
- [▶ Playback] Menu .... 213, 287
- [📷 Rec. Mode] Menu .... 83, 284
- 🗑 (Delete) button ..... 21, 79
- [↶ Set-up] Menu ..... 254, 287
- ⚡ (Flash pop-up) button  
..... 18, 74
- ☑ (EV Compensation) button  
..... 18, 21, 115

## A

- AC Adapter ..... 47
- Accessories ..... 299
- Adding the Date ..... 274
- AdobeRGB ..... 279, 314
- AE Lock ..... 116, 126
- AE Metering ..... 113, 317
- AE-L** button ..... 19
- AF Adjustment ..... 121
- AF Assist Light ..... 17, 67
- AF** (Autofocus) ..... 118
- AF** button ..... 19, 120
- AF point switching dial ... 19, 122
- AF160FC ..... 173, 300
- AF200FG ..... 173, 300
- AF360FGZ ..... 173, 300
- AF540FGZ ..... 173, 300
- Aperture ..... 88, 314
- Aperture Priority Mode **Av** .... 102
- Auto Bracket ..... 148, 314

- Auto Power Off ..... 270
- AWB** (White Balance) ..... 191
- Autofocus **AF** ..... 118
- Automatic Sensitivity Correction  
..... 90
- Av** (Aperture Priority) mode  
..... 102
- AV cable ..... 233
- AV Equipment ..... 233

## B

- B** (Bulb) Mode ..... 110
- Base Parameter Adj (Digital  
Filter) ..... 242
- Battery ..... 43
- Beep ..... 257
- Bright Portion ..... 199, 314
- Brightness Adjustment ..... 199
- Brightness Level ..... 264
- Brightness level ..... 264
- Built-in Flash ..... 72
- Bulb Mode **B** ..... 110

## C

- Cable Switch ..... 111, 303
- Calendar display ..... 218
- Camera Shake ..... 314
- Capture Information ..... 23
- Card access lamp ..... 17
- Catch-in Focus ..... 128
- Center-weighted ..... 114
- City ..... 260
- Cloudy (White Balance) ..... 191
- CMOS Sensor ..... 314
- CMOS sensor plane indicator  
..... 17
- Color (Digital Filter) ..... 241
- Color of the monitor ..... 265

Color Space .....	279, 315
Color Temperature .....	196, 197, 315
Composition Adjustment .....	203
Continuous Shooting .....	143
Contrast (Custom Image) .....	205
Contrast AF .....	157
Contrast-Control-Sync (Flash) .....	182
Control panel .....	24, 35
Copyright Holder .....	277
Correct exposure .....	88
Cropping .....	239
<b>CTE</b> (White Balance) .....	191
Custom Filter (Digital Filters) .....	154, 242
Custom Image .....	205
<b>[C Custom Setting] Menu</b> .....	85, 288

## D

Dark Portion .....	199, 315
Date Adjustment .....	61
Date change .....	258
Daylight (White Balance) .....	191
Daylight-Sync shooting .....	76
DCF .....	315
Default Setting .....	284
Delete .....	79, 227
Delete All Images .....	230
 (Delete) button .....	21, 79
Delete Folder .....	228
Deleting a Single Image .....	79
Depth of field .....	89, 315
Destination .....	258
Digital Filter .....	153, 241
Digital Preview .....	131
Diopter Adjust .....	55
Direct keys .....	34, 82, 284
Display Language .....	261
Distortion .....	201

DNG .....	315
DPOF .....	315
DPOF Settings .....	273
D-Range .....	199, 315
Drive Mode .....	82
Dust Alert .....	296
Dust Removal .....	295
Dynamic Range .....	92, 199, 315

## E

Electronic Level .....	65, 266
Error Message .....	305
EV .....	316
EV Compensation .....	115, 316
 (EV Compensation) button .....	18, 21, 115
EV Steps .....	116
Exif .....	277, 316
Exposure .....	88
Exposure Bracketing .....	148
Exposure Mode .....	39, 93
Exposure Warning .....	101, 103, 109
Extended Bracketing .....	151
External flash .....	173
Extract Color (Digital Filter) .....	153, 241
Eyecup .....	55

## F

Face Detection .....	157
File Format .....	188
File Name .....	268
File number .....	267
Film plane indicator .....	17
Filter .....	153, 241
Filter Effect (Custom Image) .....	205
Fish-eye (Digital Filter) .....	153, 241
Fix Focus .....	124

- Flash ..... 72, 167
- Flash (White Balance) ..... 191
- Flash compensation ..... 76
- Flash Exposure Compensation  
..... 76
- ⚡ (Flash pop-up) button  
..... 18, 72
- Flash X-sync Speed Mode **X**  
..... 112
- Fluorescent Light (White  
Balance) ..... 191
- Focal Length ..... 135
- Focus Indicator ..... 126
- Focus Lock ..... 124
- Focus Mode ..... 118
- Focus mode lever ..... 19, 118
- Focus point ..... 122, 316
- Focusing ..... 118
- Folder display ..... 217
- Folder Name ..... 267
- Format ..... 256
- Four-way controller (▲▼◀▶)  
..... 20, 21
- Front e-dial ..... 18, 21
- G**
- Green button ..... 19, 21
- Green mode ■ ..... 95
- Guide display ..... 22, 262
- H**
- HDMI terminal ..... 235
- HDR (Digital Filter) ..... 242
- HDR Capture ..... 200
- High Contrast (Digital Filter)  
..... 153, 241
- High Dynamic Range ..... 200
- High/Low Key Adjustment  
(Custom Image) ..... 205
- High-ISO Noise Reduction ..... 92
- Highlight Correction ..... 199
- High-Speed Flash Sync Mode  
..... 175
- Histogram ..... 28, 316
- Hometown ..... 58, 258
- Horizon Correction ..... 133
- Hue (Custom Image) ..... 205
- Hyper-manual Mode **M** ..... 107
- Hyper-program Mode **P** ..... 96
- I**
- Image Comparison ..... 226
- Image Tone ..... 205
- Index ..... 219
- INFO** button ..... 19, 21, 78
- Initial settings ..... 57
- Initialize ..... 256
- Input Focal Length ..... 135
- Instant Review ..... 68, 263
- Interval Shooting ..... 144
- ISO** button ..... 18, 90
- ISO Sensitivity ..... 90, 318
- J**
- JPEG ..... 316
- JPEG Quality ..... 51, 187
- JPEG Recorded Pixels ..... 186
- K**
- Kelvin ..... 196
- L**
- Language Setting ..... 57, 261
- Lateral chromatic aberration 201
- LCD Color Tuning ..... 265
- LCD panel ..... 33
- Lens ..... 53, 292
- Lens Correction ..... 201
- Lens unlock button ..... 18, 54
- Live View ..... 156
- Lock Exposure ..... 126
- LV** button ..... 19, 158

**M**

<b>M</b> (Hyper-manual) Mode .....	107
Main switch .....	18, 21, 56
Manual focus <b>MF</b> .....	126
Manual Mode <b>M</b> .....	107
Manual White Balance .....	194
Mass Storage Class .....	276
Matte Field .....	127
Memory .....	281
Memory Card .....	49
<b>MENU</b> button .....	20, 21, 36
Menu Operation .....	36
Meter Operating Time .....	114
Metering mode switching lever .....	19, 113
<b>MF</b> (Manual focus) .....	126
Microphone .....	162
Miniature (Digital Filter) .....	242
Mired .....	196, 317
Mirror Lock-up .....	141, 298
Mode dial .....	19, 39
Mode dial lock button .....	19
Monitor .....	22
Monochrome (Digital Filter) ..	241
Movie .....	160, 163
MSC .....	276
Multi-exposure .....	146
Multi-image display .....	216
Multiple Flashes .....	181
Multi-segment .....	113



**N**

ND (Neutral Density) Filter ...	317
Noise Reduction .....	92, 317
NTSC .....	234, 317

**O**

<b>OK</b> button .....	19, 21
Operation Guide .....	30
Optical Preview .....	130
Optional Accessories .....	299

**P**

<b>P</b> (Hyper-program) Mode .....	96
PAL .....	234, 317
Pastel (Digital Filter) .....	242
PC/AV terminal .....	233
Phase Difference .....	157
Photographer Information ....	277
Picture Transfer Protocol ....	276
Pixel Mapping .....	280
Playback .....	25, 78
 (Playback) button .....	19, 21, 78
Playback Display Method ....	215
 Playback] Menu ....	213, 287
Playback Mode Palette .....	212, 286
Playback time .....	46
Playing Back Movies .....	165
PNG .....	317
Power .....	56
Press fully .....	69
Press halfway .....	69
Preview .....	129
Program Line .....	94
Program Mode <b>P</b> .....	96
Protect .....	231
PTP .....	276
P-TTL (Flash) .....	179
P-TTL Auto (Flash) .....	174

**Q**

Quality Level ..	51, 161, 187, 317
Quick Zoom .....	215

**R**

RAW .....	188, 318
<b>RAW</b> button .....	19, 189
RAW Development .....	247
RAW file format .....	189
Rear e-dial .....	19, 21
 Rec. Mode] Menu ....	83, 284

JPEG Recorded Pixels .....	51	Spot Metering .....	114
Recorded Pixels .....	51, 186, 318	sRGB .....	279, 318
Red-eye reduction .....	75, 179	Star Burst (Digital Filter) .....	153, 241
Remaining image storage capacity .....	46	Status display .....	262
Remote Control .....	138, 303	Status screen .....	23
Reset .....	290	Strap .....	42
Resize .....	238	Superimpose AF Area ....	32, 122
Retro (Digital Filter) .....	153, 241	<b>Sv</b> (Sensitivity Priority) Mode .....	98
Rotate .....	225		
<b>S</b>		<b>T</b>	
Saturation (Custom Image) ..	205	<b>TAv</b> (Shutter & Aperture Priority) Mode .....	104
Save as Manual WB .....	198	Text Size .....	58, 262
Save Settings .....	207	Toning (Custom Image) .....	205
SD Memory Card .....	49	Toy Camera (Digital Filter) .....	153, 241
Select Battery .....	270	Trailing Curtain Sync ....	170, 180
Select&Delete .....	227	Tungsten Light (White Balance) .....	191
Self-timer .....	136	TV .....	233
Sensitivity .....	90	<b>Tv</b> (Shutter Priority) mode ...	100
Sensitivity Priority Mode <b>Sv</b> .....	98		
Sensor Cleaning .....	295, 297	<b>U</b>	
[  Set-up] Menu .....	254, 287	USB Connection .....	275
Shade (White Balance) .....	191	USER .....	207
Shadow Correction .....	199	Using Aperture Ring .....	294
Shake Reduction .....	132, 162		
Sharpness (Custom Image) .....	205	<b>V</b>	
Shutter & Aperture Priority Mode <b>TAv</b> .....	104	Video jack .....	233
Shutter Priority Mode <b>Tv</b> .....	100	Video Output Format .....	234
Shutter release button	18, 21, 69	Video terminal .....	233
Shutter Speed .....	88, 318	Viewfinder .....	31, 55
Slideshow .....	222	Vignetting .....	72, 318
Slim (Digital Filter) .....	242		
Slow Shutter Speed NR .....	92	<b>W</b>	
Slow-speed Sync .....	168	Water Color (Digital Filter) ...	242
Soft (Digital Filter) .....	153, 241	White Balance .....	191, 318
Sound .....	161	Wireless Mode (Flash) .....	176
		World Time .....	258

**X**

<b>X</b> (Flash X-sync Speed) mode .....	112
X-sync socket .....	183

**Z**

Zoom Display .....	214
Zoom Lens .....	71

## Memo

All PENTAX cameras purchased through authorized bona fide photographic distribution channels are guaranteed against defects of material or workmanship for a period of twelve months from date of purchase. Service will be rendered, and defective parts will be replaced without cost to you within that period, provided the equipment does not show evidence of impact, sand or liquid damage, mishandling, tampering, battery or chemical corrosion, operation contrary to operating instructions, or modification by an unauthorized repair shop. The manufacturer or its authorized representatives shall not be liable for any repair or alterations except those made with its written consent and shall not be liable for damages from delay or loss of use or from other indirect or consequential damages of any kind, whether caused by defective material or workmanship or otherwise; and it is expressly agreed that the liability of the manufacturer or its representatives under all guarantees or warranties, whether expressed or implied, is strictly limited to the replacement of parts as hereinbefore provided. No refunds will be made on repairs by non-authorized PENTAX service facilities.

#### Procedure During 12-month Warranty Period

Any PENTAX which proves defective during the 12-month warranty period should be returned to the dealer from whom you purchased the equipment or to the manufacturer. If there are no representatives of the manufacturer in your country, send the equipment to the manufacturer, with postage prepaid. In this case, it will take a considerable length of time before the equipment can be returned to you owing to the complicated customs procedures required. If the equipment is covered by warranty, repairs will be made and parts replaced free of charge, and the equipment will be returned to you upon completion of servicing. If the equipment is not covered by warranty, regular charges of the manufacturer or of its representatives will apply. Shipping charges are to be borne by the owner. If your PENTAX was purchased outside of the country where you wish to have it serviced during the warranty period, regular handling and servicing fees may be charged by the manufacturer's representatives in that country. Notwithstanding this, your PENTAX returned to the manufacturer will be serviced free of charge according to this procedure and warranty policy. In any case, however, shipping charges and customs clearance fees to be borne by the sender. To prove the date of your purchase when



required, please keep the receipt or bills covering the purchase of your equipment for at least a year. Before sending your equipment for servicing, please make sure that you are sending it to the manufacturer's authorized representatives or their approved repair shops, unless you are sending it directly to the manufacturer. Always obtain a quotation for the service charge, and only after you accept the quoted service charge, instruct the service station to proceed with the servicing.

- **This warranty policy does not affect the customer's statutory rights.**
- **The local warranty policies available from PENTAX distributors in some countries can supersede this warranty policy. Therefore, we recommend that you review the warranty card supplied with your product at the time of purchase, or contact the PENTAX distributor in your country for more information and to receive a copy of the warranty policy.**



The CE Mark is a Directive conformity mark of the European Union.

## For customers in USA

### STATEMENT OF FCC COMPLIANCE

This device complies with Part 15 of the FCC Rules. Operation is subject to the following two conditions: (1) This device may not cause harmful interference, and (2) this device must accept any interference received, including interference that may cause undesired operation.

Changes or modifications not approved by the party responsible for compliance could void the user's authority to operate the equipment.

This equipment has been tested and found to comply with the limits for a Class B digital device, pursuant to part 15 of the FCC Rules.

These limits are designed to provide reasonable protection against harmful interference in a residential installation. This equipment generates, uses and can radiate radio frequency energy and, if not installed and used in accordance with the instructions, may cause harmful interference to radio communications. However, there is no guarantee that interference will not occur in a particular installation.

If this equipment does cause harmful interference to radio or television reception, which can be determined by turning the equipment off and on, the user is encouraged to try to correct the interference by one or more of the following measures:

- Reorient or relocate the receiving antenna.
  - Increase the separation between the equipment and receiver.
  - Connect the equipment into an outlet on a circuit different from that to which the receiver is connected.
- \* Consult the dealer or an experienced radio/TV technician for help.

## For customers in Canada

This Class B digital apparatus complies with Canadian ICES-003.

### Pour les utilisateurs au Canada

Cet appareil numérique de la classe B est conforme à la norme NMB-003 du Canada.

### FOR CALIFORNIA, U.S.A. ONLY

Perchlorate Material-special handling may apply.

The lithium battery used in this camera contains perchlorate material, which may require special handling.

See [www.dtsc.ca.gov/hazardouswaste/perchlorate](http://www.dtsc.ca.gov/hazardouswaste/perchlorate)

# Declaration of Conformity

According to 47CFR, Parts 2 and 15 for  
Class B Personal Computers and Peripherals

We: PENTAX Imaging Company  
A Division of PENTAX of America, Inc.

Located at: 600 12<sup>th</sup> Street, Suite 300  
Golden, Colorado 80401 U.S.A.  
Phone: 303-799-8000 FAX: 303-790-1131

Declare under sole responsibility that the product identified herein complies with 47CFR Parts 2 and 15 of the FCC rules as a Class B digital device. Each product marketed is identical to the representative unit tested and found to be compliant with the standards. Records maintained continue to reflect the equipment being produced can be expected to be within the variation accepted, due to quantity production and testing on the statistical basis as required by 47CFR §2.909. Operation is subject to the following two conditions: (1) This device may not cause harmful interference, and (2) This device must accept any interference received, including interference that may cause undesired operation. The above named party is responsible for ensuring that the equipment complies with the standards of 47CFR §15.101 to §15.109.

Product Name: PENTAX Digital Still Camera

Model Number: **K-7**

Contact person: Customer Service Manager

Date and Place: May, 2009, Colorado

## Information for Users on Collection and Disposal of Old Equipment and Used Batteries



### 1. In the European Union

These symbols on the products, packaging and/or accompanying documents mean that used electrical and electronic equipments and batteries should not be mixed with general household waste.

Used electrical/electronic equipments and batteries must be treated separately and in accordance with legislation that requires proper treatment, recovery and recycling of these products.

Following the implementation by member states, private households within the EU states may return their used electrical/electronic equipments and batteries to designated collection facilities free of charge\*.

In some countries your local retailer may also take back your old product free of charge if you purchase a similar new one.

\*Please contact your local authority for further details.



By disposing of this product correctly you will help ensure that the waste undergoes the necessary treatment, recovery and recycling and thus prevent potential negative effects on the environment and human health which could otherwise arise due to inappropriate waste handling.

### 2. In other countries outside the EU

These symbols are only valid in the European Union. If you wish to discard these items, please contact your local authorities or dealer and ask for the correct method of disposal.



For Switzerland: Used electrical/electronic equipment can be returned free of charge to the dealer, even when you don't purchase a new product. Further collection facilities are listed on the home page of [www.swico.ch](http://www.swico.ch) or [www.sens.ch](http://www.sens.ch).

Note for the battery symbol (bottom two symbol examples):

This symbol might be used in combination with a designation for the chemical element or compound in use. In this case you have to comply with the requirement set by the Directive for the chemicals involved.

# Memo

# Memo

# Memo

**HOYA CORPORATION**

**PENTAX Imaging Systems Division**

2-36-9, Maeno-cho, Itabashi-ku, Tokyo 174-8639, JAPAN  
(<http://www.pentax.jp>)

**PENTAX Europe GmbH  
(European Headquarters)**

Julius-Vosseler-Strasse 104, 22527 Hamburg, GERMANY  
(HQ - <http://www.pentaxeurope.com>)  
(Germany - <http://www.pentax.de>)

**PENTAX U.K. Limited**

PENTAX House, Heron Drive, Langley, Slough, Berks  
SL3 8PN, U.K.  
(<http://www.pentax.co.uk>)

**PENTAX France S.A.S.**

112 Quai de Bezons, B.P. 204, 95106 Argenteuil Cedex,  
FRANCE  
(<http://www.pentax.fr>)

**PENTAX (Schweiz) AG**

Widenholzstrasse 1, 8304 Wallisellen, Postfach 367,  
8305 Dietlikon, SWITZERLAND  
(<http://www.pentax.ch>)

**PENTAX Imaging Company**

**A Division of PENTAX of America, Inc.**

(Headquarters)  
600 12th Street, Suite 300 Golden, Colorado 80401, U.S.A.  
(PENTAX Service Department)  
12061 Tejon St. STE 600 Westminster, Colorado 80234,  
U.S.A. (<http://www.pentaximaging.com>)

**PENTAX Canada Inc.**

1770 Argentia Road Mississauga, Ontario L5N 3S7,  
CANADA (<http://www.pentax.ca>)

**PENTAX Trading  
(SHANGHAI) Limited**

23D, Jun Yao International Plaza, 789 Zhaoyiabang Road,  
Xu Hui District, Shanghai, 200032 CHINA  
(<http://www.pentax.com.cn>)

<http://www.pentax.jp/english>

- Specifications and external dimensions are subject to change without notice.



## Free Manuals Download Website

<http://myh66.com>

<http://usermanuals.us>

<http://www.somanuals.com>

<http://www.4manuals.cc>

<http://www.manual-lib.com>

<http://www.404manual.com>

<http://www.luxmanual.com>

<http://aubethermostatmanual.com>

Golf course search by state

<http://golfingnear.com>

Email search by domain

<http://emailbydomain.com>

Auto manuals search

<http://auto.somanuals.com>

TV manuals search

<http://tv.somanuals.com>