

Installation and Operating Guide

Model Number | Z42PQ20 | PLASMA TV



To view the extended version of owner's manual that contains the advanced features of this TV set, visit our website at <http://www.zenithservice.com>



This product qualifies for ENERGY STAR in the "factory default (Home mode)" setting.

Changing the factory default picture setting or enabling other features will increase power consumption that could exceed the limits necessary to qualify for Energy Star rating.



© Copyright 2009, LG Electronics USA, Inc.



WARNING / CAUTION



TO REDUCE THE RISK OF ELECTRIC SHOCK DO NOT REMOVE COVER (OR BACK). NO USER SERVICEABLE PARTS INSIDE. REFER TO QUALIFIED SERVICE PERSONNEL.

 The lightning flash with arrowhead symbol, within an equilateral triangle, is intended to alert the user to the presence of uninsulated "dangerous voltage" within the product's enclosure that may be of sufficient magnitude to constitute a risk of electric shock to persons.

 The exclamation point within an equilateral triangle is intended to alert the user to the presence of important operating and maintenance (servicing) instructions in the literature accompanying the appliance.

WARNING/CAUTION

TO REDUCE THE RISK OF FIRE AND ELECTRIC SHOCK, DO NOT EXPOSE THIS PRODUCT TO RAIN OR MOISTURE.

NOTE TO CABLE/TV INSTALLER

This reminder is provided to call the CATV system installer's attention to Article 820-40 of the National Electric Code (U.S.A.). The code provides guidelines for proper grounding and, in particular, specifies that the cable ground shall be connected to the grounding system of the building, as close to the point of the cable entry as practical.

WARNING / CAUTION

To prevent fire or shock hazards, do not expose this product to rain or moisture.

FCC NOTICE

Class B digital device

This equipment has been tested and found to comply with the limits for a Class B digital device, pursuant to Part 15 of the FCC Rules. These limits are designed to provide reasonable protection against harmful interference in a residential installation. This equipment generates, uses and can radiate radio frequency energy and, if not installed and used in accordance with the instructions, may cause harmful interference to radio communications. However, there is no guarantee that interference will not occur in a particular installation. If this equipment does cause harmful interference to radio or television reception, which can be determined by turning the equipment off and on, the user is encouraged to try to correct the interference by one or more of the following measures:

- Reorient or relocate the receiving antenna.
- Increase the separation between the equipment and receiver.
- Connect the equipment to an outlet on a circuit different from that to which the receiver is connected.
- Consult the dealer or an experienced radio/TV technician for help.

This device complies with part 15 of the FCC Rules. Operation is subject to the following two conditions: (1) This device may not cause (harmful) interference, and (2) this device must accept any interference received, including interference that may cause undesired operation (of the device).

Any changes or modifications not expressly approved by the party responsible for compliance could void the user's authority to operate the equipment.

CAUTION

Do not attempt to modify this product in any way without written authorization from LG Electronics. Unauthorized modification could void the user's authority to operate this product

IMPORTANT INFORMATION TO PREVENT "IMAGE BURN / BURN-IN" ON YOUR TV SCREEN

- When a fixed image (e.g. logos, screen menus, video game, and computer display) is displayed on the TV for an extended period, it can become permanently imprinted on the screen. This phenomenon is known as "image burn" or "burn-in." Image burn is not covered under the manufacturer's warranty.
- In order to prevent image burn, avoid displaying a fixed image on your TV screen for a prolonged period (2 or more hours for LCD, 1 or more hours for Plasma).
- Image burn can also occur on the letterboxed areas of your TV if you use the 4:3 aspect ratio setting for an extended period.



SAFETY INSTRUCTIONS

IMPORTANT SAFETY INSTRUCTIONS

Read these instructions.
Keep these instructions.
Heed all warnings.
Follow all instructions.



- 1 Do not use this apparatus near water.



- 2 Clean only with dry cloth.



- 3 Do not block any ventilation openings. Install in accordance with the manufacturer's instructions.



- 4 Do not install near any heat sources such as radiators, heat registers, stoves, or other apparatus (including amplifiers) that produce heat.



- 5 Do not defeat the safety purpose of the polarized or grounding-type plug. A polarized plug has two blades with one wider than the other. A grounding type plug has two blades and a third grounding prong. The wide blade or the third prong are provided for your safety. If the provided plug does not fit into your outlet, consult an electrician for replacement of the obsolete outlet.



- 6 Protect the power cord from being walked on or pinched particularly at plugs, convenience receptacles, and the point where they exit from the apparatus.



- 7 Only use attachments/accessories specified by the manufacturer.



- 8 Use only with the cart, stand, tripod, bracket, or table specified by the manufacturer, or sold with the apparatus. When a cart is used, use caution when moving the cart/apparatus combination to avoid injury from tip-over.



- 9 Unplug this apparatus during lighting storms or when unused for long periods of time.

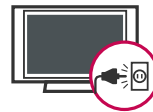

- 10 Refer all servicing to qualified service personnel. Servicing is required when the apparatus has been damaged in any way, such as power-supply cord or plug is damaged, liquid has been spilled or objects have fallen into the apparatus, the apparatus has been exposed to rain or moisture, does not operate normally, or has been dropped.

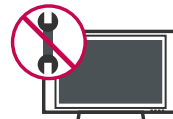

- 11 Never touch this apparatus or antenna during a thunder or lightning storm.

- 12 When mounting a TV on the wall, make sure not to install the TV by the hanging power and signal cables on the back of the TV.

- 13 Do not allow an impact shock or any objects to fall into the product, and do not drop onto the screen with something.

- 14 CAUTION concerning the Power Cord:
It is recommend that appliances be placed upon a dedicated circuit; that is, a single outlet circuit which powers only that appliance and has no additional outlets or branch circuits. Check the specification page of this owner's manual to be certain.
Do not connect too many appliances to the same AC power outlet as this could result in fire or electric shock.

SAFETY INSTRUCTIONS

Do not overload wall outlets. Overloaded wall outlets, loose or damaged wall outlets, extension cords, frayed power cords, or damaged or cracked wire insulation are dangerous. Any of these conditions could result in electric shock or fire. Periodically examine the cord of your appliance, and if its appearance indicates damage or deterioration, unplug it, discontinue use of the appliance, and have the cord replaced with an exact replacement part by an authorized servicer. Protect the power cord from physical or mechanical abuse, such as being twisted, kinked, pinched, closed in a door, or walked upon. Pay particular attention to plugs, wall outlets, and the point where the cord exits the appliance.

Do not make the TV with the power cord plugged in. Do not use a damaged or loose power cord. Be sure do grasp the plug when unplugging the power cord. Do not pull on the power cord to unplug the TV.

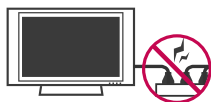

- 15** **WARNING** - To reduce the risk of fire or electrical shock, do not expose this product to rain, moisture or other liquids. Do not touch the TV with wet hands. Do not install this product near flammable objects such as gasoline or candles or expose the TV to direct air conditioning.



- 16** Do not expose to dripping or splashing and do not place objects filled with liquids, such as vases, cups, etc. on or over the apparatus (e.g. on shelves above the unit).



- 17** **GROUNDING**
Ensure that you connect the earth ground wire to prevent possible electric shock (i.e. a TV with a three-prong grounded AC plug must be connected to a three-prong grounded AC outlet). If grounding methods are not possible, have a qualified electrician install a separate circuit breaker.

Do not try to ground the unit by connecting it to telephone wires, lightning rods, or gas pipes.

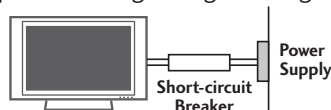

- 18** **DISCONNECTING DEVICE FROM MAINS**
Mains plug is the disconnecting device. The plug must remain readily operable.

- 19** As long as this unit is connected to the AC wall outlet, it is not disconnected from the AC power source even if you turn off this unit by SWITCH. (Some models)

20 ANTENNAS **Outdoor antenna grounding**

If an outdoor antenna is installed, follow the precautions below. An outdoor antenna system should not be located in the vicinity of overhead power lines or other electric light or power circuits, or where it can come in contact with such power lines or circuits as death or serious injury can occur.

Be sure the antenna system is grounded so as to provide some protection against voltage surges and built-up static charges.

Section 810 of the National Electrical Code (NEC) in the U.S.A. provides information with respect to proper grounding of the mast and supporting structure, grounding of the lead-in wire to an antenna discharge unit, size of grounding conductors, location of antenna discharge unit, connection to grounding electrodes and requirements for the grounding electrode.

Antenna grounding according to the National Electrical Code, ANSI/NFPA 70

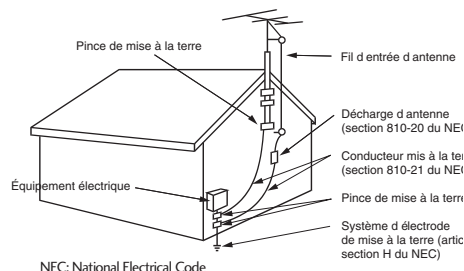

- 21** **Cleaning**
When cleaning, unplug the power cord and scrub gently with a soft cloth to prevent scratching. Do not spray water or other liquids directly on the TV as electric shock may occur. Do not clean with chemicals such as alcohol, thinners or benzene.

- 22** **Moving**
Make sure the product is turned off, unplugged and all cables have been removed. It may take 2 or more people to carry larger TVs. Do not press against or put stress on the front panel of the TV.

- 23** **Ventilation**
Install your TV where there is proper ventilation. Do not install in a confined space such as a bookcase. Do not cover the product with cloth or other materials (e.g.) plastic while plugged in. Do not install in excessively dusty places.

- 24** If you smell smoke or other odors coming from the TV or hear strange sounds, unplug the power cord contact an authorized service center.

- 25** Do not press strongly upon the panel with hand or sharp object such as nail, pencil or pen, or make a scratch on it.

- 26** Keep the product away from direct sunlight.

CONTENTS

WARNING / CAUTION 2

SAFETY INSTRUCTIONS 3

PREPARATION

To view the extended version of owner's manual ... 5

Accessories 6

Front Panel Information 7

Back Panel Information 8

Stand Instruction 9

Desktop Pedestal Installation 10

Swivel Stand 10

Cable Arrangement 10

Remote Control Functions 11

VESA Wall Mounting 12

Securing the TV to the wall to prevent falling

When the TV is used on a stand 13

Antenna or Cable Connection 14

EXTERNAL EQUIPMENT SETUP

HD Receiver Setup 15

DVD Setup 16

VCR Setup 17

WATCHING TV

Turning On the TV 18

Channel Selection 18

Volume Adjustment 18

Channel Setup 19

Favorite channel setup 20

Favorite channel list 20

Initial Setting 21

Quick Menu 22

On-Screen Menus Selection 22

APPENDIX

Troubleshooting 25

Maintenance 27

Product Specifications 28

Child Safety 30

TO VIEW THE EXTENDED VERSION OF OWNER'S MANUAL

To view the extended version of owner's manual that contains the advanced features of these TV sets, visit our website at <http://www.zenithservice.com>

Connect at <http://www.zenithservice.com> → Select Owner's Manual → Enter the all part of your model number → Press Search

FEATURES OF THIS TV



SRS is a trademark of SRS Labs, Inc.
TruSurround XT technology is incorporated under license from SRS Labs, Inc.



Manufactured under license from Dolby Laboratories.
"Dolby" and the double-D symbol are trademarks of Dolby Laboratories.



High-definition television. High-resolution digital television broadcast and playback system composed of roughly a million or more pixels, 16:9 aspect-ratio screens, and AC3 digital audio. A subset of digital television, HDTV formats include 1080i and 720p resolutions.



HDMI, the HDMI logo and High-Definition Multimedia Interface are trademarks or registered trademarks of HDMI Licensing LLC."

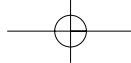

PREPARATION

ACCESSORIES

Ensure that the following accessories are included with your TV. If an accessory is missing, please contact the dealer where you purchased the product.

The accessories included may differ from the images below.

PREPARATION

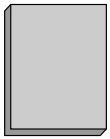

Owner's Manual

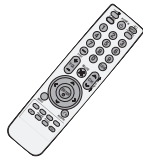

Remote Control



Batteries

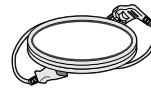

Power Cord

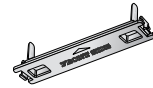

Protection Cover
(Refer to p. 9)

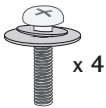

x 4

Bolts for stand assembly
(Refer to p. 9)



x 2

Cable Holder
(Refer to p.10)



Polishing Cloth

- * Wipe spots on the exterior only with the polishing cloth.
- * Do not wipe roughly when removing stain. Excessive pressure may cause scratch or discoloration.

Option Extras

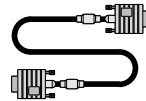

D-sub 15 pin Cable

When using the VGA (D-sub 15 pin cable) PC connection, the user must use shielded signal interface cables with ferrite cores to maintain standards compliance.



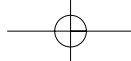

FRONT PANEL INFORMATION

- Image shown may differ from your TV.

⚠ CAUTION

- When the TV cannot be turned on with the remote control, press the O/I (power) button on the TV. (The remote control will not work when the O/I (power) button on the TV is switched off.)

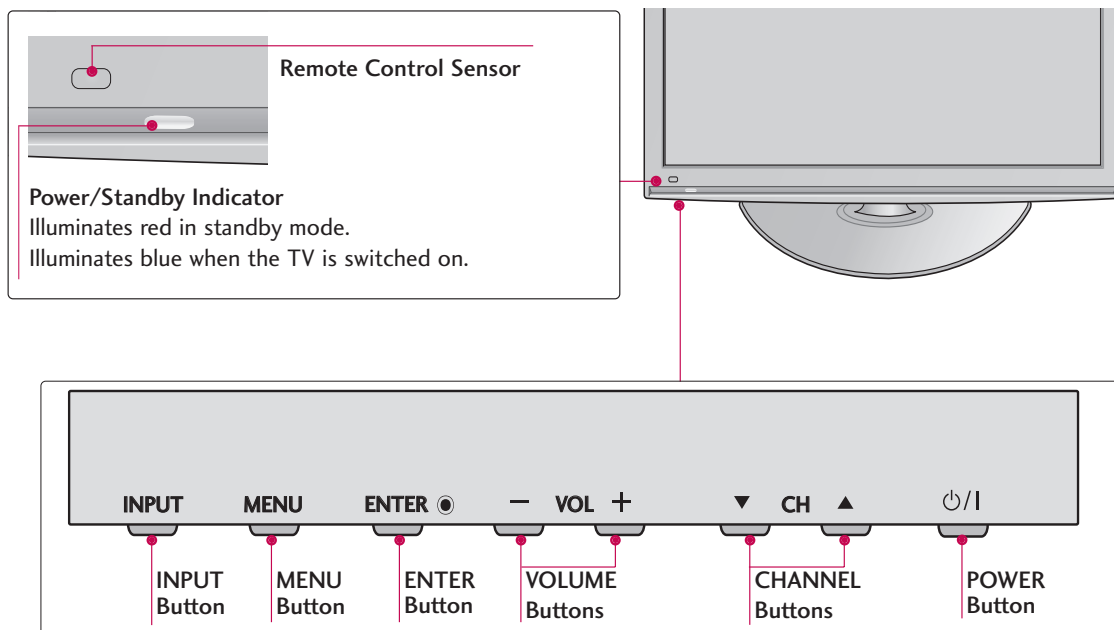

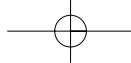

PREPARATION

BACK PANEL INFORMATION

PREPARATION

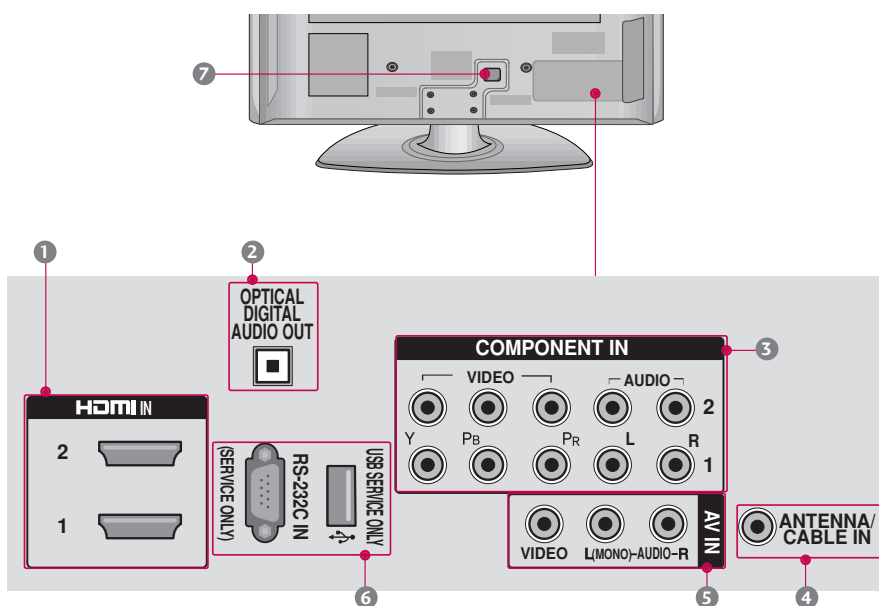

1 HDMI IN, HDMI/DVI IN

Digital Connection. Supports HD video and Digital audio. Doesn't support 480i.

Accepts DVI video using an adapter or HDMI to DVI cable (not included).

2 OPTICAL DIGITAL AUDIO OUT

Optical digital audio output for use with amps and home theater systems.

Note: In standby mode, this port doesn't work.

3 COMPONENT IN

Analog Connection. Supports HD.

Uses a red, green, and blue cable for video & red and white for audio.

4 ANTENNA/CABLE IN

Connect over-the air signals to this jack.

Connect cable signals to this jack.

5 AV (Audio/Video) IN

Analog composite connection. Supports standard definition video only (480i).

6 USB SERVICE ONLY, RS-232C IN (SERVICE ONLY)

Used for software updates.

7 Power Cord Socket

For operation with AC power.

Caution: Never attempt to operate the TV on DC power.



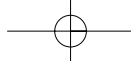

STAND INSTRUCTION

■ Image shown may differ from your TV.

Installation

- 1 Carefully place the TV screen side down on a cushioned surface to protect the screen from damage.

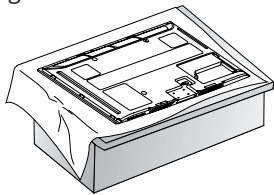

- 2 Assemble the TV as shown.

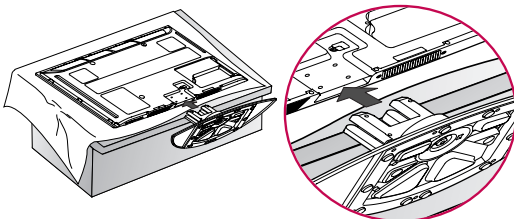

- 3 Install the 4 screws securely using the holes in the back of the TV.

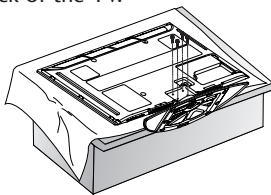

NOTE

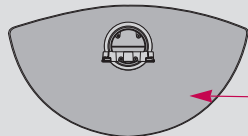

- ▶ When assembling the stand, make sure to distinguish and assemble the front and rear side of the stand correctly.
- ▶ When assembling the desk type stand, check whether the screw is fully tightened. (If not tightened fully, the product can tilt forward after the product installation). If you tighten the screw with excessive force, the screw can deviate from abrasion of the tightening part of the screw.

Detachment

- 1 Carefully place the TV screen side down on a cushioned surface to protect the screen from damage.

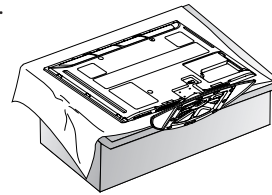

- 2 Loosen the screws from the TV.

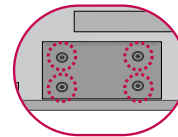
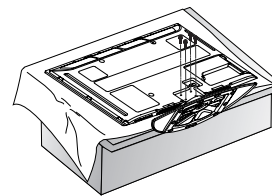

- 3 Detach the stand from the TV.

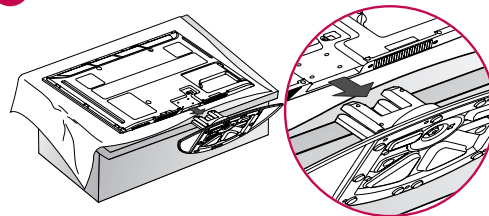

Protection Cover

After removing the stand, install the included **protection cover** over the hole for the stand. Press the **PROTECTION COVER** into the TV until you hear it click.

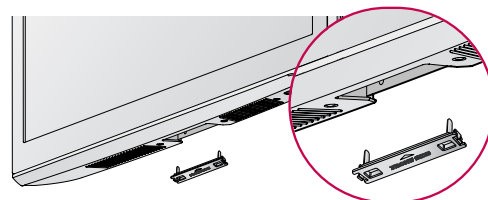

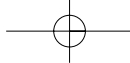

PREPARATION

DESKTOP PEDESTAL INSTALLATION

- Image shown may differ from your TV.

For proper ventilation, allow a clearance of 4 inches on all four sides from the wall.

PREPARATION

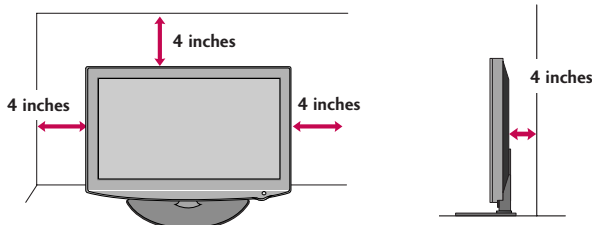

- CAUTION**
- Ensure adequate ventilation by following the clearance recommendations.
 - Do not mount near or above any type of heat source.

SWIVEL STAND

After installing the TV, you can adjust the TV set manually to the left or right direction by 20 degrees to suit your viewing position.

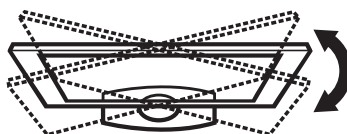

CABLE ARRANGEMENT

- Image shown may differ from your TV.

After connecting the cables as necessary, install **CABLE HOLDER** as shown and bundle the cables.

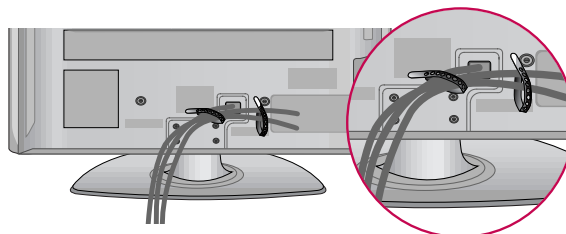

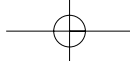

REMOTE CONTROL FUNCTIONS

When using the remote control, aim it at the remote control sensor on the TV.

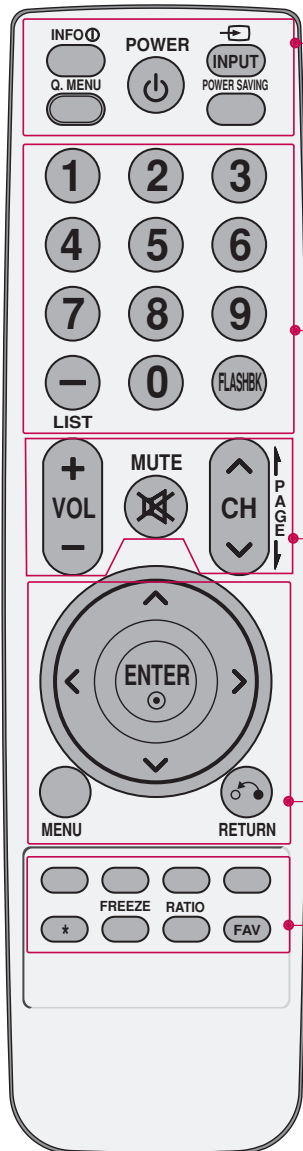

INFO Displays channel information at the top of the screen.

Q.MENU Opens the list of Quick Menu options.

POWER Turns the TV on from standby or off to standby.

INPUT Rotates through inputs.
Also switches the TV on from standby.

POWER SAVING Adjusts the Power Saving level.

NUMBER button

— (DASH) Used to enter a program number for multiple program channels such as 2-1, 2-2, etc.

LIST Displays the channel list.

FLASHBK Tunes to the last channel viewed.

VOLUME UP /DOWN Adjusts the volume.

MUTE Switch the sound on or off.

CHANNEL UP/DOWN Changes the channel.

PAGE UP/DOWN Moves from one full set of screen information to the next one.

THUMBSTICK (Up/Down/Left Right/ENTER) Navigates the on-screen menus and adjusts the system settings to your preference.

MENU Displays the main menu or clears all on-screen displays and returns to TV viewing.

RETURN Allows the user to move return one step in an interactive application or other user interaction function.

Color button Blue button have channel edit and channel block function. The other has no function.

* Not functional.

FREEZE Freezes the current frame.

RATIO Changes the aspect ratio of the video.

FAV Scroll through the programmed Favorite channels.

Installing Batteries

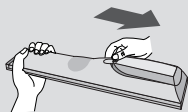

■ Open the battery compartment cover on the back side and install the batteries matching correct polarity.

■ Install two 1.5V AAA batteries. Don't mix old or used batteries with new ones.

■ Close cover.



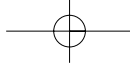

PREPARATION

VESA WALL MOUNTING

Install your wall mount on a solid wall perpendicular to the floor. When attaching to other building materials, please contact your nearest installer.

If installed on a ceiling or slanted wall, it may fall and result in severe personal injury. Zenith recommends that wall mounting be performed by a qualified professional installer.

PREPARATION

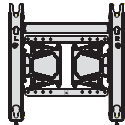
VESA (A * B)	Standard Screw	Quantity	Wall Mounting bracket (sold separately)
 400 * 400	M6	4	 AW-50PG60MS

NOTE

- ▶ Screw length needed depends on the wall mount used. For further information, refer to the instructions included with the mount.
- ▶ Standard dimensions for wall mount kits are shown in the table.
- ▶ When purchasing our wall mount kit, a detailed installation manual and all parts necessary for assembly are provided.
- ▶ Do not use screws longer than the standard dimension, as they may cause damage to the inside to the TV.
- ▶ For wall mounts that do not comply with the VESA standard screw specifications, the length of the screws may differ depending on their specifications.
- ▶ Do not use screws that do not comply with the VESA standard screw specifications. Do not use fasten the screws too strongly, this may damage the TV or cause the TV to a fall, leading to personal injury. Zenith is not liable for these kinds of accidents.
- ▶ Zenith is not liable for TV damage or personal injury when a non-VESA or non specified wall mount is used or the consumer fails to follow the TV installation instructions.

CAUTION

- ▶ Do not install your wall mount kit while your TV is turned on. It may result in personal injury due to electric shock.



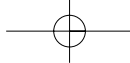

SECURING THE TV TO THE WALL TO PREVENT FALLING WHEN THE TV IS USED ON A STAND

- You should purchase necessary components to prevent the TV from tipping over (when not using a wall mount).
- Image shown may differ from your TV.

We recommend that you set up the TV close to a wall so it cannot fall over if pushed backwards. Additionally, we recommend that the TV be attached to a wall so it cannot be pulled in a forward direction, potentially causing injury or damaging the product.

Caution: Please make sure that children don't climb on or hang from the TV.

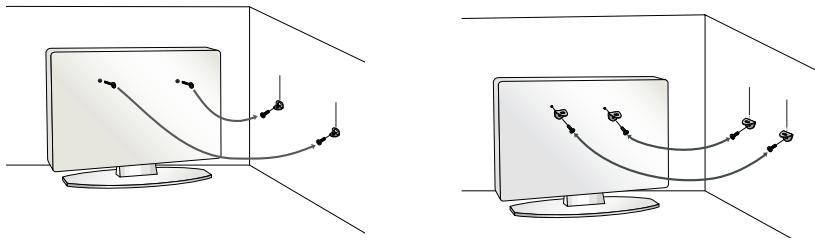

- Insert the eye-bolts (or TV brackets and bolts) to tighten the product to the wall as shown in the picture.
 - * If your product has the bolts in the eye-bolts position before inserting the eye-bolts, loosen the bolts.
 - * Insert the eye-bolts or TV brackets/bolts and tighten them securely in the upper holes.
 Secure the wall brackets with the bolts (sold separately) to the wall. Match the height of the bracket that is mounted on the wall to the holes in the product.
- Ensure the eye-bolts or brackets are tightened securely.

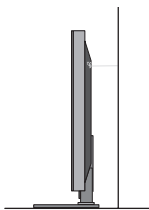

- Use a sturdy rope (sold separately) to tie the product. It is safer to tie the rope so it becomes horizontal between the wall and the product.

! NOTE

- ▶ Use a platform or cabinet strong enough and large enough to support the size and weight of the TV.
- ▶ To use the TV safely, make sure that the height of the bracket on the wall and the one on the TV are the same.



PREPARATION

- To prevent damage do not connect to the power outlet until all connections are made between the devices.
- Image shown may differ from your TV.

ANTENNA OR CABLE CONNECTION

1. Antenna (Analog or Digital)

Wall Antenna Socket or Outdoor Antenna without a Cable Box Connection.

For optimum picture quality, adjust antenna direction if needed.

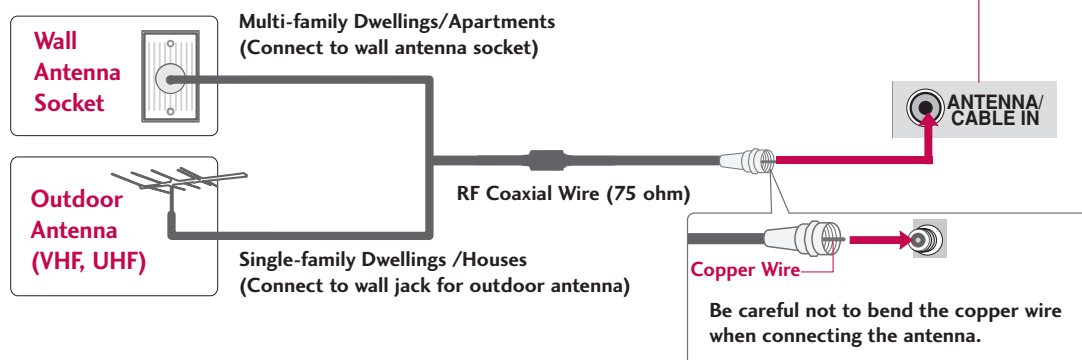

2. Cable

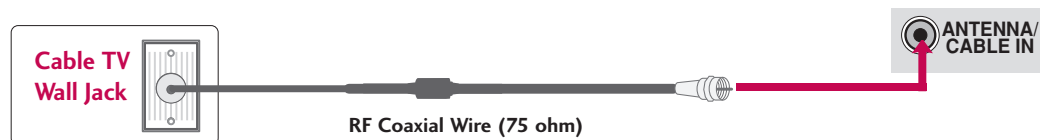

- To improve the picture quality in a poor signal area, please purchase a signal amplifier and install properly.
- If the antenna needs to be split for two TV's, install a 2-Way Signal Splitter.
- If the antenna is not installed properly, contact your dealer for assistance.
- Refer to <http://AntennaWeb.org> for more information about antennas and Digital TV.

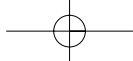

EXTERNAL EQUIPMENT SETUP

- To prevent the equipment damage, never plug in any power cords until you have finished connecting all equipment.
- Image shown may differ from your TV.

HD RECEIVER SETUP

This TV can receive Digital Over-the-air/Cable signals without an external digital set-top box. However, if you do receive digital signals from a digital set-top box or other digital external device, refer to the figure as shown below.

Component Connection

1. How to connect

- 1** Connect the video outputs (Y, PB, PR) of the digital set-top box to the **COMPONENT IN VIDEO 1** or **2** jacks on the TV. Match the jack colors (Y = green, PB = blue, and PR = red).
- 2** Connect the audio output of the digital set-top box to the **COMPONENT IN AUDIO 1** or **2** jacks on the TV.

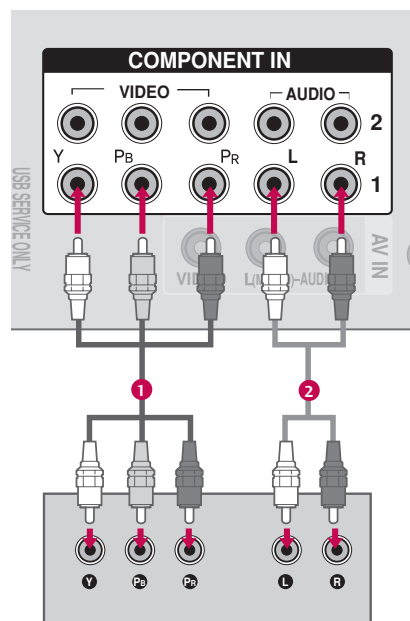

2. How to use

- Turn on the digital set-top box.
(Refer to the owner's manual for the digital set-top box operation)
- Select the **Component 1** or **2** input source on the TV using the **INPUT** button on the remote control.

Supported Resolutions

Signal	Component	HDMI
480i	Yes	No
480p	Yes	Yes
720p	Yes	Yes
1080i	Yes	Yes
1080p	Yes	Yes

Y, CB/PB, CR/PR

Resolution	Horizontal Frequency(KHz)	Vertical Frequency(Hz)
720x480i	15.73	59.94
	15.73	60.00
720x480p	31.47	59.94
	31.50	60.00
1280x720p	44.96	59.94
	45.00	60.00
1920x1080i	33.72	59.94
	33.75	60.00
1920x1080p	27.00	24.00
	33.75	30.00
	67.43	59.94
	67.50	60.00



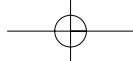

EXTERNAL EQUIPMENT SETUP

DVD SETUP

Component Connection

1. How to connect

- 1 Connect the video outputs (Y, Pb, Pr) of the DVD to the **COMPONENT IN VIDEO 1** or **2** jacks on the TV. Match the jack colors (Y = green, Pb = blue, and Pr = red).
- 2 Connect the audio outputs of the DVD to the **COMPONENT IN AUDIO 1** or **2** jacks on the TV.

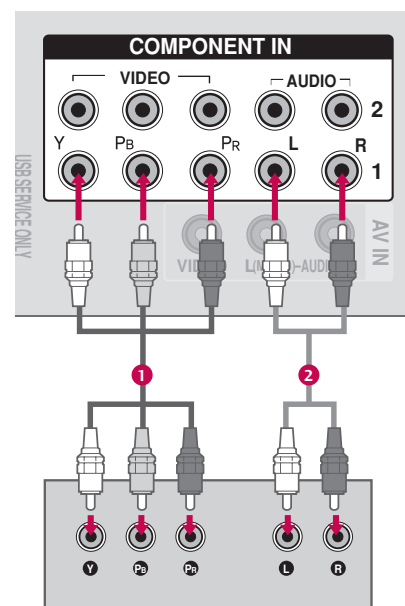

2. How to use

- Turn on the DVD player, insert a DVD.
- Select the **Component 1** or **2** input source on the TV using the **INPUT** button on the remote control.
- Refer to the DVD player's manual for operating instructions.

HDMI Connection

1. How to connect

- 1 Connect the HDMI output of the DVD to the **HDMI IN 1** or **2** jack on the TV.
- 2 No separate audio connection is necessary. HDMI supports both audio and video.

2. How to use

- Select the **HDMI 1** or **2** input source on the TV using the **INPUT** button on the remote control.
- Refer to the DVD player's manual for operating instructions.

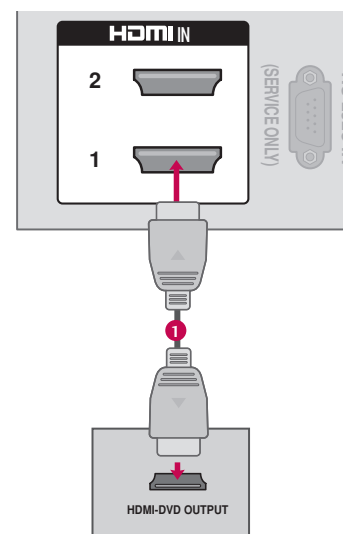

VCR SETUP

Composite (RCA) Connection

1. How to connect

- 1 Connect the **AUDIO/VIDEO** jacks between TV and VCR. Match the jack colors (Video = yellow, Audio Left = white, and Audio Right = red)

2. How to use

- Insert a video tape into the VCR and press PLAY on the VCR. (Refer to the VCR owner's manual.)
- Select the **AV** input source on the TV using the **INPUT** button on the remote control.

NOTE

- ▶ If you have a mono VCR, connect the audio cable from the VCR to the **AUDIO L(MONO)** jack of the TV.

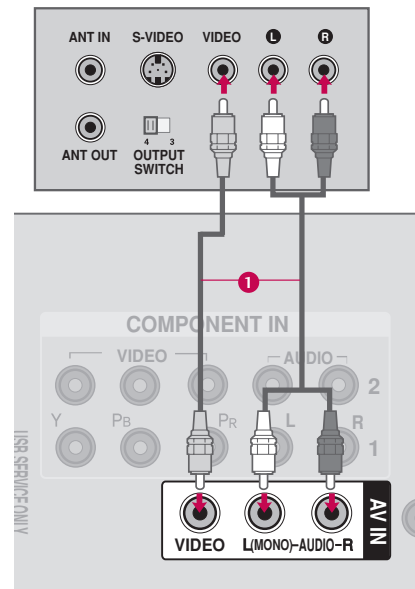

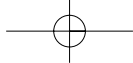

WATCHING TV

TURNING ON THE TV

- 1 First, connect power cord correctly.
And switch the **AC power control switch** on TV. At this moment, the TV switches to standby mode.
 - In standby mode to turn TV on, press the $\phi/1$, **INPUT**, **CH** (\blacktriangle or \blacktriangledown) button on the TV or press the **POWER**, **INPUT**, **CH** (\wedge or \vee), **Number (0~9)** button on the remote control.

- 2 Select the viewing source by using the **INPUT** button on the remote control.

- 3 When finished using the TV, press the **POWER** button on the remote control. The TV reverts to standby mode.

NOTE

- ▶ If you intend to be away on vacation, disconnect the power plug from the wall power outlet.
- ▶ If the TV is unplugged once or turn off with the $\phi/1$ button on the TV, reset the **Clock** function.

CHANNEL SELECTION

- 1 Press the **CH** (\wedge or \vee) or **NUMBER** buttons to select a channel number.

VOLUME ADJUSTMENT

Adjust the volume to suit your personal preference.

- 1 Press the **VOL** (+ or -) button to adjust the volume.
- 2 If you want to switch the sound off, press the **MUTE** button.
- 3 You can cancel the Mute function by pressing the **MUTE** or **VOL** (+ or -) button.



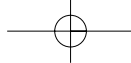

CHANNEL SETUP

Auto Scan (Auto Tuning)

Automatically finds all channels available through antenna or cable inputs, and stores them in memory on the channel list.

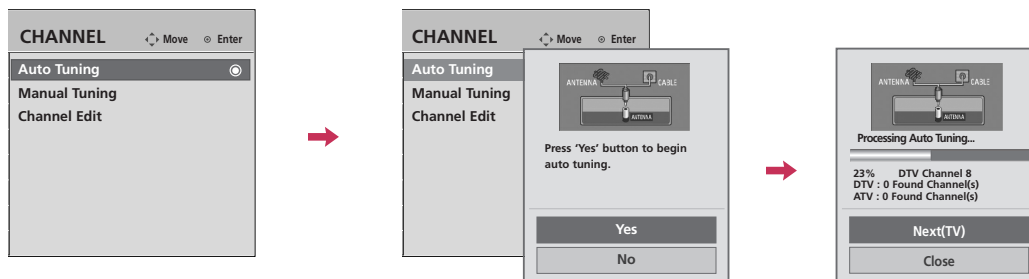

- 1 Select **CHANNEL**.
- 2 Select **Auto Tuning**.
- 3 Select **Yes**.
- 4 Run **Auto Tuning**.
- 5 Return to the previous menu.
- Return to TV viewing.

- The TV will ask for a password if parental control has been activated (**LOCK Menu**). Use the password you set up in the **LOCK Menu** to allow a channel search.
- When setting the **Auto Tuning** or **Manual Tuning**, the number of maximum channels you can store is 900. It is subject to change depending on the broadcasting signal environment.

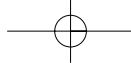

WATCHING TV





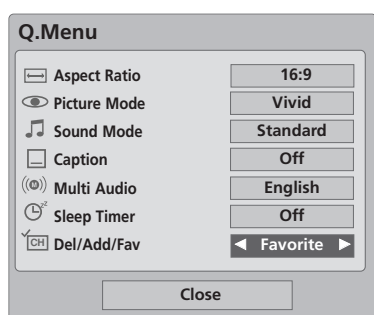

FAVORITE CHANNEL SETUP

Your TV's OSD (On Screen Display) may differ slightly from what is shown in this manual.

Favorite Channels are a convenient feature that lets you quickly select channels of your choice without waiting for the TV to select all the in-between channels.

To tune to a favorite channel, press the **FAV** (Favorite) button repeatedly.



- 1  or  Select your desired channel.
- 2   Select **Del/Add/Fav**.
- 3  Select **Favorite**.
- 4  Return to TV viewing.

WATCHING TV

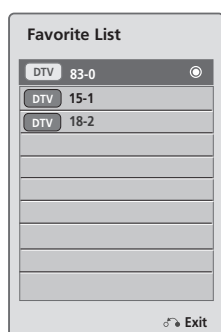

FAVORITE CHANNEL LIST





Displaying the favorite channel list

- 1  Display the Favorite channel list.

Selecting a channel in the favorite channel list

- 1  Select a channel.
- 2  Switch to the chosen channel number.

Paging through a favorite channel list

- 1  Turn the pages.
- 2  Return to TV viewing.



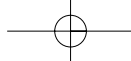

INITIAL SETTING

This Function guides the user to easily set the essential items for viewing the TV for the first time when purchasing the TV. It will be displayed on the screen when turning the TV on for the first time. It can also be activated from the user menus.

- Default selection is **“Home Use”**. We recommend setting the TV to **“Home Use”** mode for the best picture in your home environment.
- **“Store Demo”** Mode is only intended for use in retail environments. Customers can adjust the **“Picture menu - Picture mode”** manually while inspecting the TV, but the TV will automatically return to preset in-store mode after 5 minutes.
- You can also adjust **Initial Setting** in the **OPTION** menu.
Factory defaults are set when you choose **“Home Use”**.
- If you do not complete the **Initial setting**, it will appear whenever the TV is switched on until the **Initial setting** procedure is completed.

Step1. Language Selecting

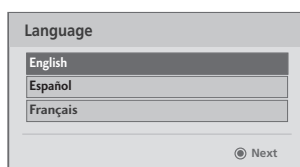

Step2. Mode setting

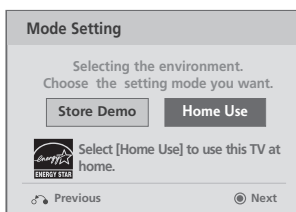

Step3. Time setting

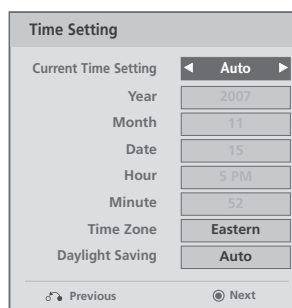

Step4. Auto Tuning

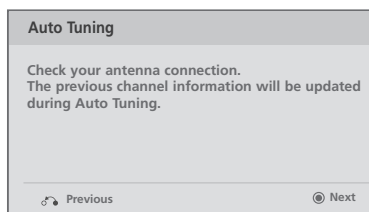

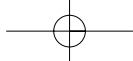

WATCHING TV

QUICK MENU

Your TV's OSD (On Screen Display) may differ slightly from what is shown in this manual. Q.Menu (Quick Menu) is a menu of features which users might use frequently.

- **Aspect Ratio:** Selects your desired picture format.
- **Picture Mode:** Selects the factory preset picture depend on the viewing environment.
- **Sound Mode:** Selects the factory preset sound for type of program.
- **Caption:** Select on or off.
- **Multi Audio:** Changes the audio language (Digital signal).
SAP: Selects MTS sound (Analog signal).
- **Sleep Timer:** Select the amount of time before your TV turns off automatically.
- **Del/Add/Fav:** Select channel you want to add/delete or add the channel to the Favorite List.



- 1 Display each menu.
- 2 Make appropriate adjustments.
- 3 Return to TV viewing.

WATCHING TV

ON-SCREEN MENUS SELECTION

Your TV's OSD (On Screen Display) may differ slightly from what is shown in this manual.

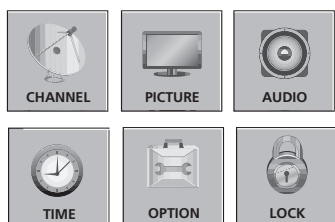

- 1 Display each menu.
- 2 Select a menu item.
- 3 Accept the current selection.
- 4 Return to TV viewing.

CHANNEL

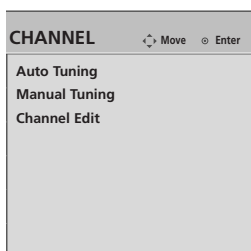

Auto Tuning	■ All available TV channels are searched and stored automatically.
Manual Tuning	■ User can do manual channel selection and add or delete individual channels.
Channel Edit	■ You can add or delete in the channel list.



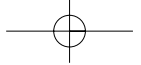

PICTURE

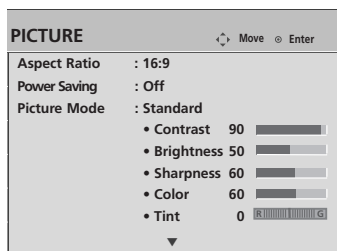

Aspect Ratio	<ul style="list-style-type: none"> Select the desired picture format
Power Saving	<ul style="list-style-type: none"> Reduces the TV's power consumption.
Picture Mode	<ul style="list-style-type: none"> Select the Vivid, Standard, Cinema, Sport, Game, Expert1 or Expert2. Adjust the Contrast, Brightness, Sharpness, Color, Tint. Advanced Control: You can calibrate the screen for each Picture Mode or set the video value according to the special video screen. Expert Control: By segmenting categories, Expert1 and Expert2 provide more categories which users can set as they see fit, offering the optimal picture quality for users. Reset: Settings of the selected picture modes return to the default factory settings.
Screen (RGB-PC)	<ul style="list-style-type: none"> Adjust the screen Resolution, Auto config, Position, Size, Phase, Reset.

WATCHING TV

AUDIO

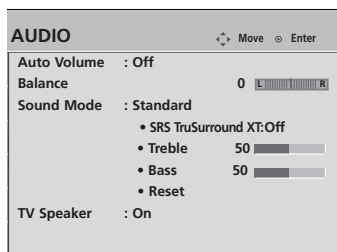

Auto Volume	<ul style="list-style-type: none"> Makes sure that the volume level remains consistent whether you are watching a commercial or a regular TV program.
Balance	<ul style="list-style-type: none"> Adjust the left/right sound of speaker to suit your taste and room situations.
Sound Mode	<ul style="list-style-type: none"> Select the Standard, Music, Cinema, Sport, and Game. SRS TruSurround XT, Treble, Bass: Adjust the sound to suit your taste and room situations. Reset: Settings of the selected Sound Mode return to the default factory settings.
TV Speaker	<ul style="list-style-type: none"> Turn the TV speaker On or off.

TIME

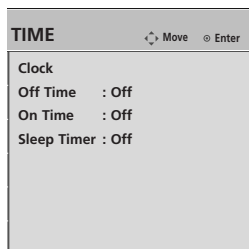

Clock	<ul style="list-style-type: none"> Auto: The time is set automatically from a digital channel signal. Select your viewing area time zone. Select Auto, Off, On depending on whether or not your viewing area observes Daylight Saving time. Manual: Set the clock manually.
Off Time	<ul style="list-style-type: none"> Select On or Off.
On Time	<ul style="list-style-type: none"> Select On or Off.
Sleep Timer	<ul style="list-style-type: none"> Select the amount of time before your TV turns off automatically: Off, 10, 20, 30, 60, 90, 120, 180, 240.



WATCHING TV

OPTION

OPTION	Move	Enter
Menu Language(Language):	English	
Audio Language	: English	
Input Label		
Key Lock	: Off	
Caption	: Off	
ISM Method	: Normal	
Initial Setting	: Home Use	

WATCHING TV

Menu Language (Language)	<ul style="list-style-type: none"> Selects your desired language for on screen menus: English, Spanish, French.
Audio Language	
Input Label	<ul style="list-style-type: none"> Sets a label to each input source.
key Lock	<ul style="list-style-type: none"> This feature can be used to prevent unauthorized viewing by locking out the front panel controls.
Caption	<ul style="list-style-type: none"> When selecting Off, Submenus for Analog, DTV, and Digital Option become disabled. Analog: CC1 ~ CC4 , Text1 ~ Text4. Digital: CC1 ~ CC4 , Text1 ~ Text4, Service1 ~ Service6. Digital Option: Customize the DTV/CADTV captions that appear on your screen.
ISM Method	<ul style="list-style-type: none"> Use it to minimize any fixed image on the screen. : Normal, Orbiter, Color Wash, White Wash.
Initial Setting	<ul style="list-style-type: none"> After turning on the TV, adjust Language, Mode, Time, Auto Tuning.

LOCK

LOCK	Move	Enter
Lock System	: Off	
Set Password		
Block Channel		
Movie Rating		
TV Rating-Children		
TV Rating-General		
Downloadable Rating		
Input Block		

Lock System	<ul style="list-style-type: none"> Select On or Off.
Set Password	<ul style="list-style-type: none"> Change the password.
Block Channel	<ul style="list-style-type: none"> Select a channel number that you wish to block.
Movie Rating	<ul style="list-style-type: none"> Blocks movies according to the movie ratings limits specified.
TV Rating-Children	<ul style="list-style-type: none"> Prevents children from watching certain children's TV programs, according to the ratings limit set.
TV Rating-General	<ul style="list-style-type: none"> Based on the ratings, blocks certain TV programs that you and your family do not want to view.
Downloadable Rating	<ul style="list-style-type: none"> This function may become available in the future and will be available only for digital channel signal.
Input Block	<ul style="list-style-type: none"> Enables you to select a source to block from the external source devices you have hooked up.

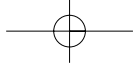

APPENDIX

TROUBLESHOOTING

Abnormal Operation	
The remote control doesn't work	<ul style="list-style-type: none"> ■ Check to see if there is any object between the product and the remote control causing obstruction. Ensure you are pointing the remote control directly at the TV. ■ Ensure that the batteries are installed with correct polarity (+ to +, - to -). ■ Ensure that the correct remote operating mode is set: TV, VCR etc. ■ Install new batteries.
Power is suddenly turned off	<ul style="list-style-type: none"> ■ Is the sleep timer set? ■ Check the power control settings. Power interrupted. ■ If there is no signal, the TV turns off automatically in 15 minutes.

Video Problems	
No picture & No sound	<ul style="list-style-type: none"> ■ Check whether the product is turned on. ■ Try another channel. The problem may be with the broadcast. ■ Is the power cord inserted into wall power outlet? ■ Check your antenna direction and/or location. ■ Test the wall power outlet, plug another product's power cord into the outlet where the product's power cord was plugged in.
Picture appears slowly after switching on	<ul style="list-style-type: none"> ■ This is normal, the image is muted during the product startup process. Please contact your service center, if the picture has not appeared after five minutes.
No or poor color or poor picture	<ul style="list-style-type: none"> ■ Adjust Color in menu option. ■ Keep a sufficient distance between the product and a VCR. ■ Try another channel. The problem may be with the broadcast. ■ Are the video cables installed properly? ■ Activate any function to restore the brightness of the picture.
Horizontal/vertical bars or picture shaking	<ul style="list-style-type: none"> ■ Check for local interference such as an electrical appliance or power tool.
Poor reception on some channels	<ul style="list-style-type: none"> ■ Station or cable product experiencing problems, tune to another station. ■ Station signal is weak, reorient antenna to receive weaker station. ■ Check for sources of possible interference.
Lines or streaks in pictures	<ul style="list-style-type: none"> ■ Check antenna (Change the direction of the antenna).
No picture when connecting HDMI	<ul style="list-style-type: none"> ■ Check HDMI cable over version 1.3. The HDMI cables don't support HDMI version 1.3, it cause flickers or no screen display. In this case use the latest cables that support HDMI version 1.3.



Audio Problems

Picture OK & No sound	<ul style="list-style-type: none"> ■ Press the VOL or VOLUME button. ■ Sound muted? Press MUTE button. ■ Try another channel. The problem may be with the broadcast. ■ Are the audio cables installed properly?
No output from one of the speakers	<ul style="list-style-type: none"> ■ Adjust Balance in menu option.
Unusual sound from inside the product	<ul style="list-style-type: none"> ■ A change in ambient humidity or temperature may result in an unusual noise when the product is turned on or off and does not indicate a fault with the product.
No sound when connecting HDMI/USB	<ul style="list-style-type: none"> ■ Check HDMI cable over version 1.3. ■ Check USB cable over version 2.0. ■ Use normal MP3 file. <p style="text-align: right; font-size: small;">*This feature is not available for all models.</p>

PC Mode Problems

The signal is out of range	<ul style="list-style-type: none"> ■ Adjust resolution, horizontal frequency, or vertical frequency. ■ Check the input source.
Vertical bar or stripe on background & Horizontal Noise & Incorrect position	<ul style="list-style-type: none"> ■ Work the Auto configure or adjust size, phase, or H/V position. (Option)
Screen color is unstable or single color	<ul style="list-style-type: none"> ■ Check the signal cable. ■ Reinstall the PC video card.

MAINTENANCE

Early malfunctions can be prevented. Careful and regular cleaning can extend the amount of time you can enjoy your new TV.

Caution: Be sure to turn the power off and unplug the power cord before you begin any cleaning.

Cleaning the Screen

- 1 Here's a great way to keep the dust off your screen for a while. Wet a soft cloth in a mixture of lukewarm water and a little fabric softener or dish washing detergent. Wring the cloth until it's almost dry, and then use it to wipe the screen.
- 2 Make sure the excess water is off the screen, and then let it air-dry before you turn on your TV.

Cleaning the Cabinet

- To remove dirt or dust, wipe the cabinet with a soft, dry, lint-free cloth.
- Please be sure not to use a wet cloth.

Extended Absence

⚠ CAUTION

- ▶ If you expect to leave your TV dormant for a long time (such as a vacation), it's a good idea to unplug the power cord to protect against possible damage from lightning or power surges.

WATCHING TV

PRODUCT SPECIFICATIONS

MODEL		Z42PQ20 (Z42PQ20-UC)
Dimensions (Width x Height x Depth)	With stand	40.5 x 28.3 x 12.1 inches 1031.2 x 720.9 x 308.0 mm
	Without stand	40.5 x 25.8 x 3.1 inches 1031.2 x 656.7 x 80.8 mm
Weight	With stand	53.5 lbs / 24.3 kg
	Without stand	48.9 lbs / 22.2 kg
Power requirement		AC100-240V ~ 50/60Hz
Television System		NTSC-M, ATSC, 64 & 256 QAM
Program Coverage		VHF 2-13, UHF 14-69, CATV 1-135, DTV 2-69, CADTV 1-135
External Antenna Impedance		75 ohm
Environment condition	Operating Temperature	32 ~ 104°F (0 ~ 40°C)
	Operating Humidity	Less than 80%
	Storage Temperature	-4 ~ 140°F (-20 ~ 60°C)
	Storage Humidity	Less than 85%

- The specifications shown above may be changed without prior notice for quality improvement.

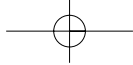

WATCHING TV

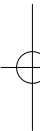

APPENDIX

CHILD SAFETY:

It Makes A Difference How and Where You Use Your Flat Panel Display

Congratulations on your purchase! As you enjoy your new product, please keep these safety tips in mind:



THE ISSUE

- The home theater entertainment experience is a growing trend and larger flat panel displays are popular purchases. However, flat panel displays are not always supported on the proper stands or installed according to the manufacturer's recommendations.
- Flat panel displays that are inappropriately situated on dressers, bookcases, shelves, desks, speakers, chests or carts may fall over and cause injury.

THIS MANUFACTURER CARES!

- The consumer electronics industry is committed to making home entertainment enjoyable and safe.

TUNE INTO SAFETY

- One size does NOT fit all. Follow the manufacturer's recommendations for the safe installation and use of your flat panel display.
- Carefully read and understand all enclosed instructions for proper use of this product.
- Don't allow children to climb on or play with furniture and television sets.
- Don't place flat panel displays on furniture that can easily be used as steps, such as a chest of drawers.
- Remember that children can become excited while watching a program, especially on a "larger than life" flat panel display. Care should be taken to place or install the display where it cannot be pushed, pulled over, or knocked down.
- Care should be taken to route all cords and cables connected to the flat panel display so that they cannot be pulled or grabbed by curious children.

WALL MOUNTING: IF YOU DECIDE TO WALL MOUNT YOUR FLAT PANEL DISPLAY, ALWAYS:

- Use a mount that has been recommended by the display manufacturer and/or listed by an independent laboratory (such as UL, CSA, ETL).
- Follow all instructions supplied by the display and wall mount manufacturers.
- If you have any doubts about your ability to safely install your flat panel display, contact your retailer about professional installation.
- Make sure that the wall where you are mounting the display is appropriate. Some wall mounts are not designed to be mounted to walls with steel studs or old cinder block construction. If you are unsure, contact a professional installer.
- A minimum of two people are required for installation. Flat panel displays can be heavy.



CEA
 Consumer Electronics Association
www.CE.org/safety

**ZENITH ELECTRONICS CORPORATION
PLASMA TV LIMITED WARRANTY – USA**

Zenith will repair or replace your product, at Zenith's option, if it proves to be defective in material or workmanship under normal use, during the warranty period ("Warranty Period") listed below, effective from the date of original consumer/end user purchase. This warranty is good only to the original consumer/end user of the product and is effective only when used in the United States.

<p>WARRANTY PERIOD:</p> <p>LABOR: ONE YEAR from the Date of Purchase.</p> <p>PARTS: ONE YEAR from the Date of Purchase.</p> <p>Effective Date of Warranty: Your warranty period Begins on the date of sale to the original consumer/end user. KEEP THE DEALER'S DATED BILL OF SALE OR PROOF OF DELIVERY as evidence of the purchase date. You will be required to submit a legible copy of your bill of sale or proof of delivery when requesting warranty service.</p> <p>Repair Parts and Replacement Units are warranted for the remaining period of the original warranty.</p>	<p>HOW SERVICE IS HANDLED:</p> <p>In Home Service. Please Call the Zenith Interactive Center at 1-877-9ZENITH (1-877-993-6484) to schedule a service appointment.</p> <p>Your unit will be repaired or replaced with a new, substitute model or factory reconditioned unit, at Zenith's option. If repaired, parts used in the repair may be new or remanufactured.</p> <p>Visit our website at http://www.zenithservice.com</p>
---	--

THIS WARRANTY IS IN LIEU OF ANY OTHER WARRANTIES, EXPRESS OR IMPLIED, INCLUDING WITHOUT LIMITATION, ANY WARRANTY OF MERCHANTABILITY OR FITNESS FOR A PARTICULAR PURPOSE. TO THE EXTENT ANY IMPLIED WARRANTY IS REQUIRED BY LAW, IT IS LIMITED IN DURATION TO THE EXPRESS WARRANTY PERIOD ABOVE. ZENITH WILL NOT BE LIABLE FOR ANY INCIDENTAL, CONSEQUENTIAL, INDIRECT, SPECIAL, OR PUNITIVE DAMAGES OF ANY NATURE, INCLUDING, WITHOUT LIMITATION, LOST PROFITS, LOST OR CORRUPTED PROGRAMMING OR DATA, OR ANY OTHER DAMAGE WHETHER BASED IN CONTRACT, TORT, OR OTHERWISE. Some states do not allow the exclusion or limitation of incidental or consequential damages or limitations on how long an implied warranty lasts, so the above exclusion or limitation may not apply to you. This warranty gives you specific legal rights and you may also have other rights that vary from state to state.

THIS LIMITED WARRANTY DOES NOT APPLY TO:

<ul style="list-style-type: none"> ● damage caused in shipping or transit ● service required as a result of improper installation, including incorrect or insufficient AC supply (please consult the owner's manual for power supply requirements) ● installation or repair of antenna systems, cable converters, cable company supplied equipment, or other components in a video system ● set-up or adjustment on consumer controls, or damage caused by improper adjustments ● damage caused by other system components ● any unit that has been modified or incorporated into any other product ● replacement of batteries on the remote control. ● damage (including cosmetic damage), failure, loss 	<p>or personal injury due to misuse, abuse, negligence, improper maintenance or storage, or to acts of nature or other causes beyond Zenith's control. (Causes beyond Zenith's control include but are not limited to lightning strike, power surges, power outages and water damage.)</p> <ul style="list-style-type: none"> ● Image burn-in ● repair or replacement of warranted parts by other than Zenith Authorized Service Centers. ● units purchased or serviced outside of the U.S.A. ● product where the original factory serial numbers have been removed, defaced or changed in any way. ● product sold and labeled as "as is, where is" or similar disclaimer.
---	---

The costs of repair or replacement under these excluded circumstances shall be borne by the consumer.

CONCERNING PIXEL FUNCTIONALITY: Your Plasma Television contains about one million individual pixels. Plasma TVs typically contain a small number of pixels that do not function normally. Your display has been inspected and is in compliance with manufacturer's specifications, indicating that any pixel defects do not affect the operation or use of your display.

CUSTOMER INTER-ACTIVE CENTER NUMBERS:

<p>To obtain customer assistance, product information, or Dealer or Service locations</p>	<p>Call 1-877-9Zenith (1-877-993-6484) (24 hours a day, 365 days per year) and select appropriate options from the menu. Or visit our website at http://www.zenithservice.com</p>
--	---

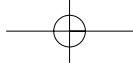

BEFORE CALLING FOR SERVICE:

- Please check your operating guide – you may avoid a service call.
- Please have your product model number, serial number and the date of purchase or the date of original installation available.
- If a replacement unit is required, under some circumstances you may be asked to provide a reserve deposit to Zenith against a credit card number as surety for advanced shipment. Your credit card will not be charged if you return the defective unit within 10 working days.
- If a replacement unit is received, please use the carton and packaging from that unit in returning the defective unit to Zenith.
- Parts and service in accordance with the Zenith warranty are Zenith's responsibility and will be provided without charge. Other service requirements will be at the owner's expense. If you have problems in obtaining satisfactory warranty service, write or call the Zenith Customer Interactive Center. Service may be provided by independently owned and operated service organizations.
- To assure proper credit and avoid unnecessary charges, you must obtain a Return Authorization before returning any product for Zenith Warranty Service. Contact the number below or your authorized Zenith repair facility for details.

IMPORTANT: Please fill out and mail your Product Registration Card or go to www.zenithservice.com to register your product online. This information allows Zenith to reach you promptly should we discover a safety or reliability problem that could affect you.

TO CONTACT ZENITH BY MAIL:

LG Customer Interactive Center
201 James Record Road
Huntsville, Alabama 35824
<http://www.zenithservice.com>

P/N : MFL58372908 (0909-REV00)
Printed in Korea



Free Manuals Download Website

<http://myh66.com>

<http://usermanuals.us>

<http://www.somanuals.com>

<http://www.4manuals.cc>

<http://www.manual-lib.com>

<http://www.404manual.com>

<http://www.luxmanual.com>

<http://aubethermostatmanual.com>

Golf course search by state

<http://golfingnear.com>

Email search by domain

<http://emailbydomain.com>

Auto manuals search

<http://auto.somanuals.com>

TV manuals search

<http://tv.somanuals.com>