

# SHARP®

## FU-40SE

**AIR PURIFIER  
OPERATION MANUAL**

**LUFTREINIGER  
BEDIENUNGSANLEITUNG**

**PURIFICATEUR D'AIR  
MANUEL D'UTILISATION**

**PURIFICADOR DE AIRE  
MANUAL DE USO**

**PURIFICATORE DELL'ARIA  
MANUALE OPERATIVO**

**LUCHTREINIGER  
GEBRUIKSAANWIJZING**

**ВОЗДУХООЧИСТИТЕЛЬ  
РУКОВОДСТВО ПО ЭКСПЛУАТАЦИИ**

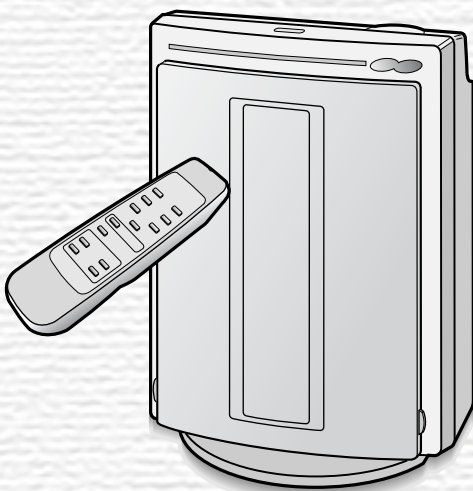

**Tabletop / wall-mounting type  
Tisch- / Wandgerät  
Type de table / installation murale  
De sobremesa / instalación en la pared  
Tipo da scrivania / parete  
Tafelmodel / wandmodel  
Настольный / настенный вариант**

ENGLISH

DEUTSCH

FRANÇAIS

ESPAÑOL

ITALIANO

NEDERLANDS

РУССКИЙ



## FEATURES

### Cluster Ion Control

The unit controls the ratio of minus cluster ions and plus cluster ions depending on the condition of the room.

#### • Clean mode

Approximately the same amount of plus and minus cluster ions are discharged. This mode is effective for reducing floating mold and household odors in the air.

#### • Refresh mode

It is said that plenty of minus ions exist in places such as waterfalls or forests in natural environment. In this operation mode, minus ions will be released in an increased rate, in order to bring the room air close to this condition.

#### • AUTO cluster ion mode

The unit will switch between the Clean mode and Refresh mode automatically depending on the amount of pollution in the air detected by dust and odor sensor.

### HEPA Filter

#### • High-efficiency dust collection

### Stamina-power carbon

Powerful deodorization by large particles of columnar charcoal.

## FOR UNDERSTANDING THE PRODUCT

Some of the odor ingredients adsorbed by the filters become separated and are discharged through the exhaust port as odor.

Depending on the usage environment, this odor may become strong in several months and the exhaust port may smell.

In this case, purchase the exchange filter FZ-40SEF of the option goods, and replace the filters.



This equipment complies with the requirements of Directives 89/336/EEC and 73/23/EEC as amended by 93/68/EEC.

## CONTENTS

<b>SAFETY PRECAUTIONS</b> .....	E-2
• CAUTIONS CONCERNING THE USAGE OF THIS PRODUCT .....	E-3
• CAUTIONS WHEN MOUNTING THIS PRODUCT TO A WALL .....	E-3
• CAUTIONS CONCERNING THE INSTALLATION .....	E-3
<b>NAMES OF PARTS</b> .....	E-4
• ACCESSORIES .....	E-5
<b>INSTALLATION</b> .....	E-6
• WHEN USING THE UNIT ON A TABLETOP ..	E-6
• WHEN USING THE UNIT WITH A MOUNTED WALL .....	E-7
<b>PREPARATION</b> .....	E-8
• INSTALLING THE FILTERS .....	E-8
• INSERTING BATTERIES IN THE REMOTE CONTROL .....	E-8
• USING THE REMOTE CONTROL .....	E-9
<b>OPERATION</b> .....	E-10
• MAIN UNIT OPERATION .....	E-10
• REMOTE CONTROL OPERATION .....	E-11
<b>CARE AND MAINTENANCE</b> .....	E-12
• MAIN UNIT .....	E-12
• FILTERS .....	E-12
• GUIDE FOR LIFE OF FILTERS .....	E-13
<b>TROUBLE SHOOTING</b> .....	E-14
<b>SPECIFICATIONS</b> .....	E-14

Thank you for purchasing the SHARP FU-40SE. Please read the instruction manual carefully for the correct usage. Before using this product, be sure to read "Safety precautions."

After reading this manual, retain it in a convenient location for future reference.

This product is for household use only.

# SAFETY PRECAUTIONS

- **Do not use the unit if the power cord or plug is damaged or the connection to the wall outlet is loose.**  
Electrical shock, short circuit and/or fire may occur as a result.
- **Do not damage, break, coat, forcefully bend, pull, twist, bundle, pinch or place heavy objects on the power cord.**  
If the power cord is damaged, fire and/or electrical shock may occur as a result.
- **Use AC 220~240V only.**  
Fire and/or electrical shock may occur as a result.
- **Do not modify. Repair and disassembly of this product are to be performed by authorized service personnel only.**  
Fire, electrical shock and/or bodily injury may occur as a result.  
For repair, contact your dealer of purchase or the nearest Sharp Service Center.
- **Periodically remove dust from the power plug**  
Accumulated dust on the power plug may cause bad insulation from humidity, etc.  
Fire and/or electrical shock may occur as a result.
- **When cleaning the unit, be sure to remove the power plug from the wall outlet.**  
In addition, never handle the power plug with wet hands.  
Electrical shock and/or bodily injury may occur as a result.
- **Do not use the unit where there are oil ingredients such as cooking oil, etc., in the air.**  
Cracking of the unit surface may occur as a result.
- **Do not wipe the unit with benzene or paint thinner. Also, do not spray insecticides on the unit.**  
Cracking, electrical shock and/or fire may occur as a result.
- **Do not operate the unit when using indoor smoke-generating insecticides.**  
Chemical ingredients may accumulate within the unit and then discharge from the exhaust port when the unit operates. Discharge of such chemicals may be unhealthy to your body.
- **Do not allow the unit to intake flammable gases, sparks from lit cigarettes, incense, etc.**  
The unit may ignite as a result.
- **Do not use the unit where it is humid, such as in a bathroom, etc., or where the unit may get wet.**  
Electrical shock and/or malfunction may occur as a result.
- **Do not insert fingers or foreign objects into the intake or exhaust ports.**  
Electrical shock and/or malfunction may occur as a result.
- **When mounting to a wall, select a sturdy wall or studding.**  
The unit may fall as result.
- **When removing the power plug, always hold the plug and never pull the cord.**  
Electrical shock and/or fire from short circuit may occur as a result.
- **Ventilate when using the unit along with a heating appliance.**  
Carbon monoxide poisoning may occur as a result.
- **Remove the power plug when not using the unit.**  
Electrical shock from bad insulation and/or fire from short circuit may occur as a result.
- **If the supply cord is damaged, it must be replaced by the manufacturer or its service agent or similarly qualified person in order to avoid a hazard.**
- **The batteries must be removed from the appliance before it is scrapped and that they are disposed of safely.**

## CAUTIONS CONCERNING THE USAGE OF THIS PRODUCT

- **Do not block the intake and exhaust ports.**
- Do not use the unit near or on hot objects, such as a stove, etc. Also, do not use the unit where it may come into contact with steam.
- **Do not use the unit on its side.**  
Deformation, malfunction and/or overheating of the motor may occur as a result.
- **Do not install when there is generation of lampblack, such as in a kitchen, etc.**
- **Do not use detergent when cleaning the unit.**  
The unit surface may become damaged or cracked.  
In addition, the sensors may malfunction as a result.
- **When transporting the unit, always hold the handle on the back of the unit.**  
Holding the front panel when carrying may cause it to detach, thus dropping the unit and resulting in bodily injury.

## CAUTIONS WHEN MOUNTING THIS PRODUCT TO A WALL

- **A wall side to install is to choose the place to have the strength done firmly.**
- **Never mount the unit to a thin wall or plasterboard of insufficient strength. The unit may drop as a result.**
- **When mounting the unit to a wall, remove the front panel and hold the main unit.**  
Holding the front panel may cause it to become detached, thus dropping the unit and resulting in bodily injury.
- **Do not install when there is generation of lampblack, such as in a kitchen, etc.**  
The unit surface may crack or the sensors may malfunction as a result.

## CAUTIONS CONCERNING THE INSTALLATION

### DO NOT USE THE REMOTE CONTROL IN THE FOLLOWING LOCATIONS

- **Location where there are inverter lighting equipment or electronic spontaneous lighting equipment**  
The remote control may become inoperative. In this case, move away from such lighting equipment or change direction.
- **Location exposed to direct sunlight**  
The unit may not received signals from the remote control  
The unit may not respond to the signals of the remote control if the ends of fluorescent lighting become black or lights flicker due the depletion of service life; however, this is not a malfunction of the remote control or the main unit. In this case, replace the lighting with new fluorescent tubes.

### TAKE CAUTION TO THE FOLLOWING DURING INSTALLATION

- **Leave at least 2m of space from televisions and radios**  
Electrical interference may occur as a result.
- **Leave at least 60cm of space from the wall**  
The motor may overheat, causing malfunction as a result.
- **Avoid a location where sensors are exposed to direct wind**  
The unit may not operate properly.
- **Avoid a location where curtains, etc., come into contact with the intake or exhaust port.**  
Curtains, etc., may become dirty or malfunction may occur as a result.

### EFFECTIVE USAGE

- **Stable surface with sufficient air circulation**
- **Near smoking area**  
Air pollution is detected quickly.

## ABOUT THE FILTER

- Do not wash and reuse Apatite HEPA filter and deodorization filter. It doesn't have effect, and they become an electric shock and the cause of the trouble.
- Small dust and odors such as tobacco smoke rise and accumulate at the top of the room.
- Large dust such as pollen and house dust accumulate at the bottom of the room.
- The wall, etc., behind the exhaust port may become dirty as time passes. When using the unit for extensive period in the same location, use a vinyl sheet, etc., to prevent the wall from becoming dirty. In addition, periodical clean the wall, etc.

# NAMES OF PARTS

## MAIN UNIT DISPLAY

\*It can't remove the noxious substances (carbon monoxide etc.) of cigarette.

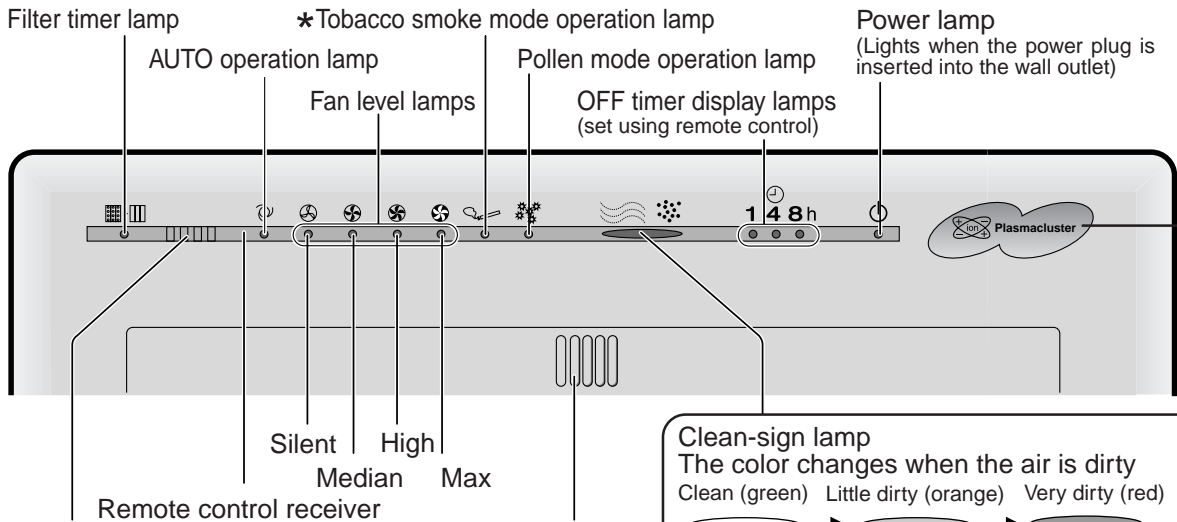

**Clean-sign lamp**  
The color changes when the air is dirty  
Clean (green) Little dirty (orange) Very dirty (red)



### ABOUT THE CLEAN-SIGN LAMP

- The dust sensor displays a clean sign depending on the relative change of the environment at the time the power plug is inserted in the wall outlet and after.
- When the air is extremely dirty at the time the power plug is inserted, the clean sign lamp may light green since the polluted state is the environment which the sensor bases the pollution rate on.
- In this case, switch manually to desirable operation as effective operation can't be done in auto operation.
- To reset the base pollution rate of the clean-sign lamp remove and insert the power plug again the room air becomes clean.

## EXPLODED DIAGRAM

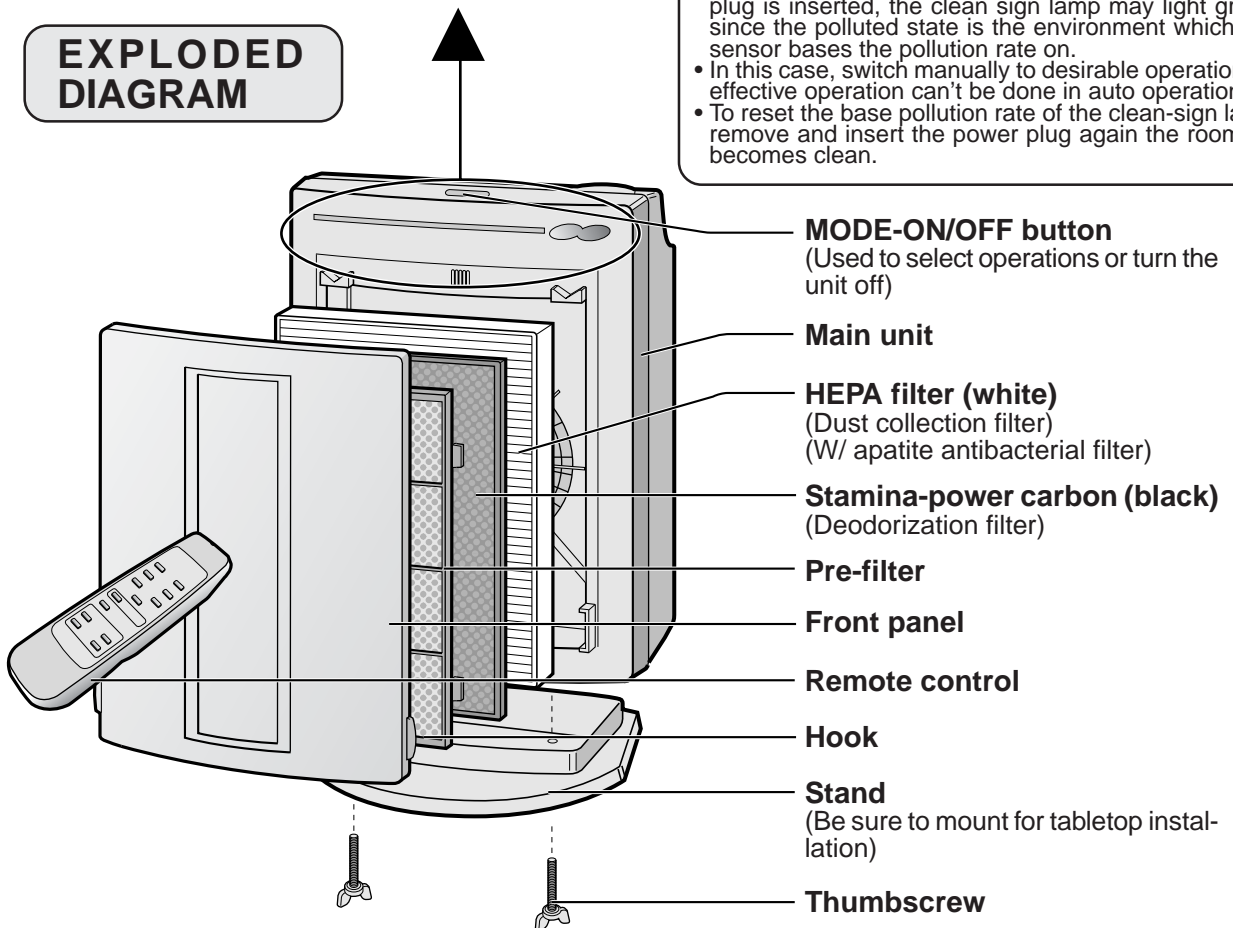

## CLUSTER ION LAMP

Cluster ion operation is selected using the remote control.

### Blue light

When the cluster ion operation is in the Clean mode or AUTO cluster ion mode and the air in the room is dirty, the light turns on and the unit will operate in the Clean mode.

### Green light

When the cluster ion operation is in the Refresh mode or AUTO cluster ion mode and the air in the room is dirty, the light turns on and the unit will operate in the Refresh mode.

### Light off

No cluster ions are generated.

If the lamp is bright when sleeping, or if the ion generation noise is irritating, turn off the cluster ion operation.

BACK

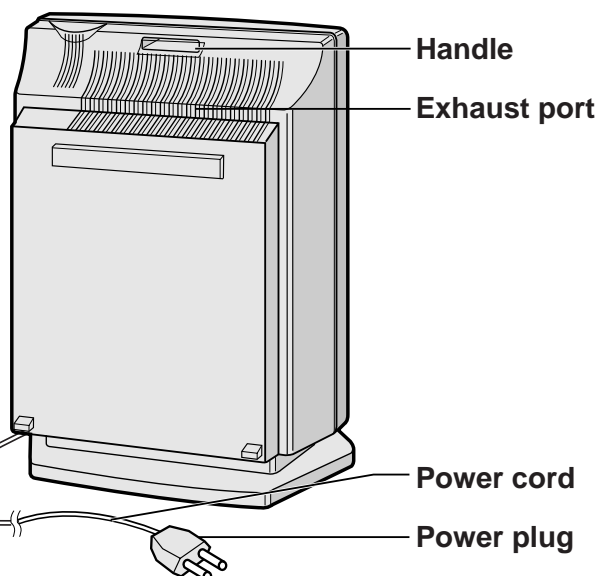

## ACCESSORIES

**Remote control**  
(1 unit)

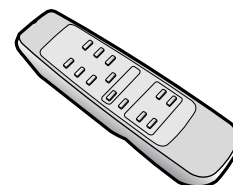

**Battery**  
(AA battery X  
2 units)



When using on tabletop

**Stand**  
(1 unit)

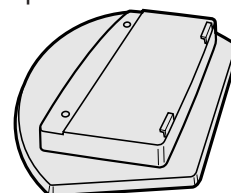

**Thumbscrew**  
(2 units)  
Located on  
bottom of  
stand



When using this product to a wall

**Wall mounting  
bracket 1**

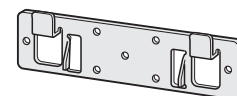

**Wall mounting  
bracket 2**

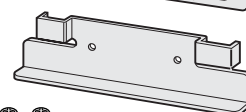

**Wood screw**  
(4 units)



**Small screw**  
(2 units)



**Cushions**  
(2 units)



# INSTALLATION

## WHEN USING THE UNIT ON A TABLETOP

### MOUNTING THE STAND

#### 1 Remove the front panel.

- At this time, also remove the pre-filter, stamina-power carbon and the HEPA filter.

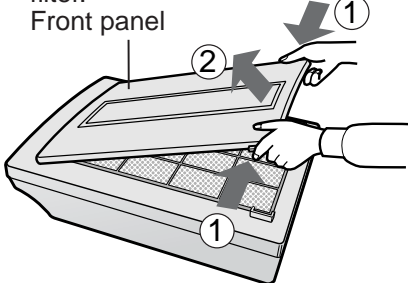

#### 2 Place the unit with its front side facing down on a flat and stable surface.

- Place a soft cloth, etc., to prevent damaging the unit.

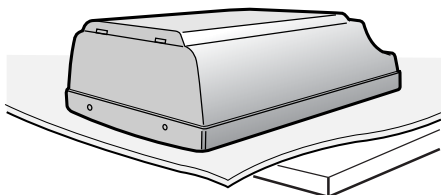

#### 3 Insert the tabs on the stand into the holes on the main unit and fix the stand using the included thumbscrews (2 units).

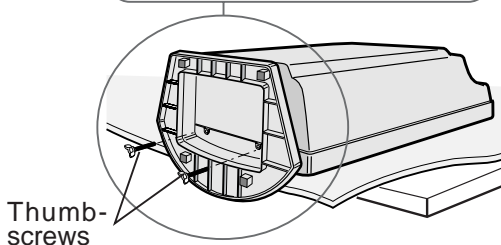
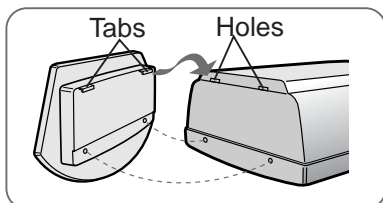

## WHEN USING THE UNIT WITH A MOUNTED WALL

### CAUTION

- When mounting the air purifier to the wall, the mounted wall will become dirty as time passes. To prevent this, place a vinyl sheet, etc., around the unit.
- A wall side to install is to choose the place to have the strength done firmly.
- In the case of a wall or concrete wall with little strength, request installation to a specialist such as an electric appliance shop, etc.
- Do not install in a location with heavy lamp-black, such as in a kitchen, etc. The unit surface may crack as a result.

#### 1 Determine the mounting location

Leave space around the bracket by referring to the illustration below. The unit cannot be mounted if there is insufficient spacing around the bracket.

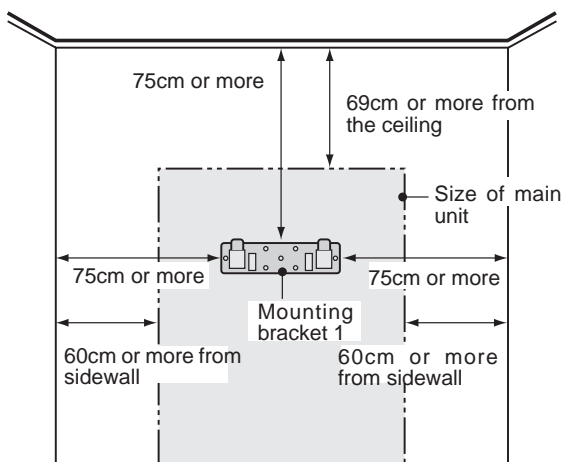

### CAUTION

#### Mount on a flat surface

- Do not mount the unit to a location that is not flat such as a wall with a door header, etc. Do not mount the unit to a thin wall with little strength such as a plasterboard, etc. The unit may fall and can be very dangerous.

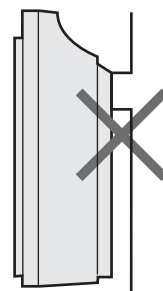



## 2 Mount mounting bracket 1

- Install it after you ask a specialist and you can get the confirmation of the strength.
- Mount the bracket using the included wood screws (long screws) so that it level.

### Use 4 wood screws (long screws)

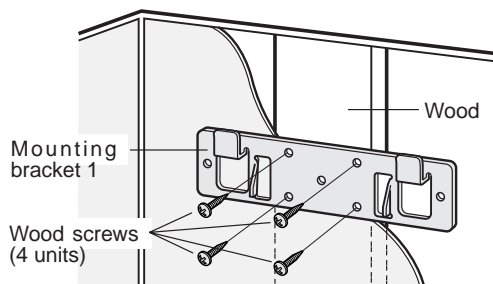

### Use 3 wood screws (long screws)

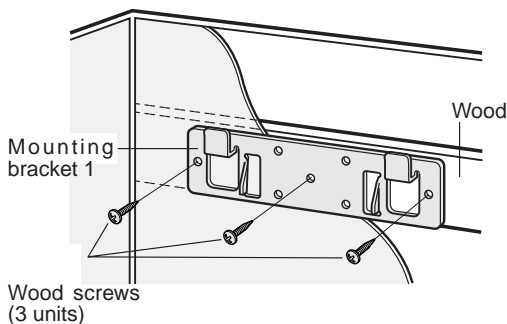

## 3 Mount mounting bracket 2 to the main unit

Mount the bracket to the back of the main unit using the included small screws (2 units).

Do not use wood screws (long screws)

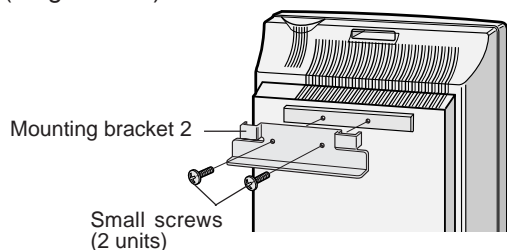

## 4 Place the 2 cushions

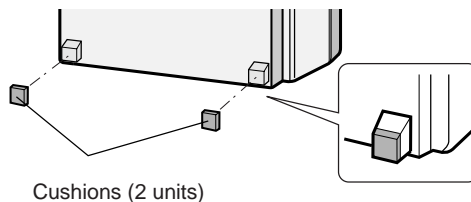

## 5 Mount the main unit

- (1) Align the horizontal positions of mounting brackets 1 and 2 and hook the bracket 2 to bracket 1.
- (2) Hold the bottom of the main unit, pull the unit towards you and then pull down.

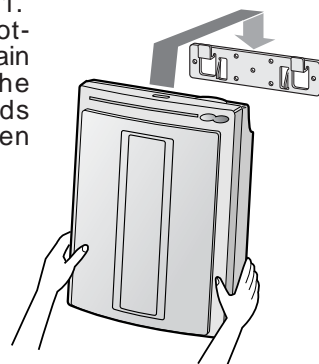

## 6 Check the installation

- Check to make sure that the tabs on mounting bracket 2 are securely mounted to the tabs on mounting bracket 1.
- Check that the power cord is not pinched.

## REMOVING THE UNIT

Pull the bottom of the unit towards you and then lift.

### NOTES

- When removing the unit, use a firm stand.
- Disconnect the power cord before removing the unit.



# PREPARATION

## INSTALLING THE FILTERS

To maintain the quality of the filters, they are installed in the main unit within polyvinyl bags. Be sure to remove the filters from the polyvinyl bags before using the unit.

### 1 Remove the filters

#### 1 Place the unit facing up

Place the unit on a table, etc., so that the stand does not contact the surface.

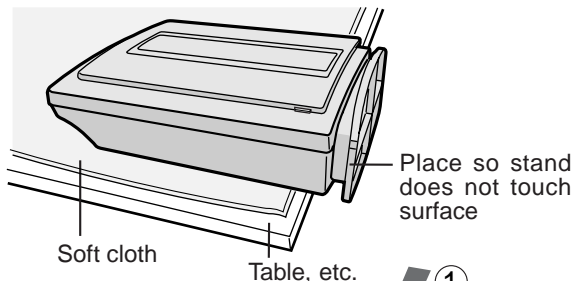

#### 2 Remove the front panel

Press in the hook on the bottom of the front panel and lift to remove.

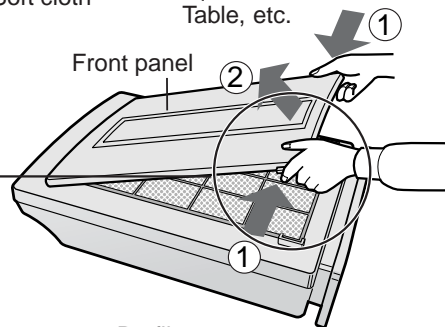
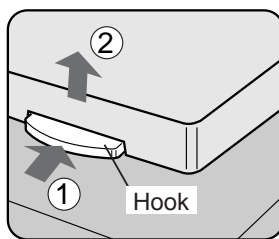

#### 3 Remove the pre-filter, and then remove the stamina-power carbon (black) and HEPA filter (white) that are inside the polyvinyl bags.

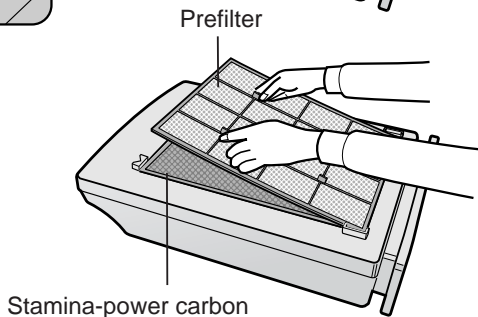

## INSERTING BATTERIES IN THE REMOTE CONTROL

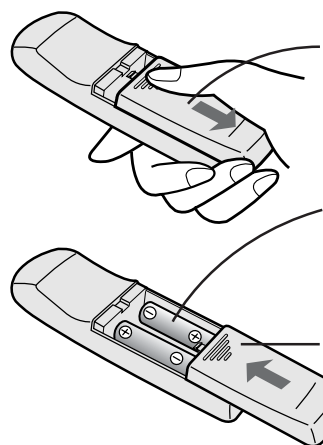

#### 1 Remove the back cover

Press and slide the back cover to remove.

#### 2 Insert batteries

Insert batteries with  $\oplus$  and  $\ominus$  as shown below.

#### 3 Close the back cover

### About the batteries

- The battery life is about 1 year. Replace the batteries when the remote control becomes inoperative.
  - Incorrect usage of the batteries may cause battery fluid leakage and/or damage. Take caution of the following when handling:
    - When replacing the batteries, replace both batteries with new ones of the same type. (Use AA alkaline batteries (2 units) or AA manganese batteries (2 units).)
    - When not using the unit or remote control for an extensive period, remove the batteries. This prevents malfunction of the remote control from battery fluid leakage.
- \* The included batteries are for initial use only and may deplete before 1 year.

## 2 Install the filter

- 1 Remove the HEPA filter from the polyvinyl bag and install it in the main unit with the **FRONT** display facing up.



Insert so that the tabs on the HEPA filter are facing toward you. Proper operation cannot be achieved when installing the filter backwards.

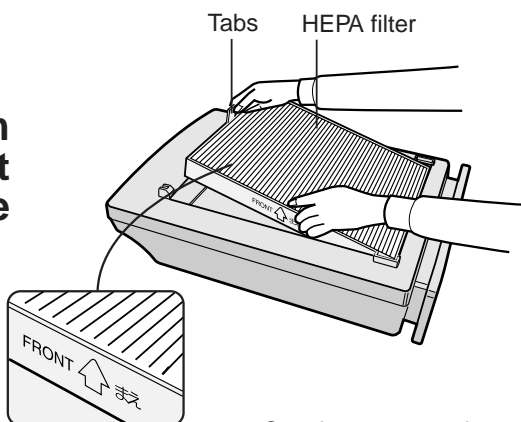

- 2 Remove the stamina-power carbon from the polyvinyl bag and install it in the main unit.

Make sure the tabs on the HEPA filter remain visible.

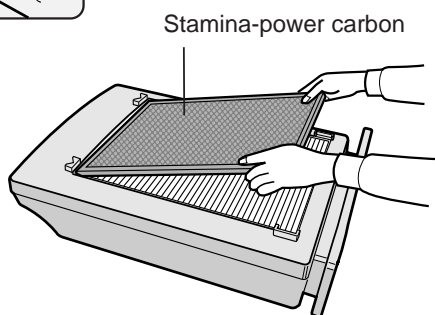

- 3 Install the pre-filter

Insert the 4 tabs on the pre-filter in the holes of the main unit.

- 4 Fill in the usage start date on the replacement label affixed on the back of the front panel and then mount the front panel.

Use the date as a guide for the filter replacement period.

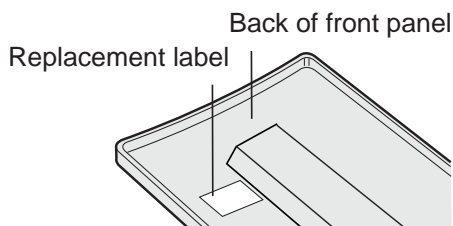

## USING THE REMOTE CONTROL

- Operate the remote control facing the main unit (receiver).
- The signal range is about 7m (front).
- Make sure there are no objects blocking the path of the signal.
- A sound will be heard from the main unit when a signal is received.

### NOTE

- Avoid strong impact on the remote control. In addition, do not wet the remote control or place it under direct sunlight or near a stove, etc. Malfunction may occur as a result.

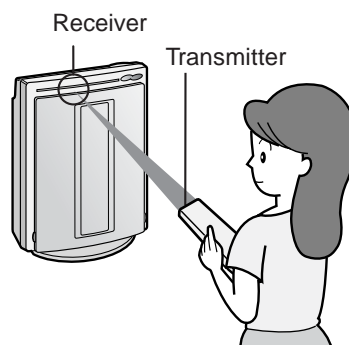

# OPERATION

For the first 30 seconds after the power plug is inserted into the wall outlet, the unit will check the conditions of the air. If operation is set to ON during this time, the Clean sign lamp will alternately flash in green, orange and red. During this time, the Cluster ion lamp will light blue and the unit will be in the Clean mode.

## MAIN UNIT OPERATION

Operations available with main unit

- AUTO operation
- Silent operation
- Median level operation
- High level operation
- Max level operation
- \*Tobacco smoke mode operation
- Pollen mode operation

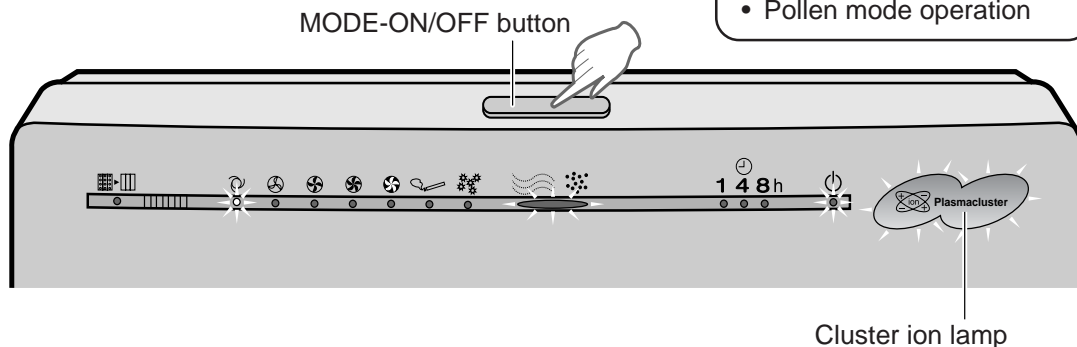

The unit will start operation when the **MODE-ON/OFF button** is pressed.

(The unit will start operation in AUTO mode)

- During operation, the cluster ion lamp will light.  
(During start of operation, the cluster ion mode will be AUTO)

The operation mode suitable for the usage condition can be set.

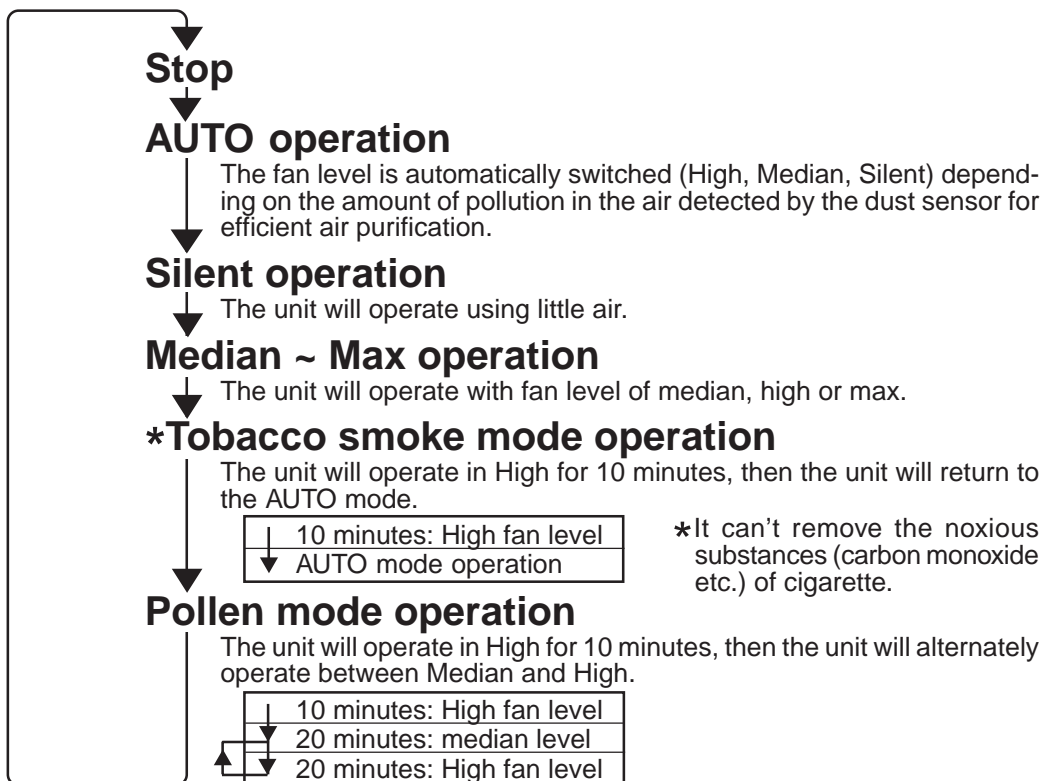

# REMOTE CONTROL OPERATION

- To start operation, press the ON/OFF button. A short beep will sound and operation will start in the AUTO mode.
- To stop operation, press the ON/OFF button again. A long beep will sound and operation will stop.

Operations available with remote control

- Fan level manual operation
- Fan level AUTO operation
- Silent operation
- Max operation
- \*Tobacco smoke mode operation
- Pollen mode operation
- OFF timer setting
- Cluster ion select  
AUTO cluster ion
- Clean mode  $\oplus\ominus\oplus\ominus$
- Refresh mode  $\ominus\ominus\ominus\ominus$

## Transmitter

### Manual (fan level) button

The fan level can be switched between Silent, Median, High and Max.

### Silent operation button

Operation will be in the Silent mode with little air.

### \*Tobacco smoke mode operation button

Unit will operate effectively when smoking cigarettes, etc.

### ON/OFF button

Used to start AUTO operation (short beep) and stop operation (long beep).

### Filter reset button

Press this button after replacing the filters.

- \*It can't remove the noxious substances (carbon monoxide etc.) of cigarette.

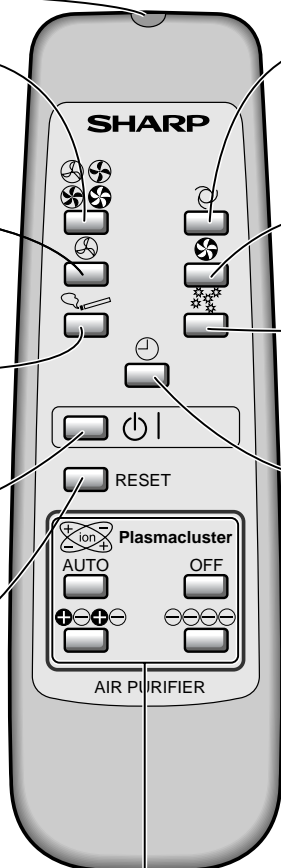

### AUTO (fan level) button

The fan level switched automatically depending on the amount of pollution in the air.

### Max operation button

Used to quickly clean the air in the room.

### Pollen mode operation button

The unit operates effectively when you suspect pollen in the air.

### OFF timer button

Used to set the OFF timer. The set time switches every time the button is pressed as shown below.

- 1 hour
- 4 hours
- 8 hours
- Cancel

- The remaining time is indicated by the lamp as time passes.
- The unit will stop operation when the timer is up.

At the start of operation, the Cluster ion mode is also set to AUTO.

## Cluster ion select button

### AUTO cluster ion button

The unit will switch between the Clean mode and Refresh mode automatically depending on the amount of pollution in the air detected by dust and odor sensor.

### Clean button $\oplus\ominus\oplus\ominus$

The unit will constantly operate in the Clean mode. The Clean mode is effective for removing mold fungus in the air. (Cluster ion lamp on (blue))

If the room smells especially moldy, operate the unit in the Clean mode.

### OFF button

The generation of ions is stopped and the cluster ion lamp is turned off.

### Refresh button $\ominus\ominus\ominus\ominus$

The unit will constantly operate in the Refresh mode. The Refresh mode maintains the balance of ions in the air for a refreshing effect.

(Cluster ion lamp on (green))

# CARE AND MAINTENANCE

(To maintain the best performance of this product, please clean the unit periodically.)

When cleaning, be sure to remove the power plug from the wall outlet. In addition, never handle the power plug with wet hands. Electrical shock and/or bodily injury may occur as a result.

## MAIN UNIT

For soiling on the main unit and the installed surface, clean as early as possible. Stubborn dirt may be hard to remove.

### Dry wipe with a soft cloth

For stubborn dirt, wipe with a soft cloth dampened with water or warm water of 40°C or less.

### Do not use volatile fluids

Benzene, paint thinner, polishing powder, etc., may damage the unit surface.

### Do not use detergents

Detergent ingredients may damage the unit surface.

### Do not get wet

Never apply water on the unit.

## ODOR SENSOR DUST SENSOR

The sensitivity of the sensors will be come unstable if the odor or dust sensor is dirty or blocked.

Remove dust on the surfaces of the sensor openings using a vacuum cleaner.

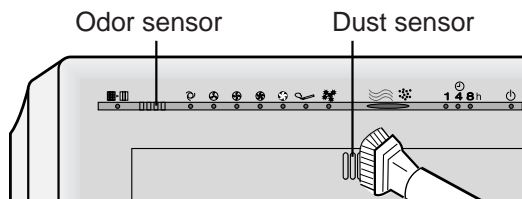

## FILTERS

Clean using the nozzle of a vacuum cleaner without removing the pre-filter.

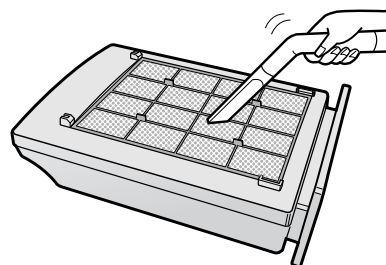

### NOTE

Never wash or clean the HEPA filter or stamina-power carbon by directly contacting the nozzle of a vacuum cleaner. This will greatly decrease the performance of the filters.

## GUIDE FOR LIFE OF FILTERS

- The replacement period differs depending on the usage hours and location of installation.
- Some of the odor ingredients adsorbed by the filters become separated and are discharged through the exhaust port as odor. Depending on the usage environment, this odor may become strong in several months and the exhaust port may smell. **If dust or odors cannot be removed easily, replace the filters.**  
(Refer to page1, FOR UNDERSTANDING THE PRODUCT)

### Guide for filter replacing timing

- The following is a guide from JEM 1467 by Japan Electrical Manufacturers Association in Japan, and in JEM 1467, the replacement period is set as when smoking 10 cigarettes per day and the dust collection/deodorization power is reduced by half than that of new filters.

- |                        |                             |
|------------------------|-----------------------------|
| • HEPA filter          | About 5 years after opening |
| • Stamina-power carbon | About 5 years after opening |

- The filter timer lamp is programmed to light in about 5 years, when using the unit for 12 hours everyday, in order to indicate accumulated usage time of the guide above.
- The filter timer lamp is to be used only as a guide.
- The operation hours are kept in memory even when removing the power plug for transportation to another room, etc.

## REPLACING THE FILTERS

- 1 See page 8 “Installing the filters” for the replacement method.**
- 2 After replacing the filters:**  
Be sure to press the Reset button on the remote control with the power plug inserted in the wall outlet.  
A short beep will be heard and the operation hours stored in the memory will be reset. If the filter replacement lamp is on, the lamp will turn off.
- 3 Fill in the usage start date of the filters on the date label included with the replacement filters. Affix the label on top of the replacement label that is already on the back of the front panel.**

### Replacement filters

- HEPA filter: 1 unit
- Stamina-power carbon: 1 unit

Model: FZ-40SEF

Please ask for replacement filters at your dealer of purchase.

### Cautions concerning the disposal of filters

Please dispose of replaced filters according to the local disposal laws and regulations.

HEPA filter materials:

- Filter: Polypropylene
- Frame: Polyester

Stamina-power carbon materials:

- Deodorizer: Activated charcoal
- Frame: Polyester

# TROUBLESHOOTING

Before calling for repair, check the symptoms below for possible remedies, since the problem may not be a malfunction of the unit.

SYMPTOM	REMEDY (not a malfunction)
<b>The remote control does not work</b>	<ul style="list-style-type: none"> <li>• Has the batteries depleted?</li> <li>• Are the batteries inserted with correct polarity?</li> <li>• Is a fluorescent lighting in the room flickering due to service life? (Refer to E-3)</li> </ul>
<b>Odors and smoke cannot be removed easily</b>	<ul style="list-style-type: none"> <li>• Are the filters heavily dirty? (Refer to E-13)</li> </ul>
<b>The Clean sign lights green even when the air is dirty</b>	<ul style="list-style-type: none"> <li>• Is the opening of the dust sensor blocked or clogged?</li> <li>• Was the air already dirty when the power plug was inserted into the wall outlet? (Refer to E-4)</li> </ul>
<b>The Clean sign lights orange or red even when the air is clean</b>	<ul style="list-style-type: none"> <li>• The sensitivity of the sensor becomes unstable when the opening of the dust sensor is dirty or is clogged. Clean the dust around the sensor opening using a vacuum cleaner. (Refer to E-12)</li> </ul>
<b>The cluster ion lamp remains green (blue) and does not change</b>	<ul style="list-style-type: none"> <li>• During the Clean mode (or Refresh mode), the cluster ion lamp color will not change.</li> </ul>
<b>A sound is heard from the unit</b>	<ul style="list-style-type: none"> <li>• This is the sound that is emitted when the unit is in the Refresh mode. If the sound is irritating, switch the unit to the Clean mode.</li> <li>• This is the sound that is emitted when the unit is generating cluster ions. If the sound is irritating, such as when sleeping, etc., set the Cluster ion mode to OFF.</li> </ul>
<b>The discharged air smells</b>	<ul style="list-style-type: none"> <li>• The ozone generated by the cluster ion generator may have an odor. However, the density of ozone generated is very little and is harmless to the human body. Furthermore, the ozone decomposes quickly so it does not accumulate in the room.</li> </ul>
<b>The unit does not operate even when smoking cigarettes</b>	<ul style="list-style-type: none"> <li>• Is the unit installed in a location that is difficult for the sensors to detect cigarette smoke?</li> <li>• If the odor or dust sensor openings blocked or clogged? (In this case, clean the openings.) (Refer to E-12)</li> </ul>

## SPECIFICATIONS

The applicable floor surface area is the surface area for when operating the unit in Max fan level. (According to Japan Electrical Manufacturers' Association JEM1467)

Power supply		220V-240V 50Hz			
Fan level operation	Fan level adjustment	Max	High	Median	Silent
	Rated power	39W	21W	10W	4W
	Fan level	240m <sup>3</sup> /hour	180m <sup>3</sup> /hour	117m <sup>3</sup> /hour	30m <sup>3</sup> /hour
Applicable floor surface		~31m <sup>2</sup>			
Cord length		2.5m			
Dimensions		415mm(W)X197mm(D)X572mm(H)(W/ stand)			
Weight		6.6kg			

### About the reduction of standby power

In order to operate the electrical circuits while the power plug is inserted in the wall outlet, this product consumes about 0.8W of standby power. (At this time, the power lamp will be on) For the conservation of energy, remove the power plug when not using the unit



**Во исполнение Статьи 5 Закона Российской Федерации «О защите прав потребителей», а также Указа Правительства Российской Федерации № 720 от 16 июня 1997 г. устанавливается срок службы данной модели – 7 лет с момента производства при условии использования в строгом соответствии с инструкцией по эксплуатации и применяемыми техническими стандартами.**

**Страна–изготовитель: Произведено в Японии**

**Фирма–изготовитель: Шарп Корпорейшн**

**Юридический адрес изготовителя:**

**22–22 Нагайке–чо, Абено–ку,  
Осака 545–8522, Япония**

# SERVICE PROCEDURE / SERVICE VORGEHENSWEISE

## SERVICE PROCEDURE - ONLY EFFECTIVE IN GERMANY

Dear SHARP customer,

SHARP machines are proprietary articles which are produced with precision and care according to most modern production methods.

In case of proper handling and with considering of the instruction book, this machine will serve you well for a long time.

Of course, a defect cannot be ruled out.

If your appliance has a warrantyable defect in the period of warranty, please contact your dealer, where you bought the appliance. This dealer is your only contact person for any claim of warranty.

**As proof for repairs during Warranty period, you need the invoice of the machine.**

Please bring your defect appliances also to your dealer (where you bought the appliance) when the warranty period is over.

### SHARP ELECTRONICS (EUROPE) GMBH

Parts & Technical Service

## SERVICE VORGEHENSWEISE - GILT NUR FÜR DEUTSCHLAND

Lieber SHARP-Kunde

SHARP- Geräte sind Markenartikel, die mit Präzision und Sorgfalt nach modernen Fertigungsmethoden hergestellt werden.

Bei sachgemässer Handhabung und unter Beachtung der Bedienungsanleitung wird Ihnen Ihr Gerät lange Zeit gute Dienste leisten.

Das Auftreten von Fehlern ist aber nie auszuschließen.

Sollte Ihr Gerät während der Gewährleistungsfrist einen gewährleistungspflichtigen Mangel aufweisen, so wenden Sie sich bitte an den Handelsbetrieb, bei dem Sie dieses Gerät erworben haben, denn dieser ist Ihr alleiniger Ansprechpartner für jegliche Gewährleistungsansprüche.

**Als Nachweis im Gewährleistungsfall dient Ihr Kaufbeleg.**

Sollte sich nach Ablauf der Gewährleistungsfrist ein Fehler des Gerätes zeigen, so wenden Sie sich bitte auch in diesem Fall an den Handelsbetrieb, bei dem Sie dieses Gerät erworben haben.

### SHARP ELECTRONICS (EUROPE) GMBH

Parts & Technical Service

**SHARP CORPORATION**  
**OSAKA, JAPAN**

## Free Manuals Download Website

<http://myh66.com>

<http://usermanuals.us>

<http://www.somanuals.com>

<http://www.4manuals.cc>

<http://www.manual-lib.com>

<http://www.404manual.com>

<http://www.luxmanual.com>

<http://aubethermostatmanual.com>

Golf course search by state

<http://golfingnear.com>

Email search by domain

<http://emailbydomain.com>

Auto manuals search

<http://auto.somanuals.com>

TV manuals search

<http://tv.somanuals.com>