

Impreso en Japón
Impresso no Japão
TINS-7436CEN1

Impreso en papel reciclado.
Impresso em papel reciclado pós utilização.



LC-15B2U

SHARP®



LC-15B2U

ENGLISH

FRANÇAIS

**LCD COLOR TELEVISION
TÉLÉVISEUR COULEUR À
ÉCRAN À CRISTAUX
LIQUIDES (LCD)**

**OPERATION MANUAL
MODE D'EMPLOI**

**MANUAL DE MANEJO
MANUAL DE OPERAÇÃO**

**TELEVISIÓN EN COLOR LCD
TELEVISOR COLORIDO LCD**



LC-15B2U

PORTUGUÊS

ESPAÑOL

SHARP®



SHARP®

Printed on post-consumer recycled paper.
Imprimé sur du papier recyclé.

Printed in Japan
Imprimé au Japon
TINS-7436CEN1



ENGLISH

LC-15B2U

LCD COLOR TELEVISION



ENGLISH

OPERATION MANUAL



Important Information

WARNING: TO REDUCE THE RISK OF FIRE OR ELECTRIC SHOCK, DO NOT EXPOSE THIS PRODUCT TO RAIN OR MOISTURE.

	CAUTION RISK OF ELECTRIC SHOCK. DO NOT OPEN.	
CAUTION: TO REDUCE THE RISK OF ELECTRIC SHOCK, DO NOT REMOVE COVER (OR BACK). NO USER-SERVICEABLE PARTS INSIDE. REFER SERVICING TO QUALIFIED SERVICE PERSONNEL.		



The lightning flash with arrow-head symbol, within an equilateral triangle, is intended to alert the user to the presence of uninsulated "dangerous voltage" within the product's enclosure that may be of sufficient magnitude to constitute a risk of electric shock to persons.



The exclamation point within a triangle is intended to alert the user to the presence of important operating and maintenance (servicing) instructions in the literature accompanying the product.

WARNING: FCC Regulations state that any unauthorized changes or modifications to this equipment not expressly approved by the manufacturer could void the user's authority to operate this equipment.

U.S.A. ONLY

CAUTION: TO PREVENT ELECTRIC SHOCK, MATCH WIDE BLADE OF PLUG TO WIDE SLOT, FULLY INSERT.

"Note to CATV system installer: This reminder is provided to call the CATV system installer's attention to Article 820-40 of the National Electrical Code that provides guidelines for proper grounding and, in particular, specifies that the cable ground shall be connected to the grounding system of the building, as close to the point of cable entry as practical."

This product utilizes tin-lead solder, and fluorescent lamp containing a small amount of mercury. Disposal of these materials may be regulated due to environmental considerations. For disposal or recycling information, please contact your local authorities or the Electronic Industries Alliance: www.eia.org

IMPORTANT:
To aid reporting in case of loss or theft, please record the TV's model and serial numbers in the space provided. The numbers are located at the rear of the TV.

Model No.:

Serial No.:

U.S.A. ONLY

DEAR SHARP CUSTOMER

Thank you for your purchase of the Sharp LCD Color TV product. To ensure safety and many years of trouble-free operation of your product, please read the Safety Precautions carefully before using this product.

IMPORTANT SAFETY PRECAUTIONS

Electricity is used to perform many useful functions, but it can also cause personal injuries and property damage if improperly handled. This product has been engineered and manufactured with the highest priority on safety. However, improper use can result in electric shock and/or fire. In order to prevent potential danger, please observe the following instructions when installing, operating and cleaning the product. To ensure your safety and prolong the service life of your LCD color TV product, please read the following precautions carefully before using the product.

- Read instructions—All operating instructions must be read and understood before the product is operated.
- Keep this manual in a safe place—These safety and operating instructions must be kept in a safe place for future reference.
- Observe warnings—All warnings on the product and in the instructions must be observed closely.
- Follow instructions—All operating instructions must be followed.
- Attachments—Do not use attachments not recommended by the manufacturer. Use of inadequate attachments can result in accidents.
- Power source—This product must operate on a power source specified on the specification label. If you are not sure of the type of power supply used in your home, consult your dealer or local power company. For units designed to operate on batteries or another power source, refer to the operating instructions.
- Power cord protection—The power cords must be routed properly to prevent people from stepping on them or objects from resting on them. Check the cords at the plugs and product.
- If the AC adapter is misplaced or needs to be replaced, obtain the same type of adapter from a SHARP service center or your dealer.
- Overloading—Do not overload AC outlets or extension cords. Overloading can cause fire or electric shock.
- Entering of objects and liquids—Never insert an object into the product through vents or openings. High voltage flows in the product, and inserting an object can cause electric shock and/or short internal parts. For the same reason, do not spill water or liquid on the product.
- Servicing—Do not attempt to service the product yourself. Removing covers can expose you to high voltage and other dangerous conditions. Request a qualified service person to perform servicing.
- Repair—If any of the following conditions occurs, unplug the power cord from the AC outlet, and request a qualified service person to perform repairs.
 - a. When the power cord or plug is damaged.
 - b. When a liquid was spilled on the product or when objects have fallen into the product.
 - c. When the product has been exposed to rain or water.
 - d. When the product does not operate properly as described in the operating instructions.

Do not touch the controls other than those described in the operating instructions. Improper adjustment of controls not described in the instructions can cause damage, which often requires extensive adjustment work by a qualified technician.
 - e. When the product has been dropped or damaged.
 - f. When the product displays an abnormal condition. Any noticeable abnormality in the product indicates that the product needs servicing.
- Replacement parts—In case the product needs replacement parts, make sure that the service person uses replacement parts specified by the manufacturer, or those with the same characteristics and performance as the original parts. Use of unauthorized parts can result in fire, electric shock and/or other danger.
- Safety checks—Upon completion of service or repair work, request the service technician to perform safety checks to ensure that the product is in proper operating condition.
- Wall or ceiling mounting—When mounting the product on a wall or ceiling, be sure to install the product according to the method recommended by the manufacturer.
- Polarization—This AC adapter may be equipped with a polarized alternating current line plug (a plug having one blade wider than the other). This plug will fit into the power outlet only one way. This is a safety feature. If you are unable to insert the plug fully into the outlet, try reversing the plug. If the plug should still fail to fit, contact your electrician to replace your obsolete outlet. Do not defeat the safety purpose of the polarized plug.



IMPORTANT SAFETY PRECAUTIONS (Continued)

- **Cleaning**—Unplug the power cord from the AC outlet before cleaning the product. Use a damp cloth to clean the product. Do not use liquid cleaners or aerosol cleaners.

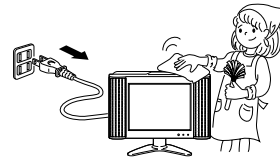

- **Water and moisture**—Do not use the product near water, such as bathtub, washbasin, kitchen sink and laundry tub, swimming pool and in a wet basement.

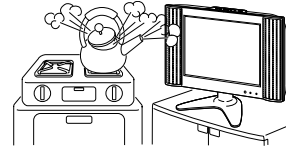

- **Stand**—Do not place the product on an unstable cart, stand, tripod or table. Placing the product on an unstable base can cause the product to fall, resulting in serious personal injuries as well as damage to the product. Use only a cart, stand, tripod, bracket or table recommended by the manufacturer or sold with the product. When mounting the product on a wall, be sure to follow the manufacturer's instructions. Use only the mounting hardware recommended by the manufacturer.



- When relocating the product placed on a cart, it must be moved with utmost care. Sudden stops, excessive force and uneven floor surface can cause the product to fall from the cart.



- **Ventilation**—The vents and other openings in the cabinet are designed for ventilation. Do not cover or block these vents and openings since insufficient ventilation can cause overheating and/or shorten the life of the product. Do not place the product on a bed, sofa, rug or other similar surface, since they can block ventilation openings. This product is not designed for built-in installation; do not place the product in an enclosed place such as a bookcase or rack, unless proper ventilation is provided or the manufacturer's instructions are followed.

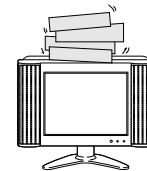

- The LCD panel used in this product is made of glass. Therefore, it can break when the product is dropped or applied with impact. Be careful not to be injured by broken glass pieces in case the LCD panel breaks.

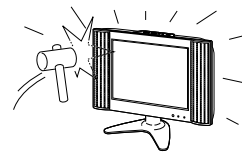

- **Heat sources**—Keep the product away from heat sources such as radiators, heaters, stoves and other heat-generating products (including amplifiers).

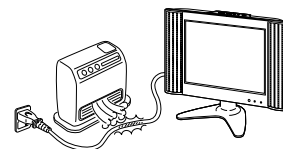

- The LCD panel is a very high technology product with 921,600 thin film transistors, giving you fine picture details. Occasionally, a few non-active pixels may appear on the screen as a fixed point of blue, green or red. Please note that this does not affect the performance of your product.

IMPORTANT SAFETY PRECAUTIONS (Continued)

- If an outside antenna is connected to the television equipment, be sure the antenna system is grounded so as to provide some protection against voltage surges and built-up static charges. Section 810 of the National Electrical Code provides information with respect to proper grounding of the mast and supporting structure, grounding of the lead-in wire to an antenna discharge unit, size of grounding conductors, location of antenna-discharge unit, connection to grounding electrodes, and requirements for the grounding electrode.

EXAMPLE OF ANTENNA GROUNDING AS PER
NATIONAL ELECTRICAL CODE

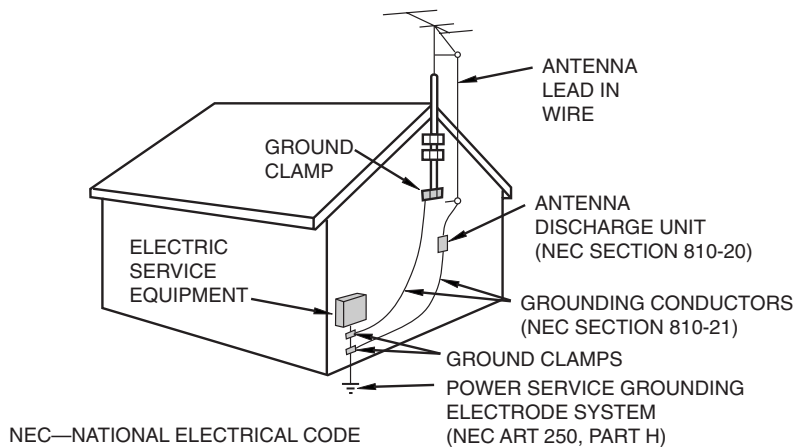

- For added protection for this television equipment during a lightning storm, or when it is left unattended and unused for long periods of time, unplug it from the wall outlet and disconnect the antenna. This will prevent damage to the equipment due to lightning and power-line surges.

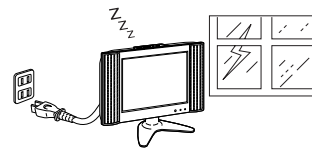

- An outside antenna system should not be located in the vicinity of overhead power lines or other electric light or power circuits, or where it can fall into such power lines or circuits. When installing an outside antenna system, extreme care should be taken to keep from touching such power lines or circuits as contact with them might be fatal.

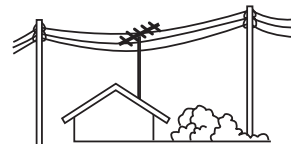



CONTENTS

	Page
DEAR SHARP CUSTOMER	3
IMPORTANT SAFETY PRECAUTIONS	3-5
SUPPLIED ACCESSORIES	7
PREPARATION	8-10
Using the Remote Control	8
Batteries for the Remote Control	8
Power Connection	9
Antenna Connection	9, 10
FRONT AND REAR CONTROL OPTIONS	11-13
Removing the Back Cover	13
Listening with Headphones	13
REMOTE CONTROL	14
BASIC OPERATION	14-17
Turning on POWER	15
Switching TV/VIDEO [AV1/AV2/COMPONENT/TV] Modes	15
Sound Volume	16
ON/OFF Standby	16
Changing the Channels	17
SELECTING MENU ITEMS	18
ADJUSTMENT	19-34
Adjusting the SLEEP TIMER Settings	19
Adjusting the BRIGHTNESS Settings	20
Adjusting the LANGUAGE Settings	21
Adjusting the VIDEO ADJUST Settings	22, 23
Adjusting the PRESET Settings	24
SET UP	25, 26
Adjusting the BLUE SCREEN Settings	27
Adjusting the CLOSED CAPTION Settings	28
Adjusting the V-CHIP Settings	29-34
CONNECTING WITH EXTERNAL DEVICES	35-37
TROUBLESHOOTING	38, 39
SPECIFICATIONS	40
DIMENSIONAL DRAWINGS	41

SUPPLIED ACCESSORIES

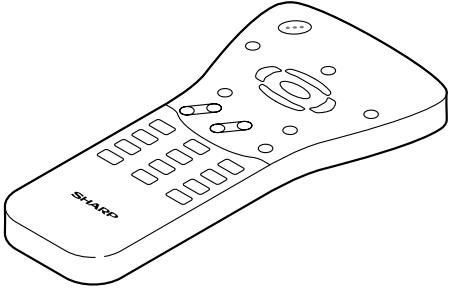
Make sure the following accessories are provided with the product.

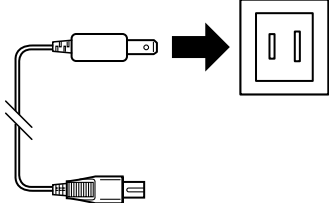
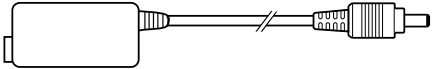
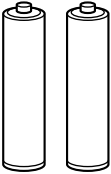
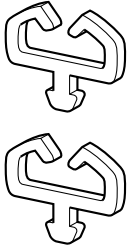
<p>Operation Manual</p>  <p>TINS-7436CEZZ</p>	<p>Wireless Remote Control</p>  <p>RRMCG1664CESA</p>	
<p>Antenna Cable (2m)</p>  <p>QCNW-5730CEZZ</p>	<p>AC Cord</p>  <p>QACCD3097CEPA</p>	
<p>AC Adapter</p>  <p>UADP-0228CEPZ</p>	<p>Size AAA Dry Battery (×2)</p>  <p>UBATU0026GEZZ</p>	<p>Cable Clamp (×2)</p>  <p>LHLDW0109CEZZ</p>

US

7

PREPARATION

Using the Remote Control

- Use the remote control by pointing it towards the remote sensor window. Objects between the remote control and sensor window may prevent proper operation.

Cautions regarding use of remote control

- Do not expose the remote control to shock. In addition, do not expose the remote control to liquids, and do not place in an area with high humidity.
- Do not install or place the remote control under direct sunlight. The heat may cause deformation of the unit.
- The remote control may not work properly if the remote sensor window of the main unit is under direct sunlight or strong lighting. In such a case, change the angle of the lighting or LCD TV set, or operate the remote control closer to the remote sensor window.

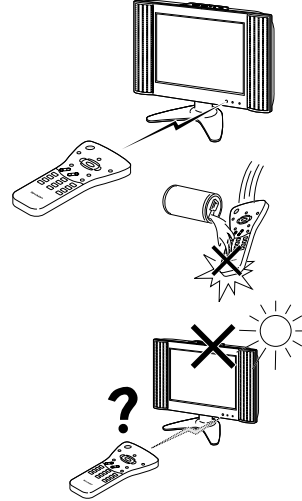

Batteries for the Remote Control

If the remote control fails to operate the LCD color TV functions, replace the batteries in the remote control.

- 1** Open the battery cover.

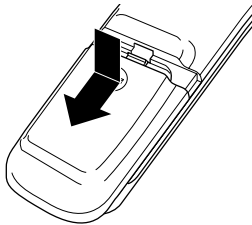

- Slide the cover while pressing down.

- 2** Insert batteries (two size-AAA batteries, supplied with product).

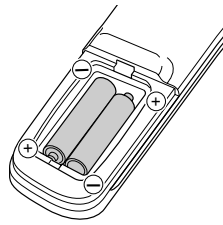

- Place the batteries with their terminals corresponding to the (+) and (-) indications in the battery compartment.

- 3** Close the battery cover.

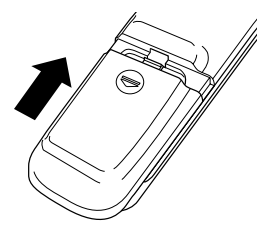

⚠ Caution!

Cautions regarding batteries

Improper use of batteries can result in a leakage of chemicals and/or explosion. Be sure to follow the instructions below.

- Place batteries with their terminals corresponding to the (+) and (-) indications.
- Different types of batteries have different characteristics. Do not mix batteries of different types.
- Do not mix old and new batteries. Mixing old and new batteries can shorten the life of new batteries and/or cause old batteries to leak chemicals.
- Remove batteries as soon as they are non-operable. Chemicals that leak from batteries can cause a rash. If chemical leakage is found, wipe with a cloth.
- The batteries supplied with the product may have a shorter life expectancy due to storage conditions.
- If the remote control is not used for an extended period of time, remove the batteries from the remote control.

PREPARATION (Continued)

Power Connection

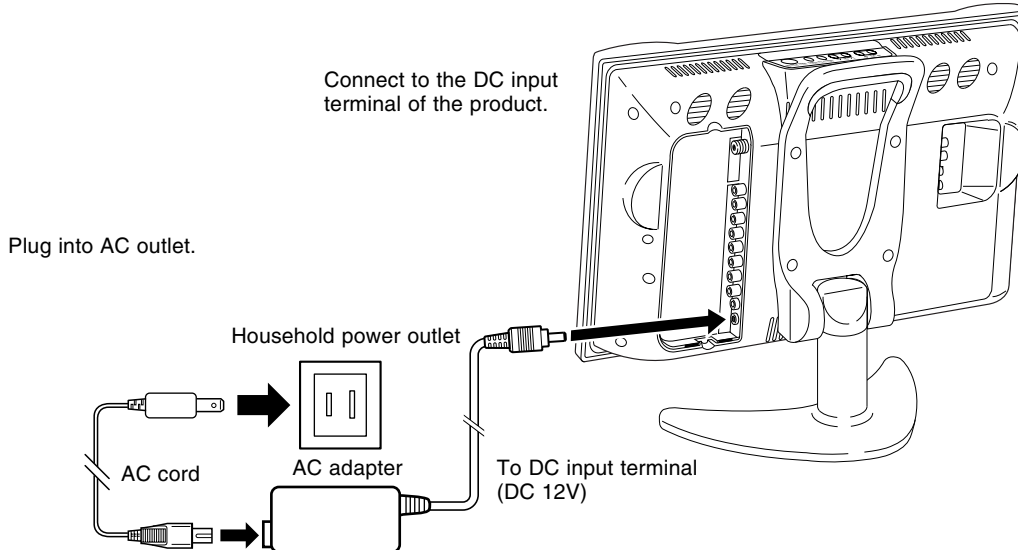

Notes:

- Use a commercially available AC plug adapter, if necessary, depending on the design of the wall outlet.
- Always turn the main **POWER** switch of the LCD TV set to off when connecting the AC adapter.
- Always unplug the AC adapter from the product and power outlet when not using for a long period of time.

Antenna Connection

CABLE TV (CATV) CONNECTION

- A 75-ohm coaxial cable connector is built into the set for easy hookup. When connecting the 75-ohm coaxial cable to the set, screw the 75-ohm cable to the ANT. terminal.
- Some cable TV companies offer "premium pay channels". Since the signals of these premium pay channels are scrambled, a cable TV converter/descrambler is generally provided to the subscriber by the cable TV company. This converter/descrambler is necessary for normal viewing of the scrambled channels. (Set your TV to channel 3 or 4, typically one of these channels is used. If this is unknown, consult your cable TV company.) For more specific instructions on installing cable TV, consult your cable TV company. One possible method of utilizing the converter/descrambler provided by your cable TV company is explained below.

Please note: An RF switch provided with two inputs (A and B) is required (not supplied).

"A" position on the RF switch (not supplied) : You can view all unscrambled channels by using the TV's channel keys.

"B" position on the RF switch (not supplied) : You can view the scrambled channels via the converter/descrambler by using the converter's channel keys.

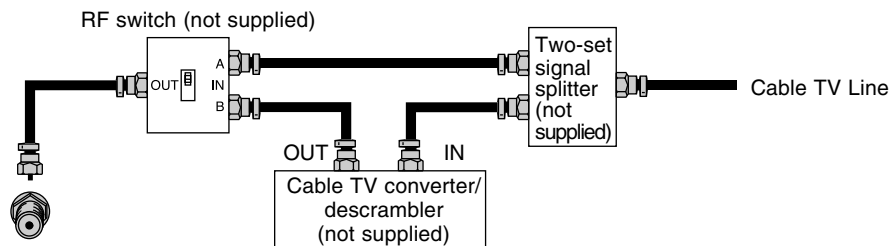

Note:

- Consult your SHARP Dealer or Service Center for the type of splitter, RF switch or combiner that might be required.

PREPARATION (Continued)

Antenna Connection (Continued)

ANTENNAS

- The antenna requirements for good color television reception are more important than those for black & white television reception. For this reason, a good quality outdoor antenna is strongly recommended. The following is a brief explanation of the type of connections that are provided with the various antenna systems.

1. A 75-ohm system is generally a round cable with F-type connector that can easily be attached to a terminal without tools (not supplied).

F-type connector



75-ohm coaxial cable (round)

2. A 300-ohm system is a flat "twin-lead" cable that can be attached to a 75-ohm terminal through a 300-75-ohm adapter (not supplied).



300-ohm twin-lead cable (flat)

OUTDOOR ANTENNA CONNECTION

- Use one of the following two diagrams if you connect an outdoor antenna.
A: Using a VHF/UHF combination outdoor antenna.
B: Using separate VHF and/or UHF outdoor antennas.
- Connect the outdoor antenna cable lead-in to the ANT. terminal on the rear of the TV set.

A. Combination VHF/UHF Antenna

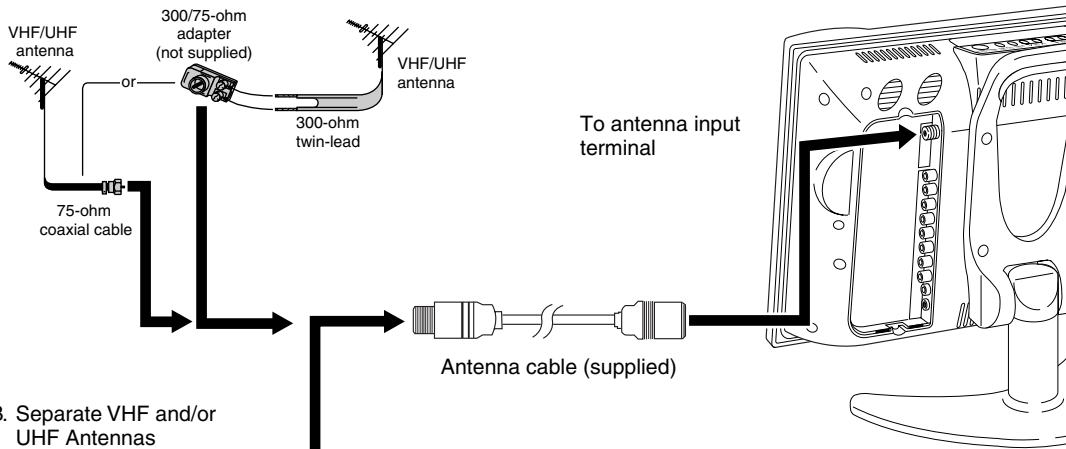

B. Separate VHF and/or UHF Antennas

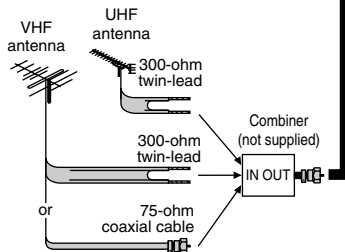

FRONT AND REAR CONTROL OPTIONS

Main unit (front view)

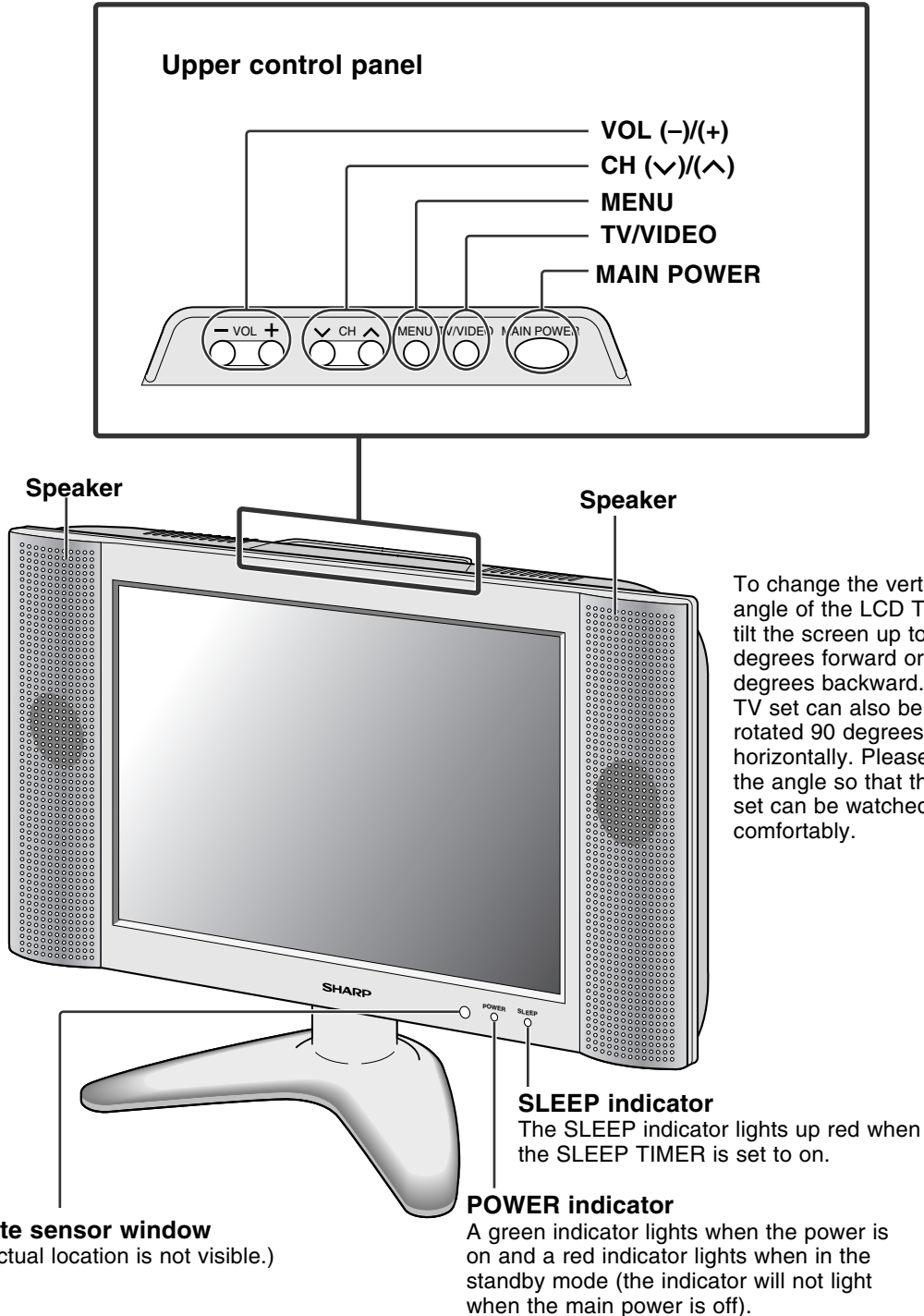

To change the vertical angle of the LCD TV set, tilt the screen up to 10 degrees forward or 20 degrees backward. The TV set can also be rotated 90 degrees horizontally. Please adjust the angle so that the TV set can be watched most comfortably.

Note:

- **TV/VIDEO**, **CH** (^)/(v), **VOL** (+)/(-), and **MENU** on the main unit have the same functions as the same buttons on the remote control. Fundamentally, this operation manual provides a description based on operation with the remote control.



FRONT AND REAR CONTROL OPTIONS (Continued)

Main unit (rear view)

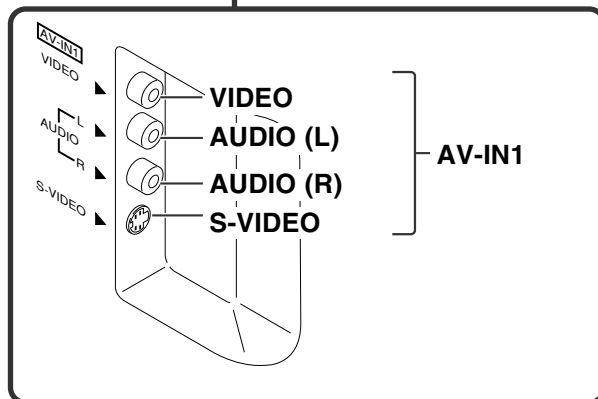
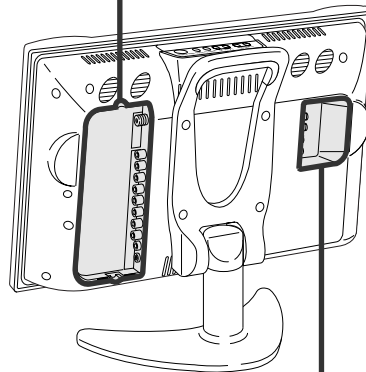
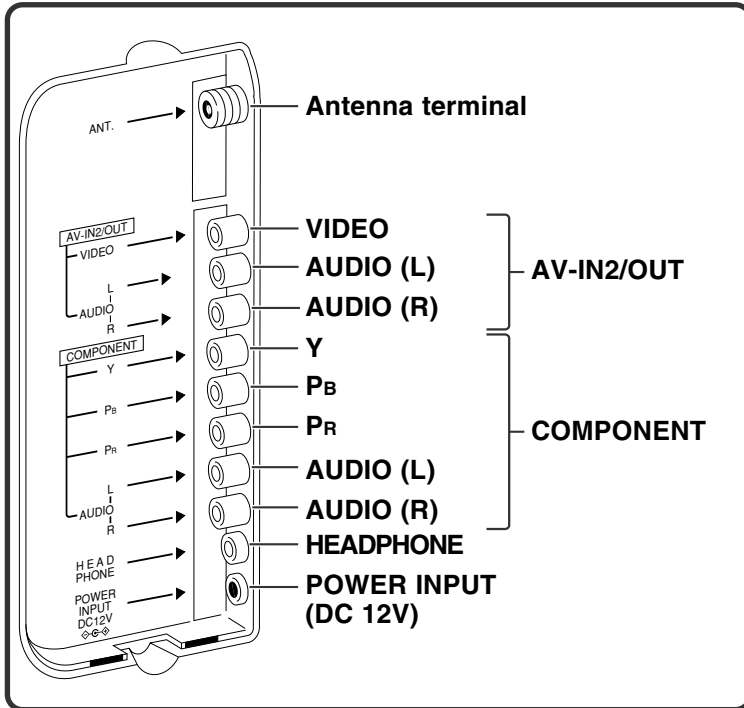



FRONT AND REAR CONTROL OPTIONS (Continued)

Removing the Back Cover

- Before connecting a connection cord into the rear terminal, remove the back cover. Push in the tab and pull out the back cover carefully.
- To mount the cover, insert the 2 hooks on the bottom of the cover into the cabinet and press on the upper part of the back cover until the tab locks in place with a click.

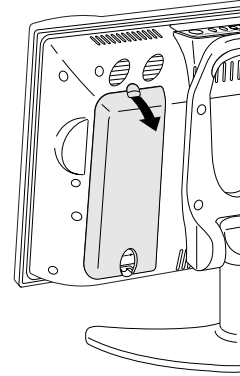

Listening with Headphones

- Plug the headphone mini-plug into the HEADPHONE jack located on the rear of the TV set.

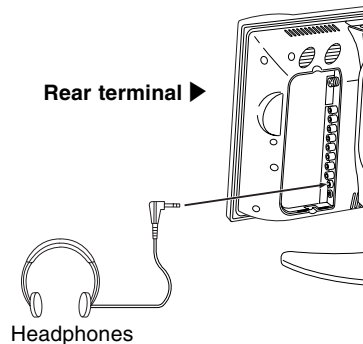

▼ On-screen display

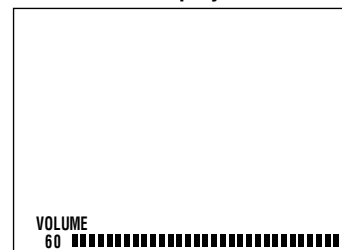

Notes:

- Headphones are not included in the supplied accessories.
- No sound will be heard from the main unit speakers when a headphone mini-plug is connected into the HEADPHONE jack.

REMOTE CONTROL

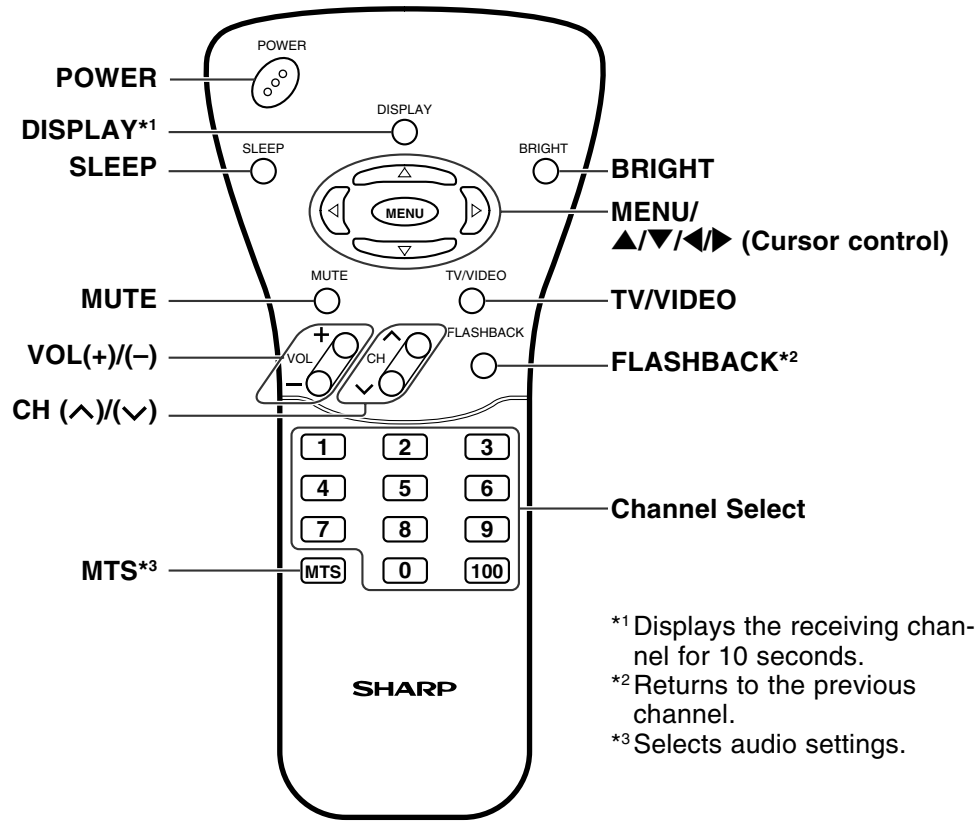

- *1 Displays the receiving channel for 10 seconds.
- *2 Returns to the previous channel.
- *3 Selects audio settings.

BASIC OPERATION

This product is factory set to comply with the TV broadcasting system in the United States. For Brazil, Argentina and Uruguay, set the color system according to the country before using this product by following the table below. The VIDEO INPUT mode is compatible with color systems worldwide and is automatically set.

Country	TV broadcasting system	Factory setting of color system		User setting
		TV	Video	TV
U.S.A.	Color: NTSC TV ch: US ch	NTSC (N358) US ch	World Multi Auto System	Not required or N/A
Canada, Mexico, Latin America	Color: NTSC TV ch: US ch	NTSC (N358) US ch	World Multi Auto System	Not required or N/A
Brazil	Color: PAL-M TV ch: US ch	NTSC (N358) US ch	World Multi Auto System	Set color system to PAL-M (see page 23)
Argentina, Uruguay	Color: PAL-N TV ch: US ch	NTSC (N358) US ch	World Multi Auto System	Set color system to PAL-N (see page 23)

* The World Multi Auto System is compatible with all color systems indicated below.

- ① N358
- ② N443
- ③ PAL
- ④ PAL-M
- ⑤ PAL-N
- ⑥ SECAM
- ⑦ PAL-60

BASIC OPERATION (Continued)

Turning on POWER

Control section of main unit

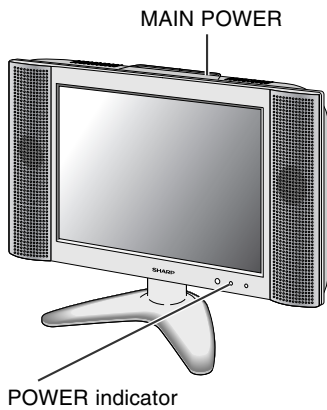

- 1 Press **MAIN POWER**, located on the upper side of the main unit, to on.
- 2 The **POWER** indicator instantaneously changes from red to green and the main unit is turned on.

Note:

- The input mode indication disappears after several seconds.

▼ On-screen display



Switching TV/VIDEO [AV1/AV2/COMPONENT/TV] Modes

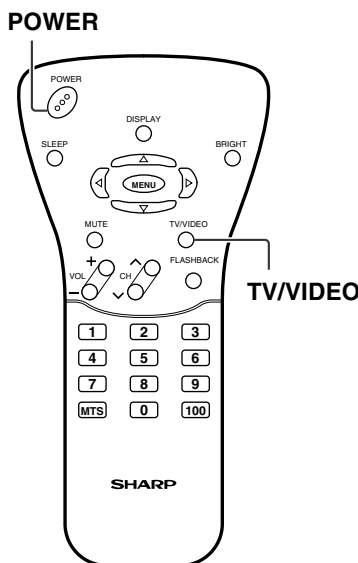

- 1 Turn on the power of the connected video equipment.
- 2 Press **TV/VIDEO** and select the applicable input source. The screen displays AV1, AV2, COMPONENT or TV mode each time **TV/VIDEO** is pressed.

Note:

- The AV input mode indication remains for 3 seconds.
- AV1: Video equipment connected to the AV1 input terminals. An S-Video input terminal is additionally provided for the AV1 input. If both the S-Video terminal and normal video terminals are connected with cables, the S-Video input terminal takes priority.
- AV2: AV2 mode is used to adjust the preset settings and IN or OUT can be selected. AV2 indication is not displayed when OUT is selected. (For details on setting AV-OUT, see page 24.)
- COMPONENT: Video equipment connected to the COMPONENT input terminals.

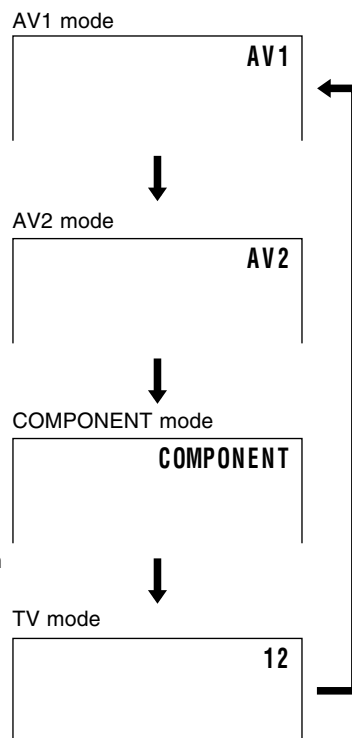

BASIC OPERATION (Continued)

Sound Volume

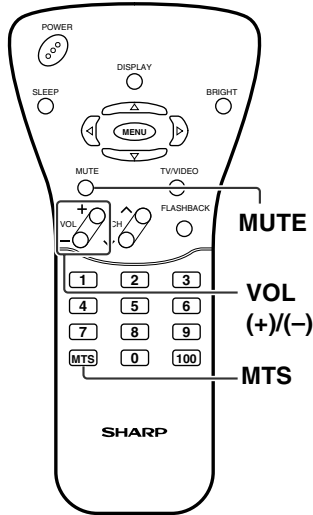

1 Press **VOL (+)** to increase the sound volume. The segment of the indicator increases.



2 Press **VOL (-)** to decrease the sound volume. The segment of the indicator decreases.



To mute the sound

1 Press **MUTE** to temporarily turn off the sound. The MUTE mark  is displayed for 4 seconds.



2 Press **MUTE** or **VOL (+)/(-)** to turn the sound back to the previous level. The mute function is automatically turned off when any of the following buttons are pressed: **POWER**, **VOL (+)/(-)**, or **MTS**.

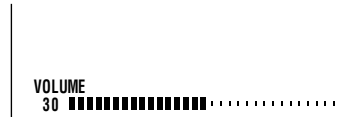

To select MTS (Multi ch TV Sound)

- Press **MTS** to display the **MTS** screen.
- Press **MTS** to select the **MTS** settings.
 [STEREO]: stereo audio
 [SAP]: second audio program
 [MONO]: monophonic audio



ON/OFF Standby

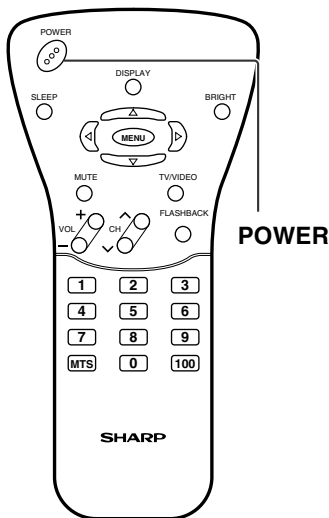

To turn off the LCD TV

Press **POWER** on the remote control. The **POWER** indicator will turn red.

To turn the LCD TV back on

Press **POWER** again. The **POWER** indicator will turn green.

BASIC OPERATION (Continued)

Changing the Channels

Changing channels by using **Channel Select** on the remote control

- This LCD TV set allows you to select up to 125 channels (1 to 125). To select a channel, enter a 2- or 3-digit number.

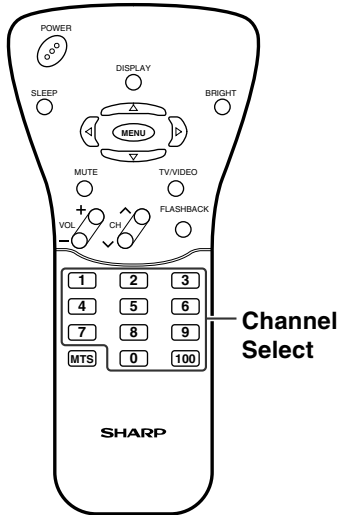

To select a 1- or 2-digit channel number (e.g., Channel 5):
Complete the following procedure within 4 seconds.

- 1 Press the **⓪** button.
- 2 Press the **⑤** button.

Note:

- When selecting a 1-digit channel number, do not fail to press the **⓪** button first.

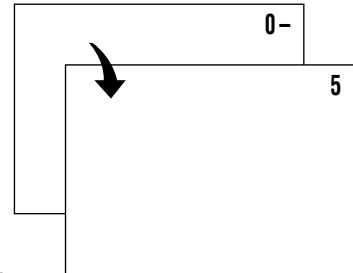

To select a 3-digit channel number (e.g., Channel 115):
Complete the following procedure within 4 seconds.

- 1 Press the **⓪** button.
- 2 Press the **①** button.
- 3 Press the **⑤** button.

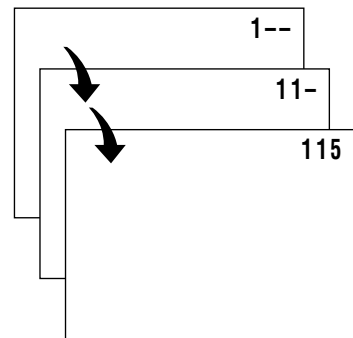

Changing channels with CH (^)/(v) on the remote control

Air Press **CH (^)** and the channels change in the order shown below:

2 → 3 → . . . → 68 → 69 → 2 → 3 → . . .

Press **CH (v)** and the channels change in the order shown below:

3 → 2 → 69 → 68 → . . . → 3 → 2 → . . .

Cable Press **CH (^)** and the channels change in the order shown below:

1 → 2 → 3 → . . . → 125 → 1 → 2 → 3 → . . .

Press **CH (v)** and the channels change in the order shown below:

3 → 2 → 1 → 125 → . . . → 3 → 2 → 1 → . . .

SELECTING MENU ITEMS

Selecting Menu Items

- This LCD TV set allows you to adjust the various settings using the menu screen. Select the desired menu item by following the steps below and then refer to the indicated page for details.

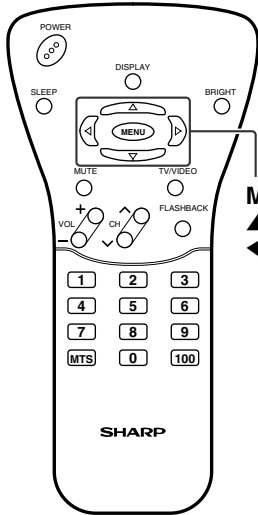

- 1 Press **MENU** to display the MENU screen.
- 2 Press **▲/▼** to select the desired menu item.
- 3 Press **◀/▶** to enter.
- 4 Press **MENU** to exit.

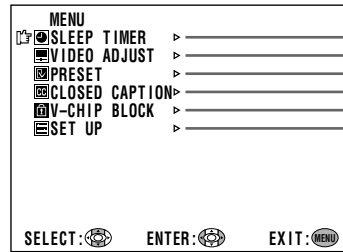

Notes:

- The TINT display only appears when the color system is set to N358 or N443 or AUTO in the NTSC mode.
- The displayed items differ depending on the setting conditions.
- The selected item changes to yellow.
- Items in magenta cannot be selected.
- TV mode
 - This product is factory set to comply with the color system in the United States (NTSC-N358). For Brazil (PAL-M), Argentina (PAL-N) and Uruguay (PAL-N), set the color system before using this product.
- COLOR SYSTEM**
 - When you set COLOR SYSTEM to AUTO, the AUTO mode automatically detects the receiving signal system and adjusts the reception system of the TV set.
 - When the picture or sound is not stable, set a specific COLOR SYSTEM (not AUTO). The picture and sound may be improved.
- To return to the previous screen, select RETURN.
- You can adjust some settings with the special buttons: SLEEP and BRIGHT (see page 19 and page 20).

(Page 19)

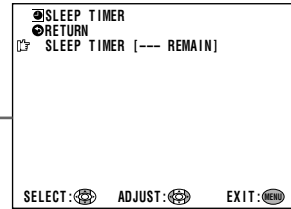

(Pages 22, 23)

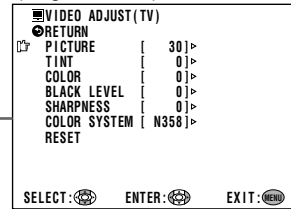

(Pages 20, 24)

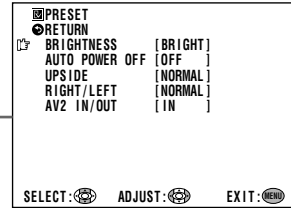

(Page 28)

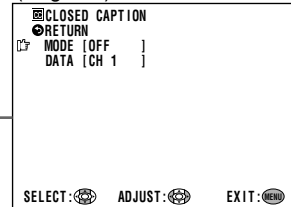

(Pages 31-34)

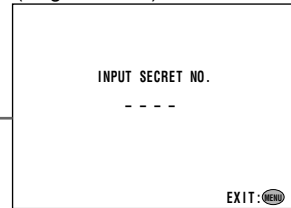

(Pages 21, 25-27)

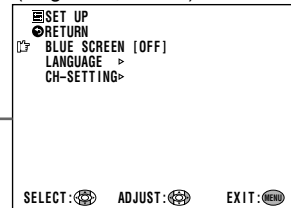

* The screen indications shown above are larger than actual for easy reading.

ADJUSTMENT

Adjusting the SLEEP TIMER Settings

You can set the SLEEP TIMER to automatically turn off the TV.

Directly setting the SLEEP TIMER

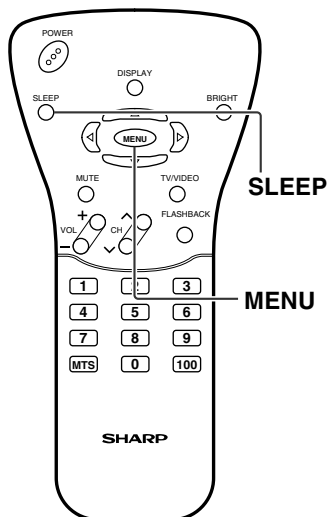

1 Press **SLEEP** to display the SLEEP TIMER screen.

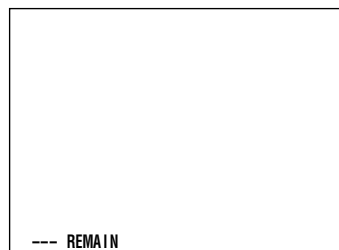

2 Press **SLEEP** to set the sleep timer (in minutes).

The time can be set in increments of 30 minutes and in the range between 30 and 120 minutes.

The SLEEP TIMER is turned off when --- is displayed.

Note:

- The SLEEP TIMER screen automatically disappears in 3 seconds.



Setting the SLEEP TIMER on the MENU screen

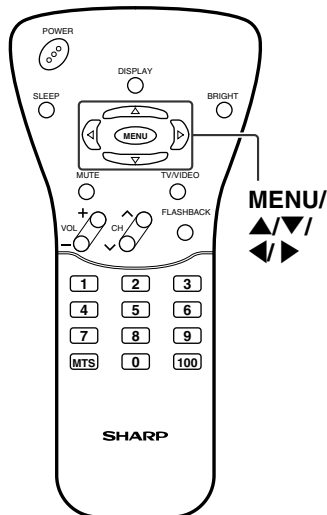

1 Press **MENU** to display the MENU screen.

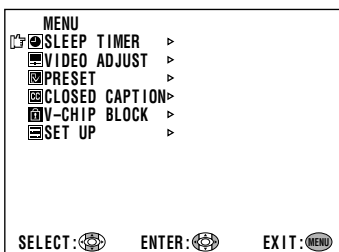

2 Press **▲/▼** to move the cursor to SLEEP TIMER.

3 Press **◀/▶** to display the SLEEP TIMER screen.

4 Press **◀/▶** to set the sleep timer (in minutes).

The time can be set in increments of 30 minutes and in the range between 30 and 120 minutes.

The SLEEP TIMER is turned off when --- is displayed.

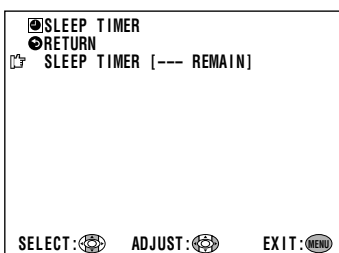

5 Press **MENU** to return to the main screen.

Notes:

- When you set the SLEEP TIMER, the SLEEP indicator lights.
- After you set the SLEEP TIMER, if you turn off the **MAIN POWER** on the TV set or press the **POWER** button on the remote control, the SLEEP TIMER setting is cancelled and the SLEEP indicator goes out.
- 5 minutes before the SLEEP TIMER turns off the TV, 5 REMAIN is displayed on the screen for 4 seconds. The SLEEP TIMER counts down and shows a similar 4-second display for each remaining minute until the timer turns off the TV.

ADJUSTMENT (Continued)

Adjusting the BRIGHTNESS Settings

You can set the brightness of the screen.

Directly setting the BRIGHTNESS

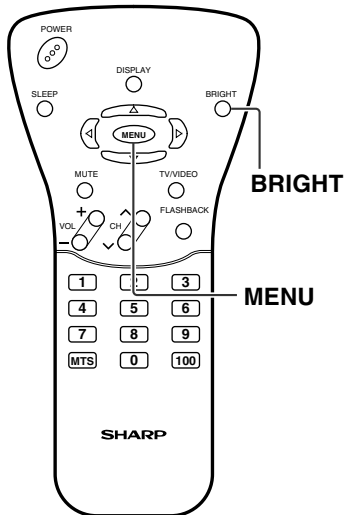

- 1 Press **BRIGHT** to display the BRIGHTNESS screen.
- 2 Press **BRIGHT** to change the setting.



Notes:

- The BRIGHTNESS screen automatically disappears in 3 seconds.
- [BRIGHT]: maximum brightness
- [NORMAL]: 60% brightness (suitable for viewing in a well-lit area and saves energy)
- [DARK]: 20% brightness (sufficiently bright when viewing in a dimly lit area)

Setting the BRIGHTNESS on the MENU screen

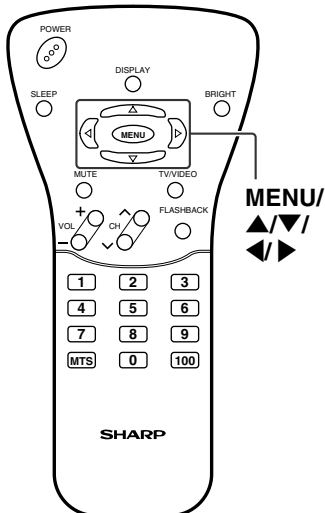

- 1 Press **MENU** to display the MENU screen.
- 2 Press **▲/▼** to move the cursor to PRESET.
- 3 Press **◀/▶** to enter.

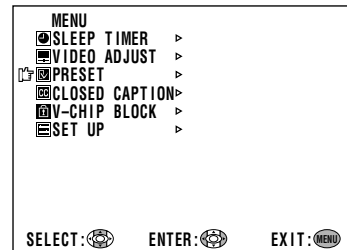

- 4 Press **▲/▼** to move the cursor to BRIGHTNESS.
- 5 Press **◀/▶** to set the brightness.
- 6 Press **MENU** to return to the main screen.

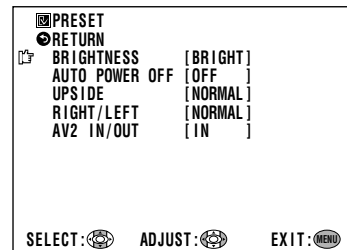



ADJUSTMENT (Continued)

Adjusting the LANGUAGE Settings

The language for the On-Screen Display can be ENGLISH, SPANISH or FRENCH.

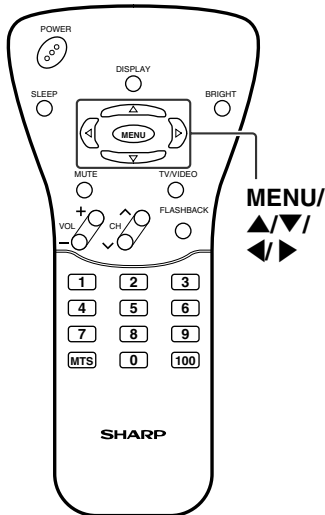

- 1 Press **MENU** to display the MENU screen.

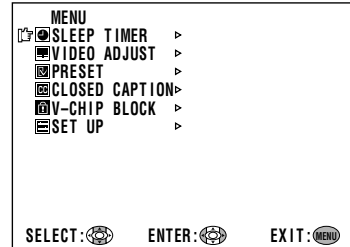

- 2 Press **▲/▼** to move the cursor to SET UP.

- 3 Press **◀▶** to enter.

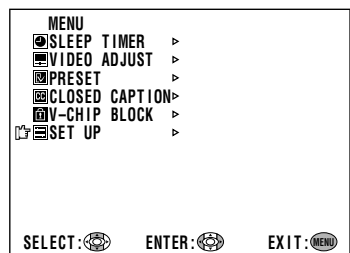

- 4 Press **▲/▼** to move the cursor to LANGUAGE.

- 5 Press **◀▶** to enter.

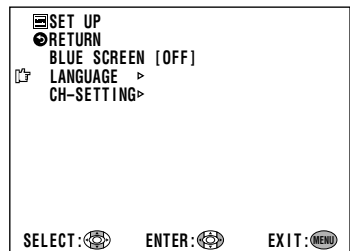

- 6 Press **▲/▼** to select the language.

- 7 Press **MENU** to return to the main screen.

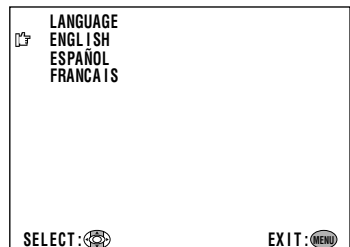

ADJUSTMENT (Continued)

Adjusting the VIDEO ADJUST Settings

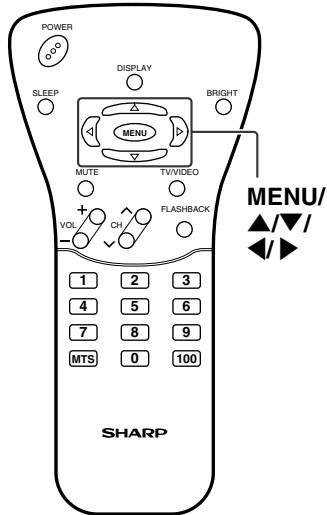

1 Press **MENU** to display the MENU screen.

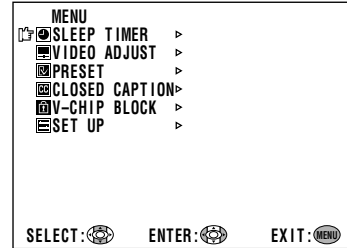

2 Press **▲/▼** to move the cursor to VIDEO ADJUST.

3 Press **◀▶** to enter.

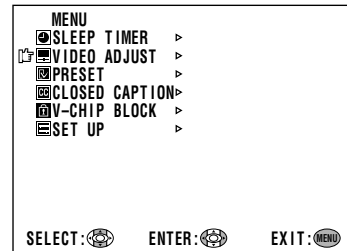

4 Press **▲/▼** to move the cursor to the desired item.

5 Press **◀▶** to enter.

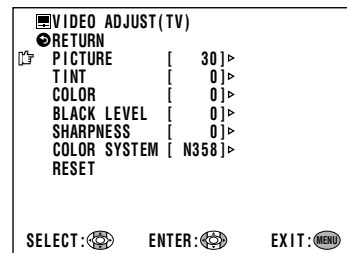

6 Press **◀▶** to change the setting.

Note:

- See page 23 for the settings.

7 Press **MENU** to return to the main screen.

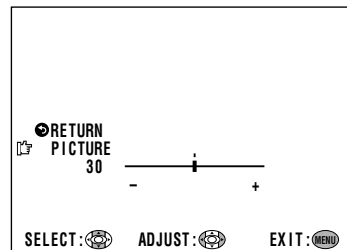



ADJUSTMENT (Continued)

Adjusting the VIDEO ADJUST Settings (Continued)

TV mode

Selected item	Press ◀.		Press ▶.
PICTURE	Decrease contrast		Increase contrast
TINT	Toward purple		Toward green
COLOR	Lower color intensity		Higher color intensity
BLACK LEVEL	Less bright		More bright
SHARPNESS	Soft picture		Sharp picture
COLOR SYSTEM	▶ N358 ↔ PAL-M ↔ PAL-N ◀		

AV mode

Selected item	Press ◀.		Press ▶.
PICTURE	Decrease contrast		Increase contrast
TINT	Toward purple		Toward green
COLOR	Lower color intensity		Higher color intensity
BLACK LEVEL	Less bright		More bright
SHARPNESS	Soft picture		Hard picture
RED-BLUE	More red level		More blue level
GREEN	Less green level		More green level
COLOR SYSTEM	Press ◀/▶ to select the COLOR SYSTEM. ▶ AUTO ↔ N358 ↔ N443 ↔ PAL ↔ PAL-M ↔ PAL-N ↔ SECAM ↔ PAL60 ◀ ■ When the COMPONENT mode is selected ▶ AUTO ↔ NTSC ↔ PAL ◀		

Notes:

- TINT is displayed only when N358 or N443 is selected.
- In BLUE SCREEN, PICTURE setting displayed in magenta cannot be selected.
- Selecting RESET will return all settings to the factory settings.
- TV mode
 - This product is factory set to comply with the color system in the United States (NTSC-N358). For Brazil (PAL-M), Argentina (PAL-N) or Uruguay (PAL-N), adjust the color system before using this product.
- COLOR SYSTEM
 - When you set COLOR SYSTEM to AUTO, the AUTO mode automatically detects the receiving signal system and adjusts the reception system of the TV set.
 - When the picture or sound is not stable, set a specific COLOR SYSTEM (not AUTO). The picture and sound may be improved.

ADJUSTMENT (Continued)

Adjusting the PRESET Settings

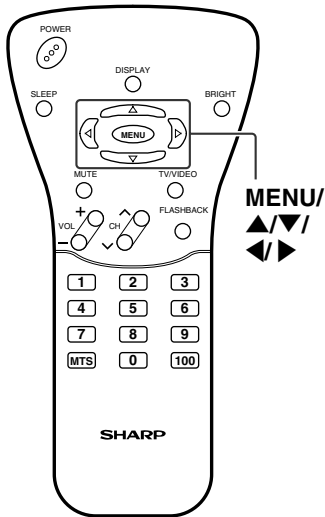

1 Press **MENU** to display the MENU screen.

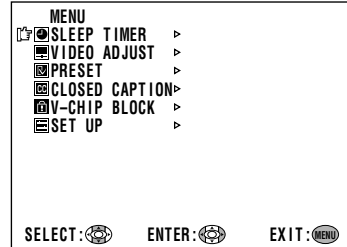

2 Press **▲/▼** to move the cursor to PRESET.

3 Press **◀▶** to enter.

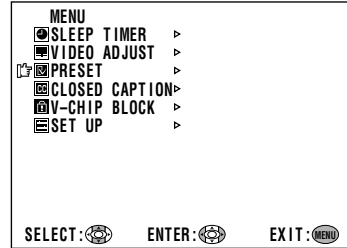



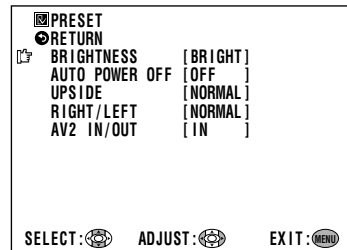

4 Press **▲/▼** to move the cursor to the desired item.

5 Press **◀▶** to change the setting.

6 Press **MENU** to return to the main screen.



Selected item	Factory setting	Setting change
BRIGHTNESS	[BRIGHT] Maximum brightness	[NORMAL] Brightness 60% → Suitable for viewing in a well-lit area. Saves energy. [DARK] Brightness 20% → Sufficiently bright when viewing in a dimly lit area.
AUTO POWER OFF (only TV mode)	[OFF]	[ON] The power of the LCD TV set is turned off when there is no signal for 5 minutes. [OFF] This feature is inactivated.
UPSIDE	[NORMAL] Normal vertical image orientation	[DOWN] Inverted image → To display images upside down for special uses. 
RIGHT/LEFT	[NORMAL] Normal horizontal image orientation	[MIRROR] Mirror image → To display mirror images for special uses. 
AV2 IN/OUT	[IN]	[OUT ] Line Output is selected, Output volume is fixed, Speaker output is available. [OUT ] Line Output is selected, Output volume is variable, Speaker output is Mute.



ADJUSTMENT (Continued)

SET UP

■ CHANNEL SETTING

It is necessary to set the receiving mode to AIR or CABLE channels to receive locally broadcast TV programs.

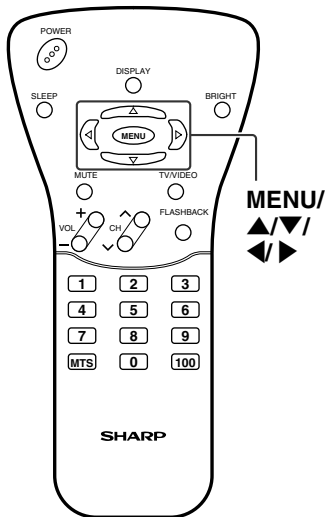

1 Press **MENU** to display the MENU screen.

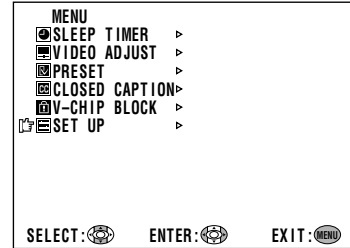

2 Press **▲/▼** to move the cursor to SET UP.

3 Press **◀▶** to enter.

4 Press **▲/▼** to move the cursor to CH-SETTING.

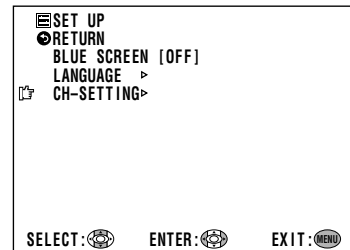

5 Press **◀▶** to enter.

6 Press **▲/▼** to move the cursor to AIR/CABLE.

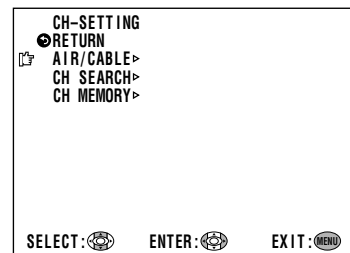

7 Press **◀▶** to enter.

8 Press **▲/▼** to move the cursor to the desired mode.

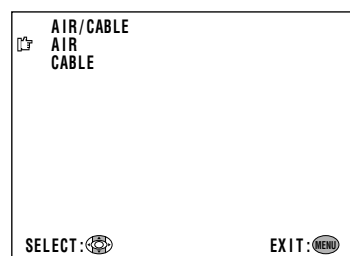

9 Press **MENU** to return to the main screen.

Note:

■ Receivable channels of your TV set are:

AIR channels:
VHF: 2 through 13.
UHF: 14 through 69.

CABLE channels:
1 (HRC and IRC mode only)
2 through 125 (STD, HRC and IRC)

ADJUSTMENT (Continued)

SET UP (Continued)

■ Saving broadcast TV channels in the memory

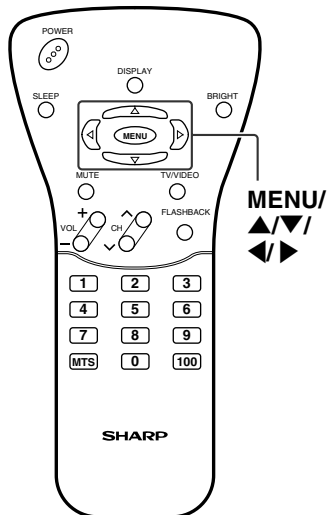

- 1 Press **MENU** to display the MENU screen, press **▲/▼** to move the cursor to SET UP, and press **◀/▶** to enter.
- 2 Press **▲/▼** to move the cursor to CH-SETTING, and press **◀/▶** to enter.
- 3 Press **▲/▼** to move the cursor to CH SEARCH, and press **◀/▶** to enter.
- 4 Press **▶**. The tuner will search through all available channels in your area and add them to the TV's memory.

Note:

- To interrupt CH SEARCH, press **◀**. CH SEARCH will stop at the current channel and will not add any higher channels.

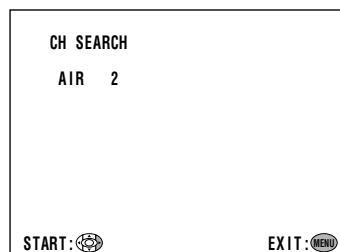
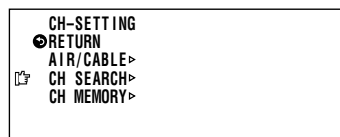

- 5 Press **MENU** to exit.

■ Adding weak or additional channels or erasing unwanted channels from TV memory

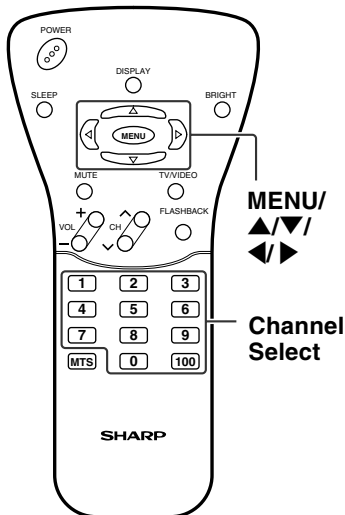

- 1 Press **MENU** to display the MENU screen, press **▲/▼** to move the cursor to SET UP, and press **◀/▶** to enter.
- 2 Press **▲/▼** to move the cursor to CH-SETTING, and press **◀/▶** to enter.
- 3 Press **▲/▼** to move the cursor to CH MEMORY, and press **◀/▶** to enter.
- 4 Use **▲/▼** or **Channel Select** to select each desired channel to add or erase.
- 5 Press **▶** to add the channel to the TV's memory or press **◀** to erase the channel from the TV's memory.
- 6 Press **MENU** to exit.

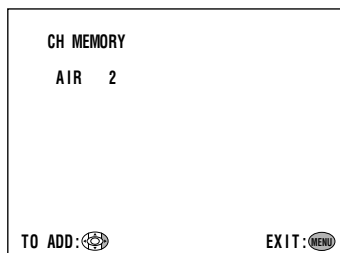
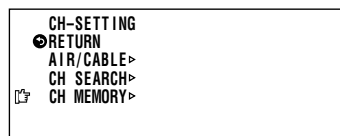

to add channel 2 to the TV memory

to erase channel 2 to the TV memory

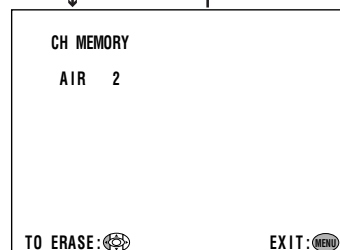

Note:

- If CH SEARCH is performed again, the previously memorized channels will be lost.



ADJUSTMENT (Continued)

Adjusting the BLUE SCREEN Settings

■ BLUE SCREEN

Automatically turns the screen blue if a broadcast signal is not received.

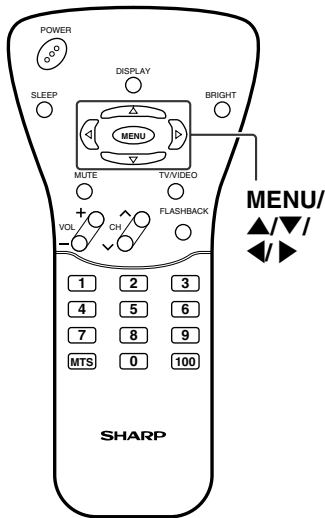

1 Press **MENU** to display the MENU screen.

2 Press **▲/▼** to move the cursor to SET UP.

3 Press **◀▶** to enter.

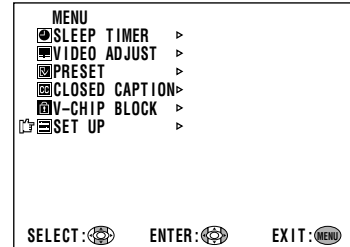

4 Press **▲/▼** to move the cursor to BLUE SCREEN.

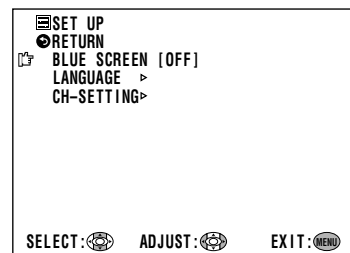

5 Press **◀▶** to select ON or OFF.

6 Press **MENU** to return to the main screen.

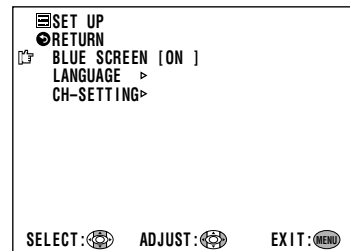

Notes:

- When received signals are weak or interfered with by some other signals, the BLUE SCREEN function may be activated. To watch the TV under such conditions, set BLUE SCREEN to OFF.
- When the AV-IN1, AV-IN2 or COMPONENT input mode is selected, if no signal is being input, the BLUE SCREEN function is activated.

ADJUSTMENT (Continued)

Adjusting the CLOSED CAPTION Settings

■ SETTING CLOSED CAPTION

- This TV set is equipped with an internal Closed Caption decoder. "Closed Caption" is a system which allows conversations, narration, and sound effects in TV programs and home videos to be viewed as captions on the TV screen (see the illustration).
- Not all the programs and videos will offer closed captioning. Please look for the "CC" symbol to ensure that captions will be shown.
- The Closed Caption broadcasts can be viewed in two modes: [CAPTION] and [TEXT]. For each mode, two channels are available: CH1 and CH2. The [CAPTION] mode shows subtitles of dialogs and commentaries of TV dramas and news programs while allowing a clear view of the picture. The [TEXT] mode displays various information over the picture (such as TV program schedules and weather forecasts, etc.) that is independent of the TV programs.

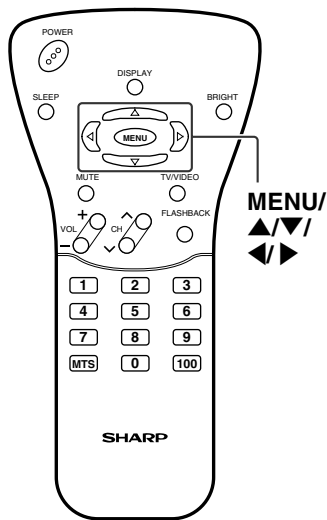

- 1 Press **MENU** to display the MENU screen.
- 2 Press **▲/▼** to move the cursor to CLOSED CAPTION.
- 3 Press **◀/▶** to enter.
- 4 Press **▲/▼** to move the cursor to MODE or DATA.

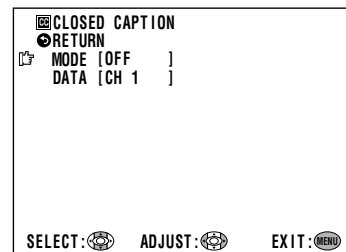
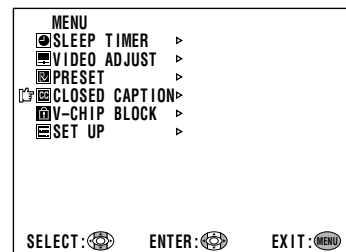

- 5 Press **◀/▶** to change the CLOSED CAPTION setting.
- 6 Press **MENU** to return to the main screen.

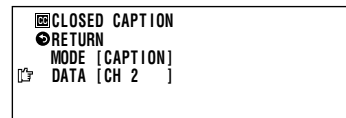
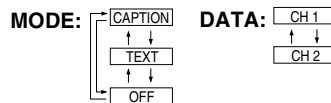
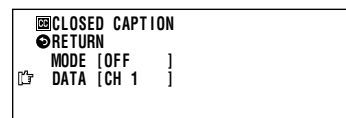

Notes:

- If a broadcast has CLOSED CAPTION and **MUTE** is pressed, the set enters [CAPTION] mode automatically. Pressing **MUTE** again will return the set to its previous condition.
- Closed Caption may malfunction (white blocks, strange characters, etc.) if signal conditions are poor or if there are problems at the broadcast source. This does not necessarily indicate a problem with your set.
- If any button is pressed to call up the On-Screen Display while viewing a Closed Caption broadcast, the closed captions will disappear momentarily.
- If no TEXT broadcast is being received while viewing in the [TEXT] mode, the screen may become dark and blank for some programs. Should this occur, switch the Closed Caption mode to OFF.

ADJUSTMENT (Continued)

Adjusting the V-CHIP Settings

■ V-CHIP

- This function allows TV programs to be restricted and TV usage to be controlled based on FCC data. It prevents children from watching violent or sexual scenes that may be harmful.
- Restriction of TV programs includes two ratings that contain information about the program: the MPAA rating and the TV Parental Guidelines. The MPAA rating is restricted by age. TV Parental Guidelines are restricted by age and content.
- Since a TV program may use either the MPAA rating or the TV Guidelines, both should be adjusted for complete control.

[1] MPAA RATING

RATING		
age base	G	GENERAL AUDIENCES. All ages admitted.
	PG	PARENTAL GUIDANCE SUGGESTED. Some material may not be suitable for children.
	PG-13	PARENTAL STRONGLY CAUTIONED. Some material may be inappropriate for children under 13.
	R	RESTRICTED. Under 17 requires accompanying parent or adult guardian.
	NC-17	NO ONE 17 AND UNDER ADMITTED.
	X	X is an older rating that is unified with NC-17 but may be encoded in the data of older movies.

MPAA RATING (examples)

Example 1:

PG-13 in the age-based rating is blocked, this will also automatically block the higher ratings R, NC-17 and X.

1. User setting

G	----
PG	----
PG-13	BLOCK
R	BLOCK
NC-17	BLOCK
X	BLOCK

2. Block table

G	not to block
PG	not to block
PG-13	Select block
R	auto-block
NC-17	auto-block
X	auto-block

Example 2:

R in the age-based rating is blocked, this will also automatically block the higher ratings NC-17 and X.

1. User setting

G	----
PG	----
PG-13	----
R	BLOCK
NC-17	BLOCK
X	BLOCK

2. Block table

G	not to block
PG	not to block
PG-13	not to block
R	Select block
NC-17	auto-block
X	auto-block

Note:

- The MPAA rating is only age-based.

ADJUSTMENT (Continued)

Adjusting the V-CHIP Settings (Continued)

[2] TV PARENTAL GUIDELINES

RATING		← content base →				
		FV (Fantasy Violence)	V (Violence)	S (Sexual Situation)	L (Adult Language)	D (Sexually Suggestive Dialog)
↑ age base ↓	TV-Y (All children)	☒	☒	☒	☒	☒
	TV-Y7 (Direct to Older Children)	×	☒	☒	☒	☒
	TV-G (General Audience)		☒	☒	☒	☒
	TV-PG (Parental Guidance Suggested)		×	×	×	×
	TV-14 (Parents Strongly Cautioned)		×	×	×	×
	TV-MA (Mature Audience Only)		×	×	×	

☒: The content rating can be set, but this rating is not normally broadcast by TV stations.

×: The content rating can be set.

TV PARENTAL GUIDELINES (examples)

Example 1:

When TV-Y7 in the age-based rating is set to BLOCK, this will automatically block the higher ratings: TV-G, TV-PG, TV-14 and TV-MA. In addition, D, L, S, V and FV in CONTENT are automatically blocked unless you manually set BLOCK CONTENT.

1. User setting

TV-Y	----
TV-Y7	BLOCK
TV-G	BLOCK
TV-PG	BLOCK
TV-14	BLOCK
TV-MA	BLOCK

BLOCK CONTENT (D L S V FV)

2. Block table

		content base				
		FV	V	S	L	D
↑ age base ↓	TV-Y					
	TV-Y7					
	TV-G					
	TV-PG					
	TV-14					
	TV-MA					

TV-Y7 Select block auto-block

Example 2:

When no item in the age-based rating is blocked, D in the content-based rating will be automatically blocked.

1. User setting

TV-Y	----
TV-Y7	----
TV-G	----
TV-PG	----
TV-14	----
TV-MA	----

BLOCK CONTENT (D)

2. Block table

		content base				
		FV	V	S	L	D
↑ age base ↓	TV-Y					
	TV-Y7					
	TV-G					
	TV-PG					
	TV-14					
	TV-MA					

auto-block

Notes:

- Age-based ratings can be modified by the content-based ratings, but only in the combinations indicated by an X in the table above.
- Choosing a lower age-based rating blocks the higher age-based ratings regardless of content rating settings.
- If you set TV-Y and TV-Y7 to BLOCK, CONTENT will display all items.

ADJUSTMENT (Continued)

Adjusting the V-CHIP Settings (Continued)

■ SETTING V-CHIP

[1] MPAA RATING

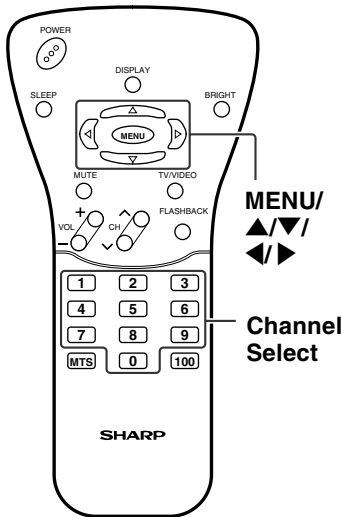

1 Press **MENU** to display the MENU screen.

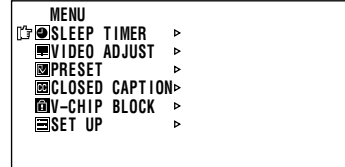

2 Press **▲/▼** to move the cursor to V-CHIP BLOCK, and press **◀/▶** to enter.

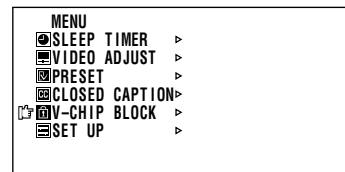

3 INPUT SECRET NO. will be displayed. Input the 4-digit secret number by using the channel select keys.

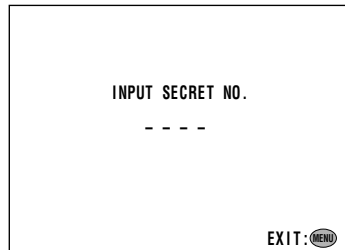

4 Press **◀/▶** to move the cursor to MPAA, and press **◀/▶** to enter.

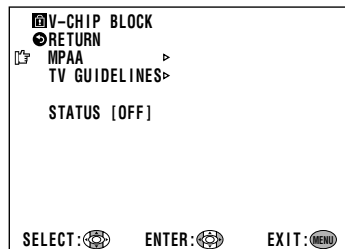

5 Press **▲/▼** to move the cursor to PG, and then press **◀/▶** to select BLOCK. If you set PG to BLOCK, PG-13, R, NC-17 and X are automatically blocked.

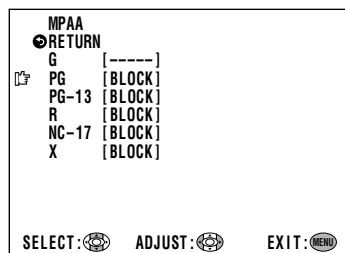

6 Press **MENU** to return to the main screen.

Notes:

- If you set G to BLOCK, all ratings are automatically blocked.
- If you set X to BLOCK, G, PG, PG-13, R and NC-17 are not blocked.

ADJUSTMENT (Continued)

Adjusting the V-CHIP Settings (Continued)

[2] TV GUIDELINES

■ Setting MPAA

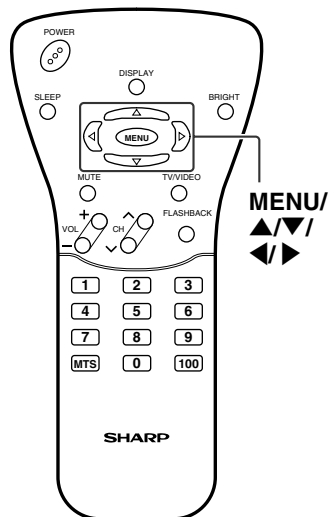

- 1 Repeat steps 1 to 3 of [1] MPAA RATING.
- 2 Press ▲/▼ to move the cursor to TV GUIDELINES.

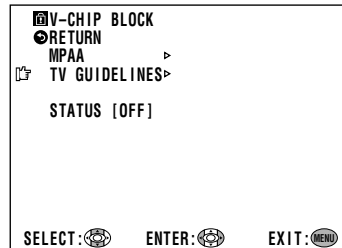

- 3 Press ◀▶ to enter.
- 4 Press ▲/▼ to move the cursor to TV-Y7, and press ◀▶ to select BLOCK. If you set TV-Y7 to BLOCK, TV-G, TV-PG, TV-14 and TV-MA are automatically blocked. In addition, D, L, S, V and FV in CONTENT are automatically blocked.

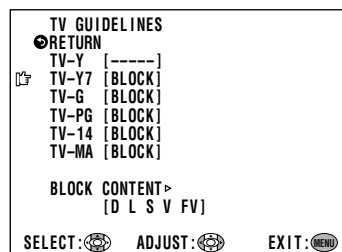

- 5 Press MENU to return to the main screen.

■ Setting BLOCK CONTENT

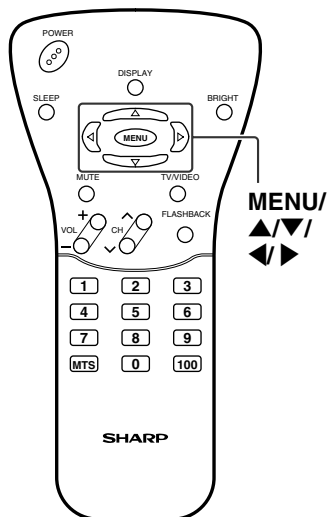

- 1 Press ▲/▼ to move the cursor to BLOCK CONTENT, and press ◀▶ to enter.

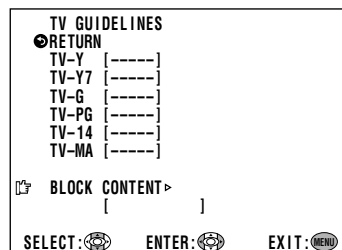

- 2 Press ▲/▼ to move the cursor to the desired item, and press ◀▶ to select BLOCK or ----- (un-block).

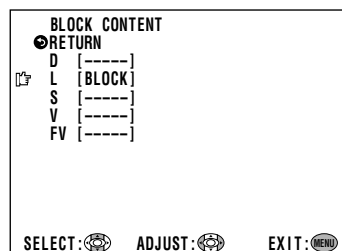

- 3 Press MENU to return to the main screen.

Note:

- If you set TV-14 to BLOCK, TV-MA is automatically blocked. contents D, L, S and V are automatically blocked by X in the table on page 30.

ADJUSTMENT (Continued)

Adjusting the V-CHIP Settings (Continued)

[3] ACTIVATE ON TO TURN ON V-CHIP BLOCK

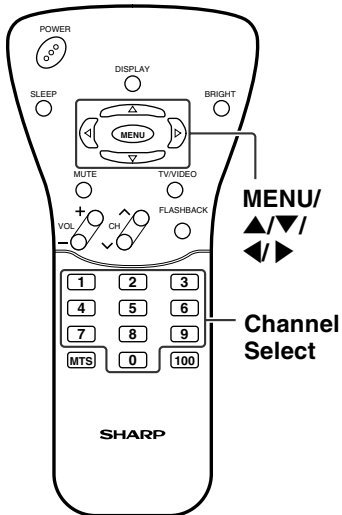

1 Press **MENU** to display the MENU screen.

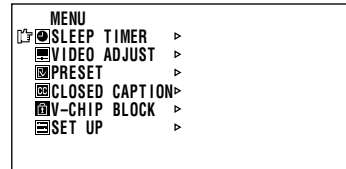

2 Press **▲/▼** to move the cursor to V-CHIP BLOCK, and press **◀/▶** to enter.

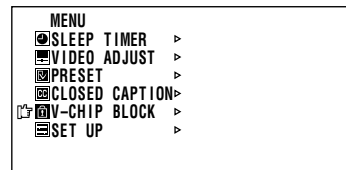

3 INPUT SECRET NO. will be displayed. Input the 4-digit secret number by using the channel select keys. (The secret number is not displayed on the screen.)

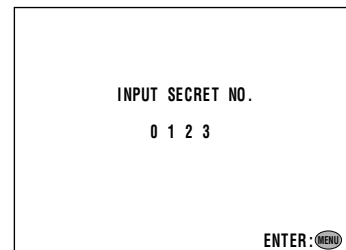

4 Press **MENU** to register the secret number.

[4] CANCELING THE V-CHIP BLOCK SCREEN WHILE V-CHIP BLOCK IS ACTIVATED

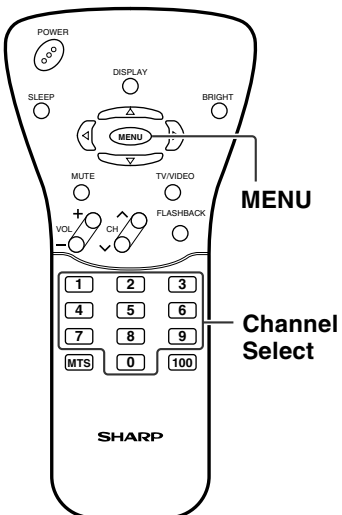

1 V-CHIP HAS BEEN ACTIVATED will be displayed if you watch the program with Program Rating data as same as you configured.



Note:

- V-CHIP HAS BEEN ACTIVATED will not be displayed if STATUS is not configured to ON.

2 Press **MENU** to display INPUT SECRET NO.

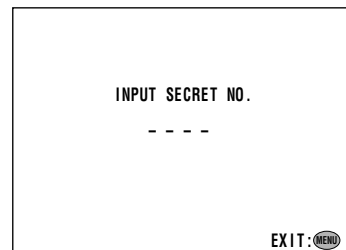

3 Input the 4-digit secret number by using the channel select keys; V-CHIP BLOCK is temporarily canceled. If you input an incorrect secret number, SECRET NO. IS INCORRECT is displayed. In this case, input the correct secret number.

Note:

- If you turn the power on from off, V-CHIP BLOCK will be activated again. If you select V-CHIP BLOCK again by using **MENU**, V-CHIP BLOCK will be turned on again.

ADJUSTMENT (Continued)

Adjusting the V-CHIP Settings (Continued)

[5] CHANGING THE V-CHIP BLOCK SETTINGS

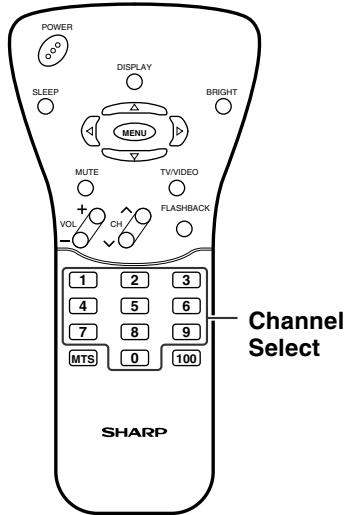

1 Repeat steps 1 to 3 of [1] **MPAA RATING**, then **INPUT SECRET NO.** will be displayed.

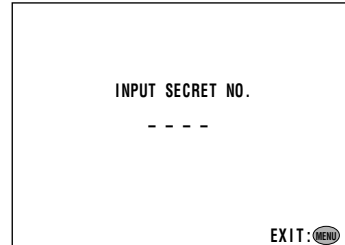

2 Input the 4-digit secret number by using the channel select keys; the V-CHIP select mode will be displayed. Set V-CHIP BLOCK again.

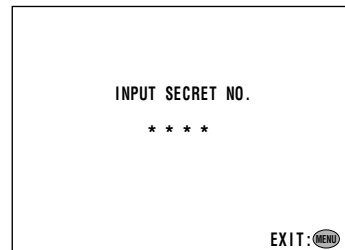

[6] CHANGING OR CLEARING THE SECRET NUMBER

If you forget the secret number, clear the secret number as follows.

Upper control panel of the main unit

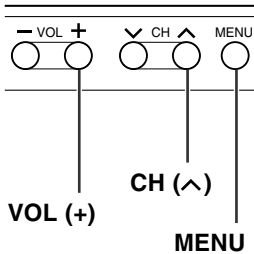

1 Repeat steps 1 to 3 of [1] **MPAA RATING**, or 1 to 2 of [4] **CANCELING THE V-CHIP BLOCK SCREEN WHILE V-CHIP BLOCK IS ACTIVATED**, then **INPUT SECRET NO.** will be displayed.

2 Press and hold both **CH (^)** and **VOL (+)** on the TV set simultaneously until the message **INPUT SECRET NO.** blinks.

3 Press **MENU** to exit.



CONNECTING WITH EXTERNAL DEVICES

You can enjoy picture and sound by connecting a VCR or a home video game system to the terminals located on the rear of the TV set.

When connecting an external device, turn off the power of the main unit first to prevent any possible damage.

Example of external devices that can be connected

- VCR
- Laser disc player

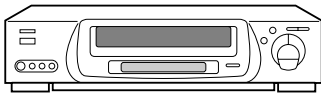

- * If your external device has an S-Video terminal, S-VIDEO connection is recommended.

To AV-IN2 terminal

- Video camera
- Home video game system

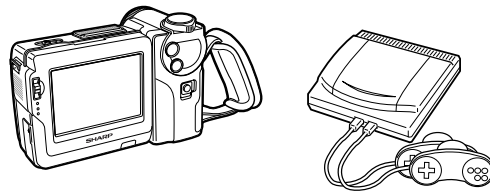

- * If your external device has an S-Video terminal, S-VIDEO connection is recommended.

To AV-IN1 terminal

- DVD, etc.

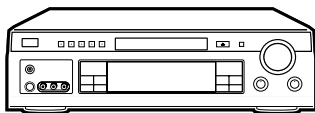

- * If your external device has a component terminal, COMPONENT connection is recommended (you can view high-quality pictures). If your external device does not have a component terminal, S-VIDEO connection is recommended.

To COMPONENT terminal

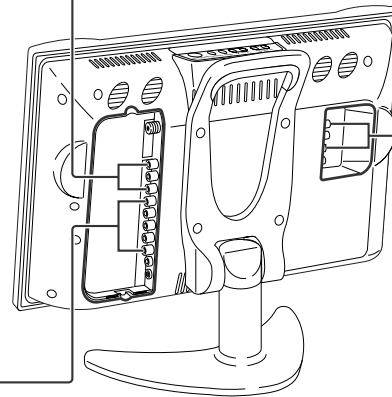

Notes:

- PC connection is not possible.
- For the cable, use a commercially available audio/video cord.
- Only connect audio/video signals to AV-IN1 and 2 terminals. Connecting other signals may result in a malfunction.
- AV-IN1 has 2 video input terminals: VIDEO and S-VIDEO. When you connect external devices to both terminals (and if you select AV-IN1), you can only view pictures from the S-VIDEO terminal. To view the picture from the VIDEO terminal, do not connect any external device to the S-VIDEO terminal.
- For more information about external device connections, see the manuals of your external devices.

CONNECTING WITH EXTERNAL DEVICES (Continued)

Connecting a VCR, DVD player or a video camera (AV-IN1/2/COMPONENT)

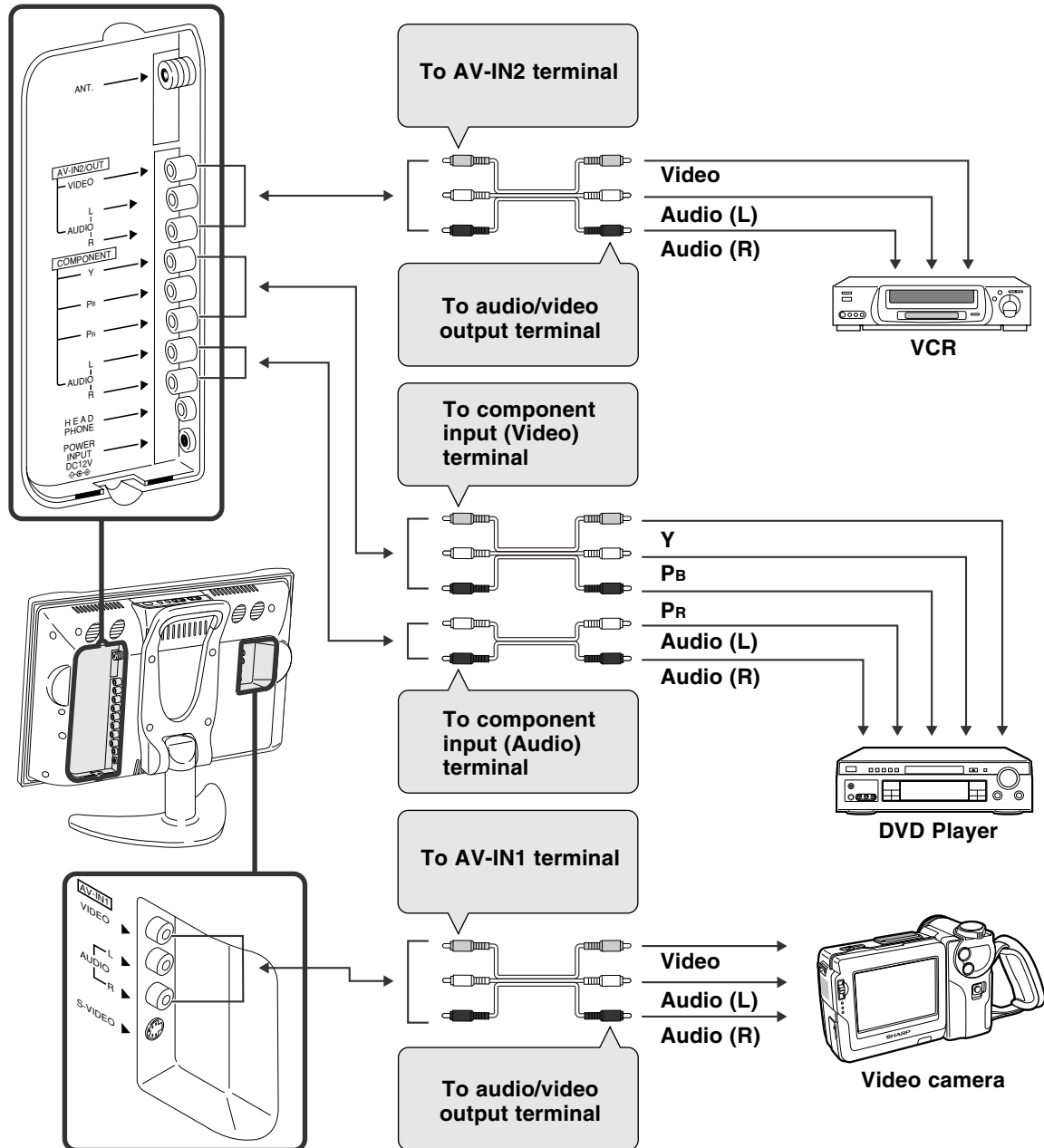

Notes:

- If your VCR (or other external devices) has an S-Video terminal, S-VIDEO connection is recommended. (Use an S-video cord.)
- When you connect external devices to both S-VIDEO and VIDEO terminals (and if you select AV-IN1), you can only view pictures from the S-VIDEO terminal.
- You cannot view multiple or synthesized pictures by connecting two or more external devices. When connecting an external device, use care to connect the video and audio cables to the corresponding terminals.
- Do not connect antennas or headphones to AV-IN2.



CONNECTING WITH EXTERNAL DEVICES (Continued)

Outputting video and audio (video output)

You can output video and audio data from the TV set through the AV output terminals (AV-OUT).

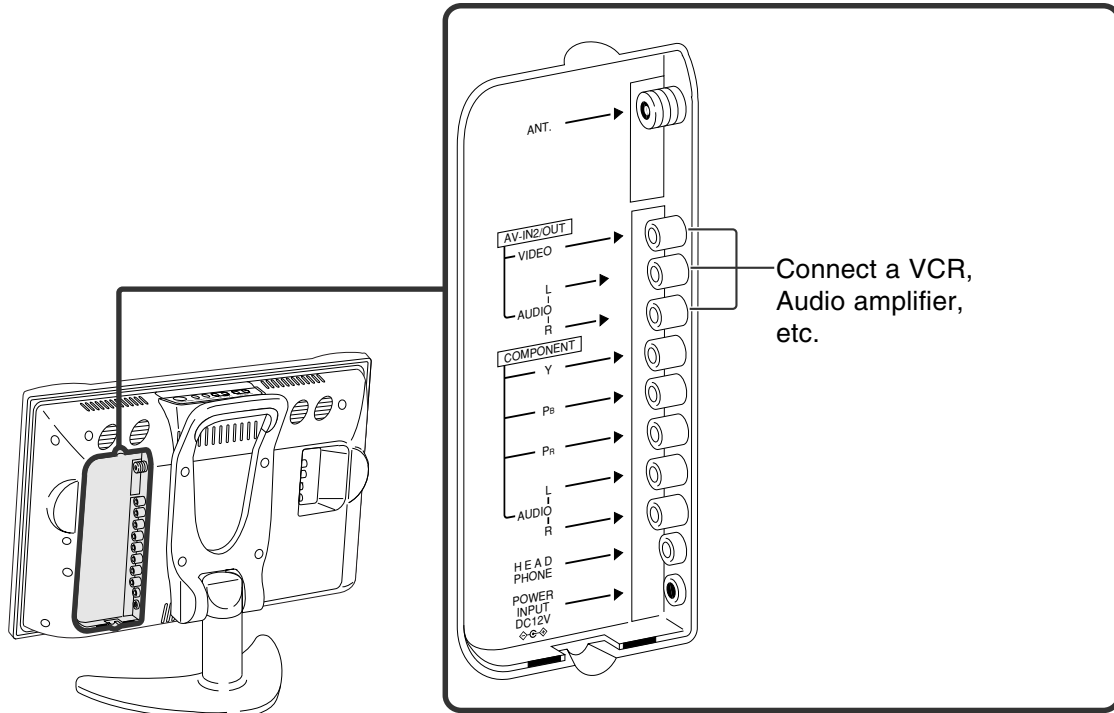

Notes:

- AV2 has 2 OUT modes (see page 24).
- When using the S-Video input for AV-IN1, no video output will be made to the AV output terminal, but audio output will be made for connection to external audio systems.

How to fix the cables



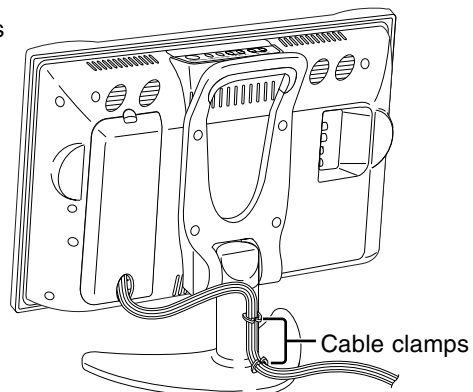

- Fix cables and cords with the attached cable clamps so that they do not get caught when mounting the cover.
- Connect the cables and cords after fixing the cable clamps (2 positions).

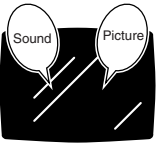
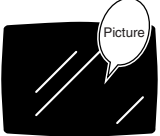

TROUBLESHOOTING

■ Before calling for repair service, check the following items for possible remedies to the encountered symptoms.

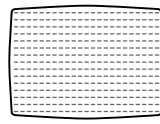
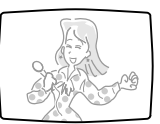

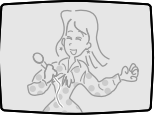

TV set

Problem	Check item	Reference Pages
 <p>There is no picture or sound.</p>	<ul style="list-style-type: none"> • Make sure the AC adapter is properly inserted in the power outlet. • Reception other than those of broadcasting stations can be considered. • Make sure the input mode is set to TV. • Make sure the main power switch of the main unit is on. 	<p>9</p> <p>15 15</p>
 <p>There is no picture. There is no picture from AV-IN 1.</p>	<ul style="list-style-type: none"> • Make sure the BLACK LEVEL is properly adjusted. • Fluorescent lamp may have reached the end of service life. • Make sure the S-Video terminal is free of connections. 	<p>22, 23 – 36</p>
 <p>There is no sound.</p>	<ul style="list-style-type: none"> • Make sure the volume is not set to minimum. • Make sure the sound is not set to mute. • Make sure that headphones are not connected. 	<p>16 16 13</p>
 <p>There is no picture or sound, just noise.</p>	<ul style="list-style-type: none"> • Make sure the antenna cable is properly connected. • Consider whether TV signals are being properly received. 	<p>9 –</p>
 <p>Picture is not clear.</p>	<ul style="list-style-type: none"> • Make sure the antenna cable is properly connected. • Consider whether TV signals are being properly received. 	<p>9 –</p>
 <p>Picture is light or improperly tinted.</p>	<ul style="list-style-type: none"> • Check color adjustment. • Check color system setting. 	<p>22, 23</p>
 <p>The picture is too dark.</p>	<ul style="list-style-type: none"> • Press the Brightness button. • Check PICTURE and BLACK LEVEL adjustment. • Fluorescent lamp may have reached the end of service life. 	<p>22, 23 40</p>
<p>Remote control does not work.</p>	<ul style="list-style-type: none"> • Check the batteries of the remote controller. • Make sure the remote sensor window is not under strong fluorescent lighting. 	<p>8 8</p>

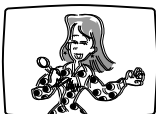

TROUBLESHOOTING (Continued)

Antenna

Problem	Check item
 <p>The picture is not sharp.</p>  <p>The picture moves.</p>	<ul style="list-style-type: none"> • The reception may be weak. • The state of the broadcast may also be bad. • Make sure the antenna is facing the right direction. • Make sure the outside antenna is not disconnected.
 <p>The picture is doubled or tripled.</p>	<ul style="list-style-type: none"> • Make sure the antenna is facing the right direction. • There may be reflected electric waves from mountains or buildings.
 <p>The picture is spotted.</p>	<ul style="list-style-type: none"> • There may be interference from automobiles, trains, high voltage lines, neon lights, etc. • There may be interference between the antenna cable and power cable. Try positioning them further apart.
 <p>There are stripes on the screen or colors fade.</p>	<ul style="list-style-type: none"> • Is the unit receiving interference from other devices? Transmission antennas of radio broadcasting stations and transmission antennas of amateur radios and cellular phones may also cause interference. • Use the unit as far apart as possible from devices that may cause possible interference.

SPECIFICATIONS

Items	Model	LC-15B2U
LCD panel		15" TFT LCD
Number of dots		921,600 dots VGA
Video color systems		N358, N443, PAL, PAL-M, PAL-N, SECAM, PAL-60
TV function	Destination	USA/Latin A/Twn
	TV Standard (CCIR)	NTSC/PAL-M/PAL-N
	TV Tuning System	PLL 181 ch.
	STEREO	MTS+SAP
	CATV	125 ch.
4-LINE COMB FILTER		Yes
Brightness		430 cd/m ²
Lamp life		60,000 hours
Viewing angles		H: 160° V: 160°
Audio amplifier		2.1 W × 2
Speakers		1-37/64 × 2-3/4 in. (4 × 7 cm), 2 pcs.
Terminals	AV1	AV-IN1, S-VIDEO-IN
	AV2	AV-IN2/AV-OUT
	COMPONENT	COMPONENT-IN, AUDIO-IN
	Antenna	F-Type
	Headphone	Mini-jack for stereo (3.5 ø)
OSD language		English/French/Spanish
Power supply		DC 12 V, AC 110–240 V, 50/60 Hz
Weight		10.2 lbs (4.6 kg), w/o accessories
Accessories		Remote control, Batteries, Antenna cable 2m, AC adapter, AC cord, Cable clamps

■ Design and specifications are subject to change without notice.



DIMENSIONAL DRAWINGS

Unit: inch/mm

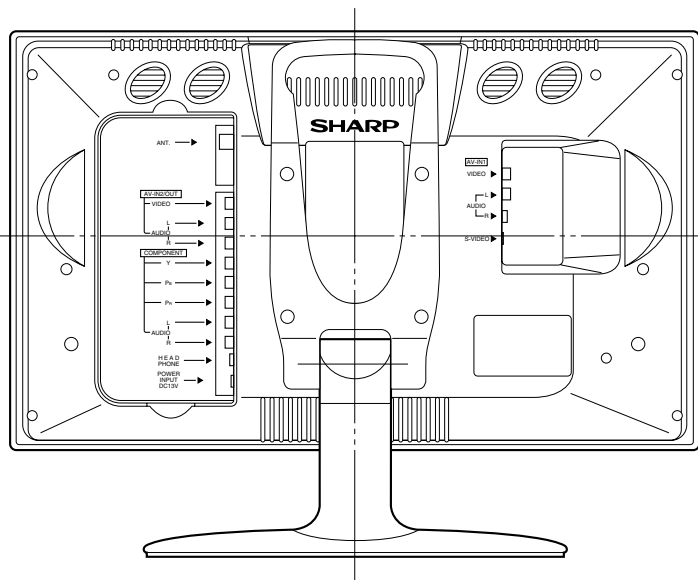
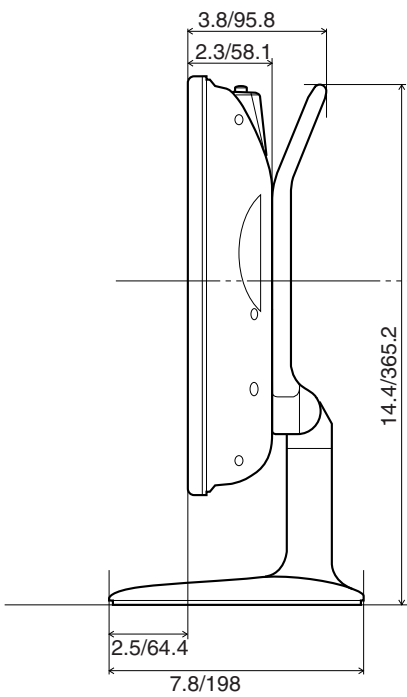
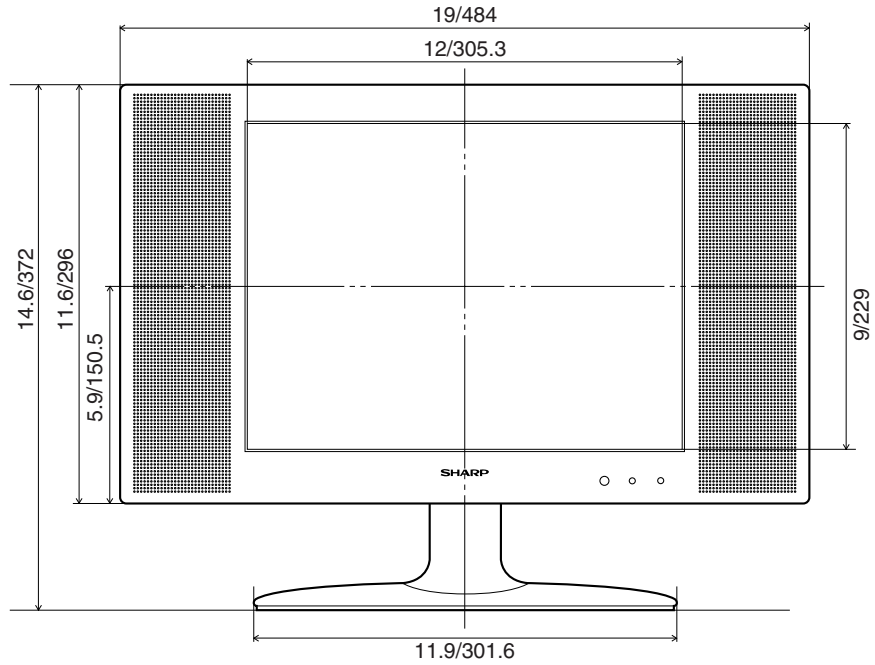

Calling for Service

For location of the nearest Sharp Authorized Service, or to obtain product literature, accessories, supplies, or customer assistance, please call 1-800-BE-SHARP.

LIMITED WARRANTY

END-USER LIMITED WARRANTY

SHARP ELECTRONICS CORPORATION warrants to the first end user purchaser that this Sharp brand product (the "Product"), when shipped in its original container, will be free from defective workmanship and materials, and agrees that it will, at its option, either repair the defect or replace the defective Product or part thereof with a new or remanufactured equivalent at no charge to the purchaser for parts or labor for the period(s) set forth below.

This warranty does not apply to any appearance items of the Product nor to the additional excluded item(s) set forth below nor to any Product the exterior of which has been damaged or defaced, which has been subjected to improper voltage or other misuse, abnormal service or handling, or which has been altered or modified in design or construction.

In order to enforce the rights under this limited warranty, the purchaser should follow the steps set forth below and provide proof of purchase to the servicer.

To the extent permitted by applicable state law, the warranties set forth herein are in lieu of, and exclusive of, all other warranties, express or implied. Specifically, ALL OTHER WARRANTIES OTHER THAN THOSE SET FORTH ABOVE ARE EXCLUDED. ALL EXPRESS AND IMPLIED WARRANTIES INCLUDING THE WARRANTIES OF MERCHANTABILITY, FITNESS FOR USE, AND FITNESS FOR A PARTICULAR PURPOSE ARE SPECIFICALLY EXCLUDED. If, under applicable state law, implied warranties may not validly be disclaimed or excluded, the duration of such implied warranties is limited to the period(s) from the date of purchase set forth below.

Neither the sales personnel of the seller nor any other person is authorized to make any warranties other than those described herein, or to extend the duration of any warranties beyond the time period described herein on behalf of Sharp.

The warranties described herein shall be the sole and exclusive warranties granted by Sharp and shall be the sole and exclusive remedy available to the purchaser. Correction of defects, in the manner and for the period of time described herein, shall constitute complete fulfillment of all liabilities and responsibilities of Sharp to the purchaser with respect to the Product, and shall constitute full satisfaction of all claims, whether based on contract, negligence, strict liability or otherwise. In no event shall Sharp be liable, or in any way responsible, for any damages or defects in the Product which were caused by repairs or attempted repairs performed by anyone other than an authorized servicer. Nor shall Sharp be liable or in any way responsible for any incidental or consequential economic or property damage. Some states do not allow limits on warranties or on remedies for breach in certain transactions; in such states, the limits herein may not apply.

Model Specific Section

<u>Your Product Model Number & Description:</u>	LC-15B2U LCD Color Television (Be sure to have this information available when you need service for your Product.)
<u>Warranty Period for this Product:</u>	One (1) year parts and labor from the date of purchase.
<u>Additional Item(s) Excluded from Warranty Coverage (if any):</u>	None
<u>Where to Obtain Service:</u>	From a Sharp Authorized Servicer located in the United States. To find the location of the nearest Sharp Authorized Servicer, call Sharp toll free at 1-800-BE-SHARP.
<u>What to do to Obtain Service:</u>	Ship prepaid or carry in your Product to a Sharp Authorized Servicer. Be sure to have Proof of Purchase available. If you ship the Product, be sure it is insured and packaged securely.

TO OBTAIN PRODUCT INFORMATION, CALL 1-888-LCD-SHARP.

SHARP®

SHARP ELECTRONICS CORPORATION

Sharp Plaza, Mahwah, New Jersey 07430-2135

Free Manuals Download Website

<http://myh66.com>

<http://usermanuals.us>

<http://www.somanuals.com>

<http://www.4manuals.cc>

<http://www.manual-lib.com>

<http://www.404manual.com>

<http://www.luxmanual.com>

<http://aubethermostatmanual.com>

Golf course search by state

<http://golfingnear.com>

Email search by domain

<http://emailbydomain.com>

Auto manuals search

<http://auto.somanuals.com>

TV manuals search

<http://tv.somanuals.com>