

SHARP®

ENGLISH

中文 (繁體)

中文 (簡體)

LC-15B5M LC-20B5M

LCD COLOUR TELEVISION
液晶顯示彩色電視機
液晶显示彩色电视机

AQUOS

OPERATION MANUAL
使用說明書
使用说明书

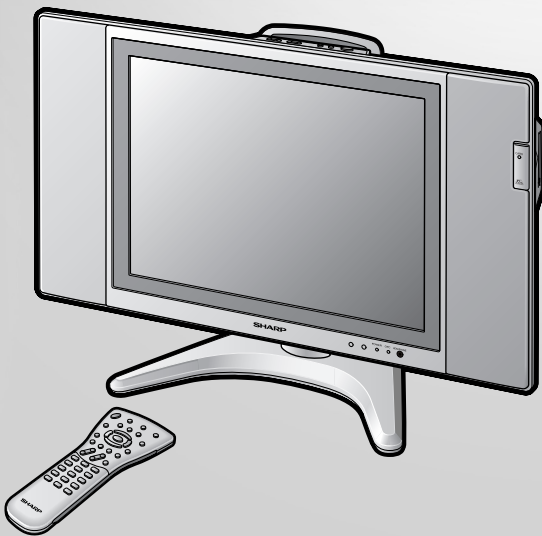

Printed on 100% post-consumer recycled paper.
本說明用紙使用的是100%的再生紙。
本說明用紙使用的是100%的再生紙。

Printed in Japan
日本印刷
日本印刷
TINS-B130WJZZ (A)
04P02-JMM

LC-15B5M LC-20B5M

LCD COLOUR TELEVISION

ENGLISH

OPERATION MANUAL

Contents

Dear SHARP customer	2	Recording/Playing Back a Memory Card	30
Important Safety Precautions	2	Recording on the Memory Card	30
Supplied Accessories	4	Playing Back the Memory Card	30
Preparation	5	Precautions when Playing Back PC Image Data on the LCD TV Set	30
Installing Batteries in the Remote Control	5	Recording on a Memory Card (Video Setup)	31
Using Remote Control	5	Rec Mode	31
Power Connection	6	Pre-Recording	31
Antenna Connection	6	Recording a TV Programme in Real-time	32
Listening with Headphones	6	Recording as a Motion Picture	32
Part Names of Main Unit	7	Easy Recording	32
How to fix the cables	8	Setting Timer Recording	33
Part Names of Remote Control	9	Adjusting the Clock	33
Basic Operation	10	Timer Rec	33
Turning On and Off the Main Power	10	Checking the Programme List	34
Standby	10	Checking the Recording Mode	35
Switching TV/VIDEO AV1/AV2/COMPONENT/ CARD/TV Mode	10	At the Set Time	35
Sound Volume	11	If There is not Sufficient Space on a Memory Card ..	35
Changing Channels	11	If Power Outage Happens/AC Cord or DC Plug at the LCD TV Set is Unplugged During Recording	35
Preset	12	Playing Back Motion Pictures (Normal Mode)	36
On-Screen Display Language Selection	12	Normal Playback	36
Presetting the Channels (AUTO)	12	Repeat	36
Presetting the Channels (MANUAL)	13	Playing Back Motion Pictures (Special Mode)	37
Channel Setting	14	Slowmotion	37
Clock Setup	14	Zoom	38
Selecting Menu Items	15	Protecting/Deleting Motion Pictures	39
Selecting Menu Items	15	Protecting Motion Picture Files	39
Basic Adjustment Settings	16	Unprotecting Motion Picture Files	39
Picture Adjustments	16	Deleting One Motion Picture File	40
Colour System (Only AV1 or AV2 mode)	16	Deleting All Motion Picture Files	40
I/P Setup	16	Playing Back Still Pictures	41
DNR (Digital Noise Reduction)	17	Listing Still Pictures (Index)	42
Film Mode	17	Displaying One Picture at a Time	42
Cool Climate	17	Slideshow Setup	43
Sound Adjustments	18	My Programme	44
On-screen Display Language Setting	18	Displaying Pictures in Slideshow in the Order Specified in "My programme"	44
AV2 In/Out	19	Rotate	45
Display Mode	19	Switching Files	45
Features	20	Audio Select	46
Timer Function	21	Recording on a Memory Card	47
NICAM Broadcast Selection	22	Shutter Click	47
A2 Stereo Broadcast Selection	23	Capturing a TV Programme in Real-time	48
Teletext	24	Capturing as Still Pictures	48
Before Using Memory Cards	26	Protecting/Deleting Still Pictures	49
Copyright	26	Protecting Still Picture Files	49
About Memory Cards	27	Unprotecting Still Picture Files	49
Commercially Available Memory Cards	27	Deleting One Still Picture File	50
Preparing a Memory Card	27	Deleting All Still Picture Files	50
Notes on Using Memory Cards and PC Card Adapters	27	Formatting the Card	51
Loading a PC Card Adapter	28	Connecting with External Devices	52
Loading a PC Card Adapter	28	Troubleshooting	55
Changing from Card Mode to the TV mode	28	Specifications	57
Inserting/Removing a PC Card	28	Time Zone Table	58
Playing Back Mode	29	Dimensional Drawings	59
Select Mode	29		

Dear SHARP customer

Thank you for your purchase of the SHARP LCD colour TV product. To ensure safety and many years of trouble-free operation of your product, please read the Important Safety Precautions carefully before using this product.

Important Safety Precautions

Electricity is used to perform many useful functions, but it can also cause personal injuries and property damage if improperly handled. This product has been engineered and manufactured with the highest priority on safety. However, improper use can result in electric shock and/or fire. In order to prevent potential danger, please observe the following instructions when installing, operating and cleaning the product. To ensure your safety and prolong the service life of your LCD colour TV product, please read the following precautions carefully before using the product.

1. Read instructions—All operating instructions must be read and understood before the product is operated.
2. Keep this manual in a safe place—These safety and operating instructions must be kept in a safe place for future reference.
3. Observe warnings—All warnings on the product and in the instructions must be observed closely.
4. Follow instructions—All operating instructions must be followed.
5. Attachments—Do not use attachments not recommended by the manufacturer. Use of inadequate attachments can result in accidents.
6. Power source—This product must operate on a power source specified on the specification label. If you are not sure of the type of power supply used in your home, consult your dealer or local power company.
7. AC cord protection—The AC cords must be routed properly to prevent people from stepping on them or objects from resting on them. Check the cords at the plugs and product.
8. Overloading—Do not overload AC outlets or extension cords. Overloading can cause fire or electric shock.
9. Entering of objects and liquids—Never insert an object into the product through vents or openings. High voltage flows in the product, and inserting an object can cause electric shock and/or short internal parts. For the same reason, do not spill water or liquid on the product.
10. Servicing—Do not attempt to service the product yourself. Removing covers can expose you to high voltage and other dangerous conditions. Request a qualified service person to perform servicing.
11. Repair—If any of the following conditions occurs, unplug the AC cord from the AC outlet, and request a qualified service person to perform repairs.
 - a. When the AC cord or plug is damaged.
 - b. When a liquid was spilled on the product or when objects have fallen into the product.
 - c. When the product has been exposed to rain or water.
 - d. When the product does not operate properly as described in the operating instructions.
Do not touch the controls other than those described in the operating instructions. Improper adjustment of controls not described in the instructions can cause damage, which often requires extensive adjustment work by a qualified technician.
 - e. When the product has been dropped or damaged.
 - f. When the product displays an abnormal condition. Any noticeable abnormality in the product indicates that the product needs servicing.
12. Replacement parts—In case the product needs replacement parts, make sure that the service person uses replacement parts specified by the manufacturer, or those with the same characteristics and performance as the original parts. Use of unauthorized parts can result in fire, electric shock and/or other danger.
13. Safety checks—Upon completion of service or repair work, request the service technician to perform safety checks to ensure that the product is in proper operating condition.
14. Wall or ceiling mounting—When mounting the product on a wall or ceiling, be sure to install the product according to the method recommended by the manufacturer.

Important Safety Precautions (Continued)

- **Cleaning**—Unplug the AC cord from the AC outlet before cleaning the product. Use a damp cloth to clean the product. Do not use liquid cleaners or aerosol cleaners.

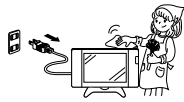

- **Water and moisture**—Do not use the product near water, such as bathtub, washbasin, kitchen sink, laundry tub, swimming pool and in a wet basement.



- **Stand**—Do not place the product on an unstable cart, stand, tripod or table. Doing so can cause the product to fall, resulting in serious personal injuries as well as damage to the product. Use only a cart, stand, tripod, bracket or table recommended by the manufacturer or sold with the product. When mounting the product on a wall, be sure to follow the manufacturer's instructions. Use only the mounting hardware recommended by the manufacturer.



- When relocating the product placed on a cart, it must be moved with utmost care. Sudden stops, excessive force and uneven floor surface can cause the product to fall from the cart.



- **Ventilation**—The vents and other openings in the cabinet are designed for ventilation. Do not cover or block these vents and openings since insufficient ventilation can cause overheating and/or shorten the life of the product. Do not place the product on a bed, sofa, rug or other similar surface, since they can block ventilation openings. This product is not designed for built-in installation; do not place the product in an enclosed place such as a bookcase or rack, unless proper ventilation is provided or the manufacturer's instructions are followed.

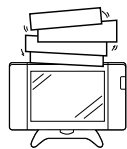

- The LCD panel used in this product is made of glass. Therefore, it can break when the product is dropped or applied with impact. Be careful not to be injured by broken glass pieces in case the LCD panel breaks.



- **Heat sources**—Keep the product away from heat sources such as radiators, heaters, stoves and other heat-generating products (including amplifiers).



- Do not place vases or any other water-filled containers on this product. The water may spill onto the product causing fire or electric shock.



- To prevent fire, never place any type of candle or naked flames on the top or near the TV set.

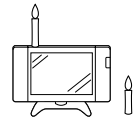

- To prevent fire or shock hazard, do not place the AC power cord under the TV set or other heavy items.

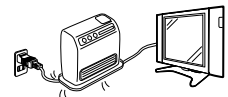

The LCD panel is a very high technology product with 921,600 thin film transistors, giving you fine picture details. Due to the very large number of pixels, a few non-active pixels may occasionally appear on the screen as a fixed point of blue, green or red. This is within product specifications and does not constitute a fault.

Supplied Accessories

Make sure the following accessories are provided with the LCD TV set.

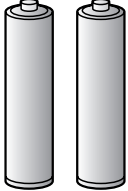
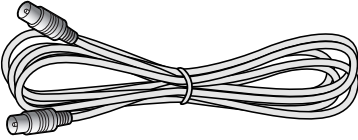
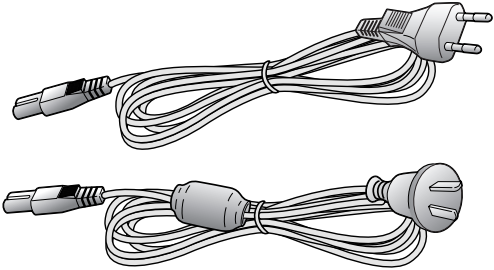
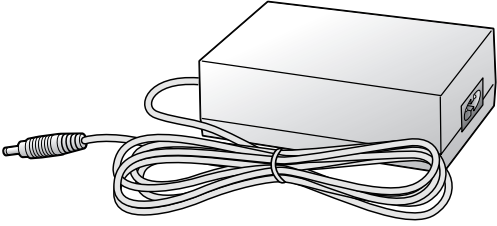
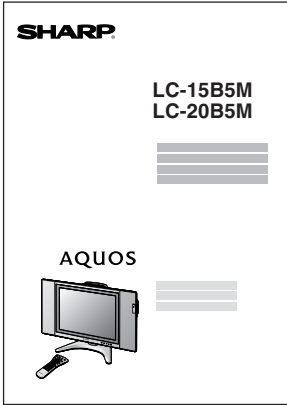
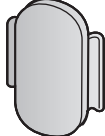
<p>Remote control</p>	<p>“AAA” size batteries (×2)</p>	
 <p>pages 5 and 9</p>	 <p>page 5</p>	
<p>Antenna cable</p>	<p>AC cord</p>	
 <p>page 6</p>	 <p>*Product shape varies in some countries.</p> <p>page 6</p>	
<p>AC adapter</p>	<p>Operation manual</p>	<p>Cable holder</p>
 <p>page 6</p>		 <p>page 8</p>

Preparation

Installing Batteries in the Remote Control

Before using the LCD TV set for the first time, install the two "AAA" size batteries supplied in the remote control. When the batteries become depleted and the remote control fails to operate, replace the batteries with new "AAA" size batteries.

1 Open the battery cover.

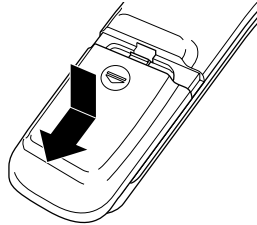

■ Slide the cover while pressing the (⇩) part.

2 Insert two "AAA" size batteries.

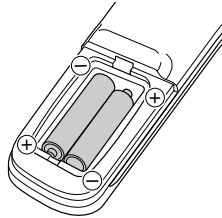

■ Place batteries with their terminals corresponding to the (+) and (-) indications in the battery compartment.

3 Close the battery cover.

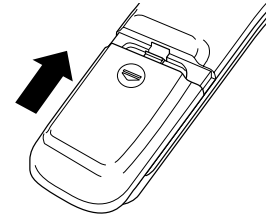

■ Engaging the lower claw with the remote control, close the cover.

⚠ Caution!

Precautions regarding batteries

- Improper use of batteries can result in a leakage of chemicals and/or explosion. Be sure to follow the instructions below.
 - Place batteries with their terminals corresponding to the (+) and (-) indications.
 - Different types of batteries have different characteristics. Do not mix batteries of different types.
 - Do not mix old and new batteries. Mixing old and new batteries can shorten the life of new batteries and/or cause old batteries to leak chemicals.
 - Remove batteries as soon as they are depleted. Chemicals that leak from batteries can cause a rash. If chemical leakage is found, wipe it off with a cloth.
 - The batteries supplied with the LCD TV set may have a shorter operating time due to storage conditions.
 - If the remote control is not to be used for an extended period of time, remove the batteries from the remote control.

Using Remote Control

- Use the remote control by pointing it towards the remote sensor window of the main unit. Objects between the remote control and sensor window may prevent proper operation.

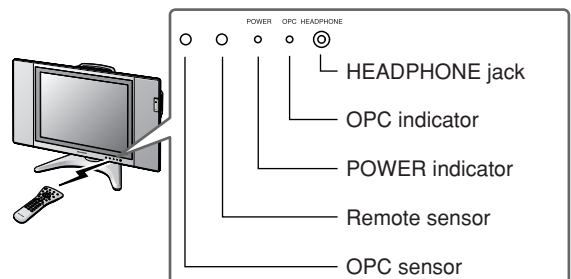

Cautions regarding use of remote control

- Do not apply shock to the remote control. In addition, do not expose the remote control to liquids, and do not place it in an area with high humidity.
- Do not install or place the remote control under direct sunlight. The heat may cause deformation of the unit.
- The remote control may not work properly if the remote sensor window is under direct sunlight or strong lighting. In such a case, change the angle of the lighting or main unit, or operate the remote control closer to the remote sensor window.

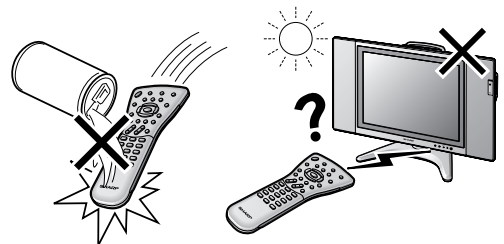

Preparation (Continued)

Power Connection

Connect to the DC input terminal of the LCD TV set.

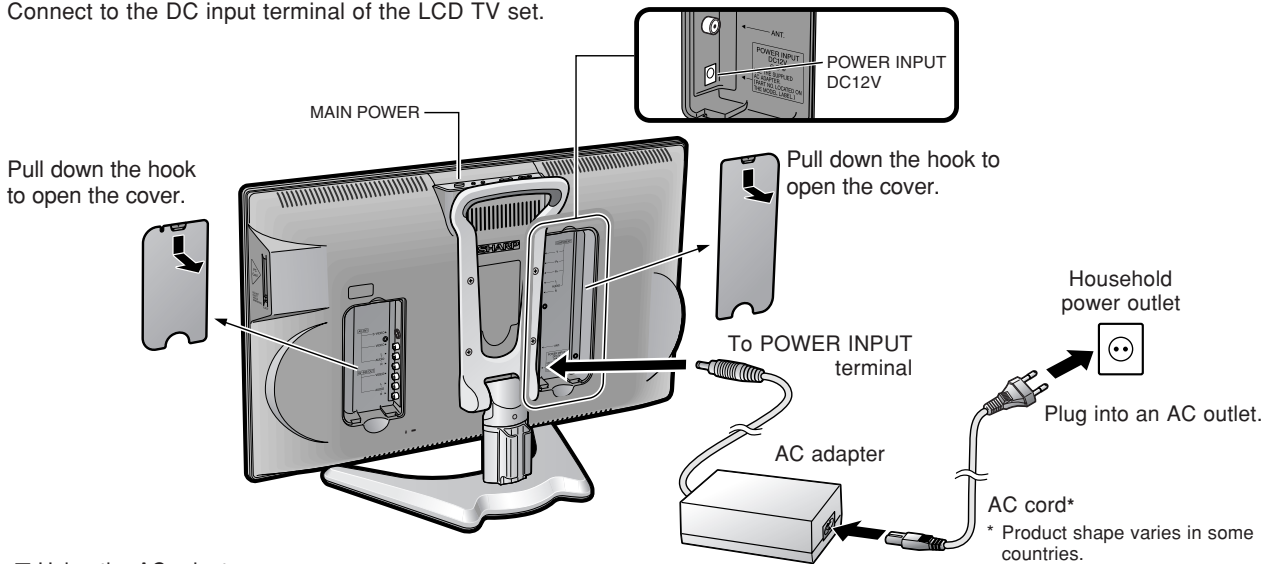

■ Using the AC adapter

- Although the AC adapter may become warm during use, this is not a malfunction.
- Do not wrap or cover the AC adapter with a blanket or similar covering. This can cause a malfunction or accident.
- Do not attempt to disassemble or modify the AC adapter. The insides of the AC adapter contain high-voltage components that can result in the risk of electrical shock.

NOTE

- Use a commercially available AC plug adapter, if necessary, depending on the design of the wall outlet.
- Always turn the **MAIN POWER** switch of the LCD TV set to OFF when connecting the AC adapter.
- Unplug the AC adapter from the LCD TV set and power outlet when the LCD TV set is not to be used for a long period of time.

Antenna Connection

- Using the supplied antenna cable, connect the room antenna terminal to the antenna terminal on the LCD TV set. (Refer to the figure below.)

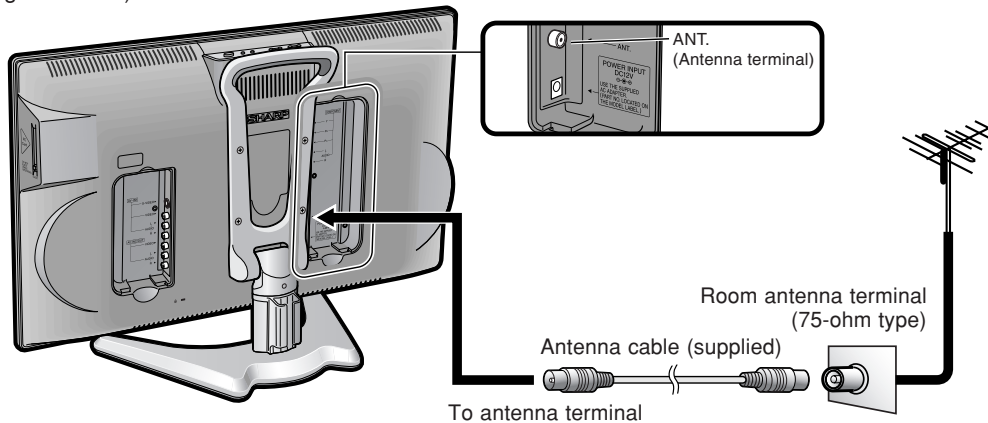

Listening with Headphones

- Plug the headphone mini-plug into the HEADPHONE jack located on the front of the LCD TV set.

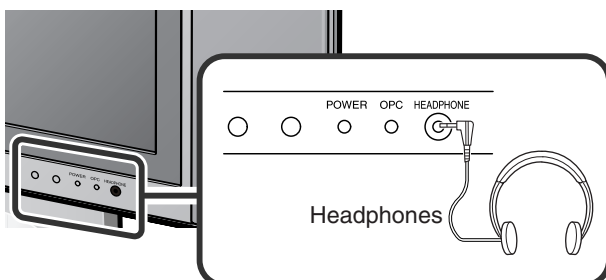

NOTE

- Headphones are not included in the supplied accessories.
- No sound is heard from the main unit speakers when a headphone mini-plug is connected into the HEADPHONE jack.

▼ On-screen display

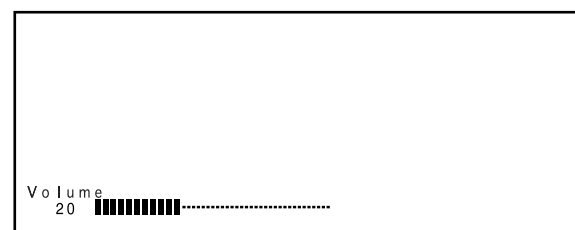

Adjust the sound volume using VOL (+)/(-).

Part Names of Main Unit

Controls

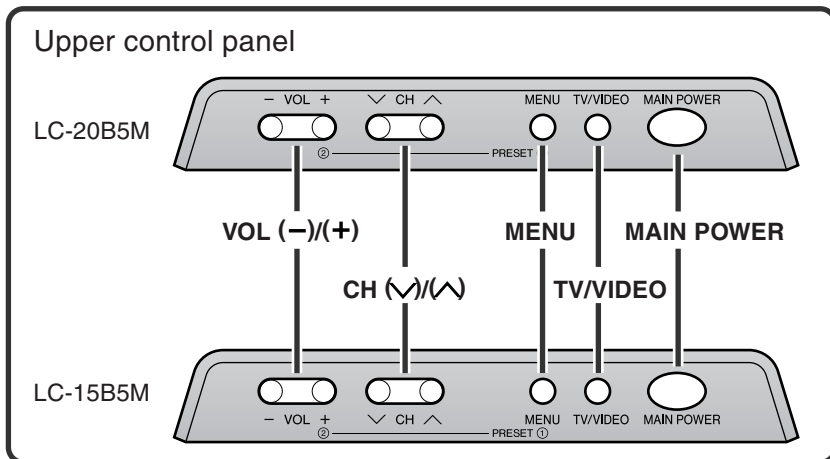

How to adjust the angle

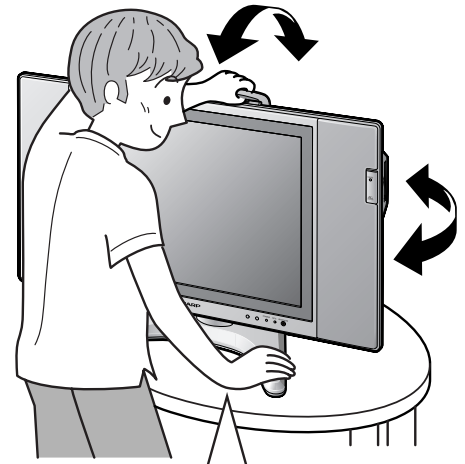

Tilt the display by grabbing onto the carrying handle while securely holding down the stand with your other hand.

To change the vertical angle of the LCD TV set, tilt the screen up to 5 degrees forward or 10 degrees backward. The LCD TV set can also be rotated up to 25 degrees to right and left. Please adjust the angle so that the LCD TV set can be watched most comfortably.

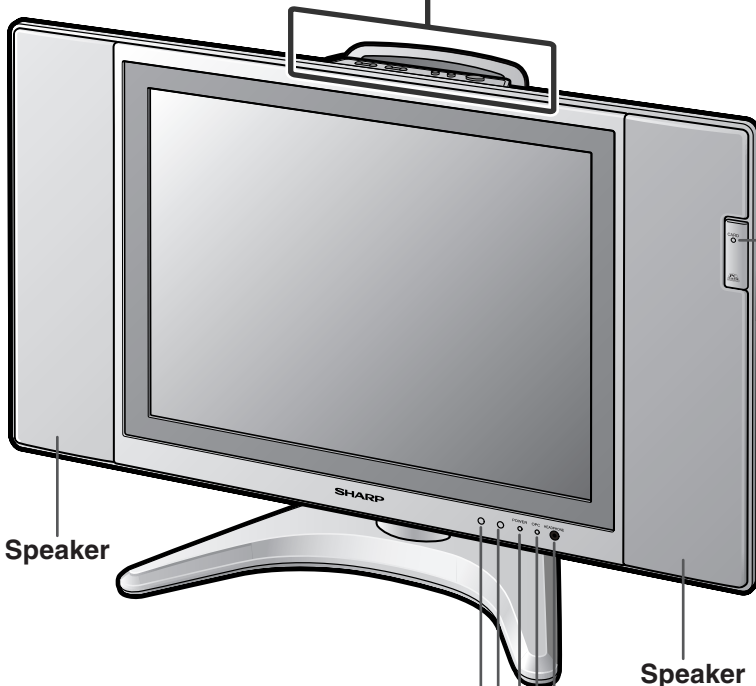

Card Lamp

When timer recording is set: Orange
When recording: Red
Standby: Green

PC Card Slot

OPC sensor

Remote sensor

Speaker

HEADPHONE jack

Plug the headphone mini-plug into the Headphone jack located on the front of the LCD TV set. (See page 6.)

OPC indicator (Optical Picture Control)

The Optical Picture Control indicator lights up green when the "Backlight" is set to "Auto (OPC)". (See page 20.)

POWER indicator

POWER indicator lights up green when the power is on, and red when in the standby mode (the indicator will not light when the main power is off). The indicator lights up orange when the wake-up timer is set.

* The examples used throughout this manual are based on the LC-20B5M model.

NOTE

- TV/VIDEO, CH (v)/(^), VOL (-)/(+) and MENU on the main unit have the same functions as the same buttons on the remote control. Fundamentally, this operation manual provides a description based on operation using the remote control.

Part Names of Main Unit (Continued)

Terminals

Rear View

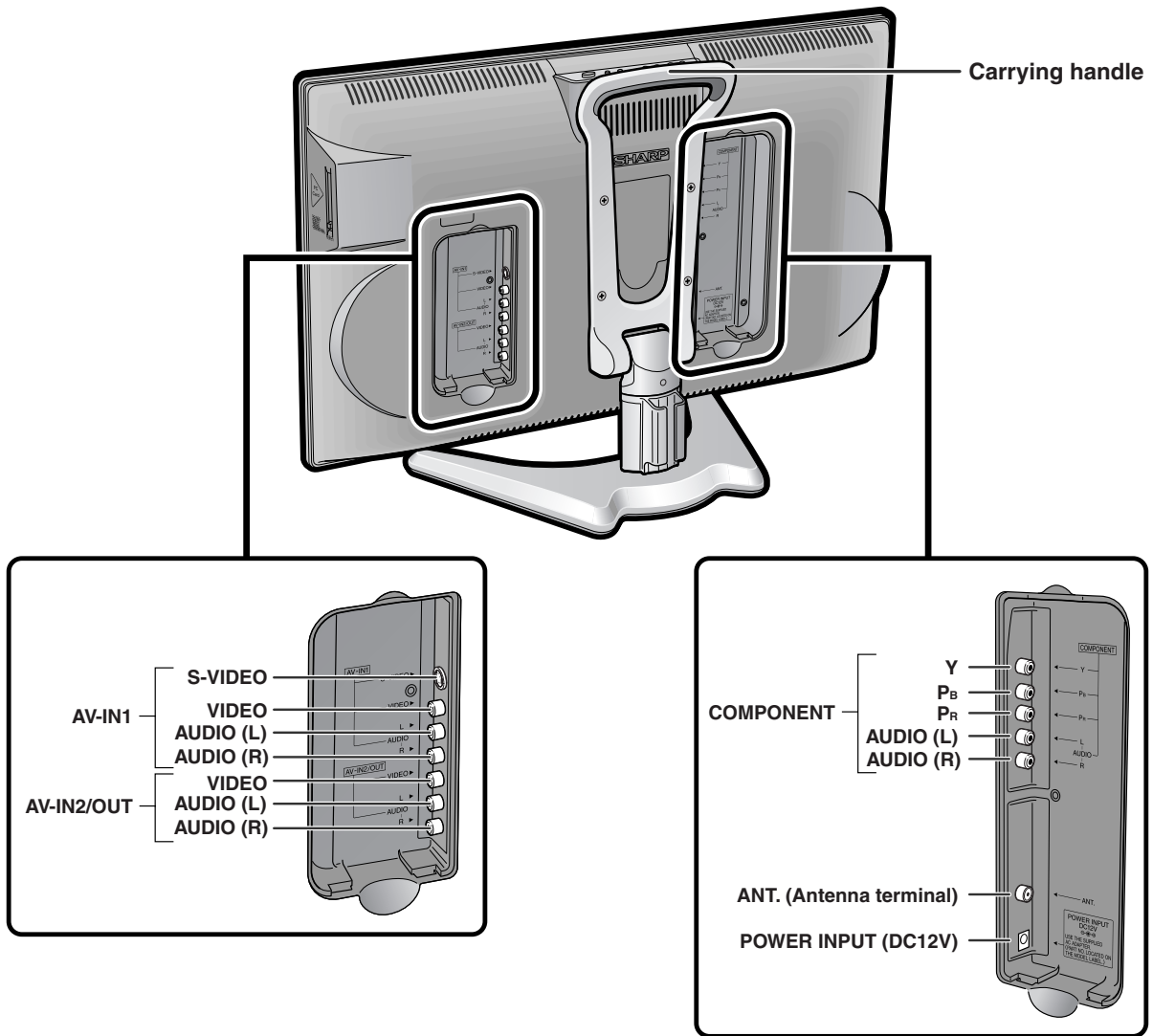

How to fix the cables

- Pull the cables connected to each terminal through the holes and close the left and right terminal covers. Push the cables into the grooves of the support covers. Insert the cable holder (supplied) from above the support cover and fix the cables.

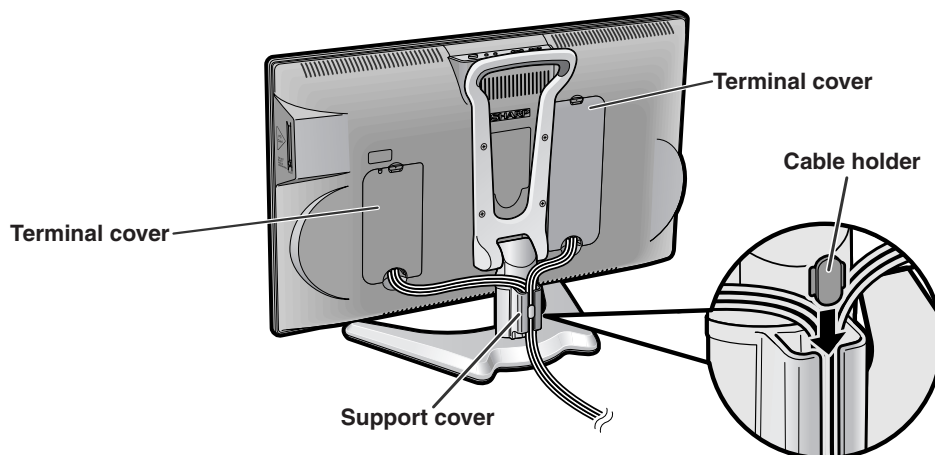

Part Names of Remote Control

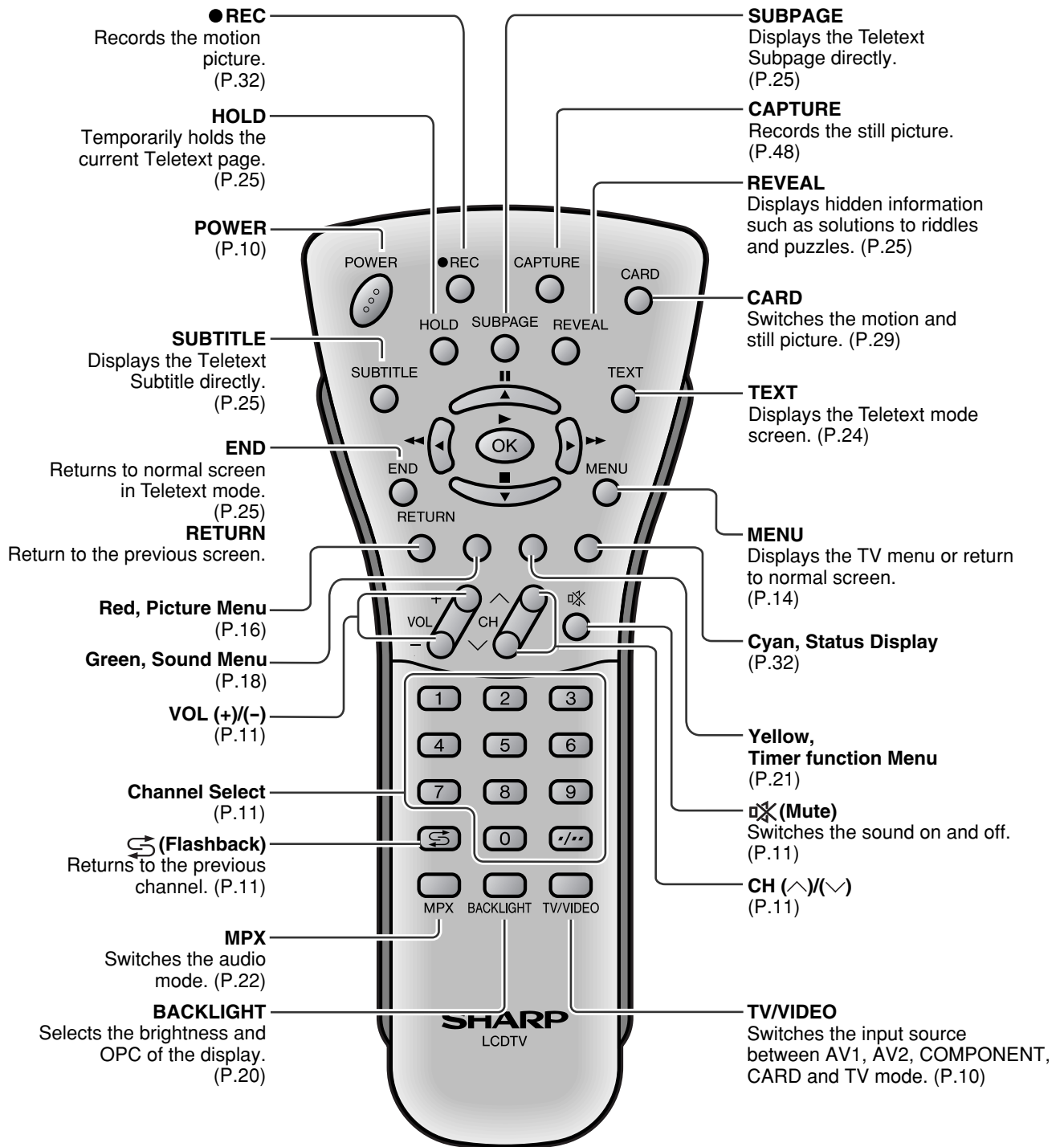

How to use the cursor during the motion picture playback

Move the cursor to the left (Select the menu items)/
Fast Reverse (Fast reverses the picture)

OK (Set the menu or items by selecting the cursor)/
Play (Playback the card)

Move the cursor to the upwards (Select the menu items)/
Still (Pause the motion picture playback or card recording)

Move the cursor to the right (Select the menu items)/
Fast Forward (Fast forwards the picture)

Move the cursor to the downwards (Select the menu items)/
Stop (stop the motion picture playback or card recording)

Basic Operation

Turning On and Off the Main Power

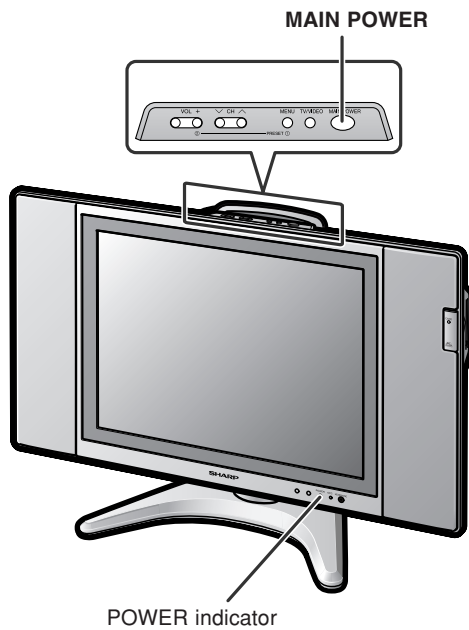

- Press **MAIN POWER**. The POWER indicator instantly changes from blinking red to green and the LCD TV set is turned on.

On-screen display



NOTE

- The On-screen display disappears after a few seconds.

- To turn off the main power, press **MAIN POWER**.

Standby

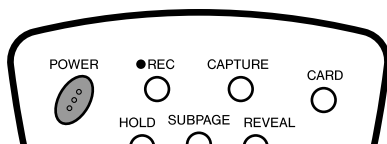

To turn off the LCD TV

Press **POWER**. The POWER indicator will turn red.

To turn the LCD TV back on

Press **POWER** again. The POWER indicator will turn green.

Switching TV/VIDEO AV1/AV2/COMPONENT/CARD/TV Mode

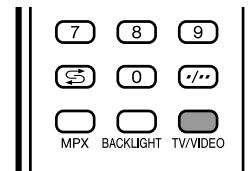

- 1 Turn on the power of the connected video equipment.
- 2 Press **TV/VIDEO** to select the applicable input source. The screen changes in order of AV1, AV2, COMPONENT, CARD and TV mode each time **TV/VIDEO** is pressed.

AV1 mode

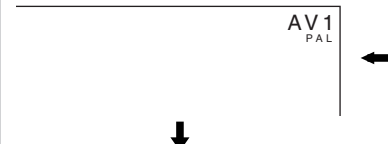

AV2 mode



COMPONENT mode

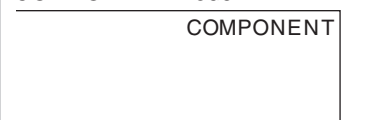

CARD mode



TV mode



NOTE

- AV input mode indication remains for 5 seconds.
- AV1: Video equipment connected to the AV1 input terminals. The S-video input terminal is additionally provided for the AV1 input. If both S-video terminal and normal video terminals are connected with cables, the S-video input terminal takes priority.
- AV2: AV2 mode is used to adjust the preset settings and IN or OUT can be selected. AV2 indication is not displayed when OUT is selected. (For details on setting AV-OUT, see page 19.)
- COMPONENT: Video equipment connected to the COMPONENT input terminals.
- CARD: Select this when running a memory card. (STILL INDEX will be displayed when still picture mode and VIDEO INDEX will be displayed when motion picture mode.)

Sound Volume

■ To adjust the volume

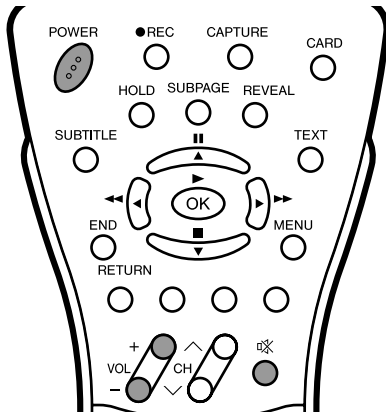

- Press **VOL (+)** to increase the sound volume. The numerical value increases.



- Press **VOL (-)** to decrease the sound volume. The numerical value decreases.



■ To mute the sound

- Press **Mute** to temporarily turn off the sound. The MUTE mark is displayed on the screen.



- Press **Mute** or **VOL (+)/(-)** to turn the sound back to the previous level. MUTE is automatically cleared when one of the following buttons are pressed: **POWER**, **VOL (+)/(-)** or **Mute**.



Changing Channels

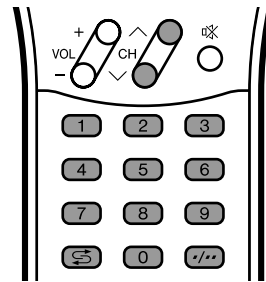

You can select channels using **Channel Select** or **CH (^)/(v)**.

- To handle the increasing number of channels available, this LCD TV set allows you to select up to 100 positions (Channels 0 to 99). One-digit and two-digit methods of selection can be used. Follow the procedure shown below to select channels.

■ Using Channel Select

To select a one-digit channel (e.g., Channel 5):

- 1 Press **5** of **Channel Select**.
- 2 If "5-" is indicated and the picture does not change, press **-/-** to switch over to the 1-digit select mode and press **5** of **Channel Select**.



To select a two-digit channel (e.g., Channel 15):

- 1 Press **-/-** to set the 2-digit select mode.
- 2 Press **1** of **Channel Select**.
- 3 Press **5** of **Channel Select**.



NOTE

- Complete this procedure within 4 seconds, otherwise the selection will not be made.

Changing channels with CH (^)/(v) on the remote control.

Press **CH (^)** and the channels change in the order shown below:
 1 → 2 → 3 → ... → 98 → 99 → 0 → 1 → 2 → 3 → ...
 Press **CH (v)** and the channels change in the order shown below:
 3 → 2 → 1 → 0 → 99 → 98 → ... → 3 → 2 → 1 → ...

■ Using **FLASHBACK**

- Press **FLASHBACK** to switch the currently tuned channel to the previously tuned channel.
- Press **FLASHBACK** again to switch back to the currently tuned channel.

Preset

On-Screen Display Language Selection

MENU on the LCD TV set can also be used to select the language.

Upper control panel

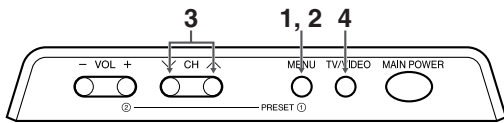

- 1 Press **MENU** (PRESET-①) on the upper part of the LCD TV set for more than 2 seconds to display the PRESET mode screen.



- 2 Press **MENU** (PRESET-①) twice to display the LANGUAGE select mode screen. Press **MENU** (PRESET-①) again to change the PRESET mode as shown below.

AUTO → MANUAL → LANGUAGE → NORMAL SCREEN

NOTE

- Instead of pressing **MENU** for more than 2 seconds, you can display the LANGUAGE select mode by selecting **Setup → Language** on the Menu screen (see page 18).

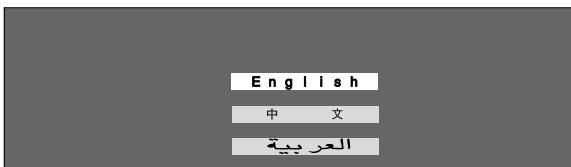

- 3 Press **CH** (∨)/(∧) to select the language you wish to display.
- 4 Press **TV/VIDEO** to return to the normal screen.

Presetting the Channels (AUTO)

Automatically tunes in and presets receivable TV stations. Make sure the antenna cable is properly connected.

Upper control panel

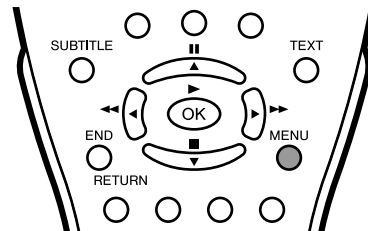
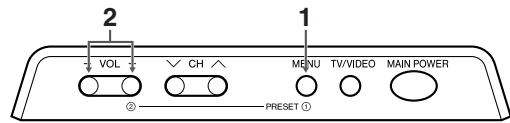

- 1 Press **MENU** (PRESET-①) on the upper part of the LCD TV set for more than 2 seconds. The AUTO mode screen appears.

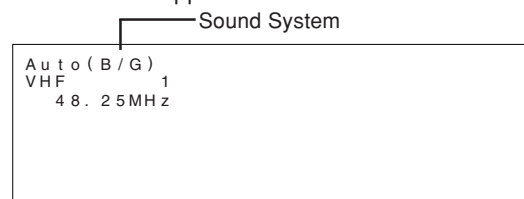

- 2 Press **VOL** (-)/(+) (PRESET-②) on the upper part of the LCD TV set. All the TV stations in your area that can be received by the LCD TV set are automatically preset.

- 3 The screen shows whatever is on channel 1 when full auto channel preset is finished.



NOTE

- When starting PRESET after setting the SOUND SYSTEM with **MENU** of the Remote Control, the SOUND SYSTEM for all channels are stored into memory.
- Unused channels are automatically skipped.
- The Preset mode is only available in the TV mode and cannot be operated in the AV mode.

Presetting the Channels (MANUAL)

- Setting a channel to a desired TV station:

Upper control panel

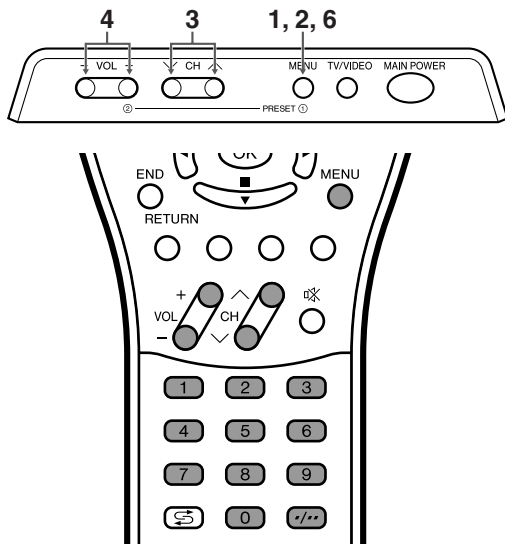

- 1 Press **MENU** (PRESET-①) on the upper part of the LCD TV set for more than 2 seconds. The AUTO mode screen appears.

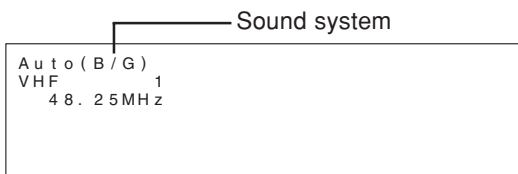

- 2 Press **MENU** (PRESET-①) to display the MANUAL mode screen. Press **MENU** (PRESET-①) again to change the MANUAL mode as shown below.

AUTO → MANUAL → LANGUAGE → NORMAL SCREEN

- 3 Select the channel position using **Channel Select** or **CH** (^)/(v).

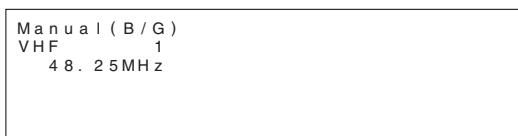

- 4 Press **VOL** (+)/(-) to locate the channel you want to preset to the position. Search is initiated and when a TV signal is received during the search, the search stops.

- 5 Repeat steps 3 and 4 above, to preset the channel positions for other broadcasts, etc.



- 6 Press **MENU** (PRESET-①) to return to the normal screen.

NOTE

- SYSTEM may not have been set correctly, if noise can be heard or if there is no sound. In such case, reset to "Sound system" using **MENU** (See page 14).

- In a weak reception area, or under bad reception conditions.

Upper control panel

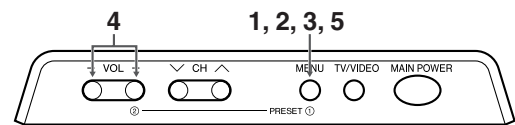

- 1 Press **MENU** (PRESET-①) on the upper part of the LCD TV set for more than 2 seconds. The AUTO mode screen appears.
- 2 Press **MENU** (PRESET-①) to display the MANUAL mode screen.
- 3 While the MANUAL mode screen is displayed, press **MENU** (PRESET-①) for more than 2 seconds. The channel position number remains in green.
- 4 Adjust for good reception using **VOL** (+)/(-).
- 5 After finishing the adjustment, press **MENU** (PRESET-①) to continue channel presetting.

NOTE

- While the MANUAL mode screen is displayed, press **MENU** (PRESET-①). (The LANGUAGE mode screen will appear.)

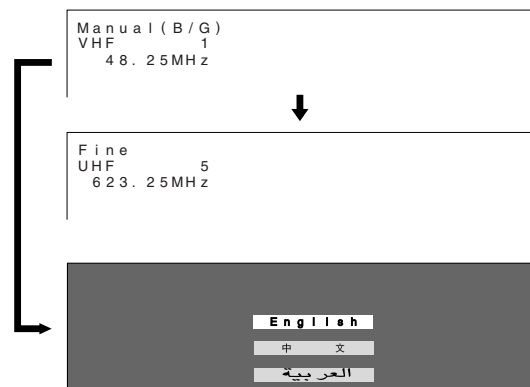

Preset (Continued)

Channel Setting

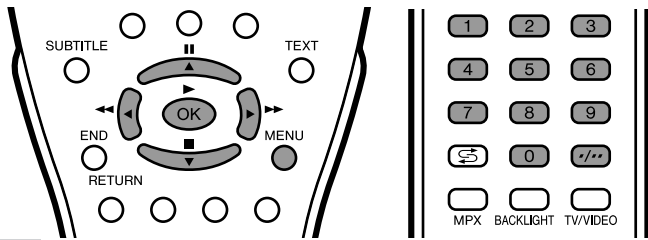

- 1 Press **MENU** to display the MENU screen.
- 2 Press **◀▶** to select "Setup".
- 3 Press **▲▼** to select "CH setup", and press **OK**.

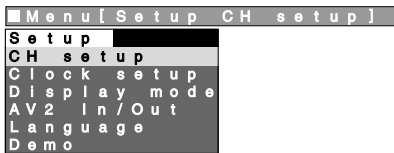

- 4 Press **▲▼** to select the desired adjustment item.

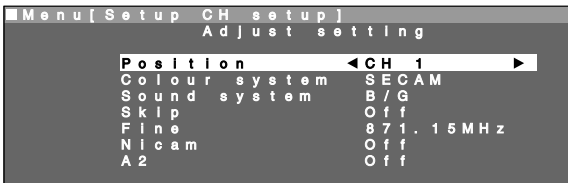

- 5 Each time you press **◀▶**, the setting for individual items is as mentioned under Selected item.

- 6 Press **MENU** to exit.

Selected item	Description
Position	The channel position changes to the upper or lower number.
Colour system	The mode changes in the following order: Auto ↔ PAL ↔ SECAM ↓ PAL60 ↔ N443 ↔ N358
Sound system	The mode changes in the following order: B/G ↔ D/K ↔ M
Skip	The mode changes in the following order: On ↔ Off Channel numbers with a "● (RED)" mark on the left are set to Skip. To turn off Skip, press Channel Select to select the desired channel, and then set the Skip mode on the CH setup menu to "Off".
Fine	The frequency changes to allow fine tuning.
Nicam	The broadcast sound system changes in the following order: On (NICAM sound) ↔ Off (Monaural TV sound)
A2	Stereo system changes in the following order: On (A2 sound) ↔ Off (Monaural TV sound)

NOTE

- Switching Colour system;
Set the system to Auto for normal TV reception. The Auto mode automatically detects the receiving signal system and changes the reception system of the LCD TV set. When the picture or sound is not stable, switching to an appropriate system may improve the picture or sound quality.
- When using Fine tuning, the channel number changes from green to yellow.
- To return the channel to its original frequency setting, follow the manual channel preset procedure. (Please see page 13 "Presetting the Channels (MANUAL)" for details.)

Clock Setup

The Timer functions that turn power on at the specified time do not work unless the clock has been adjusted. Be sure to adjust the clock first.

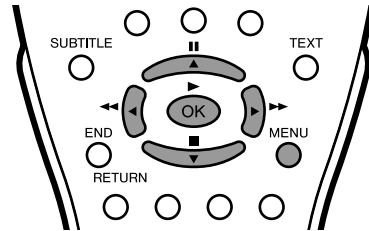

- 1 Press **MENU** to display the Menu screen.
- 2 Press **◀▶** to select "Setup".
- 3 Press **▲▼** to select "Clock setup", and press **OK**.

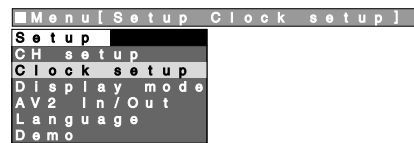

- 4 Press **◀▶** to select day/month/day of week, year or time. Press **▲▼** to make the adjustment.



- 5 Press **MENU** to exit.

NOTE

- Set the time difference with global standard time of your area for "Time zone". (See "Time Zone Table" on page 58).

Backup

The clock function is maintained for about 10 minutes even when the adapter has been shut off due to a power outage or when moving the LCD TV set. (Since about 30 minutes are required to charge the backup power supply, the clock function may not be able to be maintained if the charging time is excessively short.)

Selecting Menu Items

Selecting Menu Items

■ Menu Setting Screens

For details on using each setting screen, refer to the page number indicated.

	Page
Picture	
Contrast	16
Brightness	16
Colour	16
Tint	16
Sharpness	16
Colour system	16
Advanced	16, 17
Reset	16

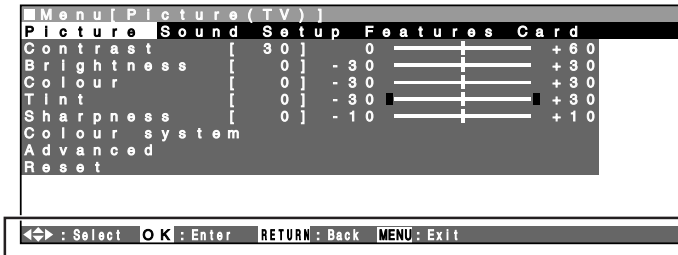

The bar above is an operational guide for the remote control. The bar will change in accordance with each menu screen.

	Page
Sound	
Treble	18
Bass	18
Balance	18
Sound wide	18
Clear tone	18
Reset	18

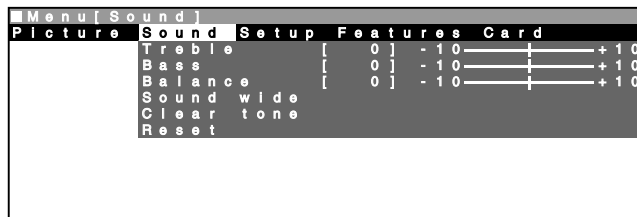

	Page
Setup	
CH setup	14, 22, 23
Clock setup	14
Display mode	19
AV2 In/Out	19
Language	18
Demo*	15

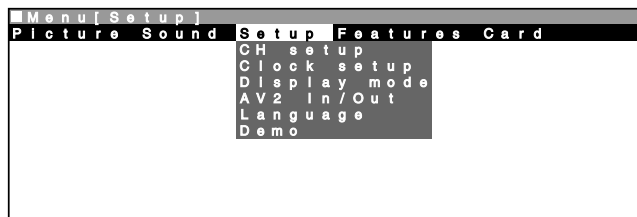

	Page
Features	
Backlight	20
Timer function	21
Auto power off	20
Blue Back	20
Reset	20

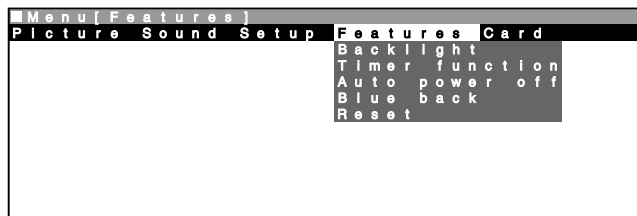

	Page
Card	
Select mode	29
Video setup	31, 36 – 40
Timer Rec.	33
Still setup	43 – 47, 49, 50
Format	51

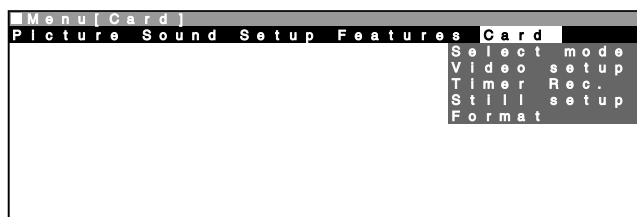

*About "Demo" in "Setup"

- "Demo" is a function for demonstration display at a shop.
- To turn off the demonstration, do the following:
 1. Press <=> to select "Setup" in the Menu screen.
 2. Press <=> to select "Demo", and press OK.
 3. Press <=> to select "Demo".
 4. Press <=> to select "Off", and press OK.
 5. Press MENU to exit.

NOTE

- The illustrations and on-screen displays in this manual are for explanation purposes and may vary slightly from the actual appearance.

Basic Adjustment Settings

Picture Adjustments

Adjust the picture to your preference with the following picture settings.

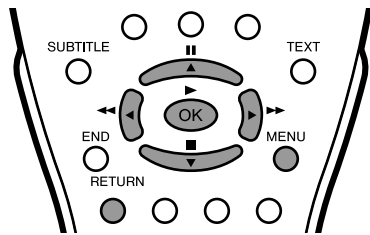

- 1 Press **MENU** to display the Menu screen.
 - The Picture Menu screen can be displayed directly by pressing the **Red**.

- 2 Press **◀▶** to select "Picture".

- 3 Press **▲▼** to select a specific adjustment item.

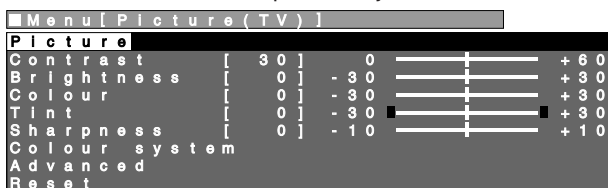

- 4 Press **◀▶** to adjust the item to your desired position.

- 5 Press **MENU** to exit.

Selected item	◀ button	▶ button
Contrast	For less contrast	For more contrast
Brightness	For less brightness	For more brightness
Colour	For less colour intensity	For more colour intensity
Tint	Skin tones become purplish	Skin tones become greenish
Sharpness	For less sharpness	For more sharpness

NOTE

- Select "Colour system" and press **OK** to select "Auto", "PAL", "SECAM", "N358", "N443" or "PAL60". See below.
- Select "Advanced" and press **OK** to set "I/P Setup", "DNR", "Film mode" or "Cool climate". See pages 16 and 17.
- When setting all adjustments (Except "Colour system" and "Advanced" items) to factory preset values,
 - 1 Press **▲▼** to select "Reset", and press **OK**.
 - 2 Press **◀▶** to select "Yes", and press **OK**.

Colour System (Only AV1 or AV2 Mode)

Set the system to "Auto" for normal reception. The "Auto" mode automatically detects the receiving signal system and changes the reception system of the set. When the picture or sound is not stable, switching to an appropriate system may improve the picture or sound quality.

- 1 Perform steps 1 and 2 in **Picture Adjustments**.

- 2 Press **▲▼** to select "Colour system", and press **OK**.

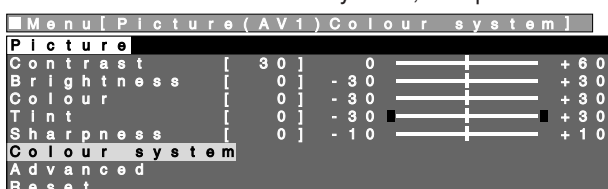

- 3 Press **▲▼/◀▶** to select "Auto", "PAL", "SECAM", "N358", "N443" or "PAL60" and press **OK**.

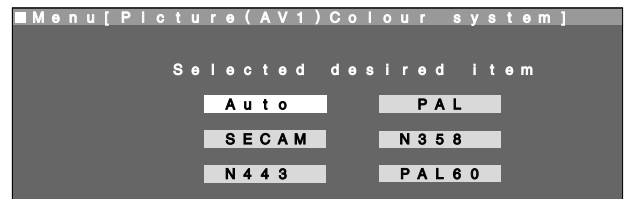

- 4 Press **MENU** to exit.

NOTE

- Colour system is displayed only in the AV mode.

I/P Setup

Adjusting the image and input signal can give you a more beautiful picture.

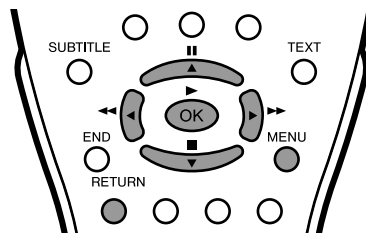

- 1 Press **MENU** to display the Menu screen.
 - The Picture Menu screen can be displayed directly by pressing the **Red**.

- 2 Press **◀▶** to select "Picture".

- 3 Press **▲▼** to select "Advanced", and press **OK**.

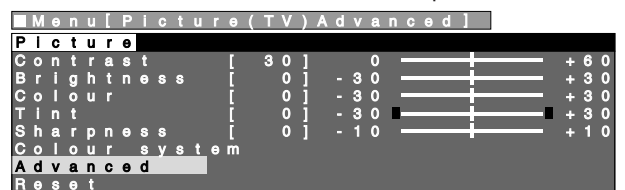

- 4 Press **▲▼** to select "I/P Setup", and press **OK**.



- 5 Press **▲▼** to select "Interlace" or "Progressive", and press **OK**.

- 6 Press **MENU** to exit.

Selected item	Description
Interlace	Use this setting when you cannot get a clear picture with Progressive. (Especially suitable for media with special effects like game software.)
Progressive	Normally, you should select this setting.

DNR (Digital Noise Reduction)

Produces a clearer video image.

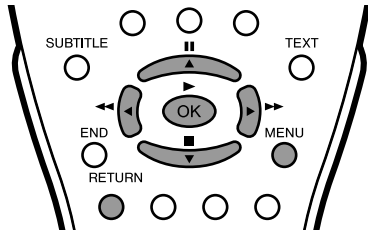

- 1 Press **MENU** to display the Menu screen.
• The Picture Menu screen can be displayed directly by pressing the **Red**.

- 2 Press **◀▶** to select "Picture".

- 3 Press **▲▼** to select "Advanced", and press **OK**.

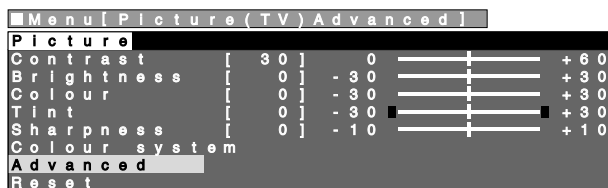

- 4 Press **▲▼** to select "DNR", and press **OK**.



- 5 Press **▲▼** to select "On", and press **OK**.

- 6 Press **MENU** to exit.

Film Mode

Automatically detects a film-based source (originally encoded at 24 frames/second), analyses it, and then recreates each still film frame for high-definition picture quality.

- 1 Press **MENU** to display the Menu screen.
• The Picture Menu screen can be displayed directly by pressing the **Red**.

- 2 Press **◀▶** to select "Picture".

- 3 Press **▲▼** to select "Advanced", and press **OK**.

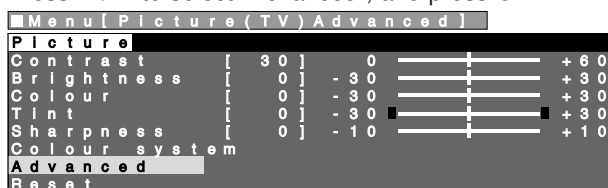

- 4 Press **▲▼** to select "Film mode", and press **OK**.



- 5 Press **▲▼** to select "On", and press **OK**.

- 6 Press **MENU** to exit.

NOTE

- Set the "Film mode" to "On" manually to detect a film-based source (originally encoded at 24 frames/second) when the input source has vertical frequency of 50 Hz (e.g. PAL, SECAM etc.) .

Cool Climate

(This function is only available with LC-20B5M model.)

Improves LCD response when viewing fast-moving images. The effect is greater at low room temperatures (at or below 15°C/59°F).

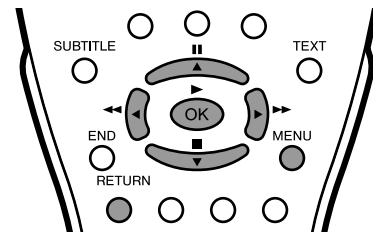

- 1 Press **MENU** to display the Menu screen.
• The Picture Menu screen can be displayed directly by pressing the **Red**.

- 2 Press **◀▶** to select "Picture".

- 3 Press **▲▼** to select "Advanced", and press **OK**.

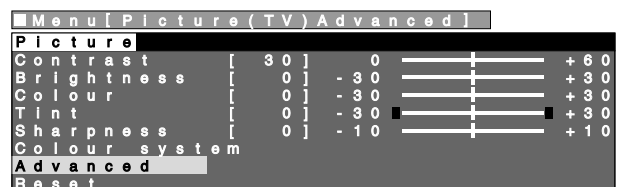

- 4 Press **▲▼** to select "Cool climate", and press **OK**.



- 5 Press **▲▼** to select "On", and press **OK**.

- 6 Press **MENU** to exit.

NOTE

- Cool climate may cause image noise. If this occurs, set the function to "Off".

Basic Adjustment Settings (Continued)

Sound Adjustments

You can adjust the sound quality to your preference with the following settings.

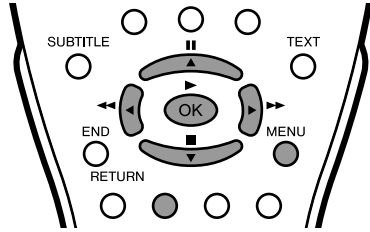

- 1 Press **MENU** to display the Menu screen.
• The Sound Menu screen can be displayed directly by pressing the **Green**.
- 2 Press **◀▶** to select "Sound".
- 3 Press **▲▼** to select a specific adjustment item.

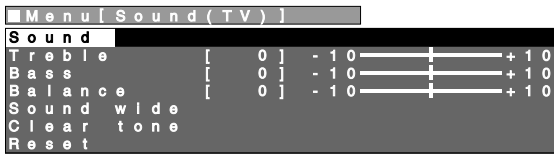

- 4 Press **◀▶** to adjust the item to your desired position.
• Select "Sound wide" or "Clear tone" and press **OK** to select "On" or "Off" of each item.

Example: Sound wide setting screen

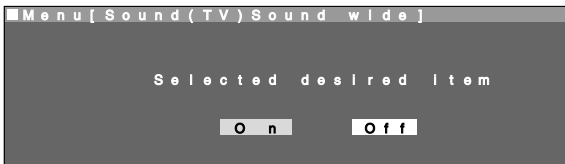

- 5 Press **MENU** to exit.

Selected item	◀ button	▶ button
Treble	For weaker treble	For stronger treble
Bass	For weaker bass	For stronger bass
Balance	Increase the volume of the left speaker	Increase the volume of the right speaker
Sound wide*	On: Increase the spread of the sound.	
Clear tone*	On: Accentuates high-pitched sounds.	

* "Sound wide" and "Clear tone" are not set when the headphone mini-plug into HEADPHONE jack.

NOTE

- When all adjustments (Except "Sound wide" and "Clear tone" items) set to factory preset values,
 - ① Press **▲▼** to select "Reset", and press **OK**.
 - ② Press **◀▶** to select "Yes", and press **OK**.
- When you select "Out ㄨ" in "AV2 In/Out", you cannot adjust sound settings.

On-screen Display Language Setting

You can select English, Chinese or Arabic as the on-screen display language.

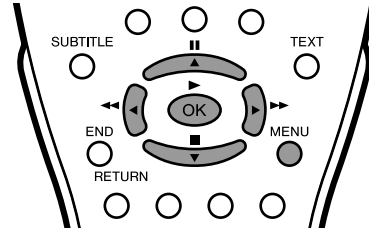

- 1 Press **MENU** to display the Menu screen.
- 2 Press **◀▶** to select "Setup".
- 3 Press **▲▼** to select "Language", and press **OK**.

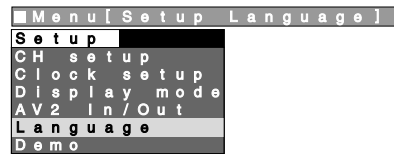

- 4 Press **▲▼** to select the desired language, and press **OK**.

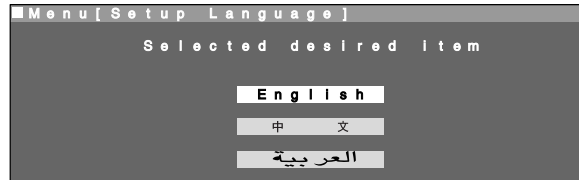

- 5 Press **MENU** to exit.

AV2 In/Out

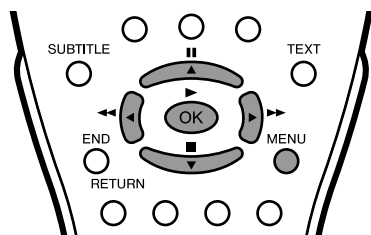

- 1 Press **MENU** to display the Menu screen.
- 2 Press **◀▶** to select "Setup".
- 3 Press **▲▼** to select "AV2 In/Out", and press **OK**.

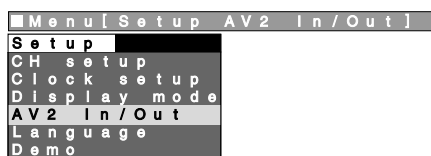

- 4 Press **▲▼** to select the desired mode, and press **OK**.

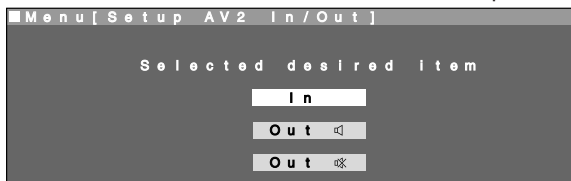

- 5 Press **MENU** to exit.

AV2 In/Out	[In] AV-IN2 terminals selected as input terminals	[Out ◀] Line Output is selected, Output volume is fixed, Speaker output is available.
		[Out ⌘] Line output is selected, Output volume is variable, speaker output is Mute.

Display Mode

You can set the orientation of the picture.

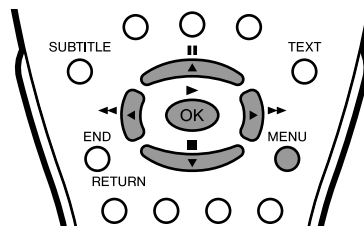

- 1 Press **MENU** and the Menu screen is displayed.
- 2 Press **◀▶** to select "Setup".
- 3 Press **▲▼** to select "Display mode", and press **OK**.

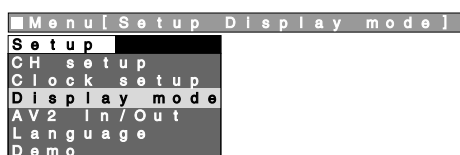

- 4 Press **▲▼** to select the desired mode, and press **OK**.

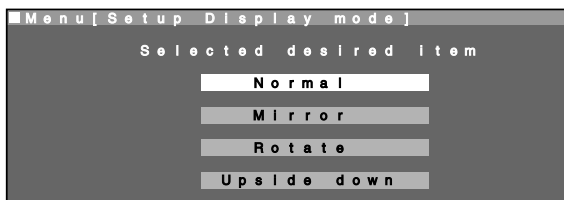

- 5 Press **MENU** to exit.

NOTE

- The Rotate is set to "Normal" at the factory setting.

[Normal]: Normal image orientation.

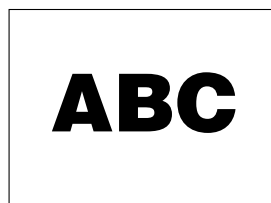

[Rotate]: To display rotated images for special uses.



[Mirror]: To display mirror images for special uses.



[Upside down]: To display upside down images for special uses.



Basic Adjustment Settings (Continued)

Features

The Feature items can be set by the user.

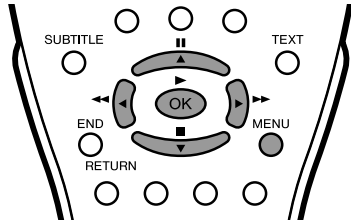

1 Press **MENU** and the Menu screen is displayed.

2 Press **◀▶** to select "Features".

3 Press **▲/▼** to select the desired adjustment item, and press **OK**.

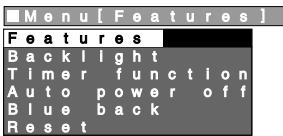

4 Press **▲/▼/◀▶** to set each item in each setting screen. (Except "Timer function" item.)

Example: Backlight setting screen

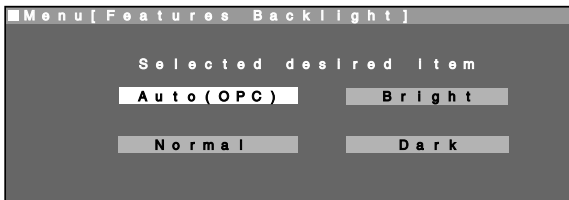

5 Press **MENU** to exit.

Directly setting the Backlight

You can change the setting of Backlight directly.

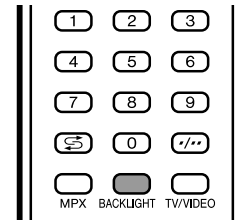

1 Press **BACKLIGHT** to display the Backlight screen.

2 Each time you press **BACKLIGHT**, the mode changes as follows. You can select the desired mode.

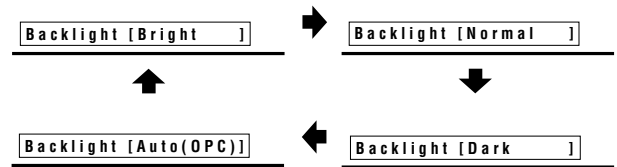

NOTE

- The Backlight screen automatically disappears after 4 seconds.
- See the table left for details of the each backlight setting.
- When set to "Auto (OPC)", make sure that no object obstructs the OPC sensor, which could affect its ability to sense surrounding light.

Selected item	Factory setting	Adjustable item/range
Backlight*	[Bright] Maximum brightness	[Normal] Brightness 60% → Suitable for viewing in well-lit areas. Saves energy. [Dark] Brightness 20% → Sufficiently bright when viewing in dim areas. [Auto (OPC)] Screen brightness is adjusted according to the ambient light of the room.
Auto power off (only TV mode)	[Off] This feature is inactive.	[On] The power of the LCD TV set is turned off when there is no signal for 5 minutes.
Blue back	[On] The screen is turned blue when there is no signal.	[Off] This feature is inactive.

* Backlight setting can be switched in one touch using the remote control (see right).

NOTE

- Select "Timer function" and press **OK** to set "Sleep timer" and "Wake-up timer" (See page 21).
- When all adjustments set to factory preset values,
 - ① Press **▲/▼** to select "Reset", and press **OK**.
 - ② Press **◀▶** to select "Yes", and press **OK**.

Timer Function

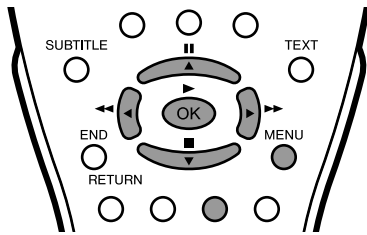

- 1 Press **MENU** to display the Menu screen.
 - The Timer function Menu screen can be displayed directly by pressing the **Yellow**.
- 2 Press **◀▶** to select “Features”.
- 3 Press **▲▼** to select “Timer function”, and press **OK**.



- 4 Press **▲▼** to select “Sleep timer”, and press **OK**.

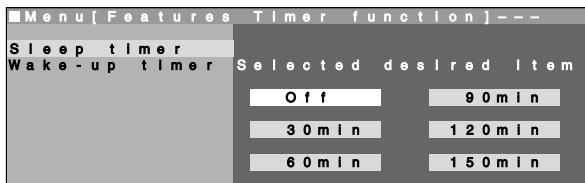

- 5 Press **▲▼/◀▶** to select “Off”, “30min”, “60min”, “90min”, “120min” or “150min”, and press **OK**.

- 6 Press **▲▼** to select “Wake-up timer”, and press **OK**.

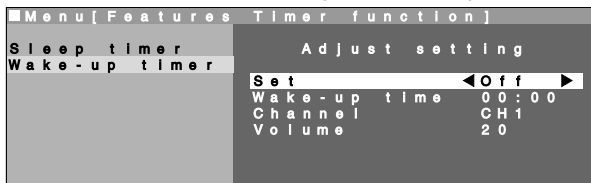

- 7 Press **▲▼** to select the desired adjustment item, and press **◀▶** to adjust them. Press **OK** to set.

- 8 Press **MENU** to exit.

NOTE

- When you set “Wake-up timer”, POWER indicator lights up orange.
- Be sure to adjust the clock with “Clock setup” in “Setup” before setting “Sleep timer” and “Wake-up timer”.
- Timer programming settings are cancelled when the duration of the power outage exceeds the backup time. (See page 14.)

NICAM Broadcast Selection

To let you enjoy NICAM broadcasting, this LCD TV receives NICAM stereo system, bilingual, and monaural broadcasts.

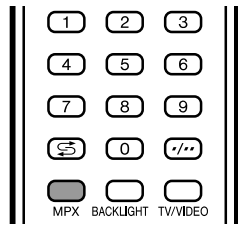

Stereo

The LCD TV set is receiving a stereo broadcast.

- Each time you press **MPX**, the mode changes between "NICAM STEREO" and "MONO".
- When "MONO" is selected, the TV sound is output monaurally.

(When stereo sound is received)

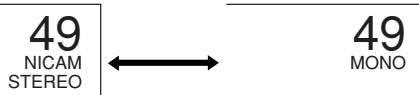

Bilingual

The LCD TV set is receiving a bilingual broadcast.

- Pressing **MPX** changes the audio mode in the order shown on the right.
- M1=main sound, M2=sub sound, or MONO=monaural sound, can be selected.

(When main sound is selected)

(When sub sound is selected)

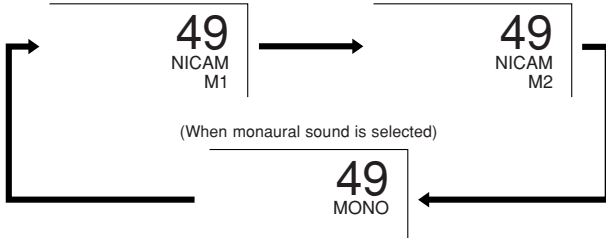

Monaural

The LCD TV set is receiving a monaural broadcast.

- Each time you press **MPX**, the mode changes between "NICAM MONO" and "MONO".

(When monaural sound is received)

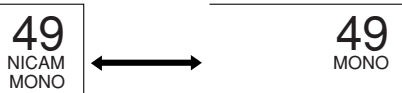

NOTE

- If approximately 3 seconds pass without a button being pressed, the mode setting is automatically terminated and the LCD TV set returns to the normal mode.
- The setting can be individually selected for each channel number.

If the sound quality is poor due to a weak signal or other problems during NICAM broadcast reception, set the "Off" position of the NICAM to change the TV sound to monaural.

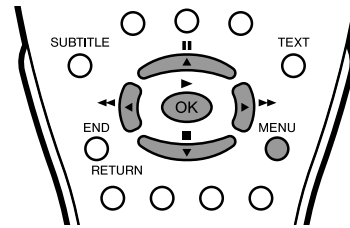

1 Press **MENU** to display the MENU screen.

2 Press **◀▶** to select "Setup".

3 Press **▲▼** to select "CH setup", and press **OK**.

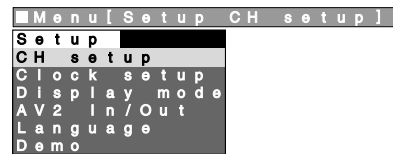

4 Press **▲▼** to select "Nicom", and press **◀▶** to select "Off".

When the NICAM sound is set to the "Off" position, the TV sound is output in monaural.

5 Press **MENU** to exit.

(When off position is selected)



NOTE

- When the NICAM sound is set to the "Off" position, **MPX** cannot be used to change the audio mode (stereo and bilingual settings).

A2 Stereo Broadcast Selection

To let you enjoy A2 stereo broadcasting, this TV receives A2 stereo system and bilingual broadcasts.

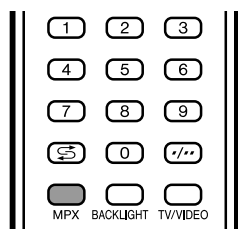

Stereo

The LCD TV set is receiving a stereo broadcast.

- Each time you press **MPX**, the mode changes between "STEREO" and "MONO".
- When "MONO" is selected, the TV sound is output monaurally.
(When stereo sound is received)

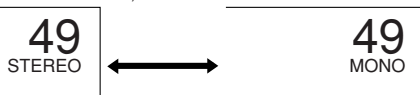

Bilingual

The LCD TV set is receiving a bilingual broadcast.

- Pressing **MPX** changes the audio mode in the order shown on the right.
- MAIN=main sound or SUB=sub sound, can be selected.
(When main sound is received) (When sub sound is received)

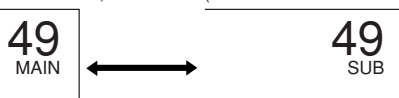

NOTE

- If approximately 3 seconds pass without a button being pressed, the mode setting is automatically terminated and the LCD TV set returns to normal mode setting.
- The setting can be selected individually for each channel number.

If the sound quality is poor due to a weak signal or other problems during A2 stereo broadcast reception, set the "Off" position of the A2 to change the TV sound to monaural.

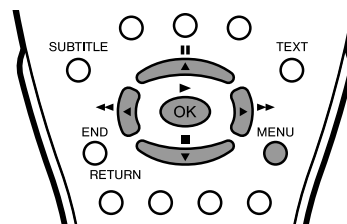

- 1 Press **MENU** to display the MENU screen.
- 2 Press **◀▶** to select "Setup".
- 3 Press **▲▼** to select "CH setup", and press **OK**.

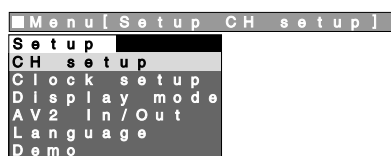

- 4 Press **▲▼** to select "A2", and press **◀▶** to select "Off".
When the A2 sound is set to the "Off" position, the TV sound is output in monaural.

(When off position is selected)

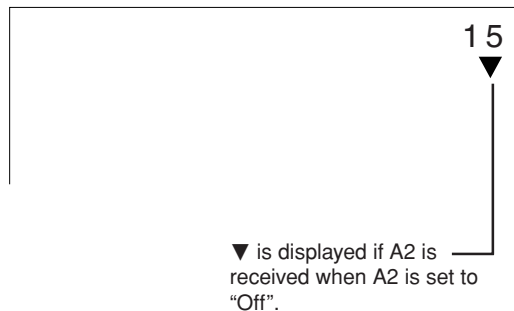

- 5 Press **MENU** to exit.

NOTE

- When the A2 sound is set to the "Off" position, **MPX** cannot be used to change the audio mode (stereo and bilingual settings).

Teletext

■ What is Teletext?

Teletext is an information service organised like a magazine, which is provided by some TV stations in addition to regular television broadcasting. Your LCD TV set receives special Teletext signals broadcast by a TV station, processes the information and displays it graphically on the screen. News, weather and sports information, stock exchange prices, programme reviews and closed captioning for people hard of hearing are among the many services available through Teletext.

■ Teletext mode

Teletext is activated with **TEXT** on the remote control and is also closed with it. The LCD TV set can be controlled in Teletext mode directly by inputting commands with the remote control and indirectly through the on-screen display (menu system).

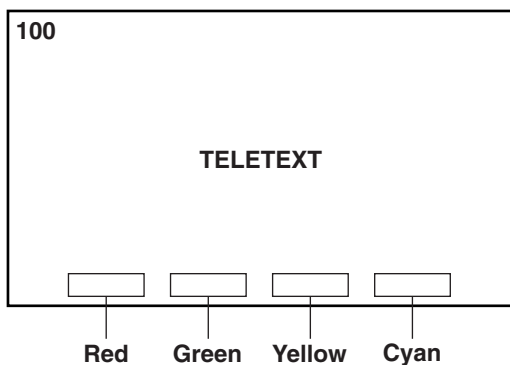

■ Operating instructions in Teletext mode

- The FLOF system for teletext is transmitted in Singapore currently.
- The TOP system for teletext is transmitted in Australia currently.
- If TOP Teletext is broadcast, a control line and TOP line can be displayed on the screen. The TOP line involves the operating instructions associated with all of the **Coloured buttons** if TOP text is transmitted, or the operating instructions for only **Red** and **Green** if TOP text is not being transmitted.
- If there are subpages, a control line holding the operating instructions for subpages can be displayed on line 24.

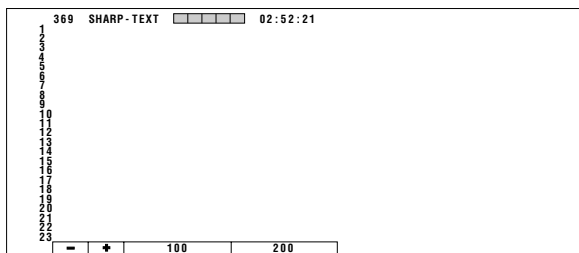

[1] Turning on and off Teletext mode

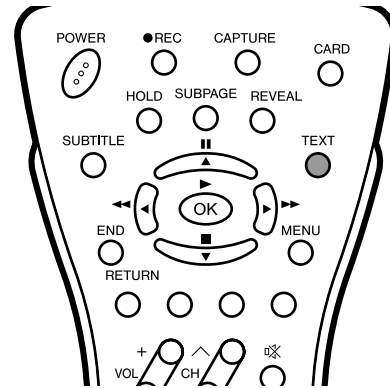

- 1 Select a TV channel that is broadcasting the Teletext programme.
- 2 Press **TEXT** and the Teletext screen is displayed.

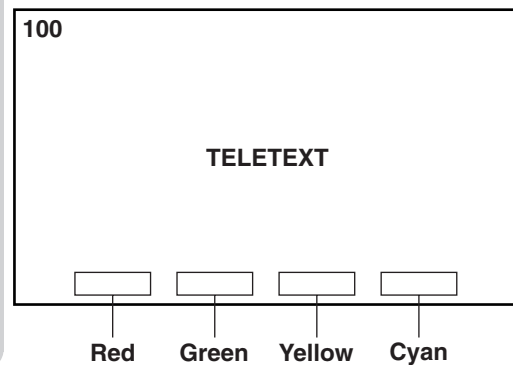

- To turn off the Teletext mode, press **TEXT** again.

[2] Using the TOP line

When TOP Teletext is being broadcast, you can display the TOP line, which contains the operating instructions on the screen.

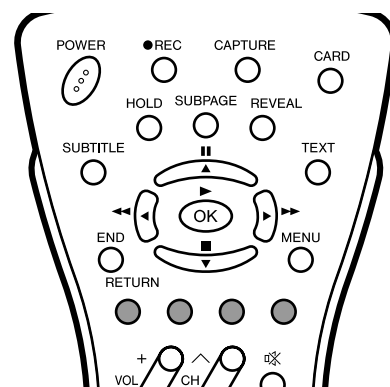

- 1 Press the **Coloured buttons** to operate the Teletext screen.
 - Press **Red** to display the previous page and **Green** to display the next page. **Yellow** and **Cyan** are as indicated on the TOP line.

NOTE

- By pressing **Red** the previously selected page will appear down to the first page which showed up directly after switching on the teletext. Therefore **Red** has no function directly after switching on the teletext.

[3] Changing subpages

If a page has been selected from among several subpages, you can display a control line which contains the subpage numbers.

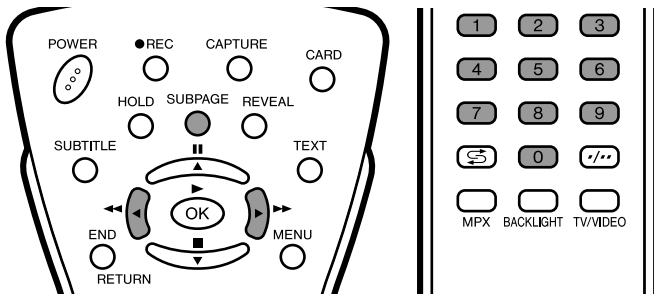

- 1 Press **SUBPAGE**. The control line with the subpage numbers is displayed on line 24, and the number of the currently selected subpage is displayed in blue.

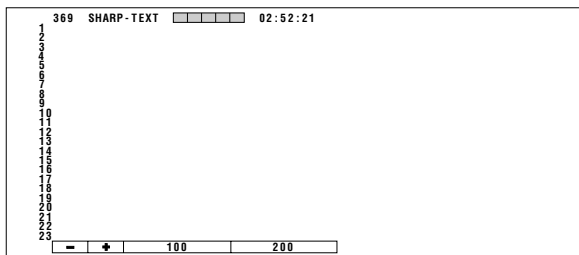

- 2 Press **◀▶** to select the desired subpage number. The selected subpage is displayed.
 - You can also use **Channel Select** to select the desired subpage.
- 3 Press **SUBPAGE** to turn off the control line.

[4] Using the TOP table

When TOP Teletext is being broadcast, you can display the TOP table with the current programme data if one exists.

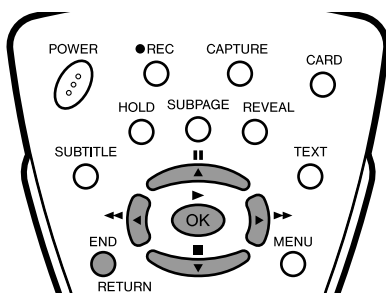

- 1 Press **OK** to display the TOP table. The Teletext page is temporarily turned off.
- 2 Press **▲/▼** to select the desired item. Press **◀▶** to select topics (column 1) or subtopics (column 2) if they exist.
- 3 Press **OK**. A page associated with the selected item is displayed.
- 4 Press **END** to exit.

[5] Using Teletext menu

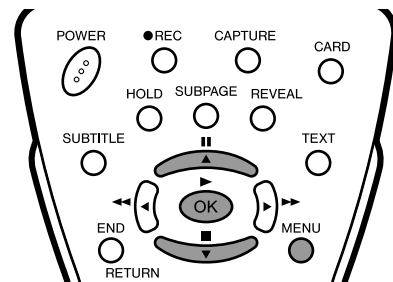

To select the character set

- 1 During Teletext broadcast, press **MENU** to display the "Character set" screen.



- 2 Press **▲/▼** to select the desired character set.
 - The colour of the letters will turn to yellow. When selecting the character set, pressing **OK** will change the letters to grey for an instant and then return them back to yellow.
- 3 Press **MENU** to exit.

[6] Useful Features for Teletext

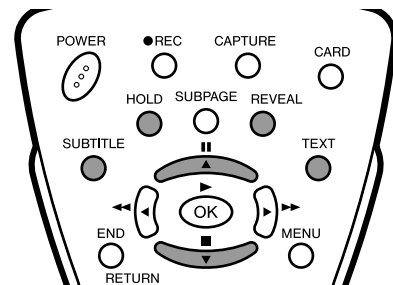

- **HOLD** on the remote control can be used to hold the current teletext page. Press the button again to cancel the hold mode.
- **▲/▼** can be used to zoom the current teletext page as below.

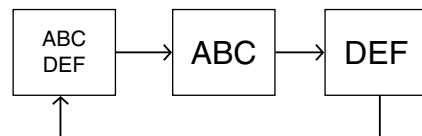

* The screen is displayed in each mode each time **▲/▼** is pressed.

- **SUBTITLE** can be used to quickly activate subtitles.
- * Press **TEXT** to deactivate subtitles.
- **REVEAL** can be used to display hidden information such as solutions to riddles and puzzles. Press the button again to hide the information.

Before Using Memory Cards

■ Important Notes on Using Memory Cards

- SHARP cannot be held responsible for misuse of the LCD TV set, any troubles during use, or other problems, or any damages arising out of the use of the LCD TV set, except for those cases for which Sharp is liable by law.
- If you or other people misuse the LCD TV set, or the LCD TV set is affected by static electricity or electrical noise, the recorded data may be in danger of being changed or lost.
- If you are making an important recording, run a test in advance to ensure that the recording would be performed correctly in terms of picture or sound quality.
- SHARP cannot be held responsibility nor make any compensations even if pictures or sound cannot be recorded correctly because of any troubles when using the LCD TV set.

Copyright

Note:

For Australia

- Copyright may exist in material you wish to record.

Copying such material without permission of the relevant licensee(s) or owner(s) of the copyright is prohibited by law. SHARP is not in a position to authorize the recording of copyright works and nothing in this manual should be read or implied as giving that authority.

For Asia

- Audio-visual material may consist of copyrighted works which must not be recorded without the authority of the owner of the copyright.

Please refer to relevant law in your country.

Duplicating images and music by copying and/or editing from videocassettes and/or TV programmes that are subject to copyrights is only permitted when the edited or copied versions are used for personal pleasure. With the exception of cases when the user personally is the owner of the copyrights of the object in question or when specific and written permission has been obtained from the owner(s) of the object in question, the user is not permitted to make copies and/or duplications and/or edited versions as this constitutes a violation of the copyright laws, possible exposing the user to demands for compensation for damages. Therefore, be sure to strictly observe the existing copyright laws.

In addition when using image data that includes third parties, since the use of such images without prior permission may constitute an intrusion on the privacy of third parties, be sure to refrain from such usage.

■ Card mode specifications

Still Picture	Recording/Playback File Format	JPEG (DCF compliant)
	Size of a Captured Still Picture	640×480 dots
Motion Picture	Recording File Format	SP/LP ... ASF (Motion Picture: MPEG-4 compliant, Sound: WMA-compliant) EP ASF (Motion Picture: MPEG-4 compliant, Sound: G.726-compliant)
	Size of a Recorded Motion Picture/Number of Frames	SP ... Size: 320×240 dots, Frame: approx. 25 frames/sec LP ... Size: 320×240 dots, Frame: approx. 25 frames/sec EP ... Size: 320×240 dots, Frame: approx. 12.5 frames/sec
	Playback File Format	ASF (Motion Picture: MPEG-4 compliant, Sound: WMA-compliant) ASF (Motion Picture: MPEG-4 compliant, Sound: G.726-compliant)

* Motion picture files and still image files recorded, stored or edited with other devices may not play back correctly.

■ Concerning the standard number of recorded images and recording time

Still Pictures

	Picture Size	Memory Card	
		32MB	128MB
Recordable Pictures	640 × 480	Approx. 300 pictures	Approx. 1,000 pictures

* Recordable numbers may vary depending on the reception conditions of the LCD TV set and/or the contents of images.

Motion Pictures

	Picture Size	Recording Mode	Memory Card Capacity	
			256MB	5GB
Recordable Time	320 × 240	SP	Approx. 10min.	Approx. 4h
	320 × 240	LP	Approx. 30min.	Approx. 10h
	320 × 240	EP	Approx. 1h	Approx. 25h

* Recordable time may vary depending on reception conditions of the LCD TV set or the contents of images.

* The maximum amount of data you can record on a memory card is 1,024 pictures in total including still and motion pictures.

* Files in excess of 4GB and files exceeding 12 hours of recording time cannot be recorded and/or played back.

About Memory Cards

- You can use memory cards (commercially available) for recording and playing back pictures.
 - Please use an appropriate PC card adapter (commercially available) for each memory card.
 - The following memory cards are available. (Note that names for memory cards vary depending on the manufacturer.)

Memory card name	Storage capacity
SD Memory Card	512 MB or less
miniSD™ Card	32 MB or less
CompactFlash	2 GB or less
MultiMediaCard	128 MB or less
SmartMedia	128 MB or less
Memory Stick	128 MB or less
Memory Stick Pro	1 GB or less
xD-Picture Card	128 MB or less
Micro Drive	2 GB or less
PC Card HDD	5 GB or less

* At present, January, 2004

The capacity of the memory stick only serves as a guide and may differ depending on brand.

Trademarks

SD Memory Card is a trademark.
 CompactFlash is a trademark of SanDisk Corporation of the USA.
 MultiMediaCard is a trademark of Infineon Technologies AG of Germany.
 SmartMedia is a trademark of Toshiba Corporation.
 Memory Stick is a trademark of Sony Corporation.

- To read picture files recorded with digital cameras, use the PC card adapter recommended by the corresponding manufacturer. (The names of PC card adapters vary depending on the manufacturer.)
- For directions concerning the use of digital cameras or PC card adapters, please refer to the operation manual provided with each product.
- Depending on the card or adapter used, normal operation may not be possible.

- In the card mode, you can playback DCF compliant JPEG pictures captured with other devices.

* DCF (Design rule for Camera File system) is a standard of the Japan Electronics and Information Technology Industries Association (JEITA). This standard specifies the image file format used for images shot with a digital camera.

- Some motion pictures recorded with other devices may not be played back correctly.
- * Depending on the card or adapter used, normal operation may not be possible.

Commercially Available Memory Cards

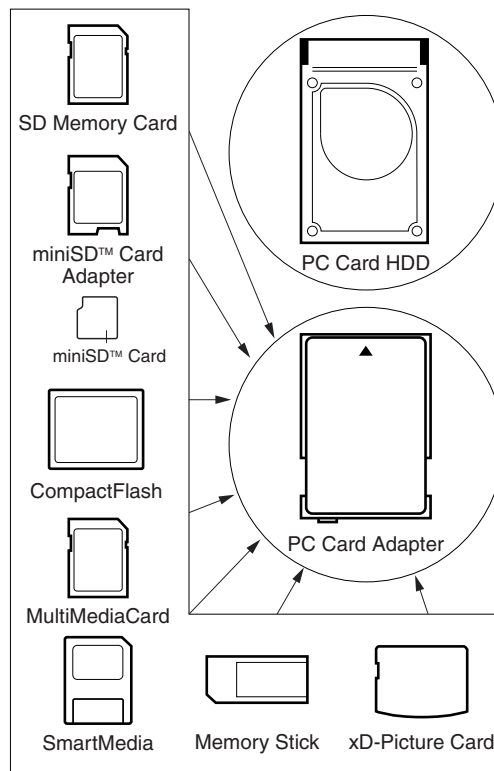

- Be sure to use an appropriate PC card adapter (commercially available) for each memory card.

Preparing a Memory Card

Insert a memory card (commercially available) into a PC card adapter (commercially available).

Example:
 Inserting the SD memory card into a PC card adapter.

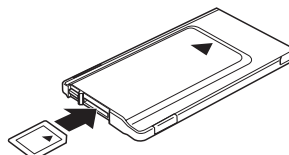

Notes on Using Memory Cards and PC Card Adapters

Please note the following when using memory cards and PC card adapters to avoid corruption of data or malfunction of the LCD TV set.

- If you use a memory card other than the ones specified above, its ability to record or playback pictures is not guaranteed.
- Some PC card adapters have restrictions in regards to memory card capacity. Refer to the relevant operation manual for such restrictions.
- Some pictures which have been created, modified, or copied on your PC may not be played back correctly.
- Do not bend, drop or apply a shock to memory cards or PC card adapters.
- Keep memory cards or PC card adapters away from heat, water or direct sunlight.
- Do not take apart or modify memory cards or PC card adapters.
- Refer to the appropriate operation manuals for details on using or keeping memory cards or PC card adapters.
- Do not turn the LCD TV set off while a memory card is in operation (e.g. playing back, recording or displaying a slideshow).
- The recorded data may be erased or changed due to incorrect operation, the influence of static electricity and electrical noise, therefore be sure to back-up the data regularly.
- Be sure to back-up important files using other media such as a PC.

Loading a PC Card Adapter

Loading a PC Card Adapter

You need to set a memory card in a PC card adapter before loading it. (See page 27.)

- 1 Check the Card Eject button is pressed.
- 2 Insert a PC card adapter into the PC card slot on the LCD TV set slowly.

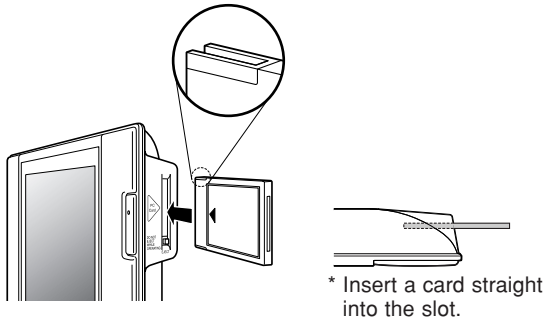

- 3 The Card Lamp turns green.

Changing from Card Mode to the TV mode

Press either **Channel Select**, **TV/VIDEO** or **CH(∧)/(∨)**.

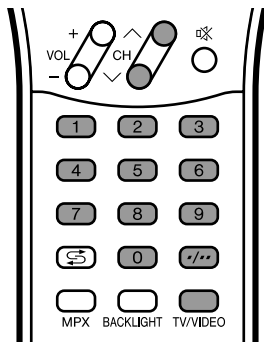

Inserting/Removing a PC Card

Important:

- Do not allow foreign objects to enter the PC card slot. This could lead to defects.

- 1 Confirm the Card Eject button is in the depressed position.

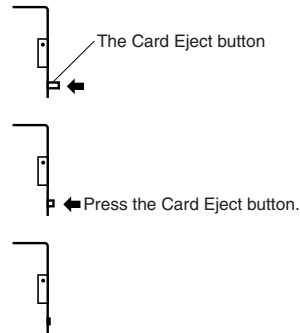

- 2 Insert the PC card adapter.

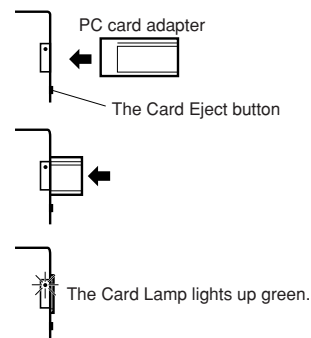

- 3 Press the Card Eject button, and remove the PC card adapter.

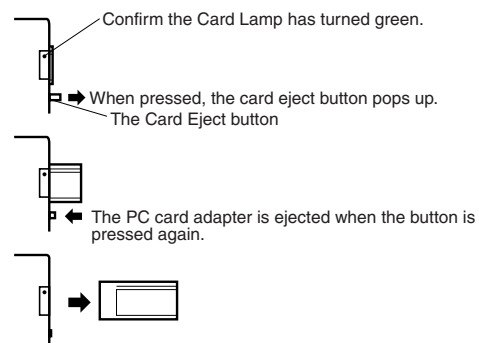

NOTE

- If the Card Eject button is not in the depressed position, the card cannot operate. Please use with the Card Eject button in the depressed position.
- When ejecting the PC card adapter, confirm the Card Lamp is green before ejecting the adapter.
- Never eject the PC card adapter when the Card Lamp is red.
- When there are many files, reading can take about 5 minutes.

Playing Back Mode

Select Mode

Switches the mode between motion picture and still picture.

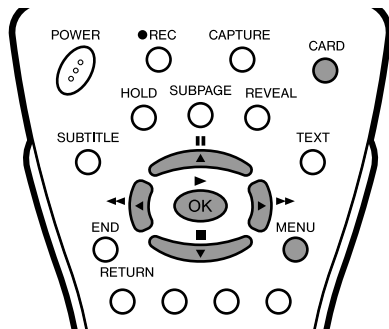

Press **CARD**.

- The playback mode used when recording is displayed. Each time you press this button, the mode is switched as follows.

[Motion Picture]

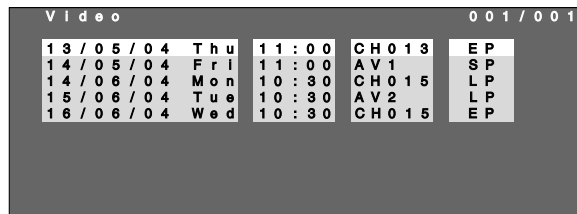

* When no motion picture is present, "No video file" is displayed.



[Still Picture]



* When no still picture is present, "No still image file" is displayed.

You can also set the mode from the Menu screen.

- Press **MENU** to display the Menu screen.
- Press **◀▶** to select "Card".
- Press **▲▼** to select "Select mode", and press **OK**.

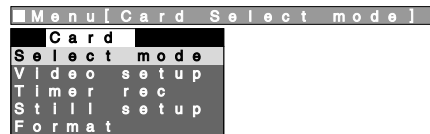

- Press **◀▶** to select the desired mode, and press **OK**.

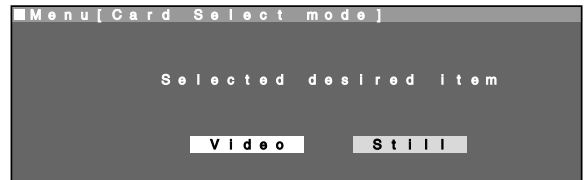

- Selected mode is displayed.

- Press **MENU** to exit.

NOTE

- Protected files are displayed with the "Ⓜ" mark.
- Files that could not be read are displayed with an "X" mark.

Recording/Playing Back a Memory Card

Recording on the Memory Card The following settings are available to help you make correct recordings.

When Recording Motion Pictures:

- Set the picture quality for recording motion pictures. → **Rec mode** (See page 31.)
- Set the date, channel, and picture quality for the programme you want to record. → **Timer Rec** (See page 33.)
- Make the settings not to miss the moment you want to record. → **Pre-recording** (See page 31.)

When Recording Still Pictures:

- Make the settings for the shutter click to be heard when a picture is captured. → **Shutter click** (See page 47.)

Playing Back the Memory Card How to playback motion/still pictures.

Select the picture (motion picture or still picture) to be played back. → **Select mode** (See page 29.)

When Playing Back Motion Pictures:

- Playback the selected picture repeatedly. → **Repeat** (See page 36.)
- Playback the selected picture more slowly than normal. → **Slowmotion** (See page 37.)
- Zooms the selected picture. → **Zoom** (See page 38.)

When Playing Back Still Pictures:

- Start playing back pictures with the setup as specified. → **Still setup** (See page 43.)
- Displays still pictures you have selected one after another at a certain interval. → **Slideshow setup** (See page 43.)
- Displays still pictures in order you have specified. → **My programme** (See page 44.)
- Rotates a still picture. → **Rotate** (See page 45.)
- Plays a background music while playing back still pictures. → **Audio select** (See page 46.)
- Deletes unnecessary files or protects the files you want to keep. → **Edit** (See page 49, 50.)

Precautions when Playing Back PC Image Data on the LCD TV Set

Recording formats of image data:

When recording image data on the LCD TV set, the recording formats are as follows.

- When recording motion pictures: The SD_VIDEO folder is created and the data is stored in. When playing the card, the SD_VIDEO recording format is recognized.
- When recording still pictures: The DCIM folder is created and the data is stored in. When playing the card, the DCIM recording format is recognized.

When playing the card, record PC data in a recording format the LCD TV set can recognize.

1. When copying motion pictures from a PC to a card recorded with the LCD TV set, only play these pictures after placing them in the SD_VIDEO folder.
2. When copying still pictures from a PC to a card recorded with the LCD TV set, only play these pictures after placing them in the DCIM folder.
3. When using a new card for copying motion pictures, first format the card and create a SD_VIDEO folder before placing the data in the folder for playback.
4. When using a new card for copying still pictures, first format the card and create a DCIM folder before placing the data in the folder for playback.

When creating, revising, or copying images using your PC, the edited images may not playback correctly.

Recording on a Memory Card (Video Setup)

Rec Mode

Use this setting for recording images you are currently watching. Select the recording mode (picture quality) for a motion picture.

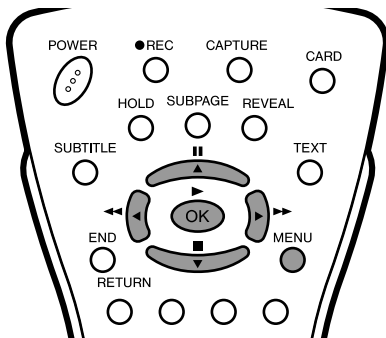

- 1 Press **MENU** to display the Menu screen.
- 2 Press **◀▶** to select "Card".
- 3 Press **▲▼** to select "Video setup", and press **OK**.

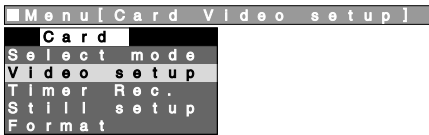

- 4 Press **▲▼** to select "Rec mode", and press **OK**.

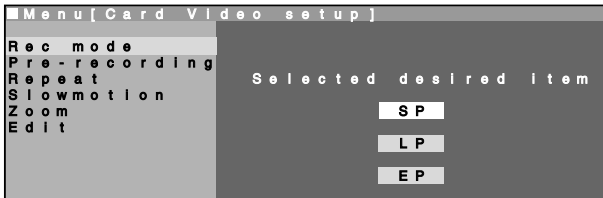

- 5 Press **▲▼** to select "SP", "LP" or "EP", and press **OK**.
- 6 Press **MENU** to exit.

Selected item	Description
SP	Use this mode for normal use.
LP	Use this mode for making long recordings.
EP	When recording with the LP/EP mode, there is a bigger difference in the image and sound quality than recording in the SP mode.

NOTE

- When using the SP mode, differences in picture quality can occur depending on the card used. In this case, it is recommended to record in the LP mode.
- When switching to the Card mode after finishing the recording, the motion picture mode is indicated.
- When switching to the Card mode after finishing recording a still picture, the still image mode is indicated.

Pre-Recording

When setting pre-recording to "On", recording will be initiated starting from 5 seconds earlier.

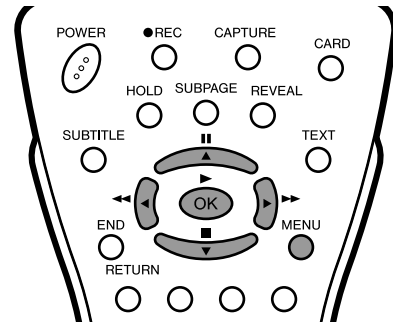

- 1 Press **MENU** to display the Menu screen.
- 2 Press **◀▶** to select "Card".
- 3 Press **▲▼** to select "Video setup", and press **OK**.

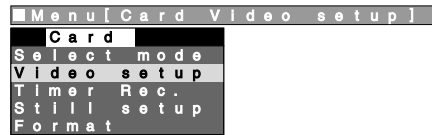

- 4 Press **▲▼** to select "Pre-recording", and press **OK**.



- 5 Press **◀▶** to select "On", and press **OK**.
- 6 Press **MENU** to exit.

NOTE

- Pre-recording is enabled only in the motion picture mode. It is not possible to capture an image a few seconds before as a still picture.
- When recording with the "Pre-recording" mode set to "On"**
 - The LAP time at playback will be a few seconds longer than the LAP time at the end of recording.
 - Depending on the timing the recording was started, the time the pre-recording can return may vary slightly, for example, immediately after selecting a channel or immediately after turning on the power.
 - When timer recording has been set in "Timer Rec.", the start time will not return even if "Pre-recording" is set to "On".

Recording a TV Programme in Real-time

Recording as a Motion Picture

Press **Cyan** to check that the desired recording mode has been selected and that the memory card has enough space for recording.

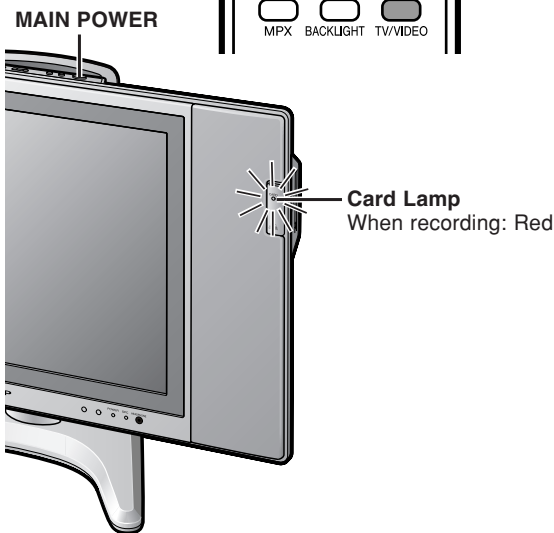
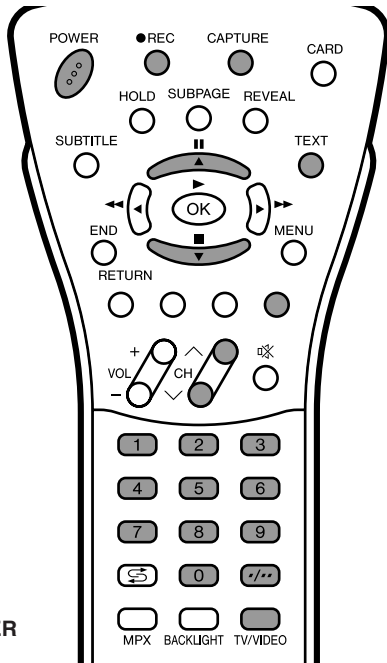

1 Press **Channel Select**, **CH** (^)/(v) or **TV/VIDEO** to select the channel you want to record.

2 Press **REC** to start recording.
 • The recording is started from the moment the button is pressed.



* When the remaining time is indicated as [08:00], this means you can record for eight more hours.

To Pause Recording

Press **II**.

- When resuming the recording, press **REC** once more.



To Stop Recording

Press **Cyan**.

- By pressing **Cyan**, you can confirm the conditions during recording.
- Press **Cyan** again to switch off the screen display.

NOTE

- When the memory card runs out of space, "Card is full" will be displayed while in the Teletext mode, and the recording will stop.
- When you press **TEXT** during the recording, "Cannot operate" is displayed. The recording itself continues.
- During teletext broadcast, **CAPTURE** is functional. However, **REC** is not functional during teletext broadcast, and "Cannot operate" is displayed.
- When **MAIN POWER** on the LCD TV set is pressed during recording, the recording cannot be stopped normally creating the danger the file is corrupted.
- Pressing **POWER** on the remote control during recording stops the recording.
- When the card has no remaining capacity left, the information display shows "Card is full" and the recording is stopped.
- During recording, you cannot switch to a different channel and you cannot switch to another input.
- When the timer reaches the stop time, the recording will be stopped.
- When you select the **COMPONENT** mode, you cannot record a motion picture.
- If the stop time is reached during timer recording the pause mode is switched on, but timer recording will continue.

Easy Recording

When pressing **REC** again during normal recording, you can easily switch to timer recording.
 Each time you press **REC**, the recording time changes as follows.

Lap → 0:30 → 1:00 → 1:30 → 2:00

Setting Timer Recording

Adjusting the Clock

The LCD TV set has a built-in clock. Be sure to adjust the clock with "Clock setup" in "Setup" before setting the timer. (See page 14.)

Timer Rec

Set the date, start time, end time, channel, and record mode for the TV programme you want to record.

You can set up to 8 programmes for timer recording up to one month in advance.

Make sure that you have finished setting channels. (See pages 12 and 13.)

• Date

The date can be set within the next one month. You can also set for daily or weekly recording.

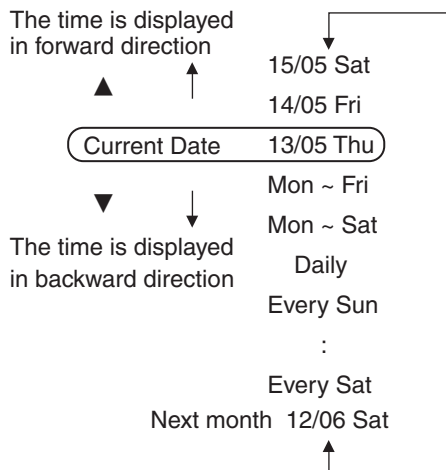

• Start/Stop

You can set the start and stop times.

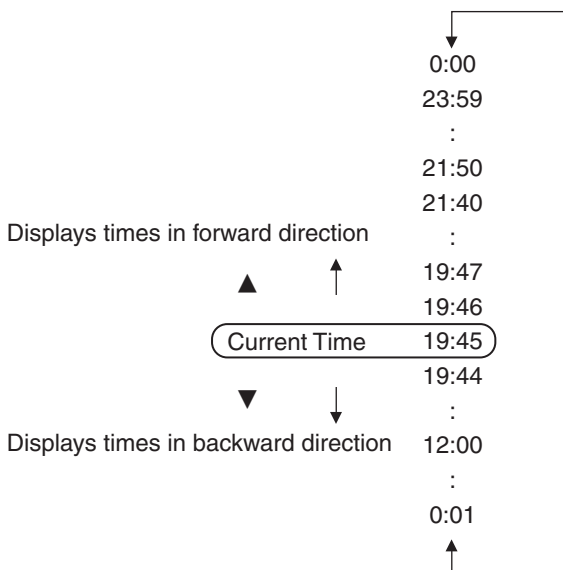

• CH

In the case of channels for which "Skip" is not set, AV1 and AV2 can be selected.

• Mode

SP, LP, EP, or FIT can be selected. (Please refer to page 34 for information of FIT.)

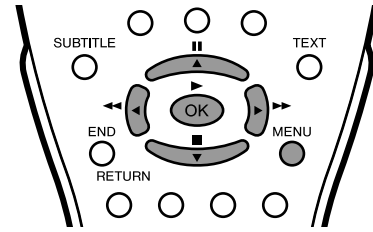

1 Press **MENU** to display the Menu screen.

2 Press **◀▶** to select "Card".

3 Press **▲/▼** to select "Timer Rec.", and press **OK**.

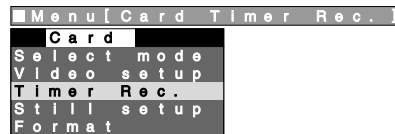

4 Press **◀▶** to select "Setup", and press **OK**.

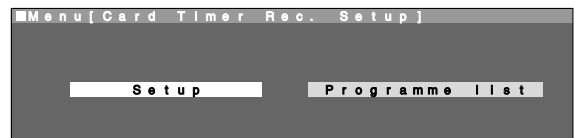

5 Press **▲/▼** to set "Date".

- You can set the date within the next one month, or you can select daily or weekly recording.

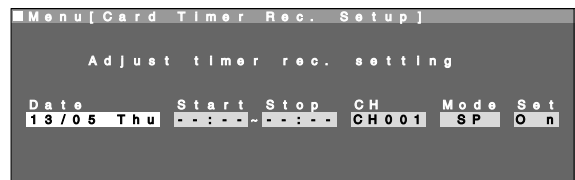

NOTE

- When the time set by the timer is reached during timer recording, the power is set to standby but the recording will be continued.

6 Press **◀▶** to select "Start".

- Press **▲** to display the time in forward direction.
- Press **▼** to display the time in backward direction.

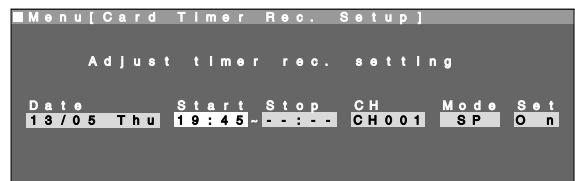

7 Press **◀▶** to select "Stop".

- Press **▲** to display the time in forward direction.
- Press **▼** to display the time in backward direction.

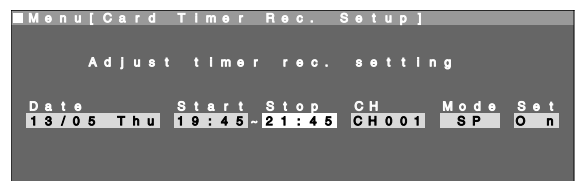

Setting Timer Recording (Continued)

- 8** Press ◀▶ to select "CH".
- When you press ▲, channels are displayed in forward direction.
 - When you press ▼, channels are displayed in backward direction.

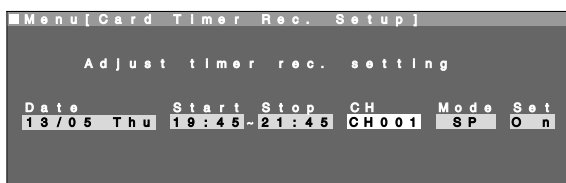

NOTE

- Programmes set to "On" in "Skip" are not displayed.

- 9** Press ◀▶ to select "Mode", and press ▲/▼ to select either "SP", "LP", "EP" or "FIT".

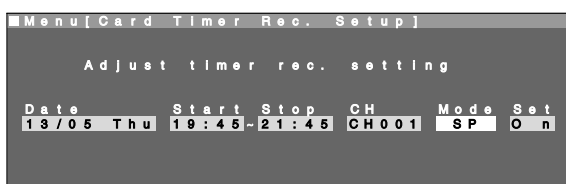

NOTE

- The recording is performed within the times set. When there is no remaining time on the card, the message "Remain 0:00" is displayed and the recording will be interrupted. In this case, use another card or delete recorded files to make more space. (See page 40.)
- FIT refers to automatic recording while adjusting image quality between SP and LP so that the recording is completed within the specified time. It may not be possible to record using FIT depending on the remaining capacity of the card.
- Two recordings cannot be programmed simultaneously for FIT.

- 10** Press ◀▶ to select "Set", and press ▲/▼ to select either "On", "Off" or "Clr".

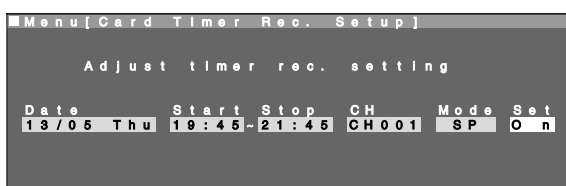

- 11** Press **OK** to set the timer.

- 12** Press **MENU** to exit.

NOTE

- Timer programming settings are cancelled when the duration of the power outage exceeds the backup time. (See page 14.)

Checking the Programme List

You can check the current recording states in the list.

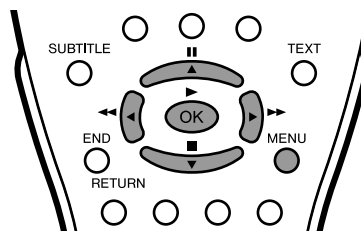

- 1** Perform steps **1** to **3** in **Timer Rec** to display the "Timer Rec." screen.

- 2** Press ◀▶ to select "Programme list", and press **OK**.

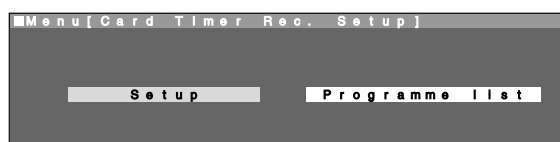

- 3** Press ▲/▼ to select the file you want to check, and press **OK**.

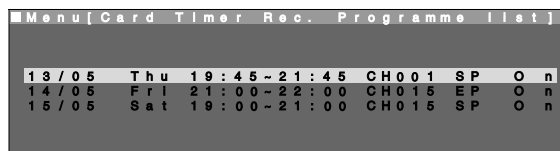

- 4** Press **MENU** to exit.

To change the programme

In the step **3** above, press ▲/▼ to select the programme to be changed or clear, and press **OK**. Press ◀▶ to select the desired item, and adjust with ▲/▼.

Checking the Recording Mode

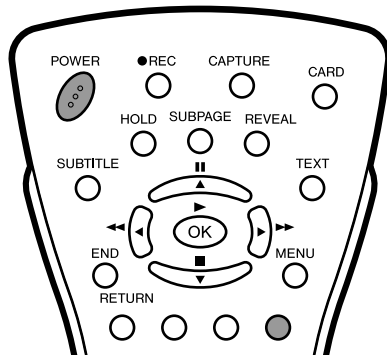

Press **Cyan**.

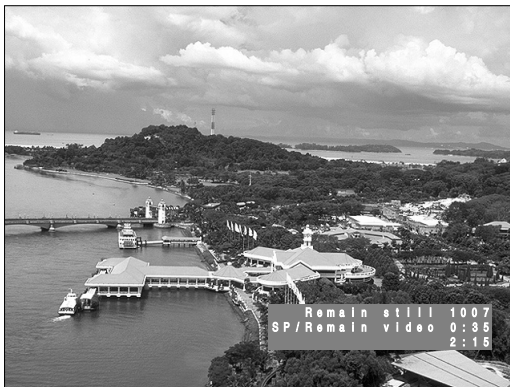

- If you turn the power off using **POWER** on the remote control while timer recording is set, both picture and sound go off at the preset recording start time and then the recording will start. (The recording also starts at the set time as well, when the power is on.)

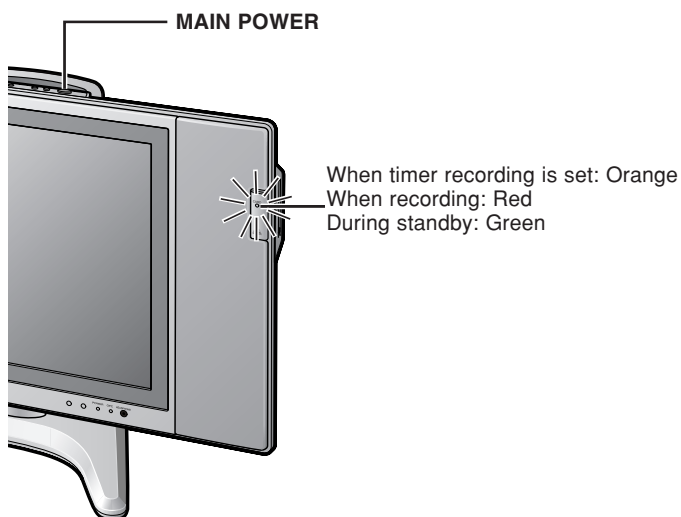

NOTE

- If you turn the power off using **MAIN POWER** on the LCD TV set, timer recording will not work.
- When the recording mode is switched to "SP", "LP", "EP" or "FIT" the remaining recording time will change accordingly.
- You cannot pause the timer recording.
- You cannot switch channels during timer recording.
- The clock cannot be adjusted while timer recording is set.
- When the Card Eject button is pressed and the card is removed during timer recording standby, the recording will take place as set when a card is reinserted.

At the Set Time

- Starts recording with the channel and the mode you have set, and stops at the end time.
- Do not remove the card during recording. Otherwise, problems may occur, causing the data including those previously recorded not to be recorded or kept properly.

If There is not Sufficient Space on a Memory Card

- Recording stops when the card runs out of free space.
- Make sure that there is enough space on a card, because timer recording can be set, like with VCRs, without taking free space in account.

If Power Outage Happens/AC Cord or DC Plug at the LCD TV Set is Unplugged During Recording

- Because the recording is not completed under normal conditions, the file cannot be stored while unnecessary data remains in the memory card. To delete unnecessary data, select "Delete file" in "Edit" and proceed to delete the file. (See page 40.)
- Start formatting the card after saving necessary files to a PC or other external media. All data and files are deleted upon format.

Playing Back Motion Pictures (Normal Mode)

Normal Playback

Modes for Playing Back Motion Pictures

Normal/Repeat/Slowmotion/Zoom

The Playback Quality of the Memory Card

As the memory card of this device records conforming to the MPEG-4 system (image compression technology), the replay image will not have the same picture quality as the image while it was being recorded.

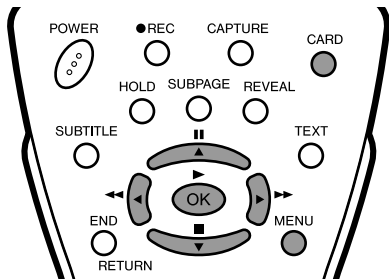

- 1 Press **CARD** to switch to the motion picture mode.
 - The recorded motion picture list is displayed.

- 2 Press **▲/▼** to select the title, and press **OK**.

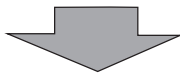
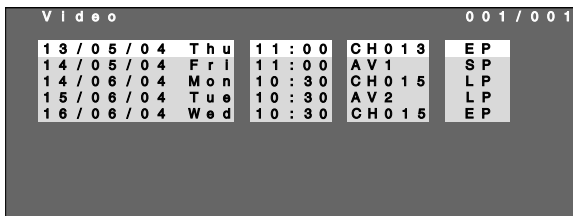

- When selecting a motion picture you paused while playing back the last time, the selection screen; "Resume" or "Top" will be displayed.



- Depending on the type of file, you may not resume a picture by selecting "Resume".



- 3 Press **MENU** to exit.

Operations while playing back

Pause	Press while playing back.
Playback	Press ▶ while pausing, fast forwarding, or fast reversing.
Fast Forward	Press ▶▶ while playing back. Pressing 2, 3 or 4 times respectively fast-forwards at 8 and 32 normal speed and back to regular speed.
Fast Reverse	Press ◀◀ while playing back. Pressing 2, 3 or 4 times respectively fast reverses at 8 and 32 normal speed and back to regular speed.
Stop	Press ■ while playing back. You will return to the recorded motion picture list.

NOTE

- If you press **■** while playing back, fast forwarding, fast reversing, or pausing, the respective operation is terminated and you will return to the recorded motion picture list.
- During fast forwarding and fast reversing, no sound is output.
- When the motion picture file is recorded using a device other than this LCD TV set, the "Resume" or "Top" selection screen may not display.

Repeat

You can specify one file or all files to replay repeatedly.

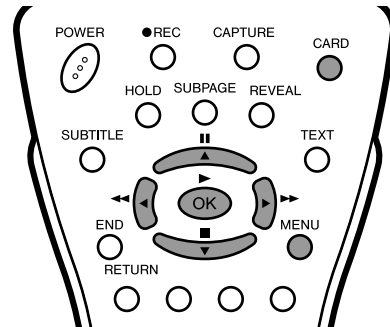

- 1 Press **CARD** to switch to the motion picture mode.
 - The recorded motion picture list is displayed.

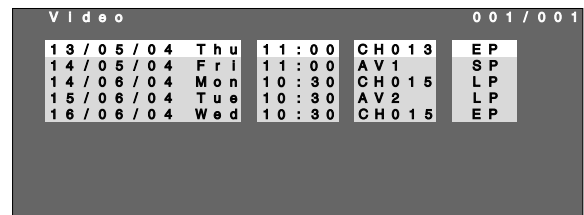

- 2 Press **MENU** to display the Menu screen. Press **◀▶** to select "Card".

- 3 Press **▲/▼** to select "Video setup", and press **OK**.

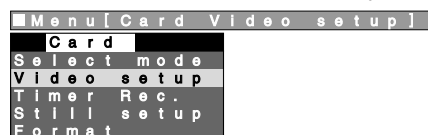

- 4 Press **▲/▼** to select "Repeat", and press **OK**.

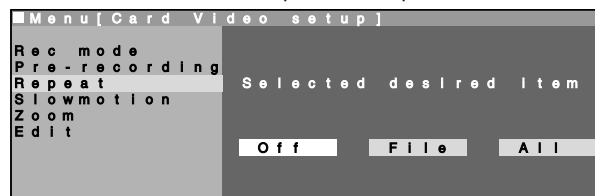

Playing Back Motion Pictures (Special Mode)

5 Press ◀▶ to select “Off”, “File” or “All”, and press **OK**.

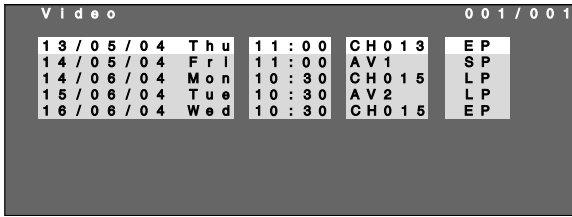

- The recorded motion picture list is displayed.

File	A file is played back repeatedly.
All	Plays back a file completely and then another in order.
Off	Does not perform repeat playback.

6 Press ▲/▼ to select the file to repeat, and press **OK**.
 • When selecting a motion picture you paused while playing back the last time, the selection screen; “Resume” or “Top” will be displayed.



7 Press **MENU** to exit.

■ When One File is Specified for Repeat Playback



NOTE

- If you press ■ while playing back, fast forwarding, fast reversing, or pausing, the respective operation is terminated and you will return to the recorded motion picture list.
- During playback of motion pictures, setting for repeat playback and slowmotion cannot be performed.

Slowmotion

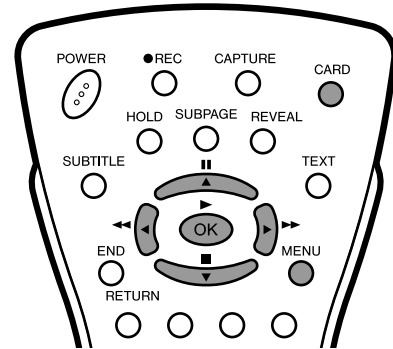

1 Press **CARD** to switch to the motion picture mode.
 • The recorded motion picture list is displayed.

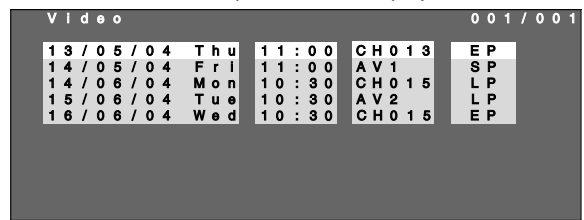

2 Press **MENU** to display the Menu screen. Press ◀▶ to select “Card”.

3 Press ▲/▼ to select “Video setup”, and press **OK**.

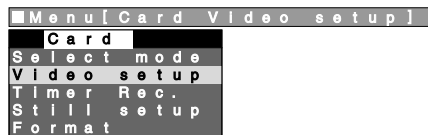

4 Press ▲/▼ to select “Slowmotion”, and press **OK**.

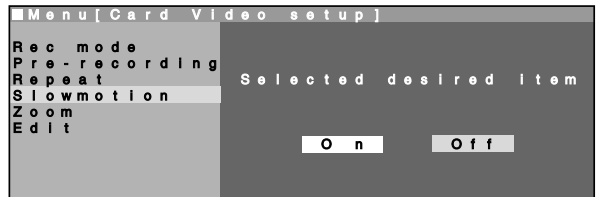

5 Press ◀▶ to select “On”, and press **OK**.

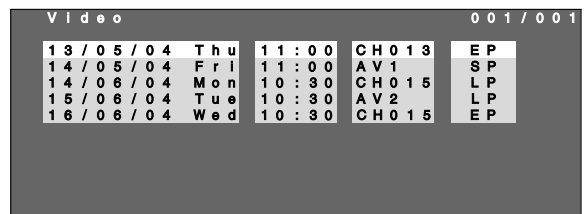

- The recorded motion picture list is displayed.

6 Press ▲/▼ to select the title to playback in slowmotion, and press **OK**.

7 Press **MENU** to exit.

Playing Back Motion Pictures (Special Mode) (Continued)

■ The Screen When Slowmotion is Specified



NOTE

- During slowmotion playback, no sound is output.
- To cancel slowmotion playback, set "Slowmotion" to "Off".

Zoom

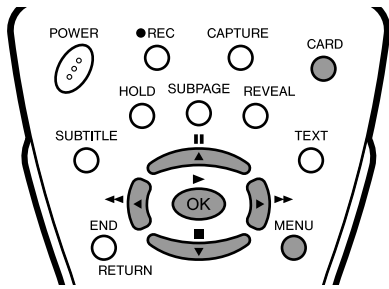

- 1 Press **CARD** to switch to the motion picture mode.
 - The recorded motion picture list is displayed.

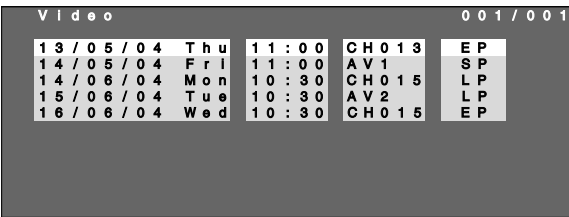

- 2 Press **MENU** to display the Menu screen. Press **◀▶** to select "Card".

- 3 Press **▲▼** to select "Video setup", and press **OK**.

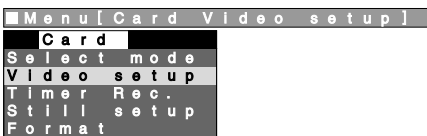

- 4 Press **▲▼** to select "Zoom", and press **OK**. Press **◀▶** to select "On", and press **OK**.



- 5 Press **▲▼** to select the title to zoom, and press **OK**.

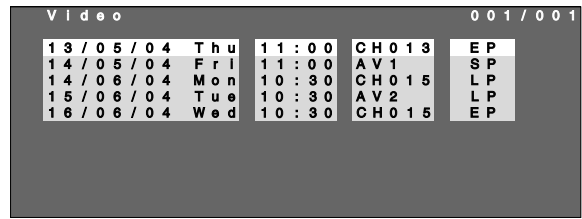

- The recorded motion picture list is displayed.
- Only when the "EP" recording mode is used, zoom playback can be performed.

- 6 Press **MENU** to exit.

■ The Screen When Zoom is Specified



When you set "Zoom" to "On".

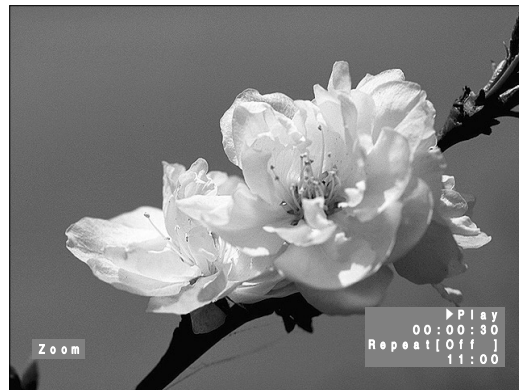

NOTE

- Only when the "EP" recording mode is used, zoom playback can be performed.

Protecting/Deleting Motion Pictures

Protecting Motion Picture Files

You can protect files you do not want to be deleted.

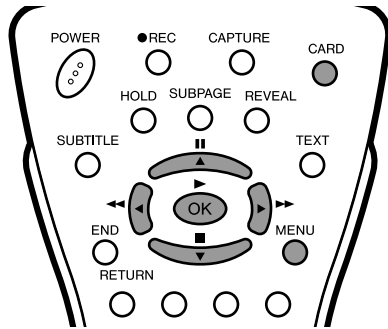

1 Press **CARD** to display the list of recorded motion pictures.

2 Press **MENU** to display the Menu screen. Press **◀▶** to select "Card".

3 Press **▲▼** to select "Video setup", and press **OK**.

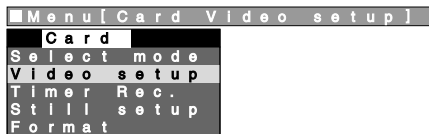

4 Press **▲▼** to select "Edit", and press **OK**.

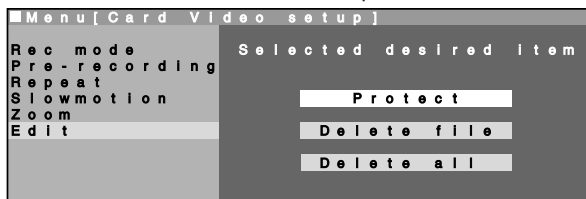

5 Press **▲▼** to select "Protect", and press **OK**.

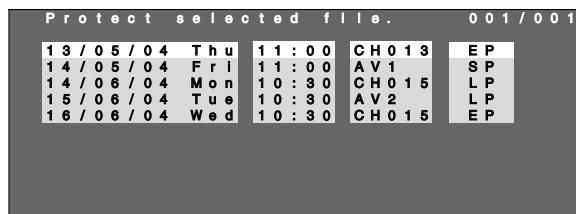

6 Press **▲▼** to select the file you want to protect, and press **OK**.



will be displayed.

7 Press **MENU** to exit.

NOTE

- Protecting the file:
By setting to protect files, you can avoid deleting files by accident. It is recommended to protect important files.

Unprotecting Motion Picture Files

- Align the cursor with the mark and press **OK**.

Protecting/Deleting Motion Pictures (Continued)

Deleting One Motion Picture File

This operation deletes one file that have not been set for protecting.

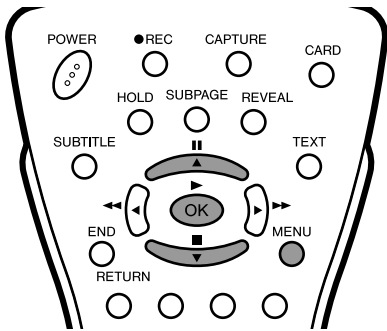

1 Perform steps 1 to 4 in **Protecting Motion Picture Files** to display the "Edit" screen.

2 Press ▲/▼ to select "Delete file", and press OK.

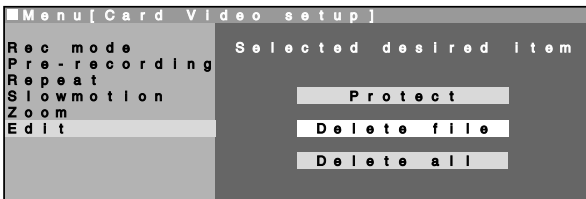

3 Press ▲/▼ to select the file you want to delete, and press OK.

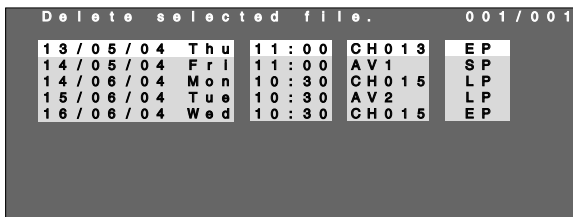

4 Press OK again.
• The selected file will be deleted.

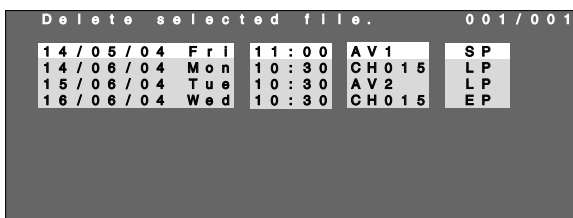

5 Press MENU to exit.

NOTE

- Do not turn off the power and do not eject the card during deletion of one file or all files. The card may not operate normally after that.
- Even if only one file is being deleted, it may take some time if it large. Please wait until the file is deleted.

Deleting All Motion Picture Files

This operation deletes all files that have not been set for protecting.

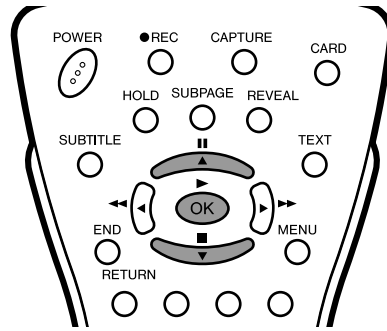

1 Perform steps 1 to 4 in **Protecting Motion Picture Files** to display the "Edit" screen.

2 Press ▲/▼ to select "Delete all", and press OK.

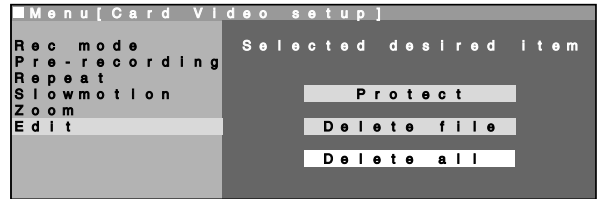

3 Press OK again.
• All files will be deleted.

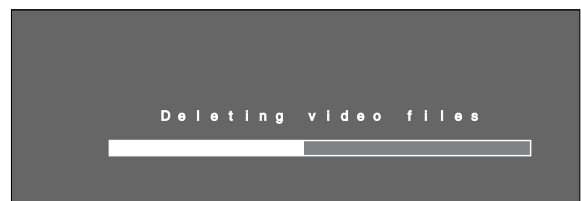
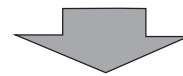

Playing Back Still Pictures

Modes for Playing Back Still Pictures

You can specify various modes with "Card" in the Menu screen.

■ Listing Still Pictures; Index (page 42)

- (1) Lists nine still pictures at a time.
- (2) Displays one still picture you select in full screen.

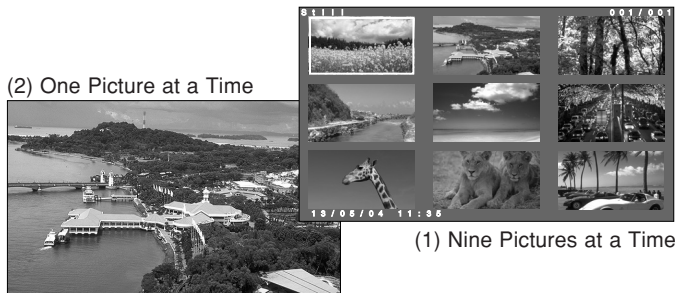

(1) Nine Pictures at a Time

■ Slideshow Setup (page 43)

You can set the interval to 1-10 seconds, 1 minute, 15 minutes or 60 minutes, and select the order from among "Normal", "Random" or "My programme". "Repeat" can also be selected.

The Slideshow Setup Screen

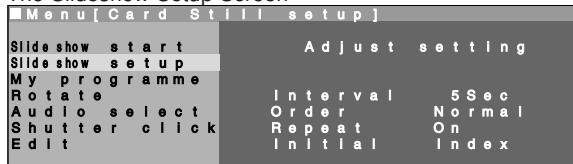

■ My Programme (page 44)

From a large number of pictures, you can select and set up to 32 pictures. (Up to 32 set pictures can be displayed in slideshow.)

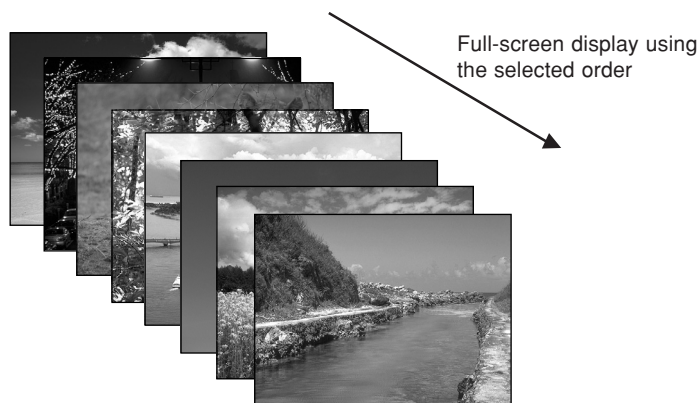

■ Rotate (page 45)

Recorded pictures can be displayed rotated 90 degrees clockwise or anticlockwise.

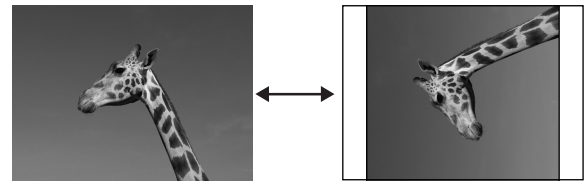

■ Audio Select (page 46)

You can select the sound played through the speaker.

The Audio Select Screen

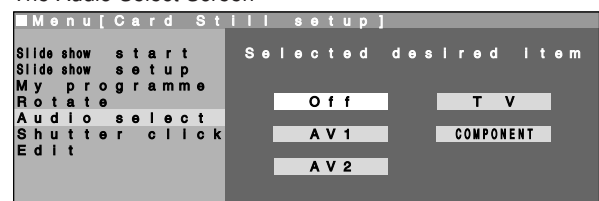

Playing Back Still Pictures (Continued)

Listing Still Pictures (Index)

Fast paging in forward/backward direction

When multiple still pictures are recorded, you can speed up paging in forward/backward direction by keeping ◀▶ depressed during paging forward/backward direction.

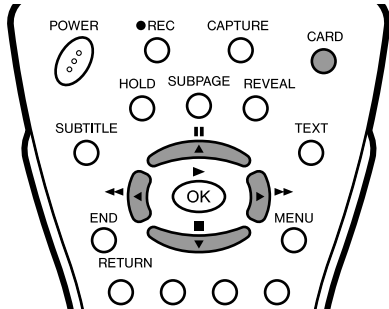

Displaying One Picture at a Time

You can select a picture from the memory card and display individually.

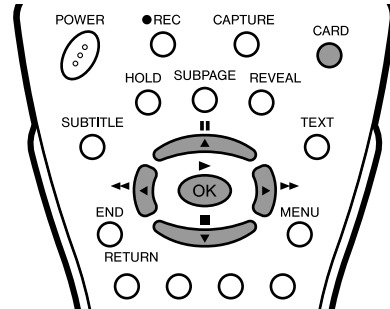

- 1 Insert the memory card. Press **CARD** to display the index of still picture.



- 1 Press **CARD** to display the index of still picture.



- 2 Press ▲/▼/◀▶ to position the cursor at the last file in the page (at the lower right), and press ▶.

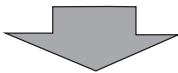

The next index page is displayed. (The cursor moves to the top file of the page.)



- 2 Press ▲/▼/◀▶ to select the picture to display, and press **OK**.



- When you press ■, you will return to the index of still picture.

NOTE

- Depending on the recording mode of digital still cameras, pictures may not be displayed in full screen.

NOTE

- After registering My Programme, if the number of files during still picture or motion picture recording has exceeded 1,024, they are not displayed in the index but they are played back from My Programme. Files that are registered in My Programme but not displayed in the index cannot be deleted from My Programme. In that case, you can only delete those particular files by first deleting files that are displayed in the index in order to make the files to be deleted appear in the Index.

Slideshow Setup

You can set the interval to 1-10 seconds, 1 minute, 15 minutes, or 60 minutes, and select the playback order from among "Normal", "Random" or "My programme".

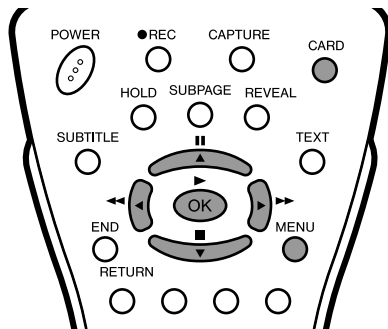

1 Press **CARD** to display the index of still picture.

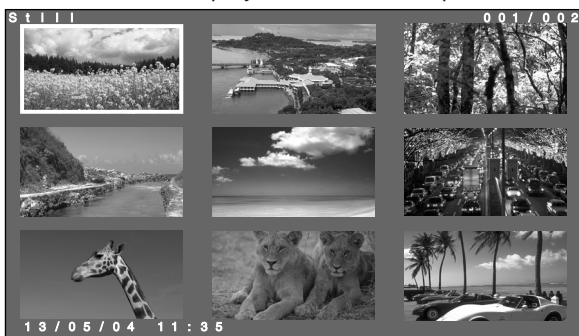

2 Press **MENU** to display the Menu screen.

3 Press **◀▶** to select "Card". Press **▲▼** to select "Still setup", and press **OK**.

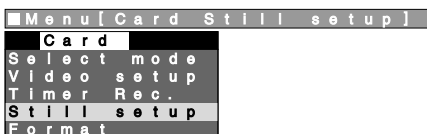

4 Press **▲▼** to select "Slideshow start", and press **OK**.

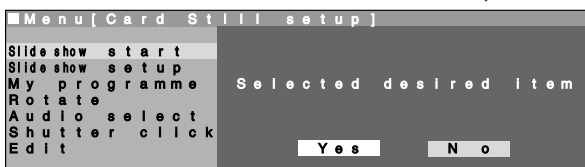

5 Press **◀▶** to select "Yes", and press **OK**.
 • The slideshow starts according to the initial mode.
 Press **MENU** if you want to change the settings halfway through.

6 Press **▲▼** to select "Still setup", and press **OK**. Press **▲▼** to select "Slideshow setup", and press **OK**.

7 Press **▲▼** to select "Interval". Press **◀▶** to select "1-10 Sec", "1 Min", "15 Min" or "60 Min".

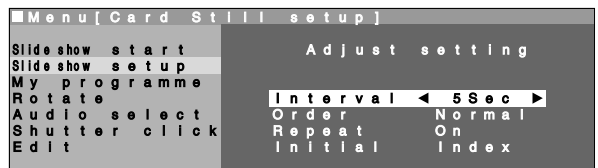

8 Press **▲▼** to select "Order". Press **◀▶** to select "Normal", "Random" or "My programme".

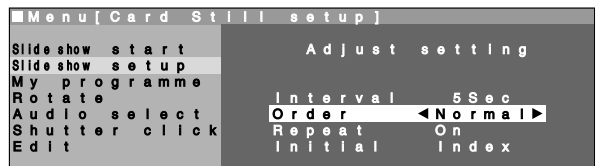

9 Press **▲▼** to select "Repeat". Press **◀▶** to select "On" or "Off".

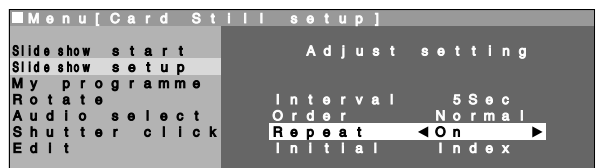

10 Press **▲▼** to select "Initial". Press **◀▶** to select "Slideshow" or "Index", and press **OK**.
 • The initial screen is the mode first displayed when switching to the still picture mode.

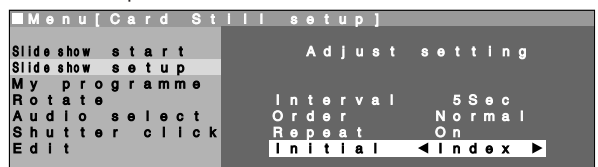

11 Press **▲▼** to select "Slideshow start", and press **OK**. Press **◀▶** to select "Yes", and press **OK**.
 • The slide show resumes in accordance with the new settings.
 If you press **■**, the slideshow will be stopped.

NOTE

- When using the slideshow for the first time after purchase, it operates in accordance with the factory presets as follows:
 Interval: 5 seconds
 Order: Normal
 Repeat: Off
- Slideshow is paused while the Menu screen is displayed.
- The display interval does not include the time it takes for the LCD TV set to process the image and display it. Therefore, the image may not be displayed for the display interval set. (In general, the processing time slows it down by 1-3 seconds.)

Playing Back Still Pictures (Continued)

My Programme

You can select up to 32 pictures and specify the order for displaying in slideshow.

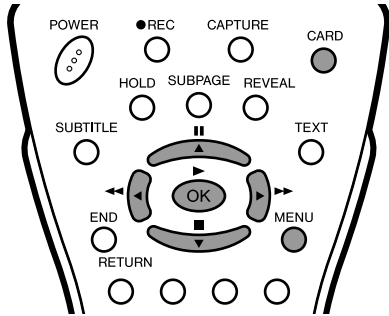

1 Press **CARD** and the index of still picture is displayed.



2 Press **MENU** to display the Menu screen.

3 Press **◀▶** to select "Card". Press **▲▼** to select "Still setup", and press **OK**.

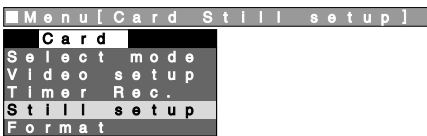

4 Press **▲▼** to select "My programme", and press **OK**.

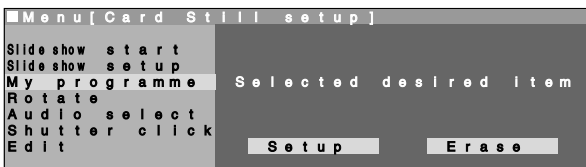

5 Press **◀▶** to select "Setup", and press **OK**.

6 Press **▲▼/◀▶** to select a picture, and press **OK**.



• The selected picture will be numbered. Pictures will be displayed in numerical order.

7 Perform the step above to select as many pictures as you like (up to 32).
• To delete the settings registered in "My programme", select "Erase" at step 4, and press **OK**.

8 Press **MENU** to exit.

NOTE

- When My Programme is set using another device, it cannot be edited.
- When My Programme is created using this device, you can add to it but you cannot edit it. Please delete all files if you want to change the order.
- After registering My Programme, if the number of files during still picture or motion picture recording has exceeded 1,024, they are not displayed in the index but they are played back from My Programme. Files that are registered in My Programme but not displayed in the index cannot be deleted from My Programme. In that case, you can only delete those particular files by first deleting files that are displayed in the index in order to make the files to be deleted appear in the Index.

Displaying Pictures in Slideshow in the Order Specified in "My programme"

Register the slideshow playback order in advance using the settings in My Programme.

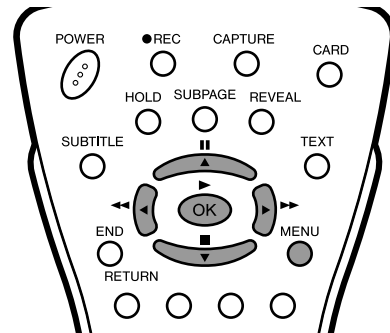

1 Press **MENU** to display the Menu screen.

2 Press **◀▶** to select "Card".

3 Press **▲▼** to select "Still setup", and press **OK**.

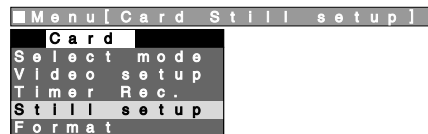

4 Press **▲▼** to select "Slideshow start", and press **OK**.

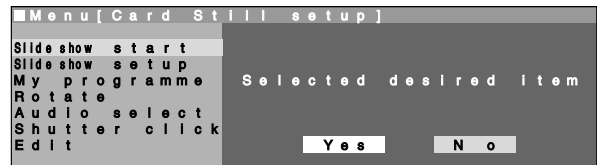

- 5** Press **◀▶** to select “Yes”, and press **OK**.
 • The slideshow will be started.



- 6** Press **MENU** to exit.

Rotate

You can rotate a displayed picture file.

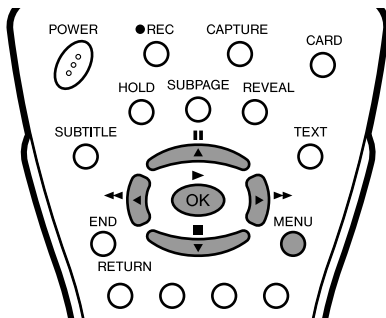

- 1** Playback the memory card. Display the picture you want to rotate in either the card playback mode or the slideshow mode.



- 2** Press **MENU** to display the Menu screen.

- 3** Press **◀▶** to select “Card”.

- 4** Press **▲/▼** to select “Still setup”, and press **OK**.

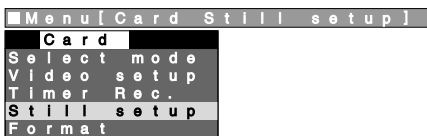

- 5** Press **▲/▼** to select “Rotate”, and press **OK**.

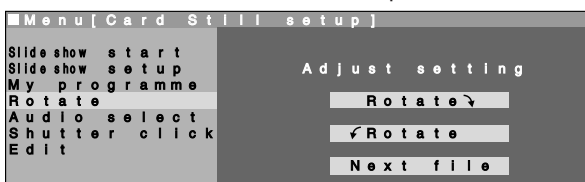

- 6** Press **▲/▼** to select “Rotate ◀” or “▶ Rotate”.

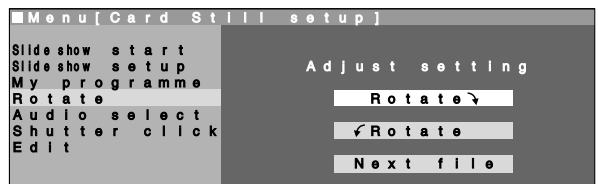

- The picture will be rotated to left or to right each time **OK** is pressed.



Rotate	Rotates the file being displayed. Select “▶ Rotate” to rotate the picture 90 degrees anti clockwise. Select “Rotate ◀” to rotate the picture 90 degrees clockwise.
--------	--

NOTE

- Pictures cannot be rotated during the index screen.
- The rotation information is deleted when the power is turned off.

Switching Files

Switches files while in the Rotate menu.

- 1** Perform steps **1** to **5** in **Rotate** to display the “Rotate” screen.

- 2** Press **▲/▼** to select “Next file”, and press **OK**.

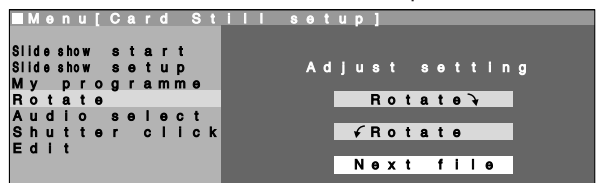

Playing Back Still Pictures (Continued)

Audio Select

Playing background music when playing back a card. You can output the sound of other devices (e.g. TV or VCR) when playing back a card.

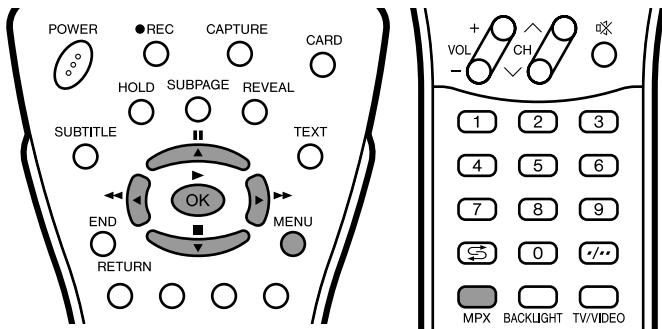

- 1 Playback the memory card. Display the picture in either the card playback mode or the slideshow mode.

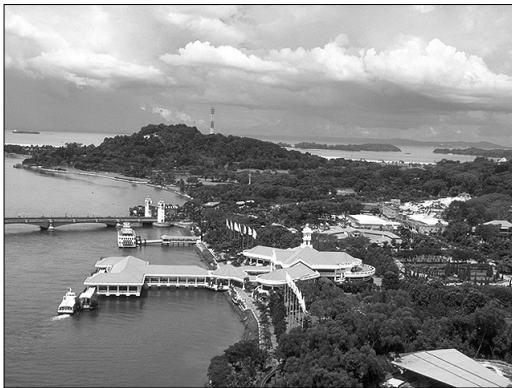

- 2 Press **MENU** to display the Menu screen.

- 3 Press **◀▶** to select "Card".

- 4 Press **▲▼** to select "Still setup", and press **OK**.

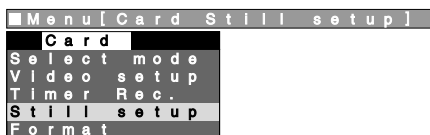

- 5 Press **▲▼** to select "Audio select", and press **OK**.

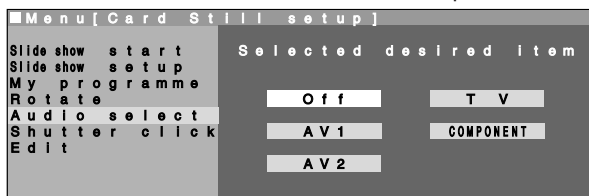

- 6 Press **▲▼◀▶** to select the sound to be output, and press **OK**.

One of the following sound setting can be selected when playing back a card.

TV	The sound of the TV channel tuned just before you switched to the card playback mode will be output. The sound of bilingual or stereo programmes becomes the sound set using the TV screen.
AV1	The sound from the device connected to AV1 will be output.
AV2	The sound from the device connected to AV2 will be output.
COMPONENT	The sound from the device connected to COMPONENT will be output.

- 7 Press **MENU** to exit.

NOTE

- Each time **MPX** is pressed during playback of still pictures, the mode changes as follows.



Recording on a Memory Card

Shutter Click

Enables you to make sure that whenever a still picture is captured the shutter sounds.

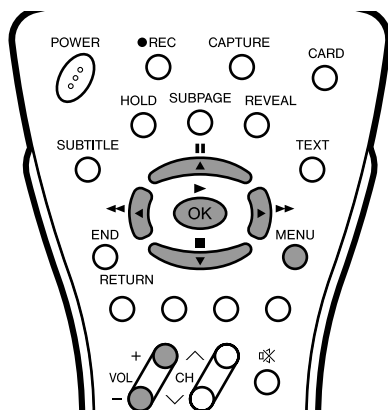

- 1 Press **MENU** to display the Menu screen.
- 2 Press **◀▶** to select "Card".
- 3 Press **▲/▼** to select "Still setup", and press **OK**.

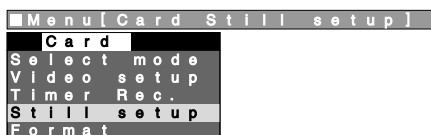

- 4 Press **▲/▼** to select "Shutter click", and press **OK**.

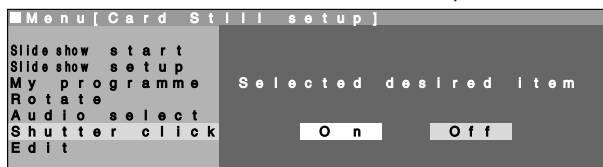

- 5 Press **◀▶** to select "On", and press **OK**.
- 6 Press **MENU** to exit.

NOTE

- The volume of the shutter sound can be adjusted using **VOL(+)/(-)**.

Capturing a TV Programme in Real-time

Capturing as Still Pictures

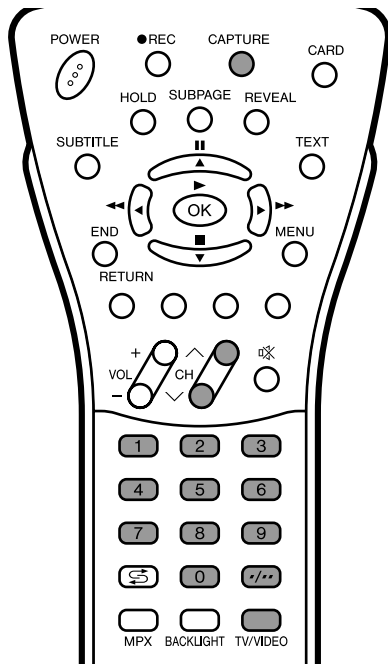

3 Whenever you want to record an image, press **CAPTURE**.



- For protecting the pictures, see “Protecting Still Picture Files” on page 49.

NOTE

- When you try to capture an image from a fast moving picture, there may be a small temporal delay in the captured picture.
- The number of remaining pictures only serves as a guide and may differ on the reception conditions and the contents of the image.
- When you select the COMPONENT mode, you cannot capture still pictures.

1 Press **Channel Select, CH (^)/(v)** or **TV/VIDEO** to select the channel you want to record.

2 Press **CAPTURE**.

- The screen freezes for a moment, and the image is recorded as a still picture.
- When “Shutter click” is set to “On”, the shutter sound can be heard at the same time. During this time, no sound from the TV or input signal can be heard.



Protecting/Deleting Still Pictures

Protecting Still Picture Files

You can protect files you do not want to be deleted.

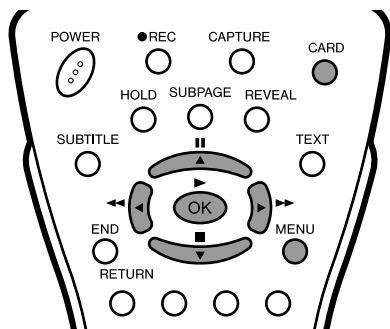

- 1 Press **CARD** to display the index of still picture.
- 2 Press **MENU** to display the Menu screen. Press **◀▶** to select "Card".
- 3 Press **▲▼** to select "Still setup", and press **OK**.

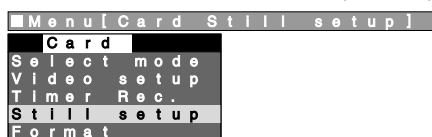

- 4 Press **▲▼** to select "Edit", and press **OK**.

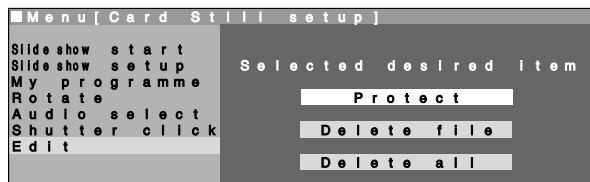

- 5 Press **▲▼** to select "Protect", and press **OK**.



- 6 Press **▲▼/◀▶** to select the file you want to protect, and press **OK**.



will be displayed.

- 7 Press **MENU** to exit.

NOTE

- Protecting the file:
 By setting to protect the file, the accidental deleting the file by mistake can be avoided. It is recommended to protect at the important files.

Unprotecting Still Picture Files

- Align the cursor with the mark and press **OK**.

Protecting/Deleting Still Pictures (Continued)

Deleting One Still Picture File

This operation deletes one file that have not been set for protecting.

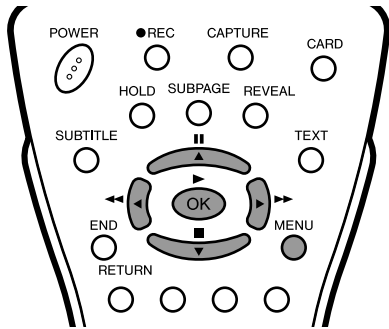

1 Perform steps 1 to 4 in **Protecting Still Picture Files** to display the "Edit" screen.

2 Press ▲/▼ to select "Delete file", and press OK.

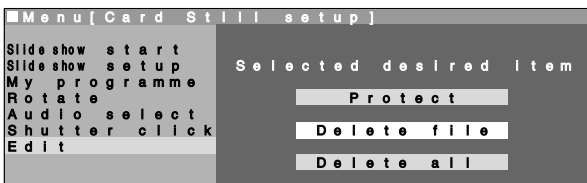

3 Press ▲/▼/◀/▶ to select the file you want to delete, and press OK.



4 Press OK again.
• Selected file will be deleted.



5 Press MENU to exit.

NOTE

- Even if only one file is being deleted, it may take some time if it is large. Please wait until the file is deleted.

Deleting All Still Picture Files

This operation deletes all files that have not been set for protecting.

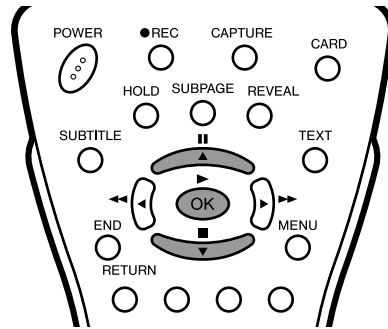

1 Perform steps 1 to 4 in **Protecting Still Picture Files** to display the "Edit" screen.

2 Press ▲/▼ to select "Delete all", and press OK.

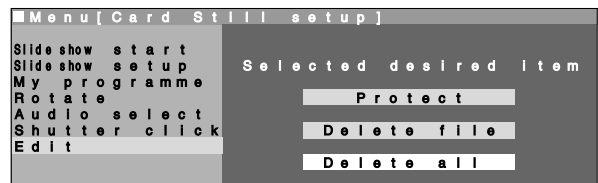

3 Press OK again.
• All files will be deleted.

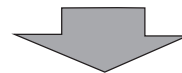

■ File display (motion picture/still picture)

When the card contains 1,024 or more motion pictures and/or still pictures, motion pictures have priority while those after number 1,024 are not displayed on the screen. When free space is created by deleting files, eject and reinsert the card or switch the power off and on again to reread the contents of the card in order to display its contents. Up to 1,024 files can be displayed with all motion pictures first followed by still pictures.

Formatting the Card

All motion picture and still picture files are deleted including any files that have been set for protecting.

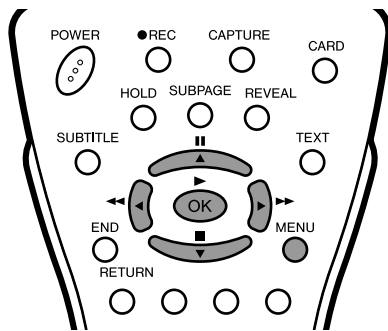

1 Run the memory card. Press **MENU** to display the Menu screen.

2 Press **◀▶** to select "Card".

3 Press **▲▼** to select "Format", and press **OK**.

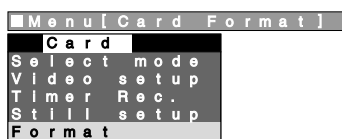

4 Press **◀▶** to select "Yes", and press **OK**.

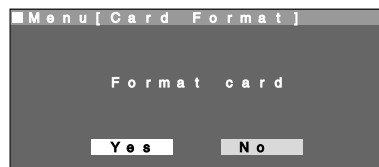

5 Press **OK** again to start formatting.

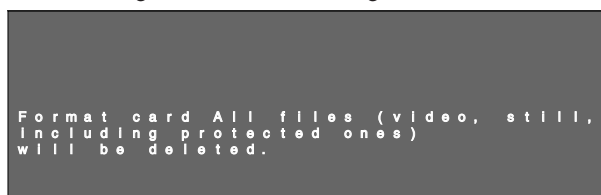

NOTE

- When you use the memory card for the first time, make sure to read the Operation manual for the card.
- The card locked with card lock function cannot be formatted.

Connecting with External Devices

You can enjoy picture and sound by connecting a VCR or a home video game system to the terminals located on the rear of the LCD TV set.

When connecting an external device, turn off the power of the LCD TV set first to prevent any possible damage.

Example of external devices that can be connected

External devices that can be connected to AV-IN1 terminal

<Example>

- Camcorder
- Home video game system

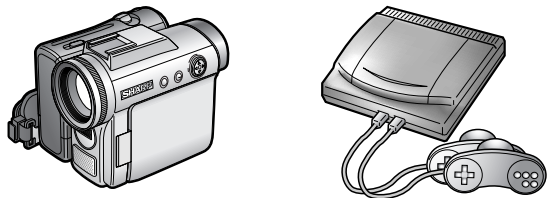

* If your external device has an S-Video terminal, S-VIDEO connection is recommended.

External devices that can be connected to COMPONENT terminal

<Example>

- DVD, etc.



* If your external device has a component terminal, COMPONENT connection is recommended (you can view high-quality pictures).

External devices that can be connected to AV-IN2 terminal

<Example>

- VCR

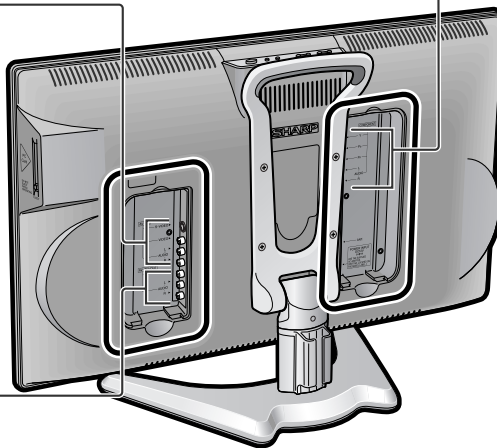

NOTE

- PC connection is not possible.
- For the cable, use a commercially available audio/video cord.
- Only connect audio/video signals to AV-IN1 and AV-IN2/OUT terminals. Connecting other signals may result in a malfunction.
- AV-IN1 has 2 video input terminals: VIDEO and S-VIDEO. When you connect external devices to both terminals (and if you select AV-IN1), you can only view pictures from the S-VIDEO terminal. To view the picture from the VIDEO terminal, do not connect any external devices to the S-VIDEO terminal.
- For more information about external device connections, see the manuals of your external devices.
- If HDTV (720P/1080I) signals are input to the COMPONENT terminals, playback cannot be viewed.

Connecting with External Devices (Continued)

Connecting a VCR, DVD player or a Camcorder (AV-IN1/2/COMPONENT)

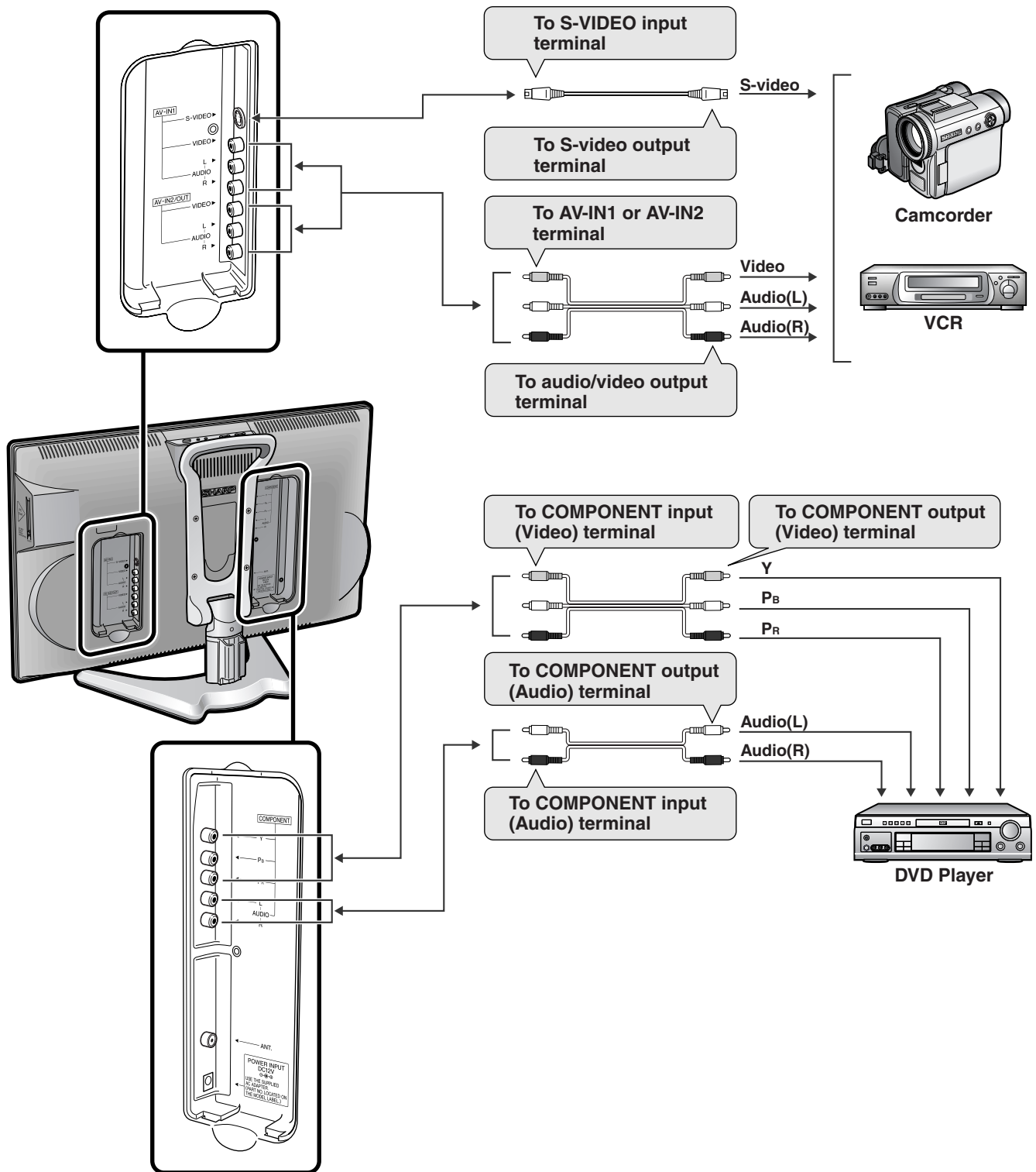

NOTE

- If your VCR (or other external devices) has an S-Video terminal, S-VIDEO connection is recommended. (Use an S-video cord.)
- When you connect external devices to both S-VIDEO and VIDEO terminals (and if you select AV-IN1), you can only view pictures from the S-VIDEO terminal.
- You cannot view multiple or synthesized pictures by connecting two or more external devices. When connecting an external device, use care to connect the video and audio cables to the corresponding terminals.
- When a monaural audio source is connected to only one of the AUDIO input terminals, sound will be heard not from both speakers but from only one speaker.

Connecting with External Devices (Continued)

Outputting video and audio (video output)

You can output video and audio data from the LCD TV set through the AV output terminals (AV-OUT).

- When using as an OUTPUT terminal, select "Setup" in the Menu and set "AV2 In/Out" to "Out". (See page 19.)
- The factory setting for "AV2 In/Out" is "In".

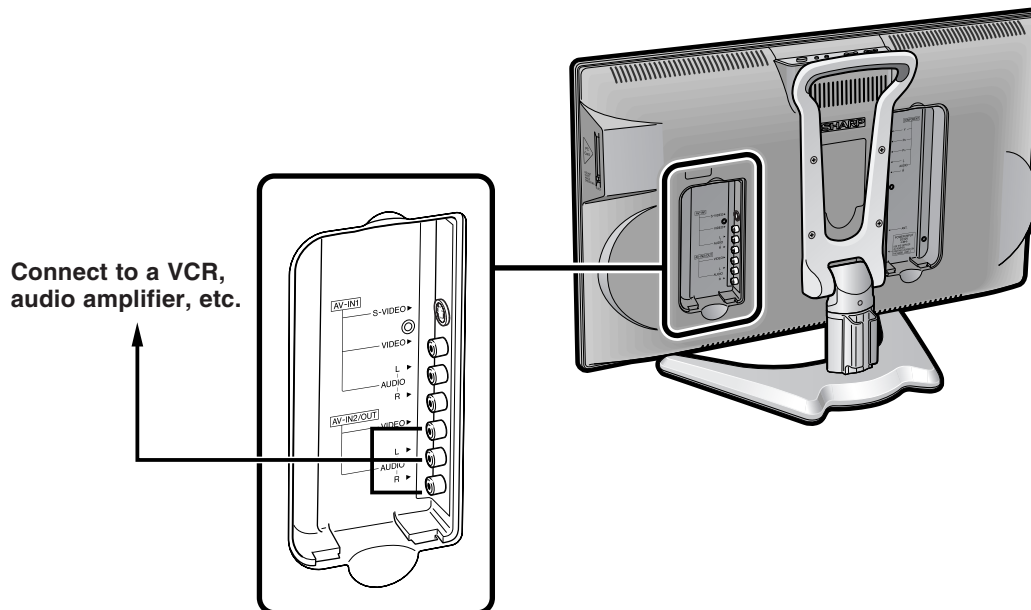





NOTE

- AV2 has 2 Out modes (see page 19).
- When using the S-VIDEO input for AV-IN1, no video output will be made to the AV output terminal, but audio output will be made for connection to external audio systems.
- When using the S-VIDEO input for AV-IN1 or Y, P_B and P_R input for COMPONENT, no video output will be made to the AV output terminal, but audio output will be made for connection to external audio systems.

Troubleshooting

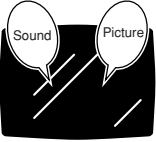
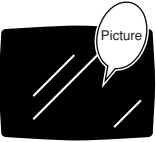
Before calling for repair services, check the following items for possible remedies to the encountered symptoms.

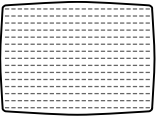
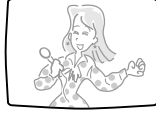
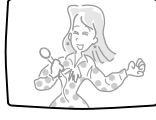
LCD TV set





Problem	Check item	Reference page
 <p>There is no picture or sound.</p>	<ul style="list-style-type: none"> • Make sure the AC adapter is properly inserted in the power outlet. • Reception other than those of broadcasting stations can be considered. • Make sure the input mode is set to the LCD TV set. • Make sure the MAIN POWER switch of the LCD TV set is on. 	<p>6</p> <p>–</p> <p>10</p> <p>10</p>
 <p>There is no picture. There is no picture from AV-IN 1/2.</p>	<ul style="list-style-type: none"> • Make sure Picture adjustment is properly adjusted. • The fluorescent lamp may have reached the end of its service life. • Make sure the S-VIDEO terminal has nothing connected. 	<p>16</p> <p>–</p> <p>8,53</p>
 <p>There is no sound.</p>	<ul style="list-style-type: none"> • Make sure the volume is not set to minimum. • Make sure the sound is not set to mute. 	<p>11</p> <p>11</p>
 <p>There is no picture or sound, just noise.</p>	<ul style="list-style-type: none"> • Make sure the antenna cable is properly connected. • Bad reception can be considered. 	<p>6</p> <p>–</p>
 <p>Picture is not clear.</p>	<ul style="list-style-type: none"> • Make sure the antenna cable is properly connected. • Bad reception could be the problem. 	<p>6</p> <p>–</p>
 <p>Picture is too light or improperly tinted.</p>	<ul style="list-style-type: none"> • Check colour adjustment. (NTSC mode) 	<p>16</p>
 <p>The picture is too dark.</p>	<ul style="list-style-type: none"> • Check if "Backlight" is set to "Dark". • Check "Contrast". • The fluorescent lamp may have reached the end of its service life. 	<p>20</p> <p>16</p> <p>–</p>
Remote control does not work.	<ul style="list-style-type: none"> • Check if batteries in the remote control have sufficient power. • Make sure the remote sensor window is not under strong lighting. 	<p>5</p> <p>5</p>
Unit cannot be operated.	<ul style="list-style-type: none"> • External influences such as lightning, static electricity, etc., may cause improper operation. In this case, operate the unit after first turning the power of the Display, or unplugging the AC cord and re-plugging it in after 1 or 2 minutes. 	<p>–</p>

■ Cautions regarding use in high and low temperature environments

- When the unit is used in a low temperature space (e.g. room, office), the picture may leave trails or appear slightly delayed. This is not a malfunction, and the unit will recover when the temperature returns to normal.
- Do not leave the unit in a hot or cold location. Also, do not leave the unit in a location exposed to direct sunlight or near a heater, as this may cause the cabinet to deform and the LCD panel to malfunction.
(Storage temperature: –20°C to +60°C)

Troubleshooting (Continued)

Antenna

Problem	Check item
 <p>The picture is not sharp.</p>  <p>The picture moves.</p>	<ul style="list-style-type: none"> • The reception may be weak. • The state of the broadcast may also be bad. • Make sure the antenna is facing the correct direction. • Make sure the outside antenna has not been disconnected.
 <p>The picture is doubled or tripled.</p>	<ul style="list-style-type: none"> • Make sure the antenna is facing the correct direction. • Broadcast waves may be reflected from adjacent mountains or buildings.
 <p>The picture is spotted.</p>	<ul style="list-style-type: none"> • There may be interference from automobiles, trains, high-voltage lines, neon lights, etc. • There may be interference between the antenna cable and power cable. Try positioning them further apart.
 <p>There are stripes on the screen or colours fade.</p>	<ul style="list-style-type: none"> • Is the unit receiving interference from other devices? Transmission antennas of radio broadcasting stations and transmission antennas of amateur radios and cellular phones may also cause interference. • Use the unit as far apart as possible from devices that may cause possible interference.

Specifications

LCD COLOUR TV COMPARISON

ITEMS	MODEL	LC-15B5M	LC-20B5M
LCD panel		15" (38 cm) Advanced Super View & BLACK TFT LCD	19.7" (50 cm) Advanced Super View & BLACK TFT LCD
Number of pixels		921,600 dots	
Video colour systems		World multi system	
TV function	TV Standard (CCIR)	I/DK/M/BG	
	TV Tuning System	Auto preset tuning	
	STEREO/BILINGUAL	NICAM-BG, I, DK/A2 stereo-BG	
	AUTO PRESET	Yes	
	CATV	S1~S41 ch. Hyper Band	
4-LINE DIGITAL COMB FILTER		Yes	
Brightness		430 cd/m ²	450 cd/m ²
Lamp life		60,000 hours*	
Viewing angles		H: 170° V: 170°	
Audio output		2.1 W × 2	
Speakers		4 × 7 cm, 2 pcs.	5.7 cm ø, 2 pcs.
Terminals	AV1	Composite Video, S-Video, Audio	
	AV2 IN/OUT	Composite Video, Audio IN/Composite Video, Audio OUT	
	COMPONENT	Y, Pb, Pr/Audio	
	Headphone jack	3.5 mm ø jack (Front)	
	PC Card Slot	PC Card Type II (PC Card Adapter)	
Image File Format		JPEG files complying with DCF format	
OSD LANGUAGE		English/Chinese/Arabic	
Power requirement		DC 12 V, AC 110–240 V, 50/60 Hz	
Power Consumption		43 W (0.7 W Standby): AC 230 V (With AC adapter)	For Asia 63 W (1.2 W Standby): AC 230 V (With AC adapter)
			For Australia 65 W (1.2 W Standby): AC 230 V (With AC adapter)
		34 W : DC 12 V	55W : DC 12 V
Weight		5.7 kg w/o accessories	9.2 kg w/o accessories
Accessories		Remote control, Batteries (×2), Antenna cable, AC adapter, AC cord, Cable holder, Operation manual	

* The typical period of time after which the lamp's power output will have decreased by about half, given that the AQUOS is used continuously in a 25°C room under standard lighting and brightness conditions.

■ As a part of policy of continuous improvement, SHARP reserves the right to make design and specification changes for the LCD TV set improvement without prior notice. The performance specification figures indicated are nominal values of production units. There may be some deviations from these values in individual units.

Time Zone Table

Only major regions are shown below. Check the actual time difference of your area.

Region	Time difference with global standard time
* New Zealand * Fiji	+ 12
New Caledonia	+ 11
Australia (AEST) * • ACT (Canberra) * • NSW (Sydney) • QLD (Brisbane) * • VIC (Melbourne) * • TAS (Hobart)	+ 10
Papua New Guinea	
Australia (ACST) • Broken Hill • NT (Darwin) * • SA (Adelaide)	+ 9:30
Japan (JST) South Korea Indonesia (Eastern area)	+ 9
Indonesia (Central area) Australia (AWST) • WA (Perth) Singapore China Hong Kong Taiwan Philippines Malaysia	+ 8
Indonesia (Western area) Cambodia Thailand Vietnam Laos	+ 7
Myanmar	+ 6:30
Sri Lanka Bangladesh	+ 6
Nepal	+ 5:45
India	+ 5:30
Pakistan	+ 5
Afghanistan	+ 4:30
U.A.E. Oman	+ 4
* Iran	+ 3:30
Republic of Yemen * Iraq Ethiopia Qatar Kuwait Saudi Arabia Sudan Bahrain	+ 3
* Egypt * Greece * Syria Libya	+ 2

* Daylight saving adoption area

Dimensional Drawings

LC-15B5M

Unit: mm

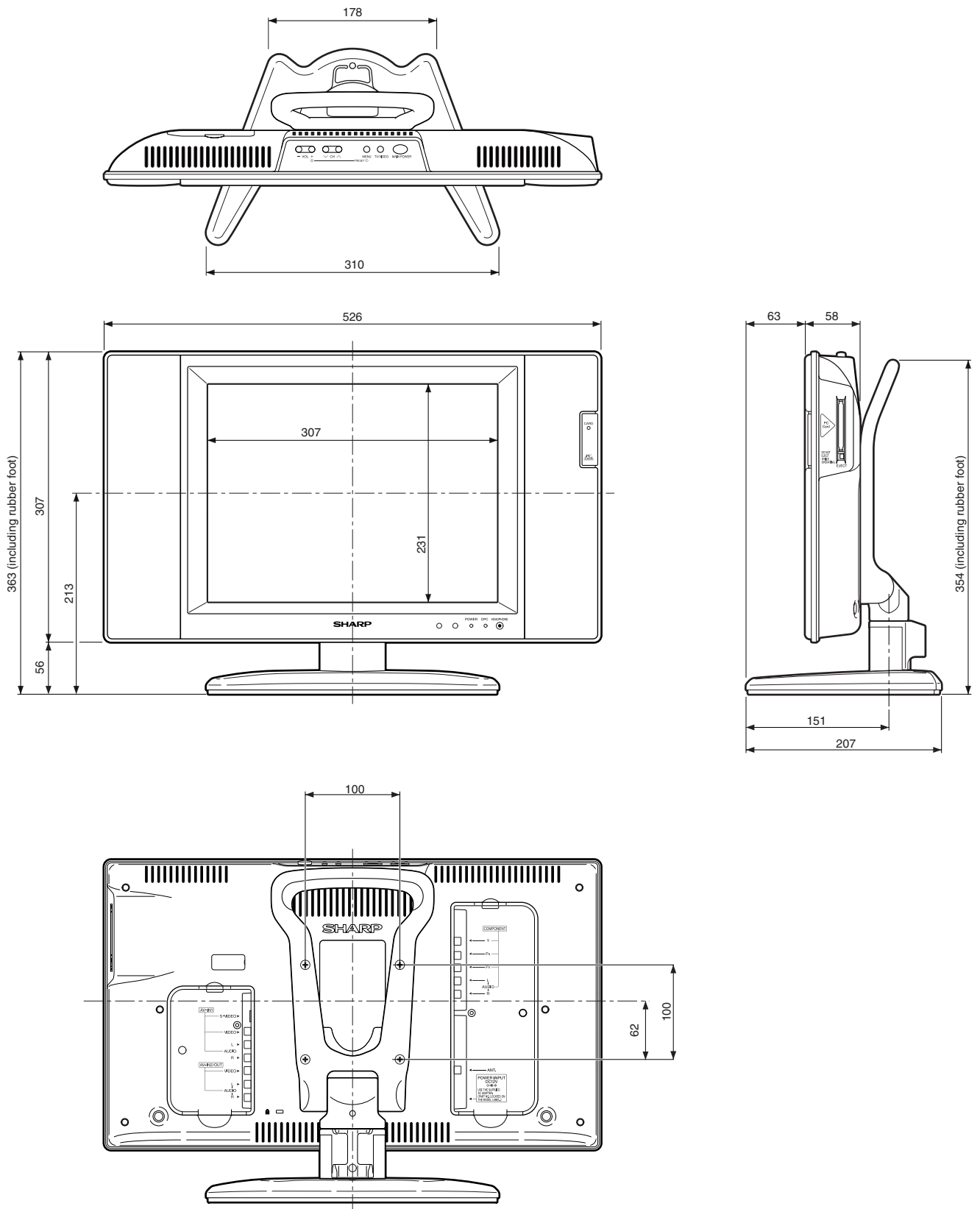

Dimensional Drawings (Continued)

LC-20B5M

Unit: mm

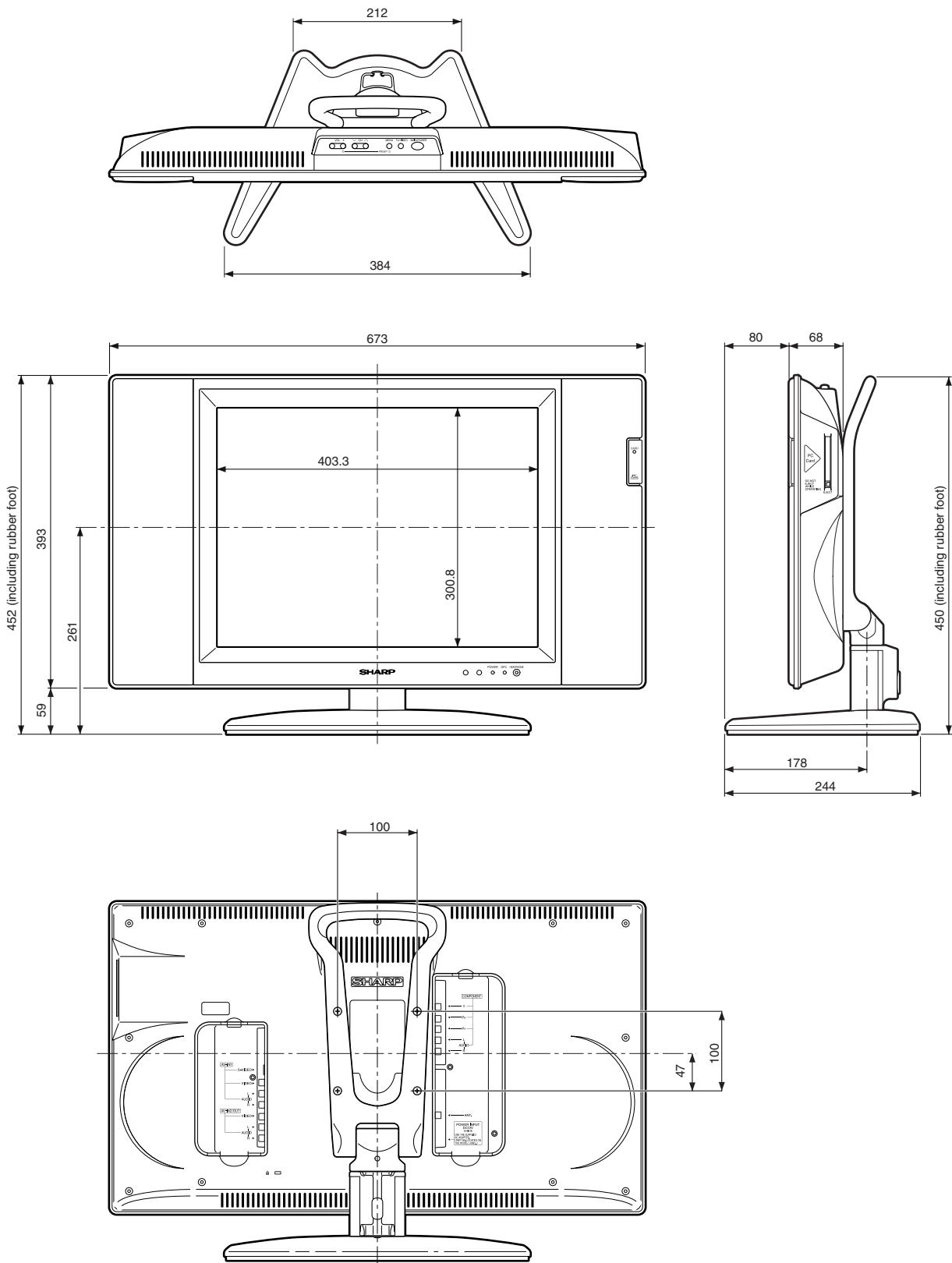

Free Manuals Download Website

<http://myh66.com>

<http://usermanuals.us>

<http://www.somanuals.com>

<http://www.4manuals.cc>

<http://www.manual-lib.com>

<http://www.404manual.com>

<http://www.luxmanual.com>

<http://aubethermostatmanual.com>

Golf course search by state

<http://golfingnear.com>

Email search by domain

<http://emailbydomain.com>

Auto manuals search

<http://auto.somanuals.com>

TV manuals search

<http://tv.somanuals.com>