

SHARP®

AQUOS AUDIO

BD-MPC41U

OPERATION MANUAL
MANUAL DE OPERACIÓN
MODE D'EMPLOI

HOME THEATER WITH
BLU-RAY DISC/DVD PLAYER
SISTEMA DE TEATRO EN CASA CON
REPRODUCTOR DE BLU-RAY Y DVD
CINÉMA-MAISON AVEC LECTEUR
DE DISQUE BLU-RAY/DVD

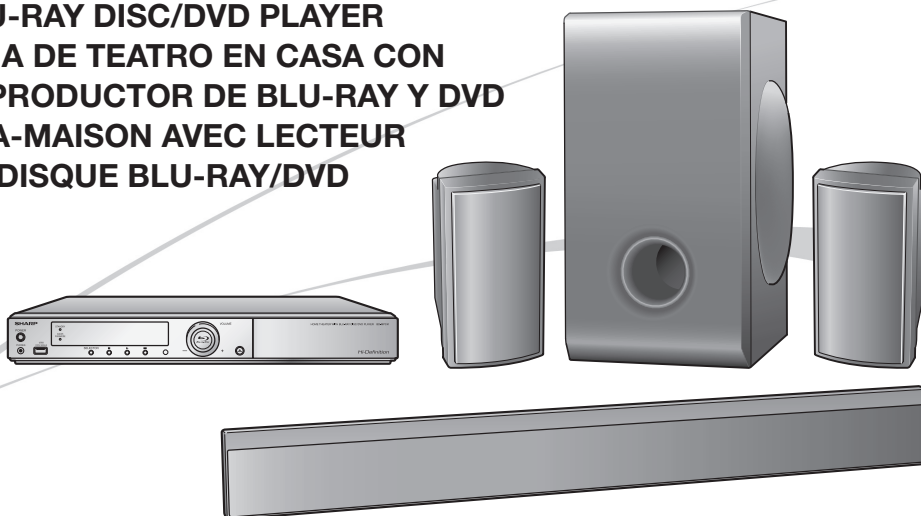

ENGLISH

ESPAÑOL

FRANÇAIS

AQUOS LINK



BD-Video



RW
COMPATIBLE



AUDYSSEY
DYNAMIC VOLUME
BASS XT



MP3



AVCHD

x.v.Color

For future reference, record the model and serial number (located on the rear of the product) in the space provided.

Model No.: _____
Serial No.: _____

WARNING: TO REDUCE THE RISK OF FIRE OR ELECTRIC SHOCK, DO NOT EXPOSE THIS APPLIANCE TO RAIN OR MOISTURE.



CAUTION
RISK OF ELECTRIC SHOCK
DO NOT OPEN



CAUTION:
TO REDUCE THE RISK OF ELECTRIC SHOCK, DO NOT REMOVE COVER. NO USER-SERVICEABLE PARTS INSIDE. REFER SERVICING TO QUALIFIED SERVICE PERSONNEL.



This symbol warns the user of uninsulated voltage within the unit that can cause dangerous electric shocks.



This symbol alerts the user that there are important operating and maintenance instructions in the literature accompanying this unit.

“WARNING—FCC Regulations state that any unauthorized changes or modifications to this equipment not expressly approved by the manufacturer could void the user’s authority to operate this equipment.”

INFORMATION

This equipment has been tested and found to comply with the limits for a Class B digital device, pursuant to Part 15 of the FCC Rules. These limits are designed to provide reasonable protection against harmful interference in a residential installation. This equipment generates, uses and can radiate radio frequency energy and, if not installed and used in accordance with the instructions, may cause harmful interference to radio communications. However, there is no guarantee that interference will not occur in a particular installation. If this equipment does cause harmful interference to radio or television reception, which can be determined by turning the equipment off and on, the user is encouraged to try to correct the interference by one or more of the following measures:

- Reorient or relocate the receiving antenna.
- Increase the separation between the equipment and receiver.
- Connect the equipment into an outlet on a circuit different from that to which the receiver is connected.
- Consult the dealer or an experienced radio/TV technician for help.

“Note to CATV system installer: This reminder is provided to call the CATV system installer’s attention to Article 820-40 of the National Electrical Code that provides guidelines for proper grounding and, in particular, specifies that the cable ground shall be connected to the grounding system of the building, as close to the point of cable entry as practical.”

CAUTION:

USE OF CONTROLS OR ADJUSTMENTS OR PERFORMANCE OF PROCEDURES OTHER THAN THOSE SPECIFIED HEREIN MAY RESULT IN HAZARDOUS RADIATION EXPOSURE.

AS THE LASER BEAM USED IN THIS UNIT IS HARMFUL TO THE EYES, DO NOT ATTEMPT TO DISASSEMBLE THE CABINET. REFER SERVICING TO QUALIFIED PERSONNEL ONLY.

- This system is classified as a CLASS 1 LASER product.
- The CLASS 1 LASER PRODUCT label is located on the side of the product.
- This product contains a low power laser device. To ensure continued safety do not remove any cover or attempt to gain access to the inside of the product. Refer all servicing to qualified personnel.

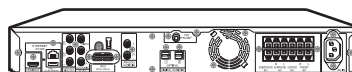

Contents

Introduction

Contents	2-3
DEAR SHARP CUSTOMER	4
IMPORTANT SAFETY INSTRUCTIONS	4-5
Precautions	6
Main Features	7
What would you like to do with this system?	8
About Media Types	9-11
Blu-ray Disc	9
Types of Discs that Can Be Used with This System	9
Discs that Cannot Be Used with This System	9-10
About Disc Contents	11
BD Video	11
Title, Chapter and Track	11
Icons Used on DVD Video Disc Cases	11
The Icons Used in This Operation Manual	11
Important Information	12
Disc Precautions	12
Copyright	12
Getting Started	13-14
Major Components	15-17
Main Unit (Front)	15
Main Unit (Rear)	15
Sound Bar Speaker (Magnetically Shielded)	16
Surround Speakers	16
Subwoofer	16
Front Panel Display	16
Remote Control	17

Connection and Setup

Positioning the Speaker System	18-21
Placing the Speaker System	18
Important points on speaker location	18
Magnetically shielded speakers	18
How to apply foot cushions	19
To mount the speakers on the wall	19
To mount the Sound Bar Speaker on the wall	20
To mount the Surround Speakers on the wall	21
Speaker Connections	22-23
Speaker Connections	22
Connecting speaker wires	23
About the wire arrangement of Sound Bar speaker	23
TV Connections	24-27
Connecting to the HDMI Terminal and the DIGITAL AUDIO IN Terminal	24
Selecting the priority video output when connecting HDMI and Component video	25
HDMI cable holder on the rear of the main unit	25
Connecting to the COMPONENT VIDEO OUT Jacks and ANALOG AUDIO IN Jacks	26
Connecting to the VIDEO OUT Jack and ANALOG AUDIO IN Jacks	27
Audio Connections	28-31
Connecting to the DIGITAL AUDIO IN Terminal	28
Connecting the ANALOG AUDIO IN Jacks	29
Connecting to the iPod Terminal	30
Connecting to the 2CH AUDIO output Jacks	31
Broadband Internet Connection	32
Connecting to the ETHERNET terminal	32
Antenna Connection	33
Connecting to the FM ANT Jack	33
Connecting a supplied FM antenna wire	33
Connecting an external FM antenna	33

Preparations and Basic Operations

Before Starting Playback	34-40
Loading the Batteries in the Remote Control	34
Approximate operating range of remote control	34
Connecting the Power Cord	34
Setting the Remote Control Code	35
Setting the remote control code of the remote control	35
Setting the remote control code of the system	35
Turning the Power On	36

Turning the power on	36
Entering standby	36
Indicators on the Main Unit	36
Language Setting	37
Changing the on-screen display language	37
RSS Reader function	37
Control Panel	38
Speaker Settings	39-40
Setting configuration	39
Testing the speaker settings	40
Adjusting the level	40
Completing the settings	40
Basic Operations	41-42
Loading a Disc	41
Input Selection	41
Changing the input selection on the main unit	41
Changing the input selection with the remote control	41
Volume Adjustment	41
Adjusting the volume	41
Muting the sound	41
Changing the Display	42
Using Headphones	42
To Dim the Display	42
Operating a SHARP TV Using the Remote Control	42
TV function control	42
AQUOS LINK Control	43-44
Controlling This System Using AQUOS LINK	43
Watching TV with AQUOS LINK	44
Listening to the sound of the AQUOS TV through this system	44
Listening to the sound through the AQUOS TV sound reproduction	44
Using this system to enjoy the sound of your AQUOS TV	44
Using the TV remote control to control playback	44

Enjoying Video and Audio Playback

Video/Picture/Music Playback	45-54
BD/DVD Video Playback	45
Displaying the disc information	45
BD/DVD Menus	46
Start playback by selecting a title from the top menu	46
Using the disc menu	46
Using the pop-up menu	46
Enjoying BONUSVIEW or BD-LIVE	47-48
Use of Picture in Picture function (secondary audio/video playback)	47
Virtual Package	47
BD-LIVE	48
DVD-R/-RW (VR format) / BD-RE/-R (BDAV format) Playback	48-49
Playback by selecting a title	48
Playback by selecting a chapter	49
Sorting the titles	49
Playback by selecting a Playlist	49
Playback from the beginning or resume playback	49
Audio CD Playback	50
Playback from the beginning	50
Playback by selecting a track	50
Operation procedure for the "Functions" menu	50
Audio Data (MP3 File) Playback	51
Playing back Audio data (MP3 files)	51
To play another file during Playback	51
To skip the file during Playback	51
Displaying Still Images (JPEG files)	52
Displaying Still Images (JPEG files)	52
Playing back Slide Show	52
Setting slide show speed/repeat playback	52
Instantly Watching Movies from Netflix	53-54
Settings for watching Netflix content on your TV	53
Adding content to the Instant Queue	54
Playing back content in the Instant Queue on your TV	54
Fast Forward/Reverse	54

Contents

Playback Functions	55-57
Fast Forward/Reverse (Search)	55
Skipping to the Next or the Start of the Current Chapter (Track/Title).....	55
Pause/Frame Advance Playback.....	55
Slow Playback	55
Skip Search	55
Replay	55
Repeat Playback of a Title or Chapter (Repeat Playback)	56
Partial Repeat Playback (Repeat Playback of a Specified Part)	56
Displaying the Audio Information	57
Switching Subtitles.....	57
Switching the Angle	57
Displaying the Angle Mark.....	57
Settings During Playback	58-59
Function Control	58
Function Control operation procedure.....	58
Functions which can be set	59
Listening to the iPod	60-61
Connecting the iPod	60
iPod Playback.....	61
Listening to the FM Broadcast	62
Tuning.....	62
Receiving Stereo FM Broadcasts	62
Presetting a Station.....	62
Recalling a preset station	62
Clearing all preset stations	62
Audio Settings and Operations	63-66
Audio Setting Display	63
Various Audio Settings	63
Changing the audio setting	63
Audio delay setting	63
Enjoying Multi-Channel Mode.....	64
Audyssey Technology	64
Enjoying a Surround Sound Effect (Sound Mode).....	65
Enjoying preset sound mode.....	65
Selectable sound modes	65
Dynamic Volume	66
Dynamic EQ.....	66
Fine-tuning the subwoofer level.....	66
Fine-tuning the center speaker level.....	66
Settings	67-79
SETTINGS	67-79
Common operations	67
Basic Operation for Playback Setting	67
Audio Video Settings.....	68
Speaker Settings	69
Smart Settings.....	69
AQUOS LINK.....	69
Playback Setting.....	70
On Screen Language	70
Version.....	70
System	70
Communication Setup	71-73
The operation procedure for inputting characters manually.....	73
USB Memory Management.....	74
Software Update Settings	75-78
Auto Update from Network	75
Manual Update from Network.....	76
Manual Update from USB memory device	77-78
Appendix	80-82
Troubleshooting	80-82
Error Messages	83
To Reset this System	83
Specifications	84
Glossary	85-87
Network Service Disclaimer	88
About Software License	89
LIMITED WARRANTY	90-91

What to do first:

Refer to “Getting Started” (pp. 13-14) to prepare for using this system.

Introduction (pp. 1-17)

Explains the important operation information.

Connection and Setup (pp. 18-33)

Shows the connecting options provided by this system.

Preparations and Basic Operations (pp. 34-44)

Explains the settings required for operation and the basic operations.

Enjoying Video and Audio Playback (pp. 45-66)

Explains functions and operations for enjoying video and audio playback.

Settings (pp. 67-79)

Gives you more options to suit your circumstances.

Appendix (pp. 80-91)

Provides troubleshooting tips and more information.

The illustrations and on-screen displays in this operation manual are for explanation purposes and may vary slightly from the actual operations.

DEAR SHARP CUSTOMER

Thank you for your purchase of the SHARP Home Theater with Blu-ray Disc/DVD Player. To ensure safety and many years of trouble-free operation of your product, please read the Important Safety Instructions carefully before using this product.

IMPORTANT SAFETY INSTRUCTIONS

Electricity is used to perform many useful functions, but it can also cause personal injuries and property damage if improperly handled. This product has been engineered and manufactured with the highest priority on safety. However, improper use can result in electric shock and/or fire. In order to prevent potential danger, please observe the following instructions when installing, operating and cleaning the product. To ensure your safety and prolong the service life of your Home Theater with Blu-ray Disc/DVD Player, please read the following precautions carefully before using the product.

- 1) Read these instructions.
- 2) Keep these instructions.
- 3) Heed all warnings.
- 4) Follow all instructions.
- 5) Do not use this apparatus near water.
- 6) Clean only with dry cloth.
- 7) Do not block any ventilation openings. Install in accordance with the manufacturer's instructions.
- 8) Do not install near any heat sources such as radiators, heat registers, stoves, or other apparatus (including amplifiers) that produce heat.
- 9) Do not defeat the safety purpose of the polarized or grounding-type plug. A polarized plug has two blades with one wider than the other. A grounding type plug has two blades and a third grounding prong. The wide blade or the third prong are provided for your safety. If the provided plug does not fit into your outlet, consult an electrician for replacement of the obsolete outlet.
- 10) Protect the power cord from being walked on or pinched particularly at plugs, convenience receptacles, and the point where they exit from the apparatus.
- 11) Only use attachments/accessories specified by the manufacturer.
- 12) Use only with the cart, stand, tripod, bracket, or table specified by the manufacturer, or sold with the apparatus. When a cart is used, use caution when moving the cart/apparatus combination to avoid injury from tip-over.
- 13) Unplug this apparatus during lightning storms or when unused for long periods of time.
- 14) Refer all servicing to qualified service personnel. Servicing is required when the apparatus has been damaged in any way, such as power-supply cord or plug is damaged, liquid has been spilled or objects have fallen into the apparatus, the apparatus has been exposed to rain or moisture, does not operate normally, or has been dropped.



Additional Safety Information

- 15) Power Sources—This product should be operated only from the type of power source indicated on the marking label. If you are not sure of the type of power supply to your home, consult your product dealer or local power company. For products intended to operate from battery power, or other sources, refer to the operating instructions.
- 16) Overloading—Do not overload wall outlets, extension cords, or integral convenience receptacles as this can result in a risk of fire or electric shock.
- 17) Object and Liquid Entry—Never push objects of any kind into this product through openings as they may touch dangerous voltage points or short-out parts that could result in a fire or electric shock. Never spill liquid of any kind on the product.
- 18) Damage Requiring Service—Unplug this product from the wall outlet and refer servicing to qualified service personnel under the following conditions:
 - a) When the AC cord or plug is damaged,
 - b) If liquid has been spilled, or objects have fallen into the product,
 - c) If the product has been exposed to rain or water,
 - d) If the product does not operate normally by following the operating instructions.
Adjust only those controls that are covered by the operating instructions as an improper adjustment of other controls may result in damage and will often require extensive work by a qualified technician to restore the product to its normal operation,
 - e) If the product has been dropped or damaged in any way, and
 - f) When the product exhibits a distinct change in performance - this indicates a need for service.
- 19) Replacement Parts—When replacement parts are required, be sure the service technician has used replacement parts specified by the manufacturer or have the same characteristics as the original part. Unauthorized substitutions may result in fire, electric shock, or other hazards.
- 20) Safety Check—Upon completion of any service or repairs to this product, ask the service technician to perform safety checks to determine that the product is in proper operating condition.
- 21) Wall or ceiling mounting—When mounting the product on a wall or ceiling, be sure to install the product according to the method recommended by the manufacturer.
- 22) The main AC plug is used as disconnect device and shall always remain readily operable.

IMPORTANT SAFETY INSTRUCTIONS

- **Outdoor Antenna Grounding** — If an outside antenna or cable system is connected to the product, be sure the antenna or cable system is grounded so as to provide some protection against voltage surges and built-up static charges.
- Article 810 of the National Electrical Code, ANSI/NFPA 70, provides information with regard to proper grounding of the mast and supporting structure, grounding of the lead-in wire to an antenna discharge unit, size of grounding conductors, location of antenna-discharge unit, connection to grounding electrodes, and requirements for the grounding electrode.

Example of antenna grounding as per National Electrical Code, ANSI/NFPA 70

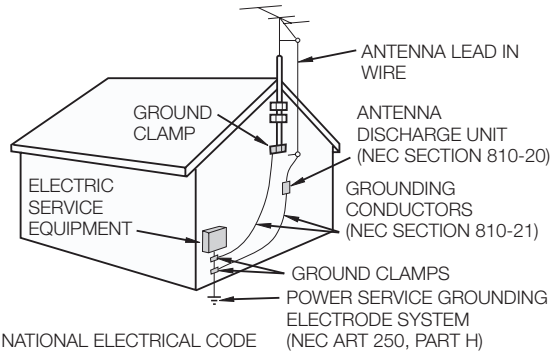

- **Water and Moisture**—Do not use this product near water - for example, near a bath tub, wash bowl, kitchen sink, or laundry tub; in a wet basement; or near a swimming pool; and the like.
- **Stand**—Do not place the product on an unstable cart, stand, tripod or table. Placing the product on an unstable base can cause the product to fall, resulting in serious personal injuries as well as damage to the product. Use only a cart, stand, tripod, bracket or table recommended by the manufacturer or sold with the product. When mounting the product on a wall, be sure to follow the manufacturer's instructions. Use only the mounting hardware recommended by the manufacturer.
- **Selecting the location**—Select a place with no direct sunlight and good ventilation.
- **Ventilation**—The vents and other openings in the cabinet are designed for ventilation. Do not cover or block these vents and openings since insufficient ventilation can cause overheating and/or shorten the life of the product. Do not place the product on a bed, sofa, rug or other similar surface, since they can block ventilation openings. This product is not designed for built-in installation; do not place the product in an enclosed place such as a bookcase or rack, unless proper ventilation is provided or the manufacturer's instructions are followed.
- **Heat**—The product should be situated away from heat sources such as radiators, heat registers, stoves, or other products (including amplifiers) that produce heat.
- **Lightning**—For added protection for this product during a lightning storm, or when it is left unattended and unused for long periods of time, unplug it from the wall outlet. This will prevent damage to the product due to lightning and power-line surges.
- To prevent fire, never place any type of candle or flames on the top or near the product.
- To prevent fire or shock hazard, do not expose this product to dripping or splashing. No objects filled with liquids, such as vases, should be placed on the product.
- To prevent fire or shock hazard, do not place the AC cord under the product or other heavy items.

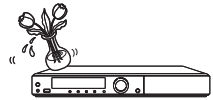

Precautions when cleaning this product

- Turn off the main power and unplug the AC cord from the wall outlet before handling.
- To clean the outer cabinet, periodically wipe it with a soft cloth (cotton, flannel, etc.).
- For severe dirt, soak a soft cloth (cotton, flannel, etc.) in some neutral detergent diluted with water, wring the cloth out thoroughly, wipe off the dirt, then wipe again with a soft, dry cloth.
- Do not use chemicals or a chemically treated cloth for cleaning. It may damage the cabinet finish.

Precautions

■ General

- Keep the unit away from direct sunlight, strong magnetic fields, excessive dust, humidity and electronic/electrical equipment (home computers, facsimiles, etc.) which generate electrical noise.
- If the unit does not work properly, unplug and plug it in again. Then turn on the unit.
- In case of an electrical storm, unplug the unit for safety.

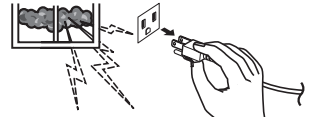

- Hold the AC power plug by the head when removing it from the AC outlet, as pulling the cord can damage internal wires.

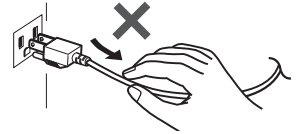

- Do not remove the outer cover, as this may result in electric shock. Refer internal service to your local SHARP service facility.
- The ventilation should not be impeded by covering the ventilation openings with items, such as newspapers, tablecloths, curtains, etc.
- Attention should be drawn to the environmental aspects of battery disposal.
- Do not place anything on the top of this system.

⚠ WARNING

- The voltage used must be the same as that specified by this product. Using this product with a higher voltage than that specified is dangerous and may result in a fire or other types of accident, causing damage. SHARP will not be held responsible for any damage resulting from the use of this unit with a voltage other than that specified.

■ Ventilation

This unit is fitted with a cooling fan at the rear for improved cooling. To allow for proper ventilation and to maintain good airflow around the main unit, position it with at least 2" (5 cm) of space on all side.

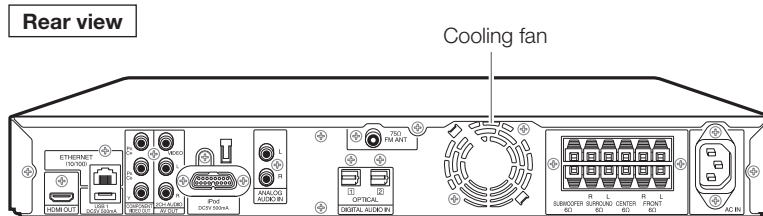

⚠ CAUTION

- The unit will get warm while being used. Do not touch the warm areas of the unit for prolonged periods to avoid damage to you.
- This unit is equipped with a special function which protects the amplifier circuit from damages. When it is activated, the sound switch is turned off. In this case, set the unit to the stand-by mode and turn on again.

■ Volume control

The sound level at a given volume setting depends on speaker efficiency, location and various other factors. It is advisable to avoid exposure to high volume levels, which occurs while turning the unit on with the volume control setting up high, or while continually listening at high volumes.

Main Features

[1] Features a new design with a sound bar front speaker to complement flat screen TVs.

- Sound bar speaker houses the left, center, and right channel speakers in a single box.

[2] Uses well-established Audyssey room equalization technologies to expand the listening area and reproduce dynamic and powerful sound.

- “Dynamic EQ”, “Dynamic Volume”, and “BassXT” enable higher quality audio.
- * These functions are described later in the manual.

* Audyssey Laboratories is the industry leader in sound equalization solutions for professional and consumer audio. Established in 2002, Audyssey was founded on a comprehensive understanding of the negative effects of room acoustics on sound reproduction. This landmark study took \$6 million dollars of research funds, five years of theoretical and experimental work, the resources of the prestigious USC Immersive Audio Laboratory and decades of shared scientific expertise by Audyssey founders Prof. Tomlinson Holman, Prof. Chris Kyriakakis, Dr. Sunil Bharitkar and Philip Hilmes. The resulting groundbreaking acoustical correction technologies provided the basis for Audyssey, which continues to develop new breakthrough technologies in audio signal processing, room acoustics and psychoacoustics.

[3] Uses select high performance parts to achieve high image and sound quality.

- ① Extra thick power cord with a 3-prong grounded plug
- ② Electrolytic capacitor to control the power supply impedance
- ③ High-performance audio electrolytic capacitor
- ④ Anti-vibration cabinet to reduce internal and external vibrations
- ⑤ Gold-plated terminals for excellent conductivity

[4] Superior audio quality design that supports the latest BD high-definition audio formats

- Full HD Audio Decoding Support (DD, DD+, Dolby True-HD, DTS, DTS-HD High Resolution Audio, DTS-HD Master Audio Essential)

[5] Multilink function enables basic operations with the TV remote control when connected to a TV with an HDMI cable.

[6] Internet capability enables BD-LIVE and Netflix streaming.

[7] iPod compatibility enables high-quality audio playback of iPod music.

[8] Compatible with AQUOS PURE MODE equipment for high-quality image playback by automatically selecting the optimal video output mode

What would you like to do with this system?

Watching high quality movies on Blu-ray discs

This system offers full high-definition Blu-ray disc playback.

Video/Picture/Music Playback (p. 45)

Enjoying different kinds of media sources

Use this system to enjoy video, picture or music content from various types of media sources such as DVDs, USB memory devices and via Internet.

**About Media Types (pp. 9-11)
Video/Picture/Music Playback (p. 45)**

Simple connection and operation through HDMI

This system is equipped with an HDMI terminal. You can connect it to the TV using HDMI and no other cable will be needed to enjoy movies. If your TV is compatible with AQUOS LINK, you can control both the TV and this system with simple operations.

**TV Connections (pp. 24-25)
AQUOS LINK Control (p. 43-44)**

Enjoying BD-LIVE functions through the Internet

This system is compatible with BD-LIVE. You can enjoy bonus content such as movie trailers through the Internet when playing back BD-Video discs compatible with BD-LIVE.

Enjoying BONUSVIEW or BD-LIVE (pp. 47-48)

Enjoy movies streamed from Netflix

Instantly watch movies streaming via this system. By connecting this system to the Internet, you can instantly watch TV episodes and movies streamed from Netflix on your TV.

Instantly Watching Movies from Netflix (pp. 53-54)

Enjoying high-quality sound

With a 5.1-channel speaker system, you can enjoy a more realistic sound experience.

Use the various sound modes to suit your listening preference.

**Positioning the speaker system (pp. 18-21)
Speaker Connections (pp. 22-23)
Configuring the speaker settings (pp. 39-40)
Enjoying a surround sound effect (p. 65)**

About Media Types

The following CD-RW/R discs cannot be played.

- Discs on which data has not been recorded cannot be played back.
- Discs recorded in a format other than an Audio CD and JPEG/MP3 file format cannot be played back.
- Discs may not be played back depending on their recording status or the status of the disc itself.
- Discs may not be played back depending on their compatibility with this system.

*2 About the JPEG file format

JPEG is a type of file format for storing still-image files (photos, illustrations, etc.). The system lets you play JPEG format still-image files.

File formats that are not compatible.

- Still images in formats other than JPEG (such as TIFF) cannot be played.
- There may be some files that cannot be played even if they are in JPEG format.
- Progressive JPEG files cannot be played.
- Moving image files as well as Motion JPEG format files cannot be played, even though they are JPEG files.

Other files that cannot be played back.

- You may not be able to play some still images which you have created, touched up, copied or otherwise edited on your computer.
- You may not be able to play some still images you have processed (rotated or saved by overwriting other images you have imported from the Internet or e-mail).

You may experience one or more of the following symptoms when playing files.

- It may take some time to play files depending on the number of folders, number of files and volume of data involved.
- EXIF information will not be displayed. EXIF stands for Exchangeable Image File Format, and is a standard for storing interchange information in image files, especially those using JPEG compression. (Refer to <http://exif.org> for more information.)

*3 About the MP3 file format

MP3 files are audio data compressed in the MPEG1/2 Audio layer-3 file format. "MP3 files" have ".mp3" as extensions. (Some files that have ".mp3" extensions or files that have not been recorded in MP3 format will produce noise or cannot be played.)

Playing the MP3 file format

- The MP3 files are not played in the order they were recorded.
- It is recommended to record data at a lower speed as data recorded at a fast speed can produce noise and may not be able to be played.
- The more folders there are, the longer the reading time.
- Depending on the folder tree, reading MP3 files can take time.
- The playing time may not be correctly displayed during MP3 file playback.

The following files cannot be played on this system.

- When both Audio CD [CD-DA] format and JPEG/MP3 file formats are recorded on a disc. (The disc is recognized to be an Audio CD [CD-DA] only tracks in Audio CD [CD-DA] format are played back.)
- Multi-session discs cannot be played.

About files/folders for Still images (JPEG files) and audio data (MP3 files)

You can play still images (JPEG files) /audio data (MP3 files) with this unit by making folder(s) on discs or USB memory devices as shown below.

Example of a folder structure:

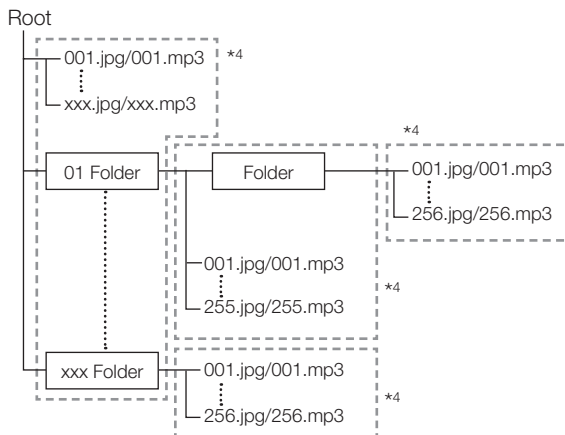

*4 Including the root directory, the maximum number of folders and files in each folder is limited to 256 in total.

File and folder requirements

- The discs or USB memory devices which this system can play back (recognize) are limited to the following properties:
 - Contains EXIF format files (only JPEG files)
 - Picture resolution: Between 32 x 32 and 7680 x 4320 pixels (only JPEG files)
 - Maximum number of folders and files in each folder: 256
 - Maximum hierarchy level of folders: 5
 - File size: 20 MB or less (JPEG files)
 - 200 MB or less (MP3 files)

NOTE

- File and folder names displayed on this system may differ from those displayed on PCs.

About Disc Contents

BD Video

Enjoy BD-specific functions including BONUSVIEW (BD-ROM Profile 1 Version 1.1), such as picture-in-picture, and BD-LIVE (pages 47 and 48). For the BD video discs compatible with BONUSVIEW/BD-LIVE, you can enjoy additional contents by copying the data from the discs or downloading it via the internet. For instance, this function is capable of playing the original movie as the primary video while playing video commentary from the film director on a small screen as a secondary video.

- NOTE**
- The available functions differ depending on the disc.

Title, Chapter and Track

- Blu-ray discs and DVDs are divided into "Titles" and "Chapters". If the disc has more than one movie on it, each movie would be a separate "Title". "Chapters", on the other hand, are subdivisions of titles. (See Example 1.)
- Audio CDs are divided into "Tracks". You can think of a "Track" as one tune on an Audio CD. (See Example 2.)

Example 1: Blu-ray disc or DVD

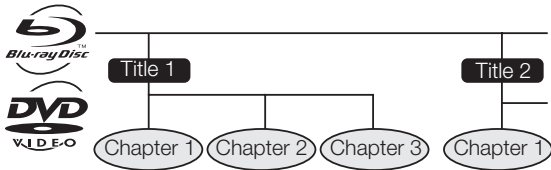

Example 2: Audio CD

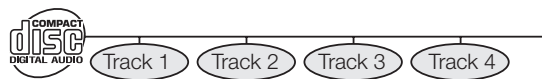

Icons Used on DVD Video Disc Cases

The back of the case of a DVD that is commercially available usually contains various information about the contents of the disc.

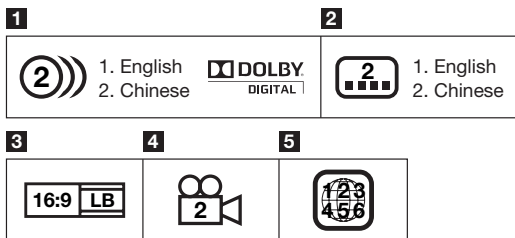

1 Audio tracks and audio formats

DVD discs can contain up to 8 separate tracks with a different language on each. The first in the list is the original track. This section also details the audio format of each soundtrack — Dolby Digital, DTS, MPEG etc.

Dolby Digital

A sound system developed by Dolby Laboratories Inc. that gives movie theater ambience to audio output when the system is connected to a Dolby Digital processor or amplifier.

DTS

DTS is a digital sound system developed by DTS, Inc. for use in cinemas.

Linear PCM

Linear PCM is a signal recording format used for Audio CDs and on some DVD and Blu-ray discs. The sound on Audio CDs is recorded at 44.1 kHz with 16 bits. (Sound is recorded between 48 kHz with 16 bits and 96 kHz with 24 bits on DVD video discs and between 48 kHz with 16 bits and 192 kHz with 24 bits on BD video discs.)

2 Subtitle languages

This indicates the kind of subtitles.

3 Screen aspect ratio

Movies are shot in a variety of screen modes.

4 Camera angle

Recorded onto some BD/DVD discs are scenes which have been simultaneously shot from a number of different angles (the same scene is shot from the front, from the left side, from the right side, etc.).

5 Region code

This indicates the region code (playable region code).

The Icons Used in This Operation Manual

- BD VIDEO** Indicates the functions that can be performed for BD Video discs.
- BD-RE** Indicates the functions that can be performed for BD-RE discs.
- BD-R** Indicates the functions that can be performed for BD-R discs.
- DVD VIDEO** Indicates the functions that can be performed for DVD Video discs.
- DVD-RW** Indicates the functions that can be performed for DVD-RW discs.
- DVD-R** Indicates the functions that can be performed for DVD-R discs.
- AUDIO CD** Indicates the functions that can be performed for Audio CDs.
- CD-R** Indicates the functions that can be performed for CD-R discs.
- CD-RW** Indicates the functions that can be performed for CD-RW discs.
- USB** Indicates the functions that can be performed for USB memory devices.





Important Information

Disc Precautions

Be Careful of Scratches and Dust

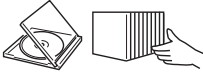
- BD, DVD and CD discs are sensitive to dust, fingerprints and especially scratches. A scratched disc may not be able to be played back. Handle discs with care and store them in a safe place.

Proper Disc Storage

Place the disc in the center of the disc case and store the case and disc upright.	
Avoid storing discs in locations subject to direct sunlight, close to heating appliances or in locations of high humidity.	
Do not drop discs or subject them to strong vibrations or impacts.	
Avoid storing discs in locations where there are large amounts of dust or moisture.	

Handling Precautions

- If the surface is soiled, wipe gently with a soft, damp (water only) cloth. When wiping discs, always move the cloth from the center hole toward the outer edge.



- Do not use record cleaning sprays, benzene, thinner, static electricity prevention liquids or any other solvent.
- Do not touch the surface.
- Do not stick paper or adhesive labels to the disc.
- If the playing surface of a disc is soiled or scratched, the system may decide that the disc is incompatible and eject the disc tray, or it may fail to play the disc correctly. Wipe any dirt off the playing surface with a soft cloth.

Cleaning the Pick Up Lens

- Never use commercially available cleaning discs. The use of these discs can damage the lens.
- Request the nearest service center approved by SHARP to clean the lens.

Warnings about dew formation

- Condensation may form on pick up lens or disc in the following conditions:
 - Immediately after a heater has been turned on.
 - In a steamy or very humid room.
 - When the system is suddenly moved from a cold environment to a warm one.

When condensation forms:

- It becomes difficult for the system to read the signals on the disc and prevents the system from operating properly.



To remove condensation:

- Take out the disc and leave the system with the power off until the condensation disappears. Using the system when there is condensation may cause malfunction.

Copyright

- Audio-visual material may consist of copyrighted works which must not be recorded without the authority of the owner of the copyright. Refer to relevant laws in your country.
- This product incorporates copyright protection technology that is protected by U.S. patents and other intellectual property rights. Use of this copyright protection technology must be authorized by Macrovision, and is intended for home and other limited viewing uses only unless otherwise authorized by Macrovision. Reverse engineering or disassembly is prohibited.

U.S. Patent Nos. 6,836,549; 6,381,747; 7,050,698; 6,516,132; and 5,583,936

- Manufactured under license from Dolby Laboratories. Dolby, Pro Logic, and the double-D symbol are trademarks of Dolby Laboratories.
- Manufactured under license under U.S. Patent #'s: 5,451,942; 5,956,674; 5,974,380; 5,978,762; 6,226,616; 6,487,535; 7,392,195; 7,272,567; 7,333,929; 7,212,872 & other U.S. and worldwide patents issued & pending. DTS is a registered trademark and the DTS logos, Symbol, DTS-HD and DTS-HD Master Audio | Essential are trademarks of DTS, Inc. ©1996-2008 DTS, Inc. All Rights Reserved.
-  is a trademark.
- "BD-LIVE" logo is a trademark of Blu-ray Disc Association.
-  is a trademark of DVD Format/Logo Licensing Corporation.
- HDMI, the HDMI logo and High-Definition Multimedia Interface are trademarks or registered trademarks of HDMI Licensing LLC.
- "x.v.Color" and "x.v.Color" logo are trademarks of Sony Corporation.
- Java and all Java-based trademarks and logos are trademarks or registered trademarks of Sun Microsystems, Inc. in the United States and/or other countries.
- "BONUSVIEW" logo is a trademark of Blu-ray Disc Association.
- "AVCHD" and the "AVCHD" logo are trademarks of Panasonic Corporation and Sony Corporation.
- Manufactured under license from Audyssey Laboratories. U.S. and foreign patents pending. Audyssey Dynamic EQ[®], Audyssey Dynamic Volume[™], Audyssey BassXT[™] and Audyssey EQ[®] are registered trademarks and trademarks of Audyssey Laboratories.

Getting Started

Step 1: Unpacking









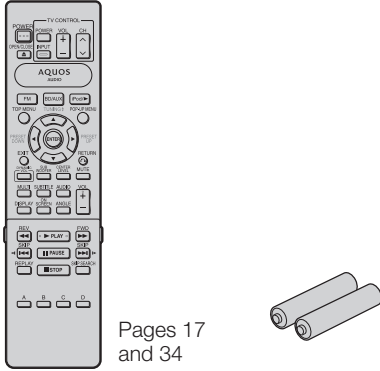
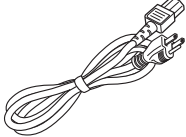
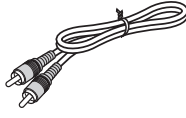

Make sure the following system components and accessories are provided with the product.

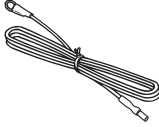
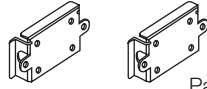
System components

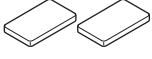
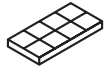
Main Unit

Speakers: Sound Bar speakers (L/R/Center), Surround speakers (L/R), Subwoofer

Accessories

Remote control (x 1), "AAA" size battery (x 2)		AC power cord (x 1)			
 <p>Pages 17 and 34</p>		 <p>Page 34</p>			
		Video cable (x 1)			
		 <p>Page 27</p>			
iPod cable (x 1)	FM antenna wire (x 1)	Wall mount angle (x 2)			
 <p>Page 30</p>	 <p>Page 33</p>	 <p>Page 20</p>			
Pattern paper (x 1)	Foot cushion (x 2) (For Sound Bar Speaker)	Foot cushion (x 8) (For Surround Speaker)			
 <p>Page 20</p>	 <p>Page 19</p>	 <p>Page 19</p>			
Speaker connection cord (x 6)					
Page 22					
 <p>White (for Sound bar speaker (left)) approx. 8 feet (2.5m)</p>	 <p>Red (for Sound bar speaker (right)) approx. 8 feet (2.5m)</p>	 <p>Green (for Sound bar speaker (center)) approx. 8 feet (2.5m)</p>	 <p>Purple (for subwoofer) approx. 8 feet (2.5m)</p>	 <p>Blue (for left surround speaker) approx. 29 feet (9m)</p>	 <p>Grey (for right surround speaker) approx. 29 feet (9m)</p>

(Continued on the next page)

Getting Started

Step 2: Connecting to speakers and selecting equipment

Make necessary connections each speakers. Refer to "Positioning the Speaker System" (Pages 18-21) and "Speaker Connections" (Pages 22-23).

Connection varies with the equipment used. Refer to Connection. (Pages 24-33)

Turn off the devices before connecting.

For using online services such as BD-LIVE, Netflix and RSS

To use the online services available on this system (BD-LIVE, Netflix or RSS), after an Internet connection is made, communication setup is required. Refer to "Communication Setup". (Pages 71-73)

Step 3: Setting up the speakers

Make the necessary preparations so you can enjoy audio playback.

Refer to "Speaker Settings". (Pages 39-40)

Step 4: Playing back video/picture/music content and listening to FM broadcasts

You can use this system to play back video, picture or music content from the desired media source such as Blu-ray disc, DVD, iPod etc., or via Internet. Refer to "Video/Picture/Music Playback". (Pages 45-54) and "Listening to the iPod". (Pages 60 and 61)

You can also set or use various functions during playback. Refer to "Playback Functions". (Pages 55-57) and "Settings During Playback". (Pages 58 and 59)

You can listen to FM broadcasts. Refer to "Listening to the FM Broadcast". (Page 62)

Use the various sound modes to enhance the audio playback. Refer to "Audio Settings and Operations". (Pages 63-66)

Select input selection and adjust the volume to enjoy the audio playback. Refer to "Basic Operations". (Page 41)

Step 5: Adjust settings

Adjust settings to enjoy various features and other functions for playing discs/content.

Refer to Settings. (Pages 67-79)

Major Components

Main Unit (Front)

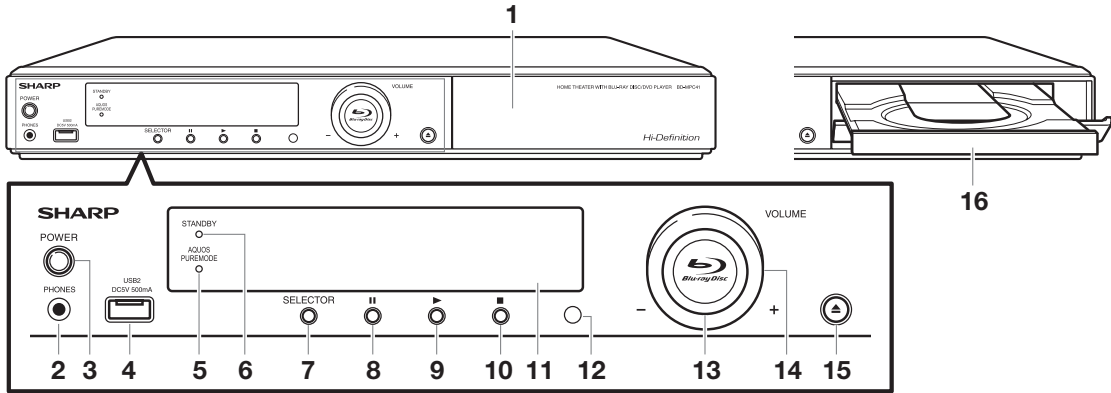

- | | |
|--|---|
| <ul style="list-style-type: none"> 1 Door flap 2 PHONE jack (p. 42) 3 POWER (p. 36) 4 USB2 terminal (p. 77)
When you insert or remove a USB memory device, be sure to turn the main power off. Also, be sure to set "Quick Start" to "No" (See page 69) before inserting or removing the device. If you insert or remove the device with this system or Quick Start on, the data may become damaged. 5 AQUOS PURE MODE indicator (p. 36) 6 STANDBY indicator (p. 36) | <ul style="list-style-type: none"> 7 SELECTOR (p.41) 8 PAUSE (pp. 50, 55) 9 PLAY (p. 45) 10 STOP (p. 45) 11 Front panel display (pp. 16, 36) 12 Remote control sensor (p. 34) 13 BD/DVD/CD mode indicator (p. 36) 14 VOLUME (p. 41) 15 OPEN/CLOSE (p. 41) 16 Disc Tray (p. 41) |
|--|---|

Main Unit (Rear)

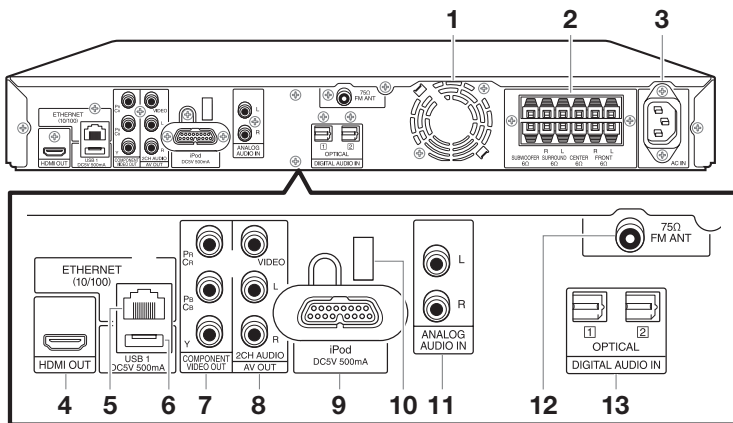

- | | |
|---|---|
| <ul style="list-style-type: none"> 1 Cooling fan
The cooling fan operates while the power to this system is on. 2 Speaker terminals (p. 22) 3 AC IN terminal (p. 34) 4 HDMI OUT terminal (p. 24) 5 ETHERNET terminal (p. 32) 6 USB1 terminal (p. 47)
When you insert or remove a USB memory device, be sure to turn the main power off. Also, be sure to set "Quick Start" to "No" (See page 69) before inserting or removing the device. If you insert or remove the device with this system or Quick Start on, the data may become damaged. | <ul style="list-style-type: none"> 7 COMPONENT VIDEO OUT jacks (p. 26) 8 2CH AUDIO output jacks (p. 31) 9 iPod terminal (p. 30) 10 HDMI cable holder (p. 25) 11 ANALOG AUDIO IN jacks (p. 27) 12 FM ANT jack (p. 33) 13 DIGITAL AUDIO IN terminals
OPTICAL 1 (p. 24)
OPTICAL 2 (p. 28) |
|---|---|

Major Components

Sound Bar Speaker (Magnetically Shielded)

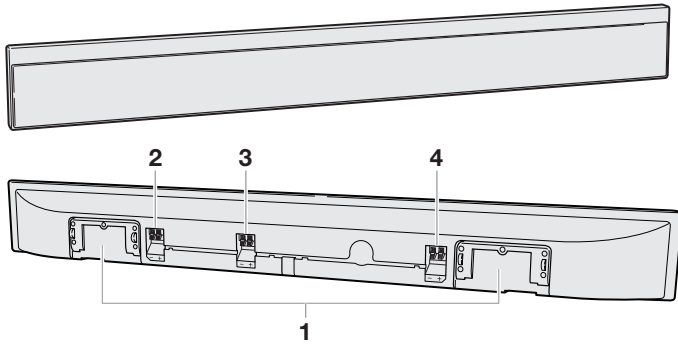

- 1 Mounting slot for wall mount angle
- 2 Speaker terminals (right)
- 3 Speaker terminals (center)
- 4 Speaker terminals (left)

Surround Speakers

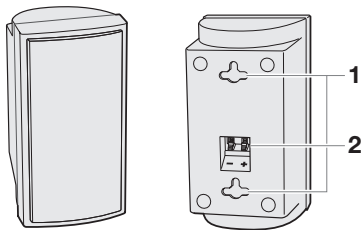

- 1 Mounting Holes
- 2 Speaker Terminals

Subwoofer

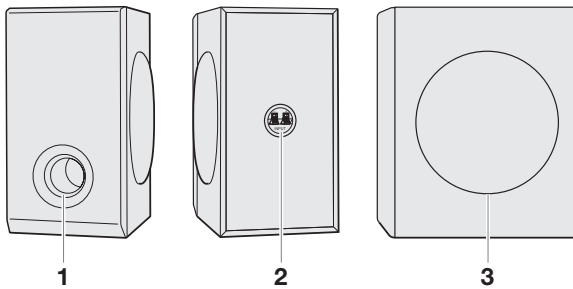

- 1 Bass Reflex Duct
- 2 Speaker Terminals
- 3 Woofer

Front Panel Display

Various information about the operating condition of the unit is shown here, including the input source, volume level setting, sound mode, mute, playback time etc.

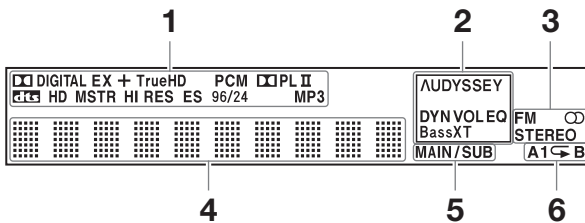

- 1 Light up when the following decoders are active.
Dolby Digital, Dolby Digital EX, Dolby Digital Plus, Dolby TruHD, Dolby ProLogic II, DTS-HD Master Audio, DTS High Resolution Audio, DTS-ES, DTS 96/24, PCM, MP3
- 2 Audyssey indicator (p. 64)
- 3 FM function indicator (p. 62)
- 4 Main display area
- 5 MAIN/SUB indicator (p. 63)
- 6 Repeat indicator (p. 56)

Remote Control

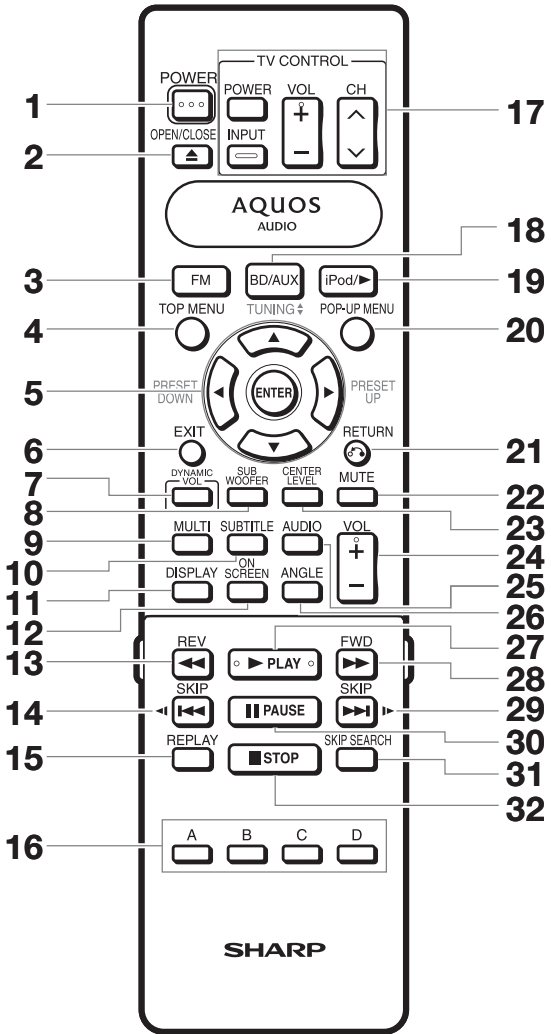

- 1 POWER (p. 36)
- 2 ▲ OPEN/CLOSE (p. 41)
- 3 FM (p. 62)
- 4 TOP MENU (pp. 46, 48)
- 5 Cursor buttons (▲/▼/◀/▶), ENTER (pp. 37, 67)
TUNING ▲/▼, PRESET DOWN ◀/PRESET UP ▶ (p. 62)
- 6 EXIT (pp. 36, 67)
- 7 DYNAMIC VOL (p. 66)
- 8 SUB WOOFER (p. 66)
- 9 MULTI (p. 64)
- 10 SUBTITLE (p. 57)
- 11 DISPLAY (p. 42)
- 12 ON SCREEN (p. 35)
- 13 ◀◀ REV (p. 55)
- 14 ◀◀ SKIP/◀ (pp. 48, 55)
- 15 REPLAY (p. 55)
- 16 A (Red), B (Green), C (Blue), D (Yellow) (p. 49)
- 17 TV CONTROL buttons (p. 42)
- 18 BD/AUX (p. 41)
- 19 iPod/▶ (p. 61)
- 20 POP-UP MENU (p. 46)
- 21 ↻ RETURN (pp. 50, 56)
- 22 MUTE (p. 41)
- 23 CENTER LEVEL (p. 66)
- 24 VOL +/- (p. 41)
- 25 AUDIO (pp. 57, 63)
- 26 ANGLE (p. 57)
- 27 ▶ PLAY (p. 45)
- 28 ▶▶ FWD (p. 55)
- 29 ▶▶▶ SKIP/▶ (pp. 48, 55)
- 30 || PAUSE (pp. 50, 55)
- 31 SKIP SEARCH (p. 55)
- 32 ■ STOP (p. 45)

Buttons under the cover

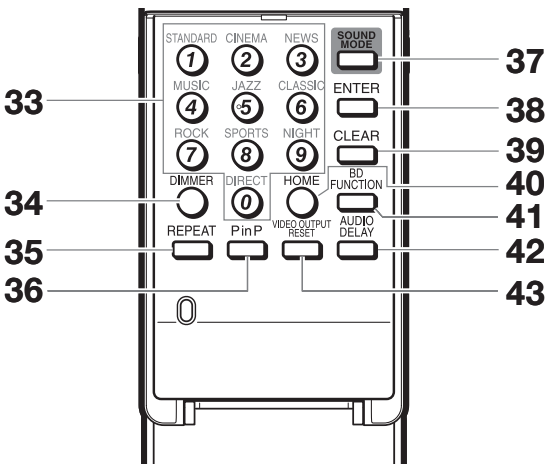

- 33 STANDARD (1)
- 34 CINEMA (2)
- 35 NEWS (3)
- 36 SOUND MODE
- 37 MUSIC (4)
- 38 JAZZ (5)
- 39 CLASSIC (6)
- 40 ENTER
- 41 ROCK (7)
- 42 SPORTS (8)
- 43 NIGHT (9)
- 44 CLEAR
- 45 DIMMER
- 46 DIRECT (0)
- 47 HOME
- 48 BD FUNCTION
- 49 REPEAT
- 50 PinP
- 51 VIDEO OUTPUT RESET
- 52 AUDIO DELAY

NOTE

- This remote control is equipped with two **ENTER** buttons (5 and 38 listed above). The **ENTER** button is useful when using with the **Number** buttons.

Positioning the Speaker System

Placing the Speaker System

To ensure optimal sound, it is recommended that you set up the speaker system as shown below.

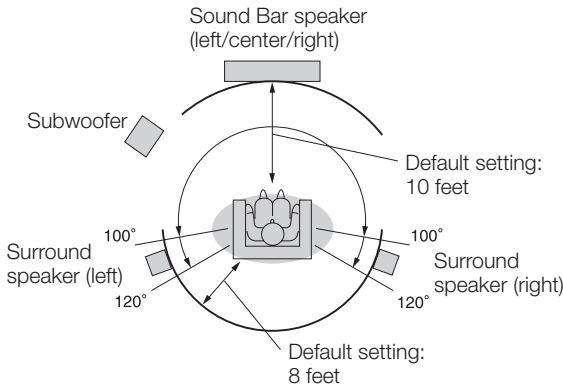

Installation image

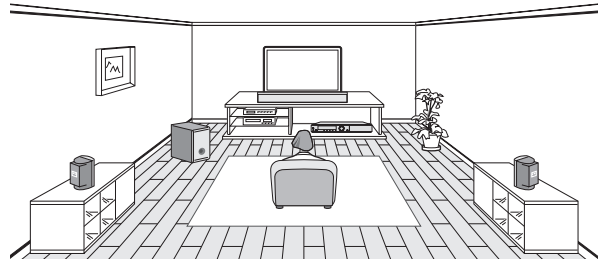

NOTE

- The default distance is set to 10 feet for the Sound Bar speaker (Front L/R and Center speakers) and 8 feet for the Surround speakers. If you cannot position the speakers at the default distance, adjust the speaker balance by using "Speaker Settings". (Pages 39-40)

Important points on speaker location

- Place the Sound Bar speaker at the position just in front of near the television.
- Place the surround speakers at a position just above the height of your ears.
- The subwoofer vibrates while reproducing bass. Place it on a stable, sturdy surface.
- The subwoofer reproduces only lower frequency bass tones.
- Since the human ear cannot identify the direction of low bass tones, the subwoofer can usually be placed freely in the room for the best sound result.
- Bass sound is easily affected by the position of the subwoofer. If the bass tones in the listening position seem much too low or too high, try changing your listening position. If the bass tone level changes when you change the listening position, try relocating the subwoofer.

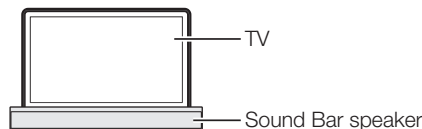

Magnetically shielded speakers

The Sound Bar speaker (left/center/right) may be placed near the TV as it is magnetically shielded. However, depending on your TV (cathode ray tube), color variation may occur on the TV screen.

If color variation occurs...

Turn off the TV (from the power switch).

After 15 - 30 minutes, turn the TV on again.

If the color variation is still present...

Move the speakers further away from the TV.

If a magnet or other magnetic source is positioned near the TV, the combined magnetic field with that of the speakers may cause color variation to occur on the TV screen.

NOTE

- The surround speakers and subwoofer are not magnetically shielded.
- If the color variation is still present, you may need to have your TV inspected.

Positioning the Speaker System

How to apply foot cushions

Affix the foot cushions (supplied) to the bottom of the speakers to prevent them from sliding or falling due to vibration.

[Sound Bar Speaker]

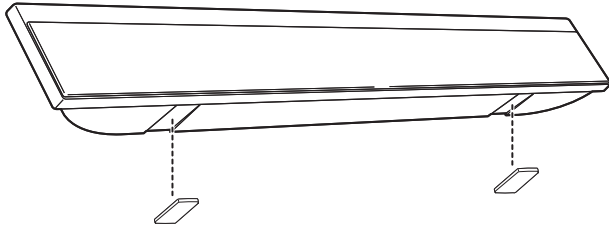

[Surround Speaker]

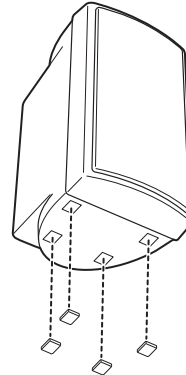

To mount the speakers on the wall

The Sound Bar speaker (left/center/right) and surround speakers can be mounted on the wall. The Sound Bar speaker needs 8 screws and the surround speaker needs 2 screws to be mounted (not supplied).

CAUTION

- Be very careful to prevent the speaker from falling when mounting on the wall.
- Before mounting, check the wall strength. (Do not put on the veneer plaster or whitewashed wall. The speakers may fall.)
- If unsure, consult a qualified service technician.
- Mounting screws are not supplied. Use appropriate ones.
- Check all mounting screws for looseness and that they are engaged in the speakers.
- Mount the speakers on the wall using 2 screws each position.
- Select a good location. If not, accidents may occur or the speaker may get damaged.
- Avoid placing on a bed, sofa, water tank, sink and hallway wall.
- To avoid accidents, fix the speaker wires to the wall. You may trip over them.
- SHARP is not responsible for accidents resulting from improper installation.
- The following may cause personal injury or speaker damage.
 - Applying any other load to the fittings than the speaker.
 - Modification or change of the fittings.
 - Stepping on or hanging from the speakers. Especially pay attention to small children.

Driving screws

SHARP designed the speakers so you may hang them on the wall. Use proper screws (not supplied). See below for size and type.

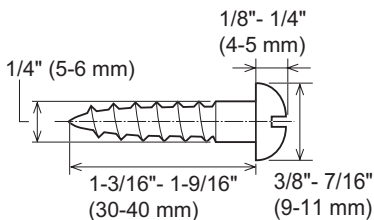

Mounting on a wooden wall

Mount on a sturdy part with thickness of 2" (5 cm) or more. Do not mount on a thin wall (plywood) or plaster board.

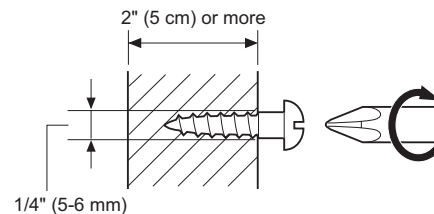

(Continued on the next page)

Positioning the Speaker System

To mount the Sound Bar Speaker on the wall

● Wall mount angle fixed on the wall (Horizontal position)

- 1 Fix the pattern paper to the wall in horizontal position as below.

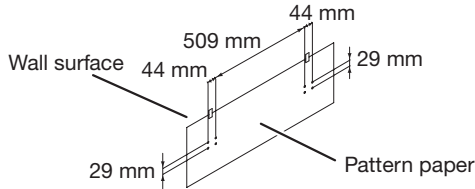

- 2 Make a hole on the wall following the screw point marks on the pattern paper by using a drill.

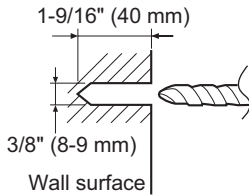

- 3 Fix a wall mount plug into the hole using a hammer until it is flush with the wall surface.

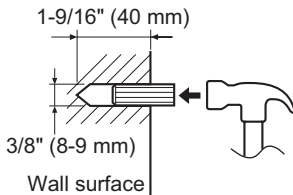

- 4 Screw the wall mount angle to the wall as shown in the illustration. (Total screw is 8 pieces)

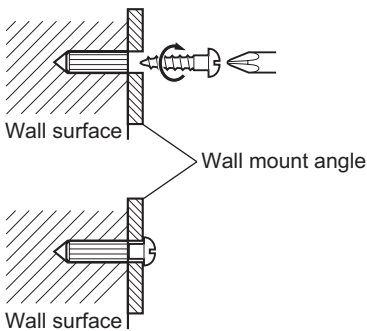
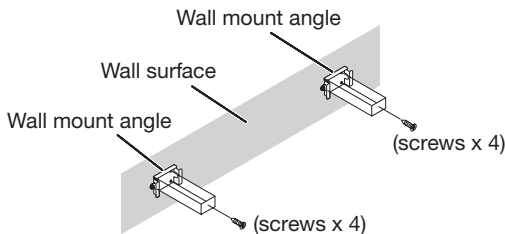

NOTE

- Make sure all screws are fully tighten. (screws are not supplied)

● Installing the Sound Bar Speaker

Before installing the speaker, connect the speaker connection cords to the speaker. (See pages 22-23.)

- 1 Align the wall mount slot at the speaker to the wall mount angle.
- 2 Slot the speaker into the wall mount angle.
- 3 Fix them securely.

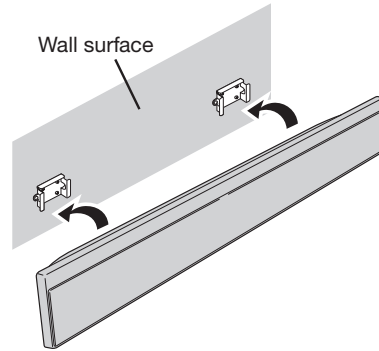

Positioning the Speaker System

To mount the Surround Speakers on the wall

● Screw fixed on the wall

- 1 Decide and make marks where to fix the screws on the wall in horizontal or vertical position as bellow.

(Horizontal position)

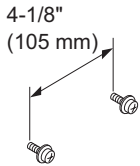

(Vertical position)

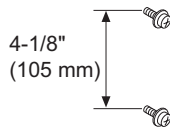

- 2 Make holes by using a drill according to the marks you have put in step 1.

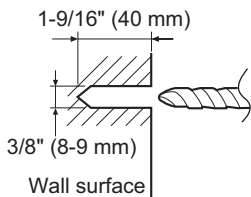

- 3 Fix a wall mount plug into the hole using a hammer until it is flush with the wall surface.

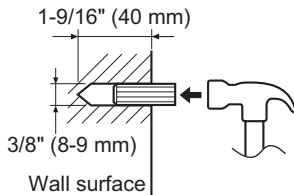

- 4 Tighten the screws.

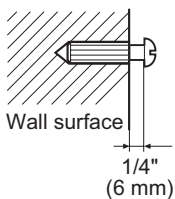
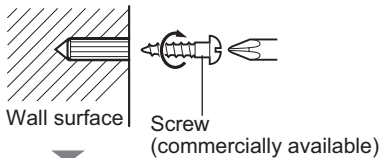

● Installing the Surround Speaker

Before installing the speaker, connect the speaker connection cords to the speaker. (See pages 22-23.)

Hook the speaker on the screw heads and make sure to properly secured.

(Vertical position)

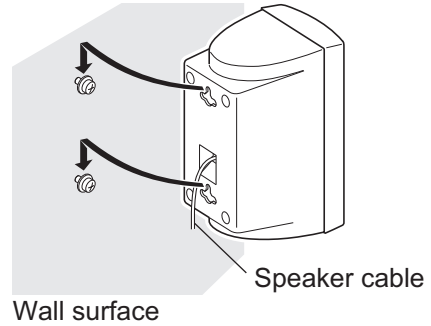

(Horizontal position)

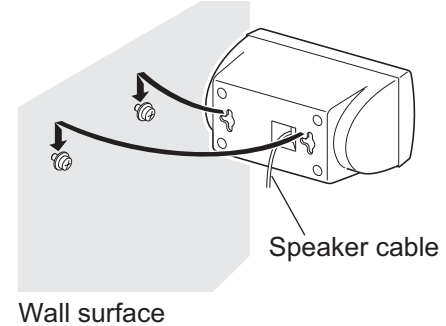

Speaker Connections

Speaker Connections

- The speaker terminals on the main unit, the tube of the speaker lead, and speaker labels are distinguished by colors.
- Connect the speaker and the unit by matching the colors.

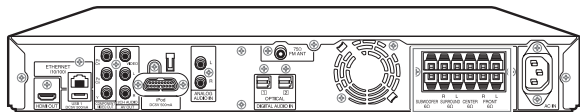

Speaker terminals

Sound Bar Speaker (right/center/left)

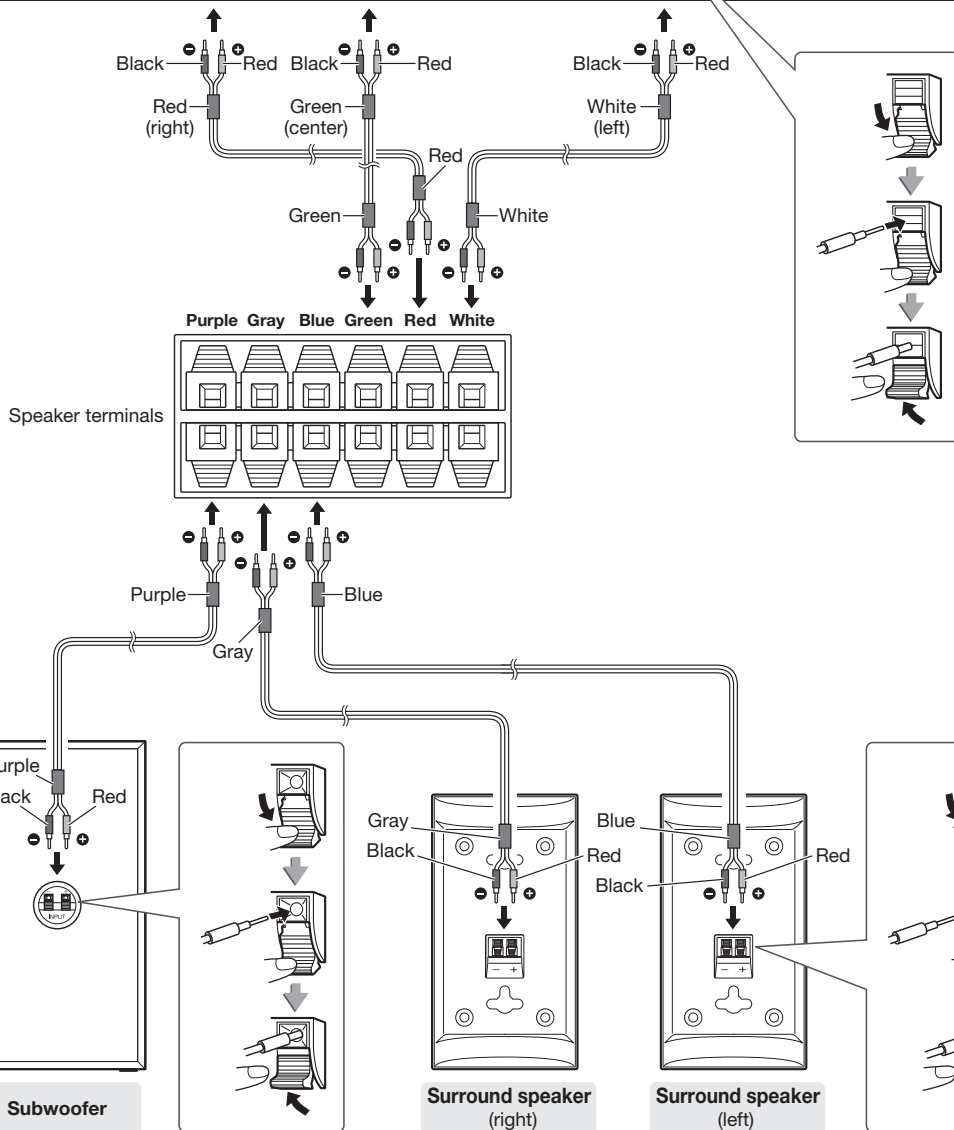
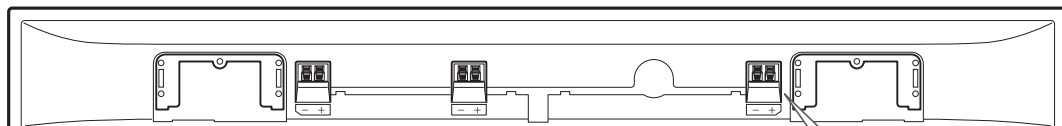

Speaker Connections

Connecting speaker wires

Make sure to leave the AC power lead disconnected when connecting the speakers.

To prevent accidental short circuit between ⊕ and ⊖ terminals, connect the speaker wires to the speakers first then to the main unit.

1 Connect the wires to the speakers.

2 Connect the other end to the main unit.

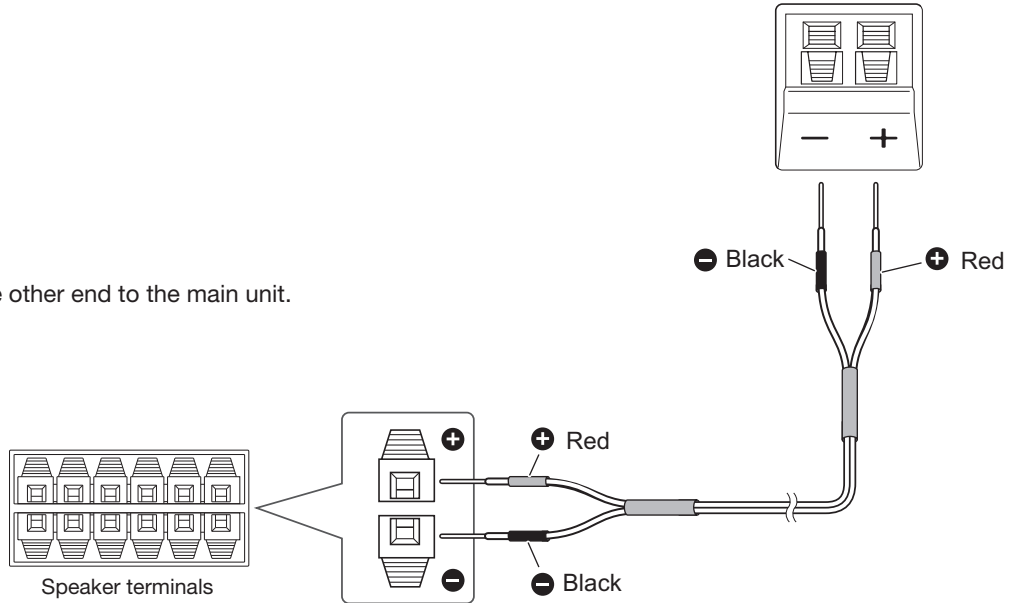

CAUTION

- The supplied speakers are exclusively for BD-MPC41U. Do not connect them to other equipment, and do not connect other speakers to BD-MPC41U. It may cause malfunction.
- Do not mistake the ⊕ and ⊖ right and left terminals of the speaker leads. (The right speaker is placed on the right when you face the unit.)
- Do not let the bare speaker wires touch each other.
- Do not stand or sit on the speakers. You may be injured.
- Insert the speaker plug fully with the rising side facing up.
- Hold the speaker plug when removing it from the main unit. Pulling the lead may cause malfunction to the unit.

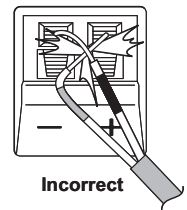

About the wire arrangement of Sound Bar speaker

After connecting the speaker wires to the Sound Bar speaker, arrange the wires as shown in the following illustration.

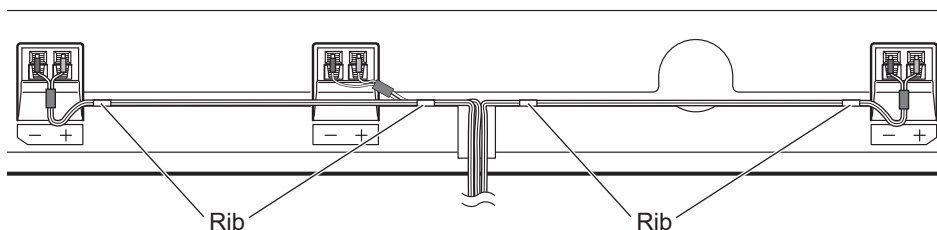

After connecting

- Refer to "Speaker Settings". (Pages 39-40)

TV Connections

Connecting to the HDMI Terminal and the DIGITAL AUDIO IN Terminal

- You can enjoy high quality digital picture through the HDMI terminal.
- When you use AQUOS LINK, make sure to use a certified HDMI cable.
- You can enjoy the TV sound through the DIGITAL AUDIO IN terminal.

STEPS

- 1: Be sure to turn off this system and the equipment before making any connections.**
- 2: Firmly insert the cables all the way into the terminal connector (①, ②, ③ and ④).**

CAUTION

- When connecting the TV and the main unit, do not connect using other HDMI equipment. Connect the TV directly to the main unit.
- When connecting the main unit and the AQUOS LINK-compatible TV, connect the AQUOS optical output to the DIGITAL AUDIO IN terminal on the main unit.
- Do not connect the system to the AQUOS LINK-compatible audio system.

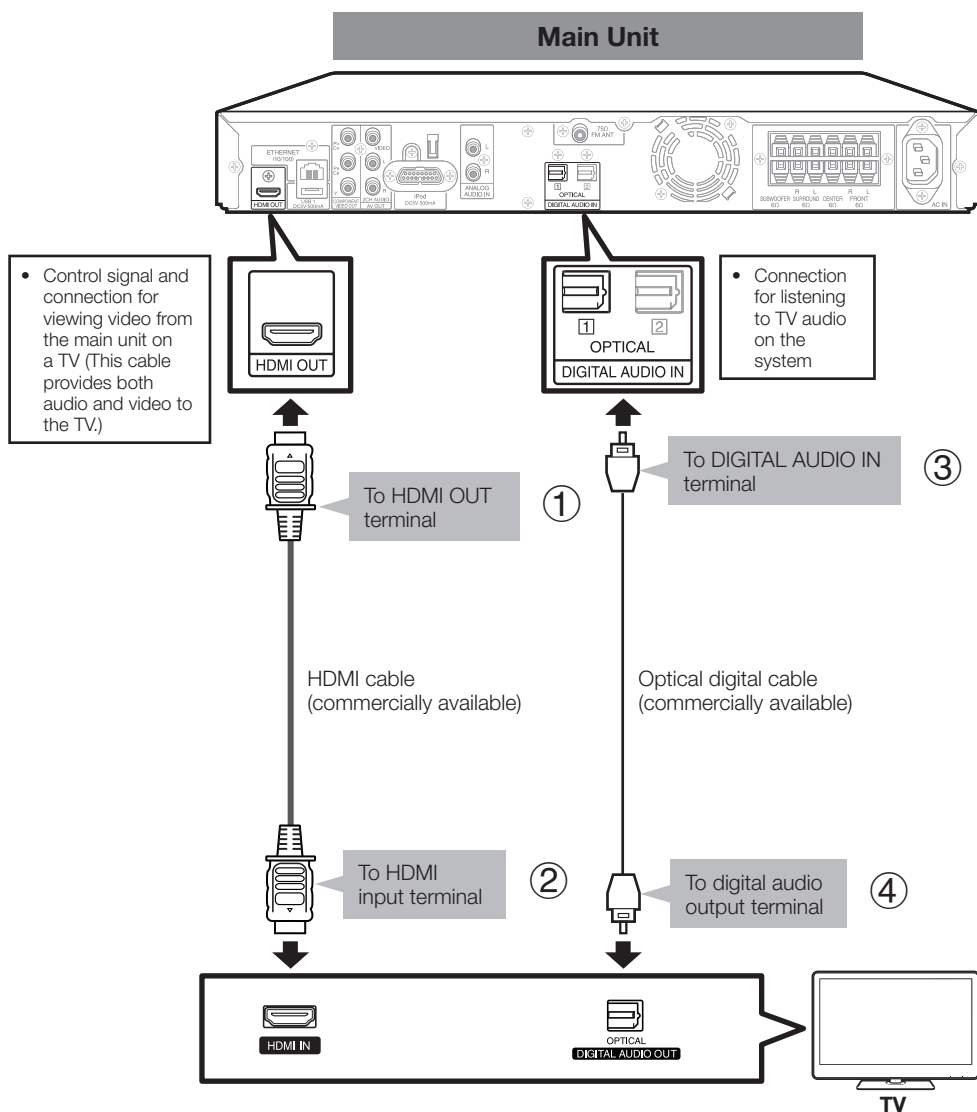

TV Connections

Selecting the priority video output when connecting HDMI and Component video

When you connect both an HDMI cable and a component cable to this system, you need to select the priority video output in “Settings” – “Audio Video Settings” – “Video Out Select”. (See page 68.)

NOTE

- When you connect the system to a SHARP TV with an HDMI cable only and the TV is turned on, the video output switches to HDMI automatically. (The above setting is unnecessary.)
- When you connect the system to a TV with an HDMI cable, “HDMI Video Out” is set to “Auto”. If you don’t get a stable image, select the desired resolution*.

When you set “HDMI Video Out” to a setting other than “Auto”, you can only select resolutions* that are compatible with the connected TV.

* Refer to “HDMI Video Out” on page 68 regarding the resolutions of the HDMI video output.

HDMI cable holder on the rear of the main unit

Do not pull the HDMI cable when connected to the terminal, as this can damage the terminal or cause a poor connection. The system comes with a dedicated cable holder so that the HDMI cable does not place a direct load on the terminal. When connecting the HDMI cable, be sure to pass the cable through the cable holder and secure it.

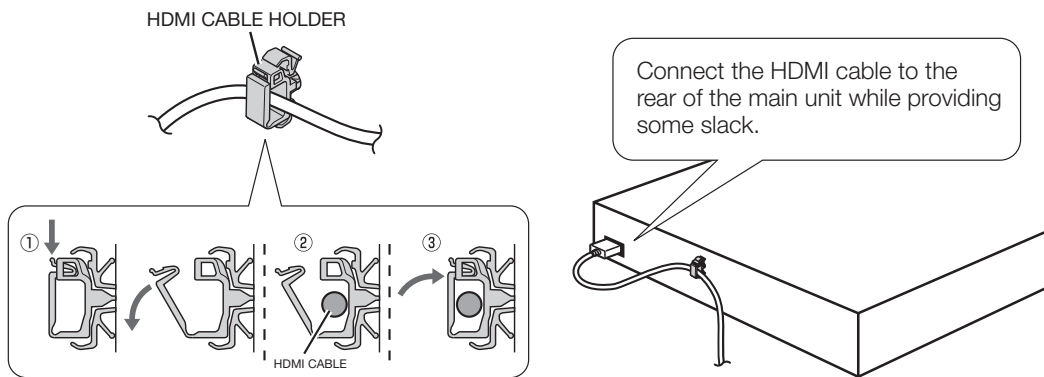

- ① Press down on the tab and pull it towards you.
- ② Pass the HDMI cable (commercially available) through the cable holder.
- ③ Press in the tab until it clicks into position.

After connecting

- If necessary, perform the Audio Video Settings. (Pages 68-69)
- Refer to AQUOS LINK control function. (Pages 43-44 and 69)
- Prepare the desired disc or content and start playback (pages 45-54), then enjoy multi-channel mode sound (page 64) or preset sound mode sound (page 65).

TV Connections

Connecting to the COMPONENT VIDEO OUT Jacks and ANALOG AUDIO IN Jacks

- You can enjoy accurate color reproduction and high quality images through the component jacks.
- You can enjoy the TV sound through the ANALOG AUDIO IN jacks.

STEPS

- Be sure to turn off this system and the equipment before making any connections.
- Firmly insert the cables all the way into the terminal connector (①, ②, ③ and ④).

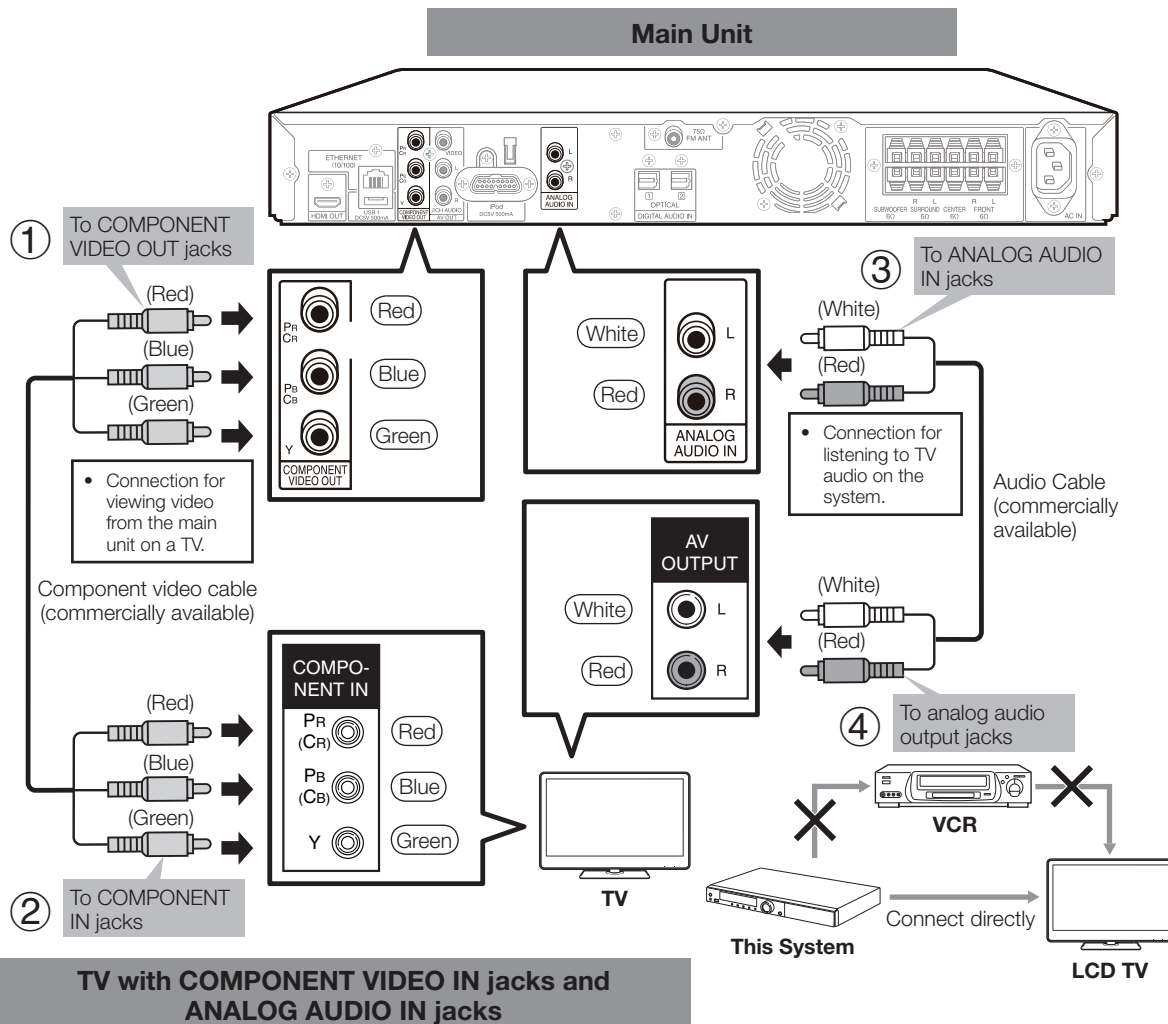

CAUTION

- You need to select the priority video output in "Settings" – "Audio Video Settings" – "Video Out Select". (See page 68.)
- When the priority video output is set to "HDMI" in "Video Out Select", the video resolution which is output from the COMPONENT VIDEO OUT jacks is the one set in "HDMI Video Out".
- When the output from the COMPONENT VIDEO OUT jacks is prioritized, set the priority video output to "Component".

NOTE

- Connect the system to LCD TV directly. If you play back the image via VCR, the image may deteriorate due to the copy guard function.
- When you record the program where copyright is protected, the copy guard function is activated automatically; the program cannot be recorded correctly. Also, the playback image via VCR may deteriorate due to this function. However, this is not a malfunction. When you watch the program where copyright is protected, we recommend that the system be connected to LCD TV directly.

After connecting

- If necessary, perform the Audio Video Settings. (Pages 68-69)
- Prepare the desired disc or content and start playback (pages 45-54), then enjoy multi-channel mode sound (page 64) or preset sound mode sound (page 65).

TV Connections

Connecting to the VIDEO OUT Jack and ANALOG AUDIO IN Jacks

- You can enjoy the images through the video jack.
- You can enjoy the TV sound through the ANALOG AUDIO IN jacks.

STEPS

1: Be sure to turn off this system and the equipment before making any connections.
2: Firmly insert the cables all the way into the terminal connector (①, ②, ③ and ④).

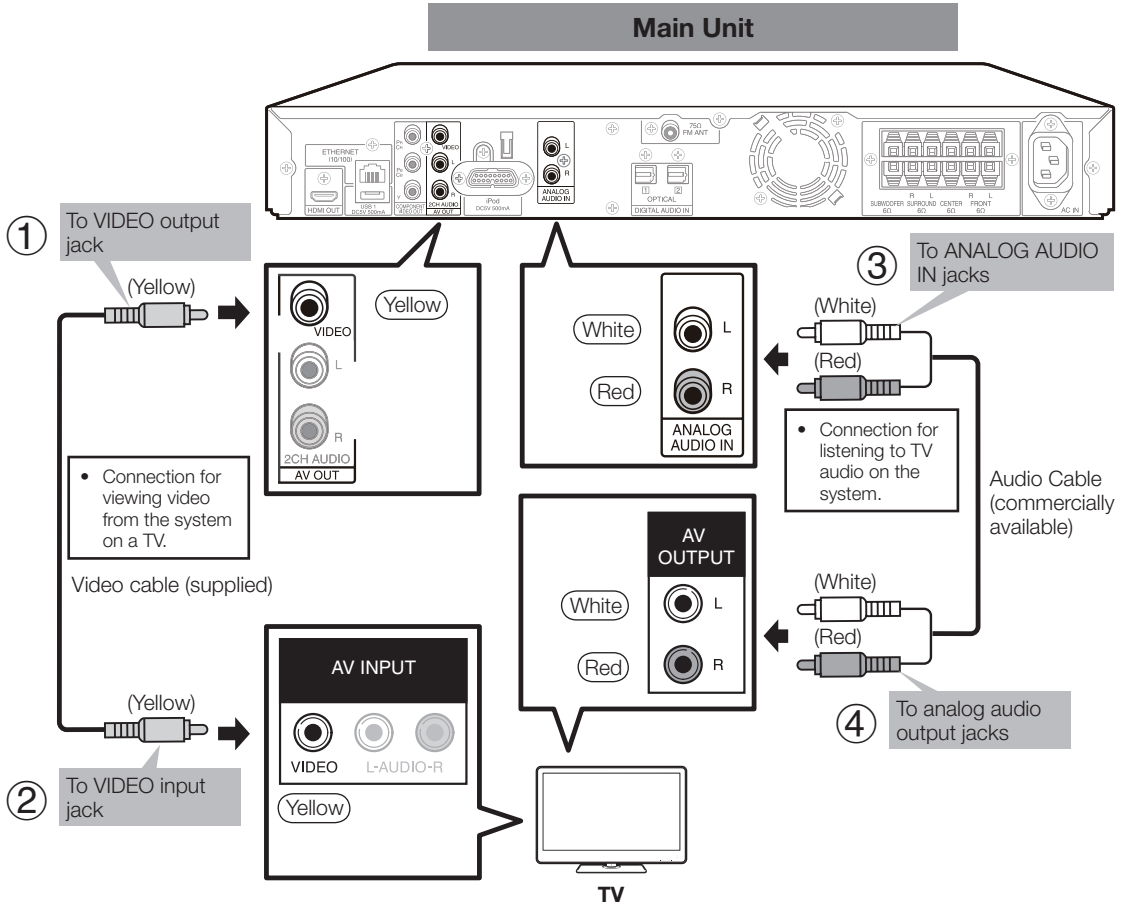

Connection and Setup

TV with a VIDEO input jack and ANALOG AUDIO IN Jacks

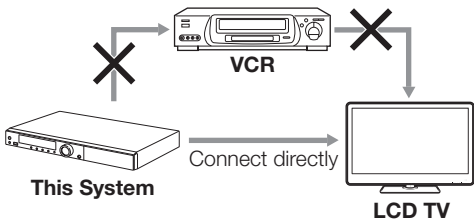

NOTE

- Connect the system to LCD TV directly. If you play back the image via VCR, the image may deteriorate due to the copy guard function.
- When you record the program where copyright is protected, the copy guard function is activated automatically; the program cannot be recorded correctly. Also, the playback image via VCR may deteriorate due to this function. However, this is not a malfunction. When you watch the program where copyright is protected, we recommend that the system be connected to LCD TV directly.

After connecting

- Prepare the desired disc or content and start playback (pages 45-54), then enjoy multi-channel mode sound (page 64) or preset sound mode sound (page 65).

Audio Connections

Connecting to the DIGITAL AUDIO IN Terminal

- You can enjoy the audio equipment sound through the DIGITAL AUDIO IN terminal.

STEPS

- 1: Be sure to turn off this system and the equipment before making any connections.
- 2: Firmly insert the cables all the way into the terminal connector (① and ②).

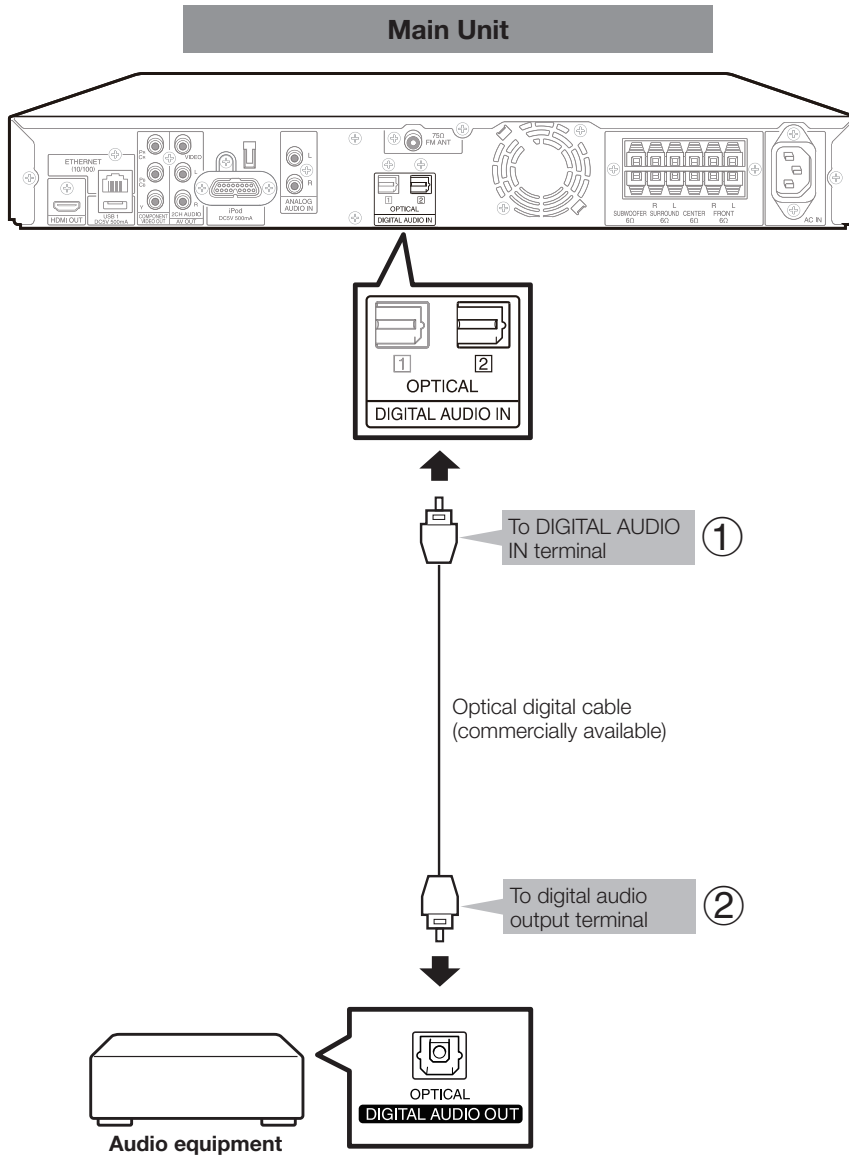

Audio equipment with a digital audio output terminal

After connecting

- Play back the audio on the connected equipment and enjoy multi-channel mode (page 64) or preset sound mode (page 65).

Audio Connections

Connecting the ANALOG AUDIO IN Jacks

- You can enjoy the audio equipment sound through the ANALOG AUDIO IN jacks.

STEPS

- 1: Be sure to turn off this system and the equipment before making any connections.
- 2: Firmly insert the cable all the way into the terminal connector (① and ②).

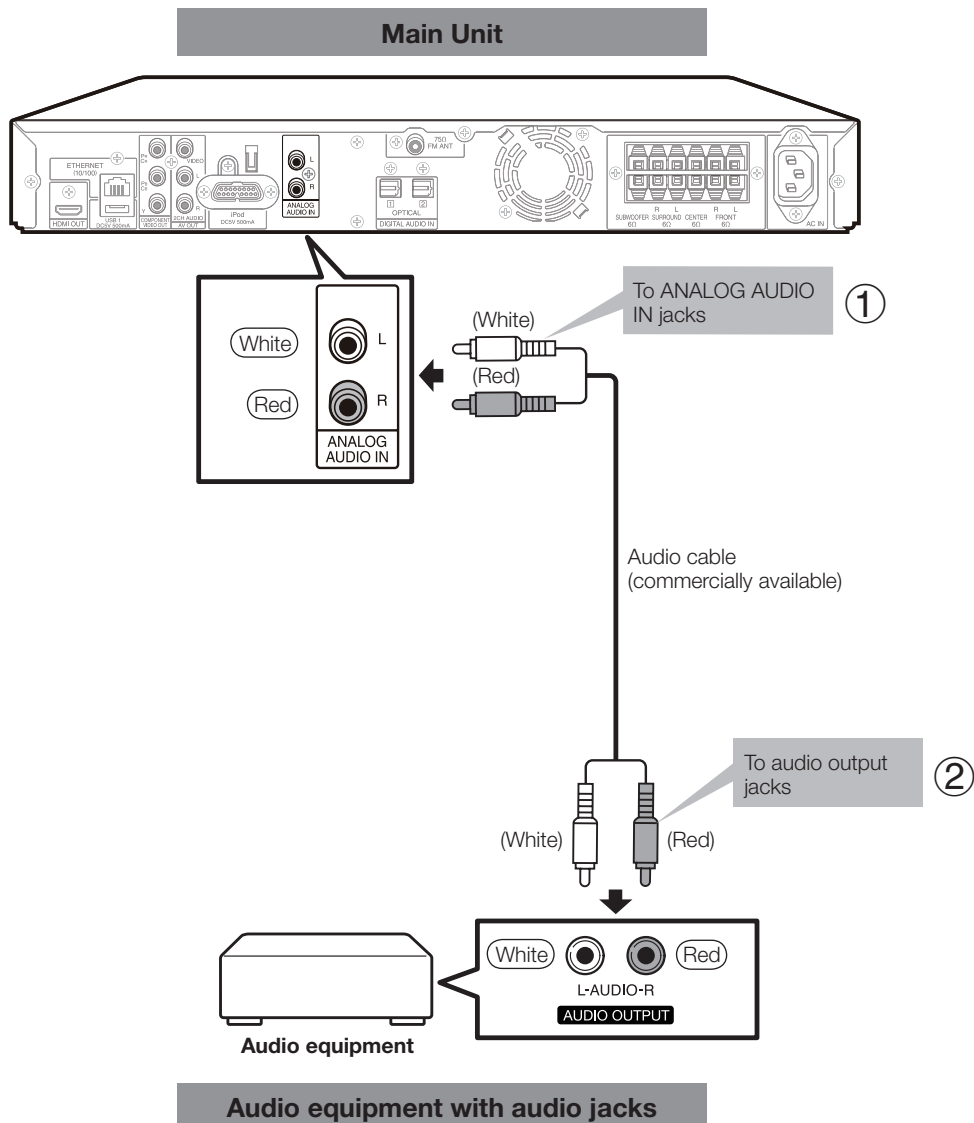

After connecting

- Play back the audio on the connected equipment and enjoy preset sound mode (page 65).

Audio Connections

Connecting to the iPod Terminal

- You can enjoy the iPod sound through the iPod terminal.

STEPS

- 1: Be sure to turn off this system and the equipment before making any connections.
- 2: Firmly connect an iPod cable to the iPod terminal.

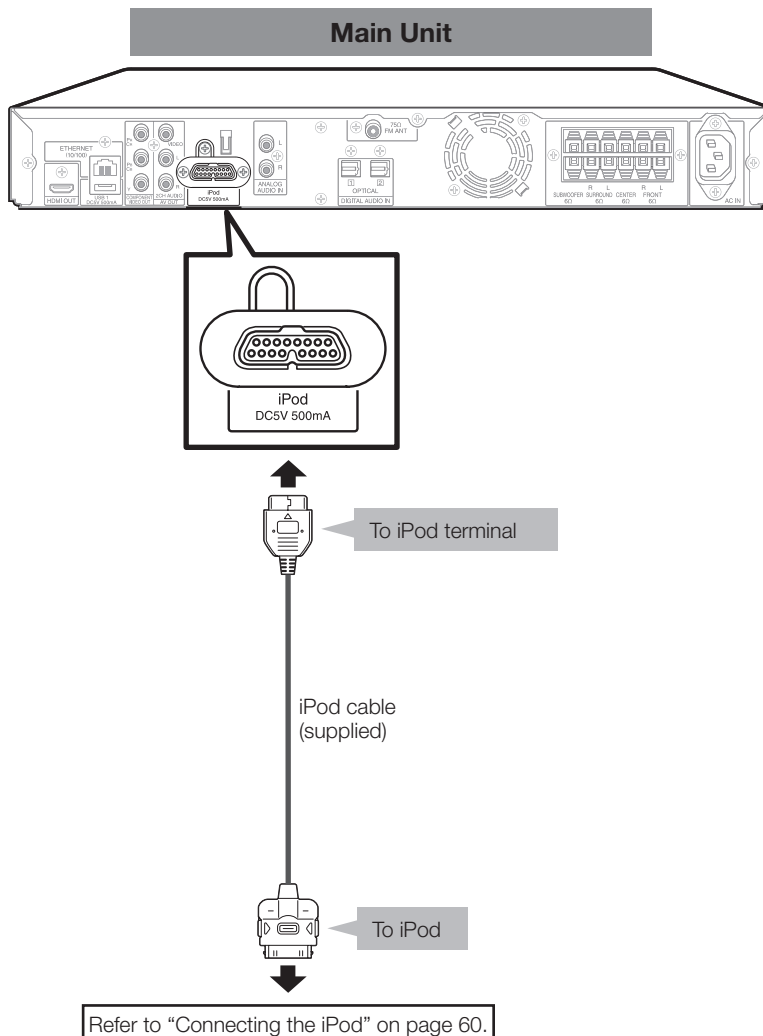

After connecting

- Connect to an iPod cable to the iPod and playback the iPod. Refer to "Listening to the iPod" (pages 60 and 61), then enjoy preset sound mode (page 65) etc..

Connecting to the 2CH AUDIO output Jacks

- You can connect audio equipment to 2CH AUDIO output jacks.

STEPS

- 1: Be sure to turn off this system and the equipment before making any connections.
- 2: Firmly insert the cable all the way into the terminal connector (① and ②).

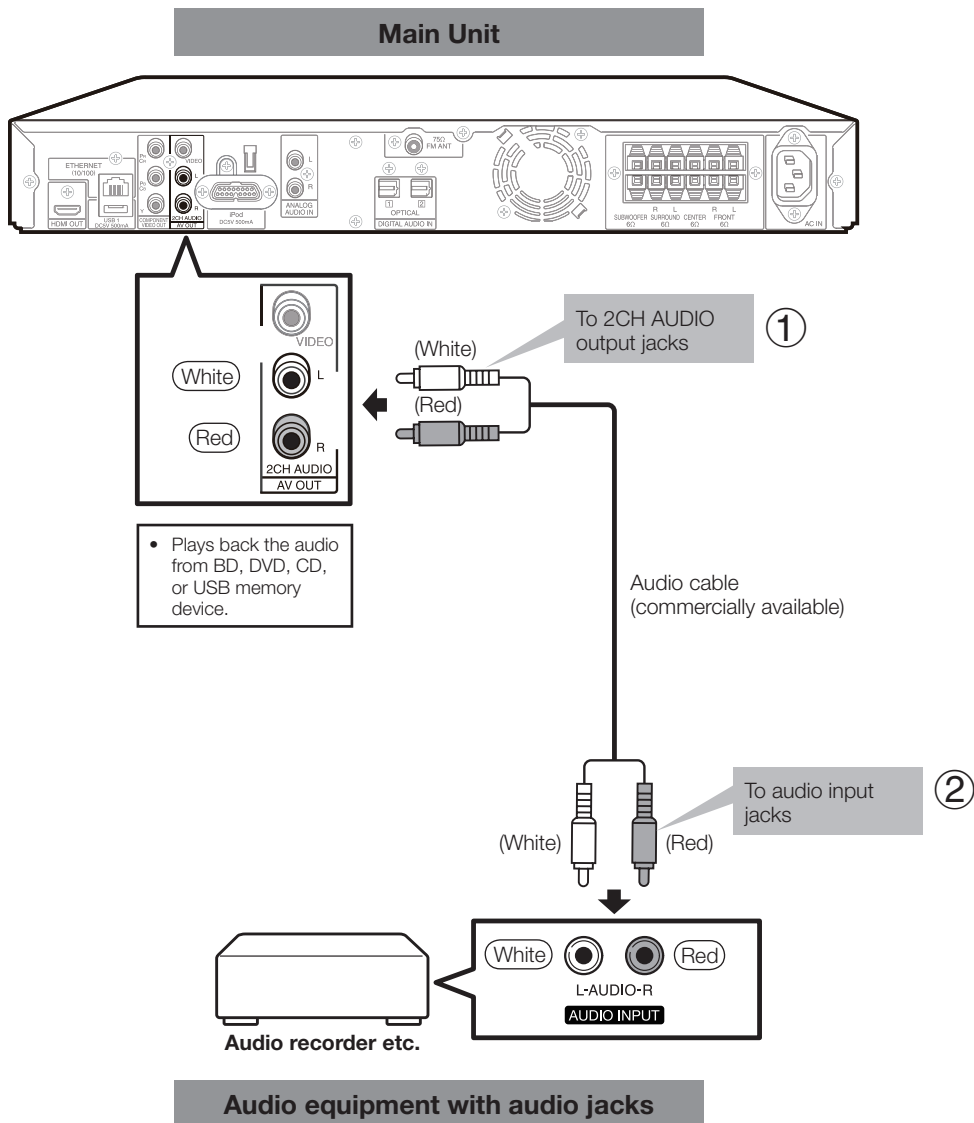

Broadband Internet Connection

Connecting to the ETHERNET terminal

- By connecting this system to the Internet, you can enjoy a variety of content on your TV using BD-LIVE functions, the RSS reader function and Netflix.
- This system can update the software from Sharp's server using the Internet.
- When using the Internet, a broadband Internet connection as shown below is required.

STEPS

- 1: Be sure to turn off this system and the equipment before making any connections.
- 2: Firmly connect a LAN cable (commercially available) to the ETHERNET terminal (① and ②).

CAUTION

- When using a broadband Internet connection, a contract with an Internet service provider is required. For more details, contact your nearest Internet service provider.
- Refer to the operation manual of the equipment you have as the connected equipment and connection method may differ depending on your Internet environment.

NOTE

- Use a LAN cable/router supporting 10BASE-T/100BASE-TX.
- SHARP cannot guarantee that all brands' hubs will operate with this system.

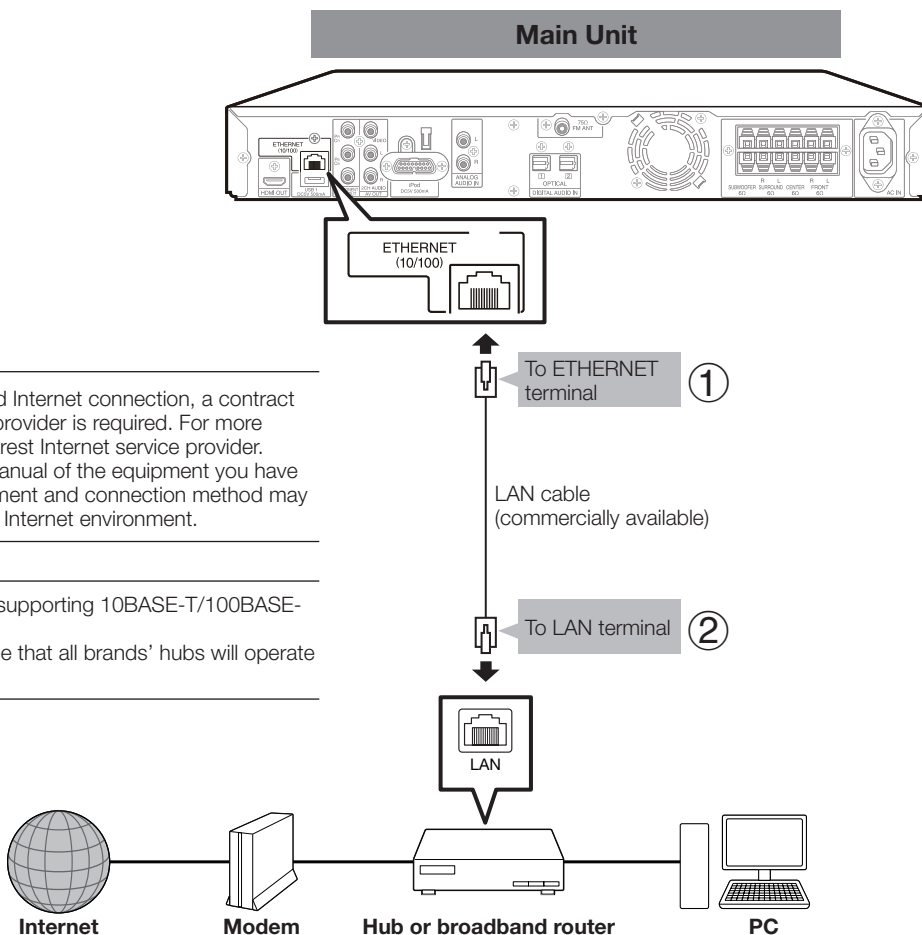

Example of a Broadband Internet Connection

After connecting

- Perform the communication settings. (Pages 71-73)
- When enjoying online service (BD-LIVE, RSS, Netflix), refer to BD-LIVE function (pages 47-48), the RSS reader function (page 37) or Netflix (pages 53-54).
- To update the software via the Internet, perform Software Update Settings. (Pages 75-76)

Antenna Connection

Connecting to the FM ANT Jack

You can connect an FM antenna to the system to receive FM broadcast.

STEPS

- 1: Be sure to turn off this system and the equipment before making any connections.
- 2: Firmly insert the cable all the way into the terminal connector.

Connecting a supplied FM antenna wire

Connect the FM antenna wire to the FM ANT jack and position the FM antenna wire in the direction where the strongest signal can be received.

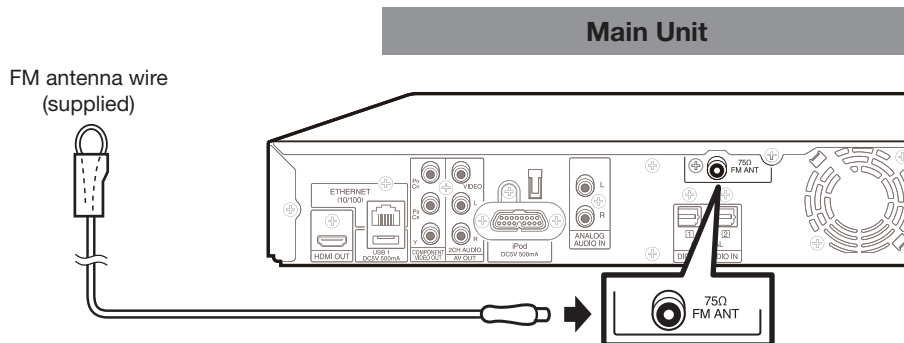

NOTE

- Placing the FM antenna wire on the unit or near the AC power cord may cause noise.
- Place the FM antenna wire away from the unit for better reception.

Connecting an external FM antenna

Use an outdoor FM antenna if you require better reception. Consult your dealer.

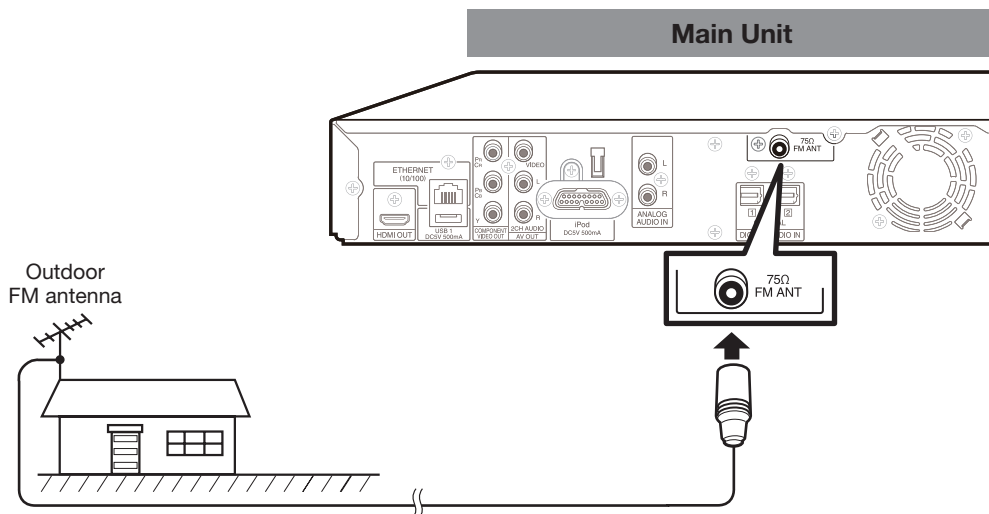

NOTE

- When an outdoor FM antenna is used, disconnect the supplied FM antenna wire.

After connecting

- Refer to "Listening to the FM Broadcast". (Page 62)

Before Starting Playback

Loading the Batteries in the Remote Control

- 1 Press down on the tab in the direction of the arrow to remove the battery cover.

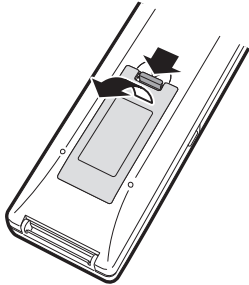

- 2 Load the two "AAA" size batteries (R-03 size, UM/SUM-4) supplied with the remote control. Make sure that the battery poles \oplus and \ominus are positioned as indicated.

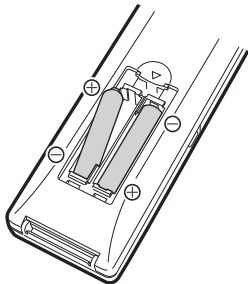

- 3 Slide the battery cover in the direction of the arrow until it clicks.

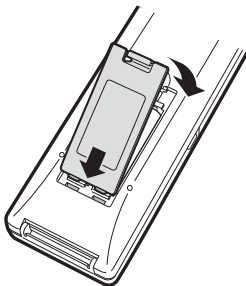

NOTE

- Do not subject the remote control to shock, water or excessive humidity.
- The remote control may not function if the system's remote sensor is in direct sunlight or any other strong light.
- Incorrect use of batteries may cause them to leak or burst. Read the battery warnings and use the batteries properly.
- Do not mix old and new batteries, or mix different brands.
- Remove the batteries if you will not use the remote control for an extended period of time.

WARNING

- Do not use or store batteries in direct sunlight or other excessively hot place, such as inside a car or near a heater. This can cause batteries to leak, overheat, explode or catch fire. It can also reduce the life or performance of batteries.

Approximate operating range of remote control

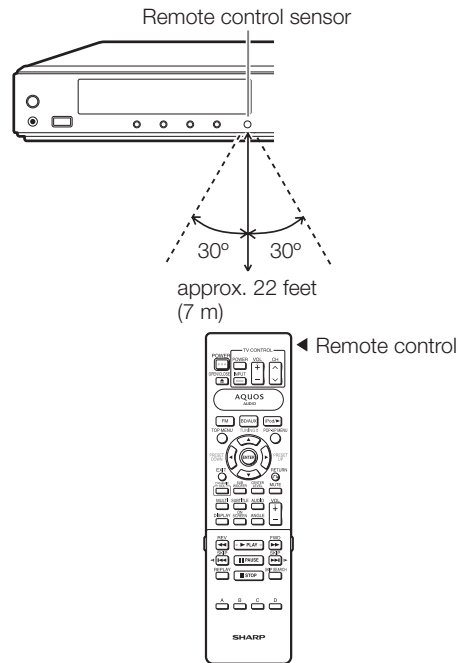

Connecting the Power Cord

Plug the supplied AC cord into the AC IN terminal on the rear of this system. Then plug into an AC outlet with ground hole.

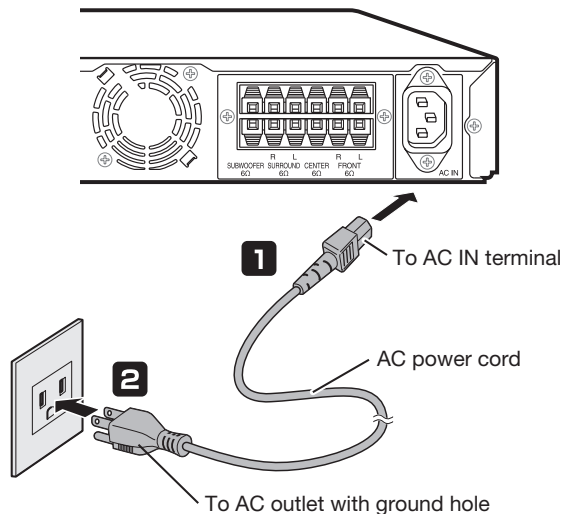

NOTE

- Place the system close to the AC outlet, and keep the power plug within reach.
- TO PREVENT RISK OF ELECTRIC SHOCK, DO NOT TOUCH THE UN-INSULATED PARTS OF ANY CABLES WHILE THE AC CORD IS CONNECTED.
- The STANDBY indicator blinks while the system is preparing for starting up. You cannot turn the system on until the STANDBY indicator stops blinking.
- If you are not going to use this system for a long period of time, be sure to remove the AC cord from the AC outlet.

Before Starting Playback

Setting the Remote Control Code

- 3 types of remote control codes operate this system: RC-1, RC-2 and RC-3. If you operate this system by remote control along with SHARP Blu-ray Disc Player or DVD Player placed next to it simultaneously, switching the remote control code (both the main unit and remote control) to one of the signals (RC-1, RC-2 or RC-3) will let you operate only with this system.
- Make sure to set the main unit and remote control to the same remote code. You can not operate the system if they are not set to the same code.



Buttons under the cover



Setting the remote control code of the remote control

Example: Setting the code to "RC-3".

- 1 Press and hold **3** first and then **POWER** on the remote control together for more than 5 seconds.
- 2 Press **POWER** (on the main unit) to turn off the system.

POWER

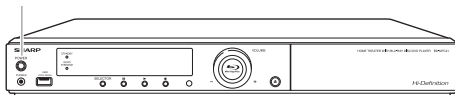

Setting the remote control code of the system

- 3 Point the remote control at the main unit, then press and hold the **ON SCREEN** for more than 10 seconds.

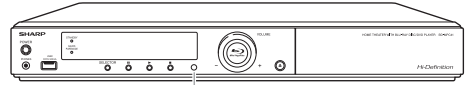

Remote control sensor

- 4 Press **POWER** (on the remote control) to turn on the system.

NOTE

- If the battery of the remote control becomes depleted or needs to be replaced, the remote control code is reset to RC-1 on the remote control. Performing a RESET resets the remote control code to RC-1 on the main unit. Set the remote control code on the main unit and remote control, as necessary.
- The following buttons on the remote control can be operated regardless of the remote control code.
- FM, BD/AUX, iPod/▶, SUB WOOFER, CENTER LEVEL, DYNAMIC VOL, MULTI, DISPLAY, MUTE, VOL+, VOL-, SOUND MODE, AUDIO DELAY, DIMMER

Before Starting Playback

Turning the Power On

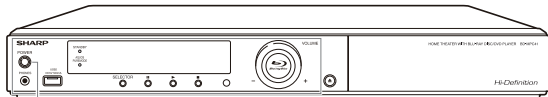
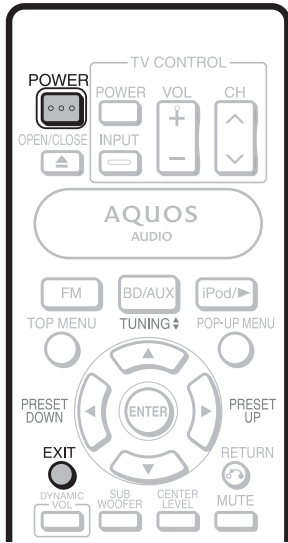

POWER

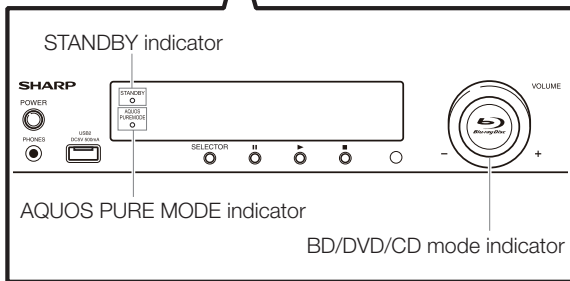

Turning the power on

Press **POWER** on the remote control or on the main unit to turn on the power of the system.



NOTE

- When you turn on this system for the first time after purchase or when you turn on this system after you perform "To Reset this System" (see page 83), the language setting screen will be displayed, so please perform the language setting (see step 4 of page 37).

Entering standby

Press **POWER** on the remote control or on the main unit to enter standby.



- If you press **POWER** again immediately after entering standby, the system may not turn on. If this happens, wait for 10 seconds or more and then turn on the power again.

NOTE

- When the STANDBY indicator is blinking (may take some time), the system cannot be turned on.

Indicators on the Main Unit

STANDBY indicator

Red blinks	Preparing for standby
Red on	Standby

AQUOS PURE MODE indicator

Green on	Output in AQUOS PURE MODE (See page 43.)
----------	--

BD/DVD/CD mode indicator

Blue on	Playing back
Blue blinks	Loading a disc

Before Starting Playback

Buttons under the cover

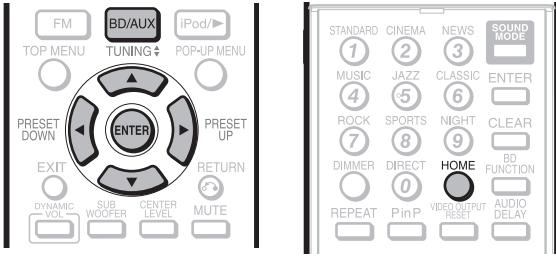

Language Setting

Changing the on-screen display language

- Press **BD/AUX** repeatedly to select DISC function.
 - The same operation can be performed by pressing **SELECTOR** repeatedly on the main unit.
- Press **HOME** to display the menu screen.
 - The same operation can be performed by pressing **ENTER** after selecting the HOME icon on the Wall paper screen.



- Press **▲/▼** to select “Settings”, then press **▶** or **ENTER**.



- Press **▲/▼** to select “On Screen Language”, then press **▶** or **ENTER**.

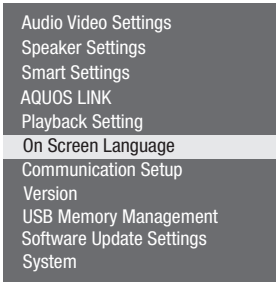

- Press **▲/▼** to select the language you want to display on the screen, then press **ENTER**.

NOTE

- To select the DVD disc language, such as subtitle language, etc., see page 46.

RSS Reader function

In this system, text information, such as news, which SHARP provides through the internet can be displayed scrolling text.

- To enjoy this function, perform the broadband internet connection (page 32) and communication settings (pages 71-73), then perform the following operation.

NOTE

- The information displayed varies periodically. However, the updating period is not constant depending on the content.
- The operation and text display may not be possible depending on the status of the player.
- When the main feature of a disc is played and the menu screen is displayed, this function cannot be displayed.
- When loading a disc, this function sometimes cannot be displayed.
- Please note that SHARP does not take any responsibility for the contents displayed with this function.

- Press **BD/AUX** repeatedly to select DISC function.
 - The same operation can be performed by pressing **SELECTOR** repeatedly on the main unit.
- Press **HOME** to display the menu screen.
 - The same operation can be performed by pressing **ENTER** after selecting the HOME icon on the Wall paper screen.
- Press **▲/▼** to select “e-Contents”, then press **▶** or **ENTER**.
- Press **▲/▼** to select “RSS”, then press **▶** or **ENTER**.
- Press **▲/▼** to select “On”, then press **ENTER**.
 - Select “Off” to turn off this function.
- Press **▲/▼** to select the desired channel.
 - The text information on the selected channel, such as news, is displayed, scrolling from right to left.

NOTE

- If you want to change the channel, press **◀/▶** to select the RSS icon and press **▲/▼** to select the desired channel while the Wall paper screen (Blu-ray Disc logo screen) is displayed.
- If you want to turn the text display off, perform the operations from step 1 when playback of the disc is stopped.

Before Starting Playback

Control Panel

This function allows you to operate this system using the TV remote control by displaying the control panel on the TV screen.

- To operate this function, connect this system to a TV compatible with HDMI CEC (Consumer Electronics Control) using an HDMI cable (see page 24). Make sure that "Control Panel" is set to "Yes" (see page 69). When the settings are completed, perform the following operations.

NOTE

- The control panel may not be displayed depending on the TV. Also, it may not be available depending on the content.
- When operating using the remote control of the system, the control panel does not appear.
- When playing Netflix streaming content, the control panel cannot be displayed.

- Switch the TV input to the input source to which this system is connected (HDMI input).
- Press the **PLAY** button on the TV remote control.
 - The control panel appears on the TV screen.

Control Panel

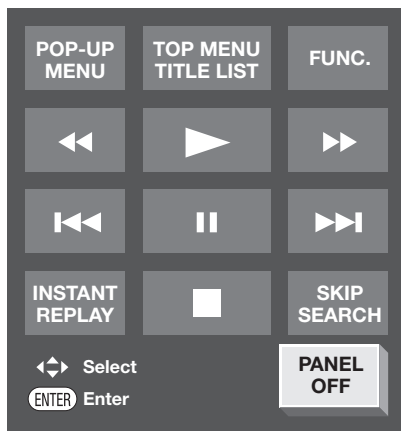

- When there is no operation for approximately 10 seconds, the control panel disappears automatically. To display the control panel, press the **PLAY** button on the TV remote control.

- Press **◀▶/▲/▼** on the TV remote control to select the desired button icon, then press **ENTER**.
 - The function of the selected button icon is available.

Major functions of each button icon

- POP-UP MENU**
 - Display the pop-up menu screen for BD video and the menu screen for DVD video.
- TOP MENU TITLE LIST**
 - Display the top menu screen for BD video and DVD video.
- FUNC.**
 - Display the Function Control screen for BD video, DVD video, etc.
- ◀◀**
 - Fast reverse (search).
- ▶**
 - Play.
- ▶▶**
 - Fast forward (search).
- ◀◀◀**
 - Skip to the beginning of a chapter.
- ||**
 - Pause.
- ▶▶▶**
 - Skip to the next chapter.
- INSTANT REPLAY**
 - Jump backward (approx. 10 seconds). (This function is used when you want to re-watch a scene that has just been shown.)
- - Stop.
- SKIP SEARCH**
 - Jump ahead (approx. 30 seconds).
- PANEL OFF**
 - Turn off the control panel.

Before Starting Playback

Speaker Settings

To ensure optimal sound, configure the speaker settings according to the speaker position.

Buttons under the cover

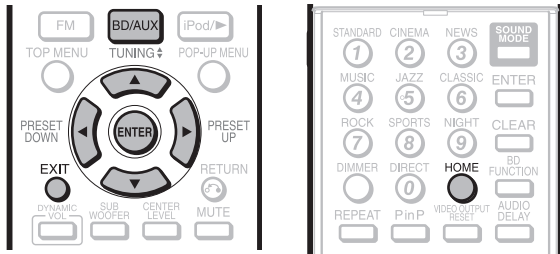

- Press **▲/▼** to adjust the item to the desired setting, then press **ENTER**.
 - See the information on the right column for details on each adjustment item.

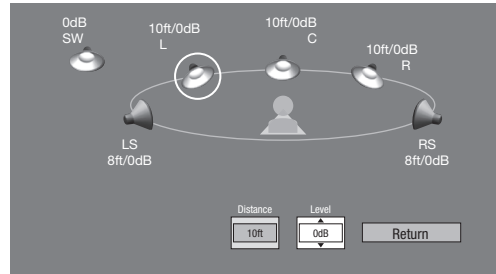

- Repeat from steps 6 to 8 for each speaker.

Setting configuration

- Press **BD/AUX** repeatedly to select DISC function.
 - The same operation can be performed by pressing **SELECTOR** repeatedly on the main unit.
- Press **HOME** to display the menu screen.
 - The same operation can be performed by pressing **ENTER** after selecting the HOME icon on the Wall paper screen.
- Press **▲/▼** to select “Settings”, then press **▶** or **ENTER**.
- Press **▲/▼** to select “Speaker Settings”, then press **▶** or **ENTER**.
- Press **▲/▼** to select “Yes”, then press **▶** or **ENTER**.
- Press **◀/▶/▲/▼** to select the speaker, then press **ENTER**.

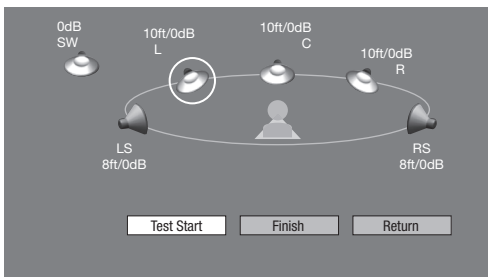

- L: Front speaker (left)
- C: Center speaker
- R: Front speaker (right)
- RS: Surround speaker (right)
- LS: Surround speaker (left)
- SW: Subwoofer

- Press **◀/▶** to select a specific adjustment item.

Distance

Selectable Range
Select from 1 feet to 29 feet in 1 feet increments.

- NOTE**
- You cannot specify Distance for the subwoofer.

Level

The level that can be specified varies depending on the speaker.

Selectable Range
-6 dB to +6 dB: The selectable range for L, R, C, RS, LS, and SW.

- NOTE**
- You can specify the level in 1 dB increments.

(Continued on the next page)

Before Starting Playback

Testing the speaker settings

Adjust the volume to 30 before testing the audio level.
(Page 41)

10 Press ▲/▼/◀/▶ to select “Test Start”, then press **ENTER**.

- A test tone is outputted from each speaker in the following order:
L→C→R→RS→LS→SW

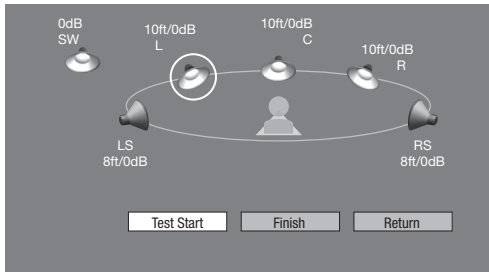

- To select a speaker to be tested, press ▲/▼/◀/▶ to select the speaker while the test tone is output.
- To stop the test tone, select “Test Tone Stop”.

Adjusting the level

When the sound volume level of each speaker is uneven, adjusting the level separately.

11 Press ▲/▼/◀/▶ to select the speaker with the setting you want to adjust, then press **ENTER**.

- To select the speaker outputting the test tone, press **ENTER**.

12 Press ◀/▶ to select “Level”.

13 Press ▲/▼ to adjust the desired level, then press **ENTER**.

14 Repeat from steps 11 to 13 for each speaker.

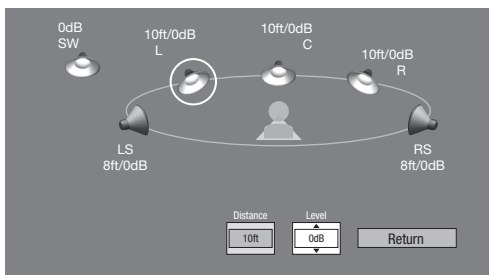

Completing the settings

15 Press ▲/▼/◀/▶ to select “Finish”, then press **ENTER**.

16 Press **HOME** or **EXIT** to exit.

Basic Operations

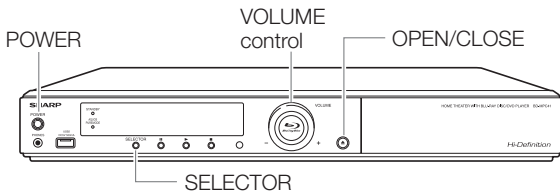

Loading a Disc

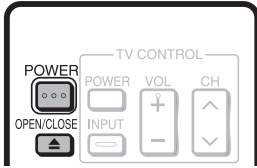

- 1 Press **POWER** to turn on the power.
- 2 Press **OPEN/CLOSE** to open the disc tray.
- 3 Load a disc on the disc tray.
 - Insert the disc with the label face up.
 - In case of disc recorded on both sides, face down the side to play back.

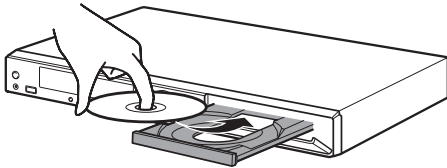

- 4 Press **OPEN/CLOSE** to close the disc tray.
 - Playback may begin automatically, depending on the disc.

Input Selection

Changing the input selection on the main unit

You can change the input source using **SELECTOR**. Each time **SELECTOR** is pressed, the input source changes as follows:

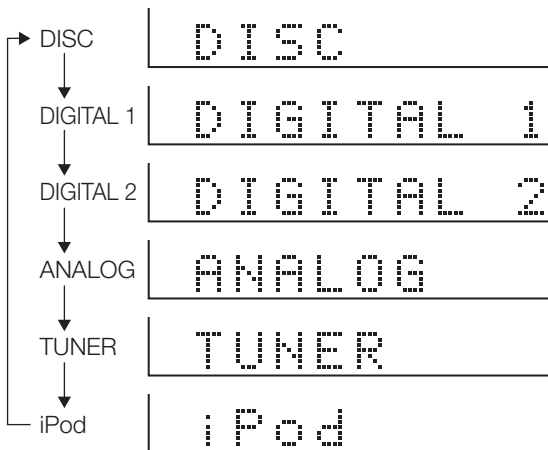

Changing the input selection with the remote control

The operation buttons vary depending on the input mode.

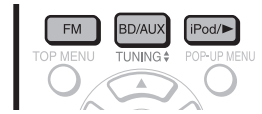

Pressing **BD/AUX** changes the input mode as follows.



To change the FM input mode, press **FM**.

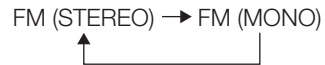

To select the iPod mode, press **iPod/▶**.

Volume Adjustment

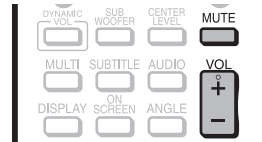

Adjusting the volume

Main unit operation:

When the **VOLUME** control is turned clockwise, the volume will increase.

When it is turned counterclockwise, the volume will decrease.



Remote control operation:

Press **VOL+** to increase the volume and **VOL-** to decrease the volume.

Muting the sound

The sound is muted temporarily when pressing **MUTE** on the remote control.

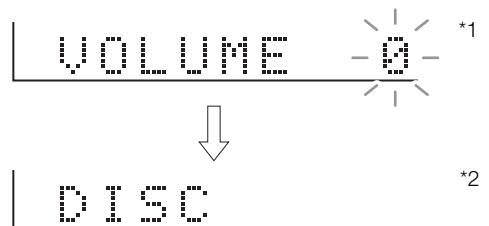

*1 flashes for 3 seconds, and then the "Function" (status display) appears.

*2 The elapsed time is displayed during disc playback.

- The mute function is canceled when you adjust the volume.

Basic Operations

Changing the Display

Use **DISPLAY** on the remote panel to change the display on the front display panel.



Pressing **DISPLAY** changes the display as follows.

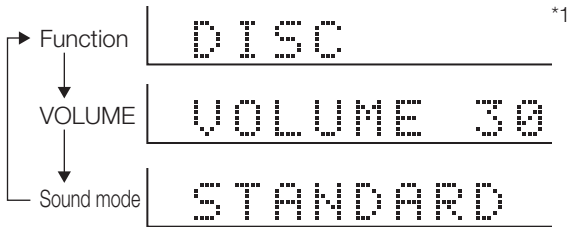

*1 The elapsed time is displayed during disc playback.

NOTE

- If no buttons are operated for 3 seconds during the volume display or sound mode display, the Function display appears.

Using Headphones

- Before plugging in or unplugging the headphones, reduce the volume.
- Be sure your headphones have a 1/8" (3.5 mm) diameter plug and are between 16 ohms and 50 ohms impedance. The recommended impedance is 32 ohms.
- While headphones are connected, sound is not produced from the speakers.
- You cannot use the surround feature with headphones.

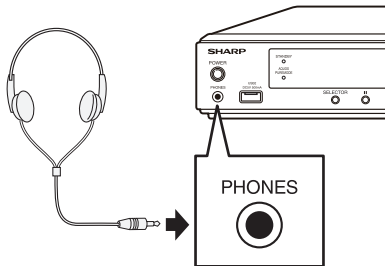

To Dim the Display

If you feel that the display on the main unit is too bright when watching movies, you can dim the display.

Buttons under the cover



Press **DIMMER** to dim the display.

- Press **DIMMER** again to cancel dim.

Operating a SHARP TV Using the Remote Control

The Universal Remote Control may operate the basic functions of the SHARP TV.

TV function control

- TV Power: POWER
- TV Channel up/down: CH \wedge/\vee
- TV Volume up/down: VOL + / -
- TV-AV Selector: INPUT

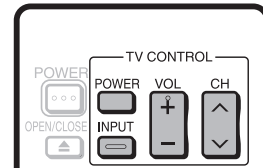

AQUOS LINK Control

Controlling This System Using AQUOS LINK

What is AQUOS LINK?

Using the HDMI CEC (Consumer Electronics Control), with AQUOS LINK you can interactively operate this system with your SHARP AQUOS TV.



What you can do with AQUOS LINK

When you connect this system to the AQUOS TV compatible with AQUOS LINK using an HDMI cable, you can perform the function listed below. (See page 24 for connecting to the HDMI terminal.)

- **Playback function turns on the AQUOS TV immediately.**
When you start to playback of this system, power of AQUOS TV will be turned on and the playback image will appear on the screen.
- **Automatic input select function**
When you start playback of this system, the input selector of the AQUOS TV will automatically switch to the AQUOS TV input terminal connected to the system and the playback image will appear on the screen, even if you are watching a TV program.
- **Automatic power off function**
If you turn off the AQUOS TV when this system is in stop mode, the power of this system will be turned off automatically. (In the case, while playing back a disc, the power does not turn off.)
- **Automatic power on function**
When you switch to the AQUOS TV input terminal connected to this system, the power of this system will be turned on automatically.
Use the remote control system of the AQUOS TV and point it towards the AQUOS TV for operation.
- **One-touch operation**
You can use the remote control of your AQUOS TV and point it towards the AQUOS TV to control the volume, mute the sound, and select the audio setting of this system.
- **AQUOS PURE MODE**
When you connected this system to an AQUOS TV compatible with AQUOS LINK and set "AQUOS LINK" to "Yes" (page 69), image automatically adjusted to the most suitable image quality for the AQUOS TV are output from the HDMI OUT terminal of this system.
The AQUOS PURE MODE indicator on this system lights in green.

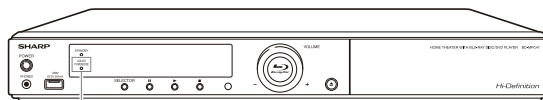

AQUOS PURE MODE indicator

NOTE

- In order to make AQUOS LINK available, connect an LCD TV to this system using an HDMI terminal. Set "AQUOS LINK" to "Yes" (see page 69). Refer to the Operation Manual on the TV for details regarding setup.

Video/Picture/Music Playback

BD/DVD Video Playback

BD VIDEO **BD-RE** **BD-R**

DVD VIDEO **DVD-R** **DVD-RW**

This section explains playback of commercially available BD Video and DVD Video discs (like movies), and recorded DVD-RW/R discs.

- This system supports DVD upscaling during DVD playback.
- For a description of other playback functions, refer to "Playback Functions" on pages 55-57.

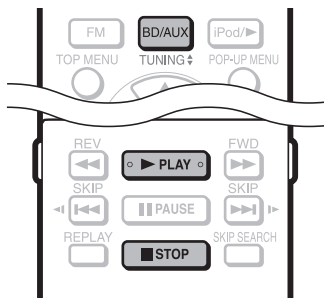

- 1 Press **BD/AUX** repeatedly to select DISC function.
 - The same operation can be performed by pressing **SELECTOR** repeatedly on the main unit.
- 2 Load a disc.
 - Playback may begin automatically, depending on the disc.
 - Playback begins from the first title.
 - The menu may be displayed first, depending on the disc. Perform playback operation by following the directions on the screen.
- 3 Press **▶ PLAY** if playback does not begin automatically or playback is stopped.

NOTE

- The disc load time may vary depending on the disc.

Regarding playback of BD video discs

- Some of the newly released BD video discs cannot be played back unless you update the system software to the latest version. Therefore, it may be required to update the software of the system.

Refer to pages 75-78 for more information regarding software updates for the system.

To stop playback

Press **■ STOP**.

Resume playback function

- If you press **▶ PLAY** next, playback will resume from the point where the system was previously stopped. To playback from the beginning, cancel resume mode by pressing **■ STOP**, then press **▶ PLAY**. (This may not work depending on the type of disc. In this case, open the disc tray or enter standby.)

NOTE

- Resume playback may not function depending on the disc.
- The resume playback function for discs will be cancelled if Netflix content is viewed after disc playback. Disc playback will start from the beginning after viewing Netflix content.

Displaying the disc information

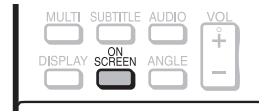

Press **ON SCREEN** during playback.

- Each time you press **ON SCREEN**, the display switches as follows.

Disc Information Screen A

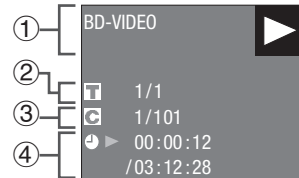

Disc Information Screen B

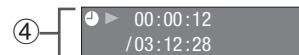

No Display

- ① Type of disc
- ② Title number being played / Total number of Titles
- ③ Chapter number being played / Total number of Chapters
- ④ Elapsed playback time / Total playback time for the Title

NOTE

- Disc Information Screen A disappears after about 1 minute elapses without performing any operations.
- For some commercially-released BD VIDEO discs, the total playback time display for the Chapter/Title may not appear.

BD/DVD Menus

- This section explains how to play back a BD/DVD video disc with a top menu, disc menu or pop-up menu.
- The titles listed in the top menu and a disc guide (for options like subtitles and audio languages) are given in the disc menu.

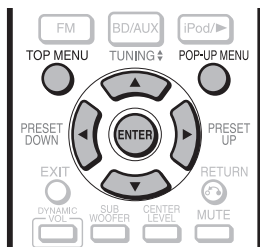

Start playback by selecting a title from the top menu

BD VIDEO **DVD VIDEO**

- 1 Press **TOP MENU**.
 - The top menu screen is displayed if present on the BD/DVD video disc.

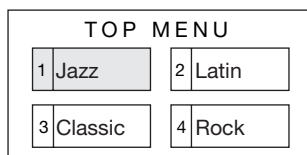

- 2 Press **▲/▼/◀/▶** to select the title, then press **ENTER**.
 - The selected title is played back.

NOTE

- The procedure explained on this page is the basic operation procedure. Procedures vary depending on the BD/DVD video disc, so you may need to follow the instructions in the BD/DVD video disc manual or the instructions displayed on the screen.

Top menu

- With some BD/DVD discs, the top menu may be referred to as the "Title Menu". Use **TOP MENU** on the remote control when the instructions refer to "Title Menu".
- If no top menu is available, the **TOP MENU** button will have no effect.

Using the disc menu

DVD VIDEO

Example: Select "SUBTITLE LANGUAGE".

- 1 Press **TOP MENU**.
 - The disc menu screen is displayed if present on the DVD video disc.
- 2 Press **▲/▼** to select "SUBTITLE LANGUAGE", then press **ENTER**.
 - The screen for selecting the subtitle language is displayed.

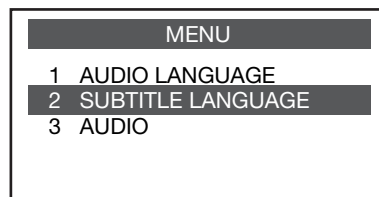

- 3 Press **▲/▼** to select the subtitle language, then press **ENTER**.
- 4 Press **TOP MENU** to exit.

Using the pop-up menu

BD VIDEO

- 1 Press **POP-UP MENU** during playback.
 - The pop up menu screen is displayed.
 - The menu contents displayed vary depending on the disc. For details on how to see and operate the pop-up menu, refer to the manual for the disc.

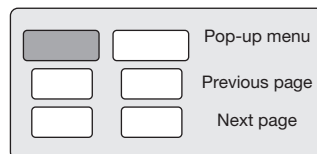

- 2 Press **▲/▼/◀/▶** to select the desired item, then press **ENTER**.
- 3 Press **POP-UP MENU** to exit.
 - The pop-up menu will automatically disappear for some discs.

Enjoying BONUSVIEW or BD-LIVE

BD VIDEO

This system is compatible with additional functions of BD-Video, BONUSVIEW (BD-ROM Profile 1 Version 1.1) and BD-LIVE.

For BD-Video discs compatible with BONUSVIEW, the functions of Picture in Picture and Virtual Package are available. For BD-LIVE compatible discs, you can enjoy a variety of functions via the internet in addition to the BONUSVIEW functions.

Virtual Package/BD-LIVE data is saved in Local Storage (USB memory device connected to this system). To enjoy these functions, connect a USB memory device (2GB or greater) supporting USB 2.0 High Speed (480Mbit/s) to the USB1 or USB2 terminal on this system.

- It is recommended that the USB memory device be connected to the USB1 terminal on the rear of the system. (When you insert or remove a USB memory device, be sure to turn the main power off and make sure that "Quick Start" is set to "No" (See page 69).)

NOTE

- A USB memory device can be used with either the USB1 or USB2 terminal. When two USB memory devices are connected to both terminals at the same time, in certain situations the USB1 terminal may give priority to Local Storage and the USB2 terminal may not be able to be used for Local Storage.

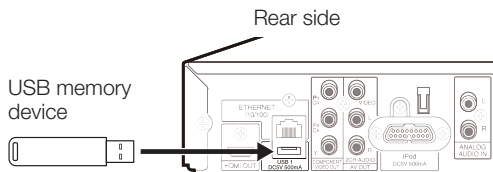

- If there is insufficient storage space, the data will not be copied/downloaded. Delete unneeded data or use a new USB memory device.
- If a USB memory device containing other data (previously recorded) is used, the video and audio may not play back properly.
- If the USB memory device is disconnected from this system during playback of Virtual Package/BD-LIVE data, playback of the disc will stop.
- Some time may be required for the data to load (read/write).
- Refer to "USB Memory Management" on page 74 for erasing the Virtual Package data and the BD-LIVE data in the USB memory device.

NOTE

- SHARP cannot guarantee that all brands' USB memory devices will operate with this system.
 - Only USB memory devices formatted with FAT 32/16 are compatible.
- When formatting a USB memory device using a PC, perform the following settings.
- Format File System: FAT32
 - Allocation Unit Size: Default Allocation Size
- Do not use a USB extension cable when connecting a USB memory device to the USB1 or USB2 terminal on this system.
 - Using a USB extension cable may prevent the system from performing correctly.

Use of Picture in Picture function (secondary audio/video playback)

BD-Video that includes secondary audio and video compatible with Picture in Picture can be played back with secondary audio and video simultaneously as a small video in the corner.

Buttons under the cover



- Press PinP during playback to show the 2-picture screen.



Primary audio/
video

Secondary
audio/video

- To remove the secondary video, press PinP again.

NOTE

- To listen to secondary audio, make sure that "Secondary Audio" is set to "On". (See page 68.)
- The secondary audio and video for Picture In Picture may automatically play back and be removed depending on the content. Also, playable areas may be restricted.

Virtual Package

For BD-Video discs compatible with Virtual Package, data is copied from the discs or internet to local storage. It is automatically copied to the local storage prior to playback. You can enjoy a variety of additional functions including secondary video, secondary audio, subtitles, movie trailers, etc.

- The playback methods vary depending on the disc. For details, refer to the disc manual.

(Continued on the next page)

BD-LIVE

In this system, a variety of contents with interactive functions are available through BD-LIVE compatible Blu-ray discs by connecting to the internet. You can enjoy the download of bonus features such as latest movie trailers to the USB memory device, communication compatible BD-J interactive games, etc.

- The available functions differ depending on the disc.

NOTE

- Regarding playback method of BD-LIVE contents, etc., perform the operations in accordance with the instructions in the BD disc manual.
- To enjoy BD-LIVE functions, perform the broadband internet connection (page 32) and communication settings (pages 71-73).
- Refer to page 70 regarding the setup to restrict access to BD-LIVE contents.
- If the BD-LIVE screen does not appear for a while after you select the BD-LIVE function in the BD disc menu, the USB memory device may not have enough free space. In such cases, eject the disc from the main unit, and then erase the data in the USB memory device using the Data Erase menu in the "USB Memory Management" menu on page 74.

DVD-R/-RW (VR format) / BD-RE/-R (BD-RE format) Playback

DVD-R **DVD-RW** **BD-RE** **BD-R**

You can play back a recorded disc (DVD: VR format finalized disc only / BD: BDAV format disc only).

- For a description of other playback functions, refer to "Playback Functions" on pages 55-57.



NOTE

- "Finalize" refers to a recorder processing a recorded disc so that it will play in other DVD players/recorders as well as this system. Only finalized DVD discs will play back in this system. (This system does not have a function to finalize discs.)
- Some discs cannot be played back depending on the audio format.

Playback by selecting a title

- 1 Press **BD/AUX** repeatedly to select DISC function.
 - The same operation can be performed by pressing **SELECTOR** repeatedly on the main unit.
- 2 Load a recorded disc.
 - The Title List screen is displayed.

Example: Thumbnail screen

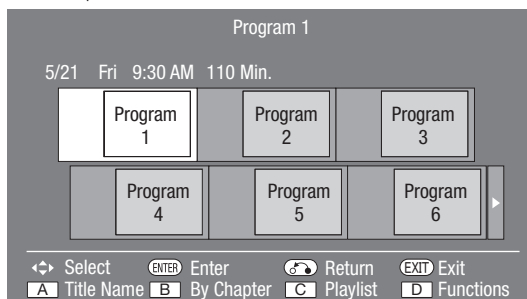

- If the Title List screen is not displayed, press **TOP MENU**.
- When loading a BD disc with usage restrictions placed by a BD recorder, the password input screen appears. Then, input your password. If you input a wrong password three times, the disc tray will open. Close the disc tray, and then input a correct password.

- 3 Press **▲/▼/◀/▶** to select the desired title, then press **ENTER** to start playback.
 - If you want to select additional titles, switch pages by pressing **◀◀ SKIP/◀|** or **▶▶ SKIP/|▶**.
 - You can playback by pressing **▶ PLAY** instead of pressing **ENTER**.
- 4 Press **■ STOP** to stop playback.

NOTE

- The Title List screen also can be displayed by pressing **TOP MENU** when playback is stopped.

Video/Picture/Music Playback

About Title List

- The Title List can be displayed in two types, Thumbnail and Title Name.
- Each time you press **A** (Red), the screen changes between Thumbnail and Title Name.

Thumbnail

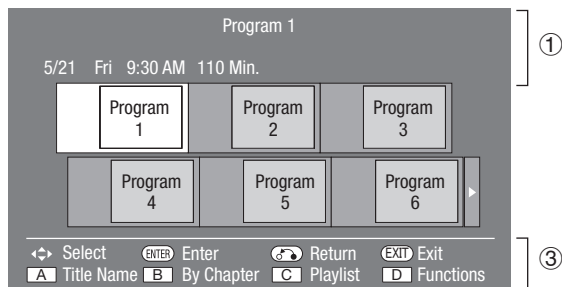

Title Name

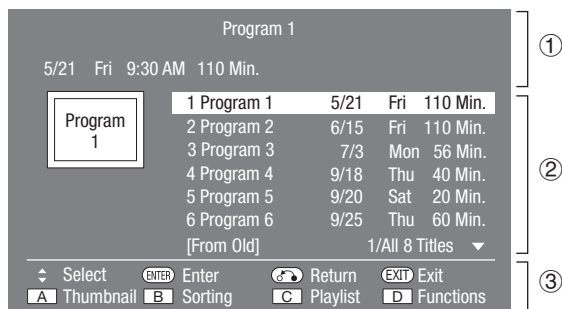

- Information of selected title
- Title Name
Recording Date
Recording Duration
- Button Guide

Playback by selecting a chapter

- Press **B** (Green) while the Thumbnail screen is displayed.
 - The chapter screen is displayed.

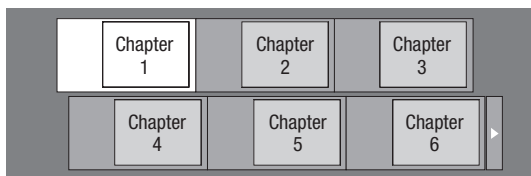

- If you want to select additional chapters, switch pages by pressing **◀◀ SKIP/◀** or **▶▶ SKIP/▶**.
 - To return to the Thumbnail screen, press **B** (Green).
- Press **▲/▼/◀/▶** to select the desired chapter, then press **ENTER** to start playback.
 - You can playback by pressing **▶ PLAY** instead of pressing **ENTER**.
 - Press **■ STOP** to stop playback.

Sorting the titles

Each time you press **B** (Green) while the Title Name screen is displayed, the Title Name display changes between displaying the newest title first and the oldest title first.

Playback by selecting a Playlist

- Press **C** (Blue) while the Title List screen is displayed.
 - The Playlist screen is displayed.

Example: Thumbnail screen

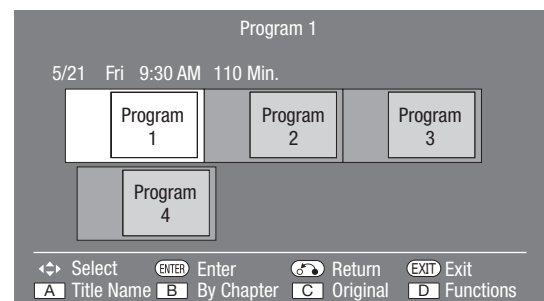

- Press **▲/▼/◀/▶** to select the desired title, then press **ENTER** to start playback.
- Press **■ STOP** to stop playback.

Playback from the beginning or resume playback

When you play back the title from the Title List after you stopped playback, you can select playback from the beginning or from the point where it was last stopped.

- Press **D** (Yellow) when the desired title is selected while the Title List screen is displayed.
- Press **▲/▼** to select the type of Playback, then press **ENTER** to start playback.
 - The type of playback may be selected from "From Beginning" or "From Continued".
- Press **■ STOP** to stop playback.

Audio CD Playback

AUDIO CD

This system can play back audio CDs.

- For a description of other playback functions, refer to "Playback Functions" on pages 55-57.

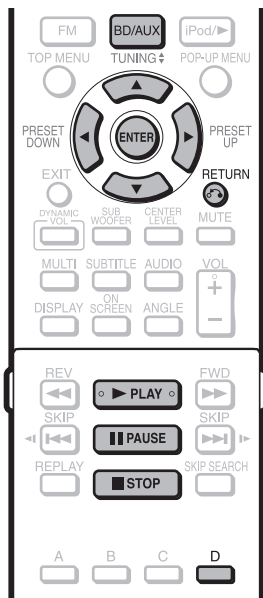

Playback from the beginning

- Press **BD/AUX** repeatedly to select DISC function.
 - The same operation can be performed by pressing **SELECTOR** repeatedly on the main unit.
- Load an audio CD.
 - The CD screen is displayed. (The CD screen is displayed only when a compact disc recorded in the CD-DA format is inserted.)
 - Playback may begin automatically, depending on the disc.

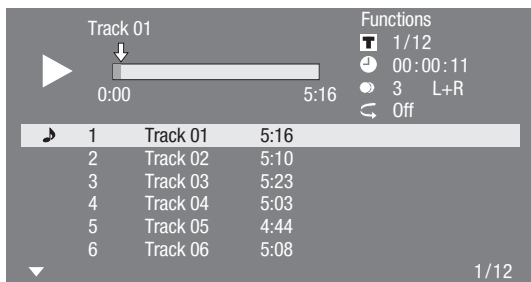

- Press **▶ PLAY** if playback does not begin automatically or playback is stopped.
- To pause the playback at any time, press **|| PAUSE**.
 - Press **|| PAUSE** or **▶ PLAY** to return to playback.
- Press **■ STOP** to stop playback.

Playback by selecting a track

- Press **▲/▼** to select the track, then press **ENTER** during playback or when playback is stopped.
 - Playback of the selected track will begin.

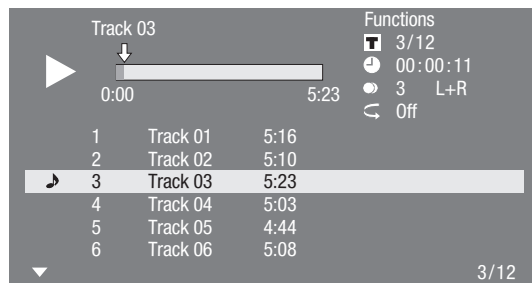

- Press **■ STOP** to stop playback.

Operation procedure for the "Functions" menu

- Press **D (Yellow) (Functions)** when the CD screen is displayed.
 - The "Functions" menu is activated.

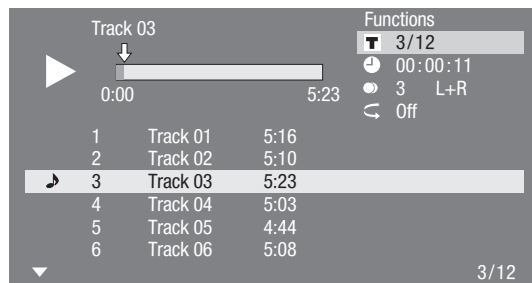

- Press **▲/▼** to select the desired setting, then press **ENTER**.
 - When playback is stopped, only "Track" can be selected.
 - For a description of each setting, see "Functions which can be set". (Page 59)
- Press **▲/▼/◀/▶** to set, then press **ENTER**.
 - Operations vary depending on the setting. Follow the operation instructions on the screen.
- Press **○ RETURN** or **D (Yellow)** to exit the "Functions" menu.

NOTE

- The displayed items vary depending on the disc.

Audio Data (MP3 File) Playback

CD-R CD-RW DVD-R DVD-RW USB

This system can play back audio data (MP3 files) recorded on CD-R/RW discs, DVD-R/RW discs and USB memory devices.

- For details on the audio data that you can play using this system, refer to page 10.

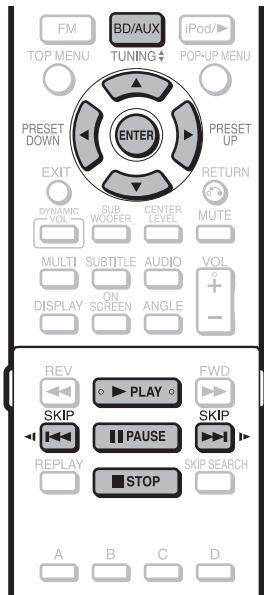

Buttons under the cover



Playing back Audio data (MP3 files)

When you insert or remove a USB memory device, be sure to turn the main power off and make sure that "Quick Start" is set to "No" (See page 69).

- Load a disc or insert a USB memory device containing audio data (MP3 files).
 - It is recommended that the USB memory device be connected to the USB2 terminal on the front of the system.

NOTE

- A USB memory device can be used with either the USB1 or USB2 terminal. When two USB memory devices are connected to both terminals at the same time, in certain situations the USB1 terminal may give priority to Local Storage and MP3 files may not be able to be played back using this terminal.

- Press **BD/AUX** repeatedly to select DISC function.
 - The same operation can be performed by pressing **SELECTOR** repeatedly on the main unit.
- Press **HOME** to display the menu screen.
- Press **▲/▼** to select "Music", then press **▶** or **ENTER**.

- Press **▲/▼** to select "DVD/CD*" or "USB Memory Device", then press **▶** or **ENTER**.
 - * Display name varies depending on the type of media inserted.
 - If only a "DVD/CD" or a USB memory device is inserted, the "DVD/CD" or "USB Memory Device" selection screen does not appear. In such cases, after step 4, proceed to step 6.
- Press **▲/▼** to select a folder or file.
 - When you select a folder, press **ENTER** to open it, and then press **▲/▼** to select a file in the folder.

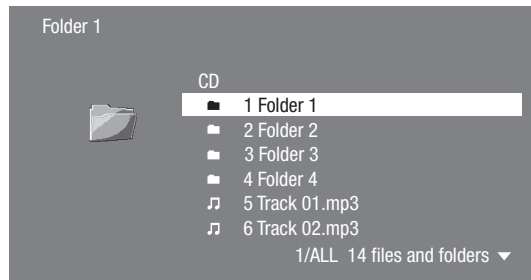

- Press **ENTER** to play back the selected file.
 - Playback of the selected file will begin.

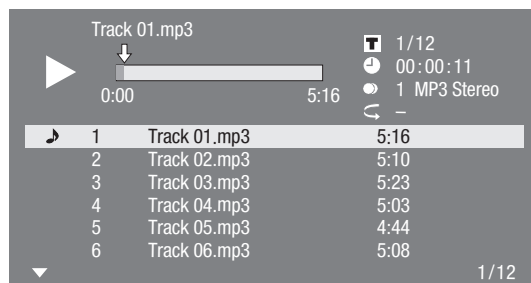

- When MP3 files are played, the "Functions" menu is not available.
- To pause the playback at any time, press **|| PAUSE**.
 - Press **|| PAUSE** or **▶ PLAY** to return to playback.
 - Press **■ STOP** to stop playback.

To play another file during Playback

Press **▲/▼** to select the file you want to play, then press **ENTER**.

- The chosen file will be played.

To skip the file during Playback

Press **◀◀ SKIP/◀** or **▶▶ SKIP/▶**.

- Press **◀◀ SKIP/◀** to skip backward.
- Press **▶▶ SKIP/▶** to skip forward.

NOTE

- The Fast Forward/Reverse function does not work.
- The Repeat function does not work.

Displaying Still Images (JPEG files)

CD-R CD-RW DVD-R DVD-RW USB

This system can display still images (JPEG files) recorded on CD-R/RW discs, DVD-R/RW discs and USB memory devices.

- For details on the still images that you can display using this system, refer to page 10.
- Still images are played one by one while during "Slide show", they are automatically replaced one after another.

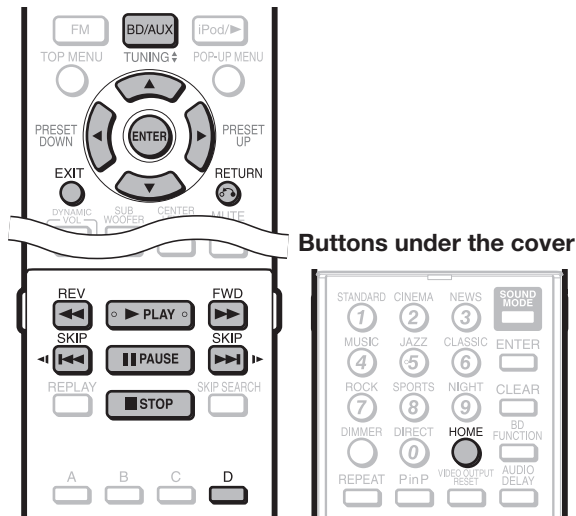

Buttons under the cover

Displaying Still Images (JPEG files)

When you insert or remove a USB memory device, be sure to turn the main power off and make sure that "Quick Start" is set to "No" (See page 69).

- 1 Load a disc or insert a USB memory device containing Still Images (JPEG files).
 - It is recommended that the USB memory device be connected to the USB2 terminal on the front of the system.

NOTE

- A USB memory device can be used with either the USB1 or USB2 terminal. When two USB memory devices are connected to both terminals at the same time, in certain situations the USB1 terminal may give priority to Local Storage and JPEG files may not be able to be played back using this terminal.

- 2 Press **BD/AUX** repeatedly to select DISC function.
 - The same operation can be performed by pressing **SELECTOR** repeatedly on the main unit.
- 3 Press **HOME** to display the menu screen.
- 4 Press **▲/▼** to select "Picture", then press **▶** or **ENTER**.
- 5 Press **▲/▼** to select "DVD/CD*" or "USB Memory Device", then press **▶** or **ENTER**.
 - * Display name varies depending on the type of media inserted.
 - If only a "DVD/CD" or a USB memory device is inserted, the "DVD/CD" or "USB Memory Device" selection screen does not appear. In such cases, after step 4, proceed to step 6.

- 6 Press **▲/▼** to select a folder or file.
 - When you select a folder, press **ENTER** to open it, and then press **▲/▼** to select a file in the folder.

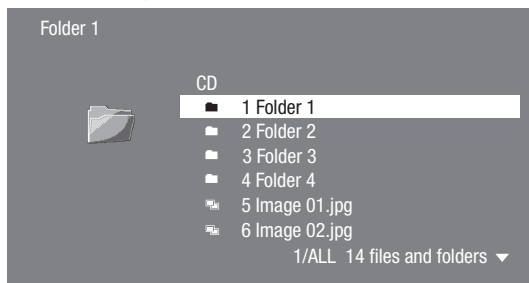

- 7 Press **ENTER** to display the selected file.
 - The selected still image appears on the screen.



- 8 Press **◀◀ SKIP/◀** or **▶▶ SKIP/▶** to replace one image with another.
 - The same operation can be performed by pressing **◀◀ REV/▶▶ FWD**.
 - Press **♂ RETURN** if you wish to return to the selection screen.
- 9 To stop the still image display at any time, press **■ STOP**.

Playing back Slide Show

- 1 To play back Slide Show, in Step 8 of the "Displaying Still Images (JPEG files)", press **▶ PLAY** (Slide Show).
 - The still images inside the selected folder are played as a slide show.
- 2 To pause the playback at any time, press **|| PAUSE**.
 - Press **▶ PLAY** to return to playback of a slide show.
- 3 To stop the playback at any time, press **■ STOP**.

Setting slide show speed/repeat playback

- 1 Press **D** (Yellow) (Slide Show Menu) while the selection screen is displayed.
 - The setting screen for "Slide Show Speed"/"Repeat Mode Setting" appears.
- 2 Press **▲/▼** to select "Slide Show Speed", then press **▶** or **ENTER**.
 - The slide show speed may be selected from "Fast", "Normal", "Slow1" and "Slow2".
- 3 Press **▲/▼** to select the desired speed, then press **ENTER**.
- 4 Press **▲/▼** to select "Repeat Mode Setting", then press **▶** or **ENTER**.
- 5 Press **▲/▼** to select the desired item, then press **ENTER**.
 - The desired item may be selected from "Yes" or "No".
- 6 Press **EXIT** to exit.

Instantly Watching Movies from Netflix

Please check that the most current software is loaded on this system by selecting auto update on the system menu screen (See pages 75-78) or by visiting <http://www.sharpsusa.com/products/support/> to check for a download of the newest software version.

This function allows you to enjoy Netflix through the Internet.

Netflix is an online DVD and Blu-ray Disc rental service, offering rental-by mail and streaming instantly to Netflix unlimited members.

- To enjoy this function, make a broadband Internet connection to both your PC and this system (see page 32), and then set communication settings (see pages 71-73), then perform the following operation.
- Before using this function, please read "Network Service Disclaimer" (page 88).

NOTE

- Netflix is not available when a proxy server is used for an Internet connection. (See pages 71-72.)
- The streaming quality (SD or HD) depends on the network speed and original bit rate of the title.
- For more information on Netflix visit <http://www.netflix.com/help> or login to your Netflix account and click "Help" at the top of the page.
- Netflix is only available in the US.
- Illustrations are examples and may differ from the actual Netflix screens.

The buttons which can be used :

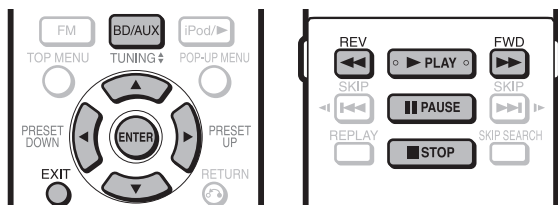

Settings for watching Netflix content on your TV

- Press **BD/AUX** repeatedly to select DISC function.
 - The same operation can be performed by pressing **SELECTOR** repeatedly on the main unit.
- Press **HOME** to display the menu screen.
 - The same operation can be performed by pressing **ENTER** after selecting the HOME icon on the Wall Paper screen.
- Press **▲/▼** to select "e-Contents", then press **▶** or **ENTER**.

The screen of this system shown on the TV



- Press **▲/▼** to select "Netflix", then press **▶** or **ENTER**.
- Read the Disclaimer displayed on the screen. If you agree, press **▲** on the last page to select "Agree", then press **ENTER**. (If you do not agree, this service cannot be used.)
- Obtain the Netflix activation code.

If you don't have a Netflix account

- Press **▲/▼** to select "no-start my FREE trial", then press **ENTER**.

The screen of this system shown on the TV

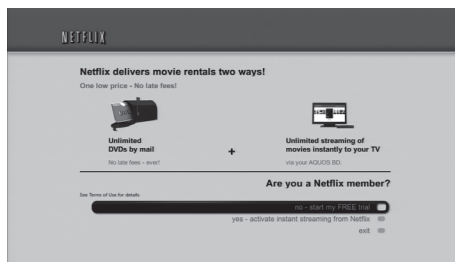

- Subscribe by visiting <http://www.netflix.com/sharp> from your PC.
- Press **▲/▼** to select "I'm now a member", then press **ENTER**.

The screen of this system shown on the TV

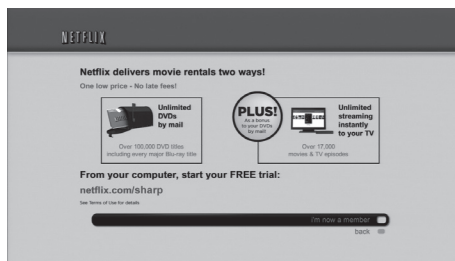

If you have a Netflix account

Press **▲/▼** to select "yes-activate instant streaming from Netflix", then press **ENTER**.

The screen of this system shown on the TV

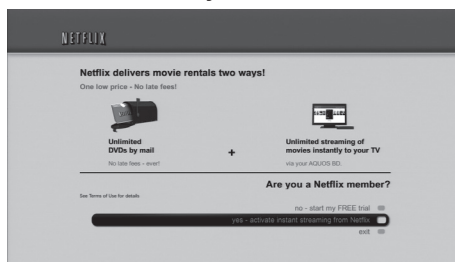

(Continued on the next page)

Video/Picture/Music Playback

- 7 You will see the following window.
- The activation code is displayed.

The screen of this system shown on the TV



- 8 Using your PC, visit <http://www.netflix.com/activate>, and then enter the activation code displayed in step 7.

The screen of the PC

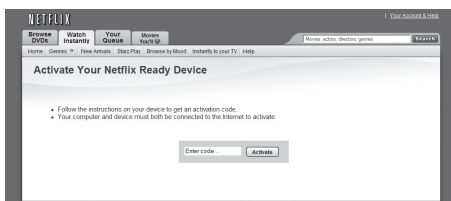

- After a period of time, the system will be activated, and the empty instant Queue screen will be displayed on your TV from the system.

Adding content to the Instant Queue

- 9 To add a movie to the instant Queue of this system, select the “Add to Instant” button on Netflix “Watch Instantly” web page using your PC.
- After a period of time, the instant Queue list registered using your PC will appear on your TV screen.

Playing back content in the Instant Queue on your TV

- 10 Press **◀▶** to select the desired movie, then press **ENTER**.
- Once this function is set and the registration is completed, the next time this service is used instant Queue list screens such as the following can be displayed directly by pressing **ENTER** after selecting the NETFLIX icon on the Wall Paper screen.

The screen of this system shown on the TV

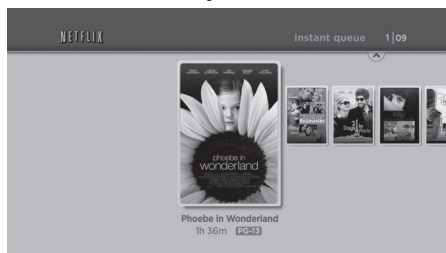

- 11 The title you selected is displayed.
- To return to the step 10, press **▲**.
 - Press **▲/▼** to select “play”, then press **ENTER** or **▶ PLAY** to start playback.

The screen of this system shown on the TV

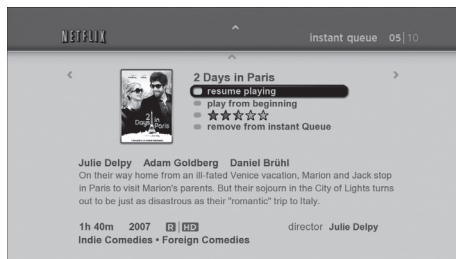

The screen of this system shown on the TV

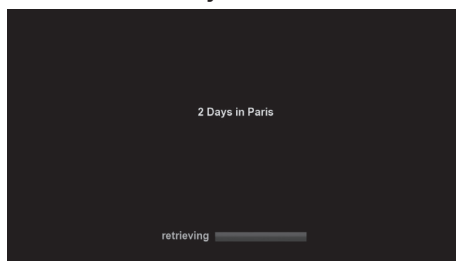

- After a period of time, playback of the movie begins.
- 12 To pause the playback at any time, press **|| PAUSE**.
- Press **|| PAUSE** or **▶ PLAY** to return to playback.
- 13 To stop the playback or go to step 11, press **▲** or **■ STOP**.
- 14 Press **EXIT** to exit.

Fast Forward/Reverse

The Fast Forward/Reverse function is enabled when **◀◀ REV** or **▶▶ FWD** is pressed during playback.

Playback Functions

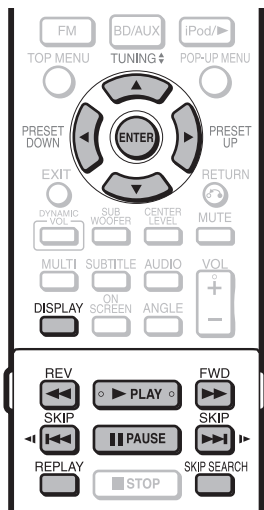

Buttons under the cover



NOTE

- Some operations in the following playback functions cannot be performed depending on the specifications of the disc.

Fast Forward/Reverse (Search)

- BD VIDEO | BD-R | BD-RE
- DVD VIDEO | DVD-R | DVD-RW
- AUDIO CD

The Fast Forward/Reverse function is enabled when **◀◀ REV** or **▶▶ FWD** is pressed during playback.

Example: When **▶▶ FWD** is pressed

- The search speed will change each time you press the button.

When playing back a DVD

- You cannot perform Fast Forward/Fast Reverse from one title and continue to another title (except when playing audio CDs). At the end or beginning of the title, Fast Forward/Fast Reverse will be cancelled and normal playback will automatically resume.

NOTE

- Subtitles are not played back with BD/DVD video discs during Fast Forward and Fast Reverse.

Skipping to the Next or the Start of the Current Chapter (Track/Title)

- BD VIDEO | BD-R | BD-RE
- DVD VIDEO | DVD-R | DVD-RW
- AUDIO CD | CD-R | CD-RW | USB

The Skipping (to the beginning of a chapter, track or title) function is enabled when **◀◀ SKIP/◀** or **▶▶ SKIP/▶** is pressed during playback.

Pause/Frame Advance Playback

- BD VIDEO | BD-R | BD-RE
- DVD VIDEO | DVD-R | DVD-RW

The Pause function is enabled when **|| PAUSE** is pressed during playback. (If you are playing back an audio CD, audio data [MP3 files] or still images [JPEG files], these will also pause.)

The Frame Advance Playback function is enabled when **▶▶ SKIP/▶** is pressed during pause.

- Frame Advance Playback may not function properly with discs other than DVD-RW/R (VR format).

NOTE

- Some BD/DVD Video discs are not compatible with Pause/Frame Advance Playback.
- Frame Advance/Reverse Playback can be performed for DVD discs by pressing **▶▶ SKIP/▶** or **◀◀ SKIP/◀** during pause.

Slow Playback

- BD VIDEO | BD-R | BD-RE
- DVD VIDEO | DVD-R | DVD-RW

The Slow Playback function is enabled when **▶▶ SKIP/◀** or **◀◀ SKIP/▶** is pressed for more than 2 seconds during pause.

- Press **▶ PLAY** to return to normal playback.

NOTE

- This doesn't work for audio CDs.
- Reverse Slow Playback cannot be performed for BD video and DVD discs in AVCHD format.
- You cannot perform Slow Playback between titles. At the end of the title, Slow Playback will be cancelled and normal playback will automatically resume.

Skip Search

- BD VIDEO | BD-R | BD-RE
- DVD VIDEO | DVD-R | DVD-RW

Playback skips 30 seconds ahead when **SKIP SEARCH** is pressed during playback.

Replay

- BD VIDEO | BD-R | BD-RE
- DVD VIDEO | DVD-R | DVD-RW

Playback jumps back 10 seconds when **REPLAY** is pressed during playback.

(Continued on the next page)

Playback Functions

Repeat Playback of a Title or Chapter (Repeat Playback)

BD VIDEO | BD-R | BD-RE
DVD VIDEO | DVD-R | DVD-RW
AUDIO CD

- 1 Play back the title or chapter you want to repeat.
- 2 Press **REPEAT**.
- 3 Press **▲/▼** to select the type of Repeat Playback.

- Playback Title: Repeats the title currently being played back.
- Playback Chapter: Repeats the chapter currently being played back.
- Scene Selection: Repeats the specified scene of title or chapter.

Playback Title
Playback Chapter
Scene Selection

- Press **RETURN** to cancel without setting the type of Repeat Playback.
- For Audio CD, you can select "Playing Disc", "Playing Track" and "Specify The Part" as Repeat Playback options.

- 4 Press **ENTER**.
Example: Repeat playback of a title (TITLE)

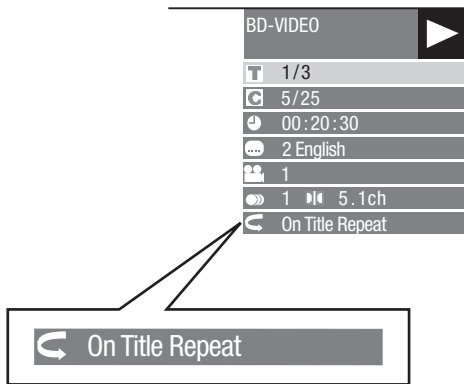

- "↶" indicator lights on the front panel display.

- 5 Press **REPEAT** to return to normal playback.

NOTE
• "Scene Selection" operation is not available for BD video.

Partial Repeat Playback (Repeat Playback of a Specified Part)

DVD VIDEO | DVD-R | DVD-RW
AUDIO CD

- 1 Press **REPEAT** during playback.
- 2 Press **▲/▼** to select "Scene Selection", then press **ENTER**.

- "Set Start Point" displays.

Playback Title
Playback Chapter
Scene Selection | Set Start Point

- 3 Press **ENTER** at the scene where you want to set the start point.

- "Set End Point" displays.

- 4 Press **ENTER** at the scene where you want to set the end point.

- "A1↔B" indicator lights on the front panel display.
- You can press **FWD** to fast forward to the scene where you want to set the end point. When you reach the desired scene, simply press **PLAY** and then **ENTER** to set the end point. To cancel Repeat Playback, press **REPEAT**.

NOTE

- Press **SKIP/▶**, the Repeat Playback is cancelled and the next chapter being play back.
- Press **SKIP/◀** once, the Repeat Playback is cancelled and the system returns to the start of current chapter (track).
- If you press **SKIP/◀** again (within about 5 seconds) the system will skip to the beginning of the previous chapter (track).
- For Partial Repeat Playback, set the start and end points within the same title.
- Repeat Playback may be forbidden depending on the disc.
- Partial Repeat Playback may not work in multi-angle scenes.
- If you press **DISPLAY**, you can confirm the Repeat Playback status.

Playback Functions

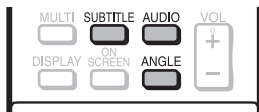

NOTE

- Some operations in the following playback function cannot be performed depending on the specifications of the disc.

Displaying the Audio Information

You can display the audio information on the disc currently being played back by pressing **AUDIO**.

- The displayed contents vary depending on the disc.

BD VIDEO **DVD VIDEO**

The audio channel currently being played back will be displayed.

If multiple audio channels are recorded, you can switch the audio channel by pressing **AUDIO**.

DVD-RW **DVD-R**

When a recorded broadcast with stereo or monaural audio is played back:

“Stereo” is displayed. (Audio cannot be switched.)

NOTE

- Setting for audio can be changed in Function Control screen. (Page 58)
- The operation of audio differs according to each disc. You may need to refer to the operation manual of the disc.
- The display for audio automatically disappears after 5 seconds.

Switching Subtitles

BD VIDEO **DVD VIDEO**

If subtitles are provided in multiple languages, you can switch between them.

Press **SUBTITLE** during playback.

- The display indicates the subtitle number currently being played back, and the subtitles appear.
- Each time **SUBTITLE** is pressed, the subtitles change.
- “–” is displayed if a disc has no subtitles.
- You can also select “Off”.

NOTE

- Setting for subtitle can be changed in Function Control screen. (Page 58)
- The operation of subtitles differs according to each disc. You may need to refer to the operation manual of the disc.
- The display for subtitles automatically disappears after 5 seconds.

Switching the Angle

BD VIDEO **DVD VIDEO**

If multiple angles are recorded, you can switch between them.

Press **ANGLE** during playback.

- The display indicates the angle number currently being played back. Each time you press **ANGLE**, the angle switches.
- “–” is displayed if a disc is recorded with only one angle.



To return to the previous angle, press **ANGLE** to cycle through the angles until you return to the original angle.

NOTE

- The displayed items vary depending on the disc.
- The operation of angle differs according to each disc. You may need to refer to the operation manual of the disc.
- The display for audio automatically disappears after 5 seconds.

Displaying the Angle Mark

BD VIDEO **DVD VIDEO**

You can change settings so that Angle Mark appears in the right bottom part of the screen when multiple angles are recorded. The settings can be changed in “Settings” - “Playback Setting” - “Angle Mark Display”. (Page 70)

Settings During Playback

Function Control

BD VIDEO | BD-R | BD-RE

DVD VIDEO | DVD-R | DVD-RW

AUDIO CD

This allows you to adjust various settings at once, like subtitles, angle settings and the title selection for Direct Playback. You can adjust the video and audio to suit your preferences. The operations are the same for BD and DVD.

Function Control screen

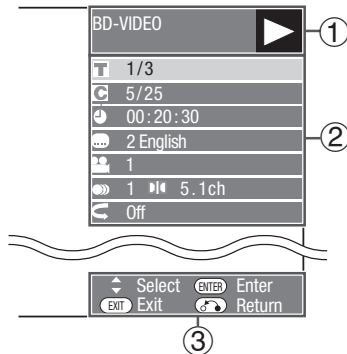

① Playback status display

Shows the operation status and the disc type.

② Setting items

Selects a title (or track) or chapter for playback, or performs video/audio settings.

- Title/Track Number (Direct Title/Track Skip)
- Chapter Number (Direct Chapter Skip)
- Playback Elapsed Time (Direct Time Skip)
- Subtitle Language
- Angle Number
- Audio
- Repeat

③ Operation guide display

Provides help on remote control button operations.

Function Control operation procedure

Buttons under the cover

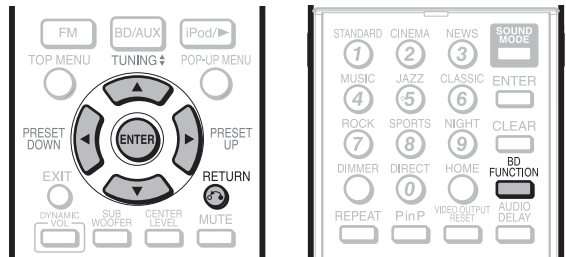

- 1 Press **BD FUNCTION** during playback.
 - The Function Control screen is displayed on the TV.
- 2 Press **▲/▼** to select the desired setting, then press **ENTER**.
 - For a description of each setting, see "Functions which can be set". (Page 59)

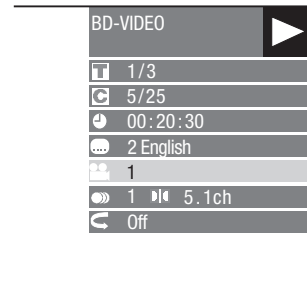

- 3 Press **▲/▼/◀/▶** to set, then press **ENTER**.
 - Operations vary depending on the setting. Follow the operation instructions on the screen.
- 4 Press **RETURN** or **BD FUNCTION** to close the Function Control screen.

NOTE

- If "—" is displayed for an option like title number or subtitles, the disc has no titles or subtitles which can be selected.
- The displayed items vary depending on the disc.
- If you access the Function Control screen during playback of a BD/DVD video, it may be impossible to operate the BD/DVD video playback. In cases like this, close the Function Control screen.

Settings During Playback

Functions which can be set

T Title/Track Number (Direct Title/Track Skip)

- Shows the title number being played back (or track number when playing back an audio CD). You can skip to the start of the title (or track).
- To skip to the start of a selected title (or track), press the **Number** buttons to enter the title (or track) number when this option is highlighted.

C Chapter Number (Direct Chapter Skip)

- Shows the chapter number being played back. You can skip to the start of the chapter.
- To skip to the start of a selected chapter, press the **Number** buttons to enter the chapter number when this option is highlighted.

⌚ Playback Elapsed Time (Direct Time Skip)

- Shows the time elapsed from the beginning of the current disc title (or track). This lets you skip to a specific time.
- Press **◀/▶** to select the Hour, Minute or Second, then press **▲/▼** or the **Number** buttons to set the time. Press **ENTER** to start playback at the set time.

📄 NOTE

- **ENTER** button under the Cover: Enter the input number.
- **CLEAR** button under the Cover: Clears the input number.

🗨️ Subtitle Language

- Shows the currently selected subtitle language. If subtitles are provided in other languages, you can switch to your preferred language.

👤 Angle Number

- Shows the currently selected angle number. If the video is recorded with multiple angles, you can switch the angle.

🔊 Audio

- Shows the currently selected type of audio. You can select the desired type of audio.

↺ Repeat

- The current Title (or Chapter) or partial segments can be repeatedly played back. Repeat Playback is also possible with the **REPEAT** button on the remote control.

📄 NOTE

- These functions may not work with all discs.

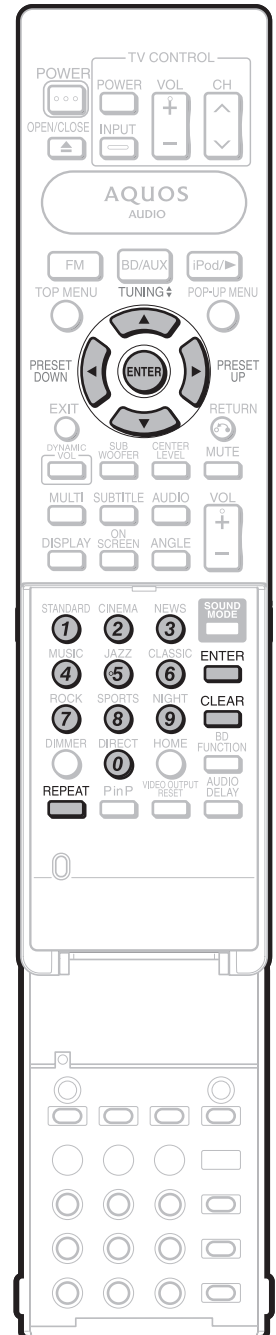

Listening to the iPod

Supported iPod

- This system is compatible with the following iPod models.

- iPod nano (software 1.2 above)
- iPod mini (software 1.2 above)
- iPod (5th generation) (software 1.3 above)
- iPod (4th generation) (software 3.0.2 above)
- iPod nano (2nd generation) (software 1.0.0 above)
- iPod nano (3rd generation) (software 1.0.3 above)
- iPod nano (4th generation) (software 1.0.3 above)
- iPod classic (software 1.0.3 above)
- iPod touch (software 1.1 above)
- iPod touch (2nd generation) (software 2.1 above)

NOTE

- Please update your iPod unit to the latest software version before using it. Please visit Apple's homepage to download the latest version for your iPod.
- Unplug all accessories for the iPod before connected to the main unit.
- Once connected to the main unit, the iPod will begin the charging.
The iPod unit cannot be charged while the main unit is in the stand-by mode.

System on operation

When the main unit is powered on, the iPod unit will automatically power on when connected to the unit.

* Invalid for 3rd iPod Generation.

System off (stand-by operation)

When the main unit is turned to stand-by mode, the iPod unit will automatically turn to stand-by mode.

Connecting the iPod

See page 30 to connect the iPod cable to the main unit.

How to connect the iPod cable

Insert the connector into the terminal of the iPod.

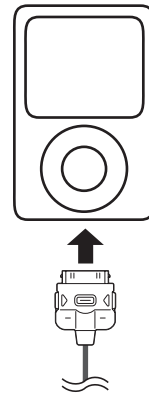

How to disconnect the iPod cable

- ① Push both sides (indicated by the arrows shown below) of the connector.
- ② Pull out the connector from the terminal of the iPod.

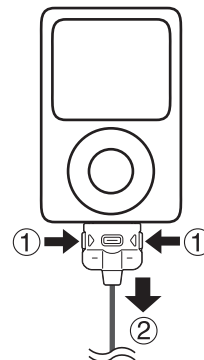

Listening to the iPod

iPod Playback

Main unit operation:



SELECTOR — (PLAY)
 || (PAUSE)

- 1 Press **SELECTOR** on the main unit repeatedly to select iPod function.
 - The iPod turns on and enters pause mode.
- 2 Press **▶ (PLAY)** on the main unit to start playback.
- 3 Press **|| (PAUSE)** on the main unit to enter pause mode.

Remote control operation:

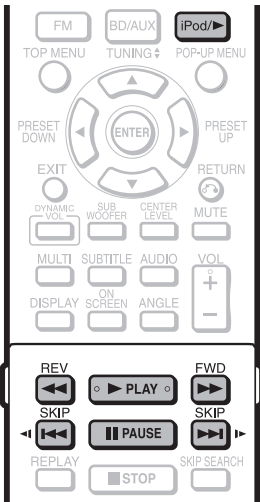

Buttons under the cover



- 1 Press **iPod/▶** on the remote control to select iPod function.
 - The iPod turns on and playback begins automatically.
- 2 Press **|| PAUSE** on the remote control to enter pause mode.

Various iPod functions

Function	Main unit	Remote control	Operation
Play			Press in the pause mode.
Pause			Press in the playback mode.
Track up/down	—		Press in the playback or pause mode. If you press the button in the pause mode, press the ▶ button to start the desired track.
Fast forward/reverse	—		Press and hold down in the playback mode. Release the button to resume playback.
Repeat	—		Press to toggle repeat mode.
Shuffle	—		Press and hold down to toggle shuffle mode.

NOTE

- Stop button (■) is invalid during iPod function.

Listening to the FM Broadcast

Buttons under the cover

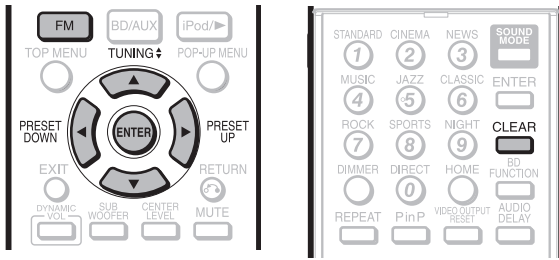

Tuning

- 1 Press **SELECTOR** on the main unit or **FM** on the remote control as many times as required to select the desired band.
 - Each time **FM** is pressed, the setting changes between "FM STEREO" and "FM MONO".
- 2 Press **TUNING** ▲/▼ to tune in to the desired station.

Manual tuning

Press **TUNING** ▲/▼ as many times as required to tune in to the desired station.

Auto tuning

When **TUNING** ▲/▼ is pressed for more than 0.5 seconds, scanning will start automatically and the tuner will stop at the first receivable broadcast station.

NOTE

- When FM broadcast interference occurs, auto scan tuning may stop automatically at that point.
- Auto scan tuning will skip stations with a weak signal.
- To cancel auto tuning, press **TUNING** ▲/▼ again or press **ENTER**.

Receiving Stereo FM Broadcasts

Press **FM** to select stereo mode. The "STEREO" indicator will be displayed.

- "◉" will appear when an FM broadcast is in stereo.
- If FM reception is weak, press **FM** to turn off the "STEREO" indicator.

The reception changes to monaural, and the sound becomes clearer.



Presetting a Station

You can preset up to 20 FM stations and recall them by pressing **PRESET** ◀▶.

- 1 Perform Steps 1 to 2 in "Tuning" on the left.
- 2 Press **ENTER** to enter the channel presetting mode.

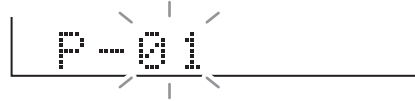

- 3 Within 3 seconds, press **PRESET** ◀▶ to select the preset channel number.
 - Preset the stations, in order, starting with preset channel 1.
- 4 Within 3 seconds, press **ENTER** to preset that station.

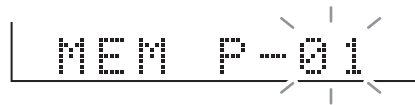

- If the preset number indicators disappear before the station is preset, repeat the operation from Step 2.
- When a new station is stored in memory, the station previously memorized for that preset channel number will be erased.

NOTE

- If the AC power cord is unplugged or a power failure lasts for more than two or three hours, the preset station settings will be lost. If this happens, preset the stations again.

Recalling a preset station

Press **PRESET** ◀▶ to select the desired preset station.

Clearing all preset stations

Press **CLEAR** for more than three seconds until "CLEAR" appears.

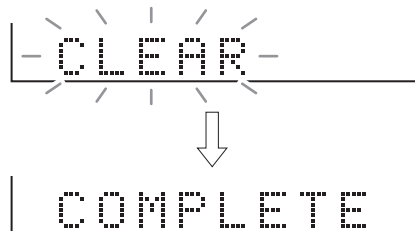

Audio Settings and Operations

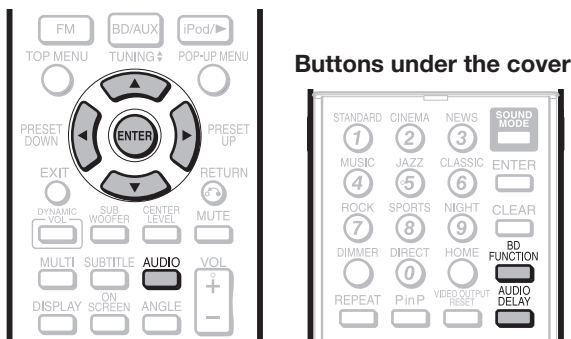

Various Audio Settings

Changing the audio setting

You can switch between main audio and sub audio for dual mono input or when playing back a dual mono disc.

- Press **AUDIO**.
- Pressing **AUDIO** changes the mode as follows.

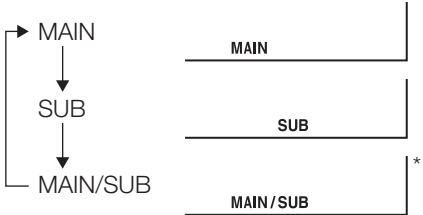

* MAIN/SUB outputs the main audio and sub audio from different speakers.

Audio Setting Display

- Pressing **BD FUNCTION** during playback displays the playback setting screen.
- The current playback audio format and number of channels are displayed.

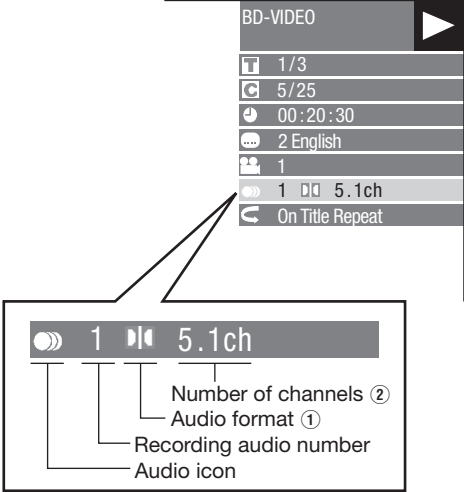

① Audio format

The current playback audio format is displayed. (LPCM, Dolby Digital, DTS, etc.)

② Number of channels

The number of current playback channels is displayed. (Mono, Stereo, 5.1 channels, etc.)

Audio delay setting

If the playback image on the TV is not synched with the audio output from the system when playing back a Blu-Ray disc or DVD, you can delay the output of the audio from the system for better synched audio and video.

- Press **AUDIO DELAY**.
 - The current mode (setting) is displayed. By default, AUTO (DL AUTO) is selected.

When the system is connected to future AQUOS LINK-compatible TV models using an HDMI cable, you can press **AUDIO DELAY** and select DL AUTO to automatically select the optimal audio delay.

- Press **▲/▼** within 3 seconds to adjust the delay.

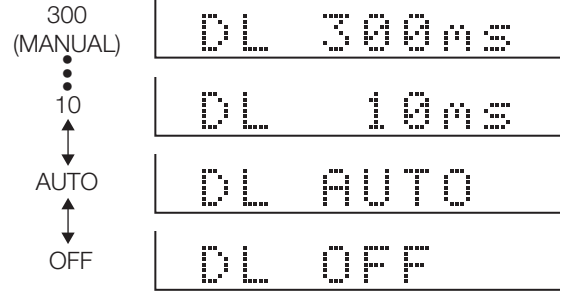

- MANUAL setting can be used to manually set the audio delay from 10 milliseconds to 300 milliseconds in 10 millisecond increments.

Enjoying Video and Audio Playback

Enjoying Multi-Channel Mode

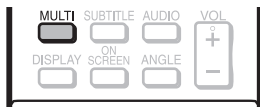

When playing back Dolby Digital, DTS or other multi-channel audio signals, the system automatically selects the optimal decoder for the signal format and plays back the multi-channel audio signal.

This system is equipped with Dolby Pro Logic II. The Dolby Pro Logic function converts 2-channel sound to 5.1-channel surround sound for more a natural sound experience.

Press **MULTI** to change the multi-channel mode. Pressing **MULTI** changes the mode as follows.

MULTI ON ↔ MULTI OFF

MULTI ON: Plays back sound in 5.1-channel surround sound for a more realistic sound experience.

- When MULTI ON is selected, "MULTI ON" is displayed for 3 seconds on the front panel display.

A diagram of a front panel display showing the text "MULTI ON" in a large, spaced-out font.

- When Dolby Pro Logic II operates, the **PL II** indicator lights.

MULTI OFF: Plays back original channel sound.

- When MULTI OFF is selected, "MULTI OFF" is displayed for 3 seconds on the front panel display.

A diagram of a front panel display showing the text "MULTI OFF" in a large, spaced-out font.

Playing back a two-channel audio source

Stereo sound is played back from the Sound bar speaker (left/right).

Sound is also played back from the subwoofer.

NOTE

- With 5.1ch input, the sound cannot be played back in stereo sound.
With 7.1ch input, the playback sound will be down-mixed to 5.1ch in both "MULTI ON" and "MULTI OFF".

Audyssey Technology

Audyssey EQ®

Audyssey EQ is based on the same core technology as Audyssey MultEQ that is used for automatic correction of room acoustics. Audyssey EQ uses time-domain filters to correct problems that arise from speaker drivers and enclosures and is calibrated to account for the acoustical problems in a typical listening environment.

Audyssey Dynamic EQ®

Audyssey Dynamic EQ solves the problem of deteriorating sound quality as volume is decreased by taking into account human perception and room acoustics. Audyssey Dynamic EQ works in tandem with Audyssey EQ to provide well-balanced sound for every listener at any volume level.

Audyssey Dynamic Volume™

Audyssey Dynamic Volume solves the problem of large variations in volume level between television programs, commercials, and between the soft and loud passages of movies. Audyssey Dynamic EQ is integrated into Dynamic Volume so that as the playback volume is adjusted automatically, the perceived bass response, tonal balance, surround impression and dialog clarity remain the same.

Audyssey BassXT™

Audyssey BassXT enables low frequency drivers to produce deeper bass by intelligently monitoring incoming audio signals and extending driver performance to its maximum safe limits at all volume levels. This enables the system to produce lower frequencies than would be possible with a traditional system of the same size.

Enjoying a Surround Sound Effect (Sound Mode)

Buttons under the cover

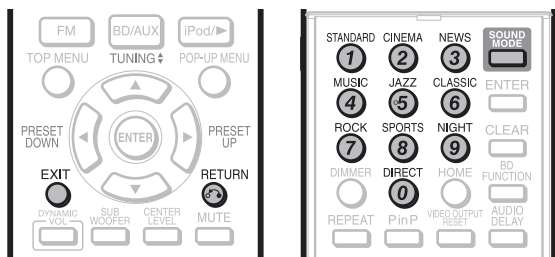

- The sound is interrupted momentarily when switching the sound mode.

Enjoying preset sound mode

Select any of the 10 sound modes preset to the optimal sound quality levels.

Select a desired sound mode by pressing one of the SOUND MODE buttons.

- Press **SOUND MODE** to enter the selection mode.
 - The current sound mode is displayed.
- Press the button of the desired sound mode within 3 seconds.
 - Pressing **RETURN** or **EXIT** on the remote control returns to the original display. If no buttons are operated within 3 seconds, the original display appears.

Selectable sound modes

SOUND MODE	Indication on display	Characteristics of each preset sound mode
STANDARD	STANDARD	Enjoy the standard quality sound.
CINEMA	CINEMA	Creates a strong low end and a dynamic, wide sound field. Appropriate for movie and similar sources.
NEWS	NEWS	Reduces the bass for clear sound that is easy to listen to regardless of the volume level. Appropriate for listening to the news.
MUSIC	MUSIC	Creates a natural, spacious sound. Appropriate for various kinds of music sources.
JAZZ	JAZZ	Slightly emphasizes both the low frequency and high frequency range, resulting in transparent sound. Appropriate for listening to jazz and similar music.
CLASSIC	CLASSIC	Slightly emphasizes the low frequency range, and creates an extended high end. Appropriate for listening to classical music.
ROCK	ROCK	Emphasizes both bass and treble, resulting in brisk and lively sound. Appropriate for listening to rock and pop music.
SPORTS	SPORTS	Creates the atmosphere you experience in a large space such as a sports stadium. Appropriate for sports broadcasting such as baseball or football games.
NIGHT	NIGHT	Dialog are easy to hear and loud sounds are controlled; even at low volume, you can enjoy a wide sound field like. Appropriate for listening to sounds of movies at low volume.
DIRECT	DIRECT	The original audio signal is played back without being filtered.

NOTE

- The DYNAMIC VOL, SUB WOOFER and CENTER LEVEL settings can be configured individually for each preset sound mode.
- When you select the "DIRECT" mode, no function of Audyssey works.

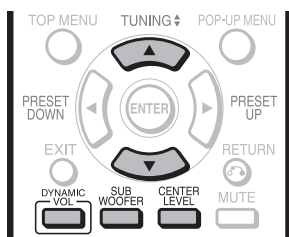

Dynamic Volume

You can adjust the Dynamic Volume level.

- 1 Press **DYNAMIC VOL** once.
 - The current Dynamic Volume level is displayed.
- 2 Press **▲/▼** within 3 seconds to adjust the desired mode as the below indicated.

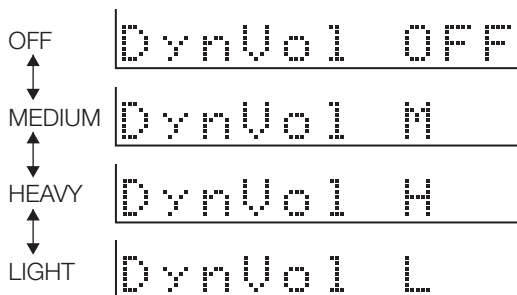

- The switched Dynamic Volume level is displayed on the TV screen for approximately 3 seconds.

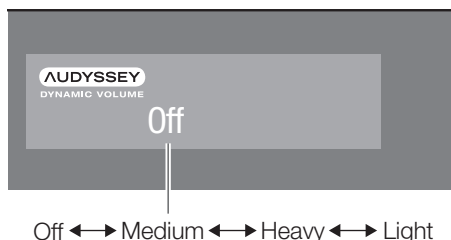

MEDIUM: Dynamic Volume is set to a moderate level. Recommended for listening to movies with volume variations.

HEAVY: Dynamic Volume is set to a heavier level. Recommended for late-night listening when high volume is not required. (When the sound mode is set to “NIGHT”, the Dynamic Volume level is set to “HEAVY” automatically.)

LIGHT: Dynamic Volume is set to a lighter level.

NOTE

- When the “Dynamic Range Control” function (page 69) is effective in DISC function, the “Dynamic Volume” function is ineffective.

Dynamic EQ

You can adjust the Dynamic EQ offset level.

- 1 Press **DYNAMIC VOL** twice continuously.
 - The current Dynamic EQ offset level is displayed.
- 2 Press **▲/▼** within 3 seconds to adjust the desired offset as the below indicated.

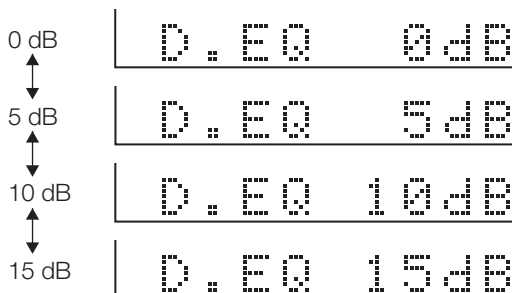

0 dB (Film Ref): This is the default setting and should be used when listening to movies.

5 dB: Select this setting for content that has a very wide dynamic range, such as classical music.

10 dB: Select this setting for jazz or other music that has a wider dynamic range. This setting should also be selected for TV content as that is usually mixed at 10 dB below film reference.

15 dB: Select this setting for pop/rock music or other program material that is mixed at very high listening levels and has a compressed dynamic range.

Fine-tuning the subwoofer level

The subwoofer level can be adjusted.

- 1 Press **SUB WOOFER**.
 - The current subwoofer level is displayed on the front display panel.



- 2 Press **▲/▼** within 3 seconds to adjust the desired level.
 - Adjust the level from -5 to +5.

Fine-tuning the center speaker level

The center speaker level can be adjusted.

- 1 Press **CENTER LEVEL**.
 - The current center speaker level is displayed on the front display panel.



- 2 Press **▲/▼** within 3 seconds to adjust the desired level.
 - Adjust the level from -5 to +5.

SETTINGS

Common operations

The “menu” enables various audio/visual settings and adjustments on the functions using the remote control. You need to call up the On Screen Display to perform settings for this system. The following is the explanation for the basic operations of the “menu”.

Example: Setting “AQUOS LINK”

1 Display the menu screen

Press **BD/AUX** repeatedly to select DISC function.

- The same operation can be performed by pressing **SELECTOR** repeatedly on the main unit.

Press **HOME** to display the menu screen.

- The same operation can be performed by pressing **ENTER** after selecting the HOME icon on the Wall paper screen.

Press $\blacktriangle/\blacktriangledown$ to select “Settings”, then press \blacktriangleright or **ENTER**.

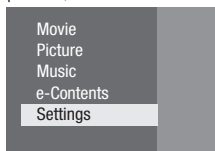

2 Select the next item

Press $\blacktriangle/\blacktriangledown$ to select “AQUOS LINK”, then press \blacktriangleright or **ENTER**.

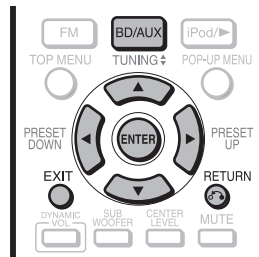
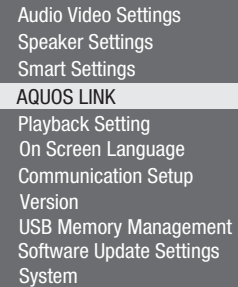

Buttons under the cover



3 Select a menu item

Press $\blacktriangle/\blacktriangledown$ to select the desired item, then press \blacktriangleright or **ENTER**.

Press \curvearrowright **RETURN** to return to the previous “menu” page.

4 Exit the menu screen

Press **HOME** or **EXIT** to exit.

Basic Operation for Playback Setting

Example: Setting “Parental Control” under “Playback Setting”

- Press **BD/AUX** repeatedly to select DISC function.
 - The same operation can be performed by pressing **SELECTOR** repeatedly on the main unit.
- Press **HOME** to display the menu screen.
 - The same operation can be performed by pressing **ENTER** after selecting the HOME icon on the Wall paper screen.
- Press $\blacktriangle/\blacktriangledown$ to select “Settings”, then press \blacktriangleright or **ENTER**.
- Press $\blacktriangle/\blacktriangledown$ to select “Playback Setting”, then press \blacktriangleright or **ENTER**.
- Press $\blacktriangle/\blacktriangledown$ to select “Parental Control”, then press \blacktriangleright or **ENTER**.
 - When you operate this system for the first time, the password setting screen will be displayed. See “When setting the password for the first time” below.
- Enter your 4-digit password.
 - You cannot move to the next setting screen until you can input the correct password.

When setting the password for the first time.

- To set the password for the first time, press $\blacktriangle/\blacktriangledown$ to select “Yes” to enter the password setting menu, then press \blacktriangleright or **ENTER**.
- Enter a 4-digit number for the password, then the same 4-digit number for confirmation.
- Press **ENTER** to complete the password setting procedure and move to the next setting screen.
- Press $\blacktriangle/\blacktriangledown$ to select the parental control level for DVD VIDEO, BD-ROM, and then select the country code. Press **ENTER** after making each selection.

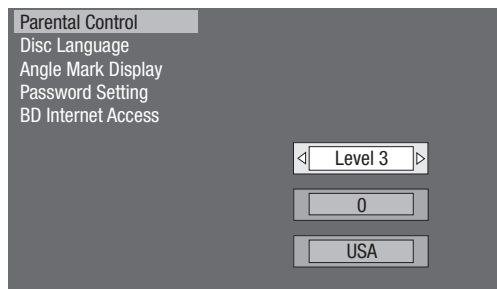

- Press **HOME** or **EXIT** to exit.

SETTINGS

Audio Video Settings

TV Aspect Ratio

You can set the screen aspect ratio of the connected TV, and adjust the video output. If you switch your TV (i.e. because you have bought a new one) and the screen aspect ratio of the connected TV changes, you will have to change the "TV Aspect Ratio" setting.

Item

Wide 16:9: Select this when connecting to a TV with a 16:9 screen aspect ratio.
Normal 4:3: Select this when connecting to a TV with a 4:3 screen aspect ratio.

<When selecting Normal 4:3>

Item

Letter Box: If you connect to a TV with a screen aspect ratio of 4:3 and playback a DVD with 16:9 video, the video will be played back with black bands at the top and bottom while maintaining the 16:9 ratio.
Pan Scan: If you connect to a TV with a screen aspect ratio of 4:3 and playback a DVD with 16:9 video, the video will be played back with the left and right sides of the image cut off to display in 4:3 screen aspect ratio. (This function works if the disc is labelled for 4:3PS.)

Component Video Out

This sets the resolution of the component video output. Some TVs are not fully compatible with the system, which may cause the image distortion. In this case, press **VIDEO OUTPUT RESET** on the remote control for five seconds. "Component Video Out" will be reset to "480i" (factory preset value).

Item

1080i, 720p, 480p, 480i

HDMI Video Out

This sets the resolution of the HDMI video output. Some TVs are not fully compatible with the system, which may cause the image distortion. In this case, press **VIDEO OUTPUT RESET** on the remote control for five seconds. "HDMI Video Out" will be reset to "Auto" (factory preset value).

Item

Auto, 1080p, 1080i, 720p, 480p

NOTE

- When the system is connected to a 1080p 24Hz compatible TV and the "HDMI Video Out" is set to "Auto", 1080p 24Hz will automatically be displayed when compatible discs are played back. At 1080p 24Hz/1080p 60Hz, there is no output from the COMPONENT VIDEO OUT jacks and VIDEO output jack.

Video Out Select

Dual video output is possible simultaneously from the COMPONENT VIDEO OUT jacks and the HDMI OUT terminal with the following settings. Select the video output which you want to have priority according to the following chart.

NOTE

- 1080p and AQUOS LINK are only available in HDMI.

Video Out Select	Dual Output	HDMI Video Out	Component Out Resolution in Dual Mode
HDMI	No	Auto	*1
	No	1080p	No
	Yes	1080i	1080i
	Yes	720p	720p
	Yes	480p	480p
Component	Dual Output	Component Video Out	HDMI Out Resolution in Dual Mode
	Yes	1080i	1080i
	Yes	720p	720p
	Yes	480p	480p
	Yes	480i	480i

*1 Depends on source. 1080p is not available.

Item

HDMI, Component

- When the priority video output is selected, video is output from the other video terminal with the resolution of the selected video output.
- There is no output from the COMPONENT VIDEO OUT jacks and VIDEO output jack when video is output at 1080p resolution and the priority video output is selected to "HDMI".
- If the video equipment connected to each of the terminals is not compatible with the resolution of the priority video output, abnormalities in images on the screen may appear.

Secondary Audio

This toggles the clicking sound on the menu and audio with secondary video in picture in picture mode for BD-Video.

- Select "Off" when enjoying the high quality sounds of BD-Video.

Item

On, Off

SETTINGS

Dynamic Range Control

This lets you adjust the range between the loudest and softest sounds (dynamic range) for playback at average volume. Use this when it is hard to hear dialog.

Item

Normal: The same audio output range is played as the original recorded audio output range.

Shift*: When Dolby Digital audio is played back, the dynamic range of the audio is adjusted so that the dialog portion can be heard easily. (If the audio sounds abnormal, set to "Normal".)

Auto: When you play back audio in the Dolby TrueHD format, the dynamic range is automatically adjusted.

* Lower the audio volume before setting. If you do not do so, the speakers may emit a loud sound or excessive output may be applied to the speakers.

NOTE

- If you change the "Dynamic Range Control" function to be effective, an effective "Dynamic Volume" function (page 66) becomes ineffective.

Speaker Settings

This lets you configure the speakers according to your surround sound environment.

See pages 39-40 for how to configure the speakers.

You cannot configure the speakers when a disc is loaded.

Remove the disc before configuring the speakers.

Smart Settings

Quick Start

This turns the Quick Start function on and off.

When the Quick Start function is on:

- The startup time of the system is reduced.
- However, power consumption will increase.

When the Quick Start function is off:

- The system will enter the low power consumption mode when in standby condition.

Item

Yes, No

NOTE

- When "Quick Start" is set to "Yes", the system requires some time to turn off.

Control Panel

This lets you set display of control panel on the TV screen on or off.

Item

Yes, No

AQUOS LINK

This lets you set the system to receive the control signal from the AQUOS LINK remote control via the HDMI cable.

Item

Yes, No

NOTE

- For details, refer to the operation manual of TV.
- If "Component" is selected from the "Video Out Select" menu, AQUOS LINK is not available. Select "HDMI" if you want to use AQUOS LINK features.

SETTINGS

Playback Setting

Parental Control

This lets you set the Parental Control depending on the disc content. The available Parental Control Levels are shown below.

The 4-digit password number needs to be entered before the Parental Control Levels and the Country Code are set. The Parental Control Levels and the Country Code cannot be set if a password has not been created or the password is not entered.

Item (For DVD-VIDEO)

8 and Off: All DVD-video can be played.
1-7: Prohibits play of DVD-video with corresponding ratings recorded on them.

Item (For BD-ROM)

No Limit: All BD-video can be played.
0-99 year(s): Prohibits play of BD-video with corresponding ratings recorded on them.

Item (Country code)

Sets the country code. Refer to the Country Code List (page 79) because the ratings differ according to the country.

NOTE

- Refer to "Basic Operation for Playback Setting" on page 67 for details.

Disc Language (Disc Priority Language)

This lets you select the language for subtitles, audio and menus displayed on the screen.

Item (Subtitle)

Refer to the Language List. (Page 79)

Item (Audio)

Refer to the Language List. (Page 79)

Item (Menu)

Refer to the Language List and Language Code List. (Page 79)

Angle Mark Display

This lets you turn the Angle Mark Display on or off when BD/DVD video recorded with multiple angles is played back. (The Angle Mark is displayed in the lower right screen.)

Item

Yes, No

Password Setting

This sets the password for setting or changing the Parental Control Level.

Item

Yes: Enter the 4-digit number.
No

NOTE

- When you forget the password, you can reset the current password using "System Reset" under "Settings". (See this page.)
- You can also set the new password if desired.

BD Internet Access

This allows you to set access restriction to BD-LIVE contents.

Item

Permit: Allows all BD-LIVE discs.
Limit: Allows only discs with owner certification.
Prohibit: Prohibits all BD-LIVE discs.

NOTE

- The available functions differ depending on the disc.
- Regarding playback method of BD-LIVE contents, etc., perform the operations in accordance with the instructions in the BD disc manual.
- To enjoy BD-LIVE functions, perform the broadband internet connection (page 32) and communication settings (pages 71-73).

On Screen Language

You can set the language you want to display on the screen.

Item

English, Español, Français

Version

When you select "Version", the system software version and Netflix ESN are displayed.

System

System Reset

You can reset all settings to the factory presets.

Item

Reset, Not Reset

Netflix Deactivate

You can deactivate your Netflix information on the system.

Item

Yes, No

Communication Setup

This allows you to perform and/or change the communication setting. This setting is required to use BD-LIVE functions, the RSS reader function, Netflix and software updates that connect to the Internet.

NOTE

- Make sure that the LAN cable is connected to this system. (See page 32.)
- For manually performing the setting, the following information of the connected router or modem is required. Confirm the information prior to the setting.
 - IP address, netmask, gateway, DNS address
- Besides, if specifying a proxy server, the following information specified from your Internet service provider is also required. Confirm the information prior to the setting.
 - IP address and port number of the proxy server
- Netflix is not available when a proxy server is used for an Internet connection. (See pages 53-54.)

Buttons under the cover

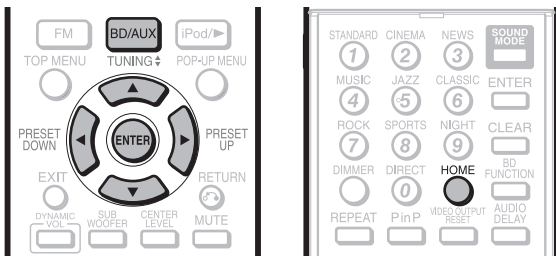

- 1 Press **BD/AUX** repeatedly to select **DISC** function.
 - The same operation can be performed by pressing **SELECTOR** repeatedly on the main unit.
- 2 Press **HOME** to display the menu screen.
- 3 Press **▲/▼** to select “Settings”, then press **▶** or **ENTER**.
- 4 Press **▲/▼** to select “Communication Setup”, then press **▶** or **ENTER**.
- 5 Press **ENTER**, then press **▲/▼** to select “Change”, then press **ENTER** again.

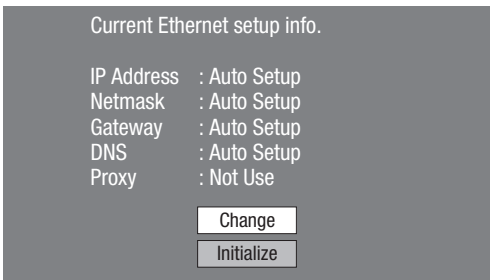

- For initializing the current setting, select “Initialize”, then press **ENTER**.

- 6 For setting the IP address, press **◀/▶** to select “Yes” or “No”, then press **ENTER**.

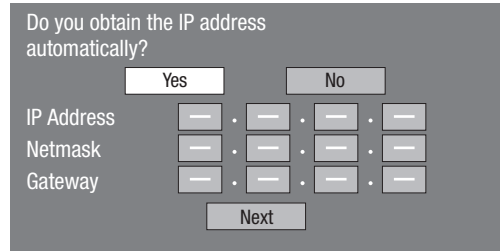

- If selecting “Yes”: The IP address is automatically obtained.
- If selecting “No”: The IP address, netmask and gateway are manually entered using the screen for inputting characters. (See page 73.) Regarding each of the setup values, confirm the specifications of your broadband router.

- 7 Select “Next”, then press **ENTER**.
 - If selecting “Yes” in the step 6, go to the step 10.
- 8 Enter your DNS address.



- The primary and secondary DNS addresses are entered using the screen for inputting characters. (See page 73.) Regarding each of the setup values, confirm the specifications of your broadband router.

- 9 Select “Next”, then press **ENTER**.
- 10 For setting the proxy server, press **◀/▶** to select “Yes” or “No”, then press **ENTER**.

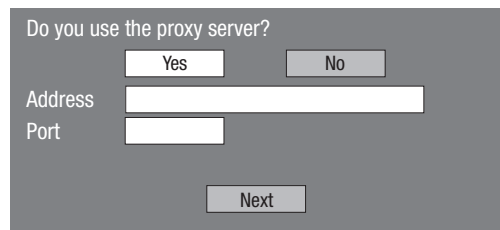

- If selecting “Yes”: The IP address or proxy server name and port number for the proxy server specified from your Internet service provider are entered using the screen for inputting characters. (See page 73.)
- If selecting “No”: Go to the next step.

- 11 Select “Next”, then press **ENTER**.

(Continued on the next page)

SETTINGS

12 For the advanced setting (the setting of the Ethernet connection speeds), press ▲/▼ to select “Yes” or “No”, then press **ENTER**.

- Normally select “No”, then press **ENTER**.
- The Ethernet connection speeds can be set when you select “Yes”, then press **ENTER**.
- As automatic detection is made (factory preset mode), this setting is not normally necessary. If a situation occurs in which the Ethernet connection fails, etc., change the setting and confirm if the Ethernet connection successfully works.
When the connection speed is set, select “Next”, then press **ENTER**.

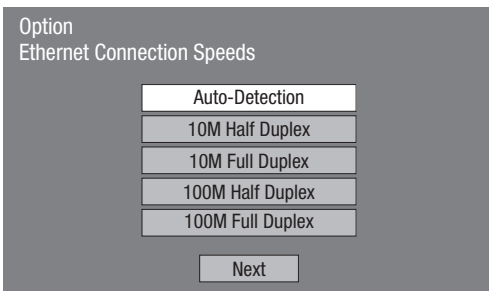

13 For testing the connection to the Internet, after confirming the settings, press ▲/▼ to select “Test”, then press **ENTER**.

- “Test” is available only when setting to obtain the IP address automatically. “Test” cannot be selected if the IP address has not been obtained automatically.

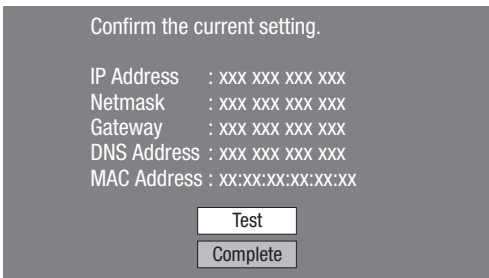

- As a result of the test, if the Internet connection fails, enter the setup values manually.

14 Press ▲/▼ to select “Complete”, then press **ENTER**.

SETTINGS

The operation procedure for inputting characters manually

NOTE

- Numeric characters such as IP address can be entered on the input screen either by selecting each of the characters in the "Numeric" mode or using the **Number** buttons on the remote control.

IP Address	123	.		.		.	
Netmask		.		.		.	
Gateway		.		.		.	

- Press **ENTER** at the boxes in which characters are to be entered, and the input screen will appear.

- Press **▲/▼** to select the desired input mode.
 - When inputting the address of the proxy server; "1ABC" (Alphabet/numeric character) / "Sign" / "Edit"
 - When inputting other values (IP address, etc.); "Numeric" / "Edit"

- Press **◀/▶** to select a number/character, then press **ENTER**.
- Repeat the step 3 to display all of the desired characters/numbers in the input field.

Example: The screen for inputting numeric characters

NOTE

- Press **RETURN** (Del.Char.) to delete a number/character you have input.
- To change a number/character you have input, press **B** (Green) (Left) or **C** (Blue) (Right) to select the number/character you want to change, and press **RETURN** (Del.Char.). Then, press **◀/▶** to select a new number/character you want to input, and press **ENTER**.

- Press **D** (Yellow) (Complete) to fix the numbers which have been input.

IP Address	123	.		.		.	
Netmask		.		.		.	
Gateway		.		.		.	

- Repeat step 1 to 5 to finish inputting all the required characters.

Input character list

1ABC (Alphabet/numeric character)	Num.	ABC	DEF	GHI	JKL	MNO	PQRS	TUV	WXYZ	Spc.
	Num.	1 2 3 4 5 6 7 8 9 0	ABC	A B C a b c	DEF	D E F d e f				
	GHI	G H I g h i	JKL	J K L j k l	MNO	M N O m n o				
	PQRS	P Q R S p q r s	TUV	T U V t u v	WXYZ	W X Y Z w x y z				
	Spc.	(space)								
Numeric	1 2 3 4 5 6 7 8 9 0									
Sign	@ . , : ; _ - \ \$ % ! ? & # + * = / ~ " ' ^ ` () < > [] { } Spc.									
	@ . , :	@ . , :	; _ - \	; _ - \	\$ % ! ?	\$ % ! ?				
	& # + *	& # + *	= / ~	= / ~	" ' ^ `	" ' ^ `				
	() < >	() < >	[] { }	[] { }	Spc.	(space)				
Edit	Cancel	Left	Right	Complete	Del.Char.					

* The same operation as the colored buttons and **RETURN** can be performed by selecting each of the items and pressing **ENTER**.
 "Del.Char." stands for deleting characters.

SETTINGS

Before using the USB memory device

CAUTION:

- Do not remove the USB memory device or unplug the AC cord while the operations for "USB Memory Management" or "Software Update (Manual Update from USB memory device)" are being performed.
- Do not use a USB extension cable when connecting a USB memory device to the USB1 or USB2 terminal on this system.
 - Using a USB extension cable may prevent the system from performing correctly.

NOTE:

- SHARP cannot guarantee that all brands' USB memory devices will operate with this system.
- Only USB memory devices formatted with FAT 32/16 are compatible.
When formatting a USB memory device using a PC, perform the following settings.
Format File System: FAT32
Allocation Unit Size: Default Allocation Size

USB Memory Management

The following instructions explain how to delete data such as the Virtual Package data and the BD-LIVE data in a USB memory device.

Buttons under the cover

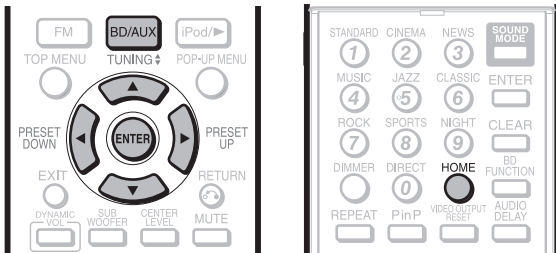

When you insert or remove a USB memory device, be sure to turn the main power off and make sure that "Quick Start" is set to "No" (See page 69).

- Insert the USB memory device into the USB1 or USB2 terminal on this system.
 - It is recommended that the USB memory device be connected to the USB1 terminal on the rear of the system.

NOTE

- A USB memory device can be used with either the USB1 or USB2 terminal. When two USB memory devices are connected to both terminals at the same time, in certain situations the USB1 terminal may give priority to Local Storage and Erase and Format cannot be used for the USB memory device connected to the USB2 terminal.

- Press **BD/AUX** repeatedly to select DISC function.
 - The same operation can be performed by pressing **SELECTOR** repeatedly on the main unit.
- Press **HOME** to display the menu screen.
- Press **▲/▼** to select "Settings", then press **▶** or **ENTER**.
- Press **▲/▼** to select "USB Memory Management", then press **▶** or **ENTER**.
 - "No USB Memory" appears when no USB memory is inserted.
- Press **▲/▼** to select "Erase" or "Format", then press **ENTER**.

Erase: Deletes only BD-VIDEO data written on the USB memory device such as BD-LIVE data.

Format: Be aware that all data including BD-VIDEO data and software update data will be deleted.

- If you want to delete only the unneeded software update data after the software is updated, delete the data on the USB memory device using a PC.



NOTE

- Data which has been saved to the system's internal memory (game score, etc.) will also be deleted.

- Press **▲/▼** to select "Yes", then press **ENTER**.
 - A confirmation message is displayed. Check that the correct USB memory device is displayed, and then continue.
- Start the process.
 - The screen for the current operation will display.

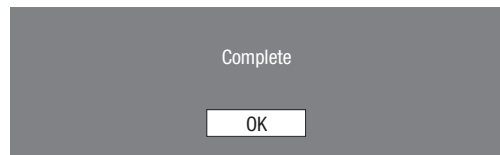

- Press **ENTER**.

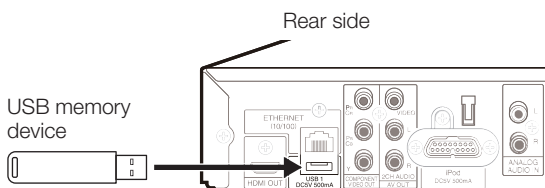

Software Update Settings

In this system, the software version can be updated using either one of the following methods.

- Auto Update from Network
- Manual Update from Network
- Manual Update from USB memory device

Auto Update from Network

This function allows you to perform the update by accessing an internet connection automatically to check if there is a new firmware version every time the system is turned on.

When using this function, it is required to perform the following settings in advance.

NOTE

- Make sure that the LAN cable is connected to this system. (See page 32.)
- Make sure to perform the communication settings. (See pages 71-73.)
- It may take time to access and download the update depending on the internet connection and other factors.

CAUTION

- Do not remove the LAN cable or unplug the AC cord while downloading or updating software.

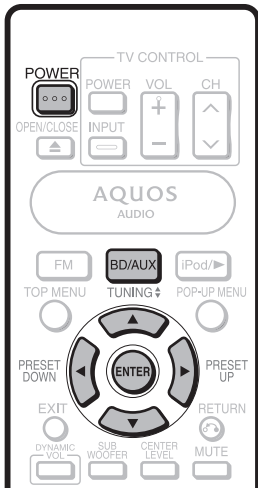

Buttons under the cover



Setup

- 1 Press **BD/AUX** repeatedly to select DISC function.
 - The same operation can be performed by pressing **SELECTOR** repeatedly on the main unit.
- 2 Press **HOME** to display the menu screen.
- 3 Press **▲/▼** to select “Settings”, then press **▶** or **ENTER**.
- 4 Press **▲/▼** to select “Software Update Settings”, then press **▶** or **ENTER**.
- 5 Press **▲/▼** to select “Auto Update Setting”, then press **▶** or **ENTER**.
- 6 Press **▲/▼** to select “Yes”, then press **ENTER**.
 - After this, an internet connection will be made automatically every time this system is turned on.

Update process

- 1 When this system is turned on, the internet connection starts automatically.

- “Accessing...” blinks on the screen.



- The current version of this unit software and the latest version of the update file on the network are displayed when latest version of firmware has been found. To update this system software with update file, select “Yes”, and go to step 2.

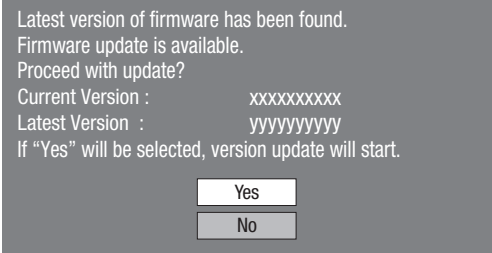

- If the latest firmware version has been already updated, nothing is displayed on the screen.

- 2 Press **ENTER** to start updating.

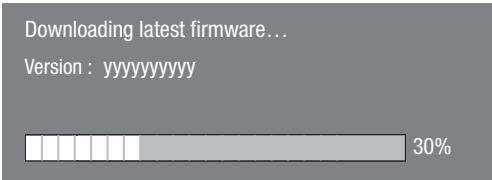

- 3 When the software is successfully updated, a screen is displayed indicating that the update process is completed.

- If the update has failed, an error message appears. Retry to perform the update after checking if the LAN cable connection (page 32) and internet settings (pages 71-73) are performed properly.

NOTE

- If the update of the AUDIO section starts automatically after the software update, the STANDBY indicator will blink. When the update is completed, the STANDBY indicator stops blinking and lights up. (The power will be turned off automatically.) Never disconnect the AC power cord until this status is reached.

- 4 If prompted by a displayed message to turn off the system, press **POWER** to turn it off before using again.

Manual Update from Network

This function allows you to perform the update operation by accessing an internet connection manually to check if there is a new firmware version.

NOTE

- Make sure that the LAN cable is connected to this system. (See page 32.)
- Make sure to perform the communication settings. (See pages 71-73.)
- It may take time to access and download the update depending on the internet connection and other factors.

CAUTION

- Do not remove the LAN cable or unplug the AC cord while downloading or updating software.



Buttons under the cover



- 1 Press **BD/AUX** repeatedly to select DISC function.
 - The same operation can be performed by pressing **SELECTOR** repeatedly on the main unit.
- 2 Press **HOME** to display the menu screen.
- 3 Press **▲/▼** to select “Settings”, then press **▶** or **ENTER**.
- 4 Press **▲/▼** to select “Software Update Settings”, then press **▶** or **ENTER**.
- 5 Press **▲/▼** to select “Manual Update”, then press **▶** or **ENTER**.
- 6 Press **▲/▼** to select “Network”, then press **ENTER**.

- 7 During access to the network and checking the latest version of firmware, “Accessing” blinks.
 - The current version of this unit software and the latest version of the update file on the network are displayed when latest version of firmware has been found. To update this system software with update file, select “Yes”, and go to step 8.

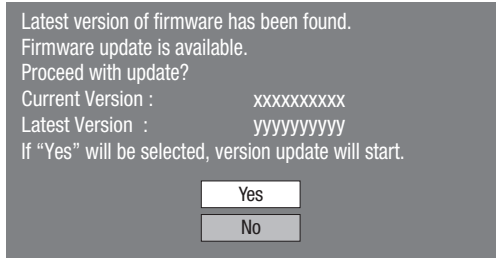

- If the firmware has already been updated to the latest version, the following message appears.

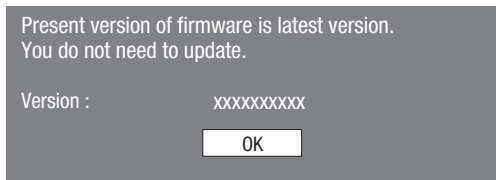

- If the internet connection has failed, an error message appears. Retry to perform the update after checking if the LAN cable connection (page 32) and internet settings (pages 71-73) are performed properly.

- 8 Press **ENTER** to start updating.

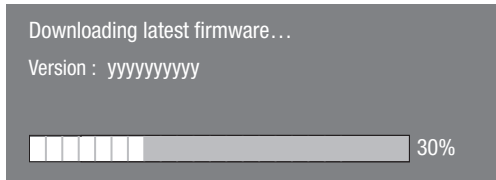

- 9 When the software is successfully updated, a screen is displayed indicating that the update process is completed.
 - If the update has failed, an error message appears. Retry to perform the update after checking if the LAN cable connection (page 32) and internet settings (pages 71-73) are performed properly.

NOTE

- If the update of the AUDIO section starts automatically after the software update, the STANDBY indicator will blink. When the update is completed, the STANDBY indicator stops blinking and lights up. (The power will be turned off automatically.) Never disconnect the AC power cord until this status is reached.

- 10 If prompted by a displayed message to turn off the system, press **POWER** to turn it off.

SETTINGS

Manual Update from USB memory device

This function allows software updates by inserting a USB memory device with the update file into the USB1 or USB2 terminal on this system.

- When a software update is performed, the software update data must be written onto the USB memory device in advance using a PC.
- The USB memory device must be clear of all files except software update data to allow new software uploading.

To check for the availability of a software update, visit www.sharpusa.com/products/support/. If you have any questions, please call 1-800-BE-SHARP (800-237-4277).

- When software update data is released, copy the data onto a USB memory device after downloading it to a PC.
- For methods such as downloading and copying to a USB memory device, carefully read the description shown on the website before performing the operation.

NOTE

- Only USB memory devices formatted with FAT 32/16 are compatible.
When formatting a USB memory device using a PC, perform the following settings.
Format File System: FAT32
Allocation Unit Size: Default Allocation Size
- Do not extract the firmware update file to any folders other than the root directory on the USB memory device. The firmware update file must be only one file directly in the root directory.

When you insert or remove a USB memory device, be sure to turn the main power off and make sure that "Quick Start" is set to "No" (See page 69).

- 1 Insert the USB memory device with the update file into the USB1 or USB2 terminal on this system.

- It is recommended that the USB memory device be connected to the USB2 terminal on the front of the system.

NOTE

- A USB memory device can be used with either the USB1 or USB2 terminal. When two USB memory devices are connected to both terminals at the same time, in certain situations the USB1 terminal may give priority to Local Storage and the USB1 terminal may not be able to be used for Software Update.

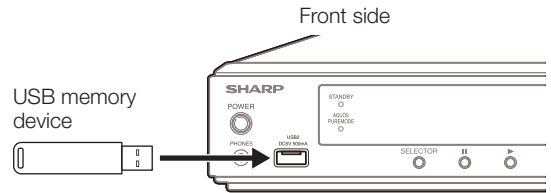

- 2 Press **BD/AUX** repeatedly to select DISC function.
 - The same operation can be performed by pressing **SELECTOR** repeatedly on the main unit.
- 3 Press **HOME** to display the menu screen.
- 4 Press **▲/▼** to select "Settings", then press **▶** or **ENTER**.
- 5 Press **▲/▼** to select "Software Update Settings", then press **▶** or **ENTER**.
- 6 Press **▲/▼** to select "Manual Update", then press **▶** or **ENTER**.
- 7 Press **▲/▼** to select "USB Memory", then press **ENTER**.
 - If you have not yet set the password, go to step 9.
- 8 Enter the 4-digit number using 0-9.

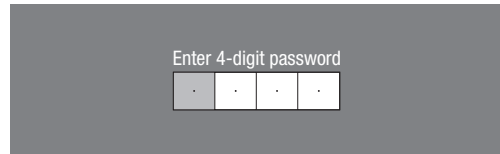

- 9 Press **ENTER** to start checking data in the USB memory device.

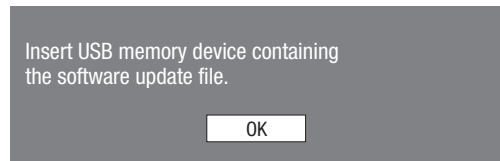

Buttons under the cover



CAUTION

- Do not remove the USB memory device or unplug the AC cord while the software is being updated.

(Continued on the next page)

SETTINGS

10 During the data checking, "Checking" blinks.

Now checking the data in USB memory device.

Checking

- The current version of this unit software and the version of the update file on the USB memory device are displayed. To update this system software with update file, select "Yes", and press **ENTER**.

Software update file is detected in the USB memory device. Start update?

Current Ver. : xxxxxxxxxx

Update Ver. : yyyyyyyyyy

Yes

No

- If the USB memory device is not properly installed or the correct update file cannot be found on the USB memory device, an error message is displayed. Check the file on the USB memory device, and then reinsert the USB memory device correctly.

Software update file is not detected in the USB memory device. Confirm that you have transferred the file to the USB memory device and retry software update. Confirm that you have inserted the USB memory device into the correct device.

OK

There is more than one software file in the USB memory device. Confirm that only the software update file is in the USB memory device.

OK

11 Press **ENTER** to start updating.

- The screen becomes dark for a while until the update screen can be displayed. Please wait for the update screen to appear. Do not unplug the AC cord.

The picture will temporarily go dark until the software update display appears. Wait several minutes and do not unplug the AC cord.

OK

Now updating

* Do not unplug AC cord.

Update Version yyyyyyyyyy

██████████ 30%

12 When the software is successfully updated, a screen is displayed indicating that the update process is completed.

- If the update has failed, check the file in the USB device and try Software Update again.

NOTE

- If the update of the AUDIO section starts automatically after the software update, the STANDBY indicator will blink. When the update is completed, the STANDBY indicator stops blinking and lights up. (The power will be turned off automatically.) Never disconnect the AC power cord until this status is reached.

13 If prompted by a displayed message to turn off the system, press **POWER** to turn it off.

14 Remove the USB memory device.

- Delete unneeded software update data using a PC after the software update process is completed.

SETTINGS

Country Code List

USA / CANADA / JAPAN / GERMANY / FRANCE / UK / ITALY / SPAIN / SWISS / SWEDEN / HOLLAND / NORWAY / DENMARK / FINLAND / BELGIUM / HONG KONG / SINGAPORE / THAILAND / MALAYSIA / INDONESIA / TAIWAN / PHILIPPINE / AUSTRALIA / RUSSIA / CHINA

Language List

English / Français / Deutsch / Italiano / Español / Japanese / Svenska / Nederlands

Language Code List

AA Afar / **AB** Abkhazian / **AF** Afrikaans / **AM** Ameharic / **AR** Arabic / **AS** Assamese / **AY** Aymara / **AZ** Azerbaijani / **BA** Bashkir / **BE** Byelorussian / **BG** Bulgarian / **BH** Bihari / **BI** Bislama / **BN** Bengali, Bangla / **BO** Tibetan / **BR** Breton / **CA** Catalan / **CO** Corsican / **CS** Czech / **CY** Welsh / **DA** Danish / **DE** German / **DZ** Bhutani / **EL** Greek / **EN** English / **EO** Esperanto / **ES** Spanish / **ET** Estonian / **EU** Basque / **FA** Persian / **FI** Finnish / **FJ** Fiji / **FO** Faroese / **FR** French / **FY** Frisian / **GA** Irish / **GD** Scots Gaelic / **GL** Galician / **GN** Guarani / **GU** Gujarati / **HA** Hausa / **HI** Hindi / **HR** Croatian / **HU** Hungarian / **HY** Armenian / **IA** Interlingua / **IE** Interlingue / **IK** Inupiak / **IN** Indonesian / **IS** Icelandic / **IT** Italian / **IW** Hebrew / **JA** Japanese / **JI** Yiddish / **JW** Javanese / **KA** Georgian / **KK** Kazakh / **KL** Greenlandic / **KM** Cambodian / **KN** Kannada / **KO** Korean / **KS** Kashmiri / **KU** Kurdish / **KY** Kirghiz / **LA** Latin / **LN** Lingala / **LO** Laothian / **LT** Lithuanian / **LV** Latvian, Lettish / **MG** Malagasy / **MI** Maori / **MK** Macedonian / **ML** Malayalam / **MN** Mongolian / **MO** Moldavian / **MR** Marathi / **MS** Malay / **MT** Maltese / **MY** Burmese / **NA** Nauru / **NE** Nepali / **NL** Dutch / **NO** Norwegian / **OC** Occitan / **OM** Afan (Oromo) / **OR** Oriya / **PA** Panjabi / **PL** Polish / **PS** Pashto, Pushto / **PT** Portuguese / **QU** Quechua / **RM** Rhaeto-Romance / **RN** Kirundi / **RO** Romanian / **RU** Russian / **RW** Kinyarwanda / **SA** Sanskrit / **SD** Sindhi / **SG** Sangho / **SH** Serbo-Croatian / **SI** Singhalese / **SK** Slovak / **SL** Slovenian / **SM** Samoan / **SN** Shona / **SO** Somali / **SQ** Albanian / **SR** Serbian / **SS** Siswat / **ST** Sesotho / **SU** Sundanese / **SV** Swedish / **SW** Swahili / **TA** Tamil / **TE** Telugu / **TG** Tajik / **TH** Thai / **TI** Tigrinya / **TK** Turkmen / **TL** Tagalog / **TN** Setswana / **TO** Tonga / **TR** Turkish / **TS** Tsonga / **TT** Tatar / **TW** Twi / **UK** Ukrainian / **UR** Urdu / **UZ** Uzbek / **VI** Vietnamese / **VO** Volapuk / **WO** Wolof / **XH** Xhosa / **YO** Yoruba / **ZH** Chinese / **ZU** Zulu

Troubleshooting

The following problems do not always suggest a defect or malfunction of this system. Refer to the problems and lists of possible solutions below before calling for service.

Power

Problem	Possible causes and solutions
The system power cannot be turned on.	<ul style="list-style-type: none"> • Is the power cord firmly plugged into the AC outlet? (Page 34) • When the power cord is plugged into an AC outlet, perform a reset. (Page 83) • The protection circuit may be activated. Unplug and plug in the power cord again after 5 minutes or more.

Basic Operation

Problem	Possible causes and solutions
The remote control does not work.	<ul style="list-style-type: none"> • Set the remote control and this system to the same remote control code. (Page 35) • Use the remote control within its operating range. • Replace the batteries. • Are there any obstructions in front of this system? • Is the remote control sensor exposed to strong light (inverter fluorescent light, direct sunlight, etc.)?
Cannot operate the system.	<ul style="list-style-type: none"> • Are you operating the system within the specified operating temperature range? (Page 84)

Disc Playback

Problem	Possible causes and solutions
The system cannot play a disc.	<ul style="list-style-type: none"> • Take out the disc and clean it. (Page 12) • Make sure that the disc is loaded properly (aligned in disc tray and label-side up). (Page 41) • Make sure that region code on the disc matches that of this system. (Page 9) • Allow any condensation in or near the system to dry. (Page 12) • Check that the disc is recorded in the compatible TV system (PAL or NTSC). • The system cannot play back video which was not recorded normally. (Page 9) • Proper playback may be impossible due to the state of the disc recording, a scratched, warped or dirty disc, the state of the pick-up, or compatibility issues between this system and the disc being used. (Pages 9, 12) • When the recorded time of a disc is unusually short, playback may not be possible. • BD-RE/R discs recorded in a format other than BDMV/BD-RE cannot be played back. (Page 9)
The disc is automatically ejected after closing the disc tray.	<ul style="list-style-type: none"> • Make sure that the disc is loaded properly (aligned in disc tray and label-side up). (Page 41) • Take out the disc and clean it. (Page 12) • Make sure that the disc is playable. (Page 9) • Make sure that region code on the disc matches that of this system. (Page 9)
Video stops.	<ul style="list-style-type: none"> • Has the system been subjected to shock or impact? Are you using it in an unstable location? The system will stop if it senses shock or vibration.
The system makes a snapping sound when starting playback or loading a disc.	<ul style="list-style-type: none"> • The system may sometimes make a snapping sound when starting playback if it has not been operated in a while. These sounds are not malfunctions of the system but are normal operating conditions.
The video does not change even when you switch the input mode during disc playback.	<ul style="list-style-type: none"> • If you have pressed SELECTOR to switch the input source during disc startup or automatic disc playback, the audio output from the speakers may not match the video on the TV. Stop disc playback, and then change the input mode.

Troubleshooting

Picture

Problem	Possible causes and solutions
No picture.	<ul style="list-style-type: none"> • Make sure that the cables are connected correctly. (Pages 24-27) • Make sure that the connected TV or the AV receiver is set to the correct input. (Pages 24-27) • Take out the disc and clean it. (Page 12) • Make sure that region code on the disc matches that of this system. (Page 9) • There is no picture from the HDMI output. <ul style="list-style-type: none"> – Are the settings performed correctly? Please check the settings. (Page 68) • There is no picture from the component video output. <ul style="list-style-type: none"> – Are the settings performed correctly? Please check the settings. (Page 68)
Screen freezes and operation buttons do not work.	<ul style="list-style-type: none"> • Press STOP, then restart playback. • Turn off the power and turn on the power again. • If the power is not turned off, perform a reset. (Page 83) • Is the disc damaged or dirty? Check the condition of the disc. See page 12 for details about disc cleaning.
There is just audio with no video.	<ul style="list-style-type: none"> • Is the connection cable for video output connected properly? (Pages 24-27)
Widescreen video appears vertically stretched, or black bands appear at the top and bottom of the screen.	<ul style="list-style-type: none"> • Is “TV Aspect Ratio” set to match the connected TV? (Page 68) • If you are using a widescreen TV, is the “TV Aspect Ratio” set to “Wide”? (Page 68)
Square noise (mosaic) appears on the screen.	<ul style="list-style-type: none"> • Blocks in images may be visible in scenes with rapid movement due to the characteristics of digital image compression technology.
The playback screen will be disturbed if DVD video is recorded to a VCR, or played back through a VCR.	<ul style="list-style-type: none"> • This system complies with analog copy protection. Some discs contain a copy prohibiting signal. If you try to play back such discs through a VCR, or record to a VCR and play back the signal, the copy protection will prevent normal playback. (Pages 26-27)
Audio is not output, or images are not played back properly.	<ul style="list-style-type: none"> • The audio may not be output or the images may not be played back properly for some discs in which copyright-protected contents are recorded.

Sound

Problem	Possible causes and solutions
No sound is heard.	<ul style="list-style-type: none"> • Is input switching (selection) proper? (Page 41) • Is muting activated? (Page 41) • Is the volume level set to “0”? (Page 41) • Is power to the connected source component turned on? • Is the source component connected to the correct input? • Are the headphones connected? • Are the speaker wires disconnected?
No sound, or sound is distorted.	<ul style="list-style-type: none"> • There is no sound during still mode, slow motion playback, fast forward and fast reverse. (Page 55) • Check that the audio cable is connected correctly. (Pages 24, 26-30) • Check that the cable plugs are clean. • Take out the disc and clean it. (Page 12) • Audio may not be output depending on the audio recording status, such as when audio other than an audio signal or non-standard audio is recorded for the audio content of the disc. (Page 9)
The sounds from speakers are not well balanced.	<ul style="list-style-type: none"> • Are the speaker wires connected to the wrong channels? (Page 22) • Are speakers adjusted to the level? (Pages 39-40)
The sound from subwoofer is not well balanced.	<ul style="list-style-type: none"> • Is the subwoofer level set to the minimum or maximum level? (Pages 39-40, 66)
Noise is heard during playback.	<ul style="list-style-type: none"> • Move any computers or mobile phones away from this system.
Left and right channels of audio are reversed, or sound comes out of only one side.	<ul style="list-style-type: none"> • Are left and right audio cables connected to the opposite terminal, or is one side disconnected? (Pages 26-27, 29)
Audio is not output, or images are not played back properly.	<ul style="list-style-type: none"> • The audio may not be output or the images may not be played back properly for some discs in which copyright-protected contents are recorded.

(Continued on the next page)

Troubleshooting

Network

Problem	Possible causes and solutions
Cannot connect to the Internet.	<ul style="list-style-type: none"> Is the LAN cable connected properly? Is the wrong cable such as a modular cable used? Connect a LAN cable to the ETHERNET terminal. (Page 32) Is the power for the connected equipment, such as broadband router or modem turned on? Is the broadband router and/or modem properly connected? Is the proper value(s) set in the network setting? Check "Communication Setup". (Pages 71-73)
Cannot download BD-LIVE contents.	<ul style="list-style-type: none"> Is the LAN cable connected properly? Is the USB memory device properly connected? Check that the USB memory device is connected to the USB1 or USB2 terminal on this system. Check if the BD disc supports BD-LIVE. Check the setting for "BD Internet Access". (Page 70)

AQUOS LINK

Problem	Possible causes and solutions
AQUOS LINK function does not work properly.	<ul style="list-style-type: none"> Is the HDMI cable properly connected? Connect the HDMI cable correctly and then perform the reset procedure. (Page 83) Try switching the input manually to check whether video from the system is reproduced.
AQUOS TV remote control does not operate this system.	<ul style="list-style-type: none"> Is the AQUOS TV remote control being pointed at the AQUOS TV? Is the AQUOS TV set to "By AQUOS AUDIO SP" mode? (Page 44) Is an HDMI CEC-enabled component being used? Check whether the batteries of the AQUOS TV remote control are still good.
Cannot reproduce sound from AQUOS TV with this system.	<ul style="list-style-type: none"> Are the AQUOS TV audio output and the DIGITAL AUDIO IN (OPTICAL) terminal on this system connected correctly via optical digital cable? (Page 24) Is the AQUOS TV set to "By AQUOS AUDIO SP" mode? (Page 44)
No sound or picture.	<ul style="list-style-type: none"> Is HDMI compliant equipment being used? Is the HDMI cable connected correctly? Connect the HDMI cable correctly and then perform the reset procedure. (Page 83) Do not connect or disconnect an HDMI cable while power is on. This may lead to operation problems and can cause the picture to disappear.
Power turns off suddenly.	<ul style="list-style-type: none"> Is the HDMI cable connected correctly? Connect the HDMI cable correctly and then perform the reset procedure. (Page 83)
Switching on this system does not turn on AQUOS TV.	<ul style="list-style-type: none"> Try setting this system to the playback condition. When playback is activated, power to AQUOS TV should come on.
During playback of video media, there is a time lag (lip sync error) between the image on the AQUOS TV and the sound from this system.	<ul style="list-style-type: none"> Try setting the audio delay function. (Page 63) This will delay the sound reproduced by this system, which serves to reduce the lip sync error.

Other

Problem	Possible causes and solutions
The TV operates incorrectly.	<ul style="list-style-type: none"> Some TVs with wireless remote control capability may operate incorrectly when using the remote control of this system. Use such TVs away from the main unit.
The system heats up during use.	<ul style="list-style-type: none"> When using this system, the console cabinet may heat up depending on the usage environment. This is not a malfunction.
STANDBY indicator will remain lit.	<ul style="list-style-type: none"> When the AC cord is removed from the outlet, the STANDBY indicator will remain lit for a short period. This is normal and is not a malfunction.
When a button is pressed, the system does not respond.	<ul style="list-style-type: none"> Set this system to the stand-by mode and then turn it back on. If the problem still exists, reset it. (Page 83)
The preset channel cannot be recalled.	<ul style="list-style-type: none"> Did you remove the plug from the AC outlet, or did a power failure occur? Preset the channel again.
The settings have been erased.	<ul style="list-style-type: none"> If this system is unplugged (or there is a power failure) for more than about 1 hour while its power is on, the settings will be lost. Make sure that you turn off this system before unplugging the power cord. When there is a power interruption or the power cord is unplugged from the AC outlet with the power on, all settings return to the factory preset values.

Error Messages

The following messages appear on the TV screen in case of an error during operation.

Error message	Possible Error	Suggested Solution
Cannot play.	<ul style="list-style-type: none"> The disc cannot be played back with this system. 	<ul style="list-style-type: none"> Check the disc, and load it correctly.
Incompatible disc.	<ul style="list-style-type: none"> If you load a disc which cannot be played with this system (i.e. a scratched disc), or if you load a disc upside down, this message will appear, and the disc tray will automatically pop out. Occurs if the loaded disc cannot be played because it is a non-standard disc or scratched, etc. 	
Cannot operate.	<ul style="list-style-type: none"> Occurs if an operation is incorrect. 	_____
This USB memory is not formatted properly. Please format the memory in USB memory management.	<ul style="list-style-type: none"> Occurs if there is a formatting error. Occurs if the USB memory is not formatted with FAT 32/16. 	<ul style="list-style-type: none"> Format the USB memory again. Format the USB memory with your PC.
The Connected USB Memory cannot be used. It should be compliant with USB 2.0	<ul style="list-style-type: none"> Occurs if USB memory not compliant with USB 2.0 High Speed (480Mbit/s) is used (i.e. USB 1.0/USB 1.1). 	<ul style="list-style-type: none"> Connect USB 2.0 High Speed (480Mbit/s) compliant USB memory.

The following messages are displayed on the main unit, when you fail to perform operations properly.

Error Message	Possible Error	Suggested Solution
FAN LOCK	<ul style="list-style-type: none"> The cooling fan at the rear of the main unit does not run. 	<ul style="list-style-type: none"> Unplug the AC power cord and check if foreign objects get caught around the cooling fan. *
 STANDBY indicator (blinks red)	<ul style="list-style-type: none"> Is volume setting very high? Is system placed in a very hot location? 	<ul style="list-style-type: none"> If the system is operated at very high volume levels or in a hot location for an extended period, the protection circuitry may be triggered. Unplug the AC power cord and plug it in again after 5 minutes or more. Then check the operation. *

* Should the same message appear even if the system is unplugged and plugged in or is set to the stand-by mode and on again, contact your local dealer where you purchased the system

To Reset this System

- If this system receives strong interference from a source such as excessive static electricity, strong external noise, malfunction of power supply, or voltage caused by lightning during use or a wrong operation is sent to the system, errors like the system not accepting an operation may occur.
- Press and hold **POWER** (for about 15 seconds) on the main unit.
 - If the power is on**, keep the button pressed down until the front panel display turns off. When the front panel display is turned off, the reset procedure is complete.
 - If the power is off**, keep the button pressed down until the STANDBY indicator turns off. When the STANDBY indicator is turned off, the reset procedure is complete. Then, after the STANDBY indicator is lit, turn on the power.
- When a reset is performed while the power is on, the system will turn off. Turn the power on again. At this point, it may take a few moments for the system processing to finish before the system is ready for use. During the system processing, the BD/DVD/CD mode indicator on the front panel display of the main unit will blink. Once the system processing has finished, the indicator will finish blinking and then light up normally. You can operate the system when the BD/DVD/CD mode indicator is lit.
- Since all settings including the language setting stored in memory are also reset when a reset has been performed, they must be set again.
- When the problem persists even after performing a reset, unplug the AC cord and plug it in again. If this does not solve the problem, contact the nearest service center approved by SHARP.

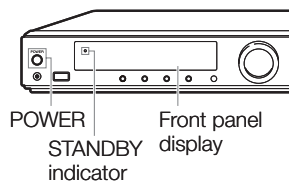

Specifications

As part of our policy of continuous improvement, SHARP reserves the right to make design and specification changes for product improvement without prior notice. The performance specification figures indicated are nominal values of production units. There may be some deviations from these values in individual units.

Main Unit

Power supply	AC 120V, 60Hz
Power consumption	Power on : 147W Stand-by mode : 20.5W Low power stand-by mode : 0.47W
Power output (FTC)	Front/Center/Surround : 80 W minimum RMS per channel into 6 ohms from 120 Hz to 20 kHz, 1 % total harmonic distortion Subwoofer : 80 W minimum RMS into 6 ohms from 45 Hz to 120 Hz, 1 % total harmonic distortion
Rated power output	Front : 170W + 170W, Center : 170W, Surround : 170W + 170W (6 ohms at 1 KHz) Subwoofer : 170W (6 ohms at 100 Hz)
Playable disc types	BD-ROM, BD-RE Dual Layer, BD-R Dual Layer, DVD Video, DVD+RW/+R/-RW/-R Dual Layer (Video/VR/AVCHD/JPEG file/MP3 file format), Audio CD (CD-DA), CD-RW/R (CD-DA/JPEG file/MP3 file format)
Tuner frequency range	FM: 87.5 - 108 MHz
Input terminals	Optical digital Input : Square type x 2 Audio input : RCA type x 1 (L/R) USB input: USB 2.0 High Speed (480Mbit/s) correspondence x 2 (for Local storage/Software update/JPEG and MP3 playback) iPod terminal: 16-pin x 1 FM Antenna : 75 ohms
Output terminals	HDMI output: 19-pin standard connector (1080p 24Hz output) x 1 HDMI™ (V.1.3 with Deep Color, x.v.Color, Dolby TrueHD, DTS-HD Master Audio Essential) Component video output: RCA type x 1 Output level: Y: 1 Vp-p (75 ohms), P _B /C _B , P _R /C _R : 0.7 Vp-p (75 ohms) Video output: RCA type x 1, Output level: 1Vp-p (75 ohms) Audio output: RCA type x 1 (L/R), Output level: 2V rms (1K ohms) Front speakers, Center speaker, Surround speakers and Subwoofer: more than 6 ohms Headphones: 16 - 50 ohms (recommended: 32 ohms)
Other terminal	ETHERNET (Network connector) x 1 (10BASE-T/100BASE-TX)
Dimensions	Approx. 17-1/16" x 2-3/8" x 13-1/8" (W x H x D) Approx. 433 x 60 x 332 mm (W x H x D)
Weight	Approx. 11.3 lbs (5.1 kg)
Operating temperature	41°F to 95°F (5°C to 35°C)
Storage temperature	-4°F to 131°F (-20°C to 55°C)
Operating humidity	10 % to 80 % (no condensation)

Sound Bar Speaker (right/center/left)

Type	Full range speaker system (magnetically shielded) 2-1/2" (6.5 cm) speaker
Impedance	6 ohms
Dimensions	Approx. 37-13/16" x 4-3/8" x 3-1/8" (W x H x D) Approx. 960 x 110 x 79 mm (W x H x D)
Weight	Approx. 7.7 lbs (3.5 kg)

Surround Speaker

Type	Full range speaker system 2-1/2" (6.5 cm) speaker
Impedance	6 ohms
Dimensions	Approx. 4-3/16" x 7-7/8" x 5-5/16" (W x H x D) Approx. 106 x 200 x 135 mm (W x H x D)
Weight	Approx. 2.0 lbs (0.9 kg) / each

Subwoofer

Type	6-1/4" (16 cm) woofer
Impedance	6 ohms
Dimensions	Approx. 9" x 15-3/8" x 13-7/16" (W x H x D) Approx. 228 x 390 x 342 mm (W x H x D)
Weight	Approx. 14.3 lbs (6.5 kg)

Glossary

AQUOS LINK (pages 43-44)

AQUOS LINK is a function that lets the system control and be controlled by the operations of a connected AQUOS TV that supports AQUOS LINK.

When you turn on or off the system, the AQUOS TV is automatically turned on or off. When you adjust the volume, mute the sound, or change the audio setting on the system, the same setting is applied on the AQUOS TV.

AVCHD (page 9)

AVCHD (Advanced Video Codec High Definition) refers to a recording format (specification) for digital video cameras which can record to a disc such as 8 cm DVD disc and play back digital high definition images.

BD-DAV (page 9)

BD-DAV (Blu-ray Disc Audio/Visual, BD-AV) refers to one of the application formats used for writable Blu-ray discs such as BD-R, BD-RE, etc. BD-DAV is a recording format equivalent to DVD-VR (VR mode) of the DVD specifications.

BD-J application

The BD-ROM format supports Java for interactive functions. "BD-J" offers content providers almost unlimited functionality when creating interactive BD-ROM titles.

BD-LIVE (pages 47, 48)

A variety of interactive content is available from BD-LIVE compatible Blu-ray discs via the internet.

BDMV (page 9)

BDMV (Blu-ray Disc Movie, BD-MV) refers to one of the application formats used for BD-ROM which is one of the Blu-ray Disc specifications. BDMV is a recording format equivalent to DVD-video of the DVD specification.

BD-R (pages 9, 45)

A BD-R (Blu-ray Disc Recordable) is a recordable, write-once Blu-ray Disc. Since contents can be recorded and cannot be overwritten, a BD-R can be used to archive data or for storing and distributing video material.

BD-RE (pages 9, 45)

A BD-RE (Blu-ray Disc Rewritable) is a recordable and rewritable Blu-ray Disc.

BD-ROM

BD-ROMs (Blu-ray Disc Read-Only Memory) are commercially produced discs. Other than conventional movie and video contents, these discs have enhanced features such as interactive content, menu operations using pop-up menus, selection of subtitle display, and slide shows. Although a BD-ROM may contain any form of data, most BD-ROM discs will contain movies in High Definition format for playback on Blu-ray Disc players.

Blu-ray Disc (BD) (page 9)

A disc format developed for recording/playing high-definition (HD) video (for HDTV, etc.), and for storing large amounts of data. A single layer Blu-ray Disc holds up to 25 GB, and a dual-layer Blu-ray Disc holds up to 50 GB of data.

Chapter number (pages 58, 59)

Sections of a movie or a music feature that are smaller than titles. A title is composed of several chapters. Some discs may only be comprised of a single chapter.

Control Panel (page 38)

This function allows you to operate this system using the TV remote control by displaying the control panel on the TV screen.

Copy guard

This function prevents copying. You cannot copy discs marked by the copyright holder with a signal which prevents copying.

Deep Color

Deep Color can reproduce rich colors, increasing the number of bits describing colors.

This system is compatible with Deep Color. You can enjoy this function by connecting to a Deep Color compatible TV using an HDMI cable.

Disc menu (page 46)

This lets you select things like the subtitle language or audio format using a menu stored on the DVD video disc.

Dolby Digital

A sound system developed by Dolby Laboratories Inc. that gives movie theater ambience to audio output when the product is connected to a Dolby Digital processor or amplifier.

Dolby Digital Plus

A sound system developed as an extension to Dolby Digital. This audio coding technology supports 7.1 multi-channel surround sound.

Dolby Pro Logic II

Dolby Pro Logic II converts two-channel stereo sound to surround sound for a more immersive audio experience.

Dolby TrueHD

Dolby TrueHD is a lossless coding technology that supports up to 8 channels of multi-channel surround sound for the next generation optical discs. The reproduced sound is true to the original source bit-for-bit.

DTS

This is a digital sound system developed by DTS, Inc. for use in cinemas.

(Continued on the next page)

DTS-HD High Resolution Audio

DTS-HD High Resolution Audio is a new technology developed for the next generation high definition optical disc format.

DTS-HD Master Audio

DTS-HD Master Audio is a lossless audio compression technology developed for the next generation high definition optical disc format.

DTS-HD Master Audio | Essential

DTS-HD Master Audio | Essential is a lossless audio compression technology developed for the next generation high definition optical disc format.

DVD upscaling (page 45)

Upscaling (upconverting) refers to a function of various players and devices that enlarge the image size to fit the size of the screen of video equipments such as a TV.

DVD video (pages 9, 45)

A disc format that contains up to eight hours of moving pictures on a disc the same diameter as a CD. A single-layer single sided DVD holds up to 4.7 GB; a double layer single-sided DVD, 8.5 GB; a single layer double-sided DVD, 9.4 GB; double-layer double-sided DVD, 17 GB. The MPEG 2 format was adopted for efficient video data compression. It is a variable rate technology that encodes the data to according to the status of the video for reproducing high-quality images. Audio information is recorded in a multi-channel format such as Dolby Digital, allowing for a realistic audio presence.

DVD+/-R (pages 9, 45)

A DVD+/-R is a recordable, write-once DVD. Since contents can be recorded and cannot be overwritten, a DVD+/-R can be used to archive data or for storing and distributing video material. The DVD+/-R has two different formats: VR format and Video format. DVDs created in Video format have the same format as a DVD video, while discs created in VR (Video Recording) format allow the contents to be programmed or edited.

DVD+/-RW (pages 9, 45)

A DVD+/-RW is a recordable and rewritable DVD. The re-recordable feature makes editing possible. The DVD+/-RW has two different formats: VR format and Video format. DVDs created in Video format have the same format as a DVD video, while discs created in VR (Video Recording) format allow the contents to be programmed or edited.

HDMI (page 24)

HDMI (High-Definition Multimedia Interface) is an interface that supports both video and audio on a single digital connection. The HDMI connection carries standard to high definition video signals and multi-channel audio signals to AV components such as HDMI equipped TVs, in digital form without degradation.

Interlace format

Interlace format shows every other line of an image as a single "field" and is the standard method for displaying images on television. The even numbered field shows the even numbered lines of an image, and the odd numbered field shows the odd numbered lines of an image.

JPEG (pages 9, 10, 52)

JPEG (Joint Photographic Experts Group) is a still image data compression format and is used in most of digital cameras.

Letter Box (LB 4:3) (page 68)

A screen size with black bars on the top and bottom of the image to allow viewing of wide-screen (16:9) material on a connected 4:3 TV.

Linear PCM Sound

Linear PCM is a signal recording format used for Audio CDs and on some DVD and Blu-ray discs. The sound on Audio CDs is recorded at 44.1 kHz with 16 bits. (Sound is recorded between 48 kHz with 16 bits and 96 kHz with 24 bits on DVD video discs and between 48 kHz with 16 bits and 192 kHz with 24 bits on BD video discs.)

Lip-Sync

This function adjusts the audio signal processing time for better audio-video synchronization.

MP3 (pages 9, 10, 51)

MP3 files are audio data compressed in the MPEG1/2 Audio layer-3 file format. "MP3 files" have ".mp3" as extensions.

MPEG-2

MPEG-2 (Moving Picture Experts Group phase 2) is one of the video data compression schemes, which is adopted for DVD videos and digital broadcasts worldwide. Some Blu-ray Discs also use high bitrate MPEG-2.

Multi Angle (pages 57-59)

This is a feature of DVD and BD video discs. In some discs, the same scene is shot from different angles, and these are stored in a single disc so you can enjoy playback from each angle. (This function can be enjoyed if the disc is recorded with multiple angles.)

Multi Audio

This is a feature of DVD and BD video discs. This function makes it possible to record different audio tracks for the same video, so you can enhance your enjoyment by switching the audio. (You can enjoy this function with discs recorded with multiple audio tracks.)

Netflix (pages 53, 54)

Netflix is an online DVD and Blu-ray Disc rental service, offering rental-by mail and streaming instantly to Netflix unlimited members.

Pan Scan (PS 4:3) (page 68)

A screen size that cuts off the sides of the image to allow viewing of wide-screen (16:9) material on a connected 4:3 TV.

Parental control (page 70)

In some digital broadcasts and BD/DVD video discs, a control level for disc viewing is set depending on the age of the viewer. With this system, you can set the control level for viewing such broadcasts and discs.

Pop-up menu (page 46)

An enhanced menu operation available on BD video discs. The pop-up menu appears when **POP-UP MENU** is pressed during playback, and can be operated while playback is in progress.

Progressive format

Compared to the Interlace format that alternately shows every other line of an image (field) to create one frame, the Progressive format shows the entire image at once as a single frame. This means that while the Interlace format can show 30 frames/60 fields in one second, the Progressive format can show 60 frames in one second. The overall picture quality increases and still images, text, and horizontal lines appear sharper.

Region code (page 9)

Code identifying a geographic region of compatibility for a BD/DVD.

Remote control code (page 35)

This is the type of the remote control signal for operating the system. There are three types of remote control signals: "Remote Control No. 1" (RC-1), "Remote Control No. 2" (RC-2) and "Remote Control No. 3" (RC-3).

Resume playback (page 45)

If you stop playback while it is in progress, the system stores the stop position in memory, and this function lets you playback from that point.

RSS (page 37)

"Really Simple Syndication" / "Rich Site Summary" is a [web feed](#) formats used to publish frequently updated information in a scrolling text format from a web.

Skip (pages 51, 55)

This returns to the start of the chapter (or track) being played, or skips to the next chapter (or track).

Sound Mode (page 65)

Select from among 10 preset sound modes to suit your listening preference.

Subtitles (pages 57, 58, 59)

These are the lines of text appearing at the bottom of the screen which translate or transcribe the dialog. They are recorded on many DVD and BD video discs.

Time number

This indicates the play time which has elapsed from the start of a disc or a title. It can be used to find a specific scene quickly. (It may not work with some discs.)

Title number (pages 58, 59)

These numbers are recorded on DVD and Blu-ray discs. When a disc contains two or more movies, these movies are numbered as title 1, title 2, etc.

Top menu (page 46)

In a BD/DVD video, this is the menu for selecting things like the chapter to be played back and the subtitle language. In some DVD videos, the top menu may be called the "Title Menu".

Track number (pages 58, 59)

These numbers are assigned to the tracks which are recorded on audio CDs. They enable specific tracks to be located quickly.

x.v.Color

x.v.Color reproduces a greater range of color than before, showing almost all of the colors that the human eye can detect. (Applicable for JPEG files only with this system)

Network Service Disclaimer

This Sharp device facilitates the access to content and services provided by third parties. The content and services accessible via this device belong to and may be proprietary to third parties. Therefore, any use of such third party content and services must be in accordance with any authorization or terms of use provided by such content or service provider. Sharp shall not be liable to you or any third party for your failure to abide by such authorization or terms of use. Unless otherwise specifically authorized by the applicable content or service provider, all third party content and services provided are for personal and non-commercial use; you may not modify, copy, distribute, transmit, display, perform, reproduce, upload, publish, license, create derivative works from, transfer or sell in any manner or medium any content or services available via this device.

Sharp is not responsible, nor liable, for customer service-related issues related to the third party content or services. Any questions, comments or service-related inquiries relating to the third party content or service should be made directly to the applicable content or service provider.

You may not be able to access content or services from the device for a variety of reasons which may be unrelated to the device itself, including, but not limited to, power failure, other Internet connection, or failure to configure your device properly. Sharp, its directors, officers, employees, agents, contractors and affiliates shall not be liable to you or any third party with respect to such failures or maintenance outages, regardless of cause or whether or not it could have been avoided.

ALL THIRD PARTY CONTENT OR SERVICES ACCESSIBLE VIA THIS DEVICE IS PROVIDED TO YOU ON AN "AS-IS" AND "AS AVAILABLE" BASIS AND SHARP AND ITS AFFILIATES MAKE NO WARRANTY OR REPRESENTATION OF ANY KIND TO YOU, EITHER EXPRESS OR IMPLIED, INCLUDING, WITHOUT LIMITATION, ANY WARRANTIES OF MERCHANTABILITY, NON-INFRINGEMENT, FITNESS FOR A PARTICULAR PURPOSE OR ANY WARRANTIES OF SUITABILITY, AVAILABILITY, ACCURACY, COMPLETENESS, SECURITY, TITLE, USEFULNESS, LACK OF NEGLIGENCE OR ERROR-FREE OR UNINTERRUPTED OPERATION OR USE OF THE CONTENT OR SERVICES PROVIDED TO YOU OR THAT THE CONTENT OR SERVICES WILL MEET YOUR REQUIREMENTS OR EXPECTATIONS.

SHARP IS NOT AN AGENT OF AND ASSUMES NO RESPONSIBILITY FOR THE ACTS OR OMISSIONS OF THIRD PARTY CONTENT OR SERVICE PROVIDERS, NOR ANY ASPECT OF THE CONTENT OR SERVICE RELATED TO SUCH THIRD PARTY PROVIDERS.

IN NO EVENT WILL SHARP AND/OR ITS AFFILIATES BE LIABLE TO YOU OR ANY THIRD PARTY FOR ANY DIRECT, INDIRECT, SPECIAL, INCIDENTAL, PUNITIVE, CONSEQUENTIAL OR OTHER DAMAGES, WHETHER THE THEORY OF LIABILITY IS BASED ON CONTRACT, TORT, NEGLIGENCE, BREACH OF WARRANTY, STRICT LIABILITY OR OTHERWISE AND WHETHER OR NOT SHARP AND/OR ITS AFFILIATES HAVE BEEN ADVISED OF THE POSSIBILITY OF SUCH DAMAGES.

About Software License

Information on the Software License for This Product

Software composition

The software included in this product is comprised of various software components whose individual copyrights are held by SHARP or by third parties.

Software developed by SHARP and open source software

The copyrights for the software components and various relevant documents included with this product that were developed or written by SHARP are owned by SHARP and are protected by the Copyright Act, international treaties, and other relevant laws. This product also makes use of freely distributed software and software components whose copyrights are held by third parties. These include software components covered by a GNU General Public License (hereafter GPL), a GNU Lesser General Public License (hereafter LGPL) or other license agreement.

Obtaining source code

Some of the open source software licensors require the distributor to provide the source code with the executable software components. GPL and LGPL include similar requirements. For information on obtaining the source code for the open source software and for obtaining the GPL, LGPL, and other license agreement information, visit the following website:

<http://www.sharppusa.com/gpl>

We are unable to answer any questions about the source code for the open source software. The source code for the software components whose copyrights are held by SHARP is not distributed.

Acknowledgements

The following open source software components are included in this product:

- linux kernel • uClibc • OpenSSL • modutils • DirectFB • zlib • busybox • bash • freetype • libjpeg • libmpeg2 • libxml2
- libpng • libsysfs • mtd/jffs2 • ncurses • Qt/Embedded

Software License Notice

Software License Notice Requirements

The software components incorporated into this product include components whose copyright holders require license notices. The license notices for these software components are shown below.

OpenSSL License

This product includes software developed by the OpenSSL Project for use in the OpenSSL Toolkit. (<http://www.openssl.org>)

Original SSLeay License

This product includes cryptographic software written by Eric Young (eyay@cryptsoft.com).

BSD License

This product includes software developed by the University of California, Berkeley and its contributors.

CONSUMER LIMITED WARRANTY

(Valid for warranty service in the U.S. and PUERTO RICO only)

CONSUMER LIMITED WARRANTY

SHARP ELECTRONICS CORPORATION warrants to the first consumer purchaser that this Sharp brand product (the "Product"), when shipped in its original container, will be free from defective workmanship and materials, and agrees that it will, at its option, either repair the defect or replace the defective Product or part thereof with a new or remanufactured equivalent at no charge to the purchaser for parts or labor for the period(s) set forth below.

This warranty does not apply to any appearance items of the Product or if the serial number or model number affixed to the Product has been removed, defaced, changed, altered or tampered with. This warranty does not cover installation or signal reception problems. This limited warranty will not apply if the Product has been or is being used in a commercial setting or application; this warranty is meant solely for the non-commercial, household use of the Product by consumers in their home or residence.

In order to enforce the rights under this limited warranty, the purchaser should follow the steps set forth below and provide proof of purchase to the servicer.

To the extent permitted by applicable state law, the warranties set forth are in lieu of, and exclusive of, all other warranties, express or implied. Specifically ALL OTHER WARRANTIES OTHER THAN THOSE SET FORTH ABOVE ARE EXCLUDED, ALL EXPRESS AND IMPLIED WARRANTIES INCLUDING THE WARRANTIES OF MERCHANTABILITY, FITNESS FOR USE, AND FITNESS FOR A PARTICULAR PURPOSE ARE SPECIFICALLY EXCLUDED. IF, UNDER APPLICABLE STATE LAW, IMPLIED WARRANTIES MAY NOT VALIDLY BE DISCLAIMED OR EXCLUDED, THE DURATION OF SUCH IMPLIED WARRANTIES IS LIMITED TO THE PERIOD(S) FROM THE DATE OF PURCHASE SET FORTH BELOW. THIS WARRANTY GIVES YOU SPECIFIC LEGAL RIGHTS. YOU MAY ALSO HAVE OTHER RIGHTS WHICH VARY FROM STATE TO STATE.

The warranties given herein shall be the sole and exclusive warranties granted by Sharp and shall be the sole and exclusive remedy available to the purchaser and only for the time periods set forth herein. No other representations or promises made by anyone are permitted. Correction of defects, in the manner and for the period of time described herein, shall constitute complete fulfillment of all liabilities and responsibilities of Sharp to the purchaser with respect to the Product, and shall constitute full satisfaction of all claims, whether based on contract, negligence, strict liability or otherwise. Sharp does not warrant nor shall Sharp be liable, or in any way responsible, for Products which have been subject to abuse (including, but not limited to, improper voltage), accident, misuse, negligence, lack of reasonable care, alteration, modification, tampering, improper operation or maintenance or any damages or defects in the Product which were caused by repairs or attempted repairs performed by anyone other than a Sharp authorized servicer. Nor shall Sharp be liable or in any way responsible for any incidental or consequential economic or property damage. Some states do not allow limits on warranties or on remedies for breach in certain transactions; in such states, the limits herein may not apply.

THIS LIMITED WARRANTY IS VALID ONLY IN THE FIFTY (50) UNITED STATES, THE DISTRICT OF COLUMBIA, AND PUERTO RICO

Model Specific Section

Your Product Model Number & Description:

BD-MPC41U HOME THEATER WITH BLU-RAY DISC/DVD PLAYER
(Be sure to have this information available when you need service for your Product.)

Warranty Period for this Product:

One (1) year parts and labor from the date of purchase.

Additional Item(s) Excluded from Warranty Coverage (if any):

Non-rechargeable batteries.

Where to Obtain Service:

From a Sharp Authorized Servicer located in the United States. To find the location of the nearest Sharp Authorized Servicer, call Sharp toll free at 1-800-BE-SHARP.

What to do to Obtain Service:

Please transport the Product in its original packaging and ensure that the Product is covered to avoid scratches and damage. Sharp shall not be responsible for lost, stolen or misdirected mail or for damage to the product incurred during shipping.

TO OBTAIN PRODUCT INFORMATION, CALL 1-800-BE-SHARP OR VISIT www.sharppusa.com

SHARP®

SHARP ELECTRONICS CORPORATION

Sharp Plaza, Mahwah, New Jersey 07495-1163

SHARP CORPORATION

Printed in Malaysia
Imprimé en Malaisie
Impreso en Malasia

TINS-E595WJQZ
10P02-MA-NM

Free Manuals Download Website

<http://myh66.com>

<http://usermanuals.us>

<http://www.somanuals.com>

<http://www.4manuals.cc>

<http://www.manual-lib.com>

<http://www.404manual.com>

<http://www.luxmanual.com>

<http://aubethermostatmanual.com>

Golf course search by state

<http://golfingnear.com>

Email search by domain

<http://emailbydomain.com>

Auto manuals search

<http://auto.somanuals.com>

TV manuals search

<http://tv.somanuals.com>