

SHARP

MICRO COMPONENT SYSTEM

MODEL

XL-UH242

OPERATION MANUAL

COMPACT
disc
DIGITAL AUDIO

MP3

USB
TERMINAL



Note:

This product is not compatible with MTP and AAC file systems.

Thank you for purchasing this SHARP product.
To obtain the best performance from this product, please read this manual carefully. It will guide you in operating your SHARP product.

XL-UH242 Micro Component System consisting of XL-UH242 (main unit) and CP-UH242 (speaker system).

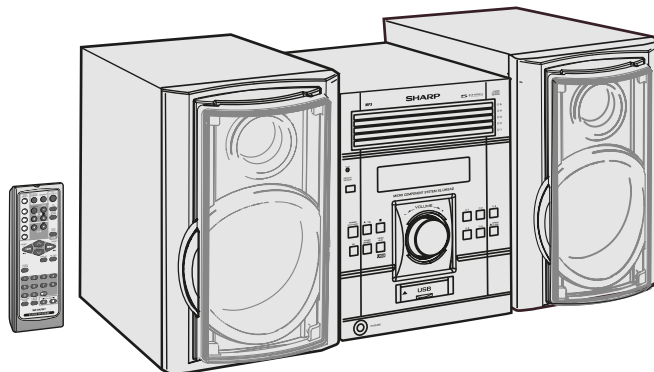

CD-R/RW
Playable

5-DISC
CHANGER

Accessories

Please confirm that the following accessories are included.

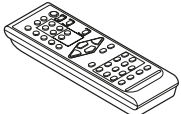
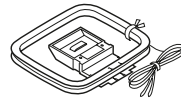
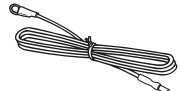
		
Remote control × 1 (RRMCGA081AWSA)	AM loop antenna × 1 (QANTL0010AWZZ)	FM antenna × 1 (92LFANT1535A)

Note:

Only the above accessories are included.

SPECIAL NOTES

Important Instruction



CAUTION
RISK OF ELECTRIC SHOCK
DO NOT OPEN



CAUTION: TO REDUCE THE RISK OF ELECTRIC SHOCK, DO NOT REMOVE COVER (OR BACK). NO USER-SERVICEABLE PARTS INSIDE. REFER SERVICING TO QUALIFIED SERVICE PERSONNEL.

Explanation of Graphical Symbols:



The lightning flash with arrowhead symbol, within an equilateral triangle, is intended to alert the user to the presence of uninsulated "dangerous voltage" within the product's enclosure that may be of sufficient magnitude to constitute a risk of electric shock to persons.



The exclamation point within an equilateral triangle is intended to alert the user to the presence of important operating and maintenance (servicing) instructions in the literature accompanying the appliance.

WARNING: TO REDUCE THE RISK OF FIRE OR ELECTRIC SHOCK, DO NOT EXPOSE THIS APPLIANCE TO RAIN OR MOISTURE.

Caution - use of controls or adjustments or performance of procedures other than those specified herein may result in hazardous radiation exposure.

Note to CATV system installer:

This reminder is provided to call the CATV system installer's attention to Article 820-40 of the National Electrical Code that provides guidelines for proper grounding and, in particular, specifies that the cable ground shall be connected to the grounding system of the building, as close to the point of cable entry as practical.

DECLARATION OF CONFORMITY

SHARP MICRO COMPONENT SYSTEM, MODEL XL-UH242
This device complies with Part 15 of the FCC Rules. Operation is subject to the following two conditions:

(1) This device may not cause harmful interference, and (2) this device must accept any interference received, including interference that may cause undesired operation.

RESPONSIBLE PARTY:

SHARP ELECTRONICS CORPORATION
Sharp Plaza, Mahwah, New Jersey 07430-2135
TEL : 1-800-BE-SHARP

For Business Customers : URL <http://www.sharppusa.com>

NOTE

This equipment has been tested and found to comply with the limits for a Class B digital device, pursuant to Part 15 of the FCC Rules. These limits are designed to provide reasonable protection against harmful interference in a residential installation. This equipment generates, uses, and can radiate radio frequency energy and, if not installed and used in accordance with the instructions, may cause harmful interference to radio communications. However, there is no guarantee that interference will not occur in a particular installation. If this equipment does cause harmful interference to radio or television reception, which can be determined by turning the equipment off and on, the user is encouraged to try to correct the interference by one or more of the following measures:

- Reorient or relocate the receiving antenna.
- Increase the separation between the equipment and receiver.
- Connect the equipment into an outlet on a circuit different from that to which the receiver is connected.
- Consult the dealer or an experienced radio/TV technician for help.

WARNING

FCC Regulations state that any unauthorized changes or modifications to this equipment not expressly approved by the manufacturer could void the user's authority to operate this equipment.

Note:

- Licensed under one or more of U.S. Pat. 4,972,484, 5,214,678, 5,323,396, 5,530,655, 5,539,829, 5,544,247, 5,606,618, 5,610,985, 5,740,317, 5,777,992, 5,878,080 or 5,960,037.

FOR YOUR RECORDS

For your assistance in reporting this unit in case of loss or theft, please record below the model number and serial number which are located on the rear of the unit.

Please retain this information.

Model number
 Serial number
 Date of purchase
 Place of purchase.....

IMPORTANT SAFETY INSTRUCTIONS

XL-UH242

Important Instruction

- 1 Read Instructions** - All the safety and operating instructions should be read before the product is operated.
- 2 Retain Instructions** - The safety and operating instructions should be retained for future reference.
- 3 Heed Warnings** - All warnings on the product and in the operating instructions should be adhered to.
- 4 Follow Instructions** - All operating and use instructions should be followed.
- 5 Cleaning** - Unplug this product from the wall outlet before cleaning. Do not use liquid cleaners or aerosol cleaners. Use a damp cloth for cleaning.
- 6 Attachments** - Do not use attachments not recommended by the product manufacturer as they may cause hazards.
- 7 Water and Moisture** - Do not use this product near water - for example, near a bath tub, wash bowl, kitchen sink, or laundry tub; in a wet basement; or near a swimming pool; and the like.
- 8 Accessories** - Do not place this product on an unstable cart, stand, tripod, bracket, or table. The product may fall, causing serious injury to a child or adult, and serious damage to the product. Use only with a cart, stand, tripod, bracket, or table recommended by the manufacturer, or sold with the product. Any mounting of the product should follow the manufacturer's instructions, and should use a mounting accessory recommended by the manufacturer.
- 9** A product and cart combination should be moved with care. Quick stops, excessive force, and uneven surfaces may cause the product and cart combination to overturn.



- 10 Ventilation** - Slots and openings in the cabinet are provided for ventilation and to ensure reliable operation of the product and to protect it from overheating, and these openings must not be blocked or covered. The openings should never be blocked by placing the product on a bed, sofa, rug, or other similar surface. This product should not be placed in a built-in installation such as a bookcase or rack unless proper ventilation is provided or the manufacturer's instructions have been adhered to.
- 11 Power Sources** - This product should be operated only from the type of power source indicated on the marking label. If you are not sure of the type of power supply to your home, consult your product dealer or local power company. For products intended to operate from battery power, or other sources, refer to the operating instructions.
- 12 Grounding or Polarization** - This product may be equipped with a polarized alternating-current line plug (a plug having one blade wider than the other). This plug will fit into the power outlet only one way. This is a safety feature. If you are unable to insert the plug fully into the outlet, try reversing the plug. If the plug should still fail to fit, contact your electrician to replace your obsolete outlet. Do not defeat the safety purpose of the polarized plug.
Alternate Warnings - This product is equipped with a three-wire grounding-type plug, a plug having a third (grounding) pin. This plug will only fit into a grounding-type power outlet. This is a safety feature. If you are unable to insert the plug into the outlet, contact your electrician to replace your obsolete outlet. Do not defeat the safety purpose of the grounding-type plug.
- 13 Power-Cord Protection** - Power-supply cords should be routed so that they are not likely to be walked on or pinched by items placed upon or against them.
- 14 Protective Attachment Plug** - The product is equipped with an attachment plug having overload protection. This is a safety feature. See Instruction Manual for replacement or resetting of protective device. If replacement of the plug is required, be sure the service technician has used a replacement plug specified by the manufacturer that has the same overload protection as the original plug.

IMPORTANT SAFETY INSTRUCTIONS (continued)

- 15 Outdoor Antenna Grounding** - If an outside antenna or cable system is connected to the product, be sure the antenna or cable system is grounded so as to provide some protection against voltage surges and built-up static charges. Article 810 of the National Electrical Code, ANSI/NFPA 70, provides information with regard to proper grounding of the mast and supporting structure, grounding of the lead-in wire to an antenna discharge unit, size of grounding conductors, location of antenna discharge unit, connection to grounding electrodes, and requirements for the grounding electrode.

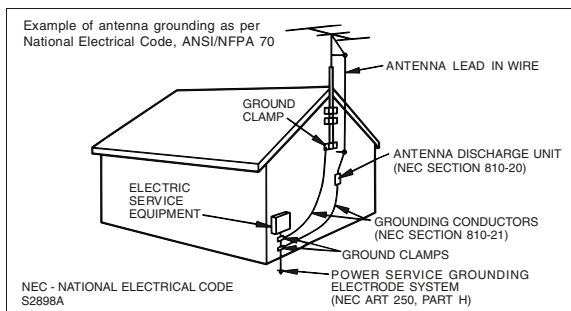

- 16 Lightning** - For added protection for this product during a lightning storm, or when it is left unattended and unused for long periods of time, unplug it from the wall outlet and disconnect the antenna or cable system. This will prevent damage to the product due to lightning and power-line surges.
- 17 Power Lines** - An outside antenna system should not be located in the vicinity of overhead power lines or other electric light or power circuits, or where it can fall into such power lines or circuits. When installing an outside antenna system, extreme care should be taken to keep from touching such power lines or circuits as contact with them might be fatal.
- 18 Overloading** - Do not overload wall outlets, extension cords, or integral convenience receptacles as this can result in a risk of fire or electric shock.

- 19 Object and Liquid Entry** - Never push objects of any kind into this product through openings as they may touch dangerous voltage points or short-out parts that could result in a fire or electric shock. Never spill liquid of any kind on the product.

- 20 Servicing** - Do not attempt to service this product yourself as opening or removing covers may expose you to dangerous voltage or other hazards. Refer all servicing to qualified service personnel.

- 21 Damage Requiring Service** - Unplug this product from the wall outlet and refer servicing to qualified service personnel under the following conditions:

- When the power-supply cord or plug is damaged,
- If liquid has been spilled, or objects have fallen into the product,
- If the product has been exposed to rain or water,
- If the product does not operate normally by following the operating instructions. Adjust only those controls that are covered by the operating instructions as an improper adjustment of other controls may result in damage and will often require extensive work by a qualified technician to restore the product to its normal operation,
- If the product has been dropped or damaged in any way, and
- When the product exhibits a distinct change in performance - this indicates a need for service.

- 22 Replacement Parts** - When replacement parts are required, be sure the service technician has used replacement parts specified by the manufacturer or have the same characteristics as the original part. Unauthorized substitutions may result in fire, electric shock, or other hazards.

- 23 Safety Check** - Upon completion of any service or repairs to this product, ask the service technician to perform safety checks to determine that the product is in proper operating condition.

- 24 Wall or Ceiling Mounting** - The product should be mounted to a wall or ceiling only as recommended by the manufacturer.

- 25 Heat** - The product should be situated away from heat sources such as radiators, heat registers, stoves, or other products (including amplifiers) that produce heat.

ENERGY STAR® Program Information



Products that have earned the ENERGY STAR® are designed to protect the environment through superior energy efficiency.

To comply with the ENERGY STAR® standards mentioned above, please cancel the demonstration mode, as described on page 12.

ENERGY STAR® is a U.S. registered mark.

Special Note

Supply of this product does not convey a license nor imply any right to distribute content created with this product in revenue-generating broadcast systems (terrestrial, satellite, cable and/or other distribution channels), revenue-generating streaming applications (via Internet, intranets and/or other networks), other revenue-generating content distribution systems (pay-audio or audio-on-demand applications and the like) or on revenue-generating physical media (compact discs, digital versatile discs, semiconductor chips, hard drives, memory cards and the like). An independent license for such use is required. For details, please visit <http://mp3licensing.com>. MPEG Layer-3 audio coding technology licensed from Fraunhofer IIS and Thomson.

Contents

	Page
■ General Information	
Precautions	6
Controls and indicators	7 - 9
■ Preparation for Use	
System connections	10 - 12
Remote control	13
■ Basic Operation	
General control	14
Setting the clock (Remote Control only)	15
■ CD or MP3/WMA disc Playback	
Listening to a CD or MP3/WMA disc	16 - 18
Advanced CD or MP3/WMA disc playback	19 - 20
Advanced CD playback	21
MP3/WMA folder mode (only for MP3/WMA files)	22 - 23
■ USB Memory Playback	
Listening to USB mass storage device / MP3 Player	24 - 25
To remove USB memory device	25
Advanced USB playback	26
■ Radio	
Listening to the radio	27 - 28
■ Advanced Features	
Timer and sleep operation (Remote Control only)	29 - 32
Enhancing your system	33 - 34
■ References	
Troubleshooting chart	34 - 36
Maintenance	36
Specifications	37
CONSUMER LIMITED WARRANTY	Back cover

Precautions

■ General

- Please ensure that the equipment is positioned in a well-ventilated area and ensure that there is at least 4" (10 cm) of free space along the sides, top and back of the equipment.

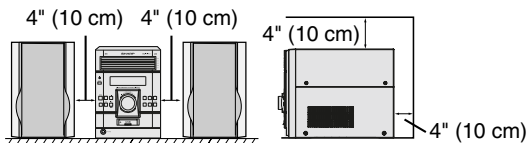

- Use the unit on a firm, level surface free from vibration.

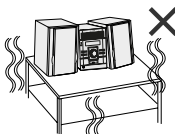

- Keep the unit away from direct sunlight, strong magnetic fields, excessive dust, humidity and electronic/electrical equipment (home computers, facsimiles, etc.) which generate electrical noise.



- Do not place anything on top of the unit.
- Do not expose the unit to moisture, to temperatures higher than 140°F (60°C) or to extremely low temperatures.
- If your system does not work properly, disconnect the AC power cord from the AC outlet. Plug the AC power cord back in, and then turn on your system.
- In case of an electrical storm, unplug the unit for safety.

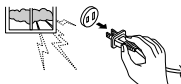

- Hold the AC power plug by the head when removing it from the AC outlet, as pulling the cord can damage internal wires.



- Do not remove the outer cover, as this may result in electric shock. Refer internal service to your local SHARP service facility.

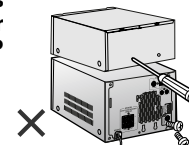

- This unit should only be used within the range of 41°F - 95°F (5°C - 35°C).

Warning:

The voltage used must be the same as that specified on this unit. Using this product with a higher voltage other than that which is specified is dangerous and may result in a fire or other type of accident causing damage. SHARP will not be held responsible for any damage resulting from use of this unit with a voltage other than that which is specified.

■ Volume control

The sound level at a given volume setting depends on speaker efficiency, location and various other factors. It is advisable to avoid exposure to high volume levels, which occurs while turning the unit on with the volume control setting up high, or while continually listening at high volumes.

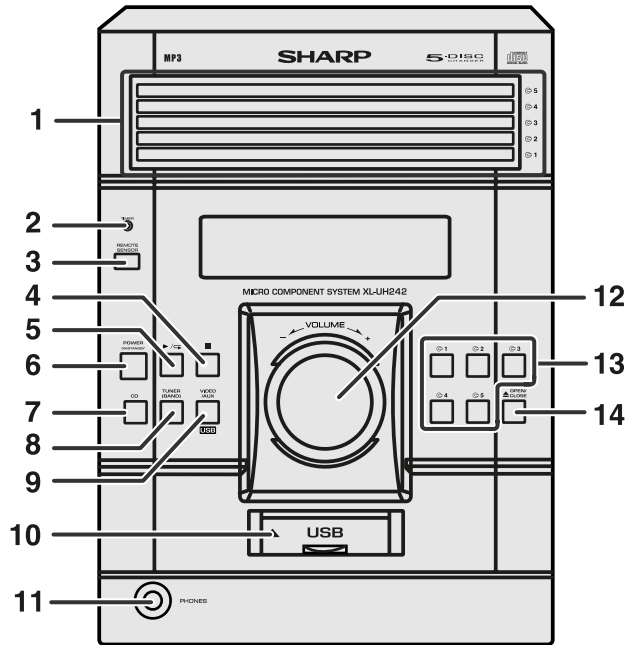

■ Front panel

	Reference page
1. Disc Trays	17
2. Timer Indicator	30
3. Remote Sensor	13
4. Disc or USB Stop Button	18
5. Disc or USB Play or Repeat Button	16, 20
6. Power ON/STANDBY Button	14
7. CD Button	16
8. Tuner (Band) Button	27
9. Video/Auxiliary/USB Button	33
10. USB Terminal	24
11. Headphone Jack	33
12. Volume Control	14
13. Disc Number Select Buttons	16
14. Disc Tray Open/Close Button	16

Controls and indicators (continued)

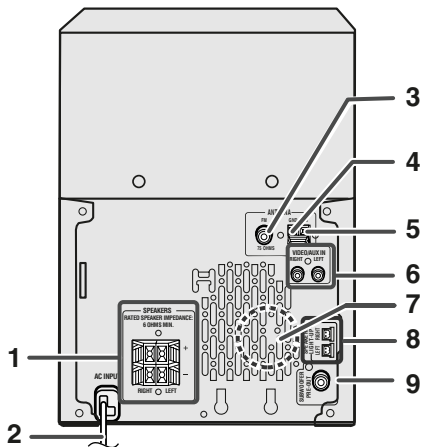
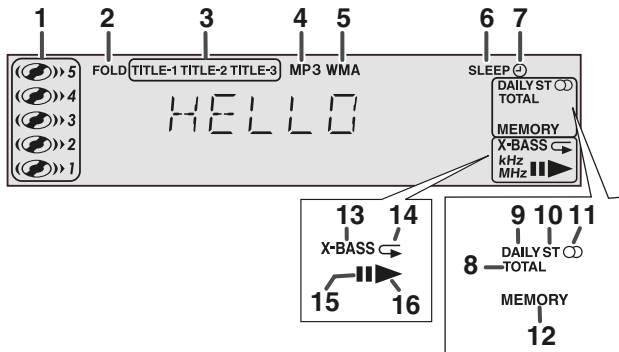

■ Display

	Reference page
1. Disc Number Indicators	21
2. MP3/WMA Folder Indicator	23
3. MP3/WMA Title Indicators	23
4. MP3 Indicator	17
5. WMA Indicator	17
6. Sleep Indicator	32
7. Timer Play Indicator	30
8. MP3/WMA Total Indicator	23
9. Daily Timer Indicator	30
10. FM Stereo Mode Indicator	27
11. FM Stereo Receiving Indicator	27
12. Memory Indicator	21
13. Extra Bass Indicator	14
14. Disc or USB Repeat Play Indicator	20, 26
15. Disc or USB Pause Indicator	18
16. Disc or USB Play Indicator	17, 26

■ Rear panel

	Reference page
1. Speaker Terminals	11
2. AC Power Cord	12
3. FM 75 Ohms Antenna Jack	11
4. AM Antenna Ground Terminal	11
5. AM Loop Antenna Terminal	11
6. Video/Auxiliary (Audio Signal) Input Jacks	33
7. Cooling Fan	12
8. Speaker Light-up Jacks	11
9. Subwoofer Pre-output Jack	34

■ Speaker system

1. Tweeter
2. Woofer
3. Bass Reflex Duct
4. Speaker Wire

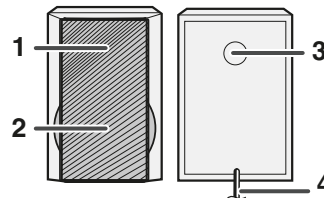

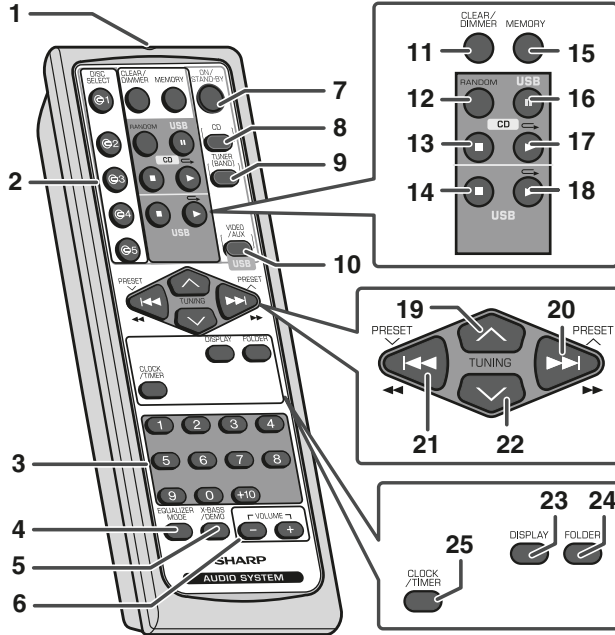

■ Remote control

	Reference page
1. Remote Control Transmitter	13
2. Disc Number Select Buttons	16
3. Disc Direct Search Buttons	19
4. Equalizer Mode Select Button	14
5. Extra Bass/Demo Button	14
6. Volume Up and Down Buttons	14
7. Power On/Stand-by Button	14
8. CD Button	16
9. Tuner (Band) Button	27
10. Video/Auxiliary/USB Button	24
11. Disc Clear/Dimmer Button	14, 21
12. Disc Random Button	20, 26
13. Disc Stop Button	18
14. USB Stop Button	24
15. Memory Button	15, 21, 28, 32
16. Disc/USB Pause Button	18
17. Disc Play or Repeat Button	16, 20
18. USB Play or Repeat Button	24
19. Tuning Up Button	27
20. CD Track Up or Fast Forward, Tuner Preset Up, Time Up Button	15, 23, 24, 28, 29, 32
21. CD Track Down or Fast Reverse, Tuner Preset Down, Time Down Button	15, 23, 24, 28, 29, 32
22. Tuning Down Button	27
23. Display Button	23, 24
24. Folder Button	23, 24
25. Clock/Timer Button	15, 29, 32

System connections

Make sure to unplug the AC power cord before any connections.

■ Antenna connection (see page 11)

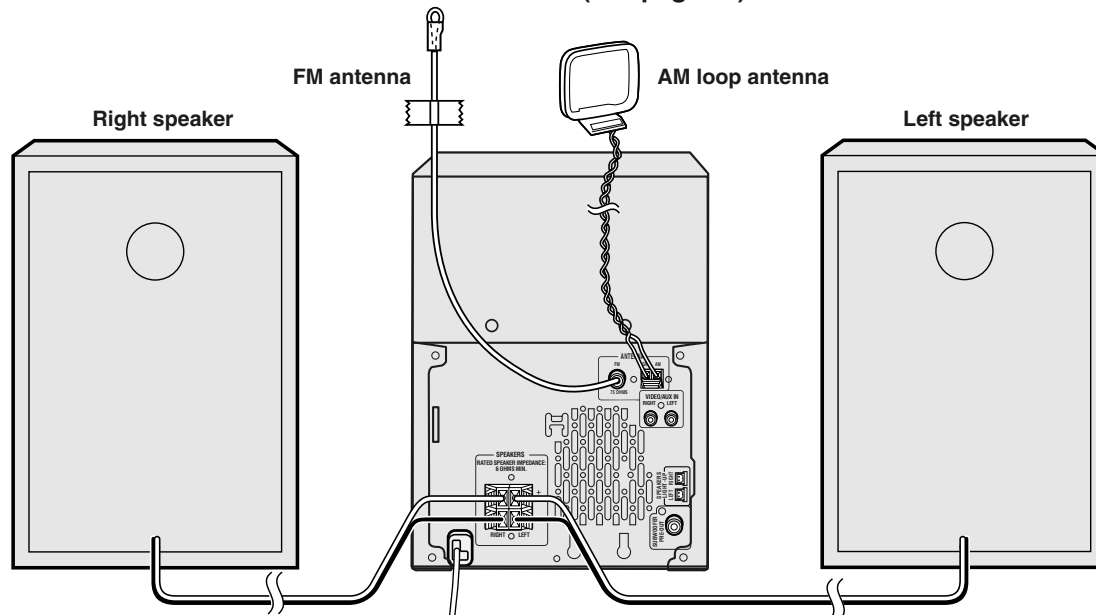

■ Speaker connection (see page 11)

AC outlet
(AC 120 V, 60 Hz)

■ AC power connection (see page 12)

■ Antenna connection

Supplied FM antenna:

Connect the FM antenna wire to the FM 75 OHMS jack and position the FM antenna wire in the direction where the strongest signal can be received.

Supplied AM loop antenna:

Connect the AM loop antenna to the AM and GND terminals. Position the AM loop antenna for optimum reception. Place the AM loop antenna on a shelf, etc., or attach it to a stand or a wall with screws (not supplied).

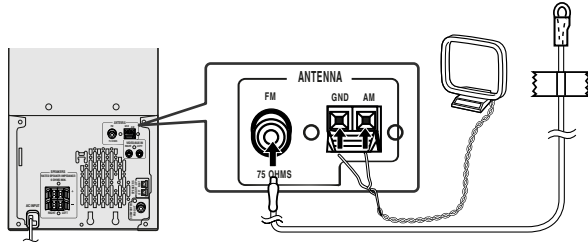

Note:

Placing the antenna on the unit or near the AC power cord may cause noise pickup. Place the antenna away from the unit for better reception.

Installing the AM loop antenna:

< Assembling >

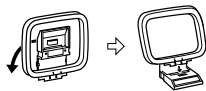

< Attaching to the wall >

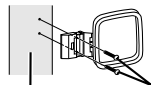

Wall Screws (not supplied)

■ Speaker connection

Connect the black wire to the minus (-) terminal, and the red wire to the plus (+) terminal.

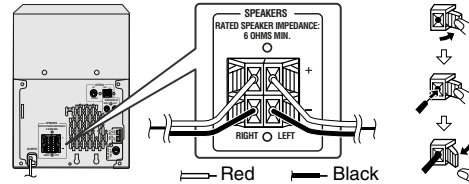

Caution:

- Use speakers with an impedance of 6 ohms or more, as lower impedance speakers can damage the unit.
- Do not mistake the right and the left channels. The right speaker is the one on the right side when you face the unit.
- **Do not let the bare speaker wires touch each other.**
- Do not allow any objects to fall into or to be placed in the bass reflex ducts.
- Do not stand or sit on the speakers. You may be injured.

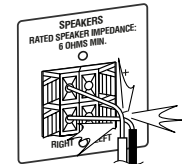

Incorrect

■ Speaker grilles are removable

Make sure nothing comes into contact with the speaker diaphragm when you remove the speaker grilles.

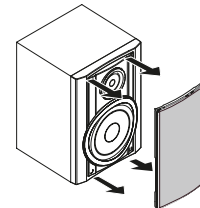

System connections (continued)

■ AC power connection

After checking all the connections have been made correctly, plug the AC power cord of this unit into the AC outlet. If you plug in the unit first, the unit will enter the demonstration mode.

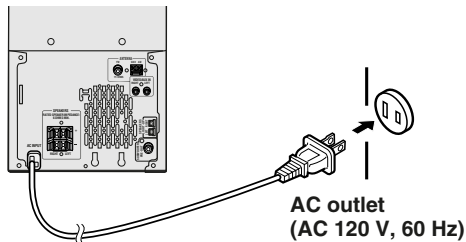

Note:

- Unplug the AC power cord from the AC outlet if the unit will not be in use for a prolonged period of time.

Cooling fan:

The main unit is built with a cooling fan at the rear of the unit for improved cooling. Please do not cover the opening of the fan with any obstacles, as this will block proper ventilation.

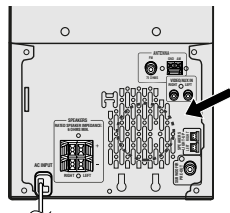

■ Demonstration mode

The first time the unit is plugged in, the unit will enter the demonstration mode. You will see words scroll.



To cancel the demonstration mode:

When the unit is in the power stand-by mode (demonstration mode), press the X-BASS/DEMO button. The unit will enter the low power consumption mode.

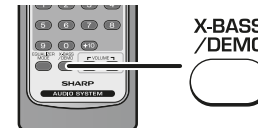

To return to the demonstration mode:

When the unit is in the power stand-by mode, press the X-BASS/DEMO button again.

Note:

When the power is on, the X-BASS/DEMO button can be used to select the extra bass mode.

■ Outdoor FM antenna

Use an outdoor FM antenna if you require better reception. Consult your dealer.

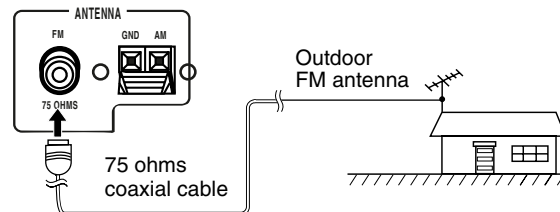

Note:

When an outdoor FM antenna is used, disconnect the supplied FM antenna wire.

Remote control

■ Battery installation

Use 2 "AA" size batteries (UM/SUM-3, R6, HP-7 or similar).
Batteries are not included.

- 1 **Open the battery cover.**
- 2 **Insert the batteries according to the direction indicated in the battery compartment.**
When inserting or removing the batteries, push them toward the ⊖ battery terminals.
- 3 **Close the cover.**

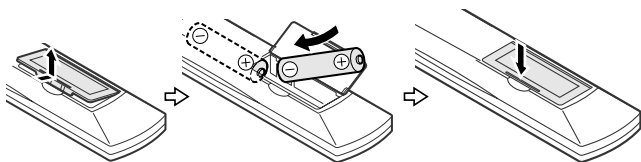

Precautions for battery use:

- Replace all old batteries with new ones at the same time.
- Do not mix old and new batteries.
- Remove the batteries if the unit will not be used for long periods of time. This will prevent potential damage due to battery leakage.

Caution:

- Do not use rechargeable batteries (nickel-cadmium battery, etc.).
- Installing the batteries incorrectly may cause the unit to malfunction.

Battery removal:

Open the battery cover and pull up the battery to take out.

Notes concerning use:

- Replace the batteries if the operating distance is reduced or if the operation becomes erratic.
- Periodically clean the transmitter on the remote control and the sensor on the unit with a soft cloth.
- Exposing the sensor on the unit to strong light may interfere with operation. Change the lighting or the direction of the unit if this occurs.
- Keep the remote control away from moisture, heat, shock, and vibrations.

■ Test of the remote control

Check the remote control after checking all the connections (see pages 10 - 12).
Point the remote control directly at the remote sensor.

The remote control can be used within the range shown below:
Press the ON/STAND-BY button. Does the power turn on? Now, you can enjoy music.

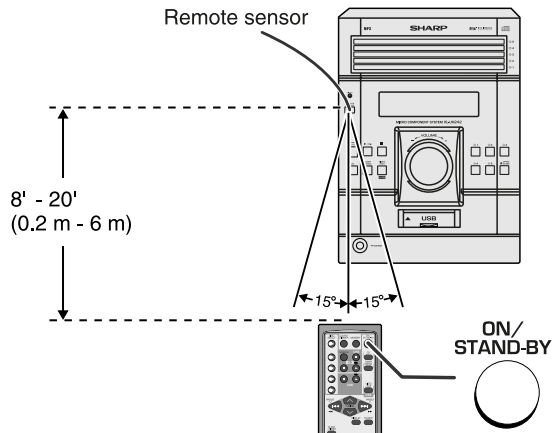

General control

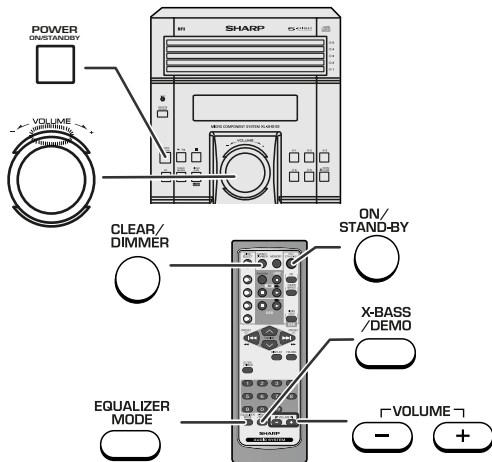

■ To turn the power on

Press the ON/STAND-BY button to turn the power on.

After use:

Press the ON/STAND-BY button to enter the power stand-by mode.

■ Illumination light control

When the power is turned on, ring around the volume control light up. To turn on/off the light, hold down the CLEAR/DIMMER button on the remote control for more than 2 seconds.

■ Volume auto fade-in

If you turn off and on the main unit with the volume set to 27 or higher, the volume starts at 16 and fades in to the last set level.

■ Volume control

Main unit operation:

When the VOLUME control is turned clockwise, the volume will increase. When it is turned counterclockwise, the volume will decrease.

Remote control operation:

Press the VOLUME (+ or -) button to increase or decrease the volume.



■ Bass control

When the power is first turned on, the unit will enter the extra bass mode which emphasizes the bass frequencies, and "X-BASS" will appear. To cancel the extra bass mode, press the X-BASS/DEMO button on the remote control.

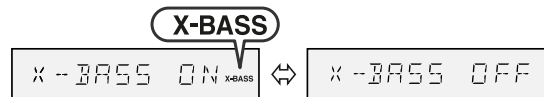

■ Equalizer

When the EQUALIZER MODE button is pressed, the current mode setting will be displayed. To change to a different mode, press the EQUALIZER MODE button repeatedly until the desired sound mode appears.

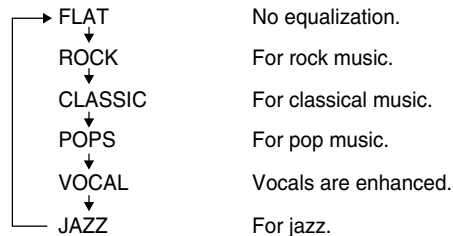

Setting the clock (Remote Control only)

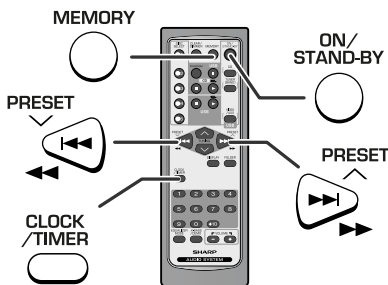

In this example, the clock is set for the 12-hour (AM 12:00) display.

<p>1 Press the ON/STAND-BY button to turn the power on.</p>
<p>2 Press the CLOCK/TIMER button.</p>
<p>3 Within 10 seconds, press the <<<< or >>>> button to select "CLOCK", and press the MEMORY button.</p> <div style="text-align: center; margin: 5px 0;"> </div>
<p>4 Press the <<<< or >>>> button to select 12-hour or 24-hour display and then press the MEMORY button.</p> <div style="text-align: center; margin: 5px 0;"> </div> <div style="text-align: center; margin: 5px 0;"> </div> <p>"AM 12:00" → The 12-hour display will appear. (AM 12:00 - PM 11:59)</p> <p>"AM 0:00" → The 12-hour display will appear. (AM 0:00 - PM 11:59)</p> <p>"0:00" → The 24-hour display will appear. (0:00 - 23:59)</p>

5 Press the <<<< or >>>> button to adjust the hour and then press the MEMORY button.



Press the <<<< or >>>> button once to advance the time by 1 hour. Hold it down to advance continuously.

6 Press the <<<< or >>>> button to adjust the minutes and then press the MEMORY button.

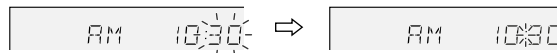

Press the <<<< or >>>> button once to advance the time by 1 minute. Hold it down to change the time in 5-minute intervals.

To confirm the time display:

[When the unit is in the stand-by mode]

Press the CLOCK/TIMER button.

The time display will appear for about 10 seconds.

[When the power is on]

Press the CLOCK/TIMER button.

Within 10 seconds, press the <<<< or >>>> button to display the time.

The time display will appear for about 10 seconds.

Note:

The "CLOCK" will appear or time will flash to confirm the time display when the AC power supply is restored after a power failure or unplugging the unit. If incorrect, readjust the clock as follows.

To readjust the clock:

Perform "Setting the clock" from step 1. If the "CLOCK" does not appear in step 3, step 4 (for selecting the 12-hour or 24-hour display) will be skipped.

To change the 12-hour or 24-hour display:

- 1 Clear all the programmed contents. [Refer to "Clearing all the memory (reset)" on page 35 for details.]
- 2 Perform "Setting the clock" from step 1.

Listening to a CD or MP3/WMA disc

This system can play back a standard CD, CD-R/RW in the CD format and CD-R/RW with MP3 or WMA files, but cannot record on them. Some audio CD-R and CD-RW discs may not be playable due to the state of the disc or the device that was used for recording.

MP3:

MP3 is a form of compression. It is an acronym which stands for MPEG Audio Layer 3.

MP3 is a type of audio code which is processed by significant compression from the original audio source with very little loss in sound quality.

- This system supports MPEG 1 Layer 3, MPEG 2 Layer 3, and VBR files.
- During VBR file playback, time counter in the display may differ from its actual playback time.
- Bitrate which is supported by MP3 is 32 ~ 320 kbps.

WMA:

WMA files are Advanced System Format files that include audio files which are compressed with Windows Media Audio codec. WMA is developed by Microsoft as an audio format file for Windows Media Player.

- "MP3" and "WMA" indicator will light up after the unit reads information on an MP3 or WMA disc.
- Bitrate which is supported by WMA is 64 ~ 160 kbps.

Auto power on function:

When you press any of the following buttons, the unit turns on.

- CD button (main unit and remote control): The unit turns on and the "CD" function is activated.
- CD ► / ◀ button on the remote control: The unit turns on and CD playback starts (regardless of the last function).
- ► / ◀ button on the main unit: The unit turns on and playback of the last function starts (CD, TUNER, VIDEO/AUX/USB).

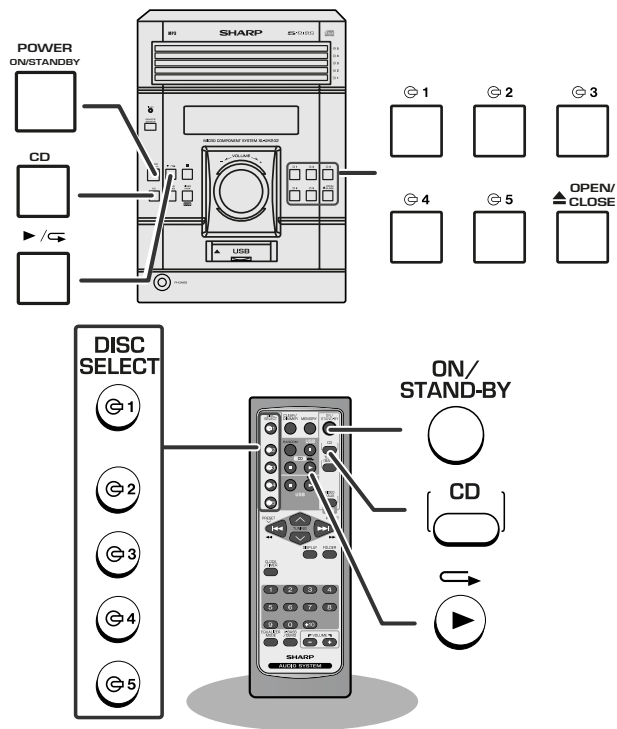

Auto power off function:

In the stop mode of CD, MP3 or WMA operation, the main unit enters the stand-by mode after 15 minutes of inactivity.





1 Press the ON/STAND-BY button to turn the power on.

2 Press the CD button.

3 Press the  1 button and within 5 seconds, press the  OPEN/CLOSE button to open the disc tray 1.

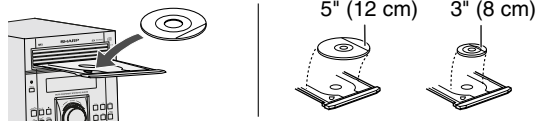
4 Place the disc on the disc tray 1, label side up.
Be sure to place 3" (8 cm) disc in the middle of the disc trays.



5 Press the  OPEN/CLOSE button to close the disc tray 1.

[CD]

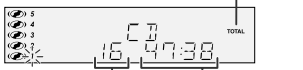

Total number of tracks on the disc Total playing time of the disc

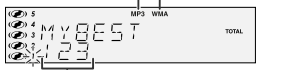

[MP3/WMA]



Total number of files

- Due to the structure of the disc information, it takes longer to read an MP3/WMA disc than a normal CD (approximately 20 to 90 seconds).



6 You can place discs on the trays 2 - 5 by following steps 3 - 5.

7 Press the  /  button to start playback.





- Playback will begin from track 1 on DISC 1. After that disc finishes playing, the next disc will automatically play.
- After the last track on the fifth disc is played, the unit will stop automatically.
- When there is no disc in one of the disc trays (1 - 5), the empty tray will be skipped to the next tray with a disc.





To exchange other discs while playing a disc:

Press one of the  1 -  5 buttons for the stopped disc and within 5 seconds, press the  OPEN/CLOSE button and exchange discs.

To remove the discs:

In the stop mode, press the  1 -  5 button and within 5 seconds, press the  OPEN/CLOSE button.

To skip to a desired disc:













Press one of the  1 -  5 buttons and within 5 seconds, press the  (CD ) button.

Caution:

- Do not place two discs in a same tray.
- Do not play discs of special shapes (heart, octagon, etc). It may cause malfunctions.
- Do not push the disc tray while it is moving.
- If the power fails while the tray is open, wait until the power is restored.
- If the disc tray is stopped with force, "ER-CD20" will appear on the display for 3 seconds and the unit will not function. If this occurs, press the ON/STAND-BY button to enter the power stand-by mode and then turn the power on again.
- If TV or radio interference occurs during CD operation, move the unit away from the TV or radio.
- If a disc is damaged, dirty, or loaded upside down, the disc will be skipped.

Listening to a CD or MP3/WMA disc (continued)

■ Various disc functions

Function	Main unit	Remote control	Operation
Play 			Press in the stop mode.
Stop 			Press in the playback mode.
Pause 			Press in the playback mode. Press the ► / ◀ button to resume playback from the paused point.
Track up/ Track down			Press in the playback or stop mode. If you press the button in the stop mode, press the ► / ◀ button to start the desired track.
Fast forward/ Fast reverse			Press and hold down in the playback mode. Release the button to resume playback.

Notes for CD or MP3/WMA disc:

- Track up/track down is possible only within individual discs.
- Fast forward/fast reverse is possible only within individual discs.
- When the end of the last track is reached during fast forward, "END" will appear on the display and CD operation will be paused. When the beginning of the first track is reached during fast reverse, the unit will enter the playback mode.
- Rewritable multi session discs which writing is not finished, can still be played.

Advanced CD or MP3/WMA disc playback

■ Direct track search

By using the direct search buttons, the desired tracks on the current disc can be played.

Use the direct search buttons on the remote control to select the desired track while playing the selected disc.



Selected track number

- The direct search buttons allow you to select up to number 9.
- When selecting number 10 or higher, use the "+10" button.

A. For example, to choose 13

- 1 Press the "+10" button once.
- 2 Press the "1" button.
- 3 Press the "3" button.

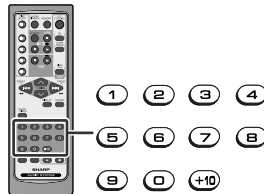

B. For example, to choose 130

- 1 Press the "+10" button twice.
- 2 Press the "1" button.
- 3 Press the "3" button.
- 4 Press the "0" button.

Notes:

- A track number higher than the number of tracks on the disc cannot be selected.
- During random play, direct search is not possible.

To stop playback:

Press the ■ (CD ■) button.

Advanced CD or MP3/WMA disc playback (continued)

■ Repeat play

Repeat play can play one disc, all 5 discs or a programmed sequence continuously.

To repeat one disc:

Press the ► / ◀ button twice.

To repeat all tracks on up to 5 discs:

Press the ► / ◀ button three times.

To repeat desired tracks (CD only):

Perform steps 1 - 6 in "Programmed play" section on page 21 and then press the ► / ◀ button twice.

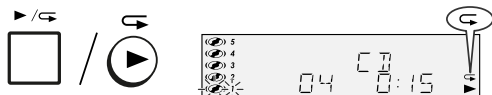

To cancel repeat play:

Press the ► / ◀ button again until "C" will disappear.

■ Random play

The tracks on the disc(s) can be played in random order automatically.

To random play all tracks on up to 5 discs:

Press the RANDOM button on the remote control.

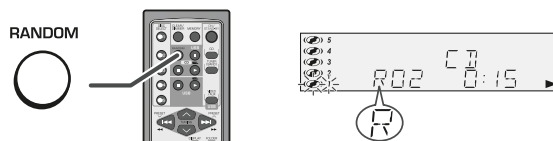

To cancel random play:

Press the ► / ◀ button.

"R" will disappear.

Notes:

- If you press the ►► button during random play, you can move to the track selected next by the random operation. On the other hand, the ◀◀ button does not allow you to move to the previous track. The beginning of the track being played will be located.
- In random play, the unit will select and play tracks automatically. (You cannot select the order of the tracks.)







Caution:

After performing repeat or random play, be sure to press the ■ (CD) button. Otherwise, the disc(s) will play continuously.

Advanced CD playback

■ Programmed play

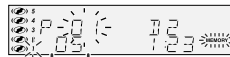
You can choose up to 32 selections for playback in the order you like.

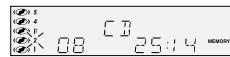
<p>1 While in the stop mode, press the MEMORY button on the remote control to enter the programming save mode.</p>	 <p>MEMORY</p>
	
<p>2 Press one of the 1 - 5 buttons to select the desired disc.</p>	 <p>Selected disc number</p>
<p>3 Press the direct search buttons on the remote control to select the desired track.</p>	  <p>Selected track number</p>
<p>You can also select a track by pressing the ◀ or ▶ button.</p>	
<p>4 Press the MEMORY button to save the track number.</p>	
<p>5 Repeat steps 2 - 4 for other tracks. Up to 32 tracks can be programmed.</p> <p>If you make a mistake, the programmed tracks can be cleared by pressing the CLEAR/DIMMER button.</p>	
<p>6 Press the ■ (CD ■) button.</p> <p>The total number in memory will appear.</p>	
<p>7 Press the ▶ / ◀ button to start playback.</p>	

To clear the programmed selections:

Press the **CLEAR/DIMMER** button on the remote control while the "MEMORY" indicator is flashing. Each time the button is pressed, one track will be cleared, beginning with the last track programmed.

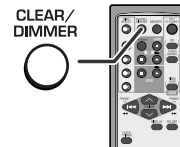

To cancel the programmed play mode:

While in the stop mode and the "MEMORY" indicator is lit, press the **CLEAR/DIMMER** button on the remote control. The "MEMORY" indicator will disappear and all the programmed contents will be cleared.

Adding tracks to the program:

If a program has been previously stored, the "MEMORY" indicator will be displayed. Then follow steps 1 - 6 to add tracks. The new tracks will be stored after the last track of the original program.

To check which tracks are programmed:

While the unit is stopped in the programmed play mode, press the **◀** or **▶** button.

Notes:

- When a disc with programmed tracks is ejected, the program is automatically canceled.
- Even if you press the **ON/STAND-BY** button to enter the stand-by mode or change the function from CD to another, the programmed selections will not be cleared.
- During the program operation, random play is not possible.

MP3/WMA folder mode (only for MP3/WMA files)

To playback MP3/WMA (Windows Media Audio) file

There are many music sites on the internet that you can download MP3/WMA (Windows Media Audio) music files. Follow the instructions from the website on how to download the music files.

You can then playback these downloaded music files by burning them to a CD-R/RW disc or by connecting a USB Memory Player device.

- Your downloaded song/files are for personal use only. Any other usage of the song without owner's permission, is against the law.

■ About folder playback order

If MP3/WMA files are recorded in several folders, a folder number will be set to each folder automatically.

These folders can be selected by the FOLDER button on the remote control. If there is no supported file formats inside the selected folder, the folder is skipped and the next folder will be selected.

Example: How to set folder number if MP3/WMA format files are recorded as below figure.

1. ROOT folder is set as folder 1.
2. As for folders inside ROOT folder (Folder A and Folder B), the folder which is recorded earlier on the disc will be set as folder 2.
3. As for folder inside Folder A (Folder C and Folder D), the folder which is recorded earlier on the disc will be set as folder 3.
4. Because there is no folder in Folder C, Folder D will be set as folder 4.
5. Folder E that is inside Folder D will be set as folder 5.
6. Folder B inside ROOT folder will be set as folder 6.

* The folder and file order information which is recorded on the disc depends on the writing software. There maybe possibilities that this unit will playback the files not according to our expected playback order.

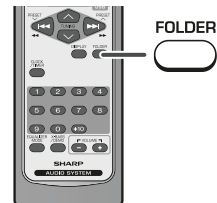

Folder mode on/off can be operated by the FOLDER button on the remote control. Files that are played when folder mode is set to the on position, may differ from those played back when folder mode is turned off.

Folder Mode Off case:

All the files starting from the selected folder or file will be played back. If file 3 inside Folder C is selected, all the files starting from file 3 will be played back.

Folder Mode On case:

All the files inside the selected folder will be played back. In case Folder D is selected, file 4, 5 and 6 will be played back. File 7 and 8 in Folder E will not be played back.

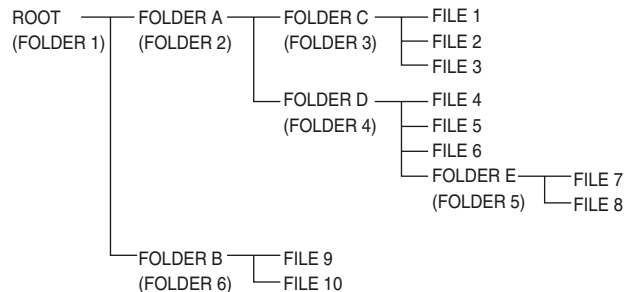

■ Procedure to playback MP3/WMA disc

To playback CD-R/RW.

1 Press the CD button, and load a MP3/WMA disc.

- After disc is loaded, disc info will be displayed.

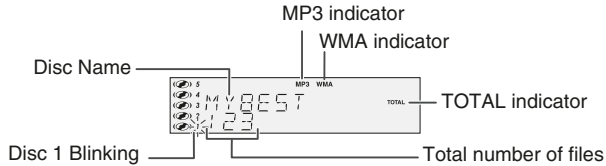

- In case folder is selected, proceed to step 2.
- In case file is selected, proceed to step 4.

2 Press the FOLDER button, and press the TUNING (∨ or ∧) button to select desired playback folder. (Folder mode on)



- To start playback with folder mode on, go to step 5.
- To change the playback folder, press the TUNING (∨ or ∧) to select another folder.

3 Select desired file to be played back by pressing the ⏪⏪ or ⏩⏩ button. Proceed to step 5.

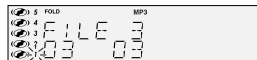

4 Select desired file to be played back by pressing the ⏪⏪ or ⏩⏩ button. (Folder mode off)



5 Press the ▶/⏪ (CD ▶/⏪) button. Playback will start and file name will be displayed.

- Title, Artist & Album name is displayed if it is recorded on the disc.
- Display content can be changed by pressing the DISPLAY button.

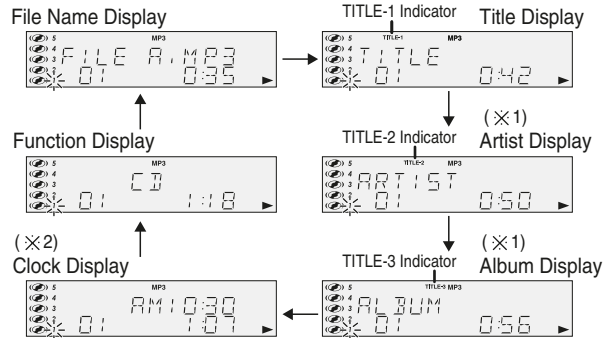

In case of playback with the folder mode on, press the TUNING (∨ or ∧) button, and the folder can be selected even though it is in playback/pause mode.

It will continue playback/pause mode in the 1st track of the selected folder.

- (※ 1) MP3 ID3-Tag only support version 1.x.
- (※ 2) Only appears when clock is already set.

Note:

- If "NO SUPPORT" is displayed, it means "Copyright protected WMA file" or "Not supported playback file" is selected.

Listening to USB mass storage device / MP3 Player

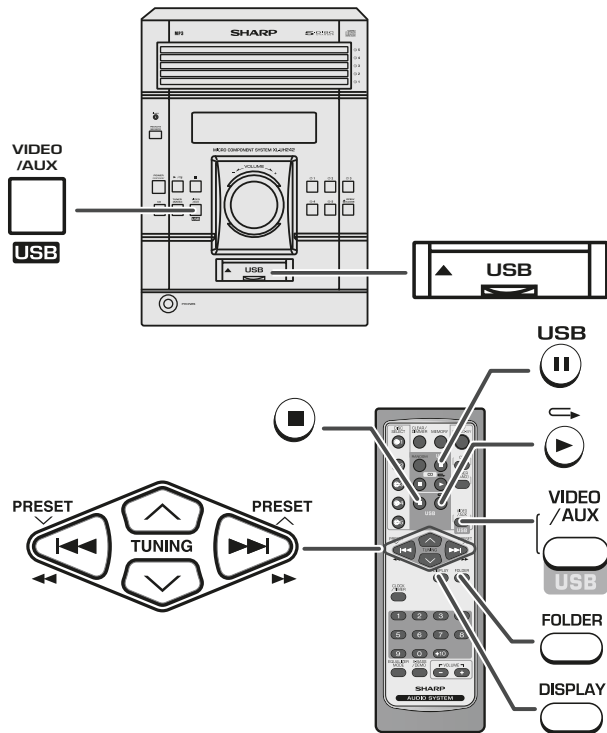

Note:

This product is not compatible with MTP and AAC file systems.

1 Press the VIDEO/AUX/USB (USB/AUX) button, and push up the USB door. Connect the USB Memory device that has MP3/WMA format files on the unit.

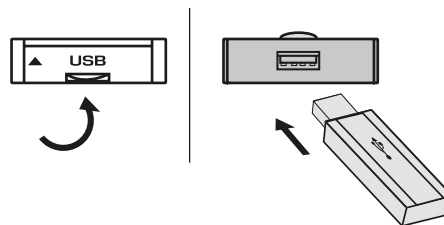

When the USB memory is connected to the main unit, the device information will be displayed.

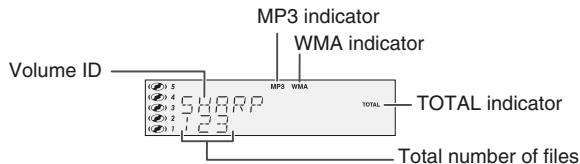

- In case folder is selected, proceed to step 2.
- In case file is selected, proceed to step 4.

2 Press the FOLDER button, and press the TUNING (∨ or ∧) button to select desired playback folder. (Folder mode on)

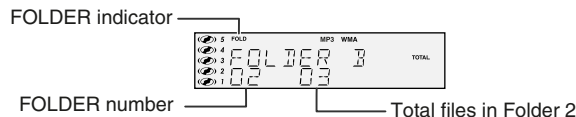

- To start playback with folder mode on, go to step 5.
- To change the playback folder, press the TUNING (∨ or ∧) button to select another folder.

To remove USB memory device

3 Select desired file to be played back by pressing the ◀◀◀◀ or ▶▶▶▶ button. Proceed to step 5.

4 Select desired file to be played back by pressing the ◀◀◀◀ or ▶▶▶▶ button. (Folder mode off)



5 Press the ▶/◀ (USB ▶/◀) button.
Playback will start and the file name will be displayed.

- Title, Artist & Album name are displayed if they are recorded in the USB memory device.
- Display content can be changed by pressing the DISPLAY button.

File Name Display



Function Display



Clock Display (×2)



TITLE-1 Indicator Title Display



TITLE-2 Indicator Artist Display (×1)



TITLE-3 Indicator Album Display (×1)

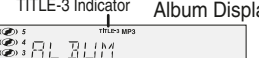

• (× 1) MP3 ID3-Tag only supports version 1.x.
 • (× 2) Only appears when clock is already set.

Note:
 To pause playback:
 Press the CD/USB ■ button.

Auto power off function:
 In the stop mode of USB operation, the main unit enters the stand-by mode after 15 minutes of inactivity.

1 Press the USB ■ button on remote control. Wait until "UNPLUG OK" appears on FL display.



2 Disconnect USB memory device from the USB terminal.

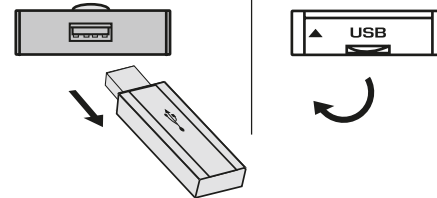

Notes:

- SHARP will not be held liable for the loss of data while the USB memory device is connected to the audio system.
- Files compressed in MP3 and / or WMA format can be played when connected to the USB terminal.
- This USB memory's format supports FAT16 or FAT32.
- SHARP cannot guarantee that all USB memory devices will work on this audio system.
- This USB memory cannot be operated via USB hub.
- If "NO SUPPORT" is displayed, it means "Copyright protected WMA file" or "Not supported playback file" is selected.
- In case the data inside the USB memory is large, it may take longer time for data to be read.
- The USB terminal in this unit is not intended for a PC connection but is used for music streaming with a USB memory device.

Advanced USB playback

■ Repeat play

Repeat play can play all tracks sequence continuously.

To repeat all tracks:

Press the ►/◄ button twice.

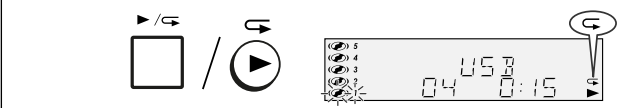

To cancel repeat play:

Press the ►/◄ button again until "◄" disappear.

■ Random play

The tracks can be played in random order automatically.

To random play all tracks:

Press the RANDOM button on the remote control.

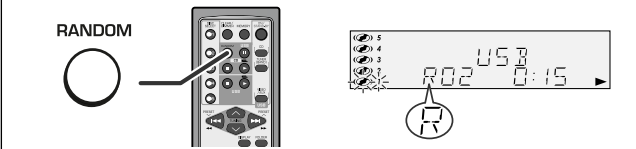

To cancel random play:

Press the ►/◄ button.
"R" will disappear.

Notes:

- If you press the ►► button during random play, you can move to the track selected next by the random operation. On the other hand, the ◄◄ button does not allow you to move to the previous track. The beginning of the track being played will be located.
- In random play, the unit will select and play tracks automatically. (You cannot select the order of the tracks.)

Caution:

After performing repeat, be sure to press the ■ (USB ■) button. Otherwise, it will play continuously.

Note:

(⊗) When folder mode is on, the selected playmode can be used for the files in the selected folder only.

Notes:

- This unit only supports "MPEG-1 Audio Layer-3" format. (Sampling Frequency fs is 32, 44.1, 48kHz)
"MPEG-2 Audio Layer-3", "MPEG-2.5 Audio Layer-3" and MP1, MP2 format are not supported.
- Program playback for USB memory is not available.
- Playback order for MP3 files may differ sometimes depending on the writing software used during file download.
- Bitrate which is supported by MP3 is 32~320 kbps, WMA is 64~160 kbps.
- For MP3/WMA files, please put ".MP3" ".WMA" extension. Files cannot be played back if there is no MP3/WMA extension.
- Playlists are not supported by this unit.
- This unit can display Folder Name or File Name up to 32 characters.
- This unit only supports MP3 ID3-Tag version 1.x.
- The display playback time may not be displayed correctly when playing back a variable bitrate file.
- Time display cannot be changed by the DISPLAY button.
- Title name and artist name can be displayed by pressing the DISPLAY button during file playback or pause mode.
- WMA meta tag also supports title, artist and album name which are recorded in WMA files.
- Copyright protected WMA files cannot be played back.

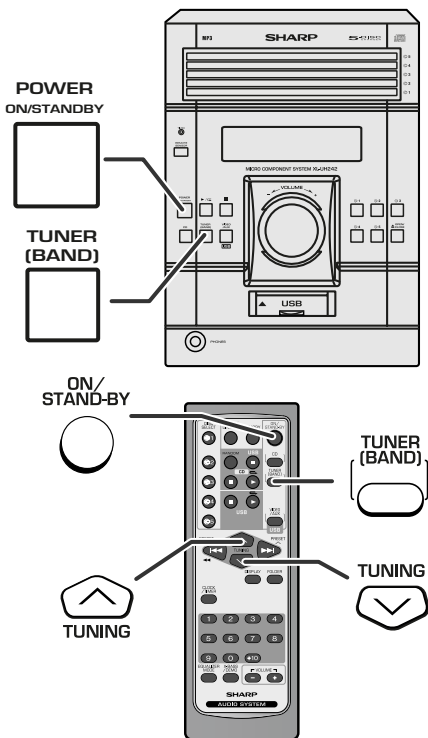

Auto power on function:

When you press any of the following buttons, the unit turns on.

- TUNER (BAND) button (main unit and remote control): The unit turns on and the "TUNER" function is activated.
- ► / ◀ button on the main unit: The unit turns on and playback of the last function starts (CD, TUNER, VIDEO/AUX/USB).

■ Tuning

- 1 Press the ON/STAND-BY button to turn the power on.
- 2 Press the TUNER (BAND) button repeatedly to select the desired frequency band (FM or AM).
- 3 Press the TUNING (∨ or ∧) button on the remote control to tune in to the desired station.

Manual tuning:

Press the TUNING (∨ or ∧) button as many times as required to tune in to the desired station.

Auto tuning:

When the TUNING (∨ or ∧) button is pressed for more than 0.5 seconds, scanning will start automatically and the tuner will stop at the first receivable broadcast station.

Notes:

- When radio interference occurs, auto scan tuning may stop automatically at that point.
- Auto scan tuning will skip weak signal stations.
- To stop the auto tuning, press the TUNING (∨ or ∧) button again.

To receive an FM stereo transmission:

Press the TUNER (BAND) button to display the "ST" indicator.

- "∞" will appear when an FM broadcast is in stereo.
- If the FM reception is weak, press the TUNER (BAND) button to extinguish the "ST" indicator. The reception changes to monaural, and the sound becomes clearer.

FM stereo mode indicator



FM stereo receiving indicator

Listening to the radio (continued)

■ Memorizing a station

You can store 40 AM and FM stations in memory and recall them at the push of a button. (Preset tuning)

1 Perform steps 1 - 3 in "Tuning" on page 27.

2 Press the MEMORY button to enter the preset tuning saving mode.

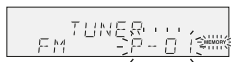

3 Within 30 seconds, press the PRESET (^ or v) button to select the preset channel number.

Store the stations in memory, in order, starting with preset channel 1.

4 Within 30 seconds, press the MEMORY button to store that station in memory.



If the "MEMORY" and preset number indicators disappear before the station is memorized, repeat the operation from step 2.

5 Repeat steps 1 - 4 to set other stations, or to change a preset station.

When a new station is stored in memory, the station previously memorized for that preset channel number will be erased.

Note:

The backup function protects the memorized stations for a few hours should there be a power failure or the AC power cord become disconnected.

■ To recall a memorized station

Press the PRESET (^ or v) button for less than 0.5 seconds to select the desired station.

■ To scan the preset stations

The stations saved in memory can be scanned automatically. (Preset memory scan)

- 1 Press the PRESET (^ or v) button for more than 0.5 seconds. The preset number will flash and the programmed stations will be tuned in sequentially, for 5 seconds each.
- 2 Press the PRESET (^ or v) button again when the desired station is located.

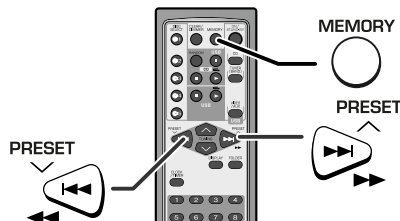

■ To erase entire preset memory

- 1 Press the ON/STAND-BY button to enter the stand-by mode.
- 2 While pressing down the 1 button and the 5 button, press the TUNER (BAND) button until "TUNER CLEAR" appears.



Timer and sleep operation (Remote Control only)

Timer playback:

The unit turns on and plays the desired source (CD, TUNER, USB, AUX) at a preset time.

This unit has 2 types of timer: ONCE TIMER and DAILY TIMER.

Once timer: Once timer play works for one time only at a preset time.

Daily timer: Daily timer play works at the same preset time every day.

For example, set the timer as a wake-up call every morning.

Using the once timer and daily timer in combination:

For example, use the once timer to listen to a radio program, and use the daily timer to wake up.

- 1 Set the daily timer (pages 29 - 31).
- 2 Set the once timer (pages 29 - 31).

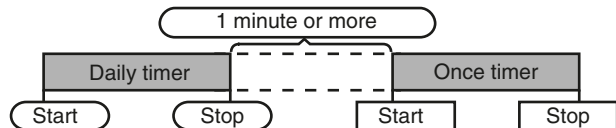

Note:

When set times for the daily timer and once timer overlap, the once timer takes priority. Allow an interval of at least 1 minute between operations.

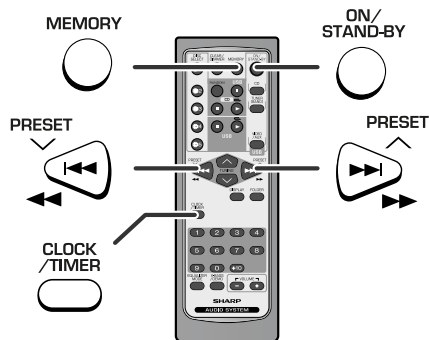

■ Timer playback

Before setting timer:

- 1 Check that the clock is set to the correct time (refer to page 15). If it is not set, you cannot use the timer function.
- 2 For timer playback: Load discs to be played.



- 1 Press the ON/STAND-BY button to turn the power on.
- 2 Press the CLOCK/TIMER button.
- 3 Within 10 seconds, press the <<<< or >>>> button to select "ONCE" or "DAILY", and press the MEMORY button.



Set the clock to the correct time if "ONCE" or "DAILY" does not appear.

Continued to the next page

Timer and sleep operation (Remote Control only) (continued)

- 4** Within 10 seconds, press the **◀◀ ◀◀** or **▶▶ ▶▶** button to select "ONCE SET" or "DAILY SET", and press the **MEMORY** button.



- 5** Press the **◀◀ ◀◀** or **▶▶ ▶▶** button to adjust the hour and then press the **MEMORY** button.

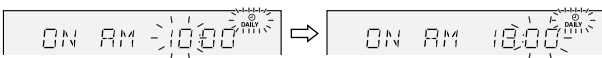

The illustrations show the timer playback setting in the daily timer mode.

- 6** Press the **◀◀ ◀◀** or **▶▶ ▶▶** button to adjust the minutes and then press the **MEMORY** button.



- 7** Set the time to finish as in steps 5 and 6 above.

- 8** Switch input with the **◀◀ ◀◀** or **▶▶ ▶▶** button, and then press the **MEMORY** button.

To select the timer playback source: CD, TUNER, USB or AUX.

- When you select the tuner, select a station by pressing the **◀◀ ◀◀** or **▶▶ ▶▶** button, and then press the **MEMORY** button.
- If a station has not been programmed, "NO PRESET" will be displayed and timer setting will be canceled.

- 9** Adjust the volume using the **VOLUME** control, and then press the **MEMORY** button.

Do not turn the volume up too high.

- 10** Press the **ON/STAND-BY** button to enter the power stand-by mode.

The "TIMER" indicator lights up and the unit is ready for timer playback.

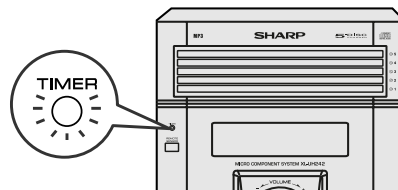

Continued to the next page

11 When the preset time is reached, playback will start.

The volume will increase gradually until it reaches the preset volume.

12 When the timer end time is reached, the system will enter the power stand-by mode automatically.**Once timer:**

The timer will be canceled.

Daily timer:

The timer will operate at the same time every day. It will continue until the daily timer setting is canceled. Cancel the daily timer when it is not in use.

Note:

When performing timer playback using another unit connected to the USB terminal or AUX IN jacks, select "USB" or "AUX" in step 8. This unit will turn on or enter the power stand-by mode automatically, however, the connected unit to AUX IN jacks will not turn on or off.

Checking the timer setting in the timer stand-by mode:

- 1 Press the CLOCK/TIMER button.
- 2 Within 10 seconds, press the **◀◀◀** or **▶▶▶** button to select "ONCE" or "DAILY", and press the MEMORY button.
- 3 Within 10 seconds, press the **◀◀◀** or **▶▶▶** button to select "ONCE CALL" or "DAILY CALL", and press the MEMORY button. The unit returns to the timer stand-by mode after displaying the settings in order.

Canceling the timer setting in the timer stand-by mode:

- 1 Press the CLOCK/TIMER button.
- 2 Within 10 seconds, press the **◀◀◀** or **▶▶▶** button to select "ONCE" or "DAILY", and press the MEMORY button.
- 3 Within 10 seconds, press the **◀◀◀** or **▶▶▶** button to select "ONCE OFF" or "DAILY OFF", and press the MEMORY button. Timer will be canceled (the setting will not be canceled).

Reusing the memorized timer setting:

The timer setting will be memorized once it is entered. To reuse the same setting, perform the following operations.

- 1 Turn the power on and press the CLOCK/TIMER button.
- 2 Within 10 seconds, press the **◀◀◀** or **▶▶▶** button to select "ONCE" or "DAILY", and press the MEMORY button.
- 3 Within 10 seconds, press the **◀◀◀** or **▶▶▶** button to select "ONCE ON" or "DAILY ON", and press the MEMORY button.
- 4 Press the ON/STAND-BY button to enter the power stand-by mode.

Timer and sleep operation (Remote Control only) (continued)

■ Sleep operation

The radio, compact disc and USB can be turned off automatically.

1 Play back the desired sound source.

2 Press the CLOCK/TIMER button.

3 Within 10 seconds, press the \lll or \ggg button to select "SLEEP", and press the MEMORY button.

SLEEP 2:00

4 Press the \lll or \ggg button to select the time.

(Maximum: 3 hours - Minimum: 1 minute)

- 3 hours - 5 minutes → 5-minute intervals
- 5 minutes - 1 minute → 1-minute intervals

5 Press the MEMORY button.

"SLEEP" will appear.

SLEEP
TUNER 98.8 MHz

6 The unit will enter the power stand-by mode automatically after the preset time has elapsed.

The volume will be turned down 1 minute before the sleep operation finishes.

To confirm the remaining sleep time:

- 1 While "SLEEP" is indicated, press the CLOCK/TIMER button.
 - 2 Within 10 seconds, press the \lll or \ggg button to select "SLEEP X : XX".
"X : XX" is sleep remaining time.
- The remaining sleep time is displayed for about 10 seconds.
 - You can change the remaining sleep time while it is displayed by pressing the MEMORY button (steps 4 - 5).

To cancel the sleep operation:

Press the ON/STAND-BY button while "SLEEP" is indicated.

To cancel the sleep operation without setting the unit to the stand-by mode, proceed as follows.

- 1 While "SLEEP" is indicated, press the CLOCK/TIMER button.
- 2 Within 10 seconds, press the \lll or \ggg button to select "SLEEP OFF", and press the MEMORY button.

■ To use timer and sleep operation together

Sleep and timer playback:

For example, you can fall asleep listening to the radio and wake up to CD in the next morning.

- 1 Set the sleep time (see left, steps 1 - 5).
- 2 While the sleep timer is set, set the timer playback (steps 2 - 10, pages 29 - 30).

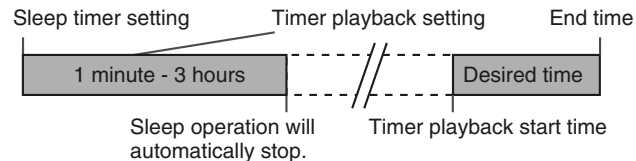

Enhancing your system

The connection cord is not included. Purchase a commercially available cord as shown below.

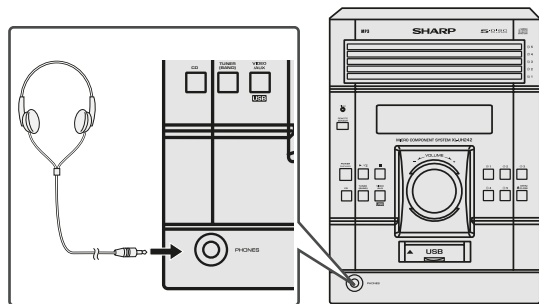
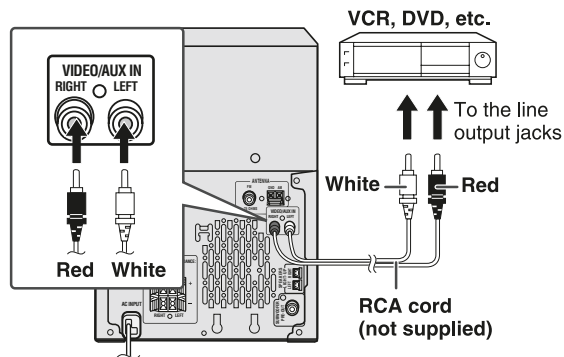

Auto power on function:

When you press any of the following buttons, the unit turns on.

- VIDEO/AUX/USB button (main unit and remote control): The unit turns on and the "USB" or "AUX" function is activated.
- ► / ◀ button on the main unit: The unit turns on and playback of the last function starts (CD, TUNER, VIDEO/AUX/USB).

■ Listening to the playback sounds from VCR, DVD, etc.

- 1 Use a connection cord to connect the VCR, DVD, etc. to the VIDEO/AUX IN jacks.

When using video equipment, connect the audio output to this unit and the video output to a television.

- 2 Press the ON/STAND-BY button to turn the power on.
- 3 Press the VIDEO/AUX/USB button.
- 4 Play the connected equipment.

Note:

To prevent noise interference, place the unit away from the television.

■ Headphones

- Before plugging in or unplugging the headphones, reduce the volume.
- Be sure your headphones have a 1/8" (3.5 mm) diameter plug and impedance between 16 and 50 ohms. The recommended impedance is 32 ohms.
- Plugging in the headphones disconnects the speakers automatically. Adjust the volume using the VOLUME control.

Enhancing your system (continued)

■ Subwoofer connection

When a commercially available subwoofer with a built-in amplifier is connected to this unit, you can enjoy sound with emphasized bass. Connect an RCA cord from a commercially available speaker with a built-in amplifier to the SUBWOOFER PRE-OUT jack.

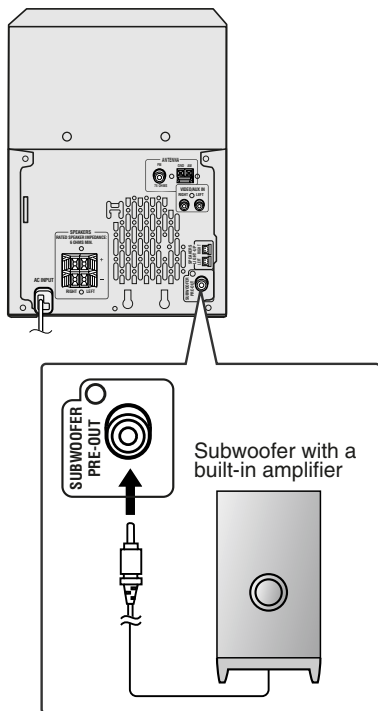

Troubleshooting chart

Many potential problems can be resolved by the owner without calling a service technician. If something is wrong with this product, check the following before calling your authorized SHARP dealer or service center.

■ General

Symptom	Possible cause
<ul style="list-style-type: none"> ● The clock is not set to the correct time. 	<ul style="list-style-type: none"> ● Did a power failure occur? Reset the clock.
<ul style="list-style-type: none"> ● When a button is pressed, the unit does not respond. 	<ul style="list-style-type: none"> ● Set the unit to the power standby mode and then turn it back on. ● If the unit still malfunctions, reset it.
<ul style="list-style-type: none"> ● No sound is heard. 	<ul style="list-style-type: none"> ● Is the volume level set to "0"? ● Are the headphones connected? ● Are the speaker wires disconnected?

■ CD player

Symptom	Possible cause
<ul style="list-style-type: none"> ● Playback does not start. 	<ul style="list-style-type: none"> ● Is the disc loaded upside down?
<ul style="list-style-type: none"> ● Playback stops in the middle or is not performed properly. 	<ul style="list-style-type: none"> ● Does the disc satisfy the standards? ● Is the disc distorted or scratched?
<ul style="list-style-type: none"> ● Playback sounds are skipped, or stopped in the middle of a track. 	<ul style="list-style-type: none"> ● Is the unit located near excessive vibrations? ● Is the disc very dirty? ● Has condensation formed inside the unit?

■ Remote control

Symptom	Possible cause
<ul style="list-style-type: none"> ● The remote control does not operate. 	<ul style="list-style-type: none"> ● Is the AC power cord of the unit plugged in? ● Is the battery polarity correct? ● Are the batteries dead? ● Is the distance or angle incorrect? ● Does the remote control sensor receive strong light?

■ Tuner

Symptom	Possible cause
<ul style="list-style-type: none"> ● The radio makes unusual noises continuously. 	<ul style="list-style-type: none"> ● Is the unit placed near the TV or computer? ● Is the FM antenna or AM loop antenna placed properly? Move the antenna away from the AC power cord if it's located nearby.

■ Condensation

Sudden temperature changes, storage or operation in an extremely humid environment may cause condensation inside the cabinet (CD pickup, etc.) or on the transmitter on the remote control. Condensation can cause the unit to malfunction. If this happens, leave the power on with no disc in the unit until normal playback is possible (about 1 hour). Wipe off any condensation on the transmitter with a soft cloth before operating the unit.

■ If trouble occurs

When this product is subjected to strong external interference (mechanical shock, excessive static electricity, abnormal supply voltage due to lightning, etc.) or if it is operated incorrectly, it may malfunction.

If such a problem occurs, do the following:

- 1 Set the unit to the stand-by mode and turn the power on again.
- 2 If the unit is not restored in the previous operation, unplug and plug in the unit, and then turn the power on.

Note:

If neither operation above restores the unit, clear all the memory by resetting it.

■ Clearing all the memory (reset)

- 1 Press the ON/STAND-BY button to enter the power stand-by mode.
- 2 While pressing down the 1 button and the 5 button, press the POWER ON/STANDBY button until "CLEAR ALL" appears.



Caution:

This operation will erase all data stored in memory including clock, timer settings, tuner preset, and CD program.

Troubleshooting chart (continued)

■ Before transporting the unit

Remove all CDs from the unit. Make sure there is no CD in the disc tray. Then, set the unit to the power stand-by mode. Carrying the unit with discs left inside can damage the unit.

■ Care of compact discs

Compact discs are fairly resistant to damage, however mistracking can occur due to an accumulation of dirt on the disc surface. Follow the guidelines below for maximum enjoyment from your CD collection and player.

- Do not write on either side of the disc, particularly the non-label side from which signals are read. Do not mark this surface.
- Keep your discs away from direct sunlight, heat, and excessive moisture.
- Always hold the CDs by the edges. Fingerprints, dirt, or water on the CDs can cause noise or mistracking. If a CD is dirty or does not play properly, clean it with a soft, dry cloth, wiping straight out from the center, along the radius.

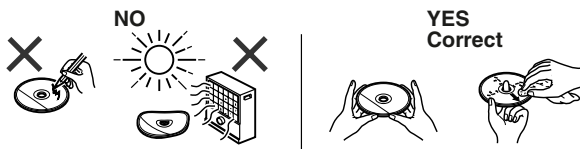

Maintenance

■ Cleaning the CD pickup lens

In order to ensure proper operation of the CD player, preventative maintenance (cleaning of the laser pickup lens) should be performed periodically. Lens cleaners are commercially available. Contact your local CD software dealer for options.

■ Cleaning the cabinet

Periodically wipe the cabinet with a soft cloth and a diluted soap solution, then with a dry cloth.

Caution:

- Do not use chemicals for cleaning (gasoline, paint thinner, etc.). It may damage the cabinet finish.
- Do not apply oil to the inside of the unit. It may cause malfunctions.

Specifications

As part of our policy of continuous improvement, SHARP reserves the right to make design and specification changes for product improvement without prior notice. The performance specification figures indicated are nominal values of production units. There may be some deviations from these values in individual units.

■ General

Power source	AC 120 V, 60 Hz
Power consumption	90 W
Dimensions	Width: 6-3/4" (175 mm) Height: 9-1/2" (240 mm) Depth: 12-1/5" (315 mm)
Weight	12.4 lbs. (5.6 kg)

■ Amplifier

Output power	90 watts minimum RMS per channel into 6 ohms from 100 Hz to 20 kHz, 10% total harmonic distortion
Output terminals	Speakers: 6 ohms Headphones: 16 - 50 ohms (recommended: 32 ohms) Subwoofer pre-out (audio signal): 200 mV/10 k ohms at 70 Hz
Input terminals	Video/Auxiliary (audio signal): 500 mV/47 k ohms

■ USB

Class	Mass storage class
Support File	MP3/WMA (do not support DRM file)
Format support	FAT 16 or FAT 32
Bitrate support	MP3 (32 ~ 320 kbps) WMA (64 ~ 160 kbps)
Other	MP3 ID3 - tag only supports version 1.x USB supports version 2.0

■ CD player

Type	5-disc multi-play compact disc player
Signal readout	Non-contact, 3-beam semiconductor laser pickup
D/A converter	1-bit D/A converter
Frequency response	20 - 20,000 Hz
Dynamic range	90 dB (1 kHz)

■ Tuner

Frequency range	FM: 87.5 - 108 MHz AM: 530 - 1,720 kHz
------------------------	---

■ Speaker

Type	2-way type speaker system 2" (5 cm) tweeter 5-1/8" (13 cm) woofer
Maximum input power	180 W
Rated input power	90 W
Impedance	6 ohms
Dimensions	Width: 7-1/4" (185 mm) Height: 10-1/4" (260 mm) Depth: 9-1/16" (230 mm)
Weight	6.1 lbs. (2.8 kg/each)

MEMO



MEMO



CONSUMER LIMITED WARRANTY

SHARP ELECTRONICS CORPORATION warrants to the first consumer purchaser that this Sharp brand product (the "Product"), when shipped in its original container, will be free from defective workmanship and materials, and agrees that it will, at its option, either repair the defect or replace the defective Product or part thereof with a new or remanufactured equivalent at no charge to the purchaser for parts or labor for the period(s) set forth below.

This warranty does not apply to any appearance items of the Product nor to the additional excluded item(s) set forth below nor to any Product the exterior of which has been damaged or defaced, which has been subjected to improper voltage or other misuse, abnormal service or handling, or which has been altered or modified in design or construction.

In order to enforce the rights under this limited warranty, the purchaser should follow the steps set forth below and provide proof of purchase to the servicer.

The limited warranty described herein is in addition to whatever implied warranties may be granted to purchasers by law. ALL IMPLIED WARRANTIES INCLUDING THE WARRANTIES OF MERCHANTABILITY AND FITNESS FOR USE ARE LIMITED TO THE PERIOD(S) FROM THE DATE OF PURCHASE SET FORTH BELOW. Some states do not allow limitations on how long an implied warranty lasts, so the above limitation may not apply to you.

Neither the sales personnel of the seller nor any other person is authorized to make any warranties other than those described herein, or to extend the duration of any warranties beyond the time period described herein on behalf of Sharp.

The warranties described herein shall be the sole and exclusive warranties granted by Sharp and shall be the sole and exclusive remedy available to the purchaser. Correction of defects, in the manner and for the period of time described herein, shall constitute complete fulfillment of all liabilities and responsibilities of Sharp to the purchaser with respect to the Product, and shall constitute full satisfaction of all claims, whether based on contract, negligence, strict liability or otherwise. In no event shall Sharp be liable, or in any way responsible, for any damages or defects in the Product which were caused by repairs or attempted repairs performed by anyone other than an authorized servicer. Nor shall Sharp be liable or in any way responsible for any incidental or consequential economic or property damage. Some states do not allow the exclusion of incidental or consequential damages, so the above exclusion may not apply to you.

THIS WARRANTY GIVES YOU SPECIFIC LEGAL RIGHTS. YOU MAY ALSO HAVE OTHER RIGHTS WHICH VARY FROM STATE TO STATE.

Model Specific Section

Your Product Model Number & Description:

XL-UH242 Micro Component System

(Be sure to have this information available when you need service for your Product.)

One (1) year parts and labor from the date of purchase.

Warranty Period for this Product:

Additional Item(s) Excluded from Warranty Coverage (if any):

Non-functional accessories, supplies, and consumable items.

Where to Obtain Service:

At a Sharp Authorized Servicer located in the United States.

To find a location of the nearest Sharp Authorized Servicer, call Sharp toll free at 1-800-BE-SHARP.

What to do to Obtain Service:

Ship prepaid or carry in your Product to a Sharp Authorized Servicer.

Be sure to have **Proof of Purchase** available. If you ship the Product, be sure it is insured and packaged securely.

TO OBTAIN SUPPLY, ACCESSORY OR PRODUCT INFORMATION, CALL **1-800-BE-SHARP**.

SHARP

SHARP ELECTRONICS CORPORATION

Sharp Plaza, Mahwah, New Jersey 07430-2135

SHARP CORPORATION

Printed in Malaysia
TINSEA122AWZZ
06C R AS ①

Free Manuals Download Website

<http://myh66.com>

<http://usermanuals.us>

<http://www.somanuals.com>

<http://www.4manuals.cc>

<http://www.manual-lib.com>

<http://www.404manual.com>

<http://www.luxmanual.com>

<http://aubethermostatmanual.com>

Golf course search by state

<http://golfingnear.com>

Email search by domain

<http://emailbydomain.com>

Auto manuals search

<http://auto.somanuals.com>

TV manuals search

<http://tv.somanuals.com>