

SHARP®

MODEL: MX-C300P
MX-C300PE
MX-C300PL

DIGITAL FULL COLOUR PRINTER

OPERATION GUIDE



INTRODUCTION

This manual describes MX-C300P/MX-C300PE/MX-C300PL Digital full colour printer.



- Where "MX-XXXX" appears in this manual, please substitute the name of your model for "XXXX". For the name of your model, see p.6.
- The screen images and procedures that appear in this manual are mainly for Windows 7. With other versions of Windows, some screen images may be different from those in this manual.
- For information on using your operating system, refer to your operating system's manual or online Help.

The display screens, messages, and key names shown in the manual may differ from those on the actual machine due to product improvements and modifications.

CONTENTS

INTRODUCTION	2
USING THE MANUAL	5
● ABOUT THE MANUALS	5
● CONVENTIONS USED IN THIS MANUAL	5
DIFFERENCES BETWEEN MODELS	6

1 BEFORE USING THE MACHINE

PART NAMES AND FUNCTIONS	7
● OPERATION PANEL	9
DISPLAY	10
● HOME SCREEN	10
● HOW TO USE THE DISPLAY	11
POWER ON AND OFF	12
● POWER ON	12
● POWER OFF	12
● POWER SAVE MODES	12
LOADING PAPER	13
● USEABLE PAPER	13
● PRINT SIDE FACE UP OR FACE DOWN	14
● LOADING PAPER	16
● TRAY SETTINGS	19
USER AUTHENTICATION MODE	20
● USING USER AUTHENTICATION MODE	20
ENTERING CHARACTERS	21
● CHARACTERS THAT CAN BE ENTERED	21

2 PRINTER

PRINTER FUNCTION OF THE MACHINE	22
PRINTING FROM WINDOWS	23
● PRINTER DRIVER PROPERTIES WINDOW ...	23
● BASIC PRINTING PROCEDURE	24
● PRINTING WHEN THE USER AUTHENTICATION FUNCTION IS ENABLED	26
● VIEWING PRINTER DRIVER HELP	27
● SAVING FREQUENTLY USED PRINT SETTINGS	28
● CHANGING THE PRINTER DRIVER DEFAULT SETTINGS	30
PRINTING FROM A MACINTOSH	31
● BASIC PRINTING PROCEDURE	31
● PRINTING WHEN THE USER AUTHENTICATION FUNCTION IS ENABLED	34
FREQUENTLY USED FUNCTION	35
● SELECTING THE COLOUR MODE	35
● SELECTING A PRINT MODE SETTING	37
● TWO-SIDED PRINTING	38
● FITTING THE PRINT IMAGE TO THE PAPER	39
● PRINTING MULTIPLE PAGES ON ONE PAGE ...	40
CONVENIENT PRINTING FUNCTIONS	42
● CONVENIENT FUNCTIONS FOR CREATING PAMPHLETS AND POSTERS	42
● FUNCTIONS TO ADJUST THE SIZE AND ORIENTATION OF THE IMAGE	45
● COLOUR MODE ADJUSTMENT FUNCTION ...	47
● FUNCTIONS THAT COMBINE TEXT AND IMAGES	51
● PRINT FUNCTIONS FOR SPECIAL PURPOSES	54
● CONVENIENT PRINTER FUNCTIONS	55
PRINTING WITHOUT THE PRINTER DRIVER ...	57
● DIRECTLY PRINTING A FILE IN USB FLASH MEMORY	58
● DIRECTLY PRINTING FROM A COMPUTER	59
● CANCELLING A PRINT JOB FROM THE MACHINE	59
● CHANGE THE MACHINE TO OFFLINE MODE	59
APPENDIX	60
● PRINTER DRIVER SPECIFICATION LIST	60

3

TROUBLESHOOTING

TROUBLESHOOTING	63
● NETWORK PROBLEMS.....	63
● PRINTING PROBLEMS.....	63
INDICATORS AND DISPLAY MESSAGES	67
MISFEED REMOVAL	68
● MISFEED IN THE BYPASS TRAY	68
● MISFEED IN THE MACHINE.....	69
● MISFEED IN THE PAPER TRAY 1	73
● MISFEED IN THE PAPER TRAY 2 (Option) ..	73
REPLACING THE TONER CARTRIDGE	74
REPLACING THE TONER COLLECTION CONTAINER	76

4

ROUTINE MAINTENANCE

CHECKING THE TOTAL OUTPUT COUNT AND TONER REMAINING	78
LIST PRINT (USER)	78
ROUTINE MAINTENANCE	79
● CLEANING THE BYPASS TRAY PAPER FEED ROLLER.....	79
● CLEANING THE MAIN CHARGER OF THE PHOTOCONDUCTIVE DRUM.....	79
● CLEANING THE LASER UNIT	80
ADJUSTING THE DISPLAY CONTRAST	82

5

SYSTEM SETTINGS

PURPOSE OF THE SYSTEM SETTINGS	83
PROGRAMMING AN ADMINISTRATOR PASSWORD	83
SYSTEM SETTINGS LIST	84
USING THE SYSTEM SETTINGS	87
● Change Admin PW	88
● Initial Setting	88
● Printer	88
● Network.....	88
● User Control.....	90
● Device Control	91
● Operation Setting	91
● Energy Save	92
● List Print.....	92
● Colour Adjust.	92
● Security Settings.....	94

6

WEB FUNCTIONS IN THE MACHINE

ABOUT THE WEB PAGES	95
● HOW TO ACCESS THE WEB PAGE	95
ABOUT THE WEB PAGES (FOR USERS)	96
CONFIGURING THE PRINTER CONDITION SETTINGS	97
● HOW TO CONFIGURE THE SETTINGS.....	97
● PRINTER CONDITION SETTING MENU.....	98
● PRINTER CONDITION SETTINGS	98
ABOUT THE WEB PAGES (FOR THE ADMINISTRATOR)	100
CONFIGURING SMTP AND DNS SERVER SETTINGS	101
PROTECTING INFORMATION PROGRAMMED IN THE WEB PAGE ([Passwords])	102
ADMINISTRATOR SETTINGS	103
● CONFIGURING A SETTING IN THE ADMINISTRATOR SETTINGS	103
● ADMINISTRATOR SETTINGS	103
E-MAIL STATUS AND E-MAIL ALERT SETTINGS	104
● INFORMATION SETUP.....	104
● SMTP SETUP	104
● STATUS MESSAGE SETUP	105
● ALERTS MESSAGE SETUP	105

TRADEMARK ACKNOWLEDGMENTS	107
--	------------

USING THE MANUAL

This machine has been designed to provide convenient printing features in a minimum amount of office space and with maximum operational ease. To enjoy the full benefit of the machine's features, read and understand this manual before using the machine. In addition, read the manual for your computer. For quick reference during machine use, SHARP recommends printing out this manual and keep it in a handy location.

ABOUT THE MANUALS

The manuals for the machine are as follows:

Start Guide

This manual explains:

- Specifications
- Cautions for using the machine in safety

Operation Guide (on the accessory CD-ROM)

This manual explains:

How to use the machine and what to do if trouble occurs.

Software Setup Guide (on the accessory CD-ROM)

This manual explains:

How to install software to operate the machine from your computer.

CONVENTIONS USED IN THIS MANUAL

The icons in the manuals indicate the following types of information:



Warns the user that injury may result if the contents of the warning are not properly followed.



Cautions the user that damage to the machine or one of its components may result if the contents of the caution are not properly followed.



Notes provide information relevant to the machine regarding specifications, functions, performance, operation and such, that may be useful to the user.

DIFFERENCES BETWEEN MODELS

This manual covers the following models.

Model	Wireless LAN
MX-C300P	Yes
MX-C300PE	
MX-C300PL	No

AB series (metric) and inch series references

Both specifications are quoted where applicable.

For example:

Page 4: A4 and B5 (8-1/2" x 11" and 5-1/2" x 8-1/2")

Although AB series size indications are shown on the operation panel of this manual, inch series indications are displayed on the inch series machines.

1

BEFORE USING THE MACHINE

This chapter contains basic information that should be read before using the machine.

PART NAMES AND FUNCTIONS

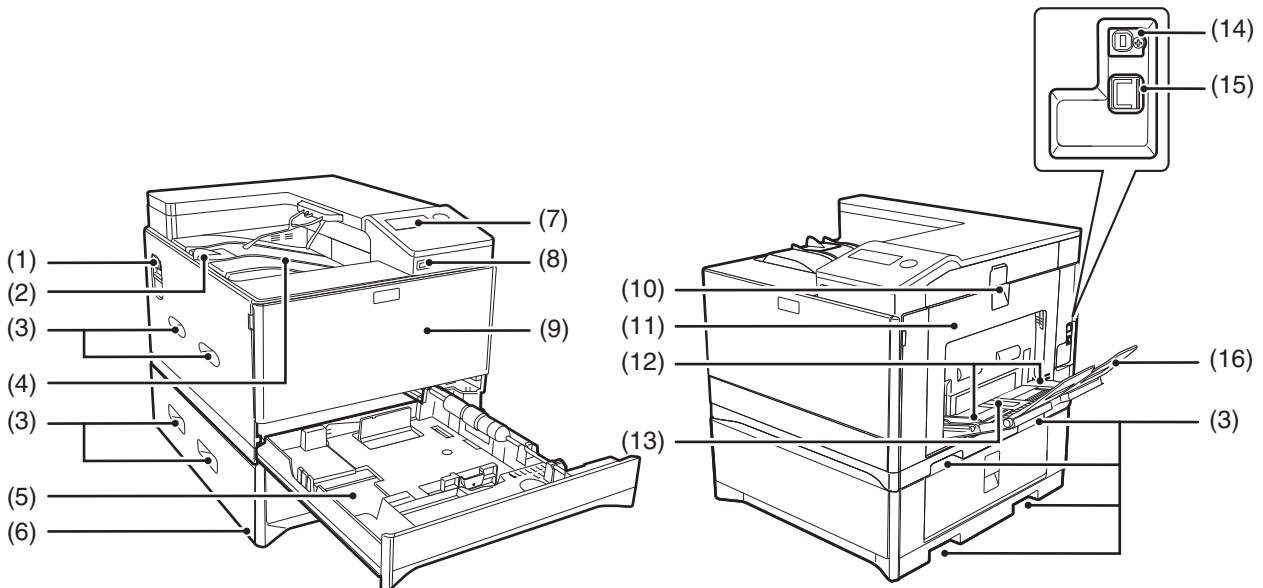

(1) Power switch

Press to turn the machine power on and off.

(2) Output tray extension

When you eject the paper of A4 size or larger, you can open to the outside.

(3) Handles

Use to move the machine. When attaching tray 2, use the handle at the bottom.



The main unit is extremely heavy, and thus two people are required to do the work. When lifting the main unit, grasp the handles on each side firm.

(4) Output tray

Printed pages are output to this tray.

(5) Tray 1

Tray 1 can hold approximately 250 sheets of paper (80 g/m² (21 lbs.)). For restrictions on paper types, sizes, and weights, refer to "USEABLE PAPER" (p.13).

(6) Tray 2 (Option)

Tray 2 can hold approximately 500 sheets of paper (80 g/m² (21 lbs.)). For restrictions on paper types, sizes, and weights, refer to "USEABLE PAPER" (p.13).

(7) Operation panel

Contains operation keys and indicator lights.

(8) USB 2.0 port (Type A)

This is used to connect a USB device such as USB flash memory to the machine.

(9) Front cover

Open to replace the toner cartridge etc.

(10) Side cover handle

Pull to open the side cover.

(11) Side cover

Open to remove misfed paper.

(12) Bypass tray guides

Adjust to the width of the paper when using the bypass tray.

(13) Bypass tray

Special paper (heavy paper or transparency film) can be fed from the bypass tray.

(14) USB 2.0 port (Type B)

Connect the USB cable to this connector when the machine is used on a USB connection.

(15) LAN connector

Connect the LAN cable to this connector when the machine is used on a network.

(16) Bypass tray extension

Open this tray when loading paper in the bypass tray.

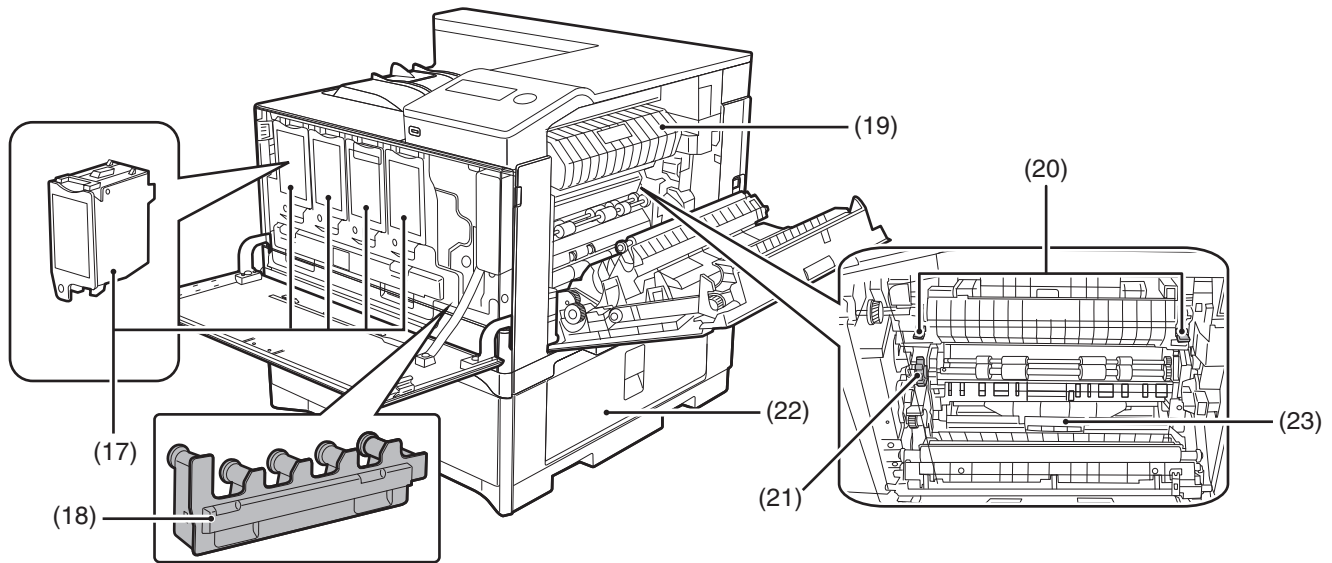
**(17) Toner cartridge (Y/M/C/Bk)**

Contains toner. When the toner in a cartridge runs out, the cartridge of the colour that ran out must be replaced.

(18) Toner collection container

This collects excess toner that remains after printing.

(19) Fusing unit paper guide

Open to remove misfed paper.

(20) Fusing unit release levers

Push down these levers to release the pressure when removing misfed paper from inside the fusing area or when feeding an envelope from the bypass tray.

(21) Roller rotating knob

Rotate to remove misfed paper.

(22) Paper tray right side cover

Open this to remove misfed paper in trays.

(23) Duplex conveyor cover

Open this cover to remove misfed paper.



- **The fusing unit is hot. Do not touch the fusing unit when removing misfed paper. Doing so may cause a burn or injury.**
- **When pushing down the levers, pinch the levers with your thumb and index finger while pushing down slowly. If you push the levers strongly, the levers may hit your fingers.**

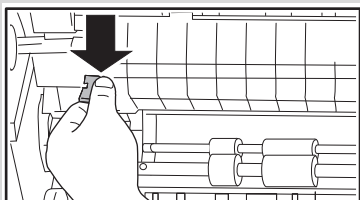

Do not block the exhaust slots of the machine by placing something in front of them or placing the machine close to the wall.

OPERATION PANEL

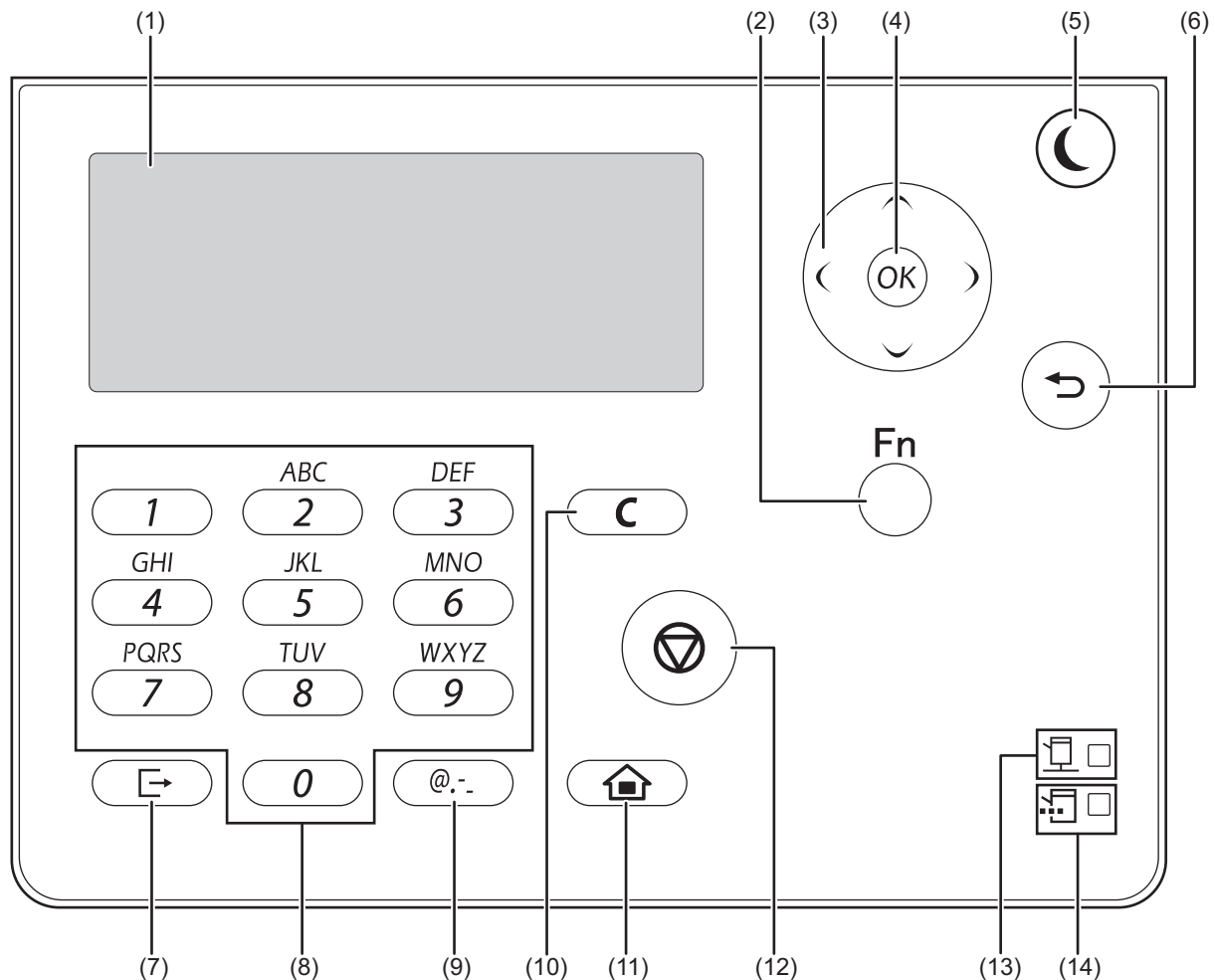

- | | |
|--|--|
| <p>(1) Display
Shows various messages. (p.10)</p> <p>(2) [SPECIAL FUNCTION] key (Fn)
Press to set the paper size and configure system settings.</p> <p>(3) Arrow keys
Press to move the highlighting (which indicates that an item is selected) in the display.</p> <p>(4) [OK] key
Press to enter the selected setting.</p> <p>(5) [ENERGY SAVE] key / indicator (☾)
Press to enter the energy save mode.</p> <p>(6) [BACK] key (↶)
Press to return the display to the previous screen.</p> <p>(7) [LOGOUT] key (→)
Press this key to log out after you have logged in and used the machine.</p> | <p>(8) Numeric keys
Enter characters/numbers.</p> <p>(9) [SYMBOL] key (@.-)
Press to enter a symbol when entering characters.</p> <p>(10) [C] key
Press to clear an enter character of printers.</p> <p>(11) [HOME] key (🏠)
Press to return the display to the home screen. (p.10)</p> <p>(12) [STOP] key (⊘)
Press this key to stop a print job.</p> <p>(13) ONLINE indicator (🖨️)
Print data can be received when this lamp is lit.</p> <p>(14) DATA indicator (🖨️⚡)
Blinks when print data is being received. Lights steadily during printing.</p> |
|--|--|

DISPLAY

This section explains how to use the display.

HOME SCREEN

The machine is set at the factory to return the display to the home screen one minute after a print job is finished or when the [HOME] key (🏠) is pressed (auto clear function).

In the default state the display shown below appears. The default state of the display may vary depending on settings in the system settings.



The auto clear time can be changed in the system settings. (p.91)

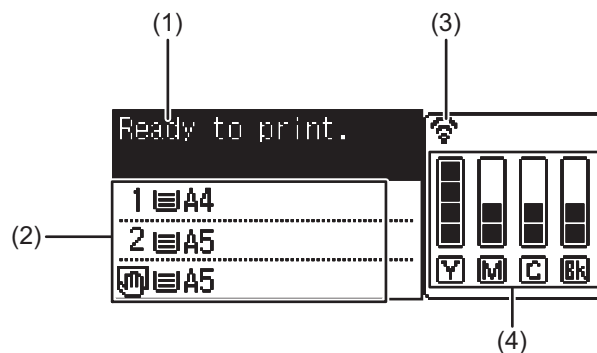

(1) Message display

Messages are displayed regarding machine status and operation.

(2) Paper size display

The size of paper loaded in each tray is displayed.

(3) Connection status display

(Models with the wireless LAN function only)

Displayed when wireless LAN is on.

	Wireless infrastructure mode: Connecting
	Wireless infrastructure mode: Not connected
	Wired + wireless access point mode
	Connection failure of wireless LAN device inside machine

(4) Toner level display

The remaining amount of each colour of toner is displayed.

	76 to 100%
	51 to 75%
	26 to 50%
	1 to 25%
	0%

HOW TO USE THE DISPLAY

Selecting an item with the arrow keys (up/down)

Use the up/down arrow keys (indicated in this manual by [▼][▲]) to move to and select (highlight) a setting item in the selection screen. Press the [OK] key to display the screen of the selected setting item. Press [OK] in the setting screen to save your settings.

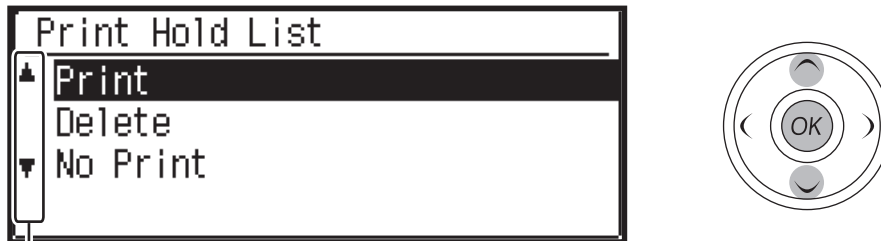

The [▼][▲] icons appear in the selection screen of settings that use the up/down arrow keys.

Selecting an item with the arrow keys (left/right)

The left/right arrow keys (indicated in this manual by [◀][▶]) are used to set the numbers in setting screens. Press the [OK] key to save your settings.

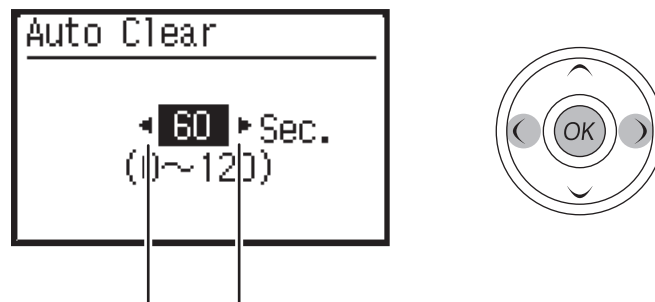

The [◀][▶] icons appear in setting screens that use the left/right arrow keys.

Use the [BACK] key (↶) to return to the previous setting screen.

POWER ON AND OFF

The power switch is located on the left side of the machine.

POWER ON

Turn the power switch to the "ON" position.

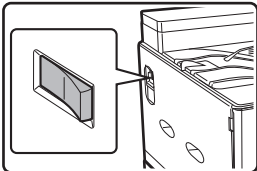

While the machine is warming up, the message "Warming Up" will appear in the message display.

POWER OFF

Make sure that the machine is not in operation and then turn the power switch to the "OFF" position.

If the power switch is turned off while the machine is in operation, a misfeed may occur and the job that was in progress will be cancelled.



- The machine is set at the factory to return the display to the home screen one minute after a print job is finished or when the [HOME] key (🏠) is pressed (auto clear function). The "Auto clear" time can be changed in the system settings. (p.91)
- The machine is initially set to automatically enter power save mode if not used for printing, for a preset period of time. This setting can be changed in the system settings. (p.92)

POWER SAVE MODES

The machine has two power save modes to reduce overall power consumption thereby reducing the cost of operation. In addition, these modes conserve natural resources and help reduce environmental pollution. The two power save modes are "Preheat mode" and "Auto power shut-off mode".

Preheat mode

This function automatically switches the machine to a low power consumption state if the duration of time set in the system settings elapses without the machine being used when the power is on. In preheat mode the display turns off. Normal operation automatically resumes when a key on the operation panel is pressed or a print job is received.

Auto power shut-off mode

This function automatically switches the machine to a state that consumes even less power than preheat mode if the duration of time set in the system settings elapses without the machine being used when the power is on. During auto power shut-off, only the [ENERGY SAVE] indicator (☾) blinks. To restore the machine to normal operation, press the [ENERGY SAVE] key (☾). Normal operation also resumes automatically when a print job is received. While auto power shut-off is in effect, pressing a key other than the [ENERGY SAVE] key (☾) will have no effect.



The preheat activation time and the "Auto power shut-off timer" can be changed using system settings.

LOADING PAPER

The message "TRAY<*>:Add paper." will be displayed when there is no paper in the selected paper tray. (<*> is the tray number.) Load paper in the indicated paper tray.

USEABLE PAPER

The following types of paper can be loaded in each tray.

Paper tray type	Paper type	Size	Weight	Capacity* ¹
Tray 1	Plain paper	A4, B5, A5, 16K,	60 g/m ² to 105 g/m ²	250 sheets
Tray 2 (Option)	Recycled paper Colour Letter head Pre-printed Pre-punched	8-1/2" x 11", 5-1/2" x 8-1/2", 7-1/4" x 10-1/2"	(16 lbs. to 28 lbs.)	500 sheets
Bypass tray	Plain paper	A4, B5, A5, A6, 16K,	60 g/m ² to 105 g/m ²	50 sheets
	Recycled paper Colour Letter head Pre-printed Pre-punched	8-1/2" x 11", 5-1/2" x 8-1/2", 7-1/4" x 10-1/2", 8-1/2" x 14", 8-1/2" x 13-1/2", 8-1/2" x 13-2/5", 8-1/2" x 13", Custom	(16 lbs. to 28 lbs.)	
	Thin paper	(Horizontal:140 to 356 mm (5-1/2" to 14")	55 g/m ² to 59 g/m ² (13 lbs. to 16 lbs.)	1 sheet
	Labels	Vertical: 90 to 216 mm (3-5/8" to 8-1/2")	–	10 sheets
	Transparency film			
	Heavy paper		106 g/m ² to 220 g/m ² (28 lbs. to 80 lbs.)	20 sheets
	Glossy Paper		–	1 sheet
	Envelopes* ²	International DL (110 mm x 220 mm) International C5 (162 mm x 229 mm) Monarch (98 mm x 191 mm) Commercial 10 (105 mm x 241 mm)	75 g/m ² to 90 g/m ² (20 lbs. to 24 lbs.)	10 sheets

*1 The number of sheets of the paper which can be set changes with the weight of a paper. The paper must not be higher than the indicator line.

*2 When feeding an envelope, push down the fusing unit release levers to release the pressure. "Loading the bypass tray" (p.17)

PLAIN PAPER, SPECIAL MEDIA

Plain paper that can be used

- SHARP standard plain paper (80 g/m² (21 lbs.)). For paper specifications, see the specifications in the Start Guide.
- Plain paper other than SHARP standard paper (60 g/m² to 105 g/m² (16 lbs. to 28 lbs.))
Recycled paper, coloured paper and pre-punched paper must meet the same specifications as plain paper. Contact your dealer or nearest authorised service representative for advice on using these types of paper.

* The "g/m²" (lbs.) units used in these explanations indicate the weight of the paper.

PRINT SIDE FACE UP OR FACE DOWN

Paper is loaded with the print side face up or face down depending on the paper type and tray.
The loading orientation of punched paper, letterhead paper, and pre-printed paper differs from that of other paper.
For details, see "Example: Placement orientations of punched paper, letter head paper, and pre-printed paper" (p.14).

Trays 1 to 2

Load the paper with the print side face up.
However, if the paper type is "Pre-Punched", "Letter Head" or "Pre-Printed", load the paper with the print side face down.

Bypass tray

Load the paper with the print side face down.
However, if the paper type is "Pre-Punched", "Letter Head" or "Pre-Printed", load the paper with the print side face up.

Example: Placement orientations of punched paper, letter head paper, and pre-printed paper

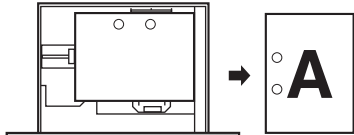
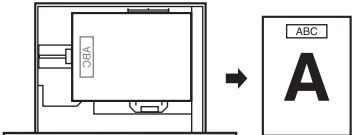
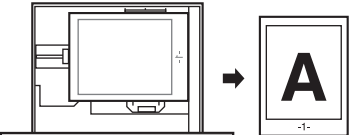
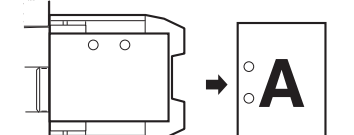
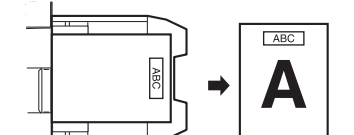
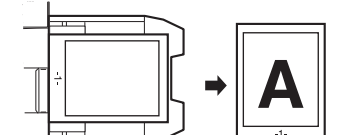
	Pre-punched (Left binding)	Letter head	Pre-printed
Tray 1 to 2	 <p>Load the paper with the print side facing down with the punch holes toward the back.</p>	 <p>Load the paper with the print side facing down with the letter head (top edge) toward the left.</p>	 <p>Load the paper with the print side (pre-printed side) facing down with the top edge toward the left.</p>
Bypass tray	 <p>Load the paper with the print side facing up with the punch holes toward the back.</p>	 <p>Load the paper with the print side facing up with the letter head (top edge) toward the right.</p>	 <p>Load the paper with the print side (pre-printed side) facing up with the top edge toward the right.</p>

Paper that cannot be used

- Special media for inkjet printers (fine paper, glossy paper, glossy film, etc.)
- Carbon paper or thermal paper
- Pasted paper
- Paper with clips
- Paper with fold marks
- Torn paper
- Oil-feed transparency film
- Thin paper less than 55 g/m² (13 lbs.)
- Paper that is 220 g/m² (80 lbs. index) or heavier
- Irregularly shaped paper
- Stapled paper
- Damp paper
- Curled paper
- Paper on which either the print side or the reverse side has been printed on by another printer or multifunction device.
- Paper with a wave-like pattern due to moisture absorption

Non-recommended paper

- Iron-on transfer paper
- Japanese paper
- Perforated paper



- Various types of plain paper and special media are sold. Some types cannot be used with the machine. Contact your dealer or nearest authorised service representative for advice on using these types of paper.
- The image quality and toner fusibility of paper may change due to ambient conditions, operating conditions, and paper characteristics, resulting in image quality inferior to that of SHARP standard paper. Contact your dealer or nearest authorised service representative for advice on using these types of paper.
- The use of non-recommended or prohibited paper may result in skewed feeding, misfeeds, poor toner fusing (the toner does not adhere to the paper well and can be rubbed off), or machine failure.
- The use of non-recommended paper may result in misfeeds or poor image quality. Before using non-recommended paper, check if printing can be performed properly.

Paper that can be used for automatic 2-sided printing

Paper used for automatic duplex printing must meet the following conditions.

Paper type: Plain paper (special paper cannot be used.)

Paper size: Standard sizes (A4, B5, A5, 16K, 8-1/2" x 14", 8-1/2" x 13", 8-1/2" x 11")

Paper weight: 60 g/m² to 105 g/m² (16 lbs. to 28 lbs.)

Special papers

Follow these guidelines when using special papers.

- Use SHARP recommended transparency film and label sheets. Using other than SHARP recommended paper may result in misfeeds or smudges on the output. If other than SHARP recommended media must be used, feed each sheet one at a time using the bypass tray (do not attempt continuous printing).
- There are many varieties of special paper available on the market, and some cannot be used with this machine. Before using special paper, contact your authorised service representative.
- Before using other than SHARP recommended paper, make a test print to see if the paper is suitable.

LOADING PAPER

Make sure that the machine is not printing, and then follow these steps to load paper.

Loading the paper tray

1 Gently lift and pull out the paper tray until it stops.

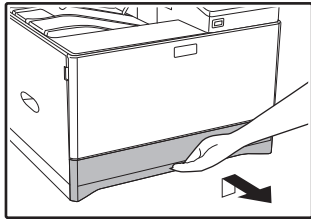

2 Push the pressure plate down, and adjust the plates in the tray to the length and width of the paper.

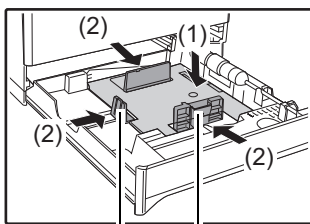
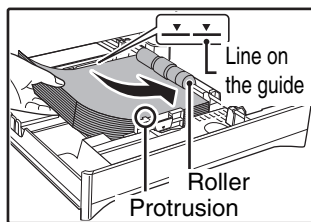

Plate B Plate A

- (1) Push the centre of the pressure plate down until it locks into place.
- (2) The plate A and B are slide-type guides. Grasp the locking knob on the guide and slide the guides until the width that the paper can be loaded properly.

3 Load paper into the tray.



- Load the paper with the print side face up. Make sure the stack of paper is straight before loading it.
- Place the paper under the roller on the right side of the tray.
- After loading the paper, close the guides to the paper width not to leave the gap from the guides.



- Do not load paper higher than the line on the guide (up to 250 sheets).
- Do not add paper to the loaded paper. It may cause multiple feed of paper.
- The loaded paper should not go higher than the protrusion of the plate A.

4 Gently push the paper tray into the machine.

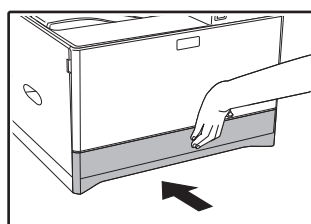

Push the tray in completely.



- If you loaded a different size of paper than was loaded previously in the tray, go to "CHANGING THE PAPER SIZE SETTING OF A TRAY" (p.19).
- When misfeed occurs, rotate the paper 180 degrees and reload it.
- Straighten curled paper before using it.

Loading the bypass tray

To feed an envelope, first press down the fusing unit release levers (2 places) to release the pressure, and then follow the steps below.

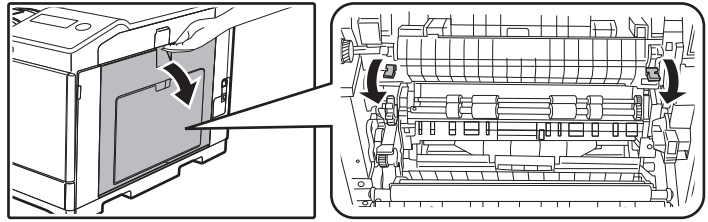

1 Open the bypass tray.

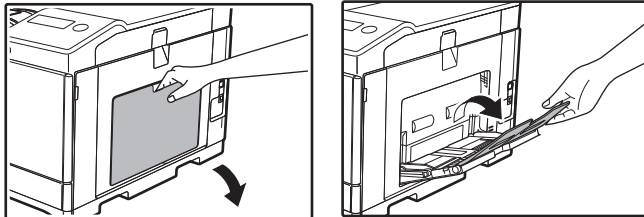

Open out the bypass tray extension.

2 Push the centre of the pressure plate down until it locks into place.

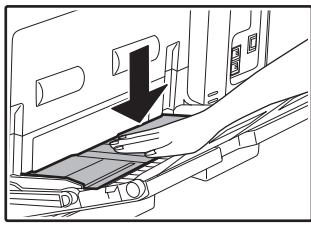

3 Set the paper guides to the paper width.

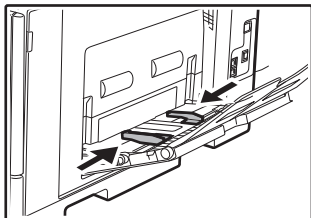

4 Insert the paper (print face down) all the way into the bypass tray.

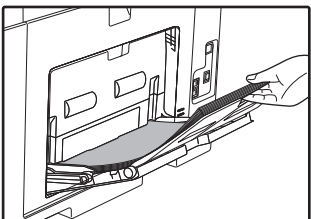

To prevent a misfeed, verify once more that the paper guides are adjusted to the width of the paper.



After feeding an envelope, be sure to press up and return the fusing unit release levers (2 places) to their original positions.



If you loaded paper into the bypass tray, press the [SPECIAL FUNCTION] key (**F_n**) and select "Paper Select" to select the bypass tray.

Important points when inserting paper in the bypass tray

- Up to 50 sheets of standard paper can be set in the bypass tray.
- Be sure to place A6, B6 or 5-1/2" x 8-1/2" size paper or envelopes horizontally as shown in the following diagram.

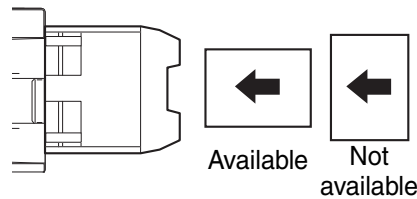

- To feed an envelope, first press down the fusing unit release levers (2 places) to release the pressure. (p.17)
- When loading envelopes, make sure that they are straight and flat and do not have loosely glued construction flaps (not the closure flap).
- Special papers except SHARP recommended transparency film, labels, and envelopes must be fed one sheet at a time through the bypass tray.
- When adding paper, first remove any paper remaining in the tray, combine it with the paper to be added and then reload as a single stack. The paper to be added must be the same size and type as the paper already in the tray.
- Use SHARP-recommended transparency film.
- Do not use paper that is smaller than the original. This may cause smudges or unclean images.
- Do not use paper that has already been printed on by a laser printer or plain paper fax machine. This may cause smudges or unclean images.

Important points when using envelopes

Envelopes that cannot be used

Do not use the following envelopes. Envelopes misfeed, and smudges may result.

- Envelopes with metal clasps, plastic hooks, or ribbon hooks
- Envelopes closed with string
- Envelopes with windows or backing
- Envelopes with an uneven front surface due to embossing
- Double-layer envelopes
- Envelopes with an adhesive for sealing
- Hand-made envelopes
- Envelopes with air inside
- Envelopes with creases, fold marks, torn or damaged envelopes
- Envelopes with an incorrectly aligned corner gluing position on the back cannot be used as creasing may result.

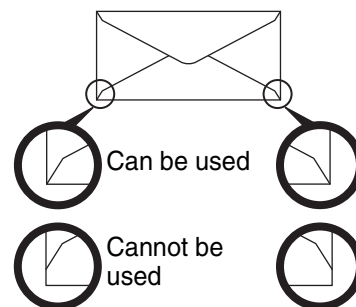

Print quality on envelopes

- Print quality is not guaranteed in the area 10 mm (13/32") around the edges of the envelope.
- Print quality is not guaranteed on parts of envelopes where there is a large step-like change of thickness, such as on four-layer parts or parts less than three layers.
- Print quality is not guaranteed on envelopes with adhesive for sealing.

Inserting transparency film

- Use SHARP-recommended transparency film.
- Do not touch the print side of transparency film.
- When loading multiple sheets of transparency film in the bypass tray, be sure to fan the sheets several times before loading.
- When printing on transparency film, be sure to remove each sheet as it exits the machine. Allowing sheets to stack in the output tray may result in curling.

TRAY SETTINGS

These programs are used to change the paper size setting of a tray, and auto tray switching.

CHANGING THE PAPER SIZE SETTING OF A TRAY

If the size of the loaded paper is different from the size shown in the display, follow the steps below to change the paper size setting of the tray.

The paper size setting cannot be changed during printing, or when a misfeed has occurred. However, if the machine is out of paper or out of toner, the paper size setting can be changed during printing.

See "USEABLE PAPER" (p.13) for information on the specifications for the types and sizes of paper that can be loaded in the paper trays.

Press the [SPECIAL FUNCTION] key (F_n), and press the [▼] or [▲] key to select "Paper Size Set".

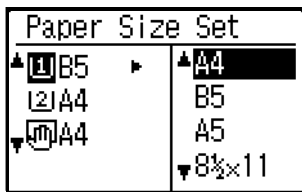

Press the [▼] or [▲] key to select the paper tray for which the paper size is being changed. Press the [▶] key and press the [▼][▲] keys to select the paper size.

Press the [OK] key.



- [1]: Shows tray "1".
- [2]: Shows tray "2".
- [Bypass tray icon]: Shows Bypass tray.

For the paper trays and tray numbers, see "USEABLE PAPER" (p.13).

DISABLING (ENABLING) AUTO TRAY SWITCHING

When auto tray switching is enabled and paper runs out during printing, the job will continue using paper from a different tray if that tray has the same size of paper in the same type. (This function does not operate when using the bypass tray.)

This function has been enabled at the factory. If you prefer to disable the function, follow the steps below.

Press the [SPECIAL FUNCTION] key (F_n), select "Paper Size", and press the [▼] key repeatedly until "Auto Tray Switching" appears.

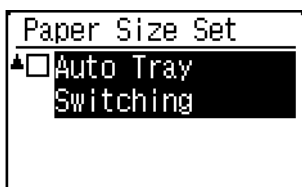

To re-enable auto tray switching, press the [OK] key that a checkmark appears.

CHANGING THE PAPER TYPE OF A TRAY

To change the paper type setting for a tray, follow the steps below.

Press the [SPECIAL FUNCTION] key (Fn), select "Paper Type", select the tray with the [▼] or [▲] key, and press the [OK] key. Select the desired paper type and press the [OK] key.

See "USEABLE PAPER" (p.13) for information on the specifications for the types and sizes of paper that can be loaded in the paper trays.

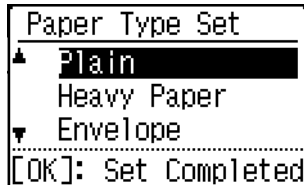

USER AUTHENTICATION MODE

When user authentication mode is enabled, a count is kept of the pages printed by each account. The page counts can be viewed in the display.

This function is enabled in the system settings. ("User Registration" (p.90))

Up to 30 can be stored.

USING USER AUTHENTICATION MODE

When user authentication mode is turned on, the account number entry screen is displayed. Enter your account number (five-digit identification number) as explained below before operating the machine.



1 Enter your account number (five digits) with the numeric keys.

As the account number is entered, the hyphens (-) change to asterisks (*). If you enter an incorrect digit, press [C] key and re-enter the correct digit.

2 When the job is finished, press the [LOGOUT] key (E→).



- When a valid account number is entered, the current count of the account will appear in the message display of the base screen. After 6 seconds (factory default setting), the base screen appears. (p.10)
- If an invalid account number is entered in step 1, the account number entry screen reappears.
- When "A Warning when Login Fails" (p.90) in the system settings is enabled, a warning message will appear and operation will not be permitted for 1 minute if an invalid account number is entered 3 times in a row.

Colour	Copies Made:00,000,000
	Remaining:00,000,000
B/W	Copies Made:00,000,000
	Remaining:00,000,000

ENTERING CHARACTERS

This section explains how to enter characters.

CHARACTERS THAT CAN BE ENTERED

Upper case alphabet, lower case alphabet, numbers, special characters, symbols.

Characters are entered by pressing the numeric keys on the operation panel. The letters entered with each numeric key are shown below.

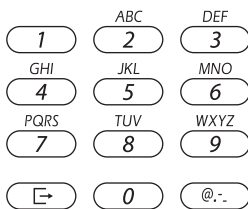

Key	Characters that can be entered
1	1 Space
2	a b c 2 A B C
3	d e f 3 D E F
4	g h i 4 G H I
5	j k l 5 J K L
6	m n o 6 M N O
7	p q r s 7 P Q R S
8	t u v 8 T U V
9	w x y z 9 W X Y Z
0	0
@,.-	# @ . - _ ! " \$ % & ' () + , ; = < > ? [] { } *



To enter two characters in succession that require the same key, press the [▶] key to move the cursor after entering the first character.

Example: Entering "ab"

Press the [2] key once, press the [▶] key once to move the cursor, and then press the [2] key twice.

PRINTER FUNCTION OF THE MACHINE

The machine is equipped with a full colour printing function as standard. To enable printing from your computer, a printer driver must be installed.

See the table below to determine which printer driver to use in your environment.

Environment	Printer driver type
Windows	PCL6 The machine supports the Hewlett-Packard PCL6 printer control languages.
Windows / Macintosh	PS This printer driver supports the PostScript 3 page description language developed by Adobe Systems Incorporated, and enables the machine to be used as a PostScript 3 compatible printer. (A PPD file is available if it is desired to use the Windows standard PS printer driver.)

Installing the printer driver in a Windows environment

To install the printer driver and configure settings in a Windows environment, see in the Software Setup Guide.



The explanations in this manual of printing in a Windows environment generally use the screens of the PCL6 printer driver. The printer driver screens may differ slightly depending on the printer driver that you are using.

Installing the printer driver in a Macintosh environment

To install the printer driver and configure settings in a Macintosh environment, see in the Software Setup Guide.

PRINTING FROM WINDOWS

PRINTER DRIVER PROPERTIES WINDOW

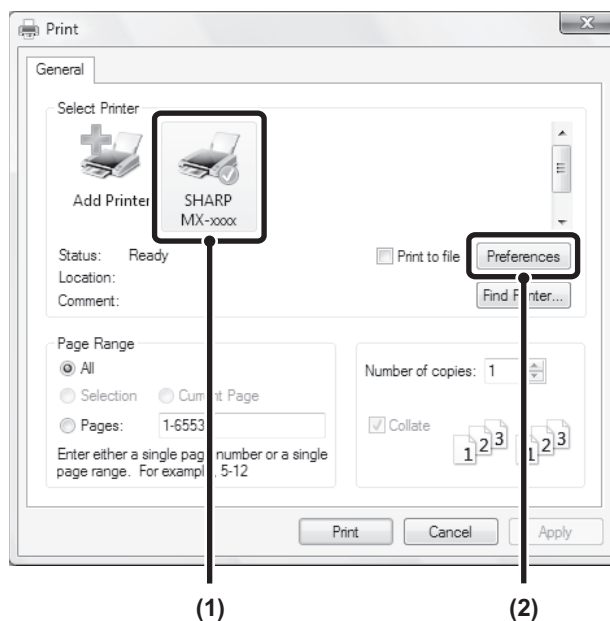

(1) Select the printer driver of the machine.

- If the printer drivers appear as icons, click the icon of the printer driver to be used.
- If the printer drivers appear as a list, select the name of the printer driver to be used from the list.

(2) Click the [Preferences] button.



The button that is used to open the printer driver properties window (usually [Properties] or [Printing Preferences]) may vary depending on the software application.

BASIC PRINTING PROCEDURE

The following example explains how to print a document from "WordPad", which is a standard accessory program in Windows.

- 1** Select [Print] from the [File] menu of WordPad.
- 2** Open the printer driver properties window.
- 3** Select print settings.

- (1)** Click the [Paper] tab.
- (2)** Select the paper size.
To select settings on other tabs, click the desired tab and then select the settings.
- (3)** Click the [OK] button.



- Make sure the paper size is the same as the paper size set in the software application.
- Up to eight custom paper sizes can be stored. Storing a custom paper size makes it easy to specify that size each time you need to use it.
To store a paper size, select [Custom Paper] or one of [User1] to [User7] from the pull-down menu and click the [Custom] button.

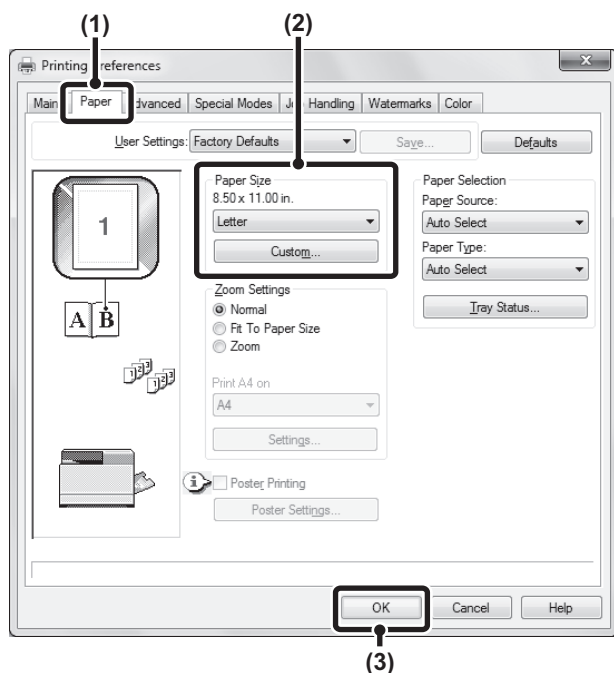

4 Click the [Print] button.

Printing begins.

SELECTING THE PAPER

This section explains how to configure the "Paper Selection" setting on the [Paper] tab of the printer driver properties window.

Before printing, check the paper sizes, paper types, and paper remaining in the machine's trays. To view the most recent tray information, click the [Tray Status] button.

- When [Auto Select] is selected in "Paper Source"
The tray that has the size and type of paper selected in "Paper Size" and "Paper Type" on the [Paper] tab is automatically selected.
- When other than [Auto Select] is selected in "Paper Source"
The specified tray is used for printing regardless of the "Paper Size" setting.
- When [Bypass Tray] is selected
The "Paper Type" must also be selected. Check the bypass tray and make sure that the desired type of paper is loaded, and then select the appropriate "Paper Type" setting.

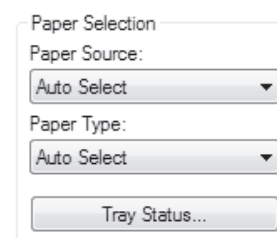

Special media such as envelopes can also be placed in the bypass tray. For the procedure for loading paper and other media in the bypass tray, see "Loading the bypass tray" (P.17) .

- When [Auto Select] is selected in "Paper Type"
A tray with plain paper of the size specified in "Paper Size" is automatically selected.
- When other than [Auto Select] is selected in "Paper Type"
A tray with the specified type of paper and the size specified in "Paper Size" is used for printing.

PRINTING ON ENVELOPES

The bypass tray can be used to print on special media such as envelopes. The procedure for printing on an envelope from the printer driver properties screen is described below.

For the types of paper that can be used in the bypass tray, see "USEABLE PAPER" (P.13). For the procedure for loading paper in the bypass tray, see "Loading the bypass tray" (P.17).

Select the envelope size in the appropriate settings of the application ("Page Settings" in many applications) and then perform the following steps.

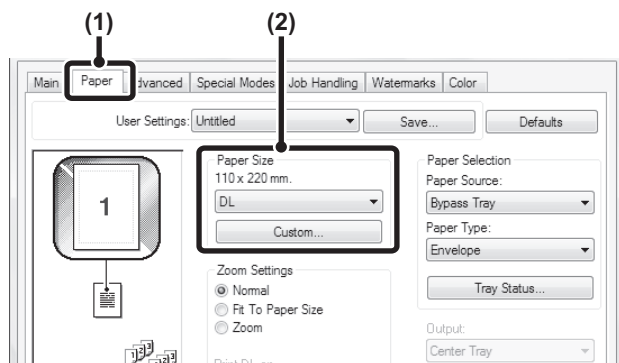

- (1) Click the [Paper] tab.
- (2) Select the envelope size from the "Paper Size" menu.

The paper tray and paper type are automatically selected.



- It is recommended that you do a test print to check the print result before using an envelope.
- In the case of media that can only be loaded in a certain orientation such as an envelope, you can rotate the image 180 degrees if needed. For more information, see "ROTATING THE PRINT IMAGE 180 DEGREES (Rotate 180 degrees)" (P.45).
- When feeding an envelope, push down the fusing unit release levers (see p.8) to release the pressure.

PRINTING WHEN THE USER AUTHENTICATION FUNCTION IS ENABLED

When the user authentication function is enabled in the machine's system settings (administrator), your user number must be entered in the printer driver properties window before you can print.

1 Open the printer driver properties window from the print window of the software application.

2 Enter your user number.

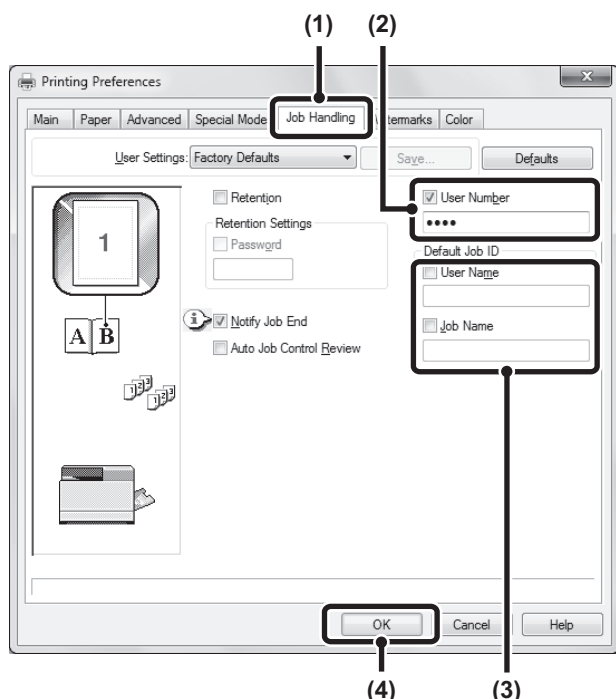

(1) Click the [Job Handling] tab.

(2) Enter your user number.

When authentication is by user number. Click the [User Number] checkbox and enter a user number (5 digits).



When [User Number] has been checked on [Printing Policy] in the [Configuration] tab, you cannot enter the user number. Enter the user information in the dialog box whenever you print.

(3) Enter the user name and job name as necessary.

- **User Name**
Click the [User Name] checkbox and enter your user name (maximum of 32 characters). Your entered user name will appear at the top of the operation panel. If you do not enter a user name, your computer login name will appear.
- **Job Name**
Click the [Job Name] checkbox and enter a job name (maximum of 80 characters). The entered job name will appear at the top of the operation panel as a file name. If you do not enter a job name, the file name set in the software application will appear.

(4) Click the [OK] button.



To have a confirmation window appear before printing starts, select the [Auto Job Control Review] checkbox so that a checkmark appears.

3 Start printing.

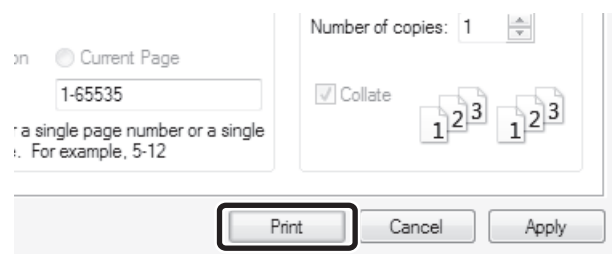

- The machine's user authentication function cannot be used when the PPD file* is installed and the Windows standard PS printer driver is used. For this reason, printing will not be possible if printing by invalid users is prohibited in the system settings (administrator).
*The PPD file enables the machine to print using the standard PS printer driver of the operating system.
System Setting(Administrator):Disable Print by Inv. User
- "Disable Print by Inv. User" can be enabled in the machine's system settings (Administrator) to prohibit print jobs of users whose user information is not stored in the machine. When this function is enabled, printing is not allowed when user information is not entered or incorrect information is entered.

VIEWING PRINTER DRIVER HELP

When selecting settings in the printer driver, you can display Help to view explanations of the settings.

- 1** Open the printer driver properties window from the print window of the software application.
- 2** Click the [Help] button.

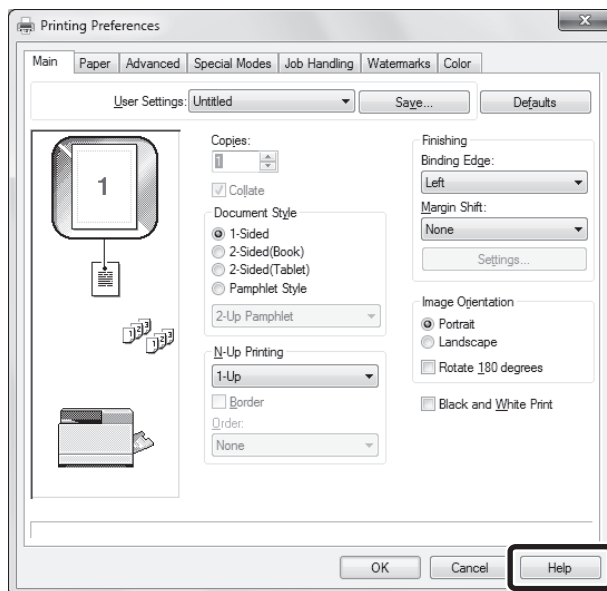

The Help window will open to let you view explanations of the settings on the tab. To view Help for settings in a dialog box, click the underlined text at the top of the Help window.

Pop-up help

Help can be displayed for a setting by clicking the setting and pressing the [F1] key.

* To view Help for a setting in Windows XP/Server 2003, click the  button in the upper right-hand corner of the printer driver properties window and then click the setting.

Information icon

Some restrictions exist on the combinations of settings that can be selected in the printer driver properties window. When a restriction exists on a selected setting, an information icon () will appear next to the setting. Click the icon to view an explanation of the restriction.

SAVING FREQUENTLY USED PRINT SETTINGS

Settings configured on each of the tabs at the time of printing can be saved as user settings. Saving frequently used settings or complex colour settings under an assigned name makes it easy to select those settings the next time you need to use them.

SAVING SETTINGS AT THE TIME OF PRINTING

Settings can be saved from any tab of the printer driver properties window. Settings configured on each tab are listed at the time of saving, allowing you to check the settings as you save them.

1 Open the printer driver properties window from the print window of the software application.

2 Save the print settings.

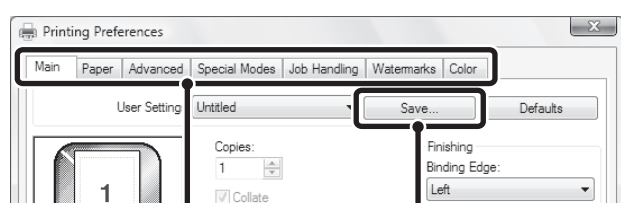

- (1) Configure print settings on each tab.
- (2) Click the [Save] button.

3 Check and save the settings.

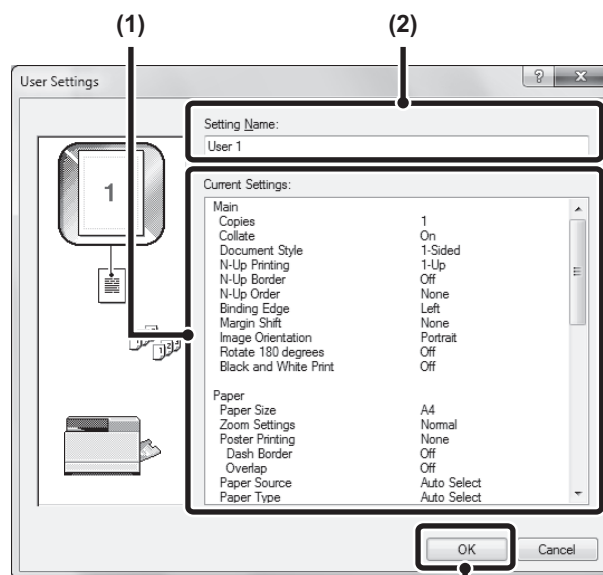

- (1) Check the displayed settings.
- (2) Enter a name for the settings (maximum of 20 characters).
- (3) Click the [OK] button.

4 Click the [OK] button.

5 Start printing.



- Up to 30 sets of user settings can be saved.
- The following items cannot be saved in user settings.
 - A watermark that you created
 - Paper insertion settings
 - Overlay file
 - The user number, user name, and job name entered in the [Job Handling] tab

USING SAVED SETTINGS

- 1 Open the printer driver properties window from the print window of the software application.
- 2 Select the print settings.

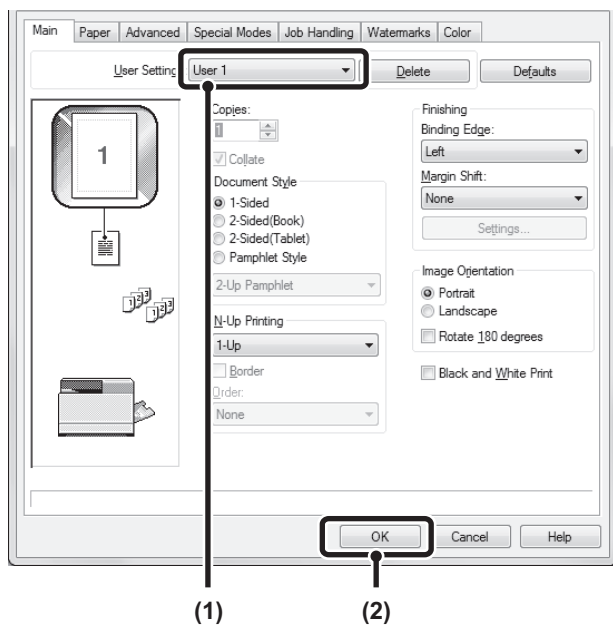

- (1) Select the user settings that you wish to use.
- (2) Click the [OK] button.

- 3 Start printing.

Deleting saved settings

Select the user settings that you want to delete in (1) of step 2 above, and click the [Delete] button.

CHANGING THE PRINTER DRIVER DEFAULT SETTINGS

The default settings of the printer driver can be changed using the procedure below. The settings selected using this procedure are saved and become the default settings when printing from a software application. (Settings selected in the printer driver properties window when printing from an application remain in effect only while the application is in use.)

1 Click the [Start] button () and select [Control Panel] and then [View devices and printers].

- In Windows XP/Server 2003, click the [start] button and then click [Printers and Faxes].
- In Windows 8/8.1/Server 2012, right-click the start screen (or swipe up from the bottom edge of the screen), and click [All apps] - [Control Panel] - [View devices and printers] - [Printer] on the taskbar.

Note In Windows XP, if [Printers and Faxes] does not appear in the [start] menu, select [Control Panel], select [Printers and Other Hardware], and then select [Printers and Faxes].

2 Open the printer properties window.

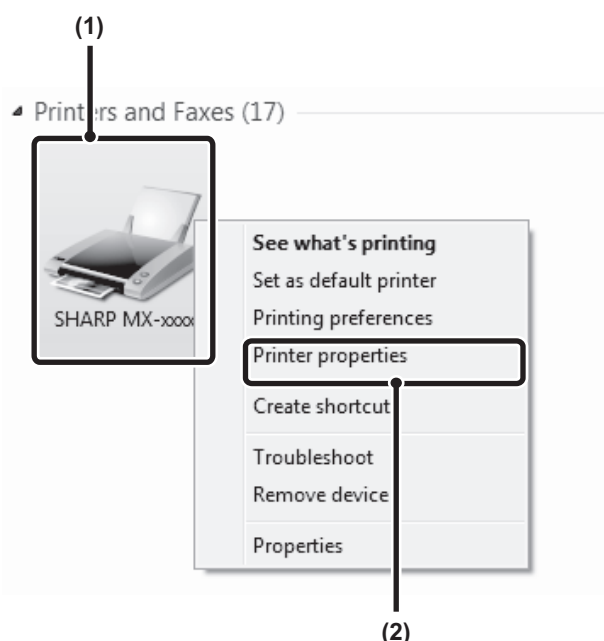

- (1) **Right-click the icon of the printer driver of the machine.**
- (2) **Select [Printer properties].**
In Windows XP/Server 2003, click the [File] menu.

3 Click the [Printing Preferences] button on the [General] tab.

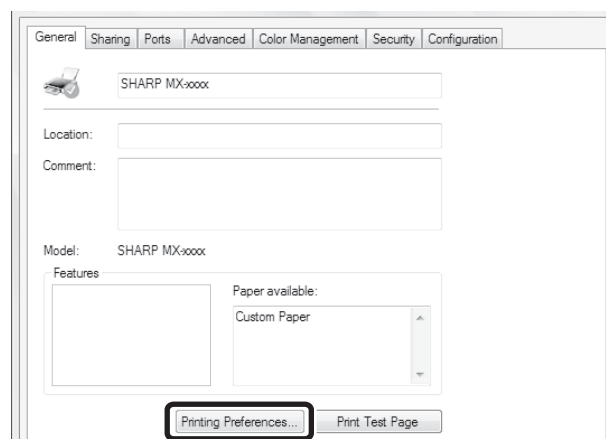

4 Configure the settings and click the [OK] button.

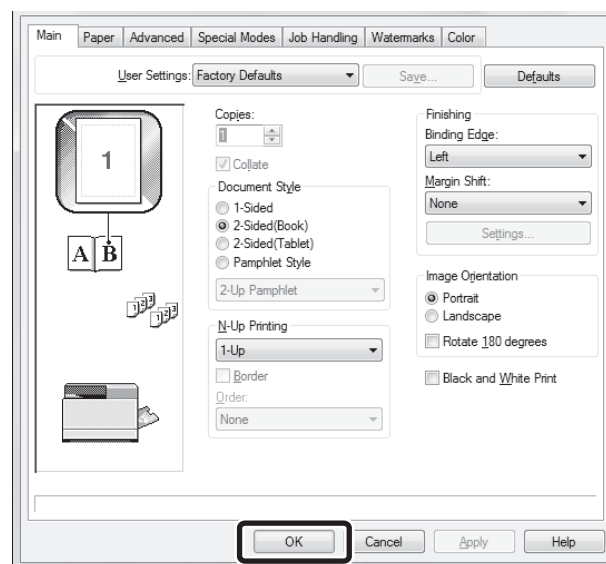

For explanations of the settings, see printer driver Help.

PRINTING FROM A MACINTOSH

BASIC PRINTING PROCEDURE

The following example explains how to print a document from the standard accessory program "TextEdit" in Mac OS X.



To use the machine for the Macintosh, the machine must be connected to a network.
To install the PPD file and configure printer driver settings, see Software Setup Guide.

SELECTING PAPER SETTINGS

Select paper settings in the printer driver before selecting the print command.

1 Select [Page Setup] from the [File] menu of TextEdit.

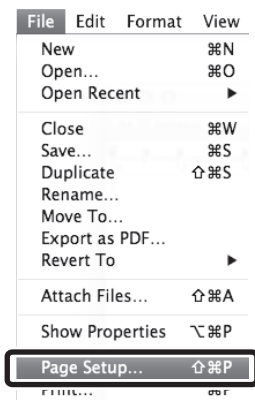

2 Select paper settings.

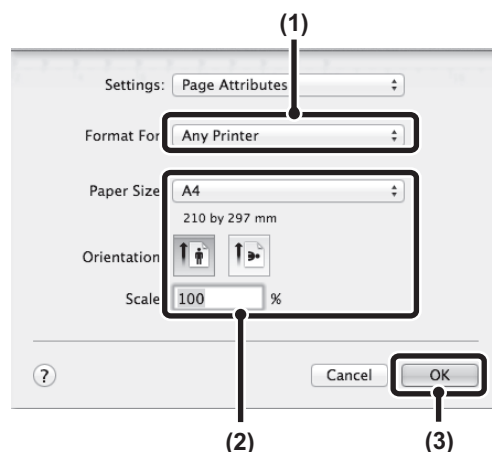

- (1) Make sure that the correct printer is selected.
- (2) Select paper settings.
The paper size, paper orientation, and enlarge/reduce can be selected.
- (3) Click the [OK] button.

PRINTING

1 Select [Print] from the [File] menu of TextEdit.

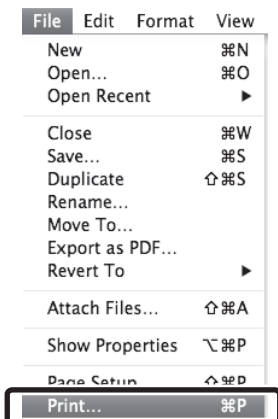

2 Make sure that the correct printer is selected.

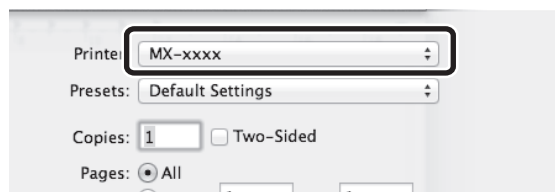



Depending on the OS, the machine name that appears in the "Printer" menu is [MX-xxxx]. ("xxxx" is a sequence of characters that varies depending on the machine model.)

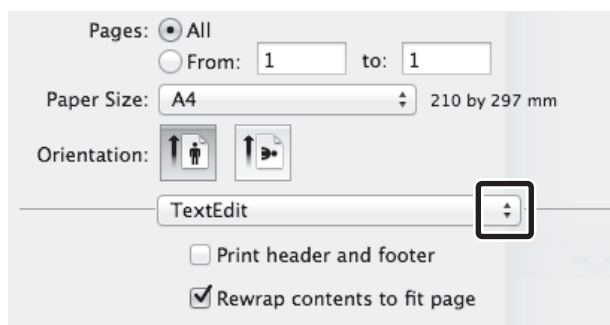

The menu used to execute printing may vary depending on the software application.

3 Select print settings.



Click  in the menu to select a setting. The corresponding setting screen will appear. If the settings do not appear in Mac OS X v10.5, 10.6 and 10.7, click "" next to the printer name.

4 Click the [Print] button.

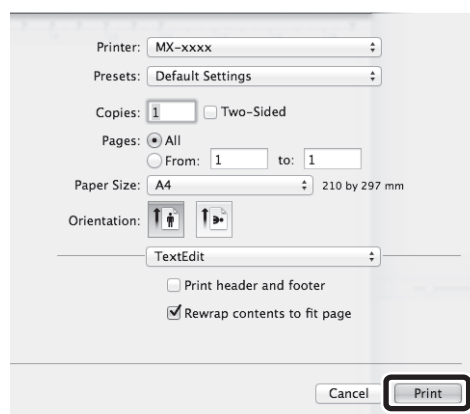

Printing begins.

SELECTING THE PAPER

This section explains the [Paper Feed] settings in the print settings window.

- When [Auto Select] is selected
A tray with plain paper or recycled paper (the factory default setting is plain paper only) of the size specified in "Paper Size" in the page settings window is automatically selected.
- When a paper tray is selected
The specified tray is used for printing regardless of the "Paper Size" setting in the page settings window. For the bypass tray, a paper type can also be specified. Make sure that the paper type setting for the bypass tray is correct and that the set type of paper is actually loaded in the bypass tray, and then select the appropriate bypass tray (paper type).



- Special media such as envelopes can also be placed in the bypass tray. For the procedure for loading paper and other media in the bypass tray, see "Loading the bypass tray" (P.17).
- When "Enable Detected Paper Size in Bypass Tray" (disabled by factory default) or "Enable Selected Paper Type in Bypass Tray" (enabled by factory default) is enabled in the system settings (administrator), printing will not take place if the paper size or paper type specified in the printer driver is different from the paper size or paper type specified in the settings of the bypass tray.

- When a paper type is selected
A tray with the specified type of paper and the size specified in "Paper Size" in the page settings window is used for printing.

PRINTING ON ENVELOPES

The bypass tray can be used to print on special media such as envelopes. The procedure for printing on an envelope from the printer driver properties screen is described below.

For the types of paper that can be used in the bypass tray, see "USEABLE PAPER" (P.13). For the procedure for loading paper in the bypass tray, see "Loading the bypass tray" (P.17).

Select the envelope size in the appropriate settings of the application ("Page Settings" in many applications) and then perform the following steps.

1 Select the paper size.

Select the envelope size from the "Paper Size" menu on the page setup screen.



In the case of media that can only be loaded in a certain orientation such as an envelope, you can rotate the image 180 degrees if needed. For more information, see "ROTATING THE PRINT IMAGE 180 DEGREES (Rotate 180 degrees)" (P.45)".

2 Select the bypass tray.

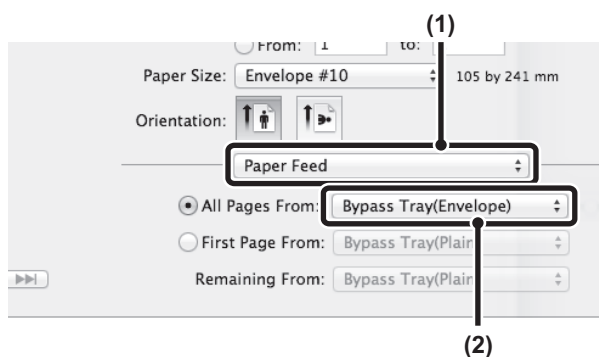

(1) Select [Paper Feed] on the print screen.

(2) Select [Bypass Tray(Envelope)] from the "All Pages From" menu.

Set the bypass tray paper type to [Envelope] in the machine's "Paper Type Setup", and make sure that an envelope is loaded in the bypass tray.



It is recommended that you do a test print to check the print result before using an envelope.

PRINTING WHEN THE USER AUTHENTICATION FUNCTION IS ENABLED

When the user authentication function is enabled in the machine's system settings (administrator), you must enter your user number in order to print.

1 Select [Print] from the application's [File] menu.

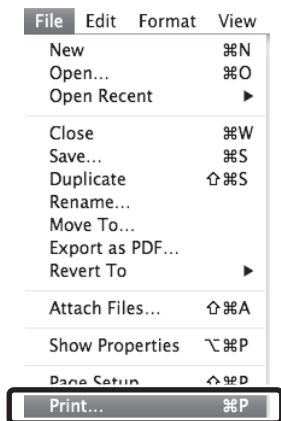

The menu used to execute printing may vary depending on the software application.

2 Display the job handling screen.

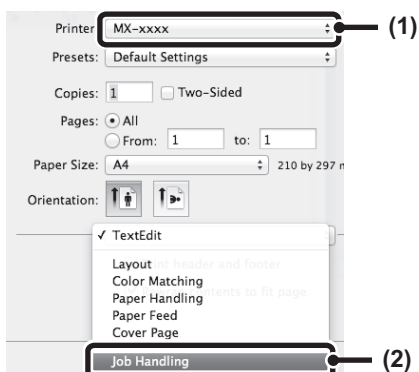

- (1) Make sure that the machine's printer name is selected.
- (2) Select [Job Handling] and then click the [Authentication] tab in the screen that appears.

In Mac OS X v10.4, select [Job Handling].



Depending on the OS, the machine name that appears in the "Printer" menu is [MX-xxxx]. ("xxxx" is a sequence of characters that varies depending on the machine model.)

3 Start printing.

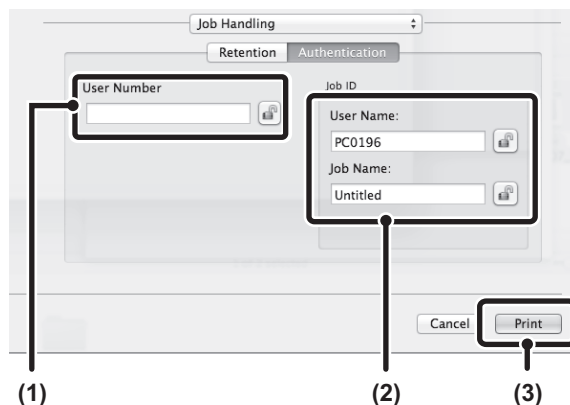

(1) Enter your user information.

When authentication is by user number
Enter your user number (5 digits) in "User Number".

(2) Enter the user name and job name as necessary.

- User Name

Enter your user name (maximum of 32 characters). Your entered user name will appear at the top of the operation panel. If you do not enter a user name, your computer login name will appear.

- Job Name

Enter a job name (maximum of 30 characters). The entered job name will appear at the top of the operation panel as a file name. If you do not enter a job name, the file name set in the software application will appear.

(3) Click the [Print] button.



You can click the  (lock) button after entering your login name and password, or user number, to simplify operation the next time you wish to print based on the same user authentication.



"Disable Print by Inv. User" can be enabled in the machine's system settings (Administrator) to prohibit print jobs of users whose user information is not stored in the machine.

FREQUENTLY USED FUNCTION

This section explains frequently used functions.

- "SELECTING THE COLOUR MODE" (P.35)
- "TWO-SIDED PRINTING" (P.38)
- "FITTING THE PRINT IMAGE TO THE PAPER" (P.39)
- "PRINTING MULTIPLE PAGES ON ONE PAGE" (P.40)

The explanations assume that the paper size and other basic settings have already been selected. For the basic procedure for printing and the steps for opening the printer driver properties window, see the following section:

- Windows : "BASIC PRINTING PROCEDURE" (P.24)
- Macintosh : "BASIC PRINTING PROCEDURE" (P.31)



In Windows, view printer driver Help for details on printer driver settings for each printing function.

SELECTING THE COLOUR MODE

This section explains how to select the colour mode in the printer driver properties window. The following three selections are available for the colour mode:

- Automatic:** The machine automatically determines whether each page is colour or black and white and prints the page accordingly. Pages with colours other than black and white are printed using Y (Yellow), M (Magenta), C (Cyan) and Bk (Black) toner. Pages that are only black and white are printed using Bk (Black) toner only. This is convenient when printing a document that has both colour and black and white pages, however, the printing speed is slower.
- Color:** All pages are printed in colour. Both colour data and black and white data are printed using Y (Yellow), M (Magenta), C (Cyan) and Bk (Black) toner.
- Black and White:** All pages are printed in black and white. Colour data such as images or materials for a presentation are printed using black toner only. This mode helps conserve colour toner when you do not need to print in colour, such as when proofreading or checking the layout of a document.



When "Color Mode" is set to [Automatic]

Even if the print result is black and white, the following types of print jobs will be counted as 4-colour (Y (Yellow), M (Magenta), C (Cyan), and Bk (Black)) print jobs. To be always counted as a black and white job, select [Black and White].

- When the data is created as colour data.
- When the application treats the data as colour data even though the data is black and white.
- When an image is hidden under a black and white image.

Windows

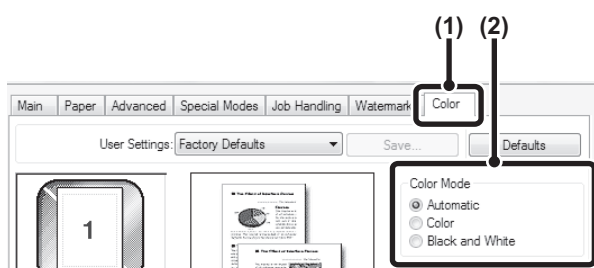

- (1) Click the [Color] tab.
- (2) Select the "Color Mode" that you wish to use.

BLACK AND WHITE PRINTING

[Black and White] can be selected on the [Main] tab as well as on the [Color] tab. Click the [Black and White Print] checkbox on the [Main] tab so that a checkmark appears.

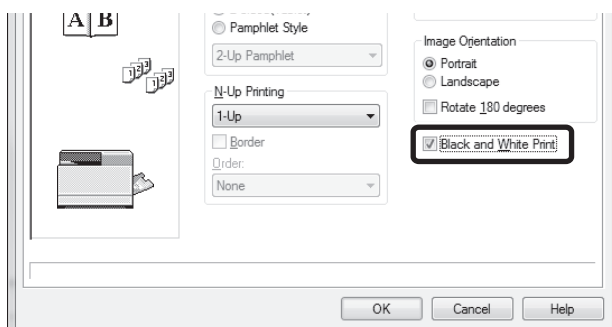

The [Black and White Print] checkbox on the [Main] tab and the "Color Mode" setting on the [Color] tab are linked. When the [Black and White Print] checkbox is selected on the [Main] tab, [Black and White] is also selected on the [Color] tab.

Macintosh

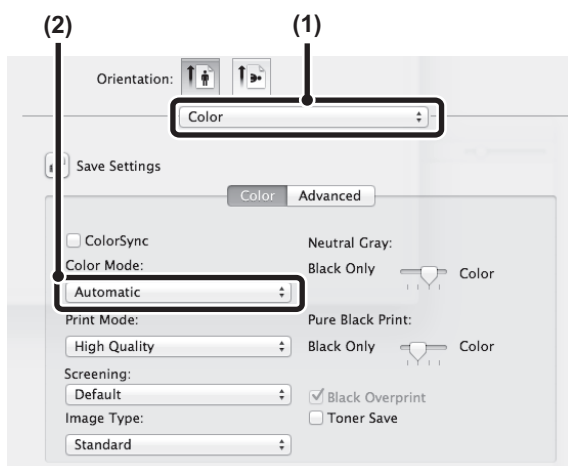

- (1) Select [Color].
- (2) Select the "Color Mode" that you wish to use.

SELECTING A PRINT MODE SETTING

This section explains the procedure for selecting a print mode setting. The "Print Mode Settings" consist of the following two items:

- Normal: This mode is suitable for printing data such as regular text or a table.
- High Quality: The print quality of colour photos and text is high.

Windows

- (1) Click the [Advanced] tab.
- (2) Select the "Print Mode".

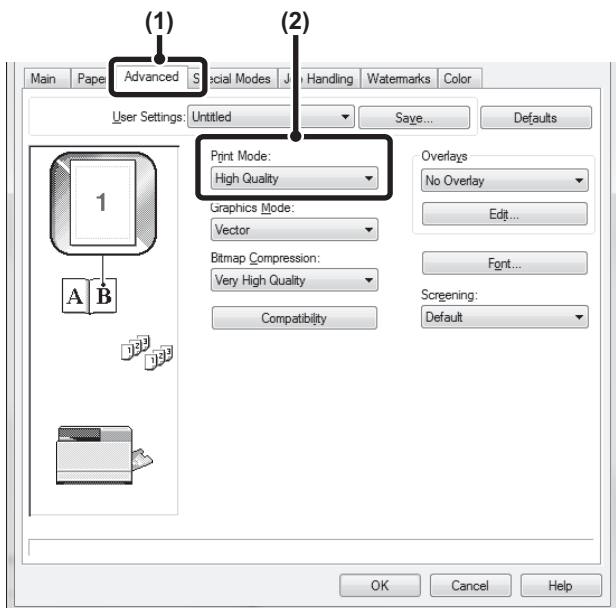



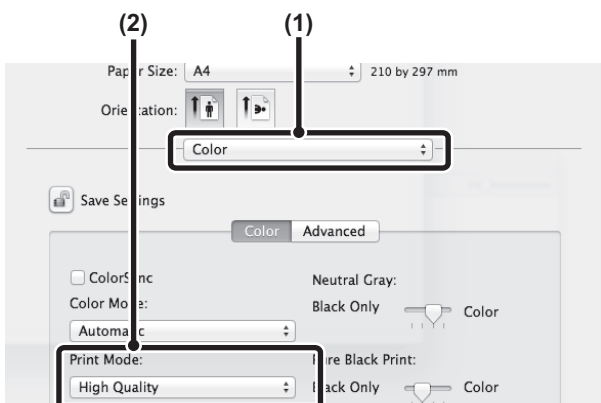

Macintosh

- (1) Select [Color].
- (2) Select the "Print Mode".



TWO-SIDED PRINTING

The machine can print on both sides of the paper. This function is useful for many purposes, and is particularly convenient when you want to create a simple pamphlet. Two-sided printing also helps conserve paper.

Paper orientation	Print results			
	Windows	Macintosh	Windows	Macintosh
Vertical	2-Sided(Book)	Long-edged binding (Flip on long edge)	2-Sided(Tablet)	Short-edged binding (Flip on short edge)
				
Horizontal	2-Sided(Book)	Short-edged binding (Flip on short edge)	2-Sided(Tablet)	Long-edged binding (Flip on long edge)
				
			The pages are printed so that they can be bound at the side.	
			The pages are printed so that they can be bound at the top.	

Windows

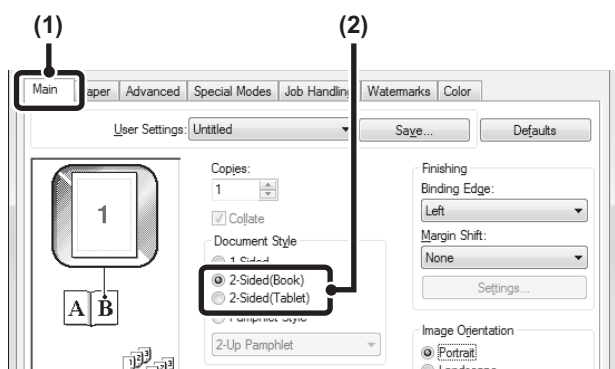

- (1) Configure the settings on the [Main] tab.
- (2) Select [2-Sided(Book)] or [2-Sided(Tablet)].

Macintosh

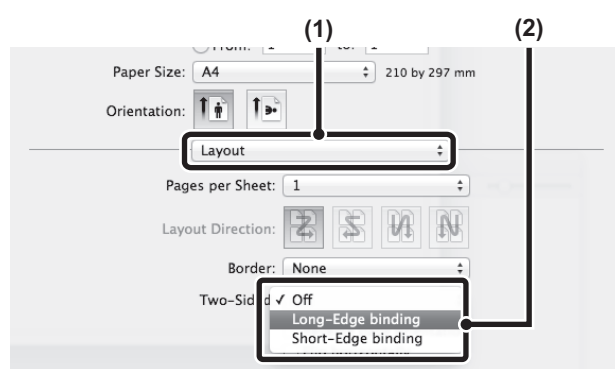

- (1) Select [Layout].
- (2) Select [Long-edged binding] or [Short-edged binding].

FITTING THE PRINT IMAGE TO THE PAPER

This function is used to automatically enlarge or reduce the printed image to match the size of the paper loaded in the machine.

This is convenient for such purposes as enlarging an A5 or invoice size document to A4 or letter size to make it easier to view, and to print when the same size of paper as the document image is not loaded in the machine.

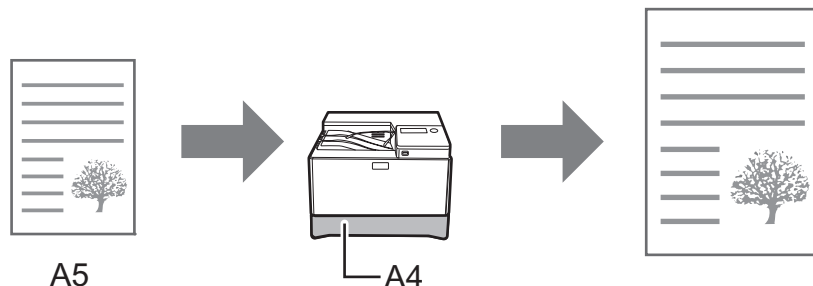

The following example explains how to print an A5 size document on A4 size paper.

Windows

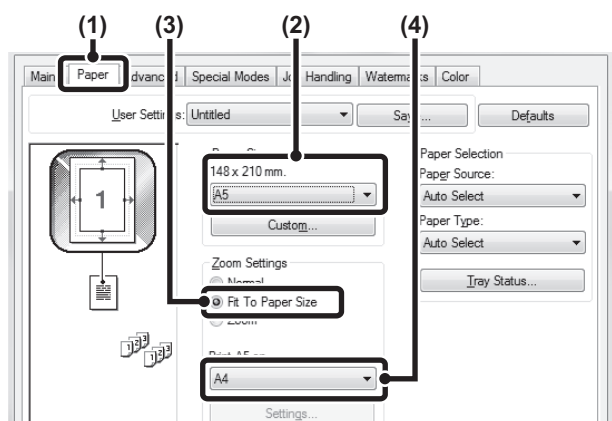

- (1) Click the [Paper] tab.
- (2) Select the size of the print image (for example: A5).
- (3) Select [Fit To Paper Size].
- (4) Select the actual paper size to be used for printing (for example: A4).

Macintosh

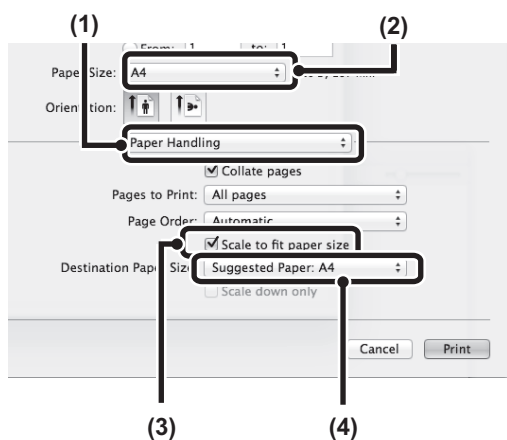





- (1) Select [Paper Handling].
- (2) Check the size of the print image (for example: A5).
To change the print image size, use the "Paper Size" menu that appears when [Page Setup] is selected.
- (3) Select [Scale to fit paper size].
- (4) Select the actual paper size to be used for printing (for example: A4).

PRINTING MULTIPLE PAGES ON ONE PAGE

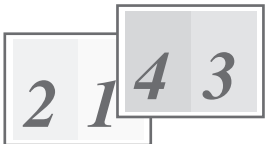
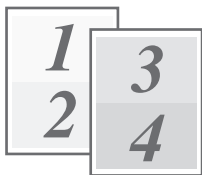
This function can be used to reduce the print image and print multiple pages on a single sheet of paper. This is convenient when you want to print multiple images such as photos on a single sheet of paper, and when you want to conserve paper. This function can also be used in combination with two-sided printing for maximum conservation of paper.

For example, when [2-Up] (2 pages per sheet) and [4-Up] (4 pages per sheet) are selected, the following print results will be obtained, depending on the order selected.

N-Up (Pages per sheet)	Print results		
	Left To Right	Right To Left	Top To Bottom (When the print orientation is landscape)
2-Up (2 pages per sheet)			

N-Up (Pages per sheet)	Right, and Down	Down, and Right	Left, and Down	Down, and Left
4-Up (4 pages per sheet)				



- The page orders for 6-Up, 8-Up, 9-Up, and 16-Up are the same as for 4-Up.
- In a Windows environment, the page order can be viewed in the print image in the printer driver properties window. In a Macintosh environment, the page orders are displayed as selections.
- In a Macintosh environment, the number of pages that can be printed on a single sheet is 2, 4, 6, 9, or 16.

Windows

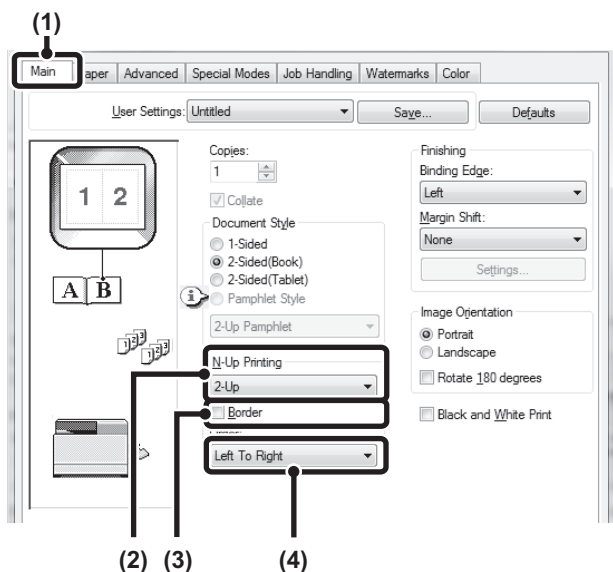

- (1) Configure the settings on the [Main] tab.
- (2) Select the number of pages per sheet.
- (3) If you wish to print borderlines, click the [Border] checkbox so that a checkmark appears.
- (4) Select the order of the pages.

Macintosh

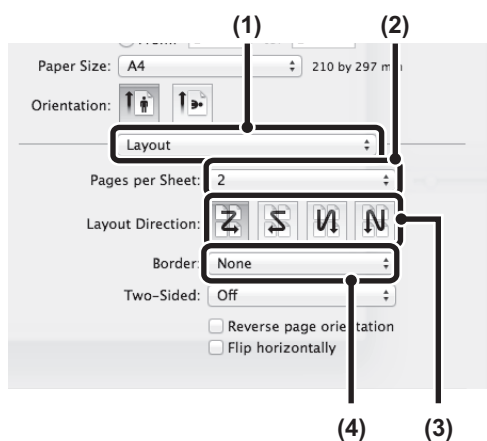

- (1) Select [Layout].
- (2) Select the number of pages per sheet.
- (3) Select the order of the pages.
- (4) If you wish to print borderlines, select the desired type of borderline.

CONVENIENT PRINTING FUNCTIONS

This section explains convenient functions for specific printing objectives.

- "CONVENIENT FUNCTIONS FOR CREATING PAMPHLETS AND POSTERS" (P.42)
- "FUNCTIONS TO ADJUST THE SIZE AND ORIENTATION OF THE IMAGE" (P.45)
- "COLOUR MODE ADJUSTMENT FUNCTION" (P.47)
- "FUNCTIONS THAT COMBINE TEXT AND IMAGES" (P.51)
- "PRINT FUNCTIONS FOR SPECIAL PURPOSES" (P.54)
- "CONVENIENT PRINTER FUNCTIONS" (P.55)

The explanations assume that the paper size and other basic settings have already been selected. For the basic procedure for printing and the steps for opening the printer driver properties window, see the following section:

- Windows : "BASIC PRINTING PROCEDURE" (P.24)
- Macintosh : "BASIC PRINTING PROCEDURE" (P.31)



In Windows, view printer driver Help for details on printer driver settings for each printing function.

CONVENIENT FUNCTIONS FOR CREATING PAMPHLETS AND POSTERS

CREATING A PAMPHLET (Pamphlet)

The pamphlet function prints on the front and back of each sheet of paper so that the sheets can be folded and bound to create a pamphlet. This is convenient when you wish to compile printed output into a pamphlet.

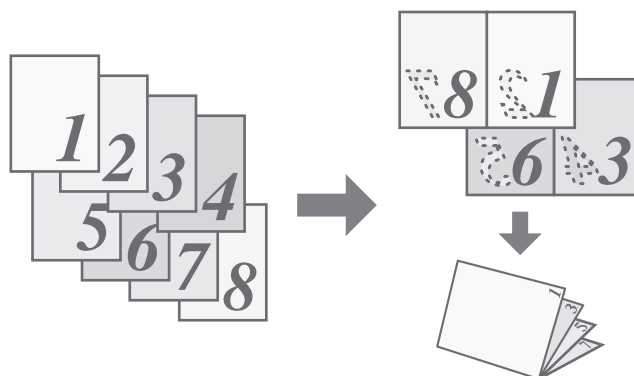

Windows

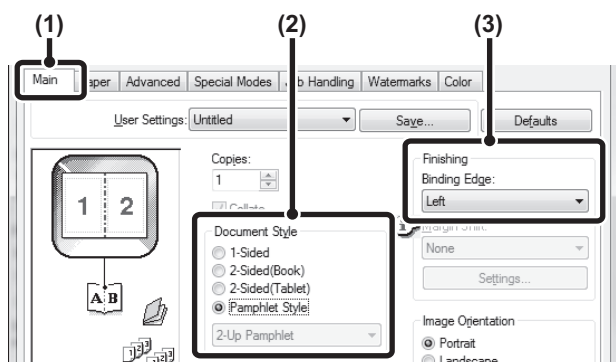

- (1) Configure the settings on the [Main] tab.
- (2) Select [Pamphlet Style]
- (3) Select the "Binding Edge".

Macintosh

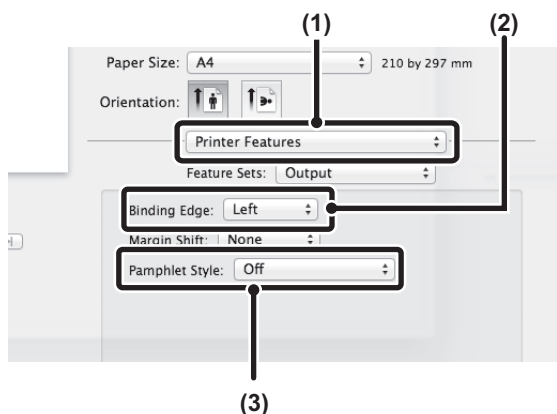

- (1) Select [Printer Features].
- (2) Select the "Binding Edge".
- (3) Select [Tiled Pamphlet] or [2-Up Pamphlet].

INCREASING THE MARGIN (Margin Shift)

This function is used to shift the print image to increase the margin at the left, right, or top of the paper. This is convenient when you wish to staple or punch the output but the binding area overlaps the text.

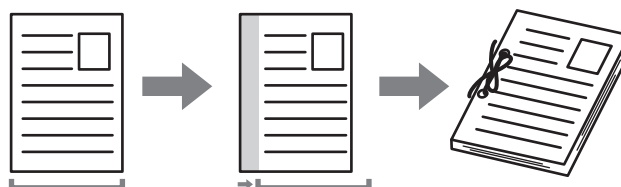

Windows

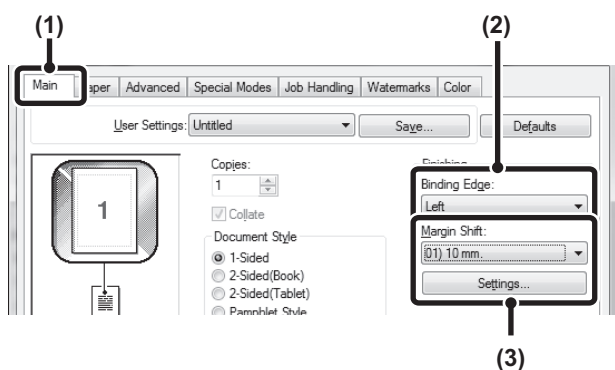

- (1) Configure the settings on the [Main] tab.
- (2) Select the "Binding Edge".
- (3) Select the "Margin Shift".
Select from the "Margin Shift" menu. If you wish to configure another numeric setting, select the setting from the pull-down menu and click the [Settings] button. Click the button or directly enter the number.

Macintosh

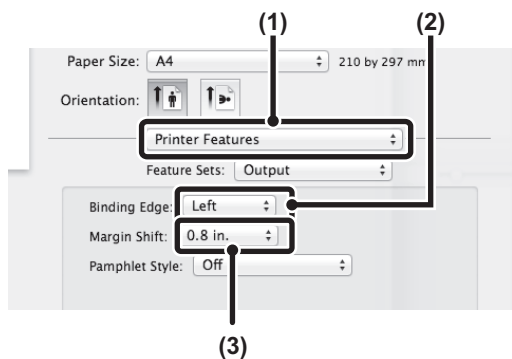

- (1) Select the "Printer Features".
- (2) Select the "Binding Edge".
- (3) Select the "Margin Shift".

CREATING A LARGE POSTER (Poster Printing)

(This function is only available in Windows.)

One page of print data can be enlarged and printed using multiple sheets of paper (4 sheets (2 x 2), 9 sheets (3 x 3) or 16 sheets (4 x 4)). The sheets can then be attached together to create a large poster. To enable precise alignment of the edges of the sheets during attachment, borderlines can be printed and overlapping edges can be created (overlap function).

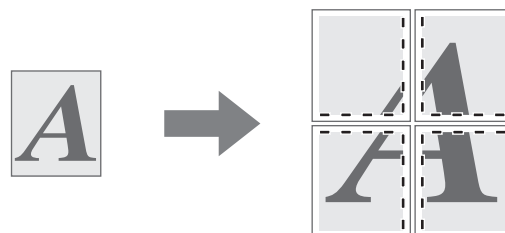

Windows

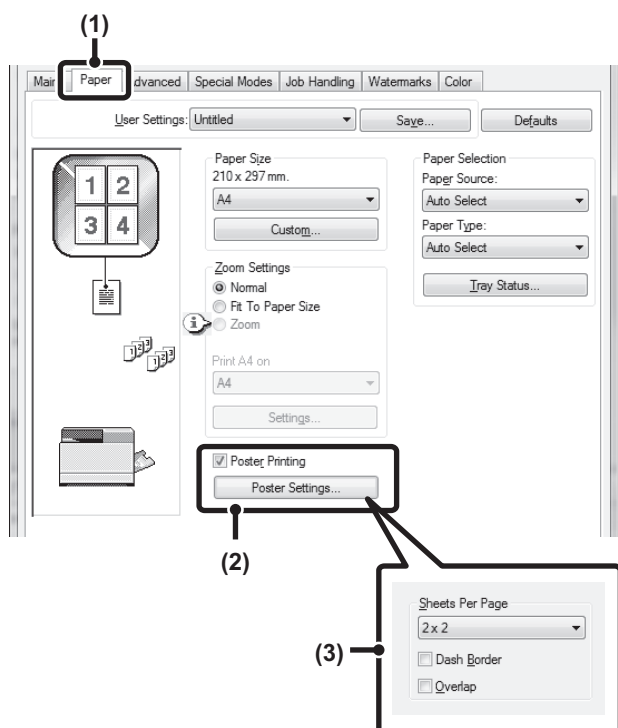

- (1) Click the [Paper] tab.
- (2) Select the [Poster Printing] checkbox and click the [Poster Settings] button.
- (3) Select poster settings. Select the number of sheets of paper to be used from the pull-down menu. If you wish to print borderlines and/or use the overlap function, select the corresponding checkboxes .

FUNCTIONS TO ADJUST THE SIZE AND ORIENTATION OF THE IMAGE

ROTATING THE PRINT IMAGE 180 DEGREES (Rotate 180 degrees)

This feature rotates the image 180 degrees so that it can be printed correctly on paper that can only be loaded in one orientation (such as envelopes or paper with punch holes). (In Mac OS X, a portrait image cannot be rotated 180 degrees.)

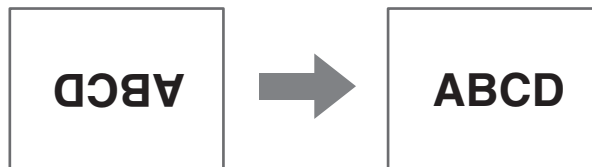

Windows

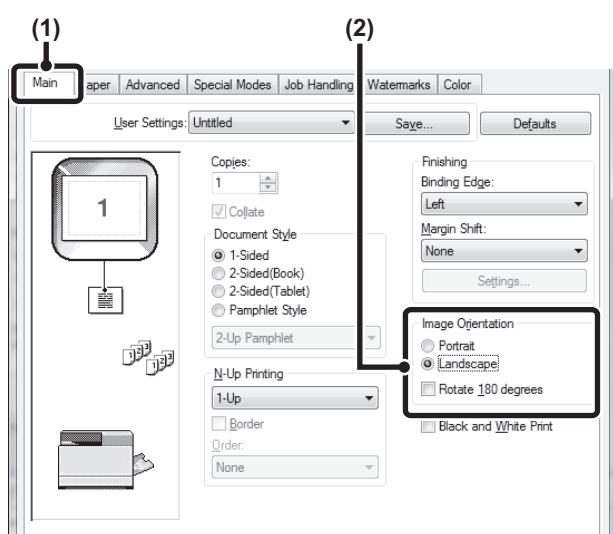

- (1) Select the setting on the [Main] tab.
- (2) Select the [Rotate 180 degrees] checkbox .

Macintosh

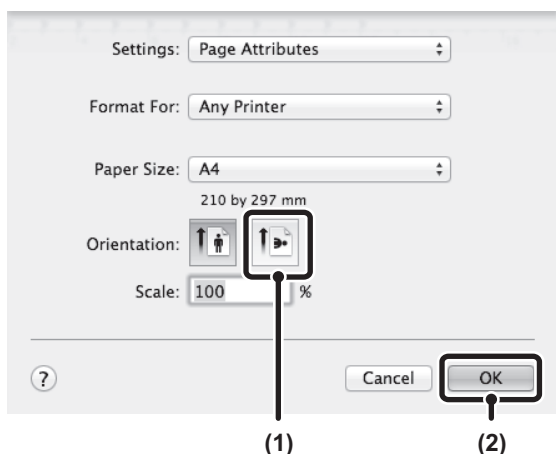

- (1) Select [Page Setup] from the [File] menu and click the button.
- (2) Click the [OK] button.

ENLARGING/REDUCING THE PRINT IMAGE (Zoom/XY-Zoom)

This function is used to enlarge or reduce the image to a selected percentage.

This allows you to enlarge a small image or add margins to the paper by slightly reducing an image.

When using the PS printer driver (Windows), you can set the width and length percentages separately to change the proportions of the image. (XY-Zoom)

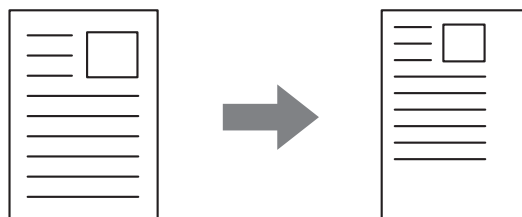

Windows

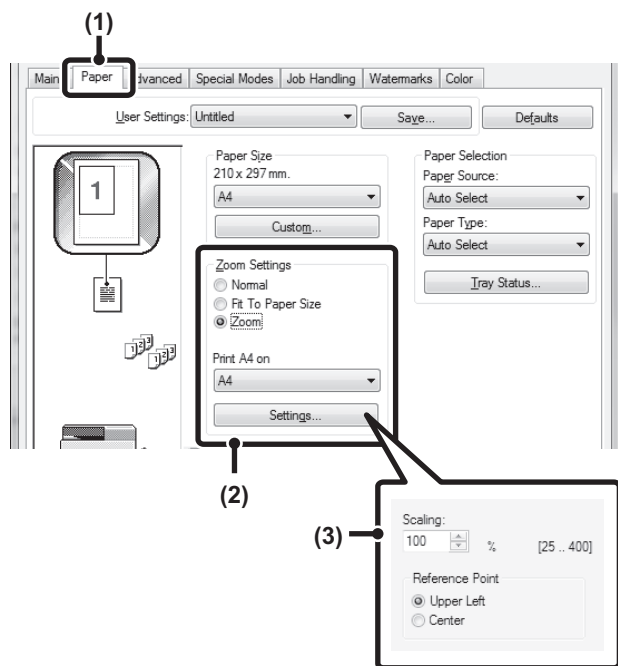

- (1) Click the [Paper] tab.
- (2) Select [Zoom] and click the [Settings] button.
The actual paper size to be used for printing can be selected from the pull-down menu.
- (3) Select the zoom ratio.
Directly enter a number (%) or click the button to change the ratio in increments of 1%. You can also select [Upper Left] or [Center] for the base point on the paper.

REVERSING THE IMAGE (Mirror Image)

The image can be reversed to create a mirror image.

This function can be used to conveniently print a design for a woodblock print or other printing medium.

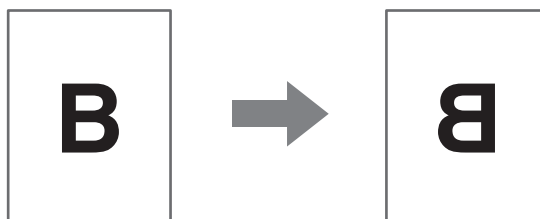

Windows

(This function can be used when the PS printer driver is used.)

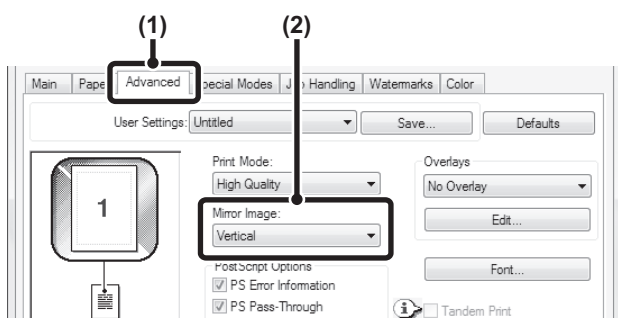

- (1) Click the [Advanced] tab.
- (2) Select a mirror image setting.
If you wish to reverse the image horizontally, select [Horizontal]. If you wish to reverse the image vertically, select [Vertical].

Macintosh

(This function can not be used in Mac OS X 10.4/10.5.)

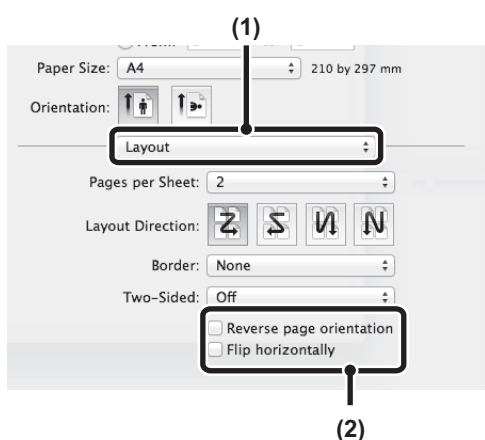

- (1) **Select [Layout].**
- (2) **Select a mirror image setting.**
 If you wish to reverse the image horizontally, select [Flip horizontally] checkbox so that a checkmark appears.
 If you wish to reverse the image vertically, select [Reverse page orientation] checkbox so that a checkmark appears.

COLOUR MODE ADJUSTMENT FUNCTION

ADJUSTING THE BRIGHTNESS AND CONTRAST OF THE IMAGE (Colour Adjustment)

The brightness and contrast can be adjusted in the print settings when printing a photo or other image. These settings can be used for simple corrections when you do not have image editing software installed on your computer.

Windows

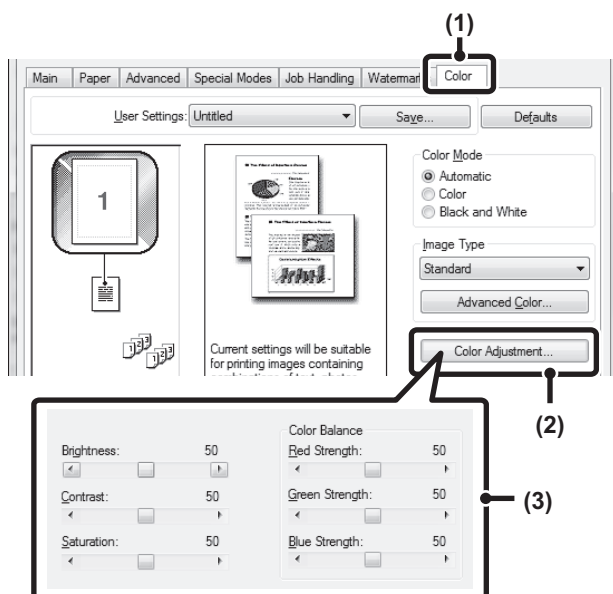

- (1) **Click the [Color] tab.**
- (2) **Click the [Color Adjustment] button.**
- (3) **Adjust the colour settings.**
 To adjust a setting, drag the slide bar or click the or button.

Macintosh

(This function can only be used in Mac OS X v10.4.)

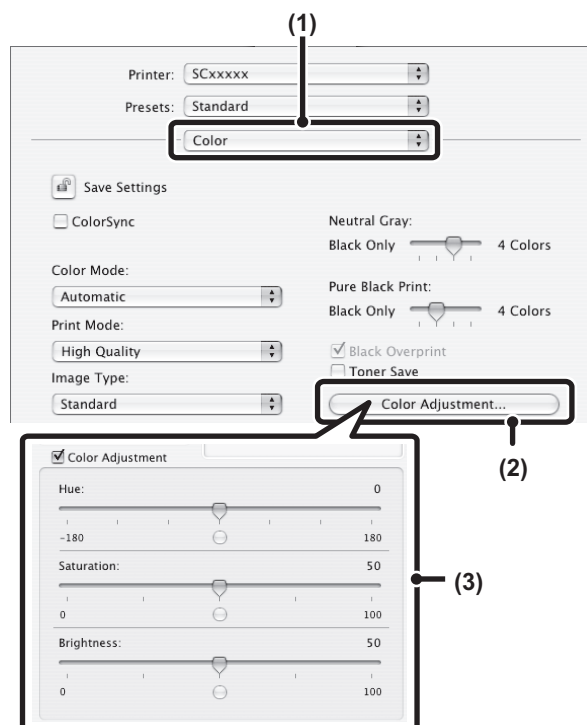

- (1) **Select [Color].**
- (2) **Click the [Color Adjustment] button.**
- (3) **Select the [Color Adjustment] checkbox and adjust the colour.**
 Adjust the settings by dragging the slide bars .

PRINTING FAINT TEXT AND LINES IN BLACK (Text To Black/Vector To Black)

(This function is only available in Windows.)

When printing a colour image in greyscale, colour text and lines that are faint can be printed in black. (Raster data such as bitmap images cannot be adjusted.) This allows you to bring out colour text and lines that are faint and difficult to see when printed in greyscale.

- [Text To Black] can be selected to print all text other than white text in black.
- [Vector To Black] can be selected to print all vector graphics other than white lines and areas in black.

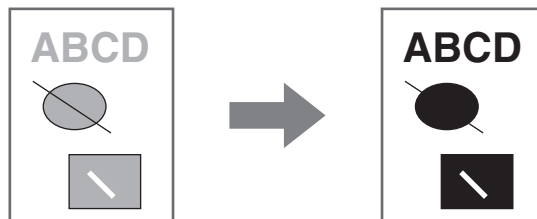

Windows

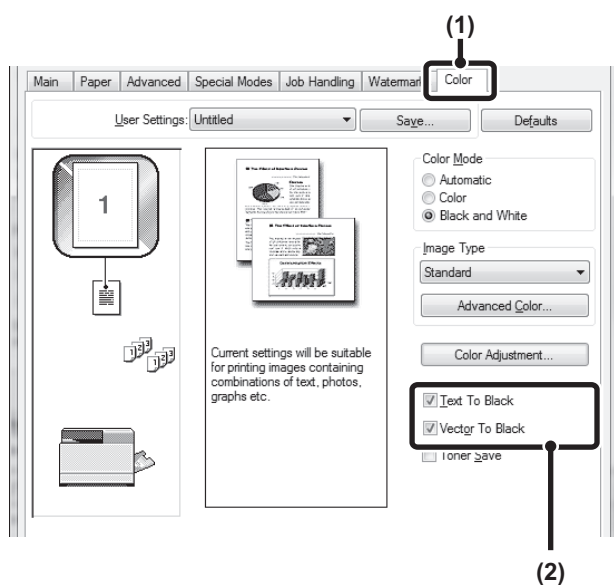

- (1) Click the [Color] tab.
- (2) Select the [Text To Black] checkbox and/or the [Vector To Black] checkbox .

SELECTING COLOUR SETTINGS TO MATCH THE IMAGE TYPE (Advanced Colour)

Preset colour settings are available in the machine's printer driver for various uses. These enable printing using the most suitable colour settings for the colour image type.

Advanced colour settings can also be configured to match the objective of the colour image, such as colour management settings and the screening setting for adjustment of colour tone expression.

Windows

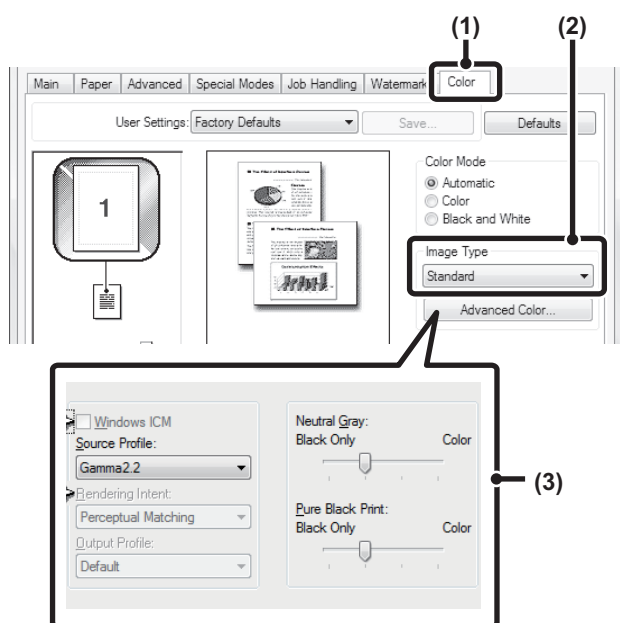

(1) Click the [Color] tab.

(2) Select the "Image Type".

A document type to match the data to be printed can be selected from the pull-down menu.

- Standard (for data that includes text, photos, graphs, etc.)
- Graphics (for data with many drawings or illustrations)
- Photo (for photo data or data that uses photos)
- CAD (for engineering drawing data)
- Scan (for data scanned by a scanner)
- Colorimetric (Data which needs to be printed in almost the same colours as those on the screen)
- Custom (for data to be printed with special settings)

(3) Select advanced colour settings.

If you wish to select advanced settings, click the [Advanced Color] button.

If you wish to perform colour management using Windows ICM* in your operating system, select [Custom] for the image type at step (2) and then select the [Windows ICM] checkbox . To configure advanced colour management settings such as "Source Profile", select the desired settings from the menus.

* Cannot be selected when using the PS printer driver on Windows 7/Vista/Server 2008/8/8.1/Server 2012.

Macintosh

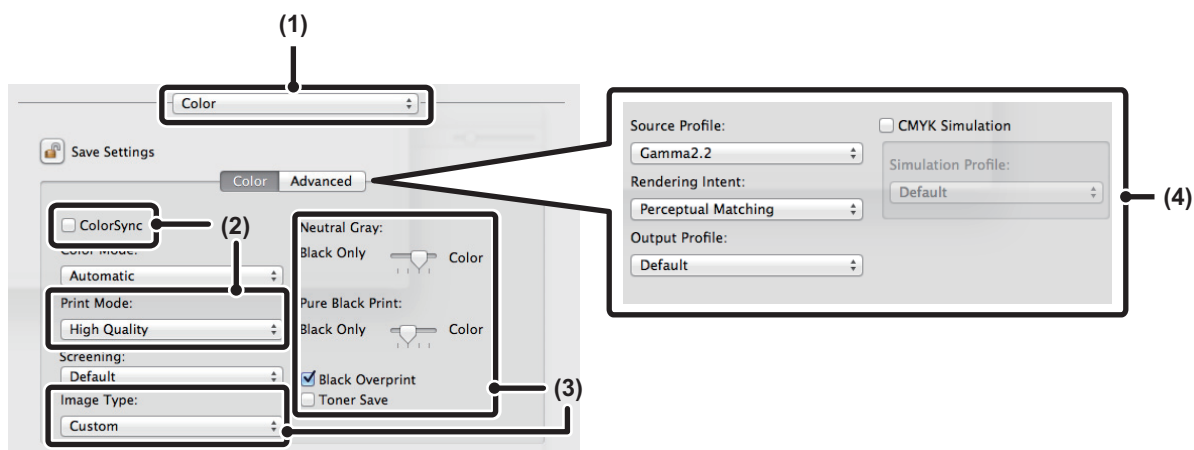

(1) Select [Color].

(2) Select colour print settings.

To use the Mac OS Color Management function, select the [ColorSync] checkbox . When this is done, "Image Type" cannot be selected.

(3) Select the Image Type.

An image type to match the data to be printed can be selected from the pull-down menu.

- Standard (for data that includes text, photos, graphs, etc.)
 - Graphics (for data with many drawings or illustrations)
 - Photo (for photo data or data that uses photos)
 - CAD (for engineering drawing data)
 - Scan (for data scanned by a scanner)
 - Colorimetric (Data which needs to be printed in almost the same colours as those on the screen)
 - Custom (for data to be printed with special settings)
- [Neutral Gray] can be used when [Custom] is selected.

(4) Select advanced colour settings.

If you wish to select detailed settings, click the [Advanced] tab.

To configure colour management settings, select the desired settings from the menus. To use "CMYK Simulation", select the [CMYK Simulation] checkbox and then select the desired setting.

The following colour management settings are available.

- Windows ICM checkbox*1: Colour management method in a Windows environment
- ColorSync checkbox: Colour management method in a Macintosh environment
- Source Profile: Selection of the input colour profile used for the printed image
- Rendering Intent: Standard value used when converting the colour balance of the image displayed on the computer screen to a colour balance that can be printed by the machine.
- Output Profile: Selection of the output colour profile used for the printed image
- CMYK Correction*2: When printing a CMYK image, you can correct the image to obtain the optimum result.
- Screening: Select the most suitable image processing method for the image being printed.
- Neutral Gray: Select whether grey halftones are printed with single-colour black toner or 4-colour CMYK toners.
- Pure Black Print: Select whether black areas are printed with single-colour black toner or 4-colour CMYK toners.
- Black Overprint: Prevents whitening of the outline of black text.
- CMYK Simulation: The colour can be adjusted to simulate printing using the process colours used by printing presses.
- Simulation Profile: Selecting a process colour.

*1 Cannot be enabled when using a PS printer driver in Windows 7/Vista/Server 2008/8/8.1/Server 2012.

*2 Only the PCL6 printer driver can be used.

FUNCTIONS THAT COMBINE TEXT AND IMAGES

ADDING A WATERMARK TO PRINTED PAGES (Watermark)

Faint shadow-like text can be added to the background of the printed image as a watermark. The size, colour, density, and angle of the watermark text can be adjusted. The text can be selected from a pre-stored list, or entered to create an original watermark.

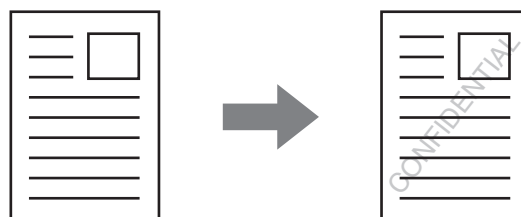

Windows

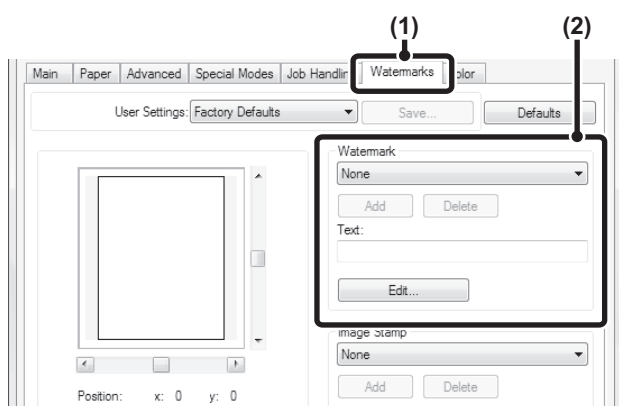

- (1) Click the [Watermarks] tab.
- (2) Select the watermark settings.
Select a stored watermark from the pull-down menu. You can click the [Edit] button to edit the font colour and select other detailed settings.



If you wish to create a new watermark...

Enter the text of the watermark in the "Text" box and click the [Add] button.

Macintosh

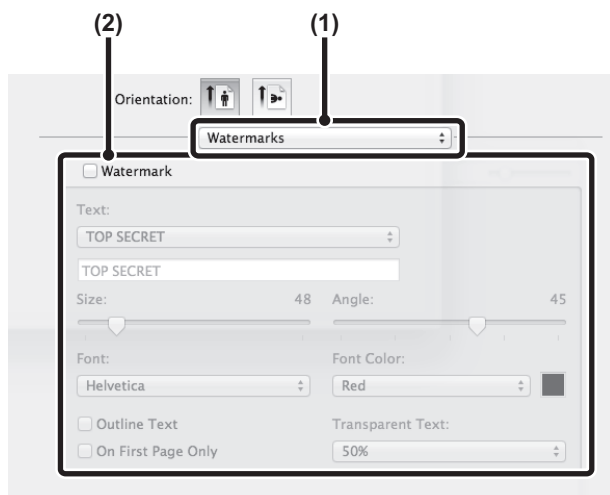

- (1) Select [Watermarks].
- (2) Click the [Watermark] checkbox and configure watermark settings.
Detailed watermark settings can be configured such as selection of the text and editing of the font and colour. Adjust the size and angle of the text by dragging the slide bar.

PRINTING AN IMAGE OVER THE PRINT DATA (Image Stamp)

(This function is only available in Windows.)

A bitmap or JPEG image stored on your computer can be printed over the print data. The size, position, and angle of the image can be adjusted. This feature can be used to "stamp" the print data with a frequently used image or an icon of your own creation.

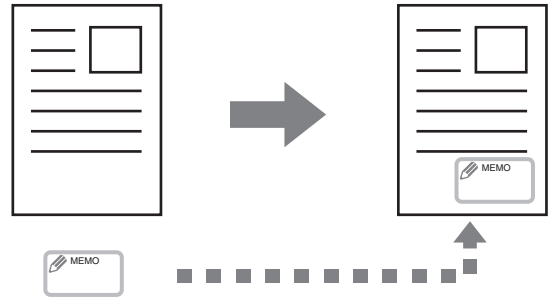

Windows

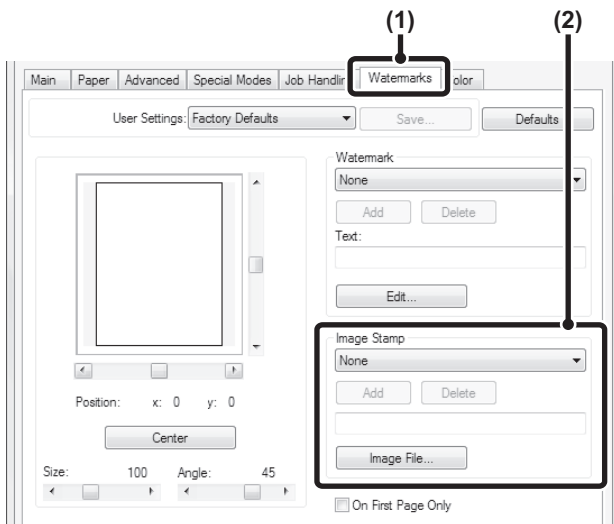

- (1) Click the [Watermarks] tab.
- (2) Select the image stamp setting.

If an image stamp has already been stored, it can be selected from the pull-down menu.

If you have not stored an image stamp, click the [Image File], select the file you wish to use for the image stamp, and click the [Add] button.

CREATING OVERLAYS FOR PRINT DATA (Overlays)

(This function is only available in Windows.)

The print data can be printed in a previously created overlay. By creating table rulings or a decorative frame in an application different from that of the text file and registering the data as an overlay file, an attractive print result can be easily obtained without the need for complex manipulations.

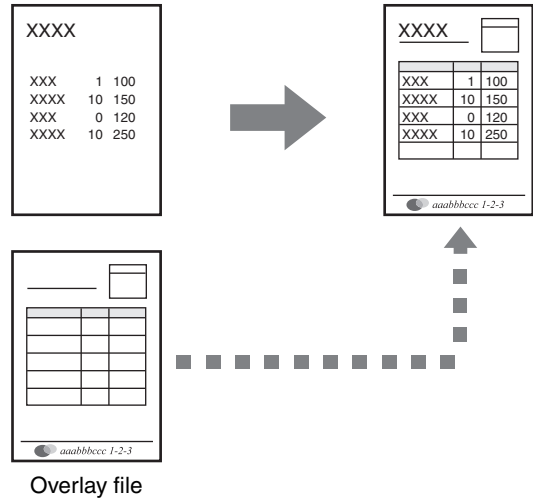

Windows

Create an overlay file.

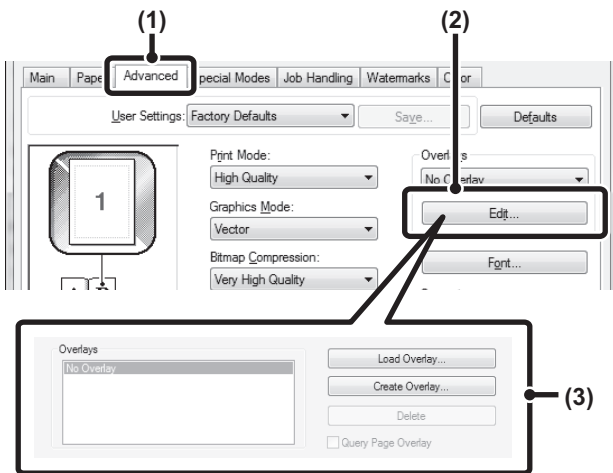

(1) Click the [Advanced] tab.

Configure the printer driver settings from the software application that you wish to use to create the overlay file.

(2) Click the [Edit] button.

(3) Create an overlay file.

Click the [Create Overlay] button and specify the name and folder to be used for the overlay file that you wish to create. The file will be created when the settings are completed and printing is started.



- When printing is started, a confirmation message will appear. The overlay file will not be created until the [Yes] button is clicked.
- To register a previously existing overlay file, click the [Load Overlay] button.

Printing with an overlay file

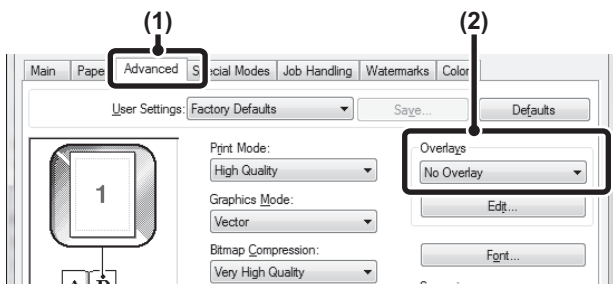

(1) Click the [Advanced] tab.

Configure the printer driver settings from the application from which you wish to print using the overlay file.

(2) Select the overlay file.

A previously created or stored overlay file can be selected from the pull-down menu.

PRINT FUNCTIONS FOR SPECIAL PURPOSES

PRINTING SPECIFIED PAGES ON DIFFERENT PAPER (Different Paper)

The front cover can be printed on paper that is different from the other pages. Use this function when you wish to print the front cover on heavy paper, or different paper such as coloured paper.

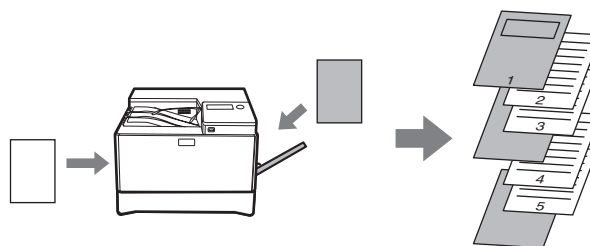

Windows

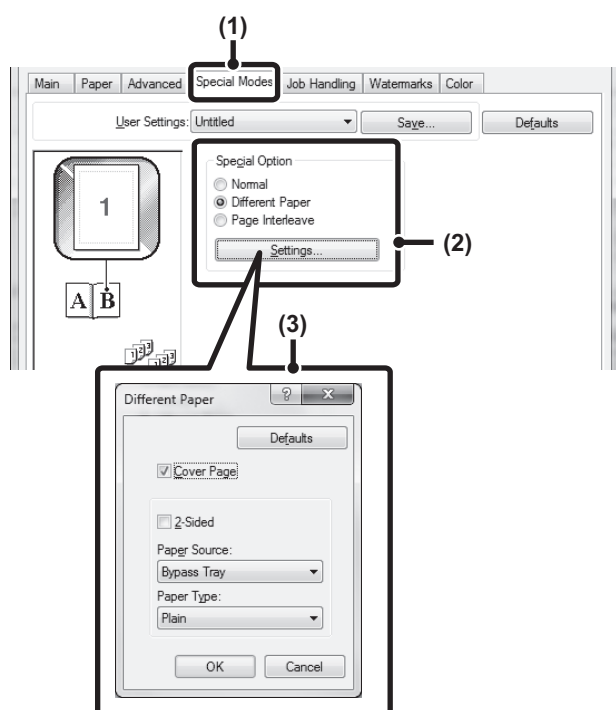

- (1) Click the [Special Modes] tab.
- (2) Select [Different Paper] and click the [Settings] button.
- (3) Select paper insertion settings.
Click the [Cover Page] checkbox (), and select the feeding method and printing method for the insert paper from the respective menus. Select the insertion position, paper source, and printing method from the corresponding menus.



When [Bypass Tray] is selected in "Paper Source", be sure to select the "Paper Type" and load that type of paper in the bypass tray.

Macintosh

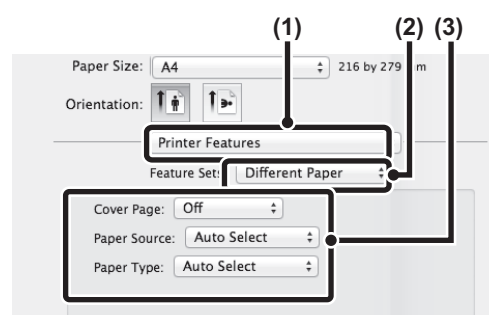

- (1) Select [Printer Features].
- (2) Select [Different Paper].
- (3) Select cover insertion settings.
Select the print setting, paper tray, and paper type for the cover page and last page.

CONVENIENT PRINTER FUNCTIONS

SAVING AND USING PRINT FILES (Retention)

This function is used to store a print job as a file on the machine, allowing the job to be printed from the operation panel.

When printing from a computer, a password (5 to 8 digits) can be set to maintain the secrecy of information in a stored file.

When a password is set, the password must be entered to print a stored file from the machine.

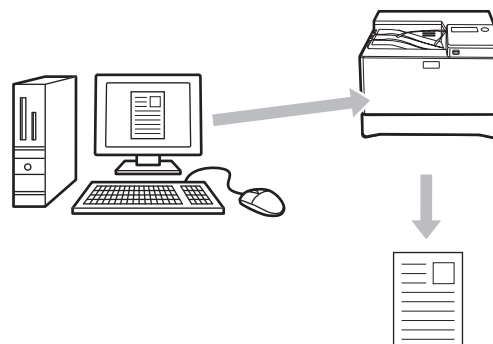

- Print data is erased when the power is turned off.
- Print data that exceeds 5 MB cannot be saved.
- A maximum of 5 files can be saved.

Windows

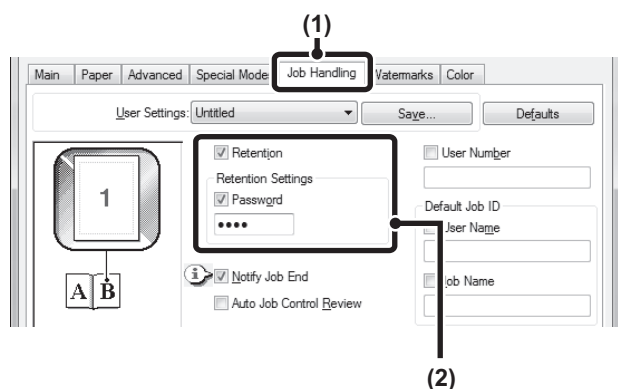

- (1) Click the [Job Handling] tab.**
- (2) Select the retention setting.**
Click the [Retention] checkbox . Select the retention method in "Retention Settings". To enter a password (5 to 8 digit number), click the [Password] checkbox .

Macintosh

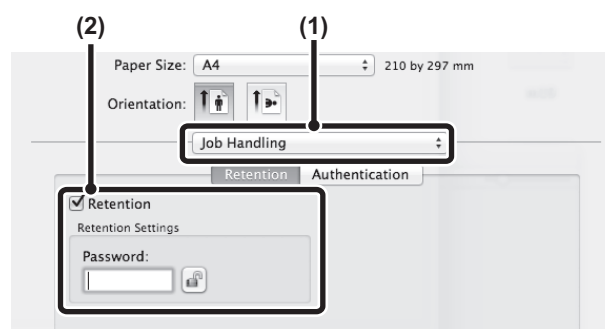

- (1) Select [Job Handling].**
- (2) Select the retention setting.**
Click the [Retention] checkbox . To simplify operation the next time the same password is set, click the  (lock) button after entering the password (5 to 8 digit number).

Printing a job stored by retention

When retention is performed, the display appears as follows:

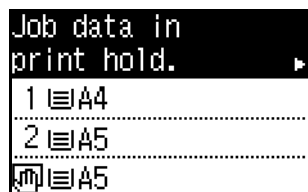

1 Press the [▶] key to display the list of print hold jobs.

2 Select the print job with the [▲][▼] keys.

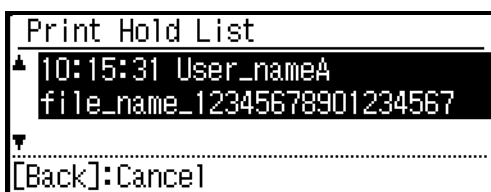

3 Press the [OK] key.

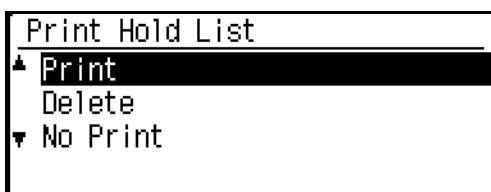

4 Print or delete the print job with the [▲][▼] keys.

Select "Print" to print the job.
 Select "Delete" to delete the job without printing it.
 Selecting "No Print" returns you to step 1.

5 Press the [OK] key.

The print job is printed or deleted. If a password is set, the job will be printed or deleted after you enter the password with the numeric keys and press the [OK] key.

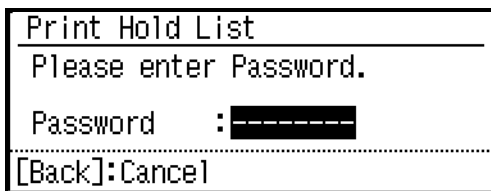

PRINTING WITHOUT THE PRINTER DRIVER

When you do not have the printer driver installed on your computer, or when the software application used to open a file that you wish to print is not available, you can print directly to the machine without using the printer driver. The file types (and corresponding extensions) that can be printed directly are shown below.

File Type	TIFF	JPEG	PCL	PDF, Encrypted PDF	PS
Extension	tiff, tif	jpeg, jpg, jpe, jfif	pcl, prn, txt	pdf	ps, prn



- Even if the print result is black and white, the following types of print jobs will be counted as 4-colour (Y (Yellow), M (Magenta), C (Cyan), and Bk (Black)) print jobs. To be always counted as a black and white job, select black and white printing.
 - When the data is created as colour data.
 - When the application treats the data as colour data even though the data is black and white.
 - When an image is hidden under a black and white image.
- The file format of some files may not be printable even if the file is listed in the above table.
- A password-protected PDF file cannot be printed.

DIRECTLY PRINTING A FILE IN USB FLASH MEMORY

A file in a USB flash memory connected to the machine can be printed from the operation panel of the machine without using the printer driver. When the printer driver of the machine is not installed on your computer, you can copy a file into a commercially available USB flash memory and connect the device to the machine to print the file directly.

1 Connect the USB flash memory to the machine.

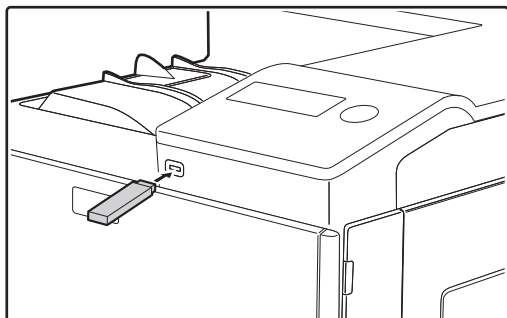

When a USB flash memory is inserted and the machine recognizes the device, the display shows the files to select.

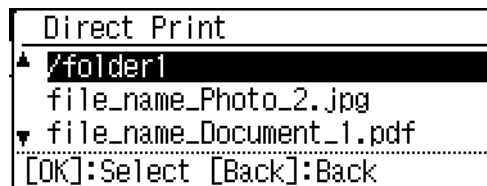

Use a FAT32 USB flash memory with a capacity of no more than 32 GB.

2 Select the file that you wish to print with [▲] or [▼] key.

A name with "/" to its left is the name of a folder in the USB flash memory. To display the files and folders in a folder, select the folder and press the [OK] key.



- A total of 100 files and folders can be displayed.
- Press the [BACK] key (↵) to move up one folder level.

3 Press the [OK] key.

4 Select "Print" with the [▲] or [▼] key and then press the [OK] key.

When forwarding of the selected file is completed, printing starts. Print settings can be selected in the machine's Web page. However, if a file that includes print settings (PCL, PS) is selected, the file's print settings will be applied.

DIRECTLY PRINTING FROM A COMPUTER

Settings can be configured in the Web pages of the machine to enable direct printing from a computer without using the printer driver. For the procedure for accessing the Web pages, see "ABOUT THE WEB PAGES" (P.95).

FTP PRINT

You can print a file from your computer by simply dragging and dropping the file onto the FTP server of the machine.

- **Configuring settings**

To enable FTP Print, click [Application Settings] and then [Setting for Print from the PC] in the Web page menu, and configure the port number. (Administrator rights are required.)

- **Performing FTP Print**

Type "ftp://" and then the IP address of the machine in the address bar of your computer's Explorer as shown below.

(Example)

ftp://192.168.1.28

Drag and drop the file that you wish to print onto the "lp" folder that appears in your Web browser. The file will automatically begin printing.



- If you printed a file (PCL, PS) that includes print settings, the settings will be applied.
- When user authentication is enabled in the system settings (administrator) of the machine, the print function may be restricted. For more information, ask your administrator.

CANCELLING A PRINT JOB FROM THE MACHINE

Press the [STOP] key (⏹) on the operation panel.

CHANGE THE MACHINE TO OFFLINE MODE

To change the machine to offline mode, follow the steps below.

- 1 Press the [SPECIAL FUNCTION] key (Fn) and select "Online/Offline" with the [▼][▲] keys.**
- 2 Select "Offline" with the [▼][▲] keys and press the [OK] key.**

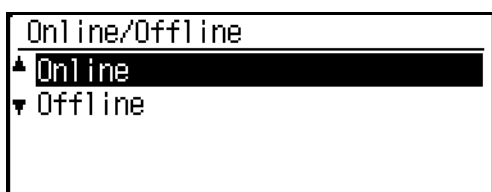

Printing stops and the mode changes to offline mode. To cancel printing, press the [C] key. To resume printing, select "Online" and press the [OK] key.

APPENDIX

PRINTER DRIVER SPECIFICATION LIST

Available functions and output results may vary depending on the type of printer driver being used.

Function		PCL6	PS	Windows PPD ^{*1}	Macintosh PPD ^{*1}	
Frequently used functions	Copies	1-999	1-999	1-999	1-999	
	Orientation	Yes	Yes	Yes	Yes	
	N-Up	Number of pages	2,4,6,8,9,16	2,4,6,8,9,16	2,4,6,9,16	2,4,6,9,16
		Order	Yes	Yes	Yes	Yes
		Border	Yes	Yes	Yes	Yes
	2-Sided Print	Yes	Yes	Yes	Yes	
	Fit To Page	Yes	Yes	No	Yes	
	Binding Edge	Yes	Yes	No	Yes	
Black and White Print	Yes	Yes	Yes	Yes		
Paper	Paper Size	Yes	Yes	Yes	Yes	
	Custom Paper	8 size	8 size	Yes	Yes	
	Paper Selection	Yes	Yes	Yes	Yes	
Convenient printer functions	Pamphlet	Yes	Yes	Yes	Yes	
	Margin Shift	0 mm to 30 mm	0 mm to 30 mm	Yes	Yes	
	Poster Printing	Yes	Yes	No	No	
	Rotate 180 degrees	Yes	Yes	Yes	Yes ^{*4}	
	Zoom/XY-Zoom	Yes ^{*2}	Yes	Yes ^{*2}	Yes ^{*2}	
Mirror Image	No	Yes	Yes ^{*5}	Yes ^{*6}		
Special functions	Different Paper	Yes	Yes	No	Yes	
	Page Interleave	Yes	No	No	No	
	Retention	Yes	Yes	No	Yes	
Colour mode adjusting function	Colour Adjustment	Yes	Yes	No	Yes ^{*3}	
	Text To Black/ Vector To Black	Yes	Yes	No	No	
	Advanced Colour	Yes	Yes	Yes	Yes	
Functions to combine text and images	Watermark	Yes	Yes	Yes	Yes	
	Image Stamp	Yes	Yes	No	No	
	Overlay	Yes	Yes	No	No	

Function		PCL6	PS	Windows PPD*1	Macintosh PPD*1
Image Quality	Print Mode	Normal/ High Quality	Normal/ High Quality	Normal/ High Quality	Normal/ High Quality
	Graphics Mode Selection	Yes	No	No	No
	Toner Save	Yes	Yes	Yes	Yes
Font	Resident font	80 fonts	136 fonts	136 fonts	136 fonts
	Selectable download font	bitmap, TrueType, Graphics	bitmap, TrueType, Type1	bitmap, TrueType, Type1	No
Other functions	Auto Configuration	Yes	Yes	No	Yes
	User Authentication	Yes	Yes	No	Yes

*1 The specifications of each function in Windows PPD and Macintosh PPD vary depending on the operating system version and the software application.

*2 The horizontal and vertical proportion cannot be set separately.

*3 Only Mac OS X v10.4 can be used.

*4 Only landscape documents are supported.

*5 Horizontal mode only.

*6 Cannot be used in Mac OS X v10.4/10.5.

3

TROUBLESHOOTING

This chapter describes troubleshooting and misfeed removal.

If you encounter a problem when using the machine, check the following troubleshooting guide before calling for service. If you cannot resolve the problem using the troubleshooting guide, turn off the main switch, disconnect the power cord from the power outlet, and contact your dealer.

If you experience difficulty using the machine, check the following troubleshooting guide before calling for service. Many problems can be easily resolved by the user. If you are unable to solve the problem using the troubleshooting guide, turn off the power switch and unplug the machine, and contact your authorised service representative.

"**_**" represents a code consisting of numbers and letters. When contacting your dealer, inform your dealer of the code that is displayed.

TROUBLESHOOTING	63
 NETWORK PROBLEMS	63
The machine does not connect to the network.	63
 PRINTING PROBLEMS	63
The machine does not operate.	63
Paper misfeed.	64
Paper size for a paper tray cannot be set.	64
A print job stops before it is finished.	64
The display turns off.	64
Lighting fixture flickers.	64
The machine does not print. (ONLINE indicator (☐) does not blink.)	65
The machine does not print. (ONLINE indicator (☐) was blinking.)	65
Printing is slow.	65
The printed image is light and uneven.	65
The printed image is dirty.	66
The printed image is skewed or it runs off the paper or the image is cut off.	66
Wrinkles appear in the paper or the image disappears in places.	66
INDICATORS AND DISPLAY MESSAGES	67
MISFEED REMOVAL	68
MISFEED IN THE BYPASS TRAY	68
MISFEED IN THE MACHINE	69
MISFEED IN THE PAPER TRAY 1	73
MISFEED IN THE PAPER TRAY 2 (Option)	73
REPLACING THE TONER CARTRIDGE	74
REPLACING THE TONER COLLECTION CONTAINER	76

TROUBLESHOOTING

NETWORK PROBLEMS



Problem	Cause and solution	Page
The machine does not connect to the network.	The LAN cable is disconnected. → Make sure that the LAN cable is firmly inserted in the connectors on the machine and your computer. To connect the cable, see the "Software setup guide".	7
	Is the machine configured for use on the same network as the computer? → The machine cannot be used if it is not connected to the same network as the computer, or if it is not configured for use on the network. For more information, consult your network administrator.	–

PRINTING PROBLEMS

In addition to this section, troubleshooting information can also be found in the README files for each of the software programs. To view a README file, see "SOFTWARE SETUP GUIDE".

Problem	Cause and solution	Page
The machine does not operate.	The machine is not plugged into a power outlet. → Plug the machine into a grounded outlet.	–
	Power switch OFF. → Turn the power switch ON.	12
	The machine is warming up. → The machine requires some time to warm up after the power switch is turned on. While the machine is warming up, settings can be performed but printing is not possible.	12
	The front cover or the side cover is not completely closed. → Close the front cover or the side cover.	–
	The machine is in auto power shut-off mode. → When auto power shut-off mode has activated, only the [ENERGY SAVE] indicator (☾) blinks; all other indicators and the display are off. The machine returns to normal operation when the [ENERGY SAVE] key (☾) is pressed, when a print job is received.	12
	Misfeed occurs. → To remove the misfeed, see "MISFEED REMOVAL".	68
	The tray is out of paper. → Load paper.	16

Problem	Cause and solution	Page
Paper misfeed.	The paper is outside of the specified size and weight range. → Use paper within the specified range.	13
	Paper curled or damp. → Do not use curled or crimped paper. Replace with dry paper. During periods when the machine is not used for a long time, remove the paper from the tray and store it in a dark place in a bag to prevent moisture absorption.	–
	Paper is not loaded properly. → Make sure the paper is properly installed.	16
	Pieces of paper inside machine. → Remove all pieces of misfed paper.	68
	Several sheets of paper stick together. → Fan the paper well before loading it.	–
	A paper misfeed has occurred in the tray. → Turn the paper over and/or turn it around, and reload.	16
	Too much paper is loaded in the tray. → If the stack of paper is higher than the indicator line on the tray, remove some of the paper and reload so that the stack does not exceed the line.	16
	The guides on the bypass tray do not match the width of the paper. → Adjust the guides to match the width of the paper. If the paper guide presses too hard against the paper, a misfeed may occur. Adjust the guide so that it lightly contacts the paper.	17
	The bypass tray extension is not pulled out. → When loading paper, open the extension.	17
	The bypass paper feed roller is dirty. → Clean the roller.	79
Paper size for a paper tray cannot be set.	Printing is performed. → Set the paper size after printing is complete.	9
	The machine has stopped temporarily due to running out of paper or a misfeed. → Load paper or remove the misfeed, and then set the paper size.	16, 68
A print job stops before it is finished.	The paper output tray is full. → Remove the output in the paper output tray to resume printing.	7
	The tray is out of paper. → Load paper.	16
The display turns off.	Any other indicators turned off. → If other indicators are lit, the machine is in "Preheat mode". Press any key on the operation panel to resume normal operation.	12
	[ENERGY SAVE] indicator () blinks. → The machine is in auto power shut-off mode. Press the [ENERGY SAVE] key () to resume normal operation.	12
Lighting fixture flickers.	The same power outlet being used is for the lighting fixture and the machine. → Connect the machine to a power outlet which is not used for other electric appliances.	–

Problem	Cause and solution	Page
<p>The machine does not print. (ONLINE indicator () does not blink.)</p>	<p>The machine is set to off-line mode. → If the ONLINE indicator () is not on, press the [SPECIAL FUNCTION] key (Fn) and then use the [▲] key to select "Online/Offline".</p>	59
	<p>The machine is not correctly connected with your computer. → Check both ends of the printer cable and make sure you have a solid connection. Try a known good cable. For information on cables, see "SPECIFICATIONS (START GUIDE)".</p>	7
	<p>Your machine is not selected correctly in the current application for the print job. → When choosing "Print" from the "File" menu located in applications, be sure you have selected "SHARP MX-XXXX" (where XXXX is the model name of your machine) printer displayed in the "Print" dialog box.</p>	-
	<p>The printer driver has not been installed properly. → Follow these steps to check and see if the printer driver is installed. 1 Click the "Start" button, and then click "Devices and Printers". In Windows Vista, click the "Start" button, click "Control Panel", and then click "Printer". In Windows XP, click the "start" button, and then click "Printers and Faxes". 2 If the "SHARP MX-XXXX" printer driver icon is shown but you still cannot print, the printer driver may not have been installed correctly. In this case, delete the software and then reinstall it.</p>	-
	<p>The port setting is not correct. → Printing is not possible if the printer driver port setting is not correct. Set the port correctly. For more information, see the Software Setup Guide.</p>	-
	<p>Printing is disabled. → If "Disable Print by Inv. User" is enabled in the system settings, printing will not be possible. Consult the administrator.</p>	90
<p>The machine does not print. (ONLINE indicator () was blinking.)</p>	<p>The tray size settings are not the same on the machine and in the printer driver. → Make sure that the same tray paper size is set on the machine and in the printer driver. To change the tray's paper size setting on the machine, see "CHANGING THE PAPER SIZE SETTING OF A TRAY" (p.19) or see Software Setup Guide to change it in the printer driver.</p>	19
	<p>The specified size of paper has not been loaded. → Load the specified size of paper in the paper tray.</p>	16
<p>Printing is slow.</p>	<p>Simultaneous use of two or more application software programs. → Start printing after quitting all unused application software programs.</p>	-
<p>The printed image is light and uneven.</p>	<p>The paper is loaded so that printing takes place on the back side of the paper. → Some paper types have a front and back side. If the paper is loaded so that printing takes place on the back side, toner will not adhere well to the paper and a good image will not be obtained.</p>	16

Problem	Cause and solution	Page
The printed image is dirty.	You are using paper that is outside the specified size and weight range. → Use paper within the specified range.	13
	Paper curled or damp. → Do not use curled or crimped paper. Replace with dry paper. During periods when the machine is not used for a long time, remove the paper from the tray and store it in a dark place in a bag to prevent moisture absorption.	–
	You did not set sufficient margins in the paper settings of your application. → The top and bottom of the paper may be dirty if the margins are set outside of the specified print quality area. → Set the margins in the software application within the specified print quality area.	–
	Black dots or smudges appear on the printed output. → Run fixing cleaning mode. The letter "V" is printed on a sheet of paper and the fusing unit is cleaned.	91
The printed image is skewed or it runs off the paper or the image is cut off.	The paper loaded in the tray is not the same size as that specified in the printer driver. → Check if the "Paper Size" options suit the size of the paper loaded in the tray. If the "Fit To Paper Size" setting is activated, make sure that the paper size selected from the drop-down list is the same as the size of the loaded paper.	–
	The orientation of document setting is not correct. → Click the "Main" tab in the printer driver setup screen, and verify if the "Image Orientation" option is set to your requirements.	–
	Paper is not loaded properly. → Make sure the paper is properly loaded.	16
	You did not correctly specify the margins for the application in use. → Check the layout of the document margins and the paper size settings for the application you are using. Also check if the print settings are specified correctly to suit the paper size.	–
Wrinkles appear in the paper or the image disappears in places.	The paper is outside of the specified size and weight range. → Use paper within the specified range.	16
	Paper curled or damp. → Do not use curled or crimped paper. Replace with dry paper. During periods when the machine is not used for a long time, remove the paper from the tray and store it in a dark place in a bag to prevent moisture absorption.	–
	The fusing unit release levers were not returned to their original positions → If the fusing unit release levers are not returned, poor toner adhesion, smudging, and lines may occur. Be sure to press both levers up to return to their original positions.	70

INDICATORS AND DISPLAY MESSAGES

If one of the following messages appears in the display, take prompt action as instructed by the message.

Message	Action
Maintenance required. Call for service.	Maintenance required soon. Contact your authorised service representative.
 (Maintenance icon)	
Obtain replacement toner.	The toner cartridge must be replaced soon.
Install the toner cartridge.	Check to see if the toner cartridge has been installed properly.
Replace waste box.	Replace the toner collection container as explained in "REPLACING THE TONER COLLECTION CONTAINER" (p.76).
Change the toner cartridge.	Replace the toner cartridge as explained in "REPLACING THE TONER CARTRIDGE" (p.74).
Remove paper from the output tray.	The number of sheets in the output tray has reached the limit. Remove the paper.
Load < * * > paper into tray < * >.	The paper size specified for the tray is different from the actual size. (p.19)
Clear paper path.	Refer to "MISFEED REMOVAL" (p.68), check the location and remove the misfeed.
Close the cover.	Make sure that the front cover and side cover are properly closed.

< * >: Tray number

< * * >: Size of paper that should be loaded

MISFEED REMOVAL

When a misfeed occurs during printing, the message " ⚠ Clear paper path." and the location of the misfeed will appear. Check the location and remove the misfeed.



Note The paper may tear when you remove a misfeed. In this event, be sure to remove all torn pieces of paper from the machine.

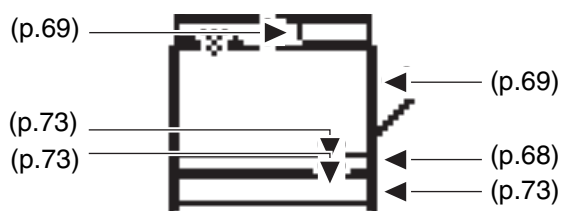

MISFEED IN THE BYPASS TRAY

- 1 Remove any paper remaining in the bypass tray.

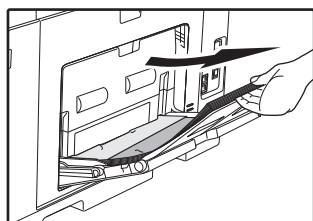

- 2 Gently remove the misfed paper from the bypass tray.

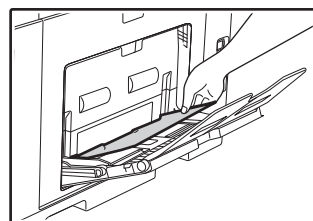

If you were able to remove the misfed paper

- 3** Close the auxiliary tray and then the bypass tray, grasp the side cover open/close handle, and gently open and close the side cover.

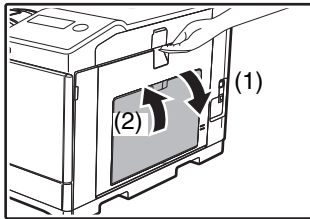

The message " ⚠ Clear paper path." will be cleared and printing will be possible.

If you are unable to remove the misfed paper

- 3** Grasp the side cover open/close handle and gently open the side cover.

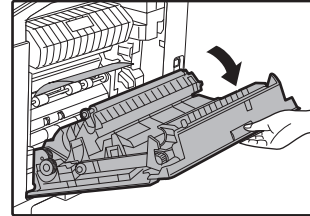

- 4** Turn the paper feed knob and feed out the paper that is inside. ("Misfeed in the paper feed area A" (p.70))

- 5** Close the side cover.

The message " ⚠ Clear paper path." will be cleared and printing will be possible.

MISFEED IN THE MACHINE

To remove a misfeed from inside the machine, open the side cover, check whether the misfeed occurred in "A", "B", or "C" below, and follow the misfeed removal procedure.

- 1** Open the bypass tray and the side cover.

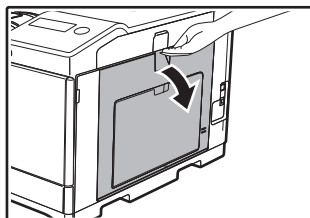

Note If paper remains in the bypass tray, remove the paper. ("MISFEED IN THE BYPASS TRAY" (p.68))

- 2** Check the misfeed location.

Area B

If the misfed paper is visible here, go to "Misfeed in the fusing area B" (p.70).

Area A

If paper is misfed here, go to "Misfeed in the paper feed area A" (p.70).

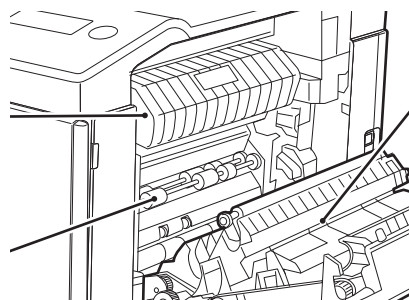

Area C

If paper is misfed here, go to "Misfeed in the transport area C" (p.72).

Misfeed in the paper feed area A

- 1 Carefully remove the misfed paper. Turn the roller rotating knob in the direction of the arrow to assist in removing it.

Roller rotating knob Fusing unit

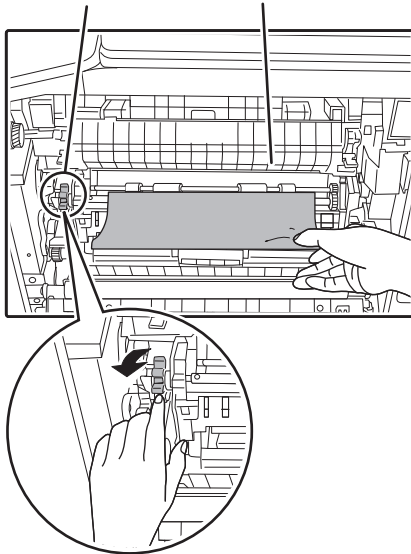

Be careful not to tear the misfed paper during removal.



Warning The fusing unit is hot. Do not touch the fusing unit when removing misfed paper. Doing so may cause a burn or injury.



Caution When removing misfed paper, do not touch or damage the transfer belt.

- 2 Close the side cover.

The message " ⚠ Clear paper path." will be cleared and printing will be possible.



- When closing the side cover, press on around the handle.
- If the message does not clear, check again to make sure that no pieces of paper remain.

Misfeed in the fusing area B

- 1 Lower the fusing unit release levers to allow easier removal.

Fusing unit release levers

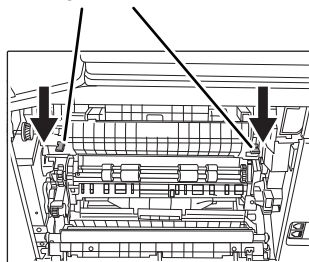

- 2 Lower the part with the green label that protrudes from the fusing unit paper guide, and open the fusing unit paper guide.

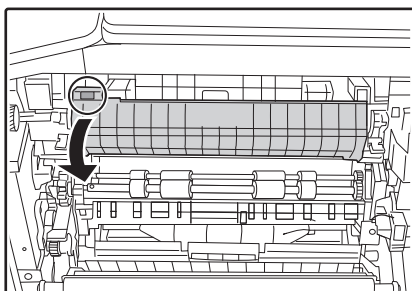

3 Remove the misfed paper.

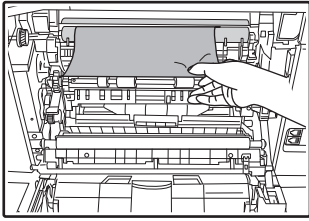

Be careful not to tear the misfed paper during removal.



Warning The fusing unit is hot. Do not touch the fusing unit when removing misfed paper. Doing so may cause a burn or injury.



- When removing misfed paper, do not touch or damage the transfer belt.
- Be careful about unfixed toner on the misfed paper not to soil your hands or clothes.

4 If the misfed paper cannot be removed, remove the paper by pulling it into the paper output area.

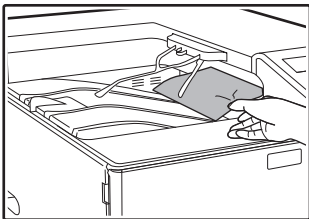

Be careful not to tear the misfed paper during removal.

5 Lift the part with the green label that protrudes from the fusing unit paper guide, and close the fusing unit paper guide.

6 Lift the fusing unit release levers, to return them to their operating positions.

7 Close the side cover.

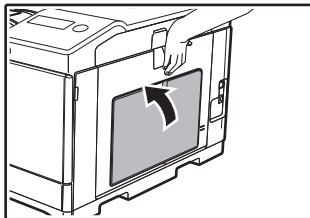

The message " ⚠ Clear paper path." will be cleared and printing will be possible.



- When closing the side cover, press on the handle.
- If the paper was torn, make sure that no torn pieces remain in the machine.
- If the message does not clear, check again to make sure that no pieces of paper remain.

Misfeed in the transport area C

- 1 Lift up the duplex conveyor lever and open the reversing unit.

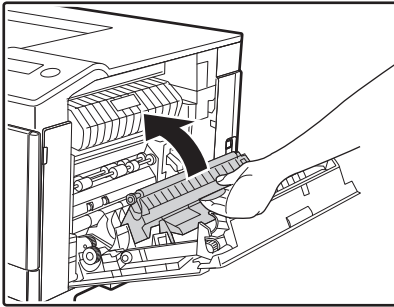

- 2 Remove the misfed paper.

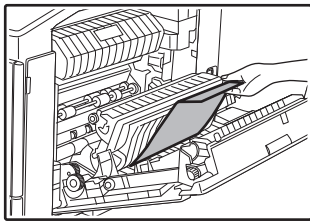

- 3 Return the duplex conveyor lever to its original position and close the side cover.

The message " ⚠ Clear paper path." will be cleared and printing will be possible.

Note

- When closing the side cover, press on around the handle.
- If the paper was torn, make sure that no torn pieces remain in the machine.
- If the message does not clear, check again to make sure that no pieces of paper remain.

MISFEED IN THE PAPER TRAY 1



Make sure that there is no misfed paper in the tray before pulling it out. (p.69)

- 1** Open the side cover and remove the misfed paper. (p.69)
- 2** Lift and pull out the upper paper tray and remove the misfed paper.

Be careful not to tear the misfed paper during removal.

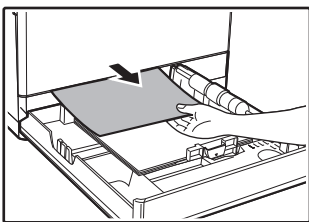

- 3** Push the upper paper tray in completely.

Push the tray in completely.

- 4** Open and close the side cover.

The message " ⚠ Clear paper path." will be cleared and printing will be possible.

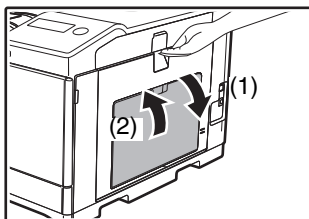

- When closing the side cover, press on the handle.
- If the message does not clear, check again to make sure that no pieces of paper remain.

MISFEED IN THE PAPER TRAY 2 (Option)

- 1** Open the lower side cover.

Grasp the handle to open the lower side cover.

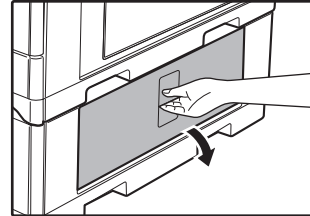

- 2** Remove the misfed paper.

Be careful not to tear the misfed paper during removal.

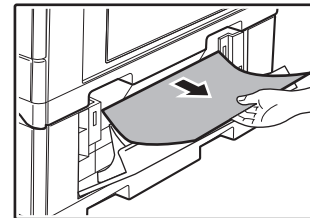

- 3** Close the lower side cover.

The message " ⚠ Clear paper path." will be cleared and printing will be possible.

- 4** If the misfed paper is not seen in step 2, lift and pull out the lower paper tray and remove the misfed paper.

Be careful not to tear the misfed paper during removal.

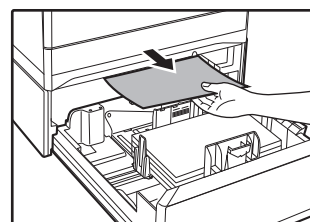

- 5** Close the lower paper tray.

Push the tray in completely.



If the message does not clear, check again to make sure that no pieces of paper remain.

REPLACING THE TONER CARTRIDGE

When the "Prepare a new toner." appears, little toner remains.

You should keep one set of replacement toner cartridges on hand so that you can replace a toner cartridge immediately when toner runs out.

Be sure to replace the toner cartridge when the message "Change the toner cartridge." appears.

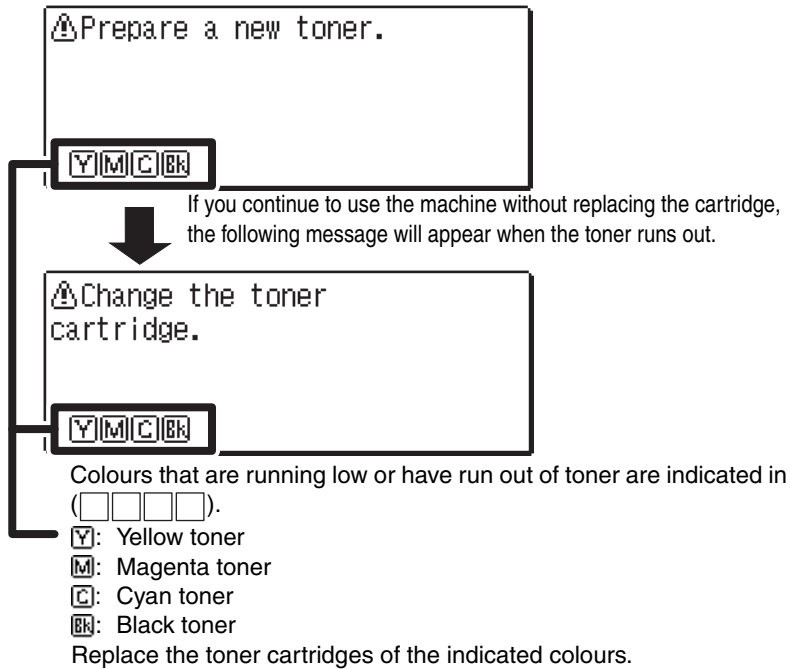

Note

- If any one of the toner colours runs out (including black toner), colour printing will not be possible. If Y, M, or C toner runs out but Bk toner remains, black and white printing will still be possible.
- Be sure to install 4 toner cartridges (Y/M/C/Bk).

Warning

- Do not throw the toner cartridge into a fire. Toner may splatter and cause burns.
- Store toner cartridges out of the reach of small children.

1 Open the front cover.

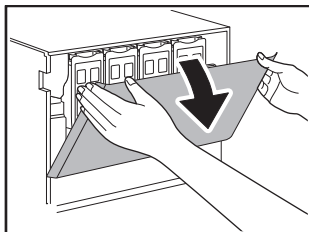

Push on both ends of the front cover and open it.

Locations of colour toner cartridges

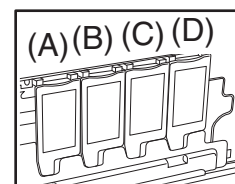

- (A) Yellow
(B) Magenta
(C) Cyan
(D) Black

2 Grasp the handle of the top and bottom of the toner cartridge, pull the toner cartridge out.

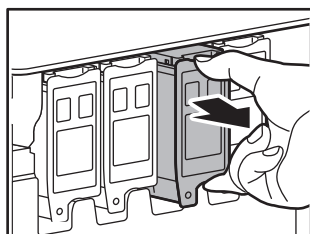

Caution

After removing the toner cartridge, do not shake it or tap on it. Doing so may cause toner to leak from the cartridge. Put the old cartridge immediately in the box of the new cartridge.

Note

Keep used toner cartridges (do not discard them). Your service technician will collect used toner cartridges.

3 Take out the new toner cartridge. Shake it vertically five or six times.

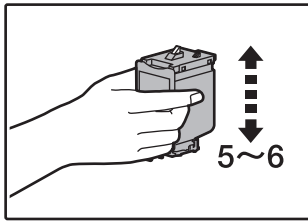

Caution When holding the toner cartridge, do not grasp the shutter. This may cause toner to leak.

4 Insert the toner cartridge along the guides until it locks in place.

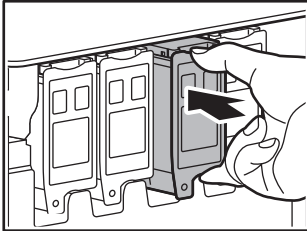

If there is any dirt or dust on the toner cartridge, remove it before installing the cartridge.



Note A toner cartridge of a different colour cannot be installed. Be sure to install a toner cartridge of the same colour.

5 Press the centre of the toner cartridge until the cartridge locks into place.

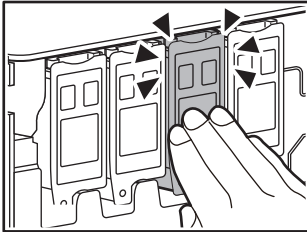

6 Close the front cover.

The message will be cleared and printing will be possible.



- Even after a new toner cartridge is installed, the message may still appear, indicating that printing cannot be resumed (toner is not fed sufficiently). In this case, open and close the front cover. The machine will feed toner again for about two minutes and then printing can be resumed.
- Before closing the front cover, make sure that the toner cartridge is correctly installed.
- When closing the front cover, gently hold both ends.

REPLACING THE TONER COLLECTION CONTAINER

This section explains the procedure for replacing the toner collection container.

The toner collection container collects any excess toner that occurs during printing. When the toner collection container becomes full, the message "Replace waste box" will appear.



Caution

- Do not throw the toner collection container into fire. Toner may fly out and cause burns.
- Store the toner collection container out of the reach of children.

1 Pull out the paper tray 1.

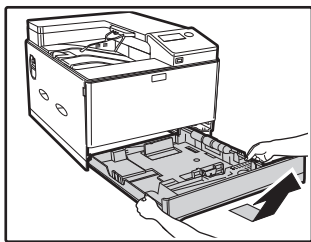

Hold the tray with both hands and slowly pull out and up at a slight angle. The toner collection container cannot be removed unless tray 1 is removed.

2 Open the front cover.

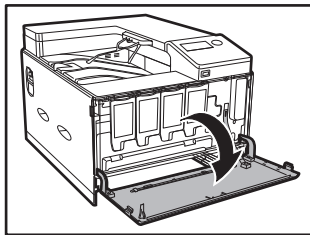

3 Pull out the toner collection container.

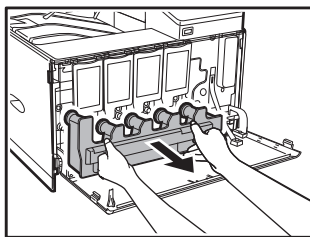

Hold the toner collection container with both hands and slowly pull it out.



Note When removing the toner collection container, it is easier to draw one side at a time.

4 Place the toner collection container on a flat surface.

Spread newspaper on the surface before placing the toner collection container.



- Do not tilt the part with the hole down, as waste toner will spill out.
- Do not discard the toner collection container. Place it in a plastic bag and store. Your service technician will collect the toner collection container the next time he comes for maintenance.

5 Install a new toner collection container.

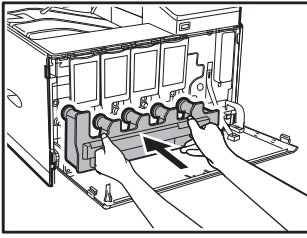

Push the toner collection container in completely.

6 Close the front cover.



You cannot close the front cover when the toner collection container is not attached.

7 Replace tray 1.

4

ROUTINE MAINTENANCE

This chapter explains how to keep the machine operating smoothly, including viewing print count, and cleaning the machine.

CHECKING THE TOTAL OUTPUT COUNT AND TONER REMAINING

You can check by pressing the [SPECIAL FUNCTION] key (Fn) and selecting "Total Count" in the function menu screen. The total output count can be used as a guideline for cleaning. When the total output count exceed "99,999,999", the counts return to "0".

Total Count	: 99,999,999
▲ Total Count	
B/W	: 44,444,444
▼ Colour	: 55,555,555



- Each two-sided sheet that is output is counted as two pages.
- Blank prints are included in the count.
- If the last page of a two-sided printing job is blank, it is not included in the count.

LIST PRINT (USER)

You can print lists of the settings and information registered in the machine. Press the [SPECIAL FUNCTION] key (Fn), select "List Print (User)", and select a list to print it.

List name	Description
All Custom Setting List	This list shows the hardware status, software status, printer condition settings, paper tray settings, and total counts. This is used to print the PCL Symbol Set List, various font lists, and the NIC page (network interface settings, etc.).
PCL Symbol Set List	
PCL Internal Font List	
PS Font List	
NIC Page	

ROUTINE MAINTENANCE



Do not spray flammable cleaner gas. Gas from the spray may come in contact with the internal electrical components or high-temperature parts of the fusing unit, creating a risk of fire or electrical shock.

CLEANING THE BYPASS TRAY PAPER FEED ROLLER

If misfeeds occur frequently when feeding envelopes, heavy paper, etc. through the bypass tray. Before starting, remove the paper from the bypass tray. Turn the power switch off, remove the roller cover from the bypass tray and wipe the paper feed roller at the feed slot of the bypass tray with a soft, clean cloth dampened with alcohol or water.

After cleaning the paper feed roller, attach the roller cover on the bypass tray, and then turn on the machine's power.

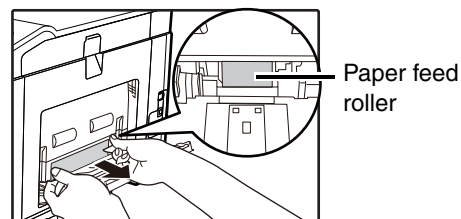

When cleaning the rollers, be careful not to injure your hands.



Do not touch the surface of the roller if your hands are dirty.

CLEANING THE MAIN CHARGER OF THE PHOTOCONDUCTIVE DRUM MC

If black lines or coloured lines appear, use the charger cleaner to clean the main charger.

- 1** Procedure of "REPLACING THE TONER COLLECTION CONTAINER" (p.76), release the toner collection container.
- 2** Grasp the green knob to release the lock and gently remove the charger cleaner.

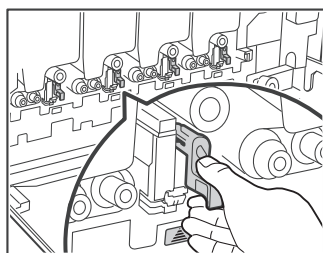

- 3** Gently push the charger cleaner all the way in.
- 4** Repeat step 2 and 3 with each of the other main chargers.

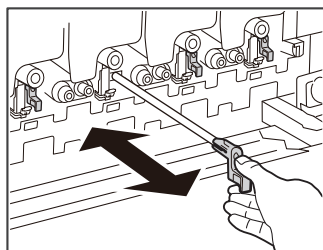

5 Procedure of "REPLACING THE TONER COLLECTION CONTAINER" (p.76), push the toner collection container into the machine.



- If this does not solve the problem, pull the knob out and push it back in 2 more times.
- When pulling and pushing the knob to clean the charger, pull and push the knob slowly from one end to the other.
- Touching the waste toner outlet or the toner collection container may soil your hands and clothes. Exercise caution when cleaning the charger.

CLEANING THE LASER UNIT LSU

When the laser unit inside the machine becomes dirty, line patterns (coloured lines) may form in the printed image. Identifying lines (coloured lines) caused by a dirty laser unit. If the above problems occur, follow the steps below to clean the laser unit.

- 1 Turn the power switch off.**
- 2 Procedure of "REPLACING THE TONER COLLECTION CONTAINER" (p.76), release the toner collection container.**
- 3 Take out the cleaning tool for the laser unit.**

The cleaning tool is attached to the front cover.

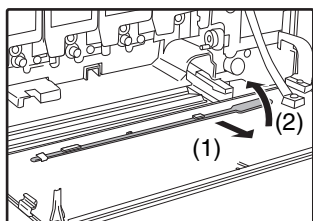

Pull the right side of the cleaning instrument and unfasten it from the claw.

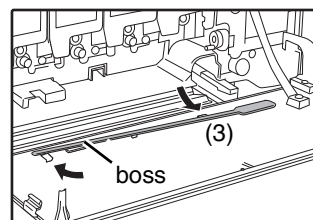

4 Clean the laser unit.

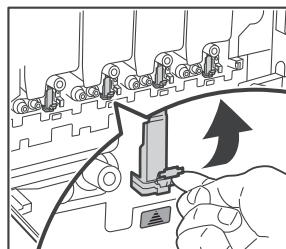

(1) Push up and open the laser unit cover (grey colour).

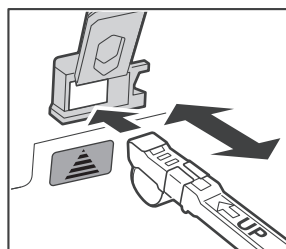

- (2) Point the cleaner down and gently push the cleaning tool all the way in.**
- (3) Gently pull the cleaning tool out.**

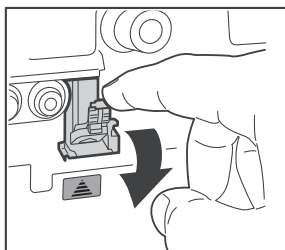

(4) Push down and close the laser unit cover.

5 Repeat step 4 to clean all holes in the laser unit (4 holes).

There are a total of 4 places to be cleaned in the laser unit, including the hole cleaned in step 4. Clean all holes.

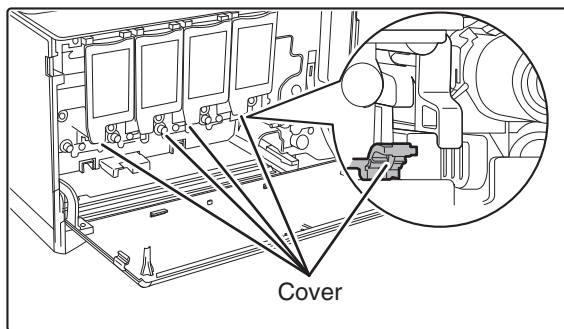

6 Replace the cleaning tool.

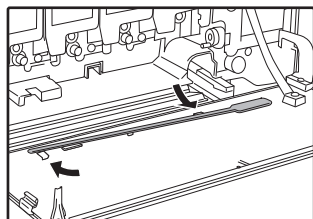

- (1) Rotate the cleaning tool after putting it on the boss and hook its edge (the side that does not have a handle) to the claw on the left side. Hook the cleaning tool with the clean side face up.
- (2) Place the right-hand side of the cleaning tool on the inner side, spread across the top of the claw.

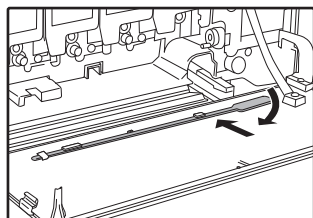

- (3) Hook the cleaning tool to the claw.

7 Procedure of "REPLACING THE TONER COLLECTION CONTAINER" (p.76), push the toner collection container into the machine.

ADJUSTING THE DISPLAY CONTRAST

The contrast of the display can be adjusted as explained below.

- 1** Press the [SPECIAL FUNCTION] key (Fn).
- 2** Select "Display Contrast" with the [▼] or [▲] key.
- 3** Press the [OK] key.

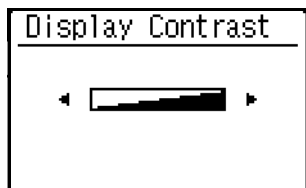

- 4** Adjust the contrast with the [◀] or [▶] key.
To reset the contrast to the default setting, press the [C] key.
- 5** Press the [SPECIAL FUNCTION] key (Fn).
You will return to the base screen.

PURPOSE OF THE SYSTEM SETTINGS

The system settings are used by the administrator of the machine to enable or disable functions to suit the needs of your workplace.

PROGRAMMING AN ADMINISTRATOR PASSWORD

The administrator password is a 5-digit number that must be entered in order to access the system settings. The administrator (administrator of the machine) should change the default administrator password that was set at the factory to a new 5-digit number. Be sure to remember the new administrator password, as it must be entered each time the system settings are subsequently used. (Only one administrator password can be programmed.) Refer to the Start Guide for the factory default administrator password.

1 Press the [SPECIAL FUNCTION] key (Fn).

The special function screen will appear.

2 Select "System Settings" with the [▼] or [▲] key.

3 Press the [OK] key.

The administrator password entry screen appears.

4 Use the numeric keys to enter the five-digit administrator password.

- If this is the first time you are programming the administrator password, enter the factory default code. (Refer to the Start Guide)
- "X" appears for each digit that you enter.
- The mode select screen will appear with "Change Admin PW" selected.

5 Press the [OK] key.

The administrator password change screen appears.

6 Enter the new 5-digit administrator password with the numeric keys.

Change Admin PW	
Present:	-----
New:	█████

Any 5 digits can be used for the administrator password.

7 Press the [OK] key.

- The previously programmed administrator password is replaced by the new administrator password.
- Press the [HOME] key (🏠) to return to the base screen.

SYSTEM SETTINGS LIST

This is a list of the machine's system settings.

Program name	Page
Change Admin PW	
Change Admin PW	88
Initial Setting	
Date & Time Set	88
Daylight Saving Time	88
Printer	
Notice Page	88
Network	
Confirmation of Network	88
Connection Type	88
Wired Settings	88
Wireless (Infrastructure)	89
Wireless (Access Point)	89
User Control	
User Authentication	90
User Registration	90
Function Limit Setting	90
Account Limit Setting	90
User Count Display	90
User Count Reset	90
A Warning when Login Fails	90
Disable Print by Inv. User	90
Device Control	
Fusing Control	91
Fusing Cleaning	91
Registration Adjustment	91
Operation Setting	
Auto Clear	91
Language Setting	91
Message Time	91
Key Touch Sound	91
Key Press Time	91
Disable Auto Key Repeat	92
Disable Paper Size Set	92
Energy Save	
Auto Power Shut-Off Timer	92
Preheat Mode	92
Enter Auto Power Shut-Off after the Remote Job	92
Toner Save Mode	92

Program name	Page
List Print	
User Info. Print	92
Colour Adjust.	
Easy Calibration	93
Tone Adjustments	93
Return to Default	94
Security Settings	
IPsec Settings	94
Initialize Private Data and Data in Machine	94

ADMINISTRATOR SETTINGS MENU

The system settings are accessed via the following menu structure. Refer to this menu when enabling or disabling the settings that are explained beginning on p.88. Some settings contain an additional level of settings (a settings screen).

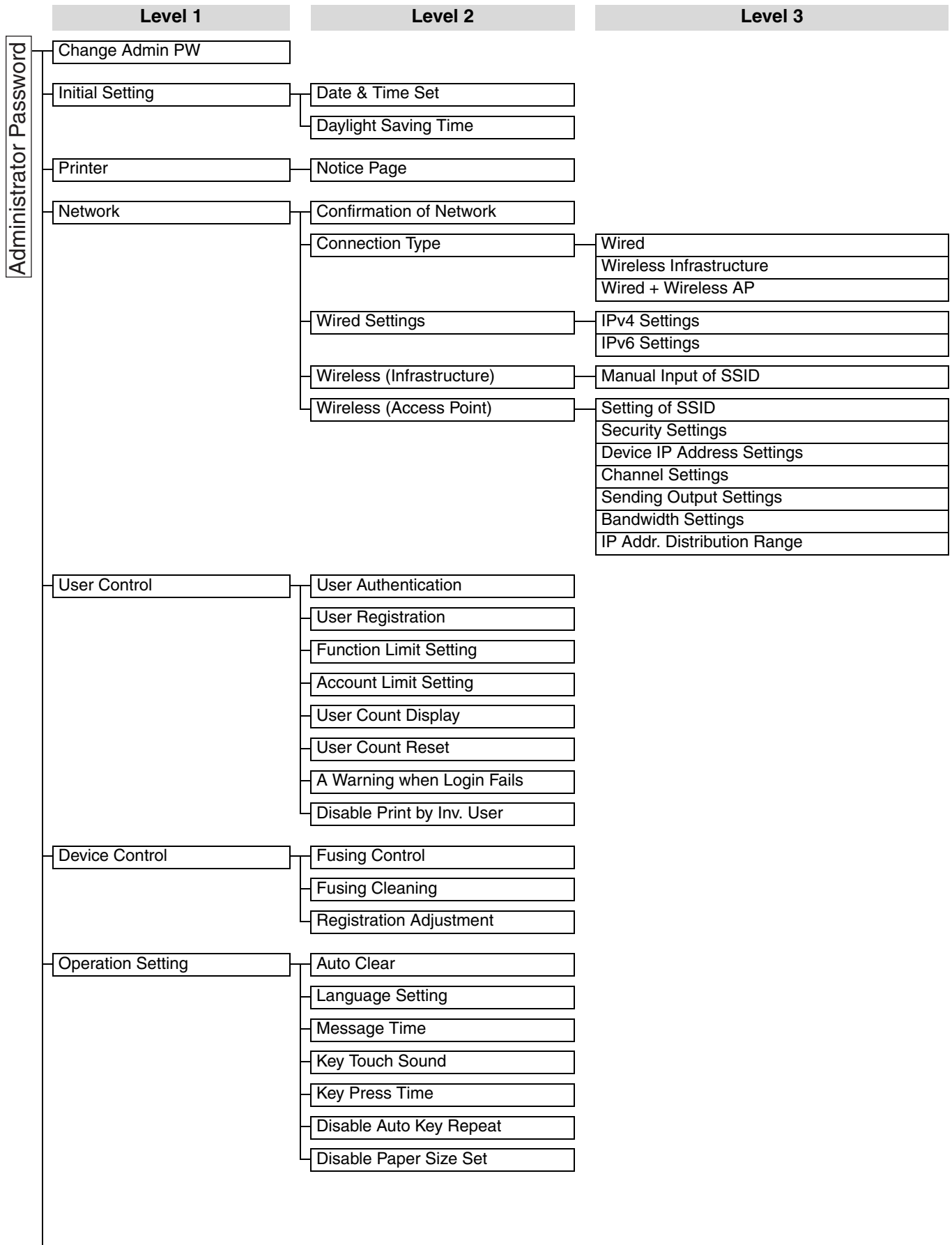

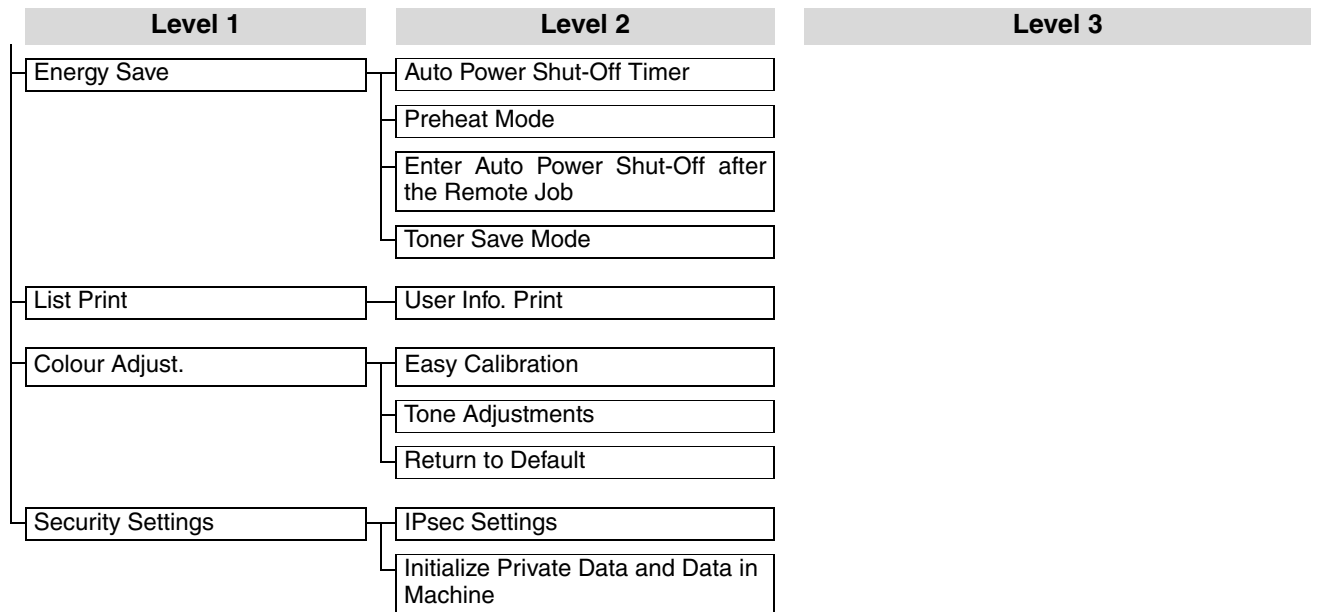

Change Admin PW

Use this function to change administrator password. To change the administrator password, see "PROGRAMMING AN ADMINISTRATOR PASSWORD" (p.83).

Initial Setting

The default settings for operation of the machine can be configured. Select the [Initial Setting] to configure the settings.

Date & Time Set

Use this to set the date and time in the machine's built-in clock.

Daylight Saving Time

Enable daylight saving time.

Printer

Settings related to the printer function can be configured. Select the [Printer] to configure the settings.

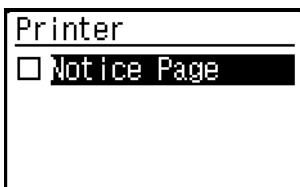

Notice Page

Set whether a notice page is printed when printing does not take place due to an error such as memory full.

Network

Network settings are described below. Select the [Network] key to configure the settings.

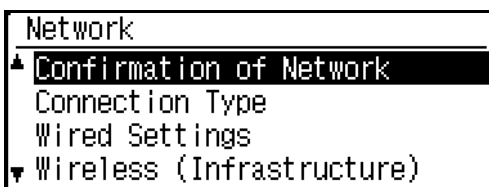

Confirmation of Network

Confirm network settings.

Connection Type

You can change the machine's network connection type.

Wired Settings

IPv4 Settings

When using the machine on a TCP/IP (IPv4) network, use this setting to configure the IP address of the machine.

The settings are shown below.

Enable DHCP

Use this setting to have the IP address obtained automatically using DHCP (Dynamic Host Configuration Protocol). When this setting is enabled, it is not necessary to manually enter an IP address.

IPv4 Address

Enter the IP address of the machine.

Subnetmask

Enter the Subnetmask.

Default Gateway

Enter the Default Gateway.

IPv6 Settings

When using the machine on a TCP/IP (IPv6) network, use this setting to configure the IP address of the machine.

The settings are shown below.

Enable IPv6 Protocol

Enable this setting.

Enable DHCPv6

Use this setting to have the IP address obtained automatically using DHCP (Dynamic Host Configuration Protocol). When this setting is enabled, it is not necessary to manually enter an IP address.

Manual Address

Enter the IP address of the machine.

Prefix Length

Enter the prefix length (0 to 128).

Default Gateway

Enter the IP Gateway address.



- If DHCP is used, the IP address assigned to the machine may change automatically. If the IP address changes, printing will not be possible.
- In an IPv6 environment, the machine can use LPD protocol.

Wireless (Infrastructure) (Only on models with wireless LAN)

This sets connection using wireless infrastructure mode.

Manual Input of SSID

Enter up to 32 half-width characters for the SSID.

Security Type

Select the security type.
(none/WEP/WPA Personal/WPA2 Personal)

Setting of Encrypt

Select the encryption method based on the "Setting of Security Type" setting.
(none/WEP/TKIP/AES)

Security Key Settings

Set the security key used for wireless connection.

WEP	5 half-width numeric digits, 10 hexadecimal (64 bit) digits, 13 half-width numeric digits, or 26 hexadecimal (128 bit) digits
WPA Personal	8 to 63 half-width numeric digits or 64 hexadecimal digits
WPA2 Personal	

Wireless (Access Point) (Only on models with wireless LAN)

This sets connection using wireless access point mode.

Setting of SSID

Enter up to 32 half-width characters for the SSID.

Security Settings

- **Security Type**

Select the security type.
(none/WEP/WPA Personal/WPA2 Personal)

- **Setting of Encrypt**

Select the encryption method based on the "Setting of Security Type" setting.
(none/WEP/TKIP/AES)

- **Security Key Settings**

Set the security key used for wireless connection.

WEP	5 half-width numeric digits, 10 hexadecimal (64 bit) digits, 13 half-width numeric digits, or 26 hexadecimal (128 bit) digits
WPA Personal	8 to 63 half-width numeric digits or 64 hexadecimal digits
WPA2 Personal	

Device IP Address Settings

Set the IP address of the access point.

Channel Settings

Set the channel used for the access point.

Sending Output Settings

Set the transmission output of the access point.

Bandwidth Settings

Set the frequency band of the access point.

IP Addr. Distribution Range

Set the lease range and lease period of the IP address used for the access point.

User Control

User Control is used to configure settings for user authentication. Select the [User Control] to configure the settings.

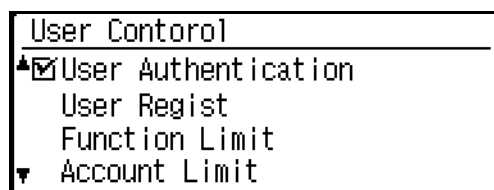

User Authentication

These settings enable or disable user authentication and specify the authentication method.

When user authentication is enabled, each user of the machine is registered. When a user logs in, settings for that user are applied.

User Registration

Users can be added, deleted, and changed.



- When entering a user number, the [OK] key is not enabled until 5 digits have been entered.
- If the [Clear] key is pressed during entry of a user number, the displayed user number changes to "-----".

Function Limit Setting

Set functions that all users or a specific user can use.

- Colour
- B/W
- USB Memory Direct Print



For the users that are prohibited to use Colour, using USB Memory Direct Print will be prohibited even if they have been permitted to use it.

Account Limit Setting

Printing paper limits can be set for all users or specific users.

User Count Display

This setting is used to display the print page counts of each account, and the usage limits for printing. Misfed pages are not included in the page counts.

To change to a different account number, press the [▼] or [▲] key.

Select and display the type with the [◀] or [▶] key.

User Count Reset

This setting is used to reset the print page counts of an individual account, or all accounts, to zero.

A Warning when Login Fails

When this setting is enabled, the machine will not allow operation for one minute if an incorrect account number is entered three times in a row. During this time, "This operation is disabled. Please contact your administrator." will appear in the display.

Disable Print by Inv. User

When enabled, this setting cancels a print job if no account number is entered or an invalid account number is entered. This setting is only effective when "User Authentication" has been enabled.

The function is initially enabled (factory default setting).



Pages printed by invalid account numbers are added to the page count of "Others" (account number).

Device Control

These settings are used to configure settings for hardware functions of the machine. To access one of these settings, select "Device Control" in the mode selection screen, select the desired setting in the device control screen, and press the [OK] key.

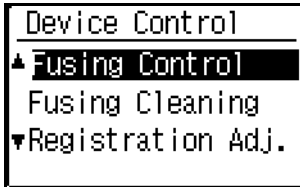

Fusing Control

The temperature of toner fusing is controlled according to the weight of the paper that is used.



- Be sure to use only paper that is in the same weight range as the weight range set here. Do not mix in other standard paper that differs from the set range.
- When settings are changed, the changes will take effect after the machine is restarted. To restart the machine, see "POWER ON AND OFF" (p.12).

Fusing Cleaning

Use this function to clean the machine's fusing unit when dots or other dirt appear on the printed side of the paper. When this function is executed, "V" printed paper is output and the fusing unit is cleaned.



If improvement is not noticed after the first time you use the function, try executing the function again.

Registration Adjustment

If the colours are out of place on the printed surface when colour printing is performed, the print positions of the colours can be adjusted.

Select "Registration Adj." and press [OK] key to start automatic registration. When appearing the complete message, the adjustment is completed.



Depending on the machine's condition, adjustment error message may appear. In that case, execute the registration adjustment again.

Operation Setting

These settings are used to configure various settings related to the operation panel. To access one of these programs, select "Operation Setting" in the mode selection screen, select the desired setting in the operation setting screen, and press the [OK] key.

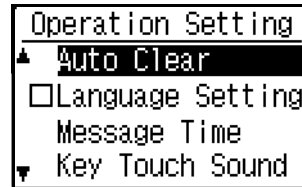

Auto Clear

The machine is set at the factory to return the display to the home screen one minute after a print job is finished or when the [HOME] key () is pressed. Time selections are "0 sec.", "10 sec.", "20 sec.", "60 sec.", "90 sec." and "120 sec.".

The factory default setting is 60 seconds. Select "Auto Clear" and press the [OK] key. The following screen will appear.

Select the desired time with the [◀] or [▶] key. If you do not want auto clear to operate, select "0".

Language Setting

This setting is used to select the display language. Select "Language Setting", press the [OK] key, and follow the steps below.

Message Time

This setting is used to set the length of time that messages appear in the display (this applies to messages that appear for a certain length of time and then automatically disappear.) Select from "Short (3 sec.)", "Normal (6 sec.)", or "Long (9 sec.)".

The factory default setting is "Normal (6 sec.)".

Key Touch Sound

This setting is used to set the length of the key touch sound that is heard each time a key is pressed.

The initial factory setting is "Short".

Select the desired length with the [▼] or [▲] key.

To turn the key touch sound off, select "Off".

Key Press Time

This setting is used to set the duration of time that a key must be pressed to take effect.

A longer setting can be selected to prevent keys pressed accidentally from taking effect. Keep in mind, however, that when a longer setting is selected more care is required when pressing keys to ensure that the key input is registered.

The initial factory setting is "Minimum".

Disable Auto Key Repeat

This setting is used to stop a setting from changing continuously when the [▼] or [▲] key is held down, such as selecting a menu item (auto key repeat will not operate). When this setting is enabled, a key must be pressed repeatedly instead of holding it down. Auto key repeat is initially set to operate (factory default setting).

Disable Paper Size Set

This setting is used to disable "Paper Size Set" in the special functions menu. When disabled, "Paper Size Set" cannot be used when the [Special Function] key (Fn) is pressed, which prevents users other than the administrator from easily changing the paper size setting.

"Disable Paper Size Set" is initially disabled (factory default setting).

Energy Save

These settings are used to configure energy saving settings. To access one of these settings, select "Energy Save" in the mode selection screen, and select the desired setting in the energy save screen, and then press the [OK] key.

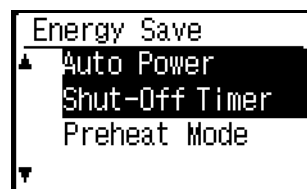

Auto Power Shut-Off Timer

This setting is used to set the duration of time until auto power shut-off mode activates when the operation panel is not used. Using this function helps conserve energy, preserve natural resources, and reduce environmental pollution.

"1 min.", "3 min.", "5 min.", "10 min.", "15 min.", "30 min.", "45 min." or "60 min." can be selected for the duration of time. Select a setting that suits your work conditions.

Preheat Mode

This setting is used to set the duration of time until preheat mode, which automatically lowers the fusing unit temperature, activates when the operation panel is not used. Using this function helps conserve energy, preserve natural resources, and reduce environmental pollution. "1 min.", "3 min.", "5 min.", "10 min.", "15 min.", "30 min.", "45 min." or "60 min." can be selected for the duration of time. Select a setting that suits your work conditions.

Enter Auto Power Shut-Off after the Remote Job

When the machine completes a print job received from the PC, the machine immediately returns to the Auto Power Shut-Off mode.

Toner Save Mode

You can reduce the amount of toner used for printing.



Toner Save Mode is only effective when the machine's printer driver is not used. When the printer driver is used, the printer driver setting takes precedence. This function may not operate in some applications and operating systems.

List Print

This is used to print lists and reports that are only for use by the administrator of the machine.

Select the [List Print] to configure the settings.

- User Info. Print
The user name, user number, paper used, paper limits, and function permission settings can be printed for each user.

Colour Adjust.

This machine provides the colour adjustment ways as shown below.

Easy Calibration and Tone Adjustments

The machine has two colour adjustment functions. Use the appropriate function depending on the situation.

- Easy Calibration
Use to fit the grey balance. This function implements a test page print out.
- Tone Adjustments
Use to adjust the tone density of each colour. This function does not implement a test page print out.

Easy Calibration

This function is performed by selecting the desired colour of grey (processed grey), which is a combination of cyan, magenta, and yellow on the printed test page.

Before using the Easy Calibration, load A4 or 8-1/2" x 11" white plain paper in the tray.

Note The result of colour reproduction depends on paper quality. It is recommended to adjust with the actual paper to be printed.

- (1) Select [Colour Adjust.] on the operation panel and press [OK] key.

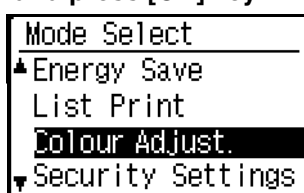

- (2) Select [Easy Calibration] and press [OK] key, then press again [OK] key to print out the test page.

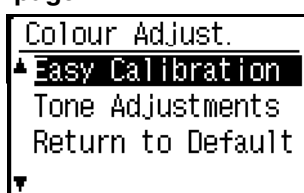

- (3) View the test page from directly in front, and select the cell that is closest to the neutral grey.

Place five sheets of white plain paper under the printed test page so that no background colour or pattern shows through the test page.

Note Be careful that the visibility of the grey patch may be affected by the environmental illumination.

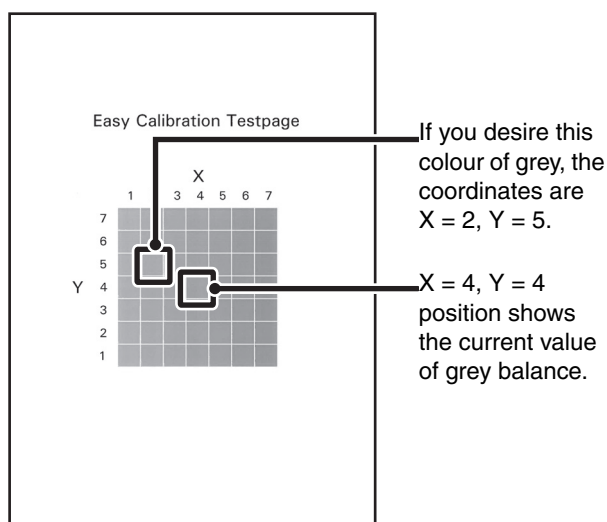

The test page is divided into cells with 7 on the horizontal axis (X) and 7 on the vertical axis (Y). Each cell is filled in with grey mixed with a varied hue of colour.

- (4) Enter the coordinates of the colour selected in step (3) in [X] and [Y] of the Easy Calibration and press [OK] key.

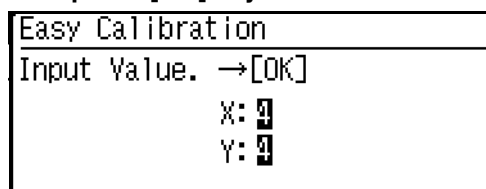

If X = 4 and Y = 4 are entered, grey balance doesn't change. If the colour adjustment is not satisfactory on the trial print, repeat the above procedure (1) to (4). If the colour is still not satisfactory after repeating the procedure several times, use the "Tone Adjustments".

Tone Adjustments

This function is used to adjust each of the density levels (low, mid, and high) of the four colour components, cyan, magenta, yellow and black.

- (1) Select [Colour Adjust.] on the operation panel and press [OK] key.

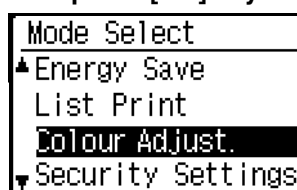

- (2) Select [Tone Adjustments] and press [OK] key, then Tone Adjustments setting screen appears.

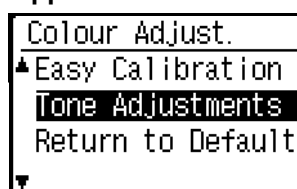

Enter each number in the range of 1 to 7 to the colours of C (Cyan), M (Magenta), Y (Yellow) and Bk (Black).

Initially the setting screen for [Low] level appears. You can change the screen for [Middle] and [High] with [▼][▲] keys.

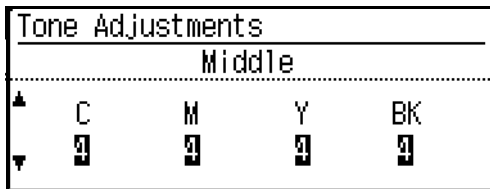

Factory default number for each colour is set to "4" respectively.
Increasing the number will make the print darker and decreasing the number will make it lighter.

Return to Default

The colour adjustment setting values can be initialized to the factory default ones by selecting [Return to Default] in [Colour Adjust.] menu.

- (1) Select [Return to Default] in [Colour Adjust.] menu and press [OK] key.

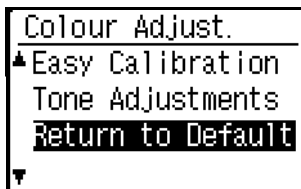

- (2) Confirmation screen appears and select [Yes] to initialize the value to default, or select [No] to return to [Mode Select] screen.

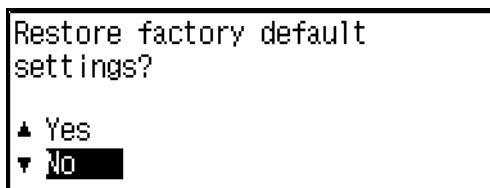

Security Settings

The following settings are related to security.
Select the [Security Settings] to configure the settings.

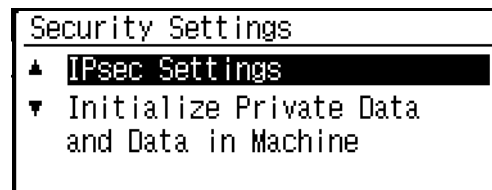

IPsec Settings

IPsec can be used for data transmission/reception on a network.

IKEv1 Settings

Configure the IKEv1 settings.

Initialize Private Data and Data in Machine

The system-set values can be restored to the factory default state after eliminating the data stored in the machine.

- Current values set for system settings
- Current values set for network settings
- User information > User registration information
- User information > Paper limits
- User information > Function usage restrictions
- User information > User counts (Excluding default users)
- Product key

6

WEB FUNCTIONS IN THE MACHINE

ABOUT THE WEB PAGES

The machine includes a built-in Web server. The Web server is accessed using a Web browser on your computer. The Web pages include both pages for users and pages for the administrator. In the user Web pages, users can monitor the machine, and select printer configuration settings. In the administrator Web pages, the administrator can configure the machine's settings, and passwords. Only the administrator is allowed to configure these settings.

HOW TO ACCESS THE WEB PAGE

Use the following procedure to access the Web pages.

1 Open the Web browser on your computer.

Supported browsers:

Internet Explorer: 6.0 or higher (Windows®)

Netscape Navigator: 9 (Windows®)

Firefox: 2.0 or higher (Windows®)

2 In the "Address" field of your Web browser, enter the IP address that has been configured in the machine.

When the connection is completed, the Web page will appear in your Web browser.

"ABOUT THE WEB PAGES (FOR USERS)" (p.96)

3 When finished, close the Web pages.

When you have finished using the Web pages, click the  (close) button in the top right corner of the page.

ABOUT THE WEB PAGES (FOR USERS)

When you access the user Web pages in the machine, the following page will appear in your browser. A menu frame appears on the left side of the page. When you click an item in the menu, a screen appears in the right frame that allows you to configure settings for that item.

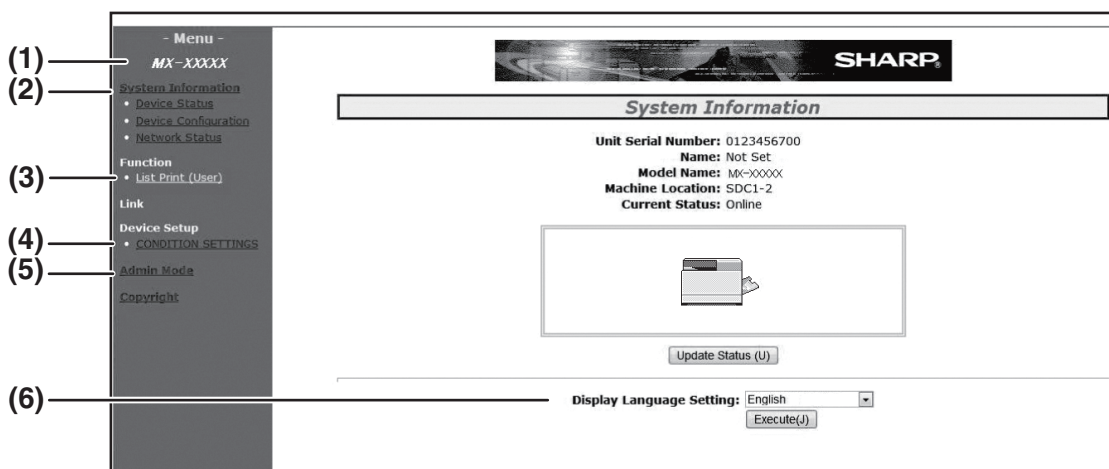

(1) Menu frame

Click a setting in the menu to configure it.

(2) System Information

Shows the current status of the machine and model name.

- Device Status
Shows the current status of the machine, paper trays, output trays, toner and other supplies, and page counts.
Out of paper and other warnings appear in red.
- Device Configuration
Shows what options are installed.
- Network Status
Shows the network status. Information on "General" and "TCP/IP" is shown on the respective pages.

(3) Data List Print

You can print out the various settings that you have selected.

(4) Condition Settings

Configure basic printer settings and printer language settings.

"CONFIGURING THE PRINTER CONDITION SETTINGS" (p.97)

(5) Admin Mode

To open the Web pages for the administrator, click here and then enter the administrator's user name and password.

"ABOUT THE WEB PAGES (FOR THE ADMINISTRATOR)" (p.100)

"PROTECTING INFORMATION PROGRAMMED IN THE WEB PAGE ([Passwords])" (p.102)

(6) Display Language Setting

Select the desired language setting from the pull-down menu.

CONFIGURING THE PRINTER CONDITION SETTINGS

The printer condition settings allow basic printer settings to be configured. The following items can be set:

- "Default Settings" (p.98): Basic settings that are mainly used when the printer driver is not used.
- "PCL Settings" (p.99): PCL symbol set, font, line feed code, and other settings.



When the printer driver is used and the same settings are configured both in the printer driver and in the above screens, the settings configured in the printer driver override the settings in the above screens. If a setting is available in the printer driver, use the printer driver to configure the setting.

HOW TO CONFIGURE THE SETTINGS

To display the Condition Settings screen, click [Condition Settings] in the menu frame.

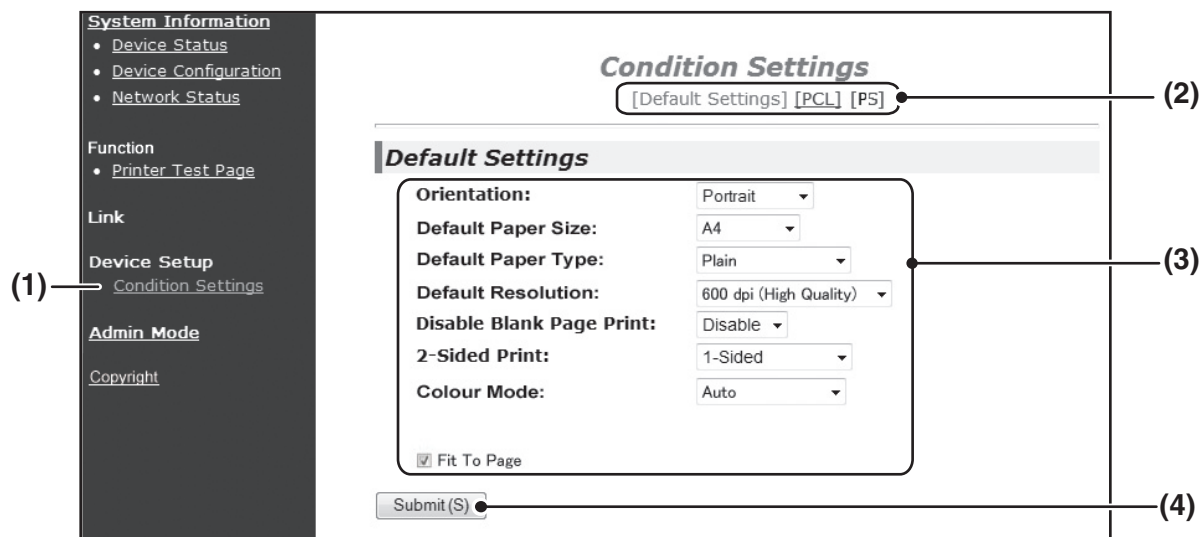

(1) Condition Settings

This displays the page for configuring the printer condition settings.

(2) Default Settings/ PCL/PS

Select the type of condition settings that you wish to configure.

(3) Settings

The factory default settings are displayed.

Change the settings as desired by selecting from drop-down lists and by directly entering settings.

For information on the settings, see "PRINTER CONDITION SETTINGS" (p.98).

(4) Submit

Click to store the Web page settings in the machine.

PRINTER CONDITION SETTING MENU

Condition Settings	
Default Settings	Factory default settings
Orientation	Portrait
Default Paper Size	A4
Default Paper Type	Plain
Default Resolution	600dpi (High Quality)
Disable Blank Page Print	Disable
2-Sided Print	1-Sided
Colour Mode	Auto
Fit To Page	ON

Condition Settings	
PCL Settings	Factory default settings
Symbol Set	PC-8
Font	0: Courier (internal font)
Line Feed Code	CR=CR; LF=LF; FF=FF
PS Settings	Factory default settings
Print PS Errors	Disable

PRINTER CONDITION SETTINGS

Factory default settings are indicated in bold.

Default Settings

Item	Selections	Description
Orientation	Portrait , Landscape	This sets the orientation of the printed page. Select [Portrait] when the image is longer in the vertical direction, or [Landscape] when the image is longer in the horizontal direction.
Default Paper Size	A4 , B5, A5, Letter, Invoice, Executive	Set the default paper size used for printing.
Default Paper Type	Plain , Letter head, Pre-printed, Pre-punched, Recycled, Colour	Set the type of paper used for printing.
Default Resolution	600dpi, 600dpi (High Quality)	Set the printing resolution.
Disable Blank Page Print	Enable, Disable	When this is specified, blank pages with no print data will not be printed.
2-Sided Print	1-Sided , 2-Sided (Book), 2-Sided (Tablet)	When [2-Sided (Book)] is selected, two-sided printing takes place so as to allow binding at the left side. When [2-Sided (Tablet)] is selected, two-sided printing takes place so as to allow binding at the top. (Only for models that support two-sided printing.)
Colour Mode	Auto , Black & White	Set the colour mode used for printing.
Fit To Page	ON , OFF	Set whether the printed image is fit to the size of the paper.

PCL Settings

Item	Selections	Description
Symbol Set	Select one of 35 sets.	This specifies which country's characters (PCL symbol set) are assigned to certain of the symbols in the character code list. The factory default setting is [PC-8].
Font	Select one internal font.	This specifies which PCL font to use for printing. One font can be specified from among the internal fonts. The factory default setting is [0: Courier].
Line Feed Code	CR=CR; LF=LF; FF=FF, CR=CR+LF; LF=LF; FF=FF, CR=CR; LF=CR+LF; FF=CR+FF, CR=CR+LF; LF=CR+LF; FF=CR+FF	This specifies the line break code by means of a combination of the "CR" (return) code, "LF" (line break) code, and "FF" (page break) code. The factory default setting is printing based on the transmitted code. The setting can be changed by selecting one of four combinations.

PostScript settings

Item	Settings	Description
Print PS Errors	Enable, Disable	When this setting is enabled, an error description is printed each time a PostScript error occurs.

ABOUT THE WEB PAGES (FOR THE ADMINISTRATOR)

In addition to the menus that appear for users, other menus that can only be used by the administrator appear in the administrator Web pages.

A menu frame appears on the left side of the page. When you click an item in the menu, a screen appears in the right frame that allows you to configure settings for that item. Settings that can only be configured by the administrator are explained here.

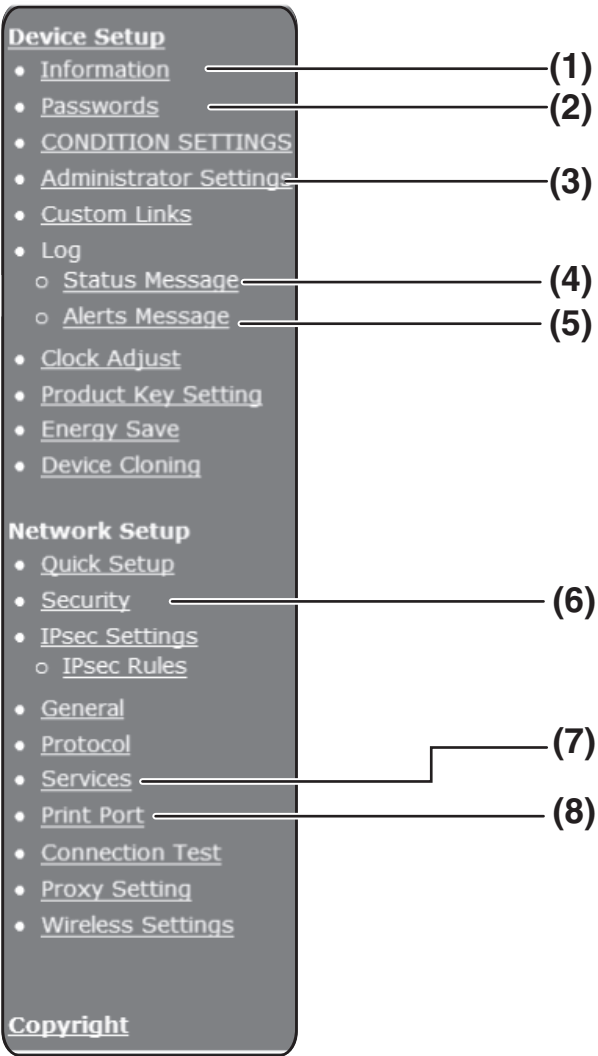

- (1)Information**
Configure machine identification information for the status & alert E-mail function.
"INFORMATION SETUP" (p.104)
- (2)Passwords**
To protect the Web site, the system administrator can establish passwords. Enter a password that you would like to establish and click the [Submit] button.
One password can be established for the administrator and one password can be established for users.
"PROTECTING INFORMATION PROGRAMMED IN THE WEB PAGE ([Passwords])" (p.102)
- (3)Administrator Settings**
Setting changes can be prohibited and interface settings can be configured.
"ADMINISTRATOR SETTINGS" (p.103)
- (4)Status Message**
Configure parameters required for sending status messages, such as destination addresses and time schedules.
"STATUS MESSAGE SETUP" (p.105)
- (5)Alerts Message**
Store destination addresses for alert messages.
"ALERTS MESSAGE SETUP" (p.105)
- (6)Security**
Unused ports can be disabled for greater security and port numbers can be changed.
- (7)Services**
Configure information concerning the e-mail system.
"SMTP SETUP" (p.104)
- (8)Print Port**
Configure settings for LPD and Raw print.

CONFIGURING SMTP AND DNS SERVER SETTINGS

The procedures for using [Quick Setup] are explained here. [Quick Setup] is used to quickly configure only the required settings for "SMTP", and "DNS" servers. These settings are normally configured first.

SMTP server: SMTP is used to transmit e-mail.

To use these transmission methods, your SMTP server settings must be configured.

DNS server: If you entered a host name in "Primary SMTP Server" or "Secondary SMTP Server" of "SMTP", you must also configure your DNS server settings.

1 Click [Quick Setup] in the menu frame.



2 Enter the required information in "SMTP" and "DNS".

3 When you have completed all of the entries, click [Submit].

The entries will be stored.



If you need to configure advanced settings for the SMTP, and DNS servers, follow the procedures below. Click [Services] in the menu frame to display the services setup screen. Select the desired server and then configure the required parameters for that server.

PROTECTING INFORMATION PROGRAMMED IN THE WEB PAGE ([Passwords])

Passwords can be set (click [Passwords] in the menu frame) to restrict Web page access and protect settings. The administrator must change the password from the factory default setting. The administrator must also take care to remember the new password. The next time the Web pages are accessed, the new password must be entered. A password can be set for the administrator and a password can be set for users.

1 Click [Passwords] in the menu frame.

2 Enter the current password in "Admin Password".

When establishing a password for the first time, enter "admin" in "Admin Password".



Be sure to enter "admin" in lower case (passwords are case sensitive).

3 Enter passwords in "User Password" and "Admin Password".

- A maximum of 7 characters and/or numbers can be entered for each password (passwords are case sensitive).
- Be sure to enter the same password in "Confirm Password" as you did in "New Password".

4 When you have finished entering all items, click [Submit].

The entered password is stored.

After setting the password, turn the machine power off and then back on.



When prompted to enter a user name, a user should enter "users" and an administrator should enter "admin" in "User Name". In "Password", the respective password for the entered user name should be entered.

ADMINISTRATOR SETTINGS

The administrator settings are used to prohibit changes to the [Condition Settings] and to configure interface settings.

- "Default settings": Select the setting for which you wish to prohibit changes.
- "Fusing Control" : The temperature of toner fusing is controlled according to the weight of the paper that is used.
- "Interface settings": Enable monitoring of data sent to the network port and set restrictions.

CONFIGURING A SETTING IN THE ADMINISTRATOR SETTINGS

1 Click [Administrator Settings] in the menu frame.

The "Default Settings" screen of the [Administrator Settings] will appear. If you wish to select a setting in the "Default Settings" screen, go to step 3.

2 Click the desired setting, and make a selection for the setting in the screen that appears.

See "ADMINISTRATOR SETTINGS" for descriptions of the settings.

3 Click [Submit] to store the entered information.

ADMINISTRATOR SETTINGS

When "YES, NO" appears in the "Settings" column, "YES" is selected when a checkmark appears in the checkbox of the item, and "NO" is selected when checkmark does not appear.

Default settings

Item	Settings	Description
Prohibit Test Page Printing	YES, NO	This setting is used to prohibit printing of a printer test page.
Disable Default Setting Changes	YES, NO	This setting is used to prohibit changes to the default condition settings.
List Prints	1-Sided, 2-Sided	Set whether lists are printed by 1-sided printing or 2-sided printing.

Fusing Control

Item	Settings	Description
Fusing Control	60-89 g/m² 90-105 g/m ²	The temperature of toner fusing is controlled according to the weight of the paper that is used.

Interface settings

Item	Settings	Description
I/O Timeout	1- 60 - 999 (sec)	During reception of a print job, if remaining data is not received after the time set here elapses, the port connection is broken and the next print job is begun.
Emulation Switching	Auto*, PostScript, PCL	Select the printer language. When [Auto] is selected, the language is automatically selected from the data sent to the printer. Unless errors occur frequently, do not change the setting from [Auto] to another setting.
Port Switching Method	Switch at End of Job, Switch after I/O Timeout	Select the method for switching network ports.

E-MAIL STATUS AND E-MAIL ALERT SETTINGS

These functions send information on machine use (print count, etc.) and error conditions (paper misfeed, out of paper, out of toner, etc.) via e-mail to the administrator of the machine or the dealer.

INFORMATION SETUP

Machine identification information for the status and alert e-mail functions is configured in the "Information Setup" screen. The entered information will be included in status and alert e-mail messages.

- 1 Click [Information] in the menu frame.**
The "Information Setup" screen will appear.
- 2 Enter the machine information.**
- 3 Click [Submit] to store the entered information.**

SMTP SETUP

The Status and alert e-mail functions use SMTP (Simple Mail Transport Protocol) to send e-mail. The following procedure is used to set up the e-mail environment. This must be done by the system administrator or other person familiar with the network.

- 1 Click [Services] in the menu frame.**
The "Services Setup" screen will appear.
- 2 Click [SMTP].**
- 3 Enter the information required to set up the e-mail environment.**
- 4 Click [Submit] to store the entered information.**

STATUS MESSAGE SETUP

Use the status message function to send the current counter information, including print count and total output count, based on the specified schedule. The destinations can be set for administrators and dealers respectively.

To set up the status message, follow these steps.

1 Click [Status Message] in the menu frame.

The "Status Message Setup" screen will appear.

2 Enter the required information, including the destination addresses and time schedule.

3 Click [Submit] to store the entered information.

When the E-mail Status settings are completed, printer count information will be sent periodically by e-mail to the specified e-mail addresses.



If you quit the browser before clicking [Submit], the settings will be cancelled. To send printer information immediately to the specified e-mail addresses, click [Send Now].

ALERTS MESSAGE SETUP

Use the alert message function to send alert information, such as empty toner and paper and trouble including paper misfeeds, to specified destinations when such problems occur. The destinations can be set for administrators and dealers respectively.

To set up the alert message, follow the procedure below.

1 Click [Alerts Message] in the menu frame.

The "Alerts Message Setup" screen will appear.

2 Enter the destination addresses.

3 Click [Submit] to store the entered information.

If these parameters are set, event information for the printer will be transmitted to the specified addresses via E-mail each time a specified event occurs. The meaning of each event item is shown below.

(Example)

Paper Jam:	A paper misfeed has occurred.
Toner Low:	Toner is low.
Toner Empty:	Toner must be added.
Paper Empty:	Paper must be loaded.



If you quit the browser before clicking [Submit], the settings will be cancelled.

Information on the Software License for This Product

Software composition

The software included in this product is comprised of various software components whose individual copyrights are held by SHARP or by third parties.

Software developed by SHARP and open source software

The copyrights for the software components and various relevant documents included with this product that were developed or written by SHARP are owned by SHARP and are protected by the Copyright Act, international treaties, and other relevant laws. This product also makes use of freely distributed software and software components whose copyrights are held by third parties. These include software components covered by a GNU General Public License (hereafter GPL), a GNU Lesser General Public License (hereafter LGPL) or other license agreement.

Obtaining source code

Some of the open source software licensors require the distributor to provide the source code with the executable software components. GPL and LGPL include similar requirements.

For information on obtaining the source code for the open source software and for obtaining the GPL, LGPL, and other license agreement information, visit the following website:

<http://sharp-world.com/products/copier/source/download/index.html>

We are unable to answer any questions about the source code for the open source software. The source code for the software components whose copyrights are held by SHARP is not distributed

TRADEMARK ACKNOWLEDGMENTS

The following trademarks and registered trademarks are used in conjunction with the machine and its peripheral devices and accessories.

- Microsoft®, Windows®, Windows® XP, Windows Server® 2003, Windows Vista®, Windows Server® 2008, Windows® 7, Windows® 8, Windows® 8.1, Windows Server® 2012 and Internet Explorer® are either registered trademarks or trademarks of Microsoft Corporation in the United States and/or other countries.
- Intel® is a trademark of Intel Corporation in the U.S. and/or other countries.
- Adobe, the Adobe logo, PostScript, Acrobat, the Adobe PDF logo, and Reader are either registered trademarks or trademarks of Adobe Systems Incorporated in the United States and/or other countries.
- Apple, Macintosh, Mac OS, AppleTalk, EtherTalk and LaserWriter are registered trademarks of Apple Inc.
- Netscape Navigator is a trademark of Netscape Communications Corporation.
- PCL is a registered trademark of the Hewlett-Packard Company.
- IBM, PC/AT, and PowerPC are trademarks of International Business Machines Corporation.
- Sharpdesk is a trademark of Sharp Corporation.
- All other trademarks and copyrights are the property of their respective owners.

Candid and Taffy are trademarks of Monotype Imaging, Inc. registered in the United States Patent and Trademark Office and may be registered in certain jurisdictions. CG Omega, CG Times, Garamond Antiqua, Garamond Halbfett, Garamond Kursiv, Garamond and Halbfett Kursiv are trademarks of Monotype Imaging, Inc. and may be registered in certain jurisdictions. Albertus, Arial, Coronet, Gill Sans, Joanna and Times New Roman are trademarks of The Monotype Corporation registered in the United States Patent and Trademark Office and may be registered in certain jurisdictions. Avant Garde, ITC Bookman, Lubalin Graph, Mona Lisa, Zapf Chancery and Zapf Dingbats are trademarks of International Typeface Corporation registered in the United States Patent and Trademark Office and may be registered in certain jurisdictions. Clarendon, Eurostile, Helvetica, Optima, Palatino, Stempel Garamond, Times and Univers are trademarks of Heidelberger Druckmaschinen AG, which may be registered in certain jurisdictions, exclusively licenced through Linotype Library GmbH, a wholly owned subsidiary of Heidelberger Druckmaschinen AG. Apple Chancery, Chicago, Geneva, Monaco and New York are trademarks of Apple Inc. and may be registered in certain jurisdictions. HGGothicB, HGMinchoL, HGPGothicB and HGPMInchoL are trademarks of Ricoh Company, Ltd. and may be registered in some jurisdictions. Wingdings is a registered trademark of Microsoft Corporation in the United States and other countries. Marigold and Oxford are trademarks of Arthur Baker and may be registered in some jurisdictions. Antique Olive is a trademark of Marcel Olive and may be registered in certain jurisdictions. Hoefler Text is a trademark of Johnathan Hoefler and may be registered in some jurisdictions. ITC is a trademark of International Typeface Corporation registered in the United States Patent and Trademark Office and may be registered in certain jurisdictions. Agfa is a trademark of the Agfa-Gevaert Group and may be registered in certain jurisdictions. Intellifont, MicroType and UFST are trademarks of Monotype Imaging, Inc. registered in the United States Patent and Trademark Office and may be registered in certain jurisdictions. Macintosh and TrueType are trademarks of Apple Inc. registered in the United States Patent and Trademark Office and other countries. PostScript is a trademark of Adobe Systems Incorporated and may be registered in some jurisdictions. HP, PCL, FontSmart and LaserJet are trademarks of Hewlett-Packard Company and may be registered in some jurisdictions. The Type 1 processor resident in Monotype Imaging's UFST product is under licence from Electronics For Imaging, Inc. All other trademarks are the property of their respective owners.

OPERATION GUIDE

SHARP®

SHARP CORPORATION

Free Manuals Download Website

<http://myh66.com>

<http://usermanuals.us>

<http://www.somanuals.com>

<http://www.4manuals.cc>

<http://www.manual-lib.com>

<http://www.404manual.com>

<http://www.luxmanual.com>

<http://aubethermostatmanual.com>

Golf course search by state

<http://golfingnear.com>

Email search by domain

<http://emailbydomain.com>

Auto manuals search

<http://auto.somanuals.com>

TV manuals search

<http://tv.somanuals.com>