

SHARP®

XV-Z15000

PROJECTOR
PROJECTEUR
PROYECTOR
PROJETOR

OPERATION MANUAL
MODE D'EMPLOI
MANUAL DE MANEJO
MANUAL DE OPERAÇÃO

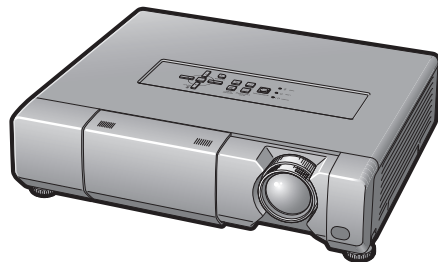
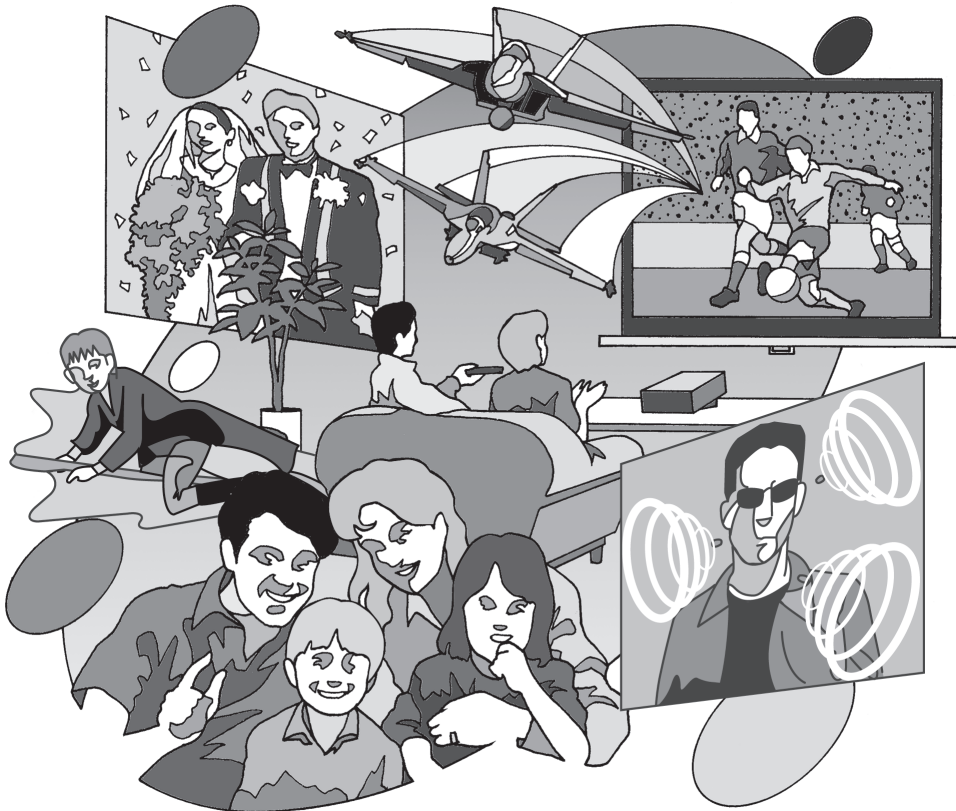

HDMI™
HIGH-DEFINITION MULTIMEDIA INTERFACE



ENGLISH

FRANÇAIS

ESPAÑOL

PORTUGUÊS

SPECIAL NOTE FOR USERS IN THE U.K.

The mains lead of this product is fitted with a non-rewireable (moulded) plug incorporating a 10A fuse. Should the fuse need to be replaced, a BSI or ASTA approved BS 1362 fuse marked  or  and of the same rating as above, which is also indicated on the pin face of the plug, must be used. Always refit the fuse cover after replacing the fuse. Never use the plug without the fuse cover fitted. In the unlikely event of the socket outlet in your home not being compatible with the plug supplied, cut off the mains plug and fit an appropriate type.

DANGER:

The fuse from the cut-off plug should be removed and the cut-off plug destroyed immediately and disposed of in a safe manner.

Under no circumstances should the cut-off plug be inserted elsewhere into a 13A socket outlet, as a serious electric shock may occur.

To fit an appropriate plug to the mains lead, follow the instructions below:

WARNING:

THIS APPARATUS MUST BE EARTHED.

IMPORTANT:

The wires in this mains lead are coloured in accordance with the following code:

Green-and-yellow	:	Earth
Blue	:	Neutral
Brown	:	Live

As the colours of the wires in the mains lead of this apparatus may not correspond with the coloured markings identifying the terminals in your plug proceed as follows:

- The wire which is coloured green-and-yellow must be connected to the terminal in the plug which is marked by the letter E or by the safety earth symbol  or coloured green or green-and-yellow.
- The wire which is coloured blue must be connected to the terminal which is marked with the letter N or coloured black.
- The wire which is coloured brown must be connected to the terminal which is marked with the letter L or coloured red.

IF YOU HAVE ANY DOUBT, CONSULT A QUALIFIED ELECTRICIAN.

Before using the projector, please read this operation manual carefully.

Introduction

IMPORTANT

- For your assistance in reporting the loss or theft of your Projector, please record the Serial Number located on the bottom of the projector and retain this information.
- Before recycling the packaging, please ensure that you have checked the contents of the carton thoroughly against the list of "Supplied accessories" on page 8.

Model No.: XV-Z15000



Serial No.:

WARNING: High brightness light source. Do not stare into the beam of light, or view directly. Be especially careful that children do not stare directly into the beam of light.



WARNING: To reduce the risk of fire or electric shock, do not expose this product to rain or moisture.

See bottom of projector.

	<p>CAUTION</p> <p>RISK OF ELECTRIC SHOCK. DO NOT REMOVE SCREWS EXCEPT SPECIFIED USER SERVICE SCREW.</p>	
<p>CAUTION: TO REDUCE THE RISK OF ELECTRIC SHOCK, DO NOT REMOVE COVER. NO USER-SERVICEABLE PARTS EXCEPT LAMP UNIT. REFER SERVICING TO QUALIFIED SERVICE PERSONNEL.</p>		



The lightning flash with arrowhead symbol, within an equilateral triangle, is intended to alert the user to the presence of uninsulated "dangerous voltage" within the product's enclosure that may be of sufficient magnitude to constitute a risk or electric shock to persons.



The exclamation point within a triangle is intended to alert the user to the presence of important operating and maintenance (servicing) instructions in the literature accompanying the product.

WARNING: This is a Class A product. In a domestic environment this product may cause radio interference in which case the user may be required to take adequate measures.

INFORMATION

This equipment has been tested and found to comply with the limits for a Class B digital device, pursuant to Part 15 of the FCC Rules. These limits are designed to provide reasonable protection against harmful interference in a residential installation. This equipment generates, uses, and can radiate radio frequency energy and, if not installed and used in accordance with the operation manual, may cause harmful interference to radio communications. However, there is no guarantee that interference will not occur in a particular installation. If this equipment does cause harmful interference to radio or television reception, which can be determined by turning the equipment off and on, the user is encouraged to try to correct the interference by one or more of the following measures:

- Reorient or relocate the receiving antenna.
- Increase the separation between the equipment and the receiver.
- Connect the equipment into an outlet on a circuit different from that to which the receiver is connected.
- Consult the dealer or an experienced radio/TV technician for help.

U.S.A. ONLY

WARNING: FCC Regulations state that any unauthorized changes or modifications to this equipment not expressly approved by the manufacturer could void the user's authority to operate this equipment.

U.S.A. ONLY

Declaration of conformity

SHARP PROJECTOR, MODEL XV-Z15000

This device complies with Part 15 of the FCC rules. Operation is subject to the following conditions: (1) This device may not cause harmful interference, and (2) this device must accept any interference received, including interference that may cause undesired operation.

Responsible Party:

SHARP ELECTRONICS CORPORATION
Sharp Plaza, Mahwah, New Jersey 07495-1163
TEL: 1-800-BE-SHARP (1-800-237-4277)

U.S.A. ONLY

PRODUCT DISPOSAL

This product utilizes tin-lead solder, and lamp containing a small amount of mercury. Disposal of these materials may be regulated due to environmental considerations. For disposal or recycling information, please contact your local authorities, the Electronics Industries Alliance: www.eiae.org, the lamp recycling organization www.lamprecycle.org, or Sharp at 1-800-BE-SHARP.

U.S.A. ONLY

Caution Concerning Lamp Replacement

See "Replacing the Lamp" on page 50.

This SHARP projector uses a DLP® chip. This very sophisticated panel contains 2,073,600 pixels (micromirrors). As with any high technology electronic equipment such as large screen TVs, video systems and video cameras, there are certain acceptable tolerances that the equipment must conform to.

This unit has some inactive pixels within acceptable tolerances which may result in inactive dots on the picture screen. This will not affect the picture quality or the life expectancy of the unit.

Authorized representative responsible for the European Union Community Market

SHARP ELECTRONICS (Europe) GmbH
Sonninstraße 3, D-20097 Hamburg

E.U. ONLY

Contents

Preparing

Introduction

Contents	3
How to Read this Operation Manual	4
IMPORTANT SAFEGUARDS	5
Accessories	8
Part Names and Functions	9
Using the Remote Control	12
Inserting the Batteries	12
Usable Range	12

Quick Start

Quick Start	13
-------------------	----

Setup

Setting Up the Projector	15
Setting Up the Projector	15
Standard Setup (Front Projection)	15
Projection (PRJ) Mode	16
Ceiling-mount Setup	16
Screen Size and Projection Distance	17

Connections

Samples of Cables for Connection	18
Connecting to Video Equipment	19
Connecting to a Computer	20
Controlling the Projector by a Computer	21

Using

Basic Operation

Turning the Projector On/Off	22
Connecting the Power Cord	22
Turning the Projector On	22
Turning the Power Off	22
(Putting the Projector into Standby Mode)	22
Image Projection	23
Adjusting the Projected Image	23
Keystone Correction	24
Auto V-Keystone Correction	25
Switching the Input Mode	26
Adjusting the Vertical and Horizontal Position of the Image	26
Displaying the Black Screen Temporarily	27
Freezing a Moving Image	27
Auto Sync (Auto Sync Adjustment)	27
Selecting the Picture Mode	27
Displaying an Enlarged Portion of an Image	28
Switching the Iris Setting	28
Hiding the Menu Temporarily (Menu Hide)	28
Switching the Eco+Quiet Mode	28
Resize Mode	29

Useful Features

Menu Bar Items	31
Using the Menu Screen	34
Menu Selections (Adjustments)	34
Picture Adjustment ("Picture" Menu)	36
Selecting the Picture Mode	36
Adjusting the Image	36
Switching the Iris Setting	37
Eco+Quiet	37
Using the Advanced	37
Correcting Gradation of Video (Gamma Correction)	37
Adjusting the Colors	37
Adjusting the Bright Boost	39

Selecting the Film Mode	39
Setting Detail Enhancement	39
Reducing Image Noise (DNR)	39
Mosquito Noise Reduction (MNR)	39
Resetting All Adjustment Items	39
Computer Image Adjustment ("SIG-ADJ" Menu)...	40
Adjusting the Computer Image	40
Setting the Resolution	40
Auto Sync (Auto Sync Adjustment)	40
Signal Type Setting	40
Setting the Video System	41
Setting the Video Setup	41
Adjusting the Dynamic Range	41
Signal Info	41
Adjusting the Projected Image ("SCR-ADJ" Menu)...	42
Setting the Resize Mode	42
Adjusting the Image Position	42
Adjusting the Overscan	42
Auto V-Keystone Correction	43
Keystone Mode Correction	43
Setting On-screen Display	44
Setting the Brightness of the Menu Screen	44
Selecting the Background Image	44
Selecting the Menu Screen Position	44
Reversing/Inverting Projected Images	44
Selecting the On-screen Display Language	44
Adjusting the Projector Function ("PRJ-ADJ" Menu)...	45
Setting Auto Power Off Mode	45
Setting the Power Save Mode (Economy Mode)	45
Setting One Touch Play, System Standby	45
and Input Name	45
Setting the Demo Mode	46
Selecting the Transmission Speed (RS-232C)	46
Fan Mode Setting	46
Returning the Default Settings	46
Lamp Timer (Life)	46

Reference

Appendix

Maintenance	47
Maintenance Indicators	48
Regarding the Lamp	50
Lamp	50
Caution Concerning the Lamp	50
Replacing the Lamp	50
Removing and Installing the Lamp Unit	51
Resetting the Lamp Timer	52

Connecting Pin Assignments	53
RS-232C Specifications and Commands	54
Computer Compatibility Chart	57
Troubleshooting	58
For SHARP Assistance	60
Specifications	61
Dimensions	62
Index	63

How to Read this Operation Manual

- The specifications are slightly different, depending on the model. However, you can connect and operate all models in the same manner.
- In this operation manual, the illustration and the screen display are simplified for explanation, and may differ slightly from the actual display.

Using the Menu Screen

Buttons used in this operation

Menu Selections (Adjustments)

- This operation can also be performed by using the buttons on the projector.

- 1** Press **MENU**
 - The "Picture" menu screen for the selected input mode is displayed.
- 2** Press **▶** or **◀** to select the menu screen to adjust on the menu bar.

Example: "Picture" menu screen when COMPONENT is selected for input mode

Button used in this step

On-screen display

CS-34

Info Indicates safeguards for using the projector.

Note Indicates additional information for setting up and operating the projector.

For Future Reference

Maintenance

➔ P. 47

Troubleshooting

➔ P. 58 and 59

Index

➔ P. 63

IMPORTANT SAFEGUARDS

CAUTION: Please read all of these instructions before you operate this product and save these instructions for later use.

Electrical energy can perform many useful functions. This product has been engineered and manufactured to assure your personal safety. BUT IMPROPER USE CAN RESULT IN POTENTIAL ELECTRICAL SHOCK OR FIRE HAZARDS. In order not to defeat the safeguards incorporated in this product, observe the following basic rules for its installation, use and servicing.

1. Read Instructions

All the safety and operating instructions should be read before the product is operated.

2. Retain Instructions

The safety and operating instructions should be retained for future reference.

3. Heed Warnings

All warnings on the product and in the operating instructions should be adhered to.

4. Follow Instructions

All operating and use instructions should be followed.

5. Cleaning

Unplug this product from the wall outlet before cleaning. Do not use liquid cleaners or aerosol cleaners. Use a damp cloth for cleaning.

6. Attachments

Do not use attachments not recommended by the product manufacturer as they may cause hazards.

7. Water and Moisture

Do not use this product near water—for example, near a bath tub, wash bowl, kitchen sink, or laundry tub; in a wet basement; or near a swimming pool; and the like.

8. Accessories

Do not place this product on an unstable cart, stand, tripod, bracket, or table. The product may fall, causing serious injury to a child or adult, and serious damage to the product. Use only with a cart, stand, tripod, bracket, or table recommended by the manufacturer, or sold with the product. Any mounting of the product should follow the manufacturer's instructions, and should use a mounting accessory recommended by the manufacturer.

9. Transportation

A product and cart combination should be moved with care. Quick stops, excessive force, and uneven surfaces may cause the product and cart combination to overturn.



10. Ventilation

Slots and openings in the cabinet are provided for ventilation to ensure reliable operation of the product and to protect it from overheating, and these openings must not be blocked or covered. The openings should never be blocked by placing the product on a bed, sofa, rug, or other similar surface. This product should not be placed in a built-in installation such as a bookcase or rack unless proper ventilation is provided or the manufacturer's instructions have been adhered to.

11. Power Sources

This product should be operated only from the type of power source indicated on the marking label. If you are not sure of the type of power supply to your home, consult your product dealer or local power company. For products intended to operate from battery power, or other sources, refer to the operating instructions.

12. Grounding or Polarization

This product is provided with one of the following types of plugs. If the plug should fail to fit into the power outlet, please contact your electrician.

Do not defeat the safety purpose of the plug.

- Two-wire type (mains) plug.
- Three-wire grounding type (mains) plug with a grounding terminal.
This plug will only fit into a grounding type power outlet.

13. Power-Cord Protection

Power-supply cords should be routed so that they are not likely to be walked on or pinched by items placed upon or against them, paying particular attention to cords at plugs, convenience receptacles, and the point where they exit from the product.

14. Lightning

For added protection for this product during a lightning storm, or when it is left unattended and unused for long periods of time, unplug it from the wall outlet and disconnect the cable system. This will prevent damage to the product due to lightning and power-line surges.

15. Overloading

Do not overload wall outlets, extension cords, or integral convenience receptacles as this can result in a risk of fire or electric shock.

16. Object and Liquid Entry

Never push objects of any kind into this product through openings as they may touch dangerous voltage points or short-out parts that could result in a fire or electric shock. Never spill liquid of any kind on the product.

17. Servicing

Do not attempt to service this product yourself as opening or removing covers may expose you to dangerous voltage or other hazards. Refer all servicing to qualified service personnel.

18. Damage Requiring Service

Unplug this product from the wall outlet and refer servicing to qualified service personnel under the following conditions:

- When the power-supply cord or plug is damaged.
- If liquid has been spilled, or objects have fallen into the product.
- If the product has been exposed to rain or water.
- If the product does not operate normally by following the operating instructions. Adjust only those controls that are covered by the operating instructions, as an improper adjustment of other controls may result in damage and will often require extensive work by a qualified technician to restore the product to normal operation.
- If the product has been dropped or damaged in any way.
- When the product exhibits a distinct change in performance, this indicates a need for service.

19. Replacement Parts

When replacement parts are required, be sure the service technician has used replacement parts specified by the manufacturer or have the same characteristics as the original part. Unauthorized substitutions may result in fire, electric shock, or other hazards.

20. Safety Check

Upon completion of any service or repairs to this product, ask the service technician to perform safety checks to determine that the product is in proper operating condition.

21. Wall or Ceiling Mounting

This product should be mounted to a wall or ceiling only as recommended by the manufacturer.

22. Heat

This product should be situated away from heat sources such as radiators, heat registers, stoves, or other products (including amplifiers) that produce heat.

Observe the following safeguards when setting up your projector.

Caution concerning the lamp unit

- Potential hazard of glass particles if lamp ruptures. In case of lamp rupture, contact your nearest Sharp Authorized Projector Dealer or Service Center for replacement. See "Regarding the Lamp" on page 50.

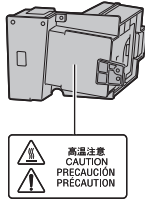

Caution concerning the setup of the projector

- For minimal servicing and to maintain high image quality, SHARP recommends that this projector be installed in an area free from humidity, dust and cigarette smoke. When the projector is subjected to these environments, the vents and lens must be cleaned more often. As long as the projector is regularly cleaned, use in these environments will not reduce the overall operation life of the unit. Internal cleaning should only be performed by a Sharp Authorized Projector Dealer or Service Center.

Do not set up the projector in places exposed to direct sunlight or bright light.

- Position the screen so that it is not in direct sunlight or room light. Light falling directly on the screen washes out the colors, making viewing difficult. Close the curtains and dim the lights when setting up the screen in a sunny or bright room.

Caution regarding placing of the projector

- Place the projector on a level site within the adjustment range (9 degrees) of the adjustment foot.

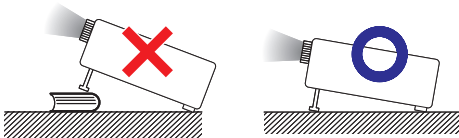

- After the projector is purchased, a faint smell from the vent may appear when the power is first turned on. This is normal and is not a malfunction. It will disappear after the projector is used for a while.

When using the projector in high-altitude areas such as mountains (at altitudes of approximately 4,900 feet (1,500 meters) or more)

- When you use the projector in high-altitude areas with thin air, set "Fan Mode" to "High". Neglecting this can affect the longevity of the optical system.

Warning about placing the projector in a high position

- When placing the projector in a high position, make certain it is carefully secure to avoid personal injury caused by the projector falling down.

Do not subject the projector to hard impact and/or vibration.

- Protect the lens so as not to hit or damage the surface of the lens.

Rest your eyes occasionally.

- Continuously watching the screen for long hours will cause eye strain. Take regular breaks to rest your eyes.

Avoid locations with extremes of temperature.

- The operating temperature of the projector is from 41°F to 95°F (+5°C to +35°C).
- The storage temperature of the projector is from -4°F to 140°F (-20°C to +60°C).

Do not block the exhaust and intake vents.

- Allow at least 11¹³/₁₆ inches (30 cm) of space between the exhaust vent and the nearest wall or obstruction.
- Ensure that the intake vent and the exhaust vent are not obstructed.
- If the cooling fan becomes obstructed, a protection circuit will automatically put the projector into standby mode to prevent overheat damage. This does not indicate a malfunction. (See page 48.) Remove the projector power cord from the wall outlet and wait at least 10 minutes. Place the projector where the intake and exhaust vents are not blocked, plug the power cord back in and turn on the projector. This will return the projector to the normal operating condition.

Caution regarding usage of the projector

- If you are not to use the projector for a long time or before moving the projector, make certain you unplug the power cord from the wall outlet, and disconnect any other cables connected to it.
- Do not carry the projector by holding the lens.
- When storing the projector, ensure that you close the lens shutter.
- Do not expose the projector to direct sunlight or place next to heat sources. Doing so may affect the cabinet color or cause deformation of the plastic cover.

Other connected equipment

- When connecting a computer or other audio-visual equipment to the projector, make the connections AFTER unplugging the power cord of the projector from the AC outlet and turning off the equipment to be connected.
- Please read the operation manuals of the projector and the equipment to be connected for instructions on how to make the connections.

Using the projector in other countries

- The power supply voltage and the shape of the plug may vary depending on the region or country you are using the projector in. When using the projector overseas, make sure you use an appropriate power cord for the country you are in.

Temperature monitor function



- If the temperature inside the projector increases, due to blockage of the air vents, or the setting location, the temperature warning indicator will blink. And if the temperature keeps on rising, "TEMP." will illuminate in the lower left corner of the picture with the temperature warning indicator blinking. If this state continues, the lamp will turn off, the cooling fan will run and then the projector will enter standby mode. Refer to "Maintenance Indicators" on pages 48 and 49 for details.



Info

- The cooling fan regulates the internal temperature, and its performance is automatically controlled. The sound of the fan may change during projector operation due to changes in the fan speed. This does not indicate malfunction.

- The DLP® logo and the DLP® medallion are registered trademarks of Texas Instruments.
- Microsoft® and Windows® are registered trademarks of Microsoft Corporation in the United States and/or other countries.
- PC/AT is a registered trademark of International Business Machines Corporation in the United States.
- Macintosh® is a registered trademark of Apple Computer, Inc. in the United States and/or other countries.
- HDMI, the HDMI logo and High-Definition Multimedia Interface are trademarks or registered trademarks of HDMI Licensing LLC.
- All other company or product names are trademarks or registered trademarks of their respective companies.
- Some IC chips in this product include confidential and/or trade secret property belonging to Texas Instruments. Therefore you may not copy, modify, adapt, translate, distribute, reverse engineer, reverse assemble or discompile the contents thereof.

Accessories

Supplied accessories

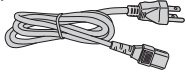
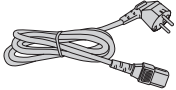
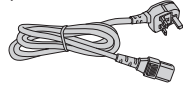
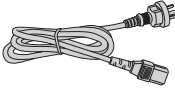
			
Remote control <RRMCGA757WJSA>	Two AA size batteries <UBATUA020WJZZ>	Operation manual	
Power cord*			
(1) 	(2) 	(3) 	(4) 
For U.S. and Canada, etc. (6' (1.8 m)) <QACCDAA007WJPZ>	For Europe, except U.K. (6' (1.8 m)) <QACCVAA011WJPZ>	For U.K. and Singapore (6' (1.8 m)) <QACCBA036WJPZ>	For Australia, New Zealand and Oceania (6' (1.8 m)) <QACCLA018WJPZ>
* Use the power cord that corresponds to the wall outlet in your country.			

Note

- Codes in “< >” are Replacement parts codes.

Optional accessories

- | | |
|--|-----------------------------|
| ■ Lamp unit | AN-K15LP |
| ■ Ceiling-mount adaptor | AN-60KT |
| ■ Ceiling-mount unit | AN-XGCM55 (for U.S.A. only) |
| | AN-TK201 <for AN-60KT> |
| | AN-TK202 <for AN-60KT> |
| | AN-EP101B <for AN-XGCM55> |
| | (for U.S.A. only) |
| ■ 3 RCA to mini D-sub 15 pin cable (10' (3.0 m)) | AN-C3CP2 |

Note

- Some of the optional accessories may not be available depending on the region. Please check with your nearest Sharp Authorized Projector Dealer or Service Center.

Part Names and Functions

Numbers in **■** refer to the main pages in this operation manual where the topic is explained.

Projector

Top View

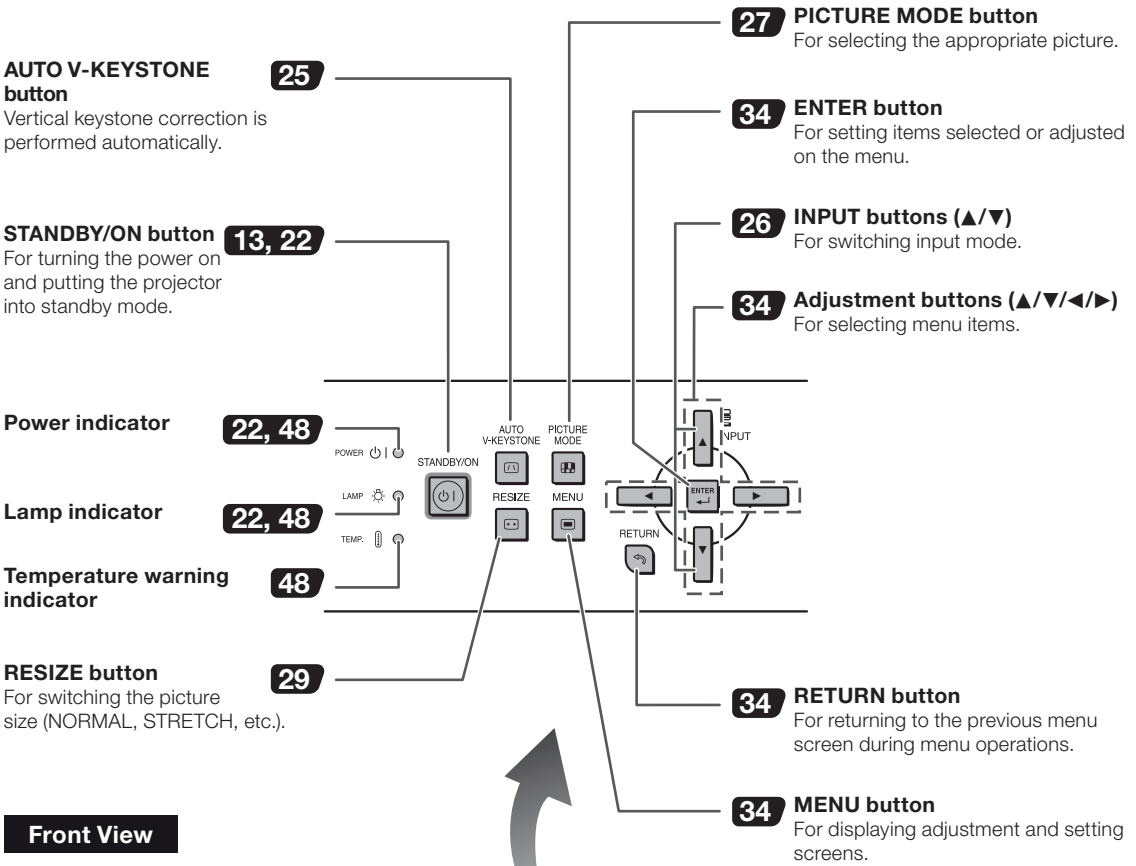

Front View

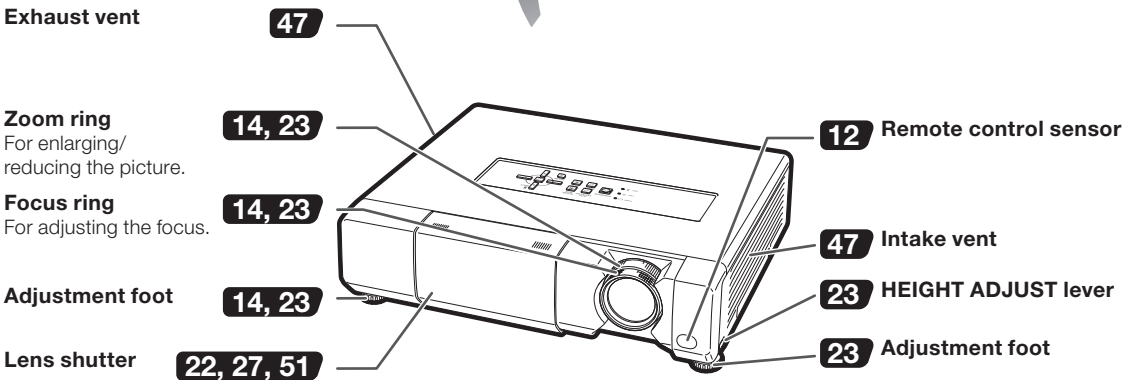

Part Names and Functions (Continued)

Projector (Rear View)

Terminals

COMPONENT terminals

Terminal for connecting video equipment with component output terminal.

RS-232C terminal

Terminal for controlling the projector using a computer.

COMPUTER/COMPONENT input terminal

Terminal for computer RGB and component signals.

Remote control sensor

Carrying handle

For carrying the projector.

HDMI1, 2 terminals

Terminal for connecting video equipment with HDMI output terminal.

S-VIDEO input terminal

Terminal for connecting video equipment with an S-video terminal.

VIDEO input terminal

Terminal for connecting video equipment.

Security bar Kensington Security Standard connector

AC socket

Connect the supplied power cord.

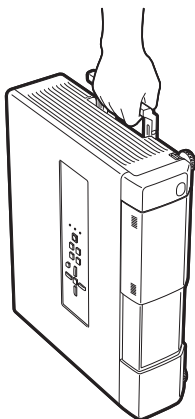
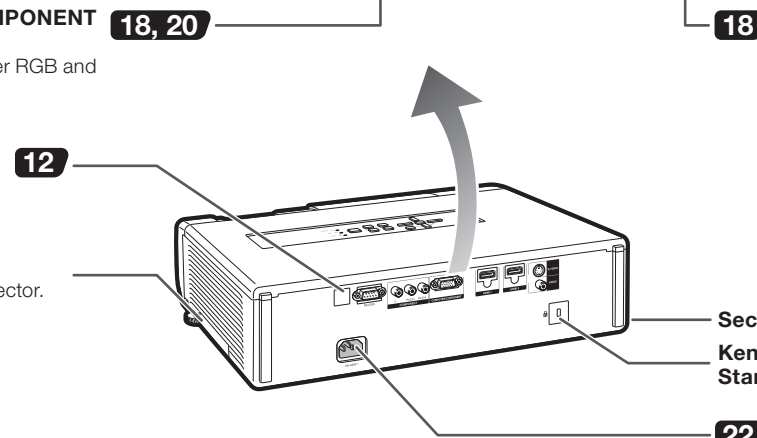
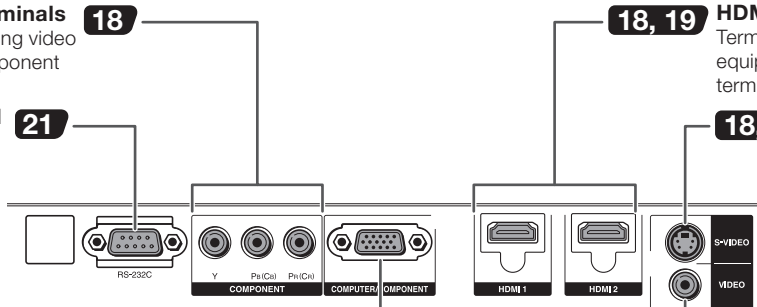

Using the Carrying Handle

When transporting the projector, carry it by the carrying handle on the side.

- Always close the lens shutter to prevent damage to the lens when transporting the projector.
- Do not lift or carry the projector by the lens as this may damage the lens.

Using the Kensington Lock

- This projector has a Kensington Security Standard connector for use with a Kensington MicroSaver Security System. Refer to the information that came with the system for instructions on how to use it to secure the projector.

Numbers in **■** refer to the main pages in this operation manual where the topic is explained.

Remote Control

STANDBY button

For putting the projector into the standby mode.

HDMI1, 2, COMPONENT, S-VIDEO, VIDEO, COMPUTER buttons

For switching to the respective input modes.

FREEZE button

For freezing images.

MAGNIFY buttons

For enlarging/reducing part of the image.

KEystone button

For entering the Keystone mode.

Adjustment buttons (▲/▼/◀/▶)

For selecting and adjusting menu items.

RETURN button

For returning to the previous menu screen during menu operations.

INPUT button

For switching input mode.

MENU HIDE button

For temporarily hiding menu screen.

14, 22

14, 26

27

28

24

34

34

26

28

13, 22

27

27

28

26

34

34

29

28

ON button

For turning the power on.

AUTO SYNC button

For automatically adjusting images when connected to a computer.

PICTURE MODE button

For selecting the appropriate picture.

IRIS 1, 2 buttons

For switching "High Brightness" and "High Contrast".

IMAGE SHIFT button

For shifting images horizontally and vertically.

ENTER button

For setting items selected or adjusted on the menu.

MENU button

For displaying adjustment and setting screens.

RESIZE button

For switching the picture size (NORMAL, STRETCH, etc.).

ECO+QUIET button

For lowering the noise of the cooling fan and extending the lamp life.

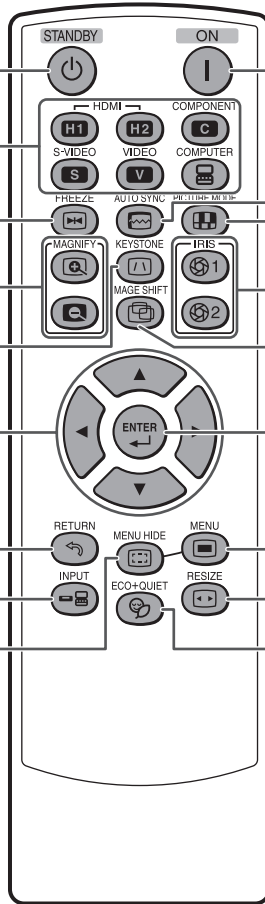

Using the Remote Control

Inserting the Batteries

1 Pull down the tab on the cover and remove the cover towards the direction of the arrow.

2 Insert the supplied batteries and put back the cover.

- Make sure the polarities correctly match the \oplus and \ominus marks inside the battery compartment.
- When putting back the cover, be sure that the cover clicks in place and settles.

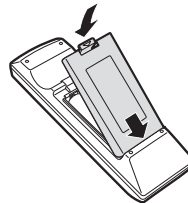
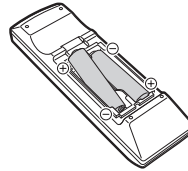
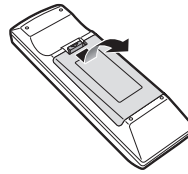

Usable Range

The remote control can be used to control the projector within the ranges shown in the illustration.

Note

- Remote control sensor is located on both the front and rear of the projector.
- The signal from the remote control can be reflected off a screen for easy operation. However, the effective distance of the signal may differ depending on the screen material.

When using the remote control:

- Be sure not to drop, expose to moisture or high temperature.
- The remote control may malfunction under a fluorescent lamp. In this case, move the projector away from the fluorescent lamp.

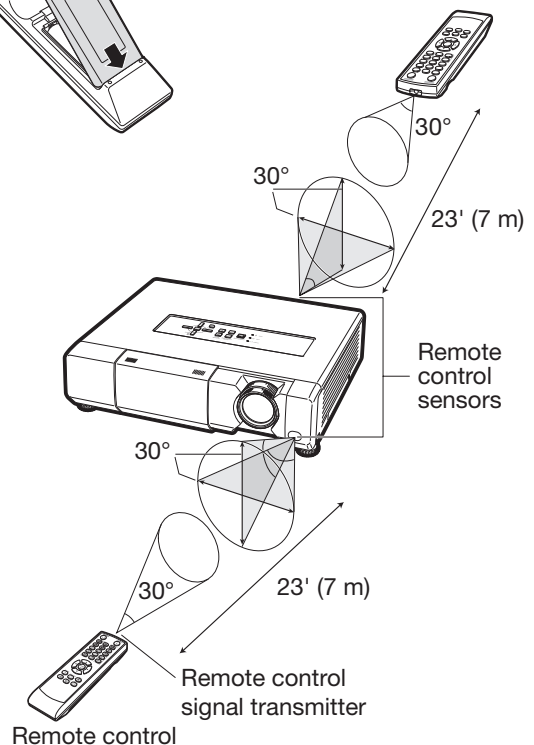

Incorrect use of the batteries may cause them to leak or explode. Please follow the precautions below

Caution

- Danger of explosion if battery is incorrectly replaced. Replace only with alkaline or manganese batteries.
- Insert the batteries making sure the polarities correctly match the \oplus and \ominus marks inside the battery compartment.
- Batteries of different types have different properties, therefore do not mix batteries of different types.
- Do not mix new and old batteries. This may shorten the life of new batteries or may cause old batteries to leak.
- Remove the batteries from the remote control once they have run out, as leaving them in can cause them to leak. Battery fluid from leaked batteries is harmful to skin, therefore ensure you wipe them first and then remove them using a cloth.
- The batteries included with this projector may run down in a short period, depending on how they are kept. Be sure to replace them as soon as possible with new batteries.
- Remove the batteries from the remote control if you will not be using the remote control for a long time.
- Comply with the rules (ordinance) of each local government when disposing of worn-out batteries.

Quick Start

This section provides an example showing how to connect the projector to video equipment that has an HDMI output terminal with a brief explanation of the steps from connection through to image projection. For details, see the pages suggested in each step.

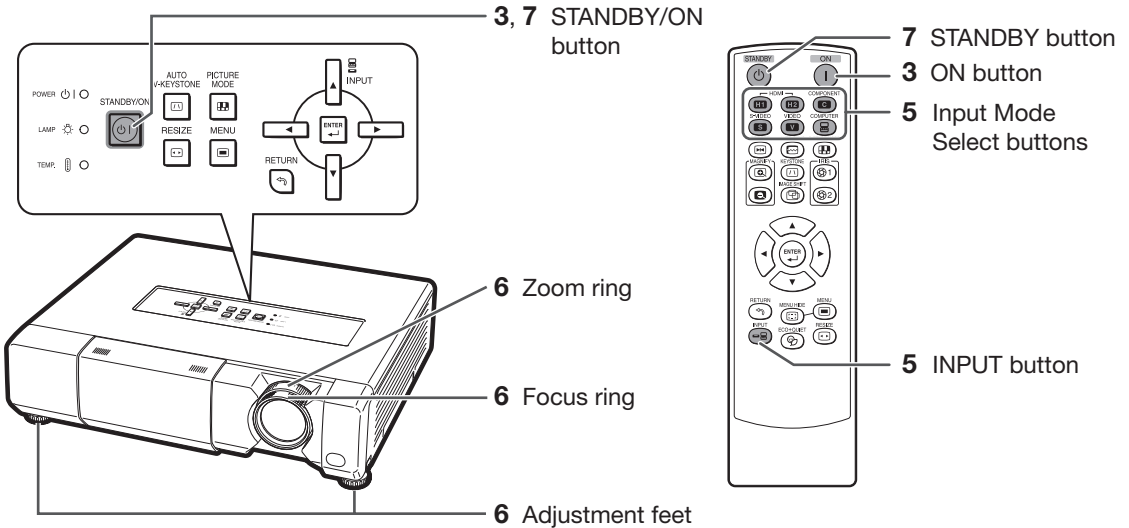

1. Place the projector facing a screen

→ Page 15

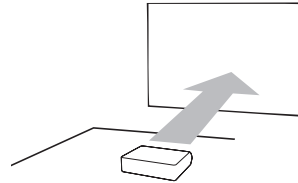

2. Connect the projector to the video equipment and plug the power cord into the AC socket of the projector

→ Pages 18-22

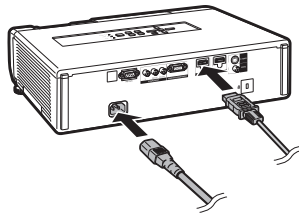

3. Open the lens shutter fully and then turn the projector on

→ Page 22

On the projector

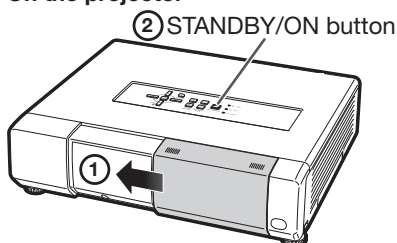

Press **STANDBY/ON** on the projector or **ON** on the remote control pointing the remote control towards the projector.

On the remote control

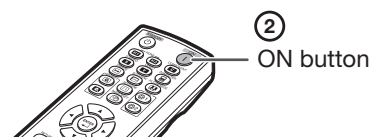

Quick Start (Continued)

4. Turn the video equipment on and start playback

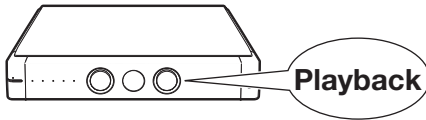

5. Select the input mode

→ Page 26

Press **HDMI1** on the remote control to select "HDMI1" for the Input mode.



HDMI1
Component
1080P

- Press **HDMI1**, **HDMI2**, **COMPONENT**, **S-VIDEO**, **VIDEO** and **COMPUTER** on the remote control to switch the Input mode.
- Press **▲** or **▼** to select your desired input mode when you press **INPUT** on the remote control or on the projector.

6. Adjust the projector angle, focus and zoom

→ Page 23

1. The focus is adjusted by rotating the focus ring.

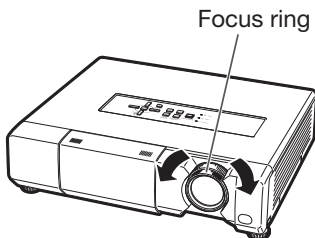

2. Zooming is adjusted by rotating the zoom ring.

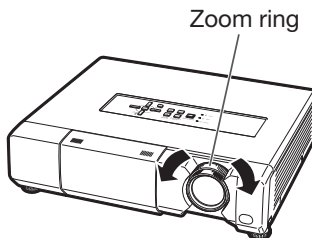

3. The projector angle is adjusted by using the adjustment feet.

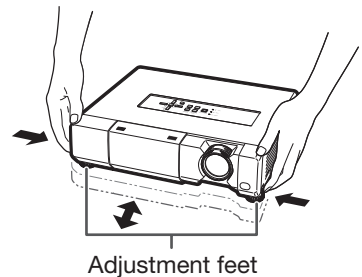

- When the image is distorted trapezoidally, the keystone correction is needed. (See page 24.)

7. Turn the power off

→ Page 22

Press **STANDBY/ON** on the projector or **STANDBY** on the remote control, then press that button again while the confirmation message is displayed, to put the projector into standby mode.

On the projector

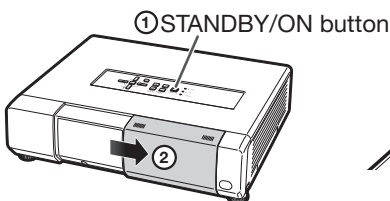

On the remote control



On-screen display

⏻ Enter STANDBY mode?
Yes : Press Again
No : Please Wait

Setting Up the Projector

Setting Up the Projector

For optimal image quality, position the projector perpendicular to the screen with the projector's feet flat and level.

Note

- The projector lens should be centered in the middle of the screen. If the horizontal line passing through the lens center is not perpendicular to the screen, the image will be distorted, making viewing difficult.
- For optimal image, position the screen so that it is not in direct sunlight or room light. Light falling directly on the screen washes out the colors, making viewing difficult. Close the curtains and dim the lights when setting up the screen in a sunny or bright room.
- A polarizing screen cannot be used with this projector.

Standard Setup (Front Projection)

- Place the projector at the required distance from the screen according to the desired picture size.

Example of standard setup

Side View

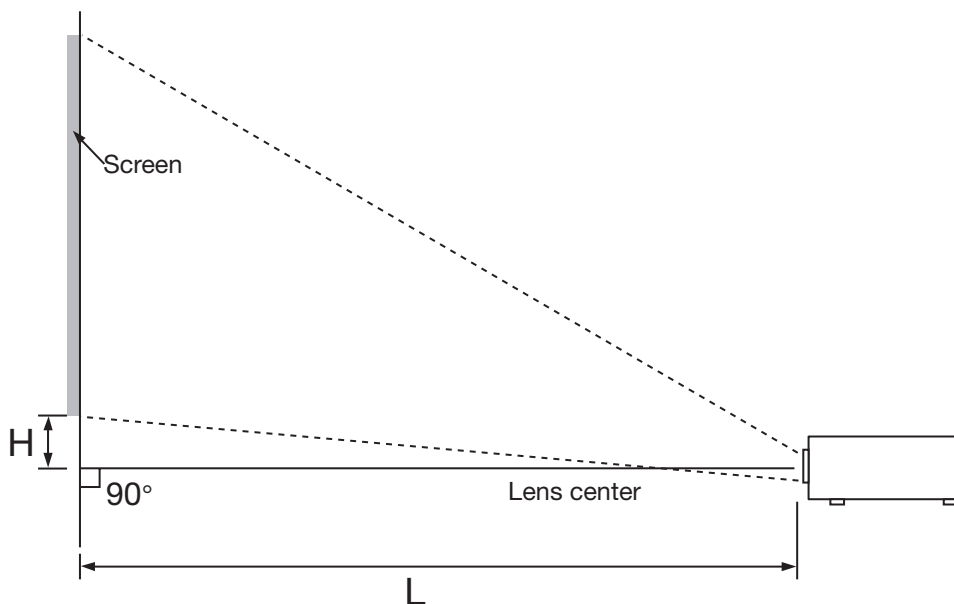

Note

- Refer to page 17 for additional information concerning "Screen Size and Projection Distance".

Setting Up the Projector (Continued)

Projection (PRJ) Mode

The projector can use any of the 4 projection modes, shown in the diagram below. Select the mode most appropriate for the projection setting in use. (You can set the PRJ Mode in "SCR-ADJ" menu. See page 44.)

■ Table mounted, front projection

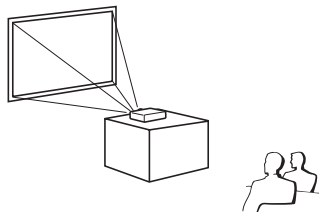

Menu item → "Front"

■ Ceiling mounted, front projection

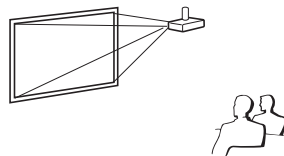

Menu item → "Ceiling + Front"

■ Table mounted, rear projection
(with a translucent screen)

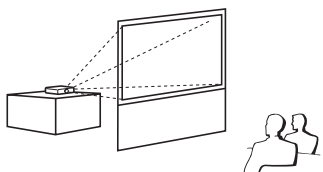

Menu item → "Rear"

■ Ceiling mounted, rear projection
(with a translucent screen)

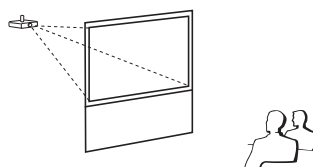

Menu item → "Ceiling + Rear"

Ceiling-mount Setup

■ It is recommended that you use the optional Sharp ceiling-mount adaptor and unit for this installation. Before mounting the projector, contact your nearest Sharp Authorized Projector Dealer or Service Center to obtain the recommended ceiling-mount adaptor and unit (sold separately).

Indication of the Projection Image Size and Projection Distance

For details, refer to "Screen Size and Projection Distance" on page 17.

Example : When using a wide screen (16:9)

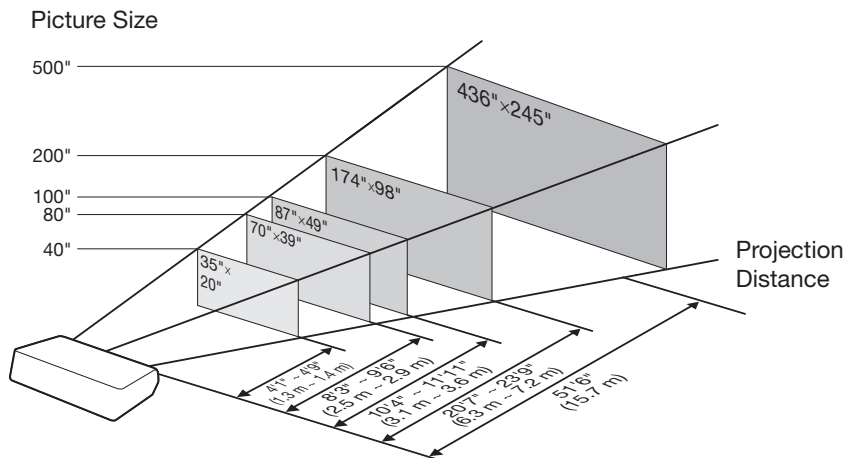

Screen Size and Projection Distance

When using a wide screen (16:9): In case of displaying the 16:9 picture on the whole of the 16:9 screen.

Diag. (x)	Picture (Screen) size		Projection distance [L]		Distance from the lens center to the bottom of the image [H]
	Width	Height	Minimum [L1]	Maximum [L2]	
500" (1270 cm)	436" (1107 cm)	245" (623 cm)	51'6" (15.7 m)	—	39 3/8" (100 cm)
400" (1016 cm)	349" (886 cm)	196" (498 cm)	41'2" (12.6 m)	47'6" (14.5 m)	31 1/2" (80 cm)
300" (762 cm)	261" (664 cm)	147" (374 cm)	30'11" (9.4 m)	35'8" (10.9 m)	23 5/8" (60 cm)
250" (635 cm)	218" (553 cm)	123" (311 cm)	25'9" (7.9 m)	29'8" (9.1 m)	19 11/16" (50 cm)
200" (508 cm)	174" (443 cm)	98" (249 cm)	20'7" (6.3 m)	23'9" (7.2 m)	15 3/4" (40 cm)
150" (381 cm)	131" (332 cm)	74" (187 cm)	15'5" (4.7 m)	17'10" (5.4 m)	11 13/16" (30 cm)
120" (305 cm)	105" (266 cm)	59" (149 cm)	12'4" (3.8 m)	14'3" (4.3 m)	9 29/64" (24 cm)
100" (254 cm)	87" (221 cm)	49" (125 cm)	10'4" (3.1 m)	11'11" (3.6 m)	7 7/8" (20 cm)
80" (203 cm)	70" (177 cm)	39" (100 cm)	8'3" (2.5 m)	9'6" (2.9 m)	6 19/64" (16 cm)
60" (152 cm)	52" (133 cm)	29" (75 cm)	6'2" (1.9 m)	7'2" (2.2 m)	4 23/32" (12 cm)
40" (102 cm)	35" (89 cm)	20" (50 cm)	4'1" (1.3 m)	4'9" (1.4 m)	3 5/32" (8 cm)

x : Picture size (diag.) (in/cm)

L : Projection distance (ft/m)

L1: Minimum projection distance (ft/m)

L2: Maximum projection distance (ft/m)

H : Distance from the lens center to the bottom of the image (in/cm)

The formula for picture size and projection distance

[Feet/inches]

L1(ft) = 0.0314 x / 0.3048

L2(ft) = 0.0362 x / 0.3048

H (in) = 0.2 x / 2.54

[m/cm]

L1(m) = 0.0314 x

L2(m) = 0.0362 x

H (cm) = 0.2 x

When using a normal screen (4:3) and projecting 4:3 image (NORMAL Mode)

Diag. (x)	Picture (Screen) size		Projection distance [L]		Distance from the lens center to the bottom of the image [H]
	Width	Height	Minimum [L1]	Maximum [L2]	
400" (1016 cm)	320" (813 cm)	240" (610 cm)	50'5" (15.4 m)	—	38 35/64" (98 cm)
300" (762 cm)	240" (610 cm)	180" (457 cm)	37'10" (11.5 m)	43'7" (13.3 m)	28 29/32" (73 cm)
250" (635 cm)	200" (508 cm)	150" (381 cm)	31'6" (9.6 m)	36'4" (11.1 m)	24 3/32" (61 cm)
200" (508 cm)	160" (406 cm)	120" (305 cm)	25'3" (7.7 m)	29'1" (8.9 m)	19 17/64" (49 cm)
150" (381 cm)	120" (305 cm)	90" (229 cm)	18'11" (5.8 m)	21'10" (6.6 m)	14 29/64" (37 cm)
120" (305 cm)	96" (244 cm)	72" (183 cm)	15'2" (4.6 m)	17'5" (5.3 m)	11 9/16" (29 cm)
100" (254 cm)	80" (203 cm)	60" (152 cm)	12'7" (3.8 m)	14'6" (4.4 m)	9 41/64" (24 cm)
80" (203 cm)	64" (163 cm)	48" (122 cm)	10'1" (3.1 m)	11'8" (3.5 m)	7 45/64" (20 cm)
70" (178 cm)	56" (142 cm)	42" (107 cm)	8'10" (2.7 m)	10'2" (3.1 m)	6 3/4" (17 cm)
60" (152 cm)	48" (122 cm)	36" (91 cm)	7'7" (2.3 m)	8'9" (2.7 m)	5 25/64" (15 cm)
40" (102 cm)	32" (81 cm)	24" (61 cm)	5'1" (1.5 m)	5'10" (1.8 m)	3 55/64" (10 cm)

x : Picture size (diag.) (in/cm)

L : Projection distance (ft/m)

L1: Minimum projection distance (ft/m)

L2: Maximum projection distance (ft/m)

H : Distance from the lens center to the bottom of the image (in/cm)

The formula for picture size and projection distance

[Feet/inches]

L1(ft) = 0.03843 x / 0.3048

L2(ft) = 0.0443 x / 0.3048

H (in) = 0.24477 x / 2.54

[m/cm]

L1(m) = 0.03843 x

L2(m) = 0.0443 x

H (cm) = 0.24477 x

When using a normal screen (4:3): In case of setting the 16:9 picture to the full horizontal width of the 4:3 screen.

Diag. (x)	Picture (Screen) size		Projection distance [L]		Distance from the lens center to the bottom of the image [H]
	Width	Height	Minimum [L1]	Maximum [L2]	
500" (1270 cm)	400" (1016 cm)	300" (762 cm)	47'3" (14.4 m)	—	36 9/64" (92 cm)
400" (1016 cm)	320" (813 cm)	240" (610 cm)	37'10" (11.5 m)	43'7" (13.3 m)	28 29/32" (73 cm)
300" (762 cm)	240" (610 cm)	180" (457 cm)	28'4" (8.6 m)	32'8" (10.0 m)	21 11/16" (55 cm)
250" (635 cm)	200" (508 cm)	150" (381 cm)	23'8" (7.2 m)	27'3" (8.3 m)	18 1/16" (46 cm)
200" (508 cm)	160" (406 cm)	120" (305 cm)	18'11" (5.8 m)	21'10" (6.6 m)	14 29/64" (37 cm)
150" (381 cm)	120" (305 cm)	90" (229 cm)	14'2" (4.3 m)	16'4" (5.0 m)	10 27/32" (28 cm)
120" (305 cm)	96" (244 cm)	72" (183 cm)	11'4" (3.5 m)	13'1" (4.0 m)	8 43/64" (22 cm)
100" (254 cm)	80" (203 cm)	60" (152 cm)	9'5" (2.9 m)	10'11" (3.3 m)	7 15/64" (18 cm)
80" (203 cm)	64" (163 cm)	48" (122 cm)	7'7" (2.3 m)	8'9" (2.7 m)	5 25/32" (15 cm)
70" (178 cm)	56" (142 cm)	42" (107 cm)	6'7" (2.0 m)	7'8" (2.3 m)	5 1/16" (13 cm)
60" (152 cm)	48" (122 cm)	36" (91 cm)	5'8" (1.7 m)	6'6" (2.0 m)	4 11/32" (11 cm)
40" (102 cm)	35" (81 cm)	24" (61 cm)	3'9" (1.2 m)	4'4" (1.3 m)	2 57/64" (7 cm)

x : Picture size (diag.) (in/cm)

L : Projection distance (ft/m)

L1: Minimum projection distance (ft/m)

L2: Maximum projection distance (ft/m)

H : Distance from the lens center to the bottom of the image (in/cm)

The formula for picture size and projection distance

[Feet/inches]

L1(ft) = 0.02882 x / 0.3048

L2(ft) = 0.03323 x / 0.3048

H (in) = 0.18358 x / 2.54

[m/cm]

L1(m) = 0.02882 x

L2(m) = 0.03323 x













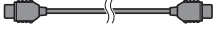
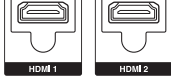

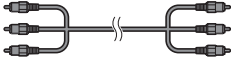
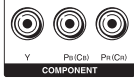
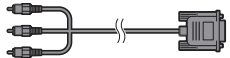

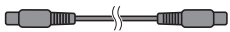

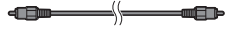

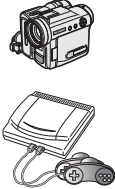
H (cm) = 0.18358 x

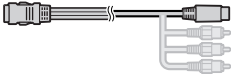

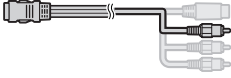
- Refer to page 15 concerning "Projection distance [L]" and "Distance from the lens center to the bottom of the image [H]".
- Allow a margin of error in the value in the diagrams above.

Samples of Cables for Connection

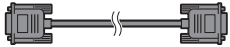
- For more details of connection and cables, refer to the operation manual of the connecting equipment.
- You may need other cables or connectors not listed below.

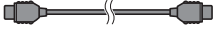
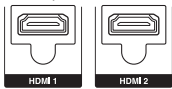
Equipment	Terminal on connected equipment	Cable	Terminal on the projector
Video equipment 	HDMI output terminal 	HDMI cable (commercially available) 	HDMI1, 2  (→ Page 19)
	Component video output terminal 	Component cable (commercially available) 	COMPONENT 
		3 RCA to mini D-sub 15 pin cable (optional, AN-C3CP2) 	COMPUTER/COMPONENT 
	S-video output terminal 	S-video cable (commercially available) 	S-VIDEO  (→ Page 19)
	Video output terminal 	Video cable (commercially available) 	VIDEO 
Camera/Video game 	Component video output terminal	Cables for a camera or a video game/3 RCA to mini D-sub 15 pin cable (optional, AN-C3CP2)  RCA adaptor plug (commercially available)	COMPUTER/COMPONENT 
	S-video output terminal	Cables for a camera or a video game 	S-VIDEO 
	Video output terminal	Cables for a camera or a video game 	VIDEO 
Computer 	RGB output terminal 	RGB cable (commercially available) 	COMPUTER/COMPONENT  (→ Page 20)
	HDMI output terminal 	HDMI cable (commercially available) 	HDMI1, 2 

Connecting to Video Equipment

Before connecting, be sure to unplug the power cord of the projector from the AC outlet and turn off the devices to be connected. After making all connections, turn on the projector and then the other devices.

Connecting Equipment with HDMI Output Terminal to the HDMI Terminal on the Projector

HDMI is a new specialized interface capable of delivering a video and audio signal to the terminal using just one cable. Since this projector does not support an audio signal by itself, use an amplifier or other audio device. For video connection, use a cable that conforms to HDMI standards. Using cables that do not conform to HDMI standards may result in a malfunction.

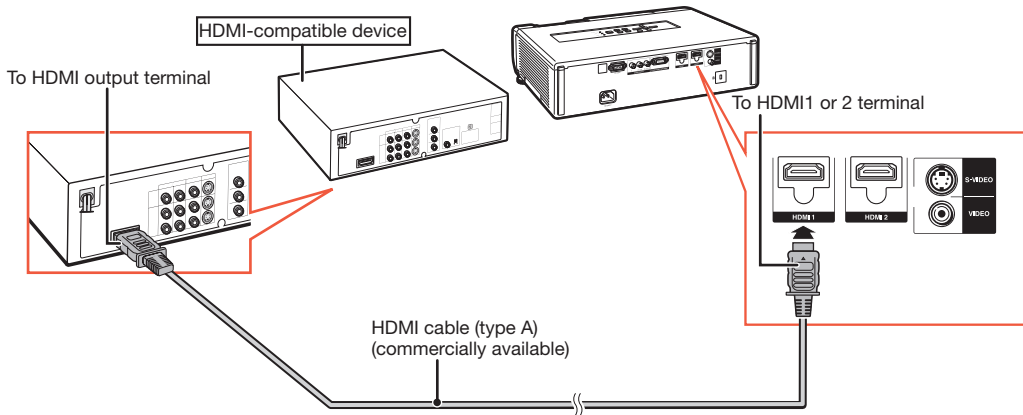

Note

- HDMI (High-Definition Multimedia Interface) is a digital AV interface that can deliver a high-definition video signal, multi-channel audio signal, and bi-directional control signal all in just one cable.
- Because it is compatible with the HDCP (High-bandwidth Digital Content Protection) system, the digital video signal does not degrade when transmitted, and a high-quality image with a simple connection can be enjoyed.

Connecting to Equipment with S-video Output Terminal

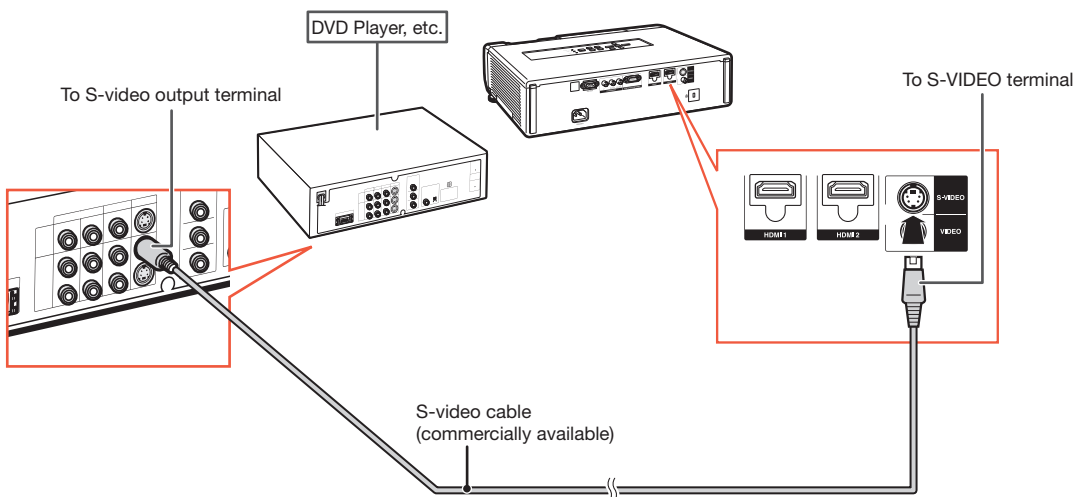

Refer to "Samples of Cables for Connection" on page 18 for connecting other equipment.

Connecting to a Computer

Ensure that the computer is the last device to be turned on after all the connections are made.

Connecting to a Computer Using the RGB Cable

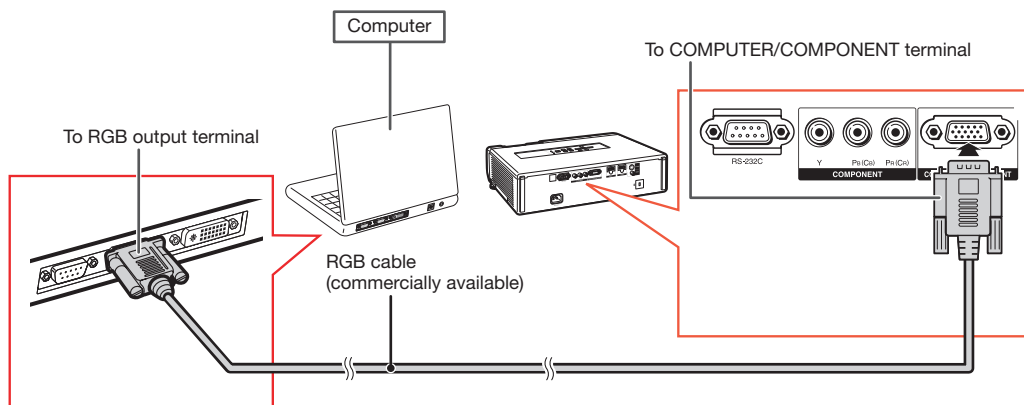

Note

- Refer to “Computer Compatibility Chart” on page 57 for a list of computer signals compatible with the projector. Use with computer signals other than those listed may cause some of the functions not to work.
- A Macintosh adaptor may be required for use with some Macintosh computers. Contact your nearest Macintosh Dealer.
- Depending on the computer you are using, an image may not be projected unless the computer’s external output port is switched on. (e.g. Press “Fn” and “F5” keys simultaneously when using a SHARP notebook computer). Refer to the specific instructions in your computer’s operation manual to enable your computer’s external output port.

Turning the Projector On/Off

Connecting the Power Cord

Plug the supplied power cord into the AC socket on the rear of the projector.

- The power indicator illuminates red, and the projector enters standby mode.

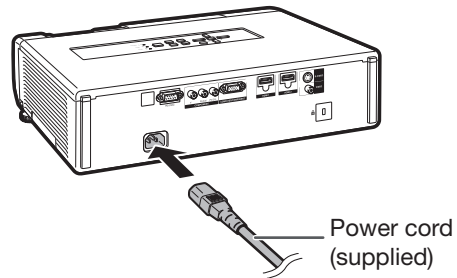

Turning the Projector On

Note that the connections to external equipment and power outlet should be done before performing the operations written below. (See pages 19 to 22.)

Open the lens shutter fully and press **STANDBY/ON** on the projector or **ON** on the remote control.

- The power indicator illuminates green.
- After the lamp indicator illuminates, the projector is ready to start operation.
- When the lens shutter is closed, the power indicator blinks alternately green and orange and the projector does not turn on.

Note

• About the Lamp Indicator

The lamp indicator illuminates to indicate the status of the lamp.

Green: The lamp is on.

Blinking in green: The lamp is warming up.

Red: The lamp is shut down abnormally or the lamp should be replaced.

- When switching on the projector, a slight flickering of the image may be experienced within the first minute after the lamp has been illuminated. This is normal operation as the lamp's control circuitry is stabilising the lamp output characteristics. It should not be regarded as faulty operation.
- If the projector is put into standby mode and immediately turned on again, the lamp may take some time to start projection.

Info

- English is the factory default language. If you want to change the on-screen display to another language, change the language according to the procedure on page 44.

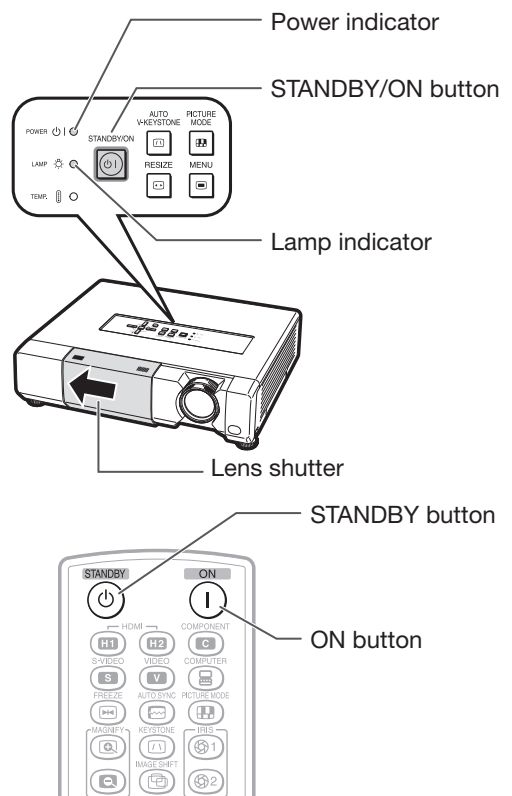

On-screen display

Enter STANDBY mode?
Yes : Press Again
No : Please Wait

Info

• Direct Power Off function:

- You can unplug the power cord from the AC outlet even if the cooling fan is still running.

Turning the Power Off (Putting the Projector into Standby Mode)

Press **STANDBY/ON** on the projector or **STANDBY** on the remote control, then press that button again while the confirmation message is displayed, to put the projector into standby mode.

- The projector cannot be turned on while cooling.

Image Projection

Adjusting the Projected Image

1 Adjusting the Focus

You can adjust the focus with the focus ring on the projector.

Rotate the focus ring to adjust the focus while watching the projected image.

2 Adjusting the Picture Size

You can adjust the picture size using the zoom ring on the projector.

Rotate the zoom ring to enlarge or shrink the picture size.

3 Adjusting the Height

The height of the projector can be adjusted using the adjustment feet.

When the screen is above the projector, the projection image can be made higher by adjusting the projector.

1 Lift the projector to adjust its height while lifting the HEIGHT ADJUST lever.

2 Remove your hands from the HEIGHT ADJUST lever of the projector after its height has been finely adjusted.

- The angle of projection is adjustable up to 9 degrees from the surface on which the projector is placed.

Note

- When adjusting the height of the projector, trapezoidal distortion occurs. Follow the procedures in Keystone Correction to correct the distortion. (See pages 24 and 43.)

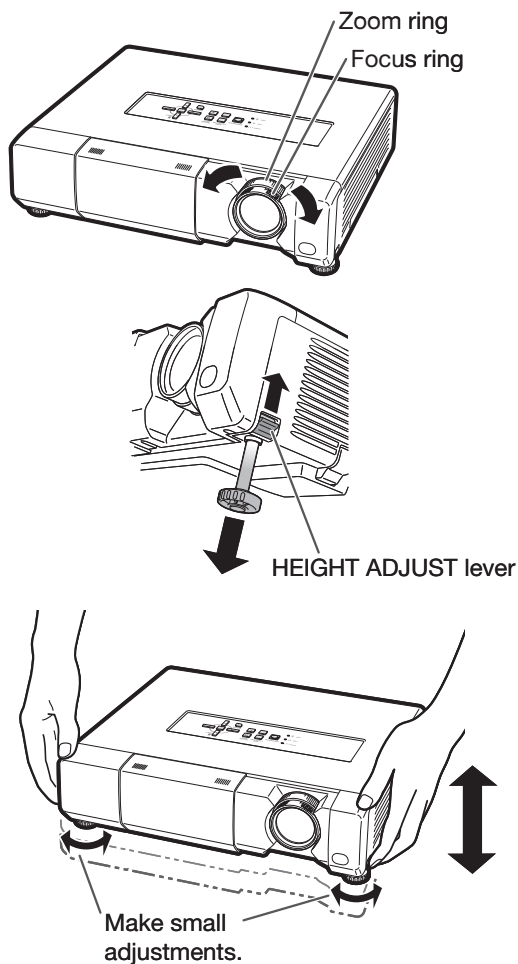

Info

- Do not apply too much pressure on the projector when the front adjustment feet come out.
- When lowering the projector, be careful not to get your fingers caught in the area between the adjustment feet and the projector.
- Hold the projector firmly while lifting or carrying.
- Do not hold by the lens area.

Image Projection (Continued)

Keystone Correction

This function can correct distortion of an image projected toward a spherical or cylindrical screen as well as trapezoidal distortion of an image on a flat screen and rotate the image at your arbitrary angle.

■ Keystone

When the image is projected either from the top or from the bottom towards the screen at an angle, the image becomes distorted trapezoidally. The function for correcting trapezoidal distortion is called Keystone Correction.

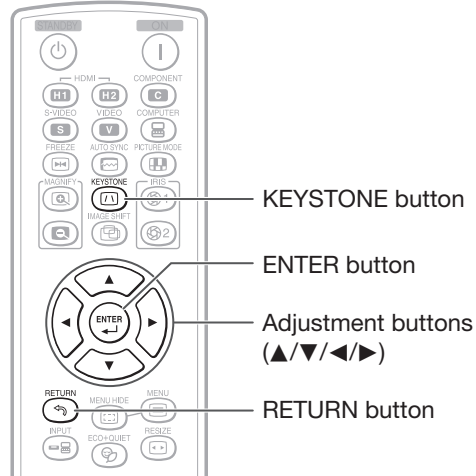

Note

- The Keystone Correction can be adjusted up to an angle of approximately ± 12 degrees with "Auto V-Keystone" and up to an angle of approximately ± 40 degrees with "V-Keystone" and approximately ± 30 degrees with "H-Keystone".

◀, ▶ button	For horizontal keystone correction
▲, ▼ button	For vertical keystone correction

1 Press **KEYSTONE** to enter the keystone mode.

- The keystone mode list appears.

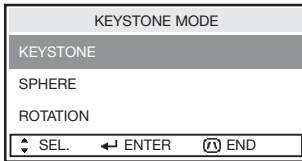

2 Press ▲/▼ to select "KEYSTONE", and then press **ENTER**.

- The keystone menu guide appears.



Selectable buttons	Description
END→KEYSTONE	Exits the keystone mode.
ADJUST→▲/▼/◀/▶	Adjusts the keystone correction.
TESTPATTERN →ENTER	Displays the testpattern.
RESET→RETURN	Returns to a default setting.

3 Press ▲/▼/◀/▶ to adjust the Keystone Correction.

Keystone Correction

H-Keystone Correction:



V-Keystone Correction:

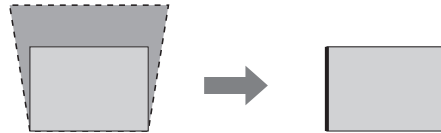

Note

- To return to the default setting, press **RETURN** while the on-screen display of the Keystone mode is on the screen.

Info

- While adjusting the image using Keystone/Sphere/Rotation Correction, straight lines and the edges of the image may appear jagged.

4 Press **KEYSTONE**.

- The on-screen display of the Keystone mode will disappear.

■ Sphere

This function can correct distortion of an image projected toward a spherical or cylindrical screen.

1 Press **KEYSTONE** to enter the keystone mode.

- The keystone mode list appears. (See page 24.)

2 Press **▲/▼** to select “**SPHERE**”, and then press **ENTER**.

- The sphere menu guide appears.

Selectable items	Description
RETURN	Returns to the keystone mode list.
ADJUST	Adjusts the sphere correction.
TESTPATTERN	Displays the testpattern.
RESET	Returns to a default setting.

3 Press **▲/▼/◀/▶** to adjust the Sphere Correction mode.

▲, ▶ button	For correction of concave distortion
▼, ◀ button	For correction of convex distortion

Sphere Correction

Correction of Concave Distortion:



Correction of Convex Distortion:

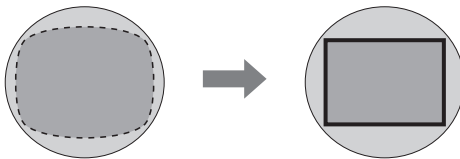

Note

- To return to the default setting, press **RETURN** while the on-screen display of the Keystone mode is on the screen.

4 Press **KEYSTONE**.

- The on-screen display of the Sphere Correction mode will disappear.

■ Rotation

This function rotates the image at an arbitrary angle.

1 Press **KEYSTONE** to enter the keystone mode.

- The keystone mode list appears. (See page 24.)

2 Press **▲/▼** to select “**ROTATION**”, and then press **ENTER**.

- The rotation menu guide appears.

Selectable items	Description
RETURN	Returns to the keystone mode list.
ADJUST	Adjusts the rotation correction.
TESTPATTERN	Displays the testpattern.
RESET	Returns to a default setting.

3 Press **▲/▼/◀/▶** to adjust the Rotation Correction mode.

▲, ▶ button	Rotates the image clockwise.
▼, ◀ button	Rotates the image counterclockwise.

Rotation Correction

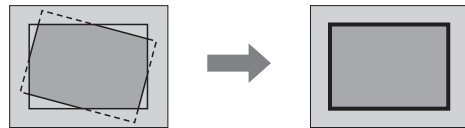

Note

- To return to the default setting, press **RETURN** while the on-screen display of the Keystone mode is on the screen.

4 Press **KEYSTONE**.

- The on-screen display of the Rotation Correction mode will disappear.

Auto V-Keystone Correction

This function can perform vertical keystone correction automatically.

Press **AUTO V-KEYSTONE** on the projector to perform vertical keystone correction which is automatically activated in response to the installation angle of the projector.

- The on-screen display of the Auto V-Keystone “On” appears when **AUTO V-KEYSTONE** is pressed once.
- Pressing **AUTO V-KEYSTONE** again after the on-screen display of the Auto V-Keystone “On” has appeared changes the on-screen display of the Auto V-Keystone “On” to the on-screen display of the Auto V-Keystone “Off” and the setting of the Auto V-Keystone to “0”.
- Pressing **AUTO V-KEYSTONE** while adjusting the image using Sphere/Rotation Correction changes Sphere/Rotation Correction mode to Keystone mode.

AUTO V-KEYSTONE button

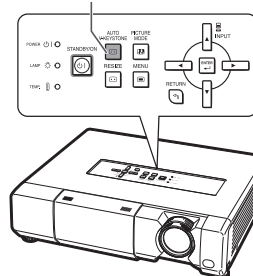

Image Projection (Continued)

Switching the Input Mode

Select the appropriate input mode for the connected equipment.

Press **HDMI1, 2, COMPONENT, S-VIDEO, VIDEO** or **COMPUTER** on the remote control to select the input mode.

- When you press **INPUT** on the projector or on the remote control, the INPUT list appears.
- Press **▲/▼** to switch the INPUT mode.

INPUT list

INPUT
HDMI1
HDMI2
COMPONENT
COMPUTER
S-VIDEO
VIDEO

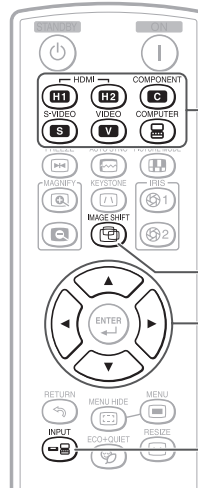

Adjusting the Vertical and Horizontal Position of the Image

1 Press **IMAGE SHIFT** to enter the image shift mode.

- The image shift menu guide appears.

IMAGE SHIFT	H: 0	V: 0
END	↕ ADJUST	
	↶ RESET	

Selectable buttons	Description
END → IMAGE SHIFT	Exits the image shift mode.
ADJUST → ▲/▼/◀/▶	Adjusts the image shift.
RESET → RETURN	Returns to a default setting.

2 Press **▲/▼/◀/▶** to adjust the vertical and horizontal position of the image.

H-Image Shift

Selectable items	◀ button	▶ button
H-Image Shift	Leftward	Rightward

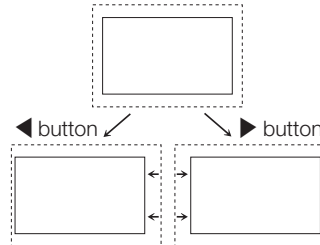

V-Image Shift

Selectable items	▼ button	▲ button
V-Image Shift	Downward	Upward

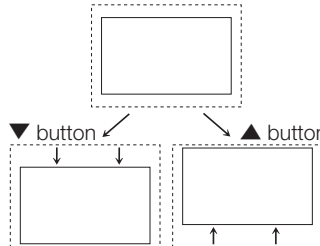

Note

- To return to the default setting, press **RETURN** when the image shift menu guide is still on the screen.
- Depending on the Resize mode, Picture mode or the input signal resolution, the range of the image shift may be limited.

Image Projection (Continued)

Displaying an Enlarged Portion of an Image

Graphs, tables and other portions of projected images can be enlarged. This is helpful when providing more detailed explanations.

1 Press **MAGNIFY** on the remote control.

- Enlarges the image.
- Pressing **MAGNIFY** or **MAGNIFY** enlarges or reduces the projected image.

Note

Press **MAGNIFY**.

x1 x2 x3 x4 x9

Press **MAGNIFY**.

- You can change the location of the enlarged image using **▲**, **▼**, **◀** and **▶**.

2 Press **RETURN** on the remote control to cancel the operation.

- To return to the default setting (x1), press **RETURN** when the on-screen display of the magnify mode is displayed.

Note

- The selectable magnifications differ depending on the input signal.
- In the following cases, the image will return to the normal size (x1).
 - When switching the INPUT mode.
 - When **RETURN** has been pressed while the on-screen display of the magnify mode is displayed.
 - When the input signal is changed.
 - When the input signal resolution and refresh rate (vertical frequency) change.
 - When the Resize mode is changed.
 - When the Picture mode is changed.

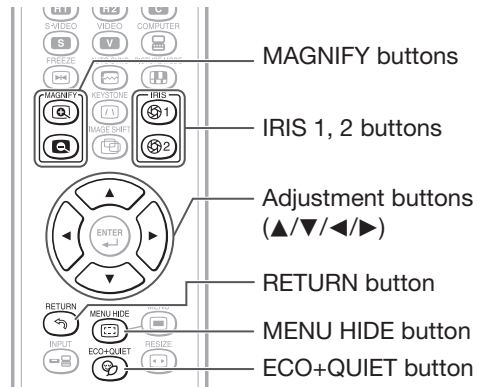

Switching the Iris Setting

This function controls the quantity of the projected light and the contrast of the image.

Press **IRIS 1** or **2**.

- Each time the button is pressed while the display is on, the mode changes in the following order:

■ IRIS 1 High Brightness ↔ High Contrast

■ IRIS 2 On ↔ Off

Note

- For details, see page 37.

Hiding the Menu Temporarily (Menu Hide)

When the menu screen is displayed, you can temporarily hide the menu screen by pressing and holding **MENU HIDE** on the remote control. This is useful when, for example, checking the video adjustment information.

Switching the Eco+Quiet Mode

Press **ECO+QUIET** to switch the Eco+Quiet mode between on and off.

- When the Eco+Quiet Mode is set to "On", the sound of the cooling fan will turn down, the power consumption will decrease, and the lamp life will extend.

Note

- Refer to "Eco+Quiet" on page 37 for details.

Resize Mode

This function allows you to modify or customize the resize mode to enhance the input image.

Press **RESIZE** on the projector or on the remote control.

Note

- The **RESIZE** function that can be selected varies depending on the input signal (resolution and vertical frequency).

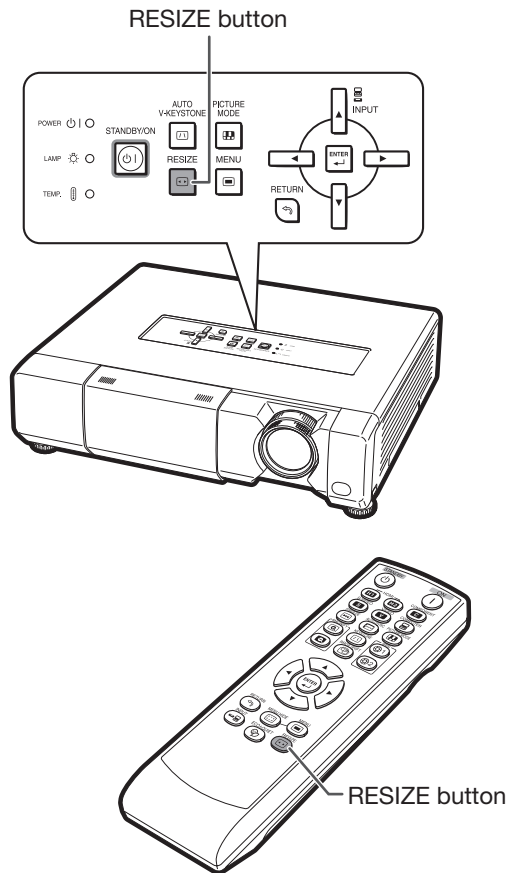



Resize Mode

RESIZE	Output screen image
NORMAL	<p>The image is displayed with the original aspect ratio.</p>
STRETCH	<p>An image compressed from a 16:9 aspect ratio to a 4:3 aspect ratio is restored to a 16:9 aspect ratio and displayed at full-screen.</p>
CINEMA ZOOM	<p>A CinemaScope image or an image with a 16:9 aspect ratio is displayed at full-screen</p>

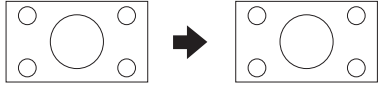

Image Projection (Continued)

RESIZE	Output screen image
ZOOM 14:9	<p>An image with a 14:9 aspect ratio and letterboxing is enlarged while maintaining the original aspect ratio.</p>  <p>The diagram shows a rectangular image with a 14:9 aspect ratio, centered on a larger square screen. The image is surrounded by black bars (letterboxing) on the top and bottom. An arrow points to the same image, but now it is enlarged so that the top and bottom bars are gone, and the image fills the width of the screen. The image is slightly smaller than the screen's height, leaving a small gap at the bottom.</p>
SMART ZOOM	<p>An image with a 4:3 aspect ratio is slightly enlarged.</p>  <p>The diagram shows a square image with a 4:3 aspect ratio, centered on a square screen. The image is surrounded by black bars on the top and bottom. An arrow points to the same image, but now it is slightly enlarged so that the top and bottom bars are gone, and the image fills the width of the screen. The image is slightly smaller than the screen's height, leaving a small gap at the bottom.</p>
DOT BY DOT	<p>The image is displayed according to the original input signal.</p>  <p>The diagram shows a square image with a 4:3 aspect ratio, centered on a square screen. The image is surrounded by black bars on the top and bottom. An arrow points to the same image, but now it is displayed at its original size, centered on the screen. The image is smaller than the screen's height, leaving a significant gap at the bottom.</p>

About Copyrights

- When using the RESIZE function to select an image size with a different aspect ratio to a TV program or video image, the image will look different from its original appearance. Keep this in mind while choosing an image size.
- The use of the RESIZE or Overscan function to compress or stretch the image for commercial purposes/public displays in a café, hotel, etc. may be an infringement of copyright protected by law for copyright holders. Please use caution.

Menu Bar Items

The following shows the items that can be set in the projector. The selectable items vary depending on the selected input, input signals, or adjustment values. Items that cannot be selected will be grayed out.

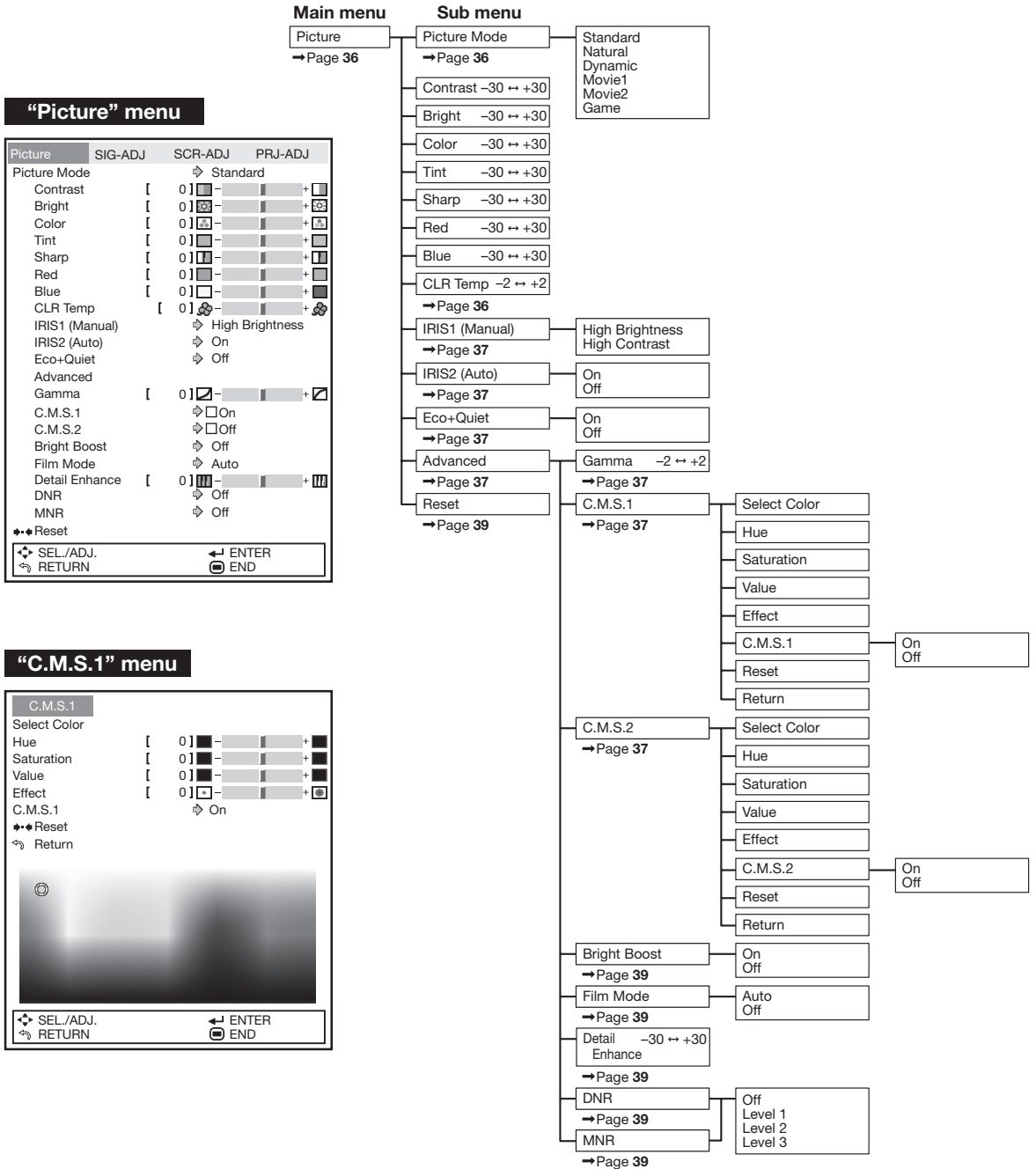

Menu Bar Items (Continued)

"SIG-ADJ" menu

Picture	SIG-ADJ	SCR-ADJ	PRJ-ADJ
Clock	[0]	[-]	[+]
Phase	[0]	[-]	[+]
H-Pos	[0]	[-]	[+]
V-Pos	[0]	[-]	[+]
◆◆Reset			
Resolution		⇨	
Auto Sync		⇨ On	
Signal Type		⇨ Auto	
Video System		⇨ Auto	
Video Setup		⇨ 0 IRE	
Dynamic Range		⇨ Auto	
Signal Info : 1080P			
H : XX.X kHz/		V : XX.X Hz	
⇨ SEL./ADJ.	⇨ ENTER		
⇨ RETURN	⇨ END		

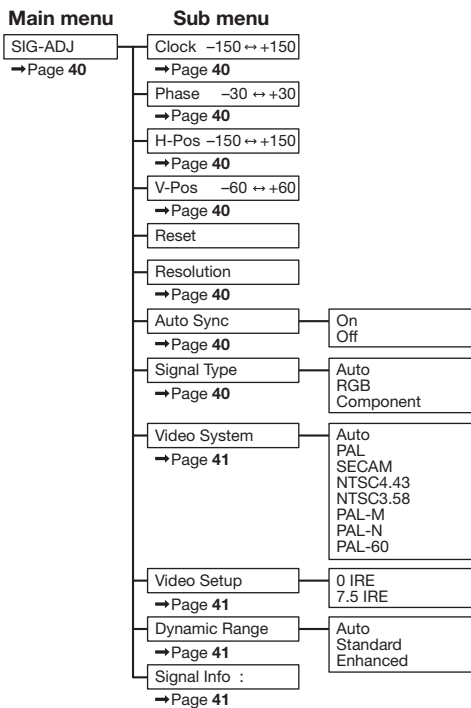

“SCR-ADJ” menu

Picture	SIG-ADJ	SCR-ADJ	PRJ-ADJ
Resize		Normal	
H-Image Shift	[0]	[-] [0] [+]	
V-Image Shift	[0]	[-] [0] [+]	
Overscan		On	
Auto V-Keystone		Keystone	
Keystone Mode		Keystone	
H-Keystone	[0]	[-] [0] [+]	
V-Keystone	[0]	[-] [0] [+]	
Sphere	[0]	[-] [0] [+]	
Rotation	[0]	[-] [0] [+]	
OSD Display		On	
OSD Brightness		Standard	
Background		Logo	
Menu Position		Upper Left	
PRJ Mode		Front	
Language		English	

SEL./ADJ. ENTER
 RETURN END

Main menu

SCR-ADJ
→Page 42

Sub menu

Resize		
→Page 42		
H-Image Shift -30 ↔ +30		
→Page 42		
V-Image Shift -30 ↔ +30		
→Page 42		
Overscan	On	Off
→Page 42		
Auto V-Keystone		
→Page 43		
Keystone Mode	Keystone	Sphere
→Page 43		Rotation
H-Keystone -60 ↔ +60		
→Page 43		
V-Keystone -100 ↔ +100		
→Page 43		
Sphere		
→Page 43		
Rotation		
→Page 44		
OSD Display	On	Off
→Page 44		
OSD Brightness	Standard	Level 1
→Page 44		Level 2
Background	Logo	Blue
→Page 44		None
Menu Position	Center	Upper Right
→Page 44		Lower Right
		Upper Left
		Lower Left
PRJ Mode	Front	Ceiling + Front
→Page 44		Rear
		Ceiling + Rear
Language	English	polski
→Page 44		Deutsch
		Magyar
		Español
		Türkçe
		Nederlands
		عربي
		فارسی
		Italiano
		汉语
		Svenska
		Português
		한국어
		Русский
		日本語

“PRJ-ADJ” menu

Picture	SIG-ADJ	SCR-ADJ	PRJ-ADJ
Auto Power Off		On	
Economy Mode		Off	
One Touch Play		Off	
System Standby		Off	
Input Name			
Demo Mode		Off	
RS-232C		9600bps	
Fan Mode		Normal	
◆◆All Reset			

Lamp Timer (Life) [X]h [XX]min (XX%)

SEL./ADJ. ENTER
 RETURN END

Main menu

PRJ-ADJ
→Page 45

Sub menu

Auto Power Off	On	Off
→Page 45		
Economy Mode	On	Off
→Page 45		
One Touch Play	On	Off
→Page 45		
System Standby	On	Off
→Page 45		
Input Name		
→Page 46		
Demo Mode	On	Off
→Page 46		
RS-232C	9600bps	38400bps
→Page 46		115200bps
Fan Mode	Normal	High
→Page 46		
All Reset		
→Page 46		
Lamp Timer (Life)		
→Page 46		

Using the Menu Screen

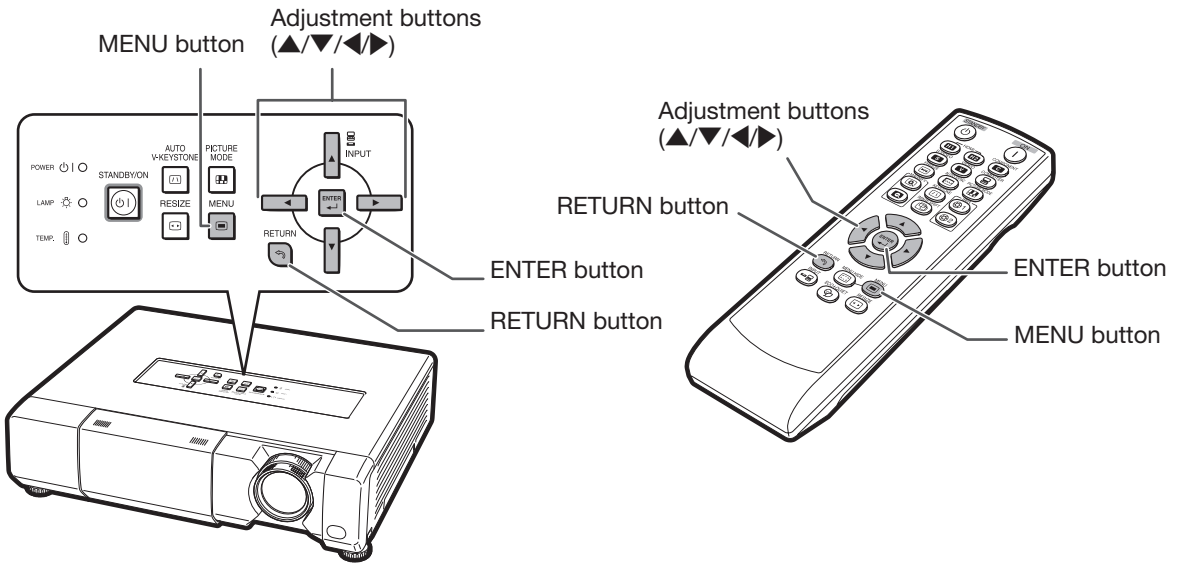

Menu Selections (Adjustments)

- This operation can also be performed by using the buttons on the projector.

1 Press **MENU**.

- The “Picture” menu screen for the selected input mode is displayed.

2 Press **▶** or **◀** to select the menu screen to adjust on the menu bar.

Example: “Picture” menu screen when COMPONENT is selected for input mode

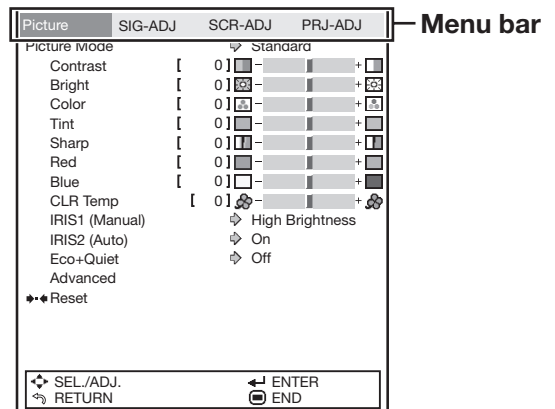

3 Press ▲ or ▼ to select the item you want to adjust.

(Example: Selecting “Bright”)

To adjust the projected image while viewing it

Press ENTER.

- The selected adjustment item (e.g. “Bright”) will be displayed at the bottom of the screen.
- When ▲ or ▼ is pressed, the next item will be displayed. (e.g. “Bright” is replaced with “Color” by pressing ▼.)

Note

- Press RETURN to return to the previous screen.

4 Press ► or ◀ to adjust the item selected.

- The adjustment is stored.
- For some menu items, press ► to display its submenu and press ▲ or ▼ to select an adjustment item, and then press ENTER.

5 Press MENU.

- The menu screen will disappear.

Single-adjustment item

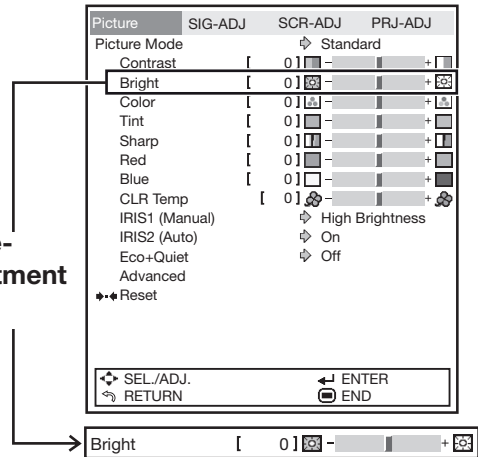

Picture Adjustment (“Picture” Menu)

Menu operation ⇒ Page 34

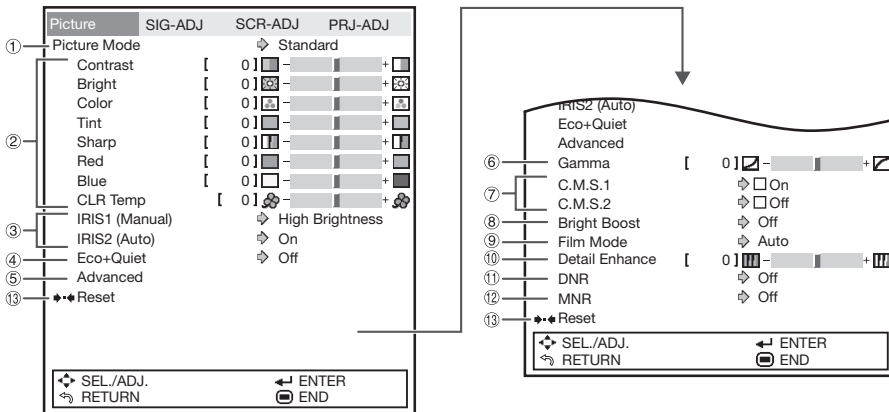

① Selecting the Picture Mode

This function allows you to select the picture mode that best suits the room brightness and the type of image being projected.

Selectable items	Description	The main default settings of each item when selecting Picture Mode				
		CLR Temp	Bright Boost	IRIS1 (Manual)	IRIS2 (Auto)	Eco+Quiet
Standard	For standard image	0	Off	High Brightness	On	Off
Natural	A balanced color image is obtained.	0	Off	High Brightness	Off	Off
Dynamic	A vivid image is obtained.	0	On	High Brightness	Off	Off
Movie1	For viewing images with the brightness slightly toned down in a darkened room	-1	Off	High Contrast	Off	On
Movie2	For viewing images with the brightness slightly boosted in a darkened room	-1	Off	High Contrast	On	On
Game	Use this when the audio and image are not synched or when you want to create a sharper image.	0	On	High Brightness	Off	Off

- You can set or adjust each item in the “Picture” menu to your preference. Any changes you make are retained in memory.

Note

- You can also press **PICTURE MODE** on the remote control to select the picture mode. (See page 27.)
- The default settings are subject to change without notice.

② Adjusting the Image

Adjustment items	◀ button	▶ button
Contrast	For less contrast.	For more contrast.
Bright	For less brightness.	For more brightness.
Color	For less color intensity.	For more color intensity.
Tint	For making skin tones purplish.	For making skin tones greenish.
Sharp	For less sharpness.	For more sharpness.
Red	For making images less reddish.	For making images more reddish.
Blue	For making images less bluish.	For making images more bluish.
CLR Temp	For making images slightly more reddish (slightly warmer colors).	For making images slightly more bluish (slightly cooler colors).

③ Switching the Iris Setting

This function controls the quantity of the projected light and the contrast of the image.

■ IRIS1 (Manual)

Selectable items	Description
High Brightness	This mode gives priority to brightness over contrast.
High Contrast	This mode gives priority to contrast over brightness.

■ IRIS2 (Auto)

This automatically selects the optimal contrast to match the image.

Selectable items	Description
On	This mode gives priority to contrast with the use of auto adjustment.
Off	This mode gives priority to brightness without the use of auto adjustment.



Note

- You can also use **IRIS 1, 2** on the remote control to change the Iris. (See page 28.)

④ Eco+Quiet

Selectable items	Brightness and Power consumption
On	Approx. 75%
Off	100%



Note

- When “Eco+Quiet” is set to “On”, the power consumption will decrease and the lamp life will extend. (Projection brightness decreases approximately 25%.)

⑤ Using the Advanced

“Advanced” allows you to make even finer adjustments to the image so that it appears just the way you want it to.

To display the Advanced menu, select “Advanced” and press **ENTER**.



Note

- When the “Advanced” settings are displayed, select “Advanced” again and press **ENTER** to return to the “Picture” menu.

⑥ Correcting Gradation of Video (Gamma Correction)

When the darker areas of the image become difficult to see because of the image or the projection environment, you can correct the gamma setting to make the image brighter and easier to see.

Selectable items	Description
+2	Provides a brighter gradation.
+1	
0	Standard setting
-1	Provides a darker gradation.
-2	

⑦ Adjusting the Colors

You can select the color of the projected image to correct and then adjust it to the desired color by setting “Hue”, “Saturation”, “Value”, and “Effect”.



Note

- Before performing this adjustment, prepare the image to be adjusted.
- You can perform this adjustment easier in the still image than in the moving image.

1 Select “C.M.S.1” or “C.M.S.2” (C.M.S.: Color Management System) in the “Advanced” menu, and press **ENTER**.

- If there is no data for the stored corrected color, the color selection screen and the picker is displayed. (Go to step 2.)

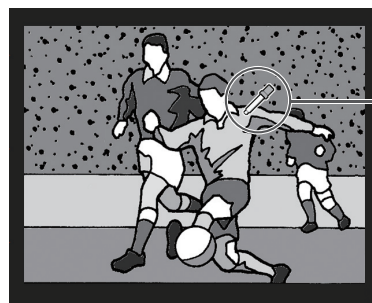

Picker

Picture Adjustment (“Picture” Menu) (Continued)

- If there is data for the stored corrected color, the C.M.S. color adjustment screen is displayed. (Go to step 3.)

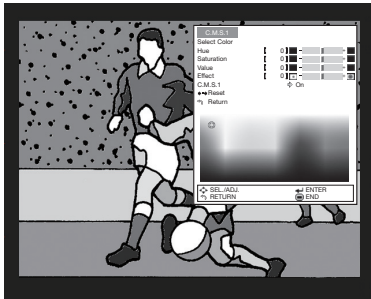

2 Use the picker and select the color of the projected image to correct. The picker can be operated by adjustment buttons (▲/▼/◀/▶) on the remote control.

- By enlarging the projected image using or **MAGNIFY**, more fine adjustment can be performed.



- By continuing to press the adjustment buttons (▲/▼/◀/▶), the picker moves rapidly.

After selecting the color of the projected image to correct, press **ENTER**. The C.M.S. color adjustment screen is displayed. (Go to step 3.)

3 Set or adjust each item in the C.M.S. color adjustment screen.

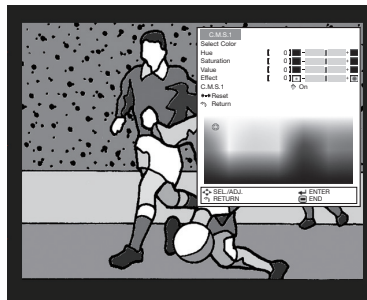

C.M.S. color adjustment screen:

Selectable items	Description
Select Color	Starts over the selection of the color to be corrected.
Hue	Sets the hue of the main colors.
Saturation	Sets the saturation of the main colors.
Value	Sets the value of the main colors.
Effect ¹	Specifies the range of color correction.
C.M.S.1 ² (or C.M.S.2)	Checks the appearance of the projected image after above correction.
Reset	Sets “Hue”, “Saturation”, “Value”, and “Effect” to their default values.
Return	Completes the correction and closes the C.M.S. color adjustment screen.

^{*1} To specify the range of color correction, select “Effect” and press ◀ or ▶ button.

◀ button	Specifies smaller range.
▶ button	Specifies larger range.

^{*2} To check the appearance of the projected image, select “C.M.S.1” (or “C.M.S.2”) and set to “On” or “Off”.

On	The appearance of the projected image after above color adjustment reflected can be checked.
Off	The appearance of the projected image in former color adjustment can be checked.

4 To complete the C.M.S. color adjustment, select “Return” and press **ENTER**.

Note

- The C.M.S. color adjustment can be made to one color each in “C.M.S.1” and “C.M.S.2”.

⑧ Adjusting the Bright Boost

Bright Boost uses Texas Instruments' Bright Boost technology. The image becomes brighter while the color reproduction is kept at a high level.

Selectable items	Description
On	The Bright Boost function is activated.
Off	The Bright Boost function is not activated.

⑨ Selecting the Film Mode

This function provides high-quality playback of images originally projected at 24 fps, such as movies on DVDs.

Selectable items	Description
Auto	Films are detected automatically.
Off	Films are not detected.

⑩ Setting Detail Enhancement

This function enhances the details in images and, thereby, creates a greater sense of depth.

◀ button	Provides less detail enhancement.
▶ button	Provides more detail enhancement.

⑪ Reducing Image Noise (DNR)

Video digital noise reduction (DNR) provides high quality images with minimal dot crawl and cross color noise.

Selectable items	Description
Off	The DNR function is not activated.
Level 1	Sets the DNR level for viewing a clearer picture.
Level 2	
Level 3	

Note

Set "DNR" to "Off" in the following cases:

- When the image is blurry.
- When the contours and colors of moving images drag.
- When TV broadcasts with weak signals are projected.
- This function can be set when the input signal is 480I/480P, 576I/576P, S-VIDEO or VIDEO.

⑫ Mosquito Noise Reduction (MNR)

The so-called Mosquito Noise (flickering) can be reduced.

Selectable items	Description
Off	MNR does not function.
Level 1	Sets the MNR level for viewing a clearer picture.
Level 2	
Level 3	

Note

Set "MNR" to "Off" in the following cases:

- When the image is blurry.
- When the contours and colors of moving images drag.
- When TV broadcasts with weak signals are projected.
- This function can be set when the input signal is 480I/480P, 576I/576P, S-VIDEO or VIDEO.

⑬ Resetting All Adjustment Items

To reset all adjustment items to the default settings, select "Reset" and press **ENTER**.

⑤ Setting the Video System

The video input system mode is factory preset to “Auto”; however, a clear picture from the connected audio-visual equipment may not be received, depending on the video signal difference. In that case, switch the video signal.

Selectable items
Auto
PAL
SECAM
*NTSC4.43
NTSC3.58
PAL-M
PAL-N
PAL-60

* When reproducing NTSC signals in PAL video equipment.

Note

- The video signal can only be set in VIDEO or S-VIDEO mode.
- When “Video System” is set to “Auto”, you may not receive a clear picture due to signal differences. Should this occur, switch to the video system of the source signal.

⑥ Setting the Video Setup

Selectable items	Description
0 IRE	Sets the black level to 0 IRE.
7.5 IRE	Sets the black level to 7.5 IRE.

Note

- This can be used for a 480I signal connected to the COMPONENT terminal or the COMPUTER/COMPONENT terminal.
- This can be used for an NTSC3.58 signal connected to the VIDEO or S-VIDEO terminal.

⑦ Adjusting the Dynamic Range

An optimum picture may not be displayed if an HDMI-capable device’s output signal type and the projector’s input signal type do not match. If this should occur, switch “Dynamic Range”.

Selectable items	Description
Auto	In most circumstances, “Auto” should be selected.
Standard	When the black levels of the image show banding or appear faded, select the item that results in the best picture quality.
Enhanced	

⑧ Signal Info

Input signal information is displayed.

④ Auto V-Keystone Correction

Select "Auto V-Keystone" in the "SCR-ADJ" menu and press **ENTER**. Vertical keystone correction is performed automatically.

Note

- Pressing **ENTER** when the on-screen display of the Auto V-Keystone "On" appears changes the setting of the Auto V-Keystone to "Off".
- For details of Keystone mode, see page 24.
- Pressing **AUTO V-KEYSTONE** while adjusting the image using Sphere/Rotation Correction changes Sphere/Rotation Correction mode to keystone mode.

Auto V-Keystone Correction

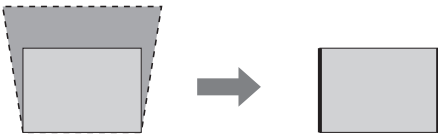

⑤ Keystone Mode Correction

This function can correct distortion of an image projected toward a spherical or cylindrical screen as well as trapezoidal distortion of an image on a flat screen and rotate the image at your arbitrary angle.

Note

- For details of Keystone mode, see page 24.

Info

- While adjusting the image using Keystone/ Sphere/Rotation Correction, straight lines and the edges of the image may appear jagged.

Select "Keystone Mode" in the "SCR-ADJ" menu and press **ENTER**. Then select a desired item among "Keystone", "Sphere", or "Rotation" and press **ENTER**. "Keystone" has been set as a default setting in which you can adjust "H-Keystone" and "V-Keystone".

Keystone

H-Keystone:

◀ or ▶	Makes the upper and lower sides parallel.
--------	---

Horizontal Keystone Correction



V-Keystone:

◀ or ▶	Makes the left and right sides parallel.
--------	--

Vertical Keystone Correction

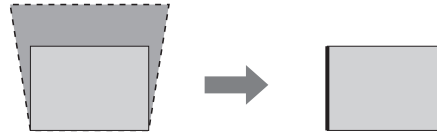

Sphere

This function corrects screen distortion created during spherical or cylindrical screen projection.

◀ button	Narrower at the center
▶ button	Wider at the center

Sphere Correction

Correction of Convex Distortion:

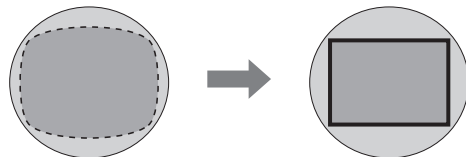

Correction of Concave Distortion:



Adjusting the Projected Image (“SCR-ADJ” Menu) (Continued)

■ Rotation

This function can rotate the image at an arbitrary angle.

◀ button	Rotates the image counterclockwise.
▶ button	Rotate the image clockwise.

Rotation Correction



⑥ Setting On-screen Display

Selectable items	Description
On	All on-screen displays are displayed.
Off	INPUT/FREEZE/AUTO SYNC/RESIZE/PICTURE MODE/ECO+QUIET/MAGNIFY/ “An invalid button has been pressed.” are not displayed.

⑦ Setting the Brightness of the Menu Screen

Sets the brightness of the menu screen.

Selectable items	Description
Standard	Standard brightness
Level 1	Darker than the “Standard” brightness
Level 2	Darker than the “Level 1” brightness

⑧ Selecting the Background Image

Selectable items	Description
Logo	SHARP logo screen
Blue	Blue screen
None	— (Black screen)

⑨ Selecting the Menu Screen Position

Select “Menu Position” in the “SCR-ADJ” menu and the desired position for the menu screen.

Selectable items	Description
Center	Displayed on the center of the image.
Upper Right	Displayed on the upper right of the image.
Lower Right	Displayed on the lower right of the image.
Upper Left	Displayed on the upper left of the image.
Lower Left	Displayed on the lower left of the image.

⑩ Reversing/Inverting Projected Images

This function allows the projector to be used in a wider range of projection styles by allowing the image to be inverted to suit the projection environment (location).

Selectable items	Description
Front	Normal image (Projected from the front of the screen)
Ceiling + Front	Inverted image (Projected from the front of the screen with an inverted projector)
Rear	Reversed image (Projected from the rear of the screen or with a mirror)
Ceiling + Rear	Reversed and inverted image (Projected with a mirror)

See page 16 for details of Projection (PRJ) Mode.

⑪ Selecting the On-screen Display Language

The projector can switch the on-screen display language among 17 languages.

English
 Deutsch
 Español
 Nederlands
 Français
 Italiano
 Svenska
 Português
 Русский
 polski
 Magyar
 Türkçe
 عربي
 فارسی
 汉语
 한국어
 日本語

Adjusting the Projector Function (“PRJ-ADJ” Menu)

The illustration shown here is for explanation and may be different from the actual on-screen display.

Picture	SIG-ADJ	SCR-ADJ	PRJ-ADJ
① Auto Power Off		⇒ On	
② Economy Mode		⇒ Off	
③ One Touch Play		⇒ Off	
System Standby		⇒ Off	
Input Name			
④ Demo Mode		⇒ Off	
⑤ RS-232C		⇒ 9600bps	
⑥ Fan Mode		⇒ Normal	
⑦ ●●● All Reset			
⑧ Lamp Timer (Life) [X]h [XX]min (XX%)			
SEL./ADJ. RETURN		ENTER END	

① Setting Auto Power Off Mode

This function automatically switches the projector to Standby mode if no signals are received for a set period.

Selectable items	Description
On	When no input signal is detected for more than 15 minutes, the projector will automatically enter standby mode.
Off	The Auto Power Off function will be disabled.

Note

- When the Auto Power Off function is set to “On”, 5 minutes before the projector enters standby mode, the message “Enter STANDBY mode in X min.” will appear on the screen to indicate the remaining minutes.

② Setting the Power Save Mode (Economy Mode)

■ Economy Mode

Selectable items	Description
On	This enables the Economy mode.
Off	You can use the linked functions. RS-232C can be used to control the projector in standby mode.

Note

- Set this function to “Off” when you want to use RS-232C to control the projector from a computer.
- One Touch Play is set to “Off” when the Economy mode is set to “On”.

③ Setting One Touch Play, System Standby and Input Name

When a Sharp product equipped with Consumer Electronics Control (HDMI CEC) is connected to the projector with an HDMI cable, you can use the linked function with HDMI CEC (“One Touch Play” and “System Standby”).

Note

The CEC function may not work with some CEC devices. (When the projector is connected to a non-Sharp product, the CEC function may not work.)

■ Setting the One-Touch Playback Function (One Touch Play)

One Touch Play turns on the projector and selects the input automatically when you turn on or begin playback on connected HDMI-compliant Sharp Video Products.

Selectable items	Description
On	This enables One Touch Play.
Off	This disables One Touch Play.

Note

- When enabling One Touch Play, be sure to enable the CEC setting on the HDMI-compliant Sharp Video Products connected to the projector.
- The Economy mode is set to “Off” when One Touch Play is set to “On”.
- In the following cases, One Touch Play is not enabled.
 - When playback is paused
 - When the screen is turned off (black) after the lens shutter is closed
 - When the cooling fan is running (See page 48.)
 - When the lamp is warming up (See page 48.)

■ Setting the System Standby Function (System Standby)

When you turn off the projector, the HDMI-compliant video equipment connected to the projector enters standby mode.

Selectable items	Description
On	This enables System Standby.
Off	This disables System Standby.

Note

- When enabling System Standby, be sure to enable the CEC setting on the HDMI-compliant Sharp Video Products connected to the projector.

Adjusting the Projector Function (“PRJ-ADJ” Menu) (Continued)

■ Setting the Input Terminal Names (Input Name)

Set the name of the input terminal (up to 14 alphanumeric characters).

1 Press ▲/▼ to select “Input Name” and then press ENTER.

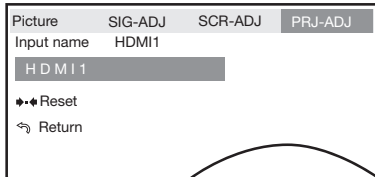

◀ or ▶ button	Selects a character column.
▲ or ▼ button	Selects a character.
ENTER button	Sets the input terminal name.

2 Press ▲/▼ to select “Return” and then press ENTER to return to the previous screen.

- To return to the previous setting, select “Reset” and then press ENTER.

Note

- When connecting the projector to a Sharp Video Product with an HDMI cable using an input mode of HDMI1 or HDMI2 and the linked function with HDMI CEC (“One Touch Play” or “System Standby”) works normally, the name of the connected Sharp Video Product is automatically captured.
- When the input terminal name has been changed by a user, the changed name is displayed.
- To return to the default name, select “Reset” and press ENTER.

④ Setting the Demo Mode

Set the Demo Mode to “On” or “Off”.

Selectable items	Description
On	This enables Demo Mode.
Off	This disables Demo Mode.

⑤ Selecting the Transmission Speed (RS-232C)

Make sure that both the projector and computer are set for the same baud rate.

Selectable items	Description
9600bps	Transmission speed is slow.
38400bps	↕
115200bps	Transmission speed is rapid.

⑥ Fan Mode Setting

This function changes the fan rotation speed.

Selectable items	Description
Normal	Suitable for normal environments.
High	Select this when using the projector at altitudes of approximately 4,900 feet (1,500 meters) or more.

- When “Fan Mode” is set to “High”, the fan rotation speeds up, and the fan noise becomes louder.

⑦ Returning to the Default Settings

Use “All Reset” to initialize all the adjustments you have made to the default settings.

Note

The following items cannot be initialized.

- “SIG-ADJ” menu — Resolution
- “SCR-ADJ” menu — Language
- “PRJ-ADJ” menu — Lamp Timer (Life)

⑧ Lamp Timer (Life)

You can confirm the cumulative lamp usage time and the remaining lamp life (percentage).

Lamp usage condition	Remaining lamp life		
	“Life”	100%	5%
Operated exclusively with “Eco+Quiet” set to “On”	Approx. 3,000 hours	Approx. 150 hours	Approx. 150 hours
Operated exclusively with “Eco+Quiet” set to “Off”	Approx. 2,000 hours	Approx. 100 hours	Approx. 100 hours

Note

- It is recommended that the lamp be changed when the remaining lamp life becomes 5%.
- The lamp life may vary depending on the usage condition.

Maintenance

Cleaning the projector

- Ensure that you have unplugged the power cord before cleaning the projector.
 - The cabinet as well as the operation panel is made of plastic. Avoid using benzene or thinner, as these can damage the finish on the cabinet.
 - Do not use volatile agents such as insecticides on the projector.
 - Do not attach rubber or plastic items to the projector for long periods.
- The effects of some of the agents in the plastic may cause damage to the quality or finish of the projector.
- Wipe off dirt gently with a soft flannel cloth.
 - When the dirt is hard to remove, soak a cloth in a mild detergent diluted with water, wring the cloth well and then wipe the projector.

Strong cleaning detergents may discolor, warp or damage the coating on the projector. Make sure to test on a small, inconspicuous area on the projector before use.

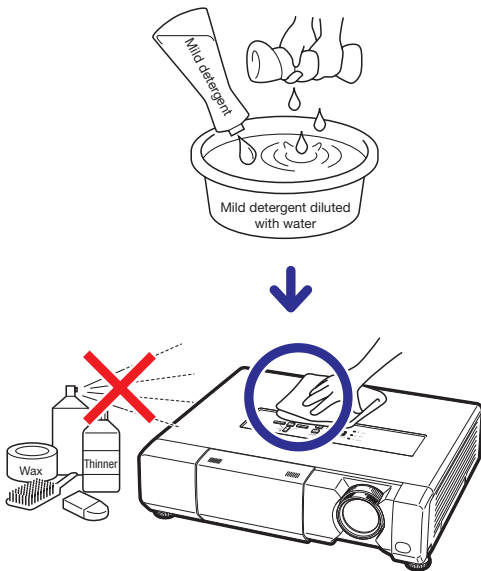

Cleaning the lens

- Use a commercially available blower or lens cleaning paper (for glasses and camera lenses) for cleaning the lens. Do not use any liquid type cleaning agents, as they may wear off the coating film on the surface of the lens.
- As the surface of the lens can easily get damaged, be careful not to scrape or hit the lens.

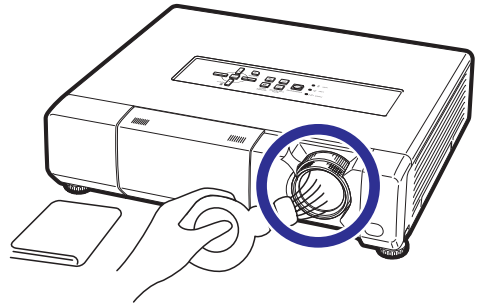

Cleaning the exhaust and intake vents

- Use a vacuum cleaner to clean dust from the exhaust vent and the intake vent.

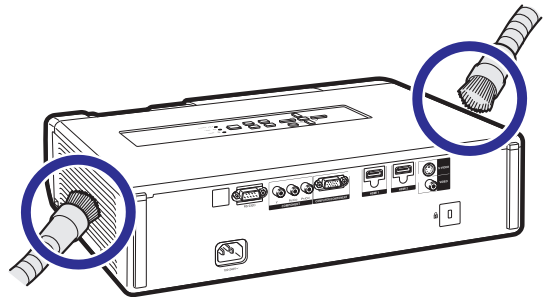

Info

- If you want to clean the air vents during projector operation, ensure you press **STANDBY/ON** on the projector or **STANDBY** on the remote control and put the projector into standby mode. After the cooling fan has stopped, clean the vents.

Maintenance Indicators

- The warning lights (power indicator, lamp indicator and temperature warning indicator) on the projector indicate problems inside the projector.
- If a problem occurs, either the temperature warning indicator or the lamp indicator will illuminate red, and the projector will enter standby mode. After the projector has entered standby mode, follow the procedures given below.

Top View

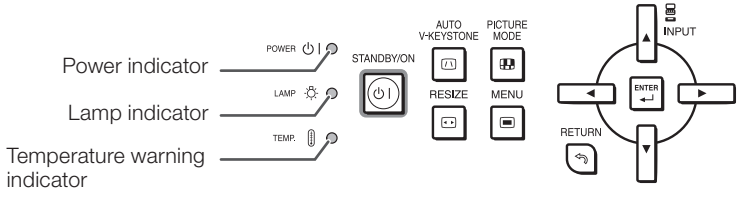

About the temperature warning indicator



If the temperature inside the projector increases, due to blockage of the air vents, or the setting location, the temperature warning indicator will blink. And if the temperature keeps on rising, “TEMP.” will illuminate in the lower left corner of the picture with the temperature warning indicator blinking. If this state continues, the lamp will turn off, the cooling fan will run and then the projector will enter standby mode. When you find the temperature warning indicator blinking, be sure to perform the measures described on page 49.

About the lamp indicator



- When the remaining lamp life becomes 5% or less, (yellow) and “Change The Lamp” will be displayed on the screen. When the percentage becomes 0%, it will change to (red), the lamp will automatically turn off and then the projector will automatically enter standby mode. At this time, the lamp indicator will illuminate in red.
- **If you try to turn on the projector a fourth time without replacing the lamp, the projector will not turn on.**

Indicators on the Projector

Power indicator	Red on	Normal (Standby)
	Green on	Normal (Power on)
	Red blinks	Abnormal (See page 49.)
	Green blinks	Normal (Cooling)
	Green and orange blink alternately	The lens shutter is closed. (See page 22.)
Lamp indicator	Green on	Normal
	Green blinks	The lamp is warming up.
	Red on	The lamp is shut down abnormally or requires to be changed. (See page 49.)
Temperature warning indicator	Off	Normal
	Red on/Red blinks	The internal temperature is abnormally high. (See page 49.)

	Maintenance indicator		Problem	Cause	Possible Solution
	Normal	Abnormal			
Temperature warning indicator	Off	Red blinks (On)/ Red on (Standby)	The internal temperature is abnormally high.	<ul style="list-style-type: none"> • Temperatures around the projector are high. • Blocked air intake 	<ul style="list-style-type: none"> • Use the projector in an area with a temperature of lower than 95°F (+35°C). • Relocate the projector to an area with proper ventilation. (See page 6.)
				<ul style="list-style-type: none"> • Cooling fan breakdown • Internal circuit failure • Clogged air intake 	<ul style="list-style-type: none"> • Take the projector to your nearest Sharp Authorized Projector Dealer or Service Center (see page 60) for repair.
Lamp indicator	Green on (Green blinks when the lamp is warming up.)	Red on (Standby)	The lamp does not illuminate.	<ul style="list-style-type: none"> • The lamp is shut down abnormally. 	<ul style="list-style-type: none"> • Disconnect the power cord from the AC outlet, and then connect it again. • Carefully replace the lamp. (See page 50.) • Take the projector to your nearest Sharp Authorized Projector Dealer or Service Center (see page 60) for repair. • Please exercise care when replacing the lamp. • Securely install the cover.
			Time to change the lamp.	<ul style="list-style-type: none"> • Remaining lamp life becomes 5% or less. 	
			The lamp does not illuminate.	<ul style="list-style-type: none"> • Burnt-out lamp • Lamp circuit failure 	
Power indicator	Green on/ Red on Green blinks (Cooling)	Red blinks	The power indicator blinks in red when the projector is on.	<ul style="list-style-type: none"> • The lamp unit cover is open. 	<ul style="list-style-type: none"> • If the power indicator blinks in red even when the lamp unit cover are securely installed, contact your nearest Sharp Authorized Projector Dealer or Service Center (see page 60) for advice.

Info

- If the temperature warning indicator illuminates, and the projector enters standby mode, follow the possible solutions above and then wait until the projector has cooled down completely before plugging in the power cord and turning the power back on. (At least 10 minutes.)
- If the power is turned off for a brief moment due to power outage or some other cause while using the projector, and the power supply recovers immediately after that, the lamp indicator will illuminate in red and the lamp may not be lit. In this case, unplug the power cord from the AC outlet, replace the power cord in the AC outlet and then turn the power on again.
- The cooling fan keeps the internal temperature of the projector constant and this function is controlled automatically. The sound of the cooling fan may change during operation because the fan speed may change and this is not a malfunction.

Regarding the Lamp

Lamp

- It is recommended that the lamp (sold separately) be replaced when the remaining lamp life becomes 5% or less, or when you notice a significant deterioration in the picture and color quality. The lamp life (percentage) can be checked with the on-screen display. (See page 46.)
- Purchase a replacement lamp of type AN-K15LP from your place of purchase, nearest Sharp Authorized Projector Dealer or Service Center.

IMPORTANT NOTE TO U.S. CUSTOMERS:

The lamp included with this projector is backed by a 90-day parts and labor limited warranty. All service of this projector under warranty, including lamp replacement, must be obtained through a Sharp Authorized Projector Dealer or Service Center. For the name of the nearest Sharp Authorized Projector Dealer or Service Center, please call toll-free: 1-888-GO-SHARP (1-888-467-4277).

Hg LAMP CONTAINS MERCURY For State Lamp Disposal Information
www.lamprecycle.org or 1-800-BE-SHARP

U.S.A. ONLY

Caution Concerning the Lamp

- This projector utilizes a pressurized mercury lamp. A loud sound may indicate lamp failure. Lamp failure can be attributed to numerous sources such as: excessive shock, improper cooling, surface scratches or deterioration of the lamp due to a lapse of usage time.
- The period of time up to failure largely varies depending on the individual lamp and/or the condition and the frequency of use. It is important to note that failure can often result in the bulb cracking.
- When the lamp replacement indicator and on-screen display icon are illuminated, it is recommended that the lamp be replaced with a new one immediately, even if the lamp appears to be operating normally.
- Should the lamp break, there is also a possibility that glass particles may spread inside of the projector. In such a case, it is recommended you contact your nearest Sharp Authorized Projector Dealer or Service Center to assure safe operation.
- Should the lamp break, the glass particles may spread inside the lamp cage or gas contained in the lamp may be vented into the room from the exhaust vent. Because the gas in this lamp includes mercury, ventilate the room well if the lamp breaks and avoid all exposure to the released gas. In case of exposure to the gas, consult a doctor as soon as possible.

Replacing the Lamp

Caution

- Do not remove the lamp unit from the projector right after use. The lamp will be very hot and may cause burns or injury.
- Wait at least one hour after the power cord is disconnected to allow the surface of the lamp unit to fully cool before removing the lamp unit.

- **Carefully change the lamp by following the instructions described in this section. * If you wish, you may have the lamp replaced at your nearest Sharp Authorized Projector Dealer or Service Center.**

* If the new lamp does not light after replacement, take your projector to the nearest Sharp Authorized Projector Dealer or Service Center for repair.

Removing and Installing the Lamp Unit

- Warning!** • Do not remove the lamp unit from the projector right after use. The lamp and parts around the lamp will be very hot and may cause burns or injury.

Info

- Do not touch the glass surface of the lamp unit or the inside of the projector.
- To avoid injury to yourself and damage to the lamp, make sure you carefully follow the steps below.
- Do not loosen other screws except for the lamp unit cover and lamp unit.

Optional
accessory

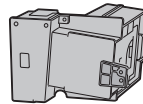

Lamp unit
AN-K15LP

- 1 Press **STANDBY/ON** on the projector or **STANDBY** on the remote control to put the projector into standby mode.**

- 2 Disconnect the power cord.**
 - Unplug the power cord from the AC socket.
 - Leave the lamp until it has fully cooled down (about 1 hour).

- 3 Remove the lamp unit cover.**
 - Close the lens shutter. Loosen the user service screw (①) that secures the lamp unit cover. Remove the lamp unit cover (②).

STANDBY/ON button

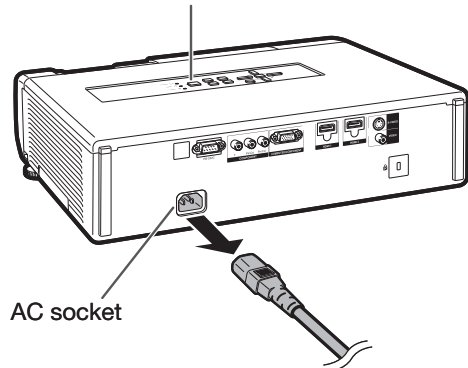

AC socket

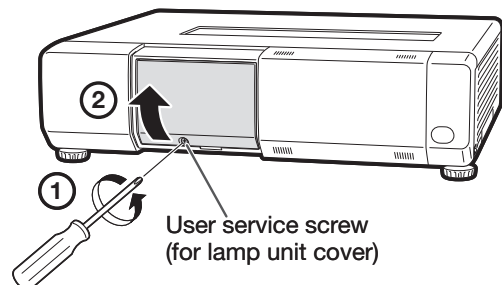
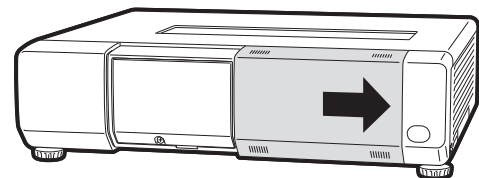

User service screw
(for lamp unit cover)

Regarding the Lamp (Continued)

4 Remove the lamp unit.

- Loosen the securing screws from the lamp unit. Hold the lamp unit and pull it in the direction of the arrow. At this time, keep the lamp unit horizontal and do not tilt it.

5 Insert the new lamp unit.

- Press the lamp unit firmly into the lamp unit compartment. Fasten the securing screws.

6 Replace the lamp unit cover.

- Align the tab on the lamp unit cover (①) and place it while pressing the cover (②) to close it. Then tighten the user service screw (③) to secure the lamp unit cover.

Info

- If the lamp unit and lamp unit cover are not correctly installed, the power will not turn on, even if the power cord is connected to the projector.

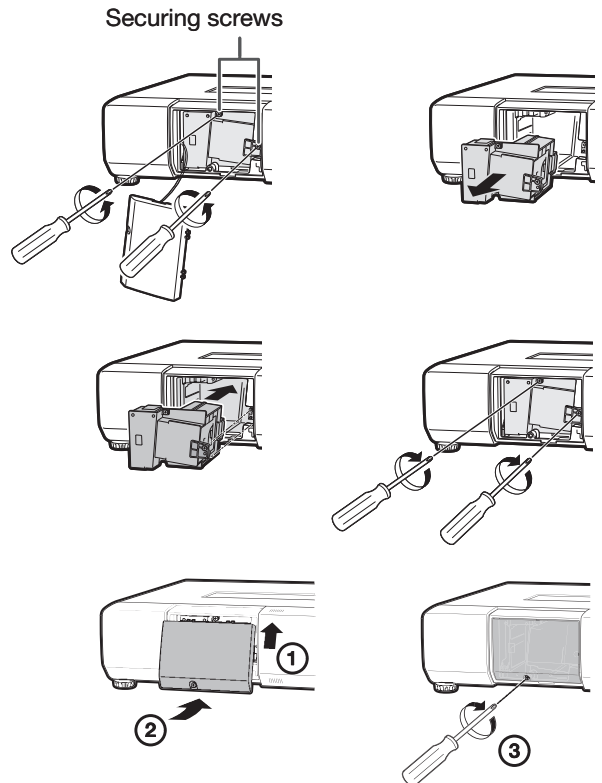

Resetting the Lamp Timer

Reset the lamp timer after replacing the lamp.

Info

- Make sure to reset the lamp timer only when replacing the lamp. If you reset the lamp timer and continue to use the same lamp, this may cause the lamp to become damaged or explode.

1 Connect the power cord and open the lens shutter fully.

- Plug the power cord into the AC socket of the projector.

2 Reset the lamp timer.

- While simultaneously holding down **MENU**, **ENTER** and **▼** on the projector, press **STANDBY/ON** on the projector and keep all four buttons pressed down until the lamp indicator starts blinking green.
- "LAMP 0000 H" is displayed, indicating that the lamp timer is reset.

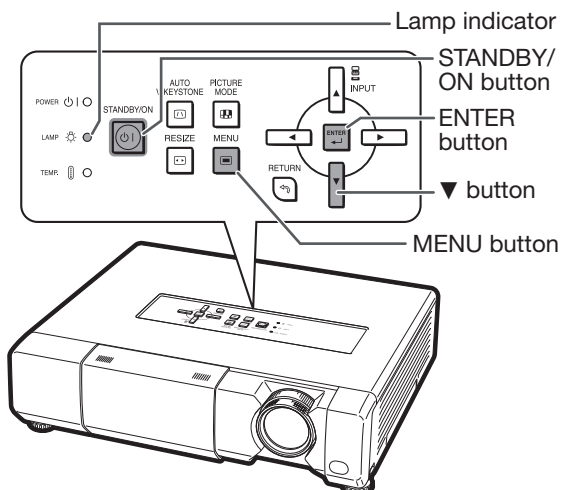
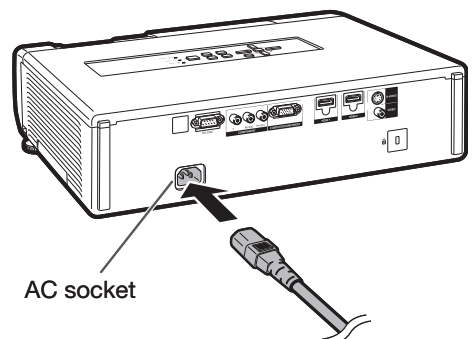

Connecting Pin Assignments

COMPUTER/COMPONENT input and COMPUTER/COMPONENT output Terminals : mini D-sub 15 pin female connector

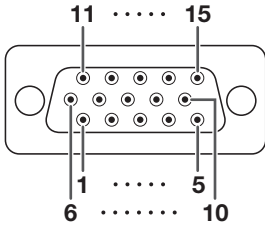

COMPUTER Input/Output

Pin No.	Signal
1	Video input (red)
2	Video input (green/sync on green)
3	Video input (blue)
4	Not connected
5	Not connected
6	Earth (red)
7	Earth (green/sync on green)
8	Earth (blue)
9	Not connected
10	GND
11	Not connected
12	Bi-directional data
13	Horizontal sync signal: TTL level
14	Vertical sync signal: TTL level
15	Data clock

COMPONENT Input/Output

Pin No.	Signal
1	PR (CR)
2	Y
3	PB (CB)
4	Not connected
5	Not connected
6	Earth (PR)
7	Earth (Y)
8	Earth (PB)
9	Not connected
10	Not connected
11	Not connected
12	Not connected
13	Not connected
14	Not connected
15	Not connected

RS-232C Terminal: 9-pin D-sub male connector

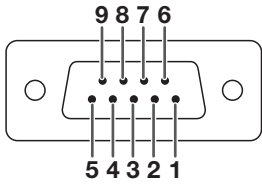

Pin No.	Signal	Name	I/O	Reference
1				Not connected
2	RD	Receive Data	Input	Connected to internal circuit
3	SD	Send Data	Output	Connected to internal circuit
4		Reserved		Connected to internal circuit
5	SG	Signal Ground		Connected to internal circuit
6		Reserved		Connected to internal circuit
7		Reserved		Connected to internal circuit
8		Reserved		Connected to internal circuit
9				Not connected

HDMI Terminal

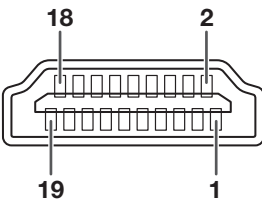

Pin No.	Name	Pin No.	Name	Pin No.	Name
1	T.M.D.S data 2+	8	T.M.D.S data 0 shield	14	Reserved
2	T.M.D.S data 2 shield	9	T.M.D.S data 0-	15	SCL
3	T.M.D.S data 2-	10	T.M.D.S clock+	16	SDA
4	T.M.D.S data 1+	11	T.M.D.S clock shield	17	DDC/CEC ground
5	T.M.D.S data 1 shield	12	T.M.D.S clock-	18	+5V power
6	T.M.D.S data 1-	13	CEC	19	Hot plug detection
7	T.M.D.S data 0+				



RS-232C Specifications and Commands

Computer control

A computer can be used to control the projector by connecting an RS-232C cable (null modem, cross type, commercially available) to the projector. (See page 21 for connection.)

Communication conditions

Set the serial port settings of the computer as follows.

Signal format: Conforms to RS-232C standard.

Baud rate*: 9,600 bps / 38,400bps / 115,200bps

Data length: 8 bits

*Use the same settings for the projector and computer.

Parity bit: None

Stop bit: 1 bit

Flow control: None

Basic format

Send commands from the computer in the following order: command, parameter, and return code. After processing the command from the computer, the projector sends a response code to the computer.

Command format

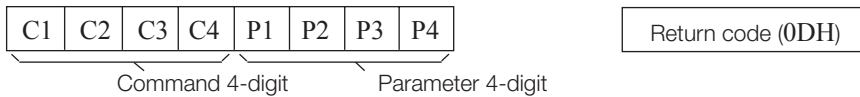

Response code format

Normal response



Problem response (communication error or incorrect command)



Info

- If you are controlling the projector from a computer using RS-232C commands, wait at least 30 seconds after turning the projector on before sending any commands.
- When more than one code is being sent, send each command only after the response code for the previous command from the projector is verified.
- When using the computer control function of the projector, the projector's operating status cannot be read by the computer. Therefore, confirm the status by transmitting the display commands for each adjustment menu and checking the status with the on-screen display. If the projector receives a command other than a menu display command, it will execute the command without displaying the on-screen display.

Commands

Example: To turn on the projector

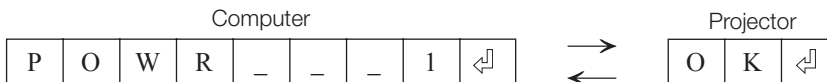

Control Contents	Command	Parameter	Return	
			Power ON	Standby mode (or 30-second startup time)
Power	On	P O W R _ _ _ 1	OK or ERR	OK
	Off	P O W R _ _ _ 0	OK	OK or ERR
	Status	T L P S ? ? ? ?	1	0
Projector Condition		T A B N _ _ _ 1	0:Normal 1:Temp High 8:Lamp Life 5% or less 16:Lamp Burnt-out 32:Lamp Ignition Failure	0:Normal 1:Temp High 2:Fan Error 4:Lamp Cover Open 8:Lamp Life 5% or less 16:Lamp Burnt-out 32:Lamp Ignition Failure 64:Temp Abnormally High
	Lamp	T L P S _ _ _ 1	0:Off, 1:On, 2:Retry 3:Waiting, 4:Lamp Error	0:Off, 4:Lamp Error
Lamp	Power Status	T P O W _ _ _ 1	1:On, 2:Cooling	0:Standby
	Quantity	T L P N _ _ _ 1	1	
	Usage Time (Hour)	T L T T _ _ _ 1	0-9999 (Integer)	
	Usage Time (Minute)	T L T M _ _ _ 1	0, 15, 30, 45	
	Life (Percentage)	T L T L _ _ _ 1	0%-100% (Integer)	
	Name	Model Name Check	T N A M _ _ _ 1	XVZ15000
Model Name Check		M N R D _ _ _ 1	XV-Z15000	
Projector Name Setting1 (First 4 characters) *1		P J N 1 * * * *		OK or ERR
Projector Name Setting2 (Middle 4 characters) *1		P J N 2 * * * *		OK or ERR
Projector Name Setting3 (Last 4 characters) *1		P J N 3 * * * *		OK or ERR
Projector Name Check		P J N 0 _ _ _ 1		Projector Name

Control Contents		Command				Parameter				Return			
										Power ON	Standby mode (or 30-second startup time)		
Input Change	Computer	I	R	G	B	--	--	--	1	OK or ERR	ERR		
	Component	I	R	G	B	--	--	--	2	OK or ERR	ERR		
	HDMI1	I	R	G	B	--	--	--	3	OK or ERR	ERR		
	HDMI2	I	R	G	B	--	--	--	4	OK or ERR	ERR		
	S-Video	I	V	E	D	--	--	--	1	OK or ERR	ERR		
	Video	I	V	E	D	--	--	--	2	OK or ERR	ERR		
	Input RGB Check	I	R	G	B	?	?	?	?	1: Computer, 2: Component, 3: HDMI1, 4: HDMI2, ERR	ERR		
	Input Video Check	I	V	E	D	?	?	?	?	1: S-Video, 2: Video, ERR	ERR		
Input Mode Check	I	M	O	D	?	?	?	?	1: RGB, 2: Video	ERR			
Input Check	I	C	H	K	?	?	?	?	1: Computer 2: Component 3: HDMI1 4: HDMI2 5: S-Video 6: Video	ERR			
Resize	Computer	Normal	R	A	S	R	--	--	--	1	OK or ERR	ERR	
		Stretch	R	A	S	R	--	--	--	2	OK or ERR	ERR	
		Dot By Dot	R	A	S	R	--	--	--	3	OK or ERR	ERR	
		Cinema Zoom	R	A	S	R	--	--	--	5	OK or ERR	ERR	
		Zoom14:9	R	A	S	R	--	--	--	7	OK or ERR	ERR	
	Component	Smart Zoom	R	A	S	R	--	--	--	6	OK or ERR	ERR	
		Normal	R	B	S	R	--	--	--	1	OK or ERR	ERR	
		Stretch	R	B	S	R	--	--	--	2	OK or ERR	ERR	
		Dot By Dot	R	B	S	R	--	--	--	3	OK or ERR	ERR	
		Cinema Zoom	R	B	S	R	--	--	--	5	OK or ERR	ERR	
	HDMI1	Zoom14:9	R	B	S	R	--	--	--	7	OK or ERR	ERR	
		Smart Zoom	R	B	S	R	--	--	--	6	OK or ERR	ERR	
		Normal	R	C	S	R	--	--	--	1	OK or ERR	ERR	
		Stretch	R	C	S	R	--	--	--	2	OK or ERR	ERR	
		Dot By Dot	R	C	S	R	--	--	--	3	OK or ERR	ERR	
	HDMI2	Cinema Zoom	R	C	S	R	--	--	--	5	OK or ERR	ERR	
		Zoom14:9	R	C	S	R	--	--	--	7	OK or ERR	ERR	
		Smart Zoom	R	C	S	R	--	--	--	6	OK or ERR	ERR	
		Normal	R	D	S	R	--	--	--	1	OK or ERR	ERR	
		Stretch	R	D	S	R	--	--	--	2	OK or ERR	ERR	
	S-Video	Dot By Dot	R	D	S	R	--	--	--	3	OK or ERR	ERR	
		Cinema Zoom	R	D	S	R	--	--	--	5	OK or ERR	ERR	
		Zoom14:9	R	D	S	R	--	--	--	7	OK or ERR	ERR	
		Smart Zoom	R	D	S	R	--	--	--	6	OK or ERR	ERR	
		Normal	R	A	S	V	--	--	--	1	OK or ERR	ERR	
	Video	Stretch	R	A	S	V	--	--	--	2	OK or ERR	ERR	
		Cinema Zoom	R	A	S	V	--	--	--	5	OK or ERR	ERR	
		Zoom14:9	R	A	S	V	--	--	--	7	OK or ERR	ERR	
		Smart Zoom	R	A	S	V	--	--	--	6	OK or ERR	ERR	
		Normal	R	B	S	V	--	--	--	1	OK or ERR	ERR	
	ALL Reset		A	L	R	E	--	--	--	1	OK or ERR	ERR	
			R	A	P	S	--	--	--	1	OK or ERR	ERR	
	Computer INPUT	Picture Mode	Natural	R	A	P	S	--	--	--	2	OK or ERR	ERR
			Dynamic	R	A	P	S	--	--	--	3	OK or ERR	ERR
			Movie1	R	A	P	S	--	--	--	4	OK or ERR	ERR
			Movie2	R	A	P	S	--	--	--	5	OK or ERR	ERR
Game			R	A	P	S	--	--	--	6	OK or ERR	ERR	
Picture Reset			R	A	R	E	--	--	--	1	OK or ERR	ERR	
Contrast		-30 - +30	R	A	P	I	--	*	*	*	OK or ERR	ERR	
Bright		-30 - +30	R	A	B	R	--	*	*	*	OK or ERR	ERR	
Color		-30 - +30	R	A	C	O	--	*	*	*	OK or ERR	ERR	
Tint		-30 - +30	R	A	T	I	--	*	*	*	OK or ERR	ERR	
Sharp		-30 - +30	R	A	S	H	--	*	*	*	OK or ERR	ERR	
Red		-30 - +30	R	A	R	D	--	*	*	*	OK or ERR	ERR	
Blue		-30 - +30	R	A	B	E	--	*	*	*	OK or ERR	ERR	
CLR Temp		-2→+2	R	A	C	T	--	*	*	*	OK or ERR	ERR	
Component INPUT		Picture Mode	Standard	R	B	P	S	--	--	--	1	OK or ERR	ERR
	Natural		R	B	P	S	--	--	--	2	OK or ERR	ERR	
	Dynamic		R	B	P	S	--	--	--	3	OK or ERR	ERR	
	Movie1		R	B	P	S	--	--	--	4	OK or ERR	ERR	
	Movie2		R	B	P	S	--	--	--	5	OK or ERR	ERR	
	Game		R	B	P	S	--	--	--	6	OK or ERR	ERR	
	Contrast	-30 - +30	R	B	P	I	--	*	*	*	OK or ERR	ERR	
	Bright	-30 - +30	R	B	B	R	--	*	*	*	OK or ERR	ERR	
	Color	-30 - +30	R	B	C	O	--	*	*	*	OK or ERR	ERR	
	Tint	-30 - +30	R	B	T	I	--	*	*	*	OK or ERR	ERR	
	Sharp	-30 - +30	R	B	S	H	--	*	*	*	OK or ERR	ERR	
	Red	-30 - +30	R	B	R	D	--	*	*	*	OK or ERR	ERR	
	Blue	-30 - +30	R	B	B	E	--	*	*	*	OK or ERR	ERR	
	CLR Temp	-2→+2	R	B	C	T	--	*	*	*	OK or ERR	ERR	
	Picture Reset		R	B	R	E	--	--	--	1	OK or ERR	ERR	

RS-232C Specifications and Commands (Continued)

Control Contents			Command				Parameter				Return	
											Power ON	Standby mode (or 30-second startup time)
HDMI1	Picture Mode	Standard	R	C	P	S	--	--	--	1	OK or ERR	ERR
		Natural	R	C	P	S	--	--	--	2	OK or ERR	ERR
		Dynamic	R	C	P	S	--	--	--	3	OK or ERR	ERR
		Movie1	R	C	P	S	--	--	--	4	OK or ERR	ERR
		Movie2	R	C	P	S	--	--	--	5	OK or ERR	ERR
		Game	R	C	P	S	--	--	--	6	OK or ERR	ERR
	Contrast	-30 - +30	R	C	P	I	--	*	*	*	OK or ERR	ERR
	Bright	-30 - +30	R	C	B	R	--	*	*	*	OK or ERR	ERR
	Color	-30 - +30	R	C	C	O	--	*	*	*	OK or ERR	ERR
	Tint	-30 - +30	R	C	T	I	--	*	*	*	OK or ERR	ERR
	Sharp	-30 - +30	R	C	S	H	--	*	*	*	OK or ERR	ERR
	Red	-30 - +30	R	C	R	D	--	*	*	*	OK or ERR	ERR
	Blue	-30 - +30	R	C	B	E	--	*	*	*	OK or ERR	ERR
	CLR Temp	-2→2	R	C	C	T	--	--	--	*	OK or ERR	ERR
	Picture Reset		R	C	R	E	--	--	--	1	OK or ERR	ERR
	HDMI2	Picture Mode	Standard	R	D	P	S	--	--	--	1	OK or ERR
Natural			R	D	P	S	--	--	--	2	OK or ERR	ERR
Dynamic			R	D	P	S	--	--	--	3	OK or ERR	ERR
Movie1			R	D	P	S	--	--	--	4	OK or ERR	ERR
Movie2			R	D	P	S	--	--	--	5	OK or ERR	ERR
Game			R	D	P	S	--	--	--	6	OK or ERR	ERR
Contrast		-30 - +30	R	D	P	I	--	*	*	*	OK or ERR	ERR
Bright		-30 - +30	R	D	B	R	--	*	*	*	OK or ERR	ERR
Color		-30 - +30	R	D	C	O	--	*	*	*	OK or ERR	ERR
Tint		-30 - +30	R	D	T	I	--	*	*	*	OK or ERR	ERR
Sharp		-30 - +30	R	D	S	H	--	*	*	*	OK or ERR	ERR
Red		-30 - +30	R	D	R	D	--	*	*	*	OK or ERR	ERR
Blue		-30 - +30	R	D	B	E	--	*	*	*	OK or ERR	ERR
CLR Temp		-2→2	R	D	C	T	--	--	--	*	OK or ERR	ERR
Picture Reset			R	D	R	E	--	--	--	1	OK or ERR	ERR
S-Video INPUT		Picture Mode	Standard	V	A	P	S	--	--	--	1	OK or ERR
	Natural		V	A	P	S	--	--	--	2	OK or ERR	ERR
	Dynamic		V	A	P	S	--	--	--	3	OK or ERR	ERR
	Movie1		V	A	P	S	--	--	--	4	OK or ERR	ERR
	Movie2		V	A	P	S	--	--	--	5	OK or ERR	ERR
	Game		V	A	P	S	--	--	--	6	OK or ERR	ERR
	Contrast	-30 - +30	V	A	P	I	--	*	*	*	OK or ERR	ERR
	Bright	-30 - +30	V	A	B	R	--	*	*	*	OK or ERR	ERR
	Color	-30 - +30	V	A	C	O	--	*	*	*	OK or ERR	ERR
	Tint	-30 - +30	V	A	T	I	--	*	*	*	OK or ERR	ERR
	Sharp	-30 - +30	V	A	S	H	--	*	*	*	OK or ERR	ERR
	Red	-30 - +30	V	A	R	D	--	*	*	*	OK or ERR	ERR
	Blue	-30 - +30	V	A	B	E	--	*	*	*	OK or ERR	ERR
	CLR Temp	-2→2	V	A	C	T	--	--	--	*	OK or ERR	ERR
	Picture Reset		V	A	R	E	--	--	--	1	OK or ERR	ERR
	Video INPUT	Picture Mode	Standard	V	B	P	S	--	--	--	1	OK or ERR
Natural			V	B	P	S	--	--	--	2	OK or ERR	ERR
Dynamic			V	B	P	S	--	--	--	3	OK or ERR	ERR
Movie1			V	B	P	S	--	--	--	4	OK or ERR	ERR
Movie2			V	B	P	S	--	--	--	5	OK or ERR	ERR
Game			V	B	P	S	--	--	--	6	OK or ERR	ERR
Contrast		-30 - +30	V	B	P	I	--	*	*	*	OK or ERR	ERR
Bright		-30 - +30	V	B	B	R	--	*	*	*	OK or ERR	ERR
Color		-30 - +30	V	B	C	O	--	*	*	*	OK or ERR	ERR
Tint		-30 - +30	V	B	T	I	--	*	*	*	OK or ERR	ERR
Sharp		-30 - +30	V	B	S	H	--	*	*	*	OK or ERR	ERR
Red		-30 - +30	V	B	R	D	--	*	*	*	OK or ERR	ERR
Blue		-30 - +30	V	B	B	E	--	*	*	*	OK or ERR	ERR
CLR Temp		-2→2	V	B	C	T	--	--	--	*	OK or ERR	ERR
Picture Reset			V	B	R	E	--	--	--	1	OK or ERR	ERR
RGB Frequency Check		Horizontal		T	F	R	Q	--	--	--	1	kHz (***.* or ERR)
	Vertical		T	F	R	Q	--	--	--	2	Hz (***.* or ERR)	ERR
Lamp Timer Reset *2		L	P	R	E	0	0	0	1	ERR	OK, ERR	

Note

- If an underbar (_) appears in the parameter column, enter a space. If an asterisk (*) appears, enter a value in the range indicated in brackets under CONTROL CONTENTS.

¹ For setting the projector name, send the commands in order of PJN1, PJN2 and PJN3.

² The Lamp Timer Reset command can only be sent in standby mode.

Computer Compatibility Chart

Computer

- Multiple signal support
Horizontal Frequency: 15–110 kHz, Vertical Frequency: 43–85 Hz, Pixel Clock: 12–170 MHz
- Compatible with sync on green and composite sync signals (TTL level)

PC/MAC	Mode	Resolution	Horizontal frequency [kHz]	Vertical frequency [Hz]	Analog Support	Digital Support	Display	
PC	VGA	640 × 400	27.0	60	✓		Upscale	
			31.5	70	✓			
			37.9	85	✓			
		720 × 400	27.0	60		✓		
			31.5	70		✓		
			37.9	85		✓		
			26.2	50		✓		
			31.5	60		✓		✓
			34.7	70		✓		✓
	640 × 480	37.9	72		✓	✓		
		37.5	75		✓	✓		
		43.3	85		✓	✓		
		31.3	50		✓			
		35.2	56		✓	✓		
		37.9	60		✓	✓		
		46.6	70		✓	✓		
		48.1	72		✓	✓		
		46.9	75		✓	✓		
	SVGA	800 × 600	53.7	85		✓		✓
			40.3	50		✓		
			48.4	60		✓		✓
			56.5	70		✓		✓
			60.0	75		✓		✓
			68.7	85		✓		✓
			45.0	60		✓		✓
			47.8	60		✓		✓
			49.7	60		✓		✓
	WXGA	1280 × 720	47.7	60		✓		
			47.8	60		✓		
			47.8	60		✓		
47.8			60		✓			
WXGA+	1440 × 900	55.9	60		✓			
		55.0	60		✓	✓		
SXGA	1152 × 864	66.2	70		✓			
		67.5	75		✓	✓		
		60.0	60		✓	✓		
SXGA+	1280 × 960	64.0	60		✓	✓		
		64.0	60		✓	✓		
		64.0	60		✓	✓		
SXGA+	1400 × 1050	65.3	60		✓	✓		
		65.3	60		✓	✓		
		65.3	60		✓	✓		
WSXGA+	1600 × 900	55.9	60		✓	✓		
		65.3	60		✓	✓		
		66.8	60		✓	✓		
		66.8	60		✓	✓		
MAC 13"	VGA	640 × 480	67.5	60	✓	✓	Down sampled Intelligent Compression	
			34.9	67	✓			
MAC 16"	SVGA	832 × 624	49.7	75	✓		Upscale	
MAC 19"	XGA	1024 × 768	60.2	75	✓			
MAC 21"	XGA	1024 × 768	60.2	75	✓			
MAC 21"	SXGA	1152 × 870	68.7	75	✓			

*1 When a 1920 × 1080 analog signal is input, the image is compressed before it is displayed on the screen.

*2 Full image display when “Resolution” is set to “1920 × 1080”



Note

- This projector may not be able to display images from notebook computers in simultaneous (CRT/LCD) mode. Should this occur, turn off the LCD display on the notebook computer and output the display data in “CRT only” mode. Details on how to change display modes can be found in your notebook computer’s operation manual.
- When “Screen resolution” of the computer is different from the resolution displayed on the projected image, follow the procedures shown below.
 - Refer to “Resolution” on the “SIG-ADJ” menu and select the same resolution as the resolution in “Screen resolution” of the computer.
 - Depending on the computer you are using, the output signal may not be faithful to the “Screen resolution” adjustment. Check the settings of the computer’s signal output. If the settings cannot be changed, it is recommended that the resolution be set to “1920 × 1080” or “1280 × 720”.

DTV

Signal	Horizontal Frequency (kHz)	Vertical Frequency (Hz)	Analog Support	Digital Support	Signal	Horizontal Frequency (kHz)	Vertical Frequency (Hz)	Analog Support	Digital Support
480I	15.7	60	✓		1080I	28.1	50	✓	✓
480P	31.5	60	✓	✓	1080I	33.8	60	✓	✓
540P	33.8	60	✓		1080P	27.0	24		✓
576I	15.6	50	✓		1080P	28.1	25		✓
576P	31.3	50	✓	✓	1080P	33.8	30		✓
720P	37.5	50	✓	✓	1080P	56.3	50	✓	✓
720P	45.0	60	✓	✓	1080P	67.5	60	✓	✓

Troubleshooting

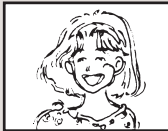
Problem	Check	Page
 <p>No picture or projector does not start</p>	<ul style="list-style-type: none"> • Projector power cord is not plugged into the wall outlet. 	22
	<ul style="list-style-type: none"> • Power to the external connected devices is off. 	–
	<ul style="list-style-type: none"> • The lens shutter is closed. 	22, 27
	<ul style="list-style-type: none"> • The selected input mode is wrong. 	26, 40, 41
	<ul style="list-style-type: none"> • Cables are incorrectly connected to the projector. 	18-22
	<ul style="list-style-type: none"> • Remote control battery has run out. 	12
	<ul style="list-style-type: none"> • External output has not been set when connecting notebook computer. 	–
	<ul style="list-style-type: none"> • The lamp unit cover is not installed correctly. 	51, 52
	<ul style="list-style-type: none"> • The selected “Signal Type” is wrong. 	40
	<ul style="list-style-type: none"> • The video signal format of the video equipment is not set correctly. 	41
 <p>Color is faded or poor.</p>	<ul style="list-style-type: none"> • “Bright” is set to minimum position. 	36
	<ul style="list-style-type: none"> • Image adjustments are incorrectly set. 	36
	(S-VIDEO or VIDEO input) <ul style="list-style-type: none"> • Video input system is incorrectly set. 	41
	(COMPONENT, COMPUTER/COMPONENT or HDMI1, 2 input) <ul style="list-style-type: none"> • Input signal type is incorrectly set. 	40
 <p>Picture is blurred; noise appears.</p>	<ul style="list-style-type: none"> • Adjust the focus. 	23
	<ul style="list-style-type: none"> • The projection distance exceeds the focus range. 	17
	(Computer input) <ul style="list-style-type: none"> • Perform “SIG-ADJ” Adjustments (“Clock” Adjustment) • Perform “SIG-ADJ” Adjustments (“Phase” Adjustment) • Noise may appear depending on the computer. 	40 40 –
	<ul style="list-style-type: none"> • The “DNR” (Digital Noise Reduction) or “MNR” (Mosquito Noise Reduction) setting is not correct. 	39
	<ul style="list-style-type: none"> • There is fog on the lens. If the projector is carried from a cold room into a warm room, or if it is suddenly heated, condensation may form on the surface of the lens and the image will become blurred. Please set up the projector at least one hour before it is to be used. If condensation should form, remove the power cord from the wall outlet and wait for it to clear. 	–
<p>An unusual sound is occasionally heard from the cabinet.</p>	<ul style="list-style-type: none"> • If the picture is normal, the sound is due to cabinet shrinkage caused by a room temperature changes. This will not affect operation or performance. 	–
<p>Maintenance indicator on the projector illuminates.</p>	<ul style="list-style-type: none"> • See “Maintenance Indicators”. 	48
<p>Picture is green when receiving component signals and the video equipment is connected to the COMPONENT or COMPUTER/COMPONENT terminal on the projector.</p>	<ul style="list-style-type: none"> • Change the input signal type setting. 	40
<p>Picture is pink when receiving RGB signals and the video equipment is connected to the COMPONENT or COMPUTER/COMPONENT terminal on the projector.</p>		
<p>The black levels of the image show banding or appear faded when HDMI1 or 2 is selected.</p>	<ul style="list-style-type: none"> • Make adjustments that result in the best picture quality in the “Dynamic Range” setting. 	41
<p>Picture is too bright and whitish.</p>	<ul style="list-style-type: none"> • Image adjustments are incorrectly set. 	36

Problem	Check	Page
The cooling fan becomes noisy.	<ul style="list-style-type: none"> When temperature inside the projector increases, the cooling fan runs faster. 	–
The lamp does not light up even after the projector turns on.	<ul style="list-style-type: none"> The lamp indicator is illuminating in red. Replace the lamp. The lens shutter is opened fully. 	22, 48, 51
The lamp suddenly turns off during projection.		
The image sometimes flickers.	<ul style="list-style-type: none"> Cables are incorrectly connected to the projector or the connected equipment works improperly. If this happens frequently, replace the lamp. 	18-21
		51
The lamp needs much time to turn on.	<ul style="list-style-type: none"> The lamp will eventually need to be changed. While the remaining lamp life draws to a close, replace the lamp. 	51
Picture is dark.		
One Touch Play is not enabled.	<ul style="list-style-type: none"> Non-Sharp Video Products are connected. One Touch Play function may not work when the projector is connected to non-Sharp Video Products. 	45
	<ul style="list-style-type: none"> An HDMI cable is not used for connection between the projector and the Sharp Video Products. One Touch Play function is enabled when the projector is connected to the Sharp Video Products with an HDMI cable. 	19
	<ul style="list-style-type: none"> One Touch Play function of the projector is not set to “On”. 	45
	<ul style="list-style-type: none"> CEC settings of connected Sharp Video Products or other CEC devices are incorrect. 	–
	<ul style="list-style-type: none"> One Touch Play is set to “Off” and disabled when the Economy mode is set to “On”. 	45
System Standby is not enabled.	<ul style="list-style-type: none"> Non-Sharp Video Products are connected. System Standby function may not work when the projector is connected to non-Sharp Video Products. 	45
	<ul style="list-style-type: none"> An HDMI cable is not used for connection between the projector and the Sharp Video Products. System Standby function is enabled when the projector is connected to the Sharp Video Products with an HDMI cable. 	19
	<ul style="list-style-type: none"> System Standby function of the projector is not set to “On”. 	45
	<ul style="list-style-type: none"> CEC settings of connected Sharp Video Products or other CEC devices are incorrect. 	–
A response code cannot be received when the projector was attempted to be controlled using RS-232C commands from a computer during standby.	<ul style="list-style-type: none"> In the case of transmitting RS-232C commands from a computer during standby, it takes a maximum of 30 seconds for the computer to receive the response code. Set the response code waiting time of the computer to 30 seconds or more. 	54
The remote control cannot be used.	<ul style="list-style-type: none"> Operate the remote control while pointing it at the projector’s remote control sensor. The remote control may be too far away from the projector. If direct sunlight or a strong fluorescent light is shining on the projector’s remote control sensor, place the projector where it will not be affected by strong light. 	12
		12
12		
	<ul style="list-style-type: none"> The batteries may be depleted or inserted incorrectly. Make sure the batteries are inserted correctly or insert new ones. 	12

This unit is equipped with a microprocessor. Its performance could be adversely affected by incorrect operation or interference. If this should happen, unplug the unit and plug it in again after more than 5 minutes.



For SHARP Assistance

If you encounter any problems during setup or operation of this projector, first refer to the “Troubleshooting” section on pages 58 and 59. If this operation manual does not answer your question, please contact the SHARP Service departments listed below.

U.S.A.	Sharp Electronics Corporation 1-888-GO-SHARP (1-888-467-4277) lcdsupport@sharpsec.com http://www.sharppusa.com	Benelux	SHARP Electronics Benelux BV 0900-SHARPCE (0900-7427723) Nederland 9900-0159 Belgium http://www.sharp.nl http://www.sharp.be http://www.sharp.lu
Canada	Sharp Electronics of Canada Ltd. (905) 568-7140 http://www.sharp.ca	Australia	Sharp Corporation of Australia Pty. Ltd. 1300-135-022 http://www.sharp.net.au
Mexico	Sharp Electronics Corporation Mexico Branch (525) 716-9000 http://www.sharp.com.mx	New Zealand	Sharp Corporation of New Zealand Phone: (09) 573-0111 Fax: (09) 573-0112 http://www.sharp.net.nz
Latin America	Sharp Electronics Corp. Latin American Group (305) 264-2277 www.servicio@sharpsec.com http://www.siemprisharp.com	Singapore	Sharp-Roxy Sales (S) Pte. Ltd. 65-226-6556 ckng@srs.global.sharp.co.jp http://www.sharp.com.sg
Germany	Sharp Electronics (Europe) GMBH 01805-234675 http://www.sharp.de	Hong Kong	Sharp-Roxy (HK) Ltd. (852) 2410-2623 dcmktg@srh.global.sharp.co.jp http://www.sharp.com.hk
U.K.	Sharp Electronics (U.K.) Ltd. 08705 274277 http://www.sharp.co.uk/customer-support	Taiwan	Sharp Corporation (Taiwan) 0800-025111 http://www.sharp-scot.com.tw
Italy	Sharp Electronics (Italy) S.P.A. (39) 02-89595-1 http://www.sharp.it	Malaysia	Sharp-Roxy Sales & Service Co. (60) 3-5125678
France	Sharp Electronics France 01 49 90 35 40 hotlineced@sef.sharp-eu.com http://www.sharp.fr	U.A.E.	Sharp Middle East Fze 971-4-81-5311 helpdesk@smef.global.sharp.co.jp
Spain	Sharp Electronica Espana, S.A. 93 5819700 sharpplcd@sees.sharp-eu.com http://www.sharp.es	Thailand	Sharp Thebnakorn Co. Ltd. 02-236-0170 svc@stcl.global.sharp.co.jp http://www.sharp-th.com
Switzerland	Sharp Electronics (Schweiz) AG 0041 1 846 63 11 cattaneo@sez.sharp-eu.com http://www.sharp.ch	Korea	Sharp Electronics Incorporated of Korea (82) 2-3660-2002 lcd@sharp-korea.co.kr http://www.sharpkorea.co.kr
Sweden	Sharp Electronics (Nordic) AB (46) 8 6343600 vision.support@sen.sharp-eu.com http://www.sharp.se	India	Sharp Business Systems (India) Limited (91) 11- 6431313 service@sharp-oa.com
Austria	Sharp Electronics (Europe) GMBH Branch Office Austria 0043 1 727 19 123 pogats@sea.sharp-eu.com http://www.sharp.at		

Specifications

Model		XV-Z15000
Display devices		0.65" DLP® Chip × 1
Resolution		1080P (1920 × 1080)
Lens	F number	F 2.5 – 2.7
	Zoom	Manual, ×1.15 (f = 21.0 – 24.2 mm)
	Focus	Manual
Input terminals	HDMI	× 2
	Computer/Component (mini D-sub 15 pin)	× 1
	Component (3RCA)	× 1
	S-Video (mini DIN 4 pin)	× 1
	Video (RCA)	× 1
Control and communication terminals	RS-232C (mini D-sub 9 pin)	× 1
Projection lamp		250 W
Rated voltage		AC 100 – 240V
Rated frequency		50/60 Hz
Input current		3.7 A
Power consumption (Standby)		353 W (7.6 W) with AC 100 V 339 W (8.3 W) with AC 240 V
Operation temperature		41°F to 95°F (+5°C to +35°C)
Cabinet		Plastic
Dimensions (main body only) [W × H × D]		15 ³ / ₄ " × 3 ¹⁵ / ₁₆ " × 13 ¹³ / ₆₄ " (400 × 100 × 335 mm)
Weight (approx.)		12.8 lbs. (5.8 kg)

As a part of policy of continuous improvement, SHARP reserves the right to make design and specification changes for product improvement without prior notice. The performance specification figures indicated are nominal values of production units. There may be some deviations from these values in individual units.

Dimensions

Units: inches (mm)

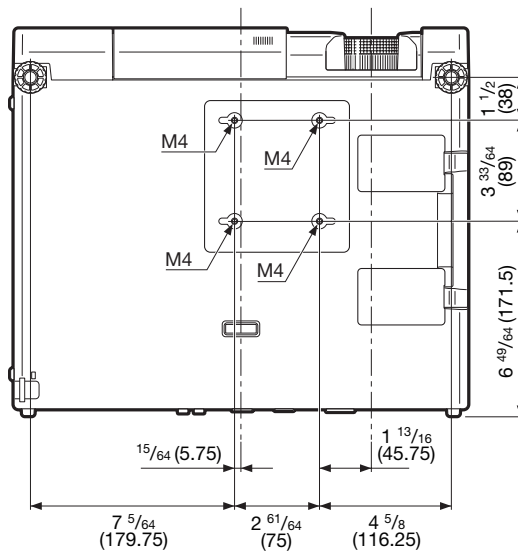
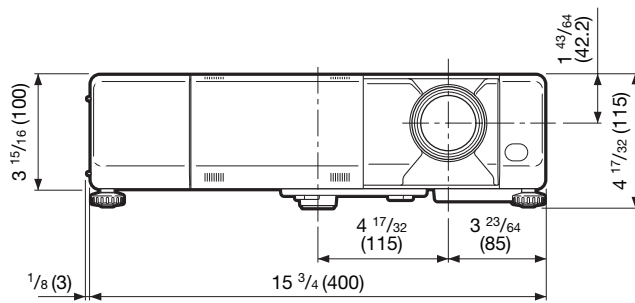
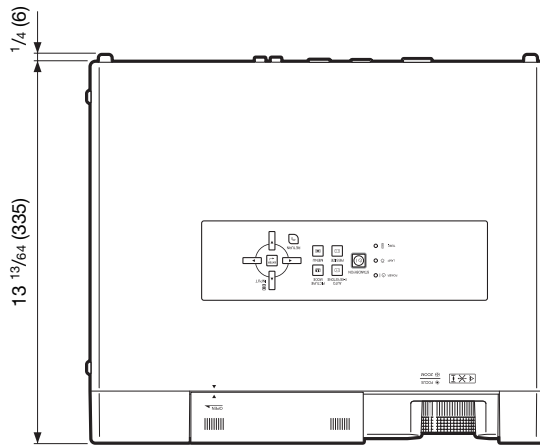

Index

Accessories	8	MAGNIFY buttons	28
AC socket	22	MENU HIDE button	28
Adjustment buttons	34	MENU button	34
Adjustment feet	23	MNR	39
Advanced	37	Movie1, 2	36
All Reset	46	Natural	36
Auto Power Off	45	ON button	22
Auto Sync	40	One Touch Play	45
AUTO SYNC button	27	On-screen Display	44
AUTO V-KEystone button	25	Optional accessories	8
Background	44	OSD Brightness	44
Batteries	12	Overscan	42
Bright	36	Phase	40
Bright Boost	39	Picture	36
Carrying handle	10	Picture Mode	36
Ceiling-mount setup	16	PICTURE MODE button	27
CINEMA ZOOM	29	Power cord	8, 22
Clock	40	Power indicator	22, 48
CLR Temp (Color Temperature)	36	PRJ-ADJ	45
C.M.S.	37	PRJ mode	16, 44
Color	36	Remote control	11
COMPONENT button	26	Remote control sensors	12
COMPONENT terminal	18	Replacing the lamp	50
COMPUTER button	26	RESIZE button	29
COMPUTER/COMPONENT terminal	18, 20	RETURN button	34
Contrast	36	Rotation	25, 44
Detail Enhance	39	RS-232C	46
DNR	39	RS-232C terminal	21
DOT BY DOT	30	Saturation	38
Dynamic	36	SCR-ADJ	42
Dynamic Range	41	Screen Size and Projection Distance	17
Economy Mode	45	Security bar	10
ECO+QUIET button	28	Select Color	38
Effect	38	Sharp	36
ENTER button	34	SIG-ADJ	40
Fan Mode	46	Signal Info	41
Film Mode	39	Signal Type	40
Focus ring	23	SMART ZOOM	30
FREEZE button	27	Sphere	25, 43
Game	36	Standard	36
Gamma	37	STANDBY button	22
HDMI1, 2 buttons	26	STANDBY/ON button	22
HDMI1, 2 terminals	18, 19	STRETCH	29
HEIGHT ADJUST lever	23	S-VIDEO button	26
H-Image Shift	26, 42	S-VIDEO terminal	18, 19
H-Pos	40	System Standby	45
Hue	38	Temperature warning indicator	48
IMAGE SHIFT button	26	Tint	36
INPUT button	26	Value	38
Input Name	46	VIDEO button	26
IRIS1, 2	37	Video Setup	41
IRIS1, 2 buttons	28	Video System	41
Kensington Security Standard connector	10	VIDEO terminal	18
KEystone button	24	V-Image Shift	26, 42
Lamp indicator	48	V-Pos	40
Lamp Timer (Life)	46	ZOOM 14:9	30
Language (on-screen display language)	44	Zoom ring	23
Lens shutter	22, 27, 51		

SHARP®

SHARP CORPORATION

Printed in China
Imprimé en Chine
Impreso en China
Impresso na China
TINS-E012WJZZ
09P01-CH-NM

Free Manuals Download Website

<http://myh66.com>

<http://usermanuals.us>

<http://www.somanuals.com>

<http://www.4manuals.cc>

<http://www.manual-lib.com>

<http://www.404manual.com>

<http://www.luxmanual.com>

<http://aubethermostatmanual.com>

Golf course search by state

<http://golfingnear.com>

Email search by domain

<http://emailbydomain.com>

Auto manuals search

<http://auto.somanuals.com>

TV manuals search

<http://tv.somanuals.com>