

SHARP

COMMERCIAL MICROWAVE OVEN

J

MODEL R-1900J

OPERATION MANUAL AND COOKING GUIDE

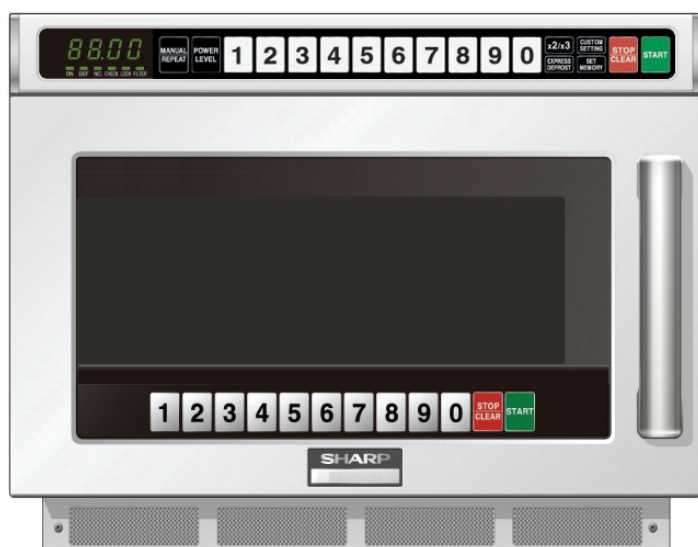

CONTENTS

Page

Warning	1
Special Notes and Warnings	2
Installation Instructions	3
Oven Diagram	4
Operation of Touch Control Panel	5
Before Operation	5
Memory Operation	5
Memory Cooking	5
Cooking Double / Triple Quantity with Memory	6
Express Defrost with Memory	7
Manual Operation	7
Single Stage Cooking	7
Multi Stage Cooking	7
Repeat Cooking	8
Express Defrost	8
Express Defrost Chart	8
Programme and Customise	9
Custom Setting	9
Saving Memories	15
Maximum Cooking Time	19
Other Convenient Features	19
Demonstration Mode	19
Monitor	19
Error Mode	19
Maintenance Mode	20
Care and Cleaning	20
Service Call Check	22
Specifications	22
Helpful Hints	23
Cookware and Utensil Guide	23
Charts	24
Warranty	31



WARNING

IMPORTANT SAFETY INSTRUCTIONS : READ CAREFULLY AND KEEP FOR FUTURE REFERENCE.

To reduce the risk of fire in the oven cavity:

- a. Do not overcook food.
- b. Remove wire twist-ties from paper or plastic bags before placing bag in the oven.
- c. Do not heat oil or fat for deep frying. The temperature of the oil cannot be controlled.
- d. Look at the oven from time to time when food is heated in disposable containers made of plastic, paper or other combustible materials for signs of smoke or burning.
- e. If materials inside the oven should ignite, or smoke is observed, keep oven door closed, turn oven off, and disconnect the power plug, or shut off power at the fuse or circuit breaker panel.

To reduce the risk of an explosion or delayed eruptive boiling when handling the container.

Your microwave oven is capable of heating food and beverages very quickly therefore, it is very important that you select the appropriate cooking time and power level for the type and quantity of food to be heated. If you are unsure of the cooking time and power level required, begin with low cooking times and power levels until the food is sufficiently heated evenly throughout.

Additionally:

- a. Do not place sealed containers in the oven. Babies bottles fitted with a screw cap or teat are considered to be sealed containers.
- b. Do not use excessive amount of time.
- c. When boiling liquids in the oven, use a wide-mouthed container.
- d. Stand at least for 20 seconds at the end of cooking to avoid delayed eruptive boiling of liquids.
- e. Stir the liquid before and during cooking. Use extreme care when handling the container or inserting a spoon or other utensil into the container.

This oven is for food preparation only and should only be used for heating, cooking and defrosting food and beverage.

It is not suitable for industrial, laboratory use, or heating therapeutic devices eg. Wheat bags.

Never operate the oven whilst any object is caught or jammed between the door and the oven.

Do not try to adjust or repair the oven yourself.

It is hazardous for anyone other than a qualified service technician trained by SHARP to carry out any service or repair operation. Especially those which involve the removal of a cover which gives protection against exposure to microwave energy are very hazardous.

Do not operate the oven if it is not working correctly or damaged until it has been repaired by a qualified service technician trained by SHARP. It is particularly important that the oven door closes properly and that there is no damage to:

(1) Door (warped), (2) Hinges and Latches (broken or loosened), (3) Door Seals, Sealing Surfaces and oven cavity (buckled or deformed), (4) Burn marks on the door seal faces.

Do not bump, or catch utensils, loose clothes and your accessories on the door safety latches when removing food from the oven.

Never poke an object, particularly a metal object, through a grille or between the door and the oven while the oven is operating.

Never tamper with or deactivate the door safety latches.

Always use oven gloves to prevent burns when handling utensils that are in contact with hot food. Enough heat from the food can transfer through utensils to cause skin burns.

Should the power supply cord become damaged, it must be replaced with a special cord supplied by a SERVICE CENTRE APPROVED BY SHARP. And it must be replaced by a qualified service technician trained by SHARP in order to avoid a hazard.

Avoid steam burns by directing steam away from the face and hands.

Slowly lift the furthest edge of a dish's cover including microwave plastic wrap etc., and carefully open popcorn and oven cooking bags away from the face.

Make sure that the power supply cord is undamaged, and that it does not run under the oven or over any hot surfaces or sharp edges.

Do not place anything on the outer cabinet.

Do not store food or any other items inside the oven.

Make sure the utensil does not touch the interior walls during cooking.

Only allow children to use the oven without supervision when adequate instructions have been given so that the child is able to use the oven in a safe way and understands the hazards of improper use.

This appliance is not intended for use by young children or infirm persons without supervision.

This appliance is not intended for use by persons (including children) with reduced physical, sensory or mental capabilities, or lack of experience and knowledge, unless they have been given supervision or instruction concerning use of the appliance by a person responsible for their safety.

Children should be supervised to ensure that they do not play with the appliance.

Do not use the oven near the steamer and fryer.

Individuals with PACEMAKERS should check with their doctor or the manufacturer of the pacemaker for precautions regarding microwave ovens.



SPECIAL NOTES AND WARNINGS

	DO	DON'T
Eggs, fruits, nuts, seeds, vegetables, sausages and oysters	<ul style="list-style-type: none"> * Puncture egg yolks and whites and oysters before cooking to prevent "explosion". * Pierce skins of potatoes, apples, squash, hot dogs, sausages and oysters so that steam escapes. 	<ul style="list-style-type: none"> * Cook eggs in shells. This prevents "explosion", which may damage the oven or injure yourself. * Cook hard/soft boiled eggs. * Overcook oysters. * Dry nuts or seeds in shells.
Popcorn	<ul style="list-style-type: none"> * Use specially bagged popcorn for the microwave oven. * Listen while popping corn for the popping to slow to 1-2 seconds. 	<ul style="list-style-type: none"> * Pop popcorn in regular brown bags or microwave safe glass bowls. * Exceed maximum time on popcorn package.
Baby food	<ul style="list-style-type: none"> * Transfer baby food to small dish and heat carefully, stirring often. Check for suitable temperature to prevent burns. * Remove the screw cap and teat before warming baby bottles. After warming shake thoroughly. Check for suitable temperature. 	<ul style="list-style-type: none"> * Heat disposable bottles. * Overheat baby bottles. Only heat until warm. * Heat bottles with nipples on. * Heat baby food in original jars.
General	<ul style="list-style-type: none"> * Food with filling should be cut after heating, to release steam and avoid burns. * Use a deep microwave safe glass bowl when cooking liquids or cereals to prevent boiling over. 	<ul style="list-style-type: none"> * Heat or cook in closed glass jars or air tight containers. * Deep fat fry. * Heat or dry wood, herbs, wet papers, clothes or flowers. * Operate the oven without a load (i.e. an absorbing material such as food or water) in the oven cavity.
Liquids (Beverages)	<ul style="list-style-type: none"> * For boiling or cooking liquids see WARNING on page 1 to prevent explosion and delayed eruptive boiling. 	<ul style="list-style-type: none"> * Heat for longer than recommended time.
Canned foods	<ul style="list-style-type: none"> * Remove food from can. 	<ul style="list-style-type: none"> * Heat or cook food while in cans.
Sausage rolls, Pies, Christmas pudding	<ul style="list-style-type: none"> * Cook for the recommended time. (These foods have high sugar and/or fat contents.) 	<ul style="list-style-type: none"> * Overcook as they may catch fire.
Meats	<ul style="list-style-type: none"> * Use a microwave proof roasting rack to collect drained juices. 	<ul style="list-style-type: none"> * Place meat directly on the ceramic shelf for cooking.
Utensils	<ul style="list-style-type: none"> * Check the utensils are suitable for MICROWAVE cooking before you use them. 	<ul style="list-style-type: none"> * Use metal utensils for MICROWAVE cooking. Metal reflects microwave energy and may cause an electrical discharge known as arcing.
Aluminium foil	<ul style="list-style-type: none"> * Use to shield food to prevent over cooking. * Watch for sparking. Reduce foil or keep clear of cavity walls. 	<ul style="list-style-type: none"> * Use too much. * Shield food close to cavity walls. Sparking can damage the cavity.
Browning dish	<ul style="list-style-type: none"> * Place a suitable insulator such as a microwave and heat proof dinner plate between the ceramic shelf and the browning dish. 	<ul style="list-style-type: none"> * Exceed the preheating time recommended by the manufacturer. Excessive preheating can cause the glass turntable to shatter and/or damage internal parts of the oven.



INSTALLATION INSTRUCTIONS

1. Remove all packing materials from the oven cavity. Remove the protective film (blue film) from the outer case cabinet. Check the unit for any damage, such as a misaligned door, damaged door seals around the door or dents inside the oven cavity or on the door. If there is any damage, please do not operate the oven until it has been checked by a SERVICE CENTRE APPROVED BY SHARP and repaired, if necessary.
2. Accessories provided
 - 1) Operation manual
 - 2) Touch guide
 - 3) Caution sheet (SPECIAL INSTRUCTIONS AND WARNINGS: part code TCAUHA276WRRZ)

3. Place oven on a secure, level surface, strong enough to take the oven weight, plus the heaviest item likely to be cooked in the oven.

4. The oven should not be installed in any area where excessive heat and steam are generated, for example, next to a conventional oven unit.

The oven should be installed so as not to block ventilation openings.

Allow at least 25 cm on the top, 10 cm on the both sides of the oven for free air space. This applies for both single and two ovens stacked.

When installing in a cabinet, the minimum inside dimension of the cabinet should be as follows. For single : 645 mm (W) x 596 mm (H) x 573 mm (D). For two ovens stacked : 645 mm (W) x 942 mm (H) x 573 mm (D). This oven is not designed for built-in installation.

WARNING: The electrical outlet must be readily accessible so that the unit can be unplugged easily in an emergency.

5. Neither the manufacturer nor the distributors can accept any liability for damage to the machine or personal injury for failure to observe the correct electrical connecting procedure.

The A.C. voltage must be single phase 230-240V, 50Hz.

6. It is recommended that a separate circuit serving only this appliance be provided.

7. This appliance must be earthed.

8. Operate the oven from a general purpose outlet.

If a generator is used, do not operate the oven with non-sinusoidal outputs.

9. **STACKING PROCEDURE FOR TWO MICROWAVE OVENS**

Two units can be installed together by placing one on top of the other. Follow these instructions:

A. Place oven A in the desired location. Position oven B on top of oven A as shown in the figure.

B. Remove screws (a) and mounting plate A and B from the right side of the back of oven A and B.

C. Replace screws (a) removed at step B and tighten them.

D. Remove screws (b), (c), (d), and (e) and then install mounting plate A and B which were removed at step B to the each lower edge of oven B as shown in the figure.

E. Replace screws (b), (c), (d), and (e) which were removed at step D and tighten them.

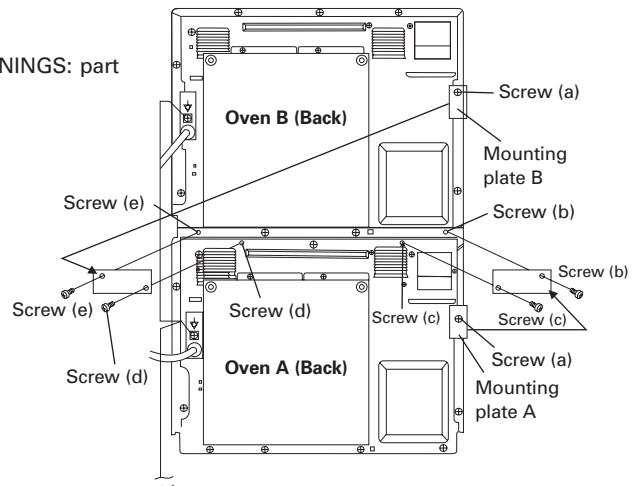

WARNING:

When two ovens are installed together by placing one on top of another:

1. Always use two mounting plates.
2. Make sure that the power supply cords are not caught between the ovens.
3. Do not install more than one oven on top of another.
4. Do not lose the removed screws.

NOTE: External Equipotential Earthing Terminal

Equipment has secondary earthing terminal.

Terminal provides external earthing connection used in addition to earthing prong on plug.

Located on outside of oven back, terminal is marked with symbol shown on the right side.





OVEN DIAGRAM

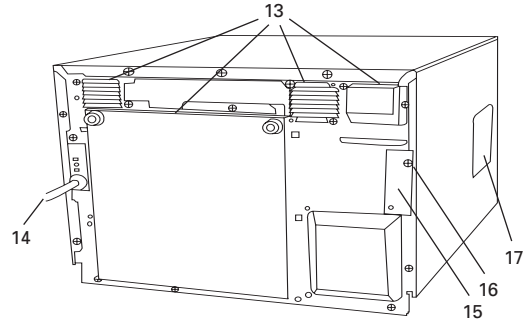
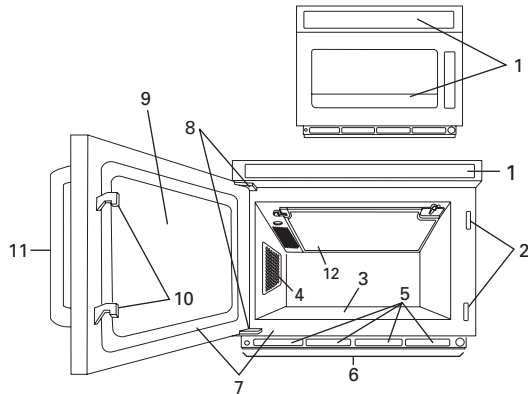

- 1. Touch control panels
- 2. Door latch openings
- 3. Ceramic shelf
- 4. Oven lamp
- 5. Air intake openings
- 6. Air intake filter
- 7. Door seals and sealing surfaces
- 8. Door hinges
- 9. Oven door with see-through window

- 10. Door latches
- 11. Door handle
- 12. Splash cover
- 13. Ventilation openings
- 14. Power supply cord
- 15. Mounting plate
- 16. Screw for mounting plate
- 17. Access cover for oven lamp replacement

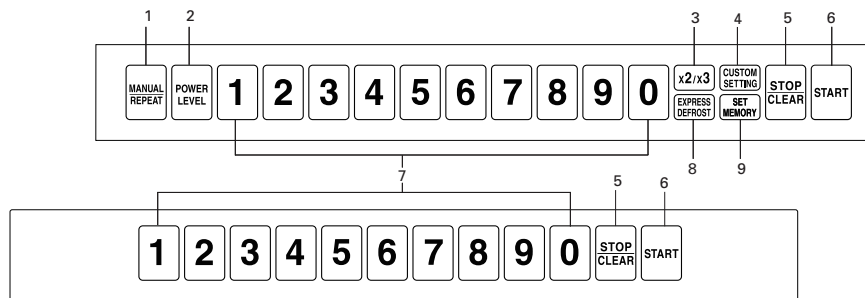

- 1. MANUAL/REPEAT pad
- 2. POWER LEVEL pad
- 3. DOUBLE/TRIPLE QUANTITY pad
- 4. CUSTOM SETTING pad
- 5. STOP/CLEAR pad

- 6. START pad
- 7. Ten number pads
- 8. EXPRESS DEFROST pad
- 9. SET MEMORY pad

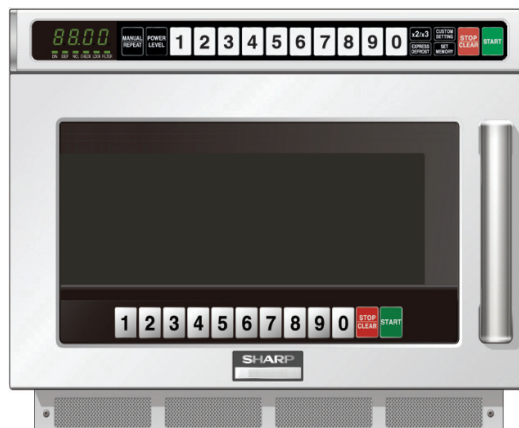
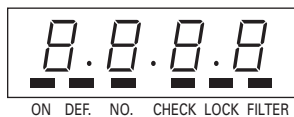



OPERATION OF TOUCH CONTROL PANEL

Before Operation

- * Before operating your new oven, make sure you read and understand this operation manual completely.
- 1) Plug in the oven. Nothing will appear in the display at this time.
- 2) Open the door. The display shows "0".
- 3) Close the door.
- 4) Control panels can only be operated when the door is closed.
- 5) Your oven has 3 ways to select memory numbers. See CUSTOM SETTING 1. To Set Input Method on page 9. The factory setting is Dual digit Input .

Cancellation:

1. Cooking data is canceled when keys are not pressed for more than three minutes when setting programming.
2. Cooking stops when the STOP/CLEAR pad is pressed and cooking data remains. However if subsequent keys are not

- pressed within three minutes, cooking data will be canceled. To resume cooking press the START pad.
3. Cooking stops when the door is opened and cooking data remains. However once the door is closed, cooking data will be canceled if subsequent keys are not pressed within 3 minutes. To resume cooking press the START pad.
 4. Cooking is immediately canceled by pressing the STOP/CLEAR pad twice.

Checking food:

Press the STOP/CLEAR pad then open the door, check food, close the door and press the START pad to continue cooking.

Cooking Completion:

When food is not taken out after cooking completion, "End" will be shown in the display until the food is taken out.

If you do not operate the oven for 3 minutes or more (i.e. closing the door or pressing the **STOP** key), your oven will automatically shut down, so you will not be able to operate the oven until you open and close the oven door.

NOTE : When you set Demonstration mode or while cooking fan work after cooking, your oven will not shut down automatically.

HELPFUL TIPS for the Memory Input Method

The Memory Input Method determines how to input memory numbers for Memory Cooking and Custom Setting and Saving Memories, therefore follow the method below. Refer to HELPFUL TIPS below as well as to Memory Cooking below.

1. **Dual Digit Input:** Must input two numbers to select a memory, even though the first number is 0. Memory programming is limited to 0 - 99.
2. **Single Digit Input:** Can only input one number to select a memory. Memory programming is limited to 0 - 9.
3. **Repeat Digit Input:** Input one, two, or three numbers to select a memory. Memory programming is limited to 0 - 29.
4. For Repeat Digit Input/Auto Start ON only, push number pads within one second of the previous number.
5. Regardless of input method selected, Counter Check/Clear (Custom Setting 7) and Multiplication Factors for Double/Triple Quantity (Custom Setting 10) only use the Dual Digit Input method. As for Custom Setting 10, enter memory number after pressing the DOUBLE/TRIPLE QUANTITY pad.

The Memory Input Method

Memory No. Examples	0	2	12	22
Dual Digit Input	0, 0	0, 2	1, 2	2, 2
Single Digit Input	0	2		
Repeat Digit Input	0	2	2, 2	2, 2, 2

MEMORY OPERATION

Memory Cooking

- * Your oven has 100 memory banks from 0 to 99. Memory contents from memory number 0 to 29 are the same in Dual, and Repeat Digit Input methods.
- * Memory 0 - 9 are programmed as factory settings. See the table of Programmed Memories and the Memory Input Method on the right side. Memory 10 - 99 must be programmed before using Memory Cooking. When a memory number which has not been programmed is entered, "End" will be shown in the display. See Saving Memories on page 15-19 to programme a new memory.

Programmed Memories and the Memory Input Method

Memory No.	Dual Digit Input	Single Digit Input	Repeat Digit Input	Cook time	Output power
1	01	1	1	5 sec.	100%
2	02	2	2	10 sec.	100%
3	03	3	3	20 sec.	100%
4	04	4	4	30 sec.	100%
5	05	5	5	40 sec.	100%
6	06	6	6	50 sec.	100%
7	07	7	7	1 min.	100%
8	08	8	8	1 min. 15 sec.	100%
9	09	9	9	1 min. 30 sec.	100%
0	00	0	0	2 min.	100%



*** Memory Cooking can be set in 6 operating ways.**

There are multiple methods of selecting memories depending on the input method selected and whether or not Auto Start is turned on or off (for information about Auto Start On/OFF function see Custom Setting 2 on page 9). To avoid mistakenly selecting the incorrect memory, please confirm your settings by checking Custom Setting (see Custom Setting 1 and 2 on page 9).

6 operating ways:

1. Dual Digit Input/Auto Start OFF (memory 00 - 99)
2. Dual Digit Input/Auto Start ON (memory 00 - 99)
3. Repeat Digit Input/Auto Start OFF (memory 0 - 9)
4. Repeat Digit Input/Auto Start ON (memory 0 - 9)
5. Single Digit Input/Auto Start OFF (memory 0 - 9)
6. Single Digit Input/Auto Start ON (memory 0 - 9)

HELPFUL TIPS for the Display of Memory Input Status and the START Pad

When Auto Start ON has been selected,

1. "0" should be displayed before entering memory number.
When "0" is not displayed, open the door and close to reset.
2. The START pad does not need to be pressed.
Cooking will automatically start when the memory number is input.

1. Dual Digit Input/Auto Start OFF (with the START Pad)

* Suppose you want to cook with memory 2, which was programmed for 10 seconds at 100%.

Procedure	
1 Place food in oven. Enter memory number.	<input type="text" value="0"/> <input type="text" value="2"/>
2 Press the START pad.	<input type="button" value="START"/>

2. Dual Digit Input/Auto Start ON (without the START Pad)

* Suppose you want to cook with memory 12, which was programmed for 10 seconds at 100%.

Procedure	
1 Place food in the oven. Enter memory number.	<input type="text" value="1"/> <input type="text" value="2"/>

3. Repeat Digit Input/Auto Start OFF (with the START Pad)

* Suppose you want to cook with memory 2, which was programmed for 10 seconds at 100%.

Procedure	
1 Place food in oven. Enter memory number.	<input type="text" value="2"/>
2 Press the START pad.	<input type="button" value="START"/>

4. Repeat Digit Input/Auto Start ON (without the START Pad)

* Suppose you want to cook with memory 12, which was programmed for 10 seconds at 100%.

Procedure	
1 Place food in oven. Enter memory number.	<input type="text" value="2"/> x 2

5. Single Digit Input/Auto Start OFF (with the START Pad)

* Suppose you want to cook with memory 2, which was programmed for 10 seconds at 100%.

Procedure	
1 Place food in oven. Enter memory number.	<input type="text" value="2"/>
2 Press the START pad.	<input type="button" value="START"/>

6. Single Digit Input/Auto Start ON (without the START Pad)

* Suppose you want to cook with memory 2, which was programmed for 10 seconds at 100%.

Procedure	
1 Place food in oven. Enter memory number.	<input type="text" value="2"/>

Cooking Double/Triple Quantity with Memory

Double/Triple Quantity is a feature where the oven will automatically calculate how to cook two or three servings of a programmed food. It does not simply double or triple the time. Factory setting is multiplication factor 1.8 for Double Quantity and 2.6 for Triple Quantity. Press the DOUBLE/TRIPLE QUANTITY pad once for Double Quantity (2 servings), and twice for Triple Quantity (3 servings).

* Suppose you want to cook 3 servings with memory number 2 programmed Single Digit Input/Auto Start ON.

Procedure	
1 Place food in oven. Press the DOUBLE/TRIPLE QUANTITY pad twice.	<input type="text" value="x2/x3"/> x 2
2 Enter memory number.	<input type="text" value="2"/>

NOTE : If your total cooking time is over the maximum time allowed, error message EE9 will be displayed. Press the STOP/CLEAR pad to clear the error message and reduce the quantity or cook without using Double/Triple Quantity. For details see Custom Setting 10 on page 13 and Maximum Cooking Time on page 19.



Express Defrost with Memory

- * Suppose you want to cook with memory 0, which was programmed for 10 minutes Express Defrost sequence, Single Digit Input/Auto Start ON.

Procedure	
1 Place food in oven. Enter memory number.	0
Midway through the defrosting cycle, the CHECK indicator will light in the display and an audible signal will be heard unless signal volume has been set to Mute. You may open the door, turn food over and shield any warm portions. Close the door.	

Procedure	
2 Press the START pad to continue defrosting.	START

NOTES:

- Even though CHECK lights up in the display, your oven continues defrosting and does not stop to check.
- Press the START pad at step 2 to continue defrosting as once the door is closed, cooking data will be canceled if the START pad is not pressed within 3 minutes.
- See Express Defrost Chart on page 8.

MANUAL OPERATION

Your oven can be programmed for up to 4 cooking sequences and has 11 preset microwave power levels.

Maximum Cooking Time

Microwave 100% - 60% Maximum of 60 minutes

Microwave 50% - 10% Maximum of 120 minutes

(Please see Maximum Cooking Time on page 19)

Microwave Power Level

Press the POWER LEVEL pad once then press	Approximate percentage of power	Display
POWER LEVEL	100%	P-HI
9	90%	P-90
8	80%	P-80
7	70%	P-70
6	60%	P-60
5	50%	P-50
4	40%	P-40
3	30%	P-30
2	20%	P-20
1	10%	P-10
0	0%	P-0

NOTES:

- It is not necessary to press the POWER LEVEL pad for 100% in Single Stage Cooking.
- If cooking time input is over the maximum allowed time, error message EE9 will be displayed. Press the STOP/CLEAR pad to clear the error message and reduce cooking time or power level. For details, see Maximum Cooking Time on page 19.

Multi Stage Cooking

- * Suppose you want to cook for 1 minute at 70% power for 1st stage and then continue to cook for 2 minutes at 50% power for 2nd stage and to cook for 3 minutes at 100% power for 3rd stage.

Single Stage Cooking

- * Suppose you want to cook for 2 minutes and 30 seconds at 50%.

Procedure	
1 Place food in oven and press the MANUAL/REPEAT pad. Enter cooking time.	MANUAL REPEAT 2 3 0
2 Press the POWER LEVEL pad and enter power level.	POWER LEVEL 5
3 Press the START pad.	START

Procedure	
1 Place food in oven and press the MANUAL/REPEAT pad. Enter cooking time for 1st stage.	MANUAL REPEAT 1 0 0
2 Press the POWER LEVEL pad. Enter power level for 1st stage.	POWER LEVEL 7
3 Press the MANUAL/REPEAT pad. Enter cooking time for 2nd stage.	MANUAL REPEAT 2 0 0
4 Press the POWER LEVEL pad. Enter power level for 2nd stage.	POWER LEVEL 5
5 Press the MANUAL/REPEAT pad. Enter cooking time for 3rd stage.	MANUAL REPEAT 3 0 0
6 Press the START pad.	START



NOTES:

1. It is not necessary to press the POWER LEVEL pad for 100% at the last stage in Multi Stage Cooking.
2. If the total cooking time is over the maximum time allowed, error message, EE9 will be displayed. Press the STOP/CLEAR pad to clear the error message pad and reduce total cooking time, power levels or stages. For details, see Maximum Cooking Time on page 19.

Repeat Cooking

Use Repeat Cooking to re-cook in the previous manual cooking setting. The previous manual cooking setting is memorized unless the oven is unplugged.

- * Suppose you want to re-cook in the previous manual cooking setting, 1 minute at 70% power for 1st stage and then continue to cook for 2 minutes at 50% power for 2nd stage and to cook for 3 minutes at 100% power for 3rd stage.

Procedure	
1 Place food in oven. Press the MANUAL/REPEAT pad.	
2 Press the START pad.	

Express Defrost

Use Express Defrost to defrost meat and poultry. Calculate total defrost time using chart below. Express Defrost can be programmed for a maximum of 90 minutes.

- * Suppose you want to defrost for 4 minutes and 30 seconds.

Procedure	
1 Place food in oven. Press the EXPRESS DEFROST pad.	
2 Enter defrosting time. (Refer to chart below.)	
3 Press the START pad.	
Midway through the defrosting cycle, the CHECK indicator will light in the display and an audible signal will be heard unless signal volume has been set to Mute. You may open the door, turn food over and shield any warm portions. Close the door.	
4 Press the START pad to continue defrosting.	

NOTES:

1. Even though CHECK lights up the display, your oven continues defrosting and does not stop to check.
2. Press the START pad at step 4 to continue defrosting. Once the door is closed, cooking data will be canceled if subsequent keys are not pressed within 3 minutes.

Express Defrost Chart

The following chart gives approx times per 500g for defrosting meat.

Food	Time(min./500g)	Procedure
Steak/Chops See Note below	4-5 min./500g	<ul style="list-style-type: none"> * Shield thin end of chops or steaks with foil. * Position the food with thinner parts in the centre in a single layer on a defrost rack. If pieces are stuck together, try to separate as soon as possible. * Turn food over and rearrange after the oven beeps. * After defrost time, stand covered with foil for 10-15 minutes.
Poultry See Note below	4-5 min./500g	<ul style="list-style-type: none"> * Remove from original wrapper. Shield wing and leg tips with foil. * Place breast side down on a defrost rack. * Turn food over after the oven beeps. * After defrost time, stand covered with foil for 15-50 minutes. N.B. After standing rinse under cold water to remove giblets if necessary.
Minced Beef See Note below	4-5 min./500g	<ul style="list-style-type: none"> * Place frozen minced beef on a defrost rack Shield edges. * Remove defrosted portion of mince, turn food over and shield edges with foil strips after the oven beeps. * After defrost time, stand covered with foil for 10-15 minutes.
Chicken Pieces See Note below	4-5 min./500g	<ul style="list-style-type: none"> * Shield the exposed bone with foil. * Place chicken pieces on a defrost rack. * Turn food over, rearrange and shield the warm portions after the oven beeps. * After defrost time, stand covered with foil for 10-15 minutes.
Roast Beef Pork Lamb	5-6 min./500g	<ul style="list-style-type: none"> * Shield the edge with foil strips about 2.5 cm wide. * Place joint with lean side face upwards (if possible) on a defrost rack. * Turn food over and shield the warm portions after the oven beeps. * After defrost time, stand covered with foil for 10-50 minutes.

Check food after standing. If additional time is needed, continue to defrost with 20% power and additional time. Food not listed in the Chart can be defrosted using 20% setting.

NOTE: When freezing minced beef, shape it into flat even sizes. For chicken pieces, steaks and chops, freeze separately in single flat layers and if necessary interleave with freezer plastic to separate layers. This will ensure even defrosting. It is also a good idea to label the packs with the correct weights.





PROGRAMME AND CUSTOMISE

Custom Setting

You can check your oven settings and customise your oven by changing Custom Settings settings.

The CUSTOM SETTING pad has 11 operations.

1. Selecting Memory Input Method
2. Selecting Auto Start Operation
3. Programme Lock Setting
4. Audible Signal Sound Volume Setting
5. Cooking Completion Signal Setting
6. Memory Check
7. Counter Check/Clear
8. Air Intake Filter Counter
9. Selecting Operation in Case of Magnetron Failure
10. Multiplication Factors for Double/Triple Quantity
11. Express Defrost Setting

To use Custom Setting function, press the CUSTOM SETTING pad twice within 2 seconds, and desired option pads. See detailed instructions below.

NOTE : You will hear an audible signal the second time the CUSTOM SETTING pad is pressed to indicate that you have entered Custom Setting.

1. Selecting Memory Input Method

Your oven has 3 ways to select memory numbers.

- CU11 : Dual Digit Input (100 memory banks)
= Factory Setting
- CU12 : Single Digit Input (10 memory banks)
- CU13 : Repeat Digit Input (30 memory banks)





To Set Input Method

Press the CUSTOM SETTING pad twice within 2 seconds then enter the numbers

- 1,1 for Dual Digit Input
- 1,2 for Single Digit Input
- 1,3 for Repeat Digit Input

Press the START pad to save settings and the STOP/CLEAR pad to exit from the Custom Setting function.

* Suppose you want to set Repeat Digit Input.

Procedure	
 x 2	1 Press the CUSTOM SETTING pad twice within 2 seconds.
 	2 Enter 1,3 for Repeat Digit Input.
	3 Press the START pad to save the setting.
	4 Press the STOP/CLEAR pad to exit from the Custom Setting function.

2. Selecting Auto Start Operation

Your oven has 2 ways to start memory cooking.

- CU21 : Auto Start OFF = factory setting
- CU22 : Auto Start ON

The factory setting is Auto Start OFF. Under Auto Start OFF, cooking will not begin until the START pad is pressed. Under Auto Start ON, cooking will automatically start after the memory number is input.





To Set Auto Start

Press the CUSTOM SETTING pad twice within 2 seconds then enter the numbers

- 2, 1 for Auto Start OFF
- 2, 2 for Auto Start ON

Press the START pad to save settings and the STOP/CLEAR pad to exit from the Custom Setting function.

* Suppose you want to set Auto Start ON.

Procedure	
 x 2	1 Press the CUSTOM SETTING pad twice within 2 seconds.
 	2 Enter 2, 2 for Auto Start ON.
	3 Press the START pad to save the setting.
	4 Press the STOP/CLEAR pad to exit from the Custom Setting function.

3. Programme Lock Setting

You can select Programme Lock ON or OFF

- CU31 : Programme Lock OFF = factory setting
- CU32 : Programme Lock ON

Programme Lock OFF is the factory setting. Programme Lock prevents accidental changes to settings. When the CUSTOM SETTING pad is pressed twice within 2 seconds in programme Lock ON, the LOCK indicator will light up. Turn Programme Lock OFF when you want to change the settings.

To Turn Programme Lock ON/OFF





Press the CUSTOM SETTING pad twice within 2 seconds then enter the numbers

- 3, 1 for Programme Lock OFF
- 3, 2 for Programme Lock ON

Press the START pad to save settings and the STOP/CLEAR pad to exit from the Custom Setting function.



* Suppose you want to set Programme Lock ON.

Procedure	
 x 2	1 Press the CUSTOM SETTING pad twice within 2 seconds.
 	2 Enter 3, 2 for Programme Lock ON.
	3 Press the START pad to save the setting.
	4 Press the STOP/CLEAR pad to exit from the Custom Setting function.

NOTE : If you select Programme Lock OFF, the LOCK indicator in the display will disappear when you press the START pad.

Operation when Programme Lock ON is set

KEY Operation	Custom Setting Title	When Programme Lock ON is Set
1	Selecting Memory Input Method	no operation
2	Selecting Auto Start Operation	no operation
3	Programme Lock Setting	operation
4	Audible Signal Sound Volume Setting	no operation
5	Cooking Completion Signal Setting	no operation
6	Memory Check	operation
7	Counter Check/Clear	check : operation clear : no operation
8	Air Intake Filter Counter	check, clear : operation set : no operation
9	Selecting Operation in Case of Magnetron Failure	no operation
x2/x3	Multiplication Factors for Double/Triple Quantity	check : operation set : no operation
EXPRESS DEFROST	Express Defrost Setting	check : operation set : no operation

4. Audible Signal Sound Volume Setting

The volume of the audible signal can be adjusted to High, Medium, or Mute.

CU41 : High = factory Setting

CU42 : Medium

CU43 : Mute

To Set Cooking Completion Signal Volume

Press the CUSTOM SETTING pad twice within 2 seconds then enter the numbers

4, 1 for High

4, 2 for Medium

4, 3 for Mute

Press the START pad to save setting and the STOP/CLEAR pad to exit from the Custom Setting function.

NOTE : Even when errors occur, your oven will not beep in mute setting.

5. Cooking Completion Signal Setting

There is a choice of 4 different signals on your oven.

CU51 : 1 long beep = factory setting

CU52 : Repeating long beeps

CU53 : 4 short beeps

CU54 : Repeating short beeps

To Set the Signal Type

Press the CUSTOM SETTING pad twice within 2 seconds then enter the numbers

5, 1 for 1 long beep

5, 2 for repeating long beeps

5, 3 for 4 short beeps



5, 4 for repeating short beeps

Press the START pad to save settings and the STOP/CLEAR pad to exit from the Custom Setting function.

6. Memory Check

Use this setting to check the programming for a certain memory.

* Suppose you want to know the information programmed into memory 1, programmed for 4 minutes at 60% for the 1st stage and 2 minutes at 30% at the 2nd stage programmed Dual Digit Input.

Procedure	Display
 x 2 	
1 Press the CUSTOM SETTING pad twice within 2 seconds and enter 6.	



Procedure	Display
0	
1	
2 Enter memory number. (After entering the memory number, the memory setting of each content is shown for 1.5 seconds at 0.3 second intervals until the STOP/CLEAR pad is pressed.)	After about 1 sec.
 3 Press the STOP/CLEAR pad to exit from the Custom Setting function.	

NOTES:

1. If is displayed at step 2 the memory has not been programmed.
2. Multiple memories can be checked until the STOP/CLEAR pad is pressed to exit from the Custom Setting function.
3. The way to enter memory numbers depends on the programmed Memory Input Method.
4. When Express Defrost is set for 30 minutes in the memory, and are displayed repeatedly at step 2.

7. Counter Check/Clear

Confirm counters are set to "0" before using oven for the first time.

Counter Check

Counter Check can be used to check the total number of times the oven has been used, or the number of times each pre-programmed memory pad, manual cooking, or Express Defrost has been used.

Total usage Press the CUSTOM SETTING pad twice within 2 seconds, then enter 7. Total usage will be displayed.

To Check More than One Counter

Press each pad as indicated below, after the previous usage is displayed.

- Total each memory usage** Input memory number.
- Total manual cooking usage** Press the MANUAL/REPEAT pad.
- Total Express Defrost usage** Press the EXPRESS DEFROST pad.

* Suppose you want to know total usage and each memory usage. In this case the oven was used 8268 times and memory 1 in any Memory Input Method was used 513 times.

Procedure	Display
x 2 1 Press the CUSTOM SETTING pad twice within 2 seconds, then enter 7. Total usage will be displayed.	After about 1 sec.
0 1 2 Enter memory number 1, to check the total memory usage of memory 1.	 After about 1 sec.

NOTES:

1. To exit from Counter Check, press the STOP/CLEAR pad.
2. Each counter will count up to 9999, and then will automatically reset to 0 and begin counting again.
3. As shown in the above example, multiple counters can be checked before pressing the STOP/CLEAR pad to exit.
4. Only Dual Digit Input method can be used when inputting memory numbers in Counter Check/Clear.



To Reset the Counter to "0"

Each counter can be manually reset to "0" by pressing the START pad after the count is displayed.

* Suppose you want to reset the count for memory number 1 in any Memory Input Method

Procedure	
<p>CUSTOM SETTING x 2 7</p> <p>1 Press the CUSTOM SETTING pad twice within 2 seconds, then enter 7. Total usage will be displayed.</p>	<p>After about 1 sec.</p>
<p>2 Enter memory number 1 to check the total memory usage of memory 1.</p>	<p>0</p> <p>1</p> <p>After about 1 sec.</p>
<p>START</p> <p>3 Press the START pad.</p>	
<p>STOP CLEAR</p> <p>4 Press the STOP/CLEAR pad to exit from the Custom Setting function.</p>	

NOTES:

1. Only Dual Digit Input method can be used when inputting memory numbers in Counter Check/Clear.
2. To clear total manual cooking usage, press the MANUAL/REPEAT pad in Step 2 instead of the number pad.
3. To clear total Express Defrost usage, press the EXPRESS DEFROST pad in Step 2 instead of the number pad.
4. To clear total usage, skip Step 2.

8. Air Intake Filter Counter

Use Custom Setting function for Air Intake Filter Counter to check total usage hours since the Air Intake Filter Counter was last reset to "0".

CU81 : The total used air intake filter time appears.

CU82 : The limit time for using a filter can be changed.

Use Custom Setting function for Air Intake Filter Counter to change the Air Filter Cycle from 001-999. The factory setting is 100 hours. When 100 hours is exceeded, the FILTER indicator in the display will start to flash on and off as a reminder to clean the air filter, even if in the middle of cooking. Furthermore "FILt" flashes on and off in stead of displaying ". ." during standby and at the same time FILTER indicator flashes on and off. Clean air intake filter (see page 21), when the FILTER indicator appears in the display, and then clear the total usage to reset it to "0" .

* Suppose you want to know the total usage hours which has been 99 hours since the last reset.

Procedure	Display
<p>CUSTOM SETTING x 2 8 1</p> <p>1 Press the CUSTOM SETTING pad twice within 2 seconds and enter 8, 1.</p>	<p>After about 1 sec.</p>
<p>STOP CLEAR</p> <p>2 Press the STOP/CLEAR pad to exit from the Custom Setting function.</p>	

To Reset the Air Intake Filter Counter

Reset the Air Intake Filter Counter after cleaning the air intake filter.

* Suppose you want to reset the Air Filter Counter which has been 101 hours since the last reset and the Air Filter Cycle is preset to 100.

Procedure	Display
<p>CUSTOM SETTING x 2 8 1</p> <p>1 Press the CUSTOM SETTING pad twice within 2 seconds and enter 8,1.</p>	<p>After about 1 sec.</p>
<p>START</p> <p>2 Press the START pad to reset the counter to "0".</p>	
<p>STOP CLEAR</p> <p>3 Press the STOP/CLEAR pad to exit from the Custom Setting function.</p>	



Air Filter Cycle

Air Filter Cycle can be changed from the factory setting of 100 hours to 001-999 hours

* Suppose you want to set the cycle to 250 hours.

Procedure	Display
 1 Press the CUSTOM SETTING pad twice within 2 seconds and enter 8, 2.	 After about 1 sec.
 2 Press the MANUAL/REPEAT pad.	
 3 Enter desired time. (Ex : Enter 2, 5, 0 for 250 hours).	
 4 Press the START pad to save settings.	
 5 Press the STOP/CLEAR pad to exit from the Custom Setting function.	

9. Selecting Operation in Case of Magnetron Failure

Your oven has 2 magnetrons. In case of single magnetron failure, the oven can be used until servicing by changing settings to allow operation under single magnetron only. However, check food carefully as additional cooking time will be needed when operating with a single magnetron.

CU91 : Your oven does not work when one magnetron fails = factory setting

CU92 : Your oven works even if one magnetron fails.

To Set Magnetron Failure Options

Press the CUSTOM SETTING pad twice within 2 seconds then enter the numbers

9, 1 to stop operation when one magnetron fails

9, 2 to allow operation of one magnetron only

Press the START pad to save settings and the STOP/CLEAR pad to exit from the Custom Setting function.

10. Multiplication Factors for Double/Triple Quantity

The multiplication factors of the double and triple quantities for memory cooking are preset to 1.80 and 2.60. You can check or change the multiplication factors.

* Suppose you want to know the multiplication factor for double quantity with memory 1, and change it to 2.00 in any Memory Input Method.

Procedure	Display
 1 Press the CUSTOM SETTING pad twice within 2 seconds and press the DOUBLE/TRIPLE QUANTITY pad.	
 2 Enter memory number.	 After about 1 sec.
 3 Press the MANUAL/REPEAT pad.	
 4 Enter desired multiplication. (Ex : Enter 2, 0, 0 for 2.00.)	
 5 Press the START pad to save settings.	
 6 Press the STOP/CLEAR pad to exit from the Custom Setting function.	



NOTES:

1. Only Dual Digit Input method can be used when inputting memory numbers in Multiplication Factors for Double/Triple Quantity.
2. The multiplication factors can be set from 0.01 to 9.99 for double quantity and triple quantity.
3. When you want to know the multiplication factor for triple quantity, press the DOUBLE/TRIPLE QUANTITY twice at step 1 after pressing the CUSTOM SETTING pad twice.
4. Multiplication Factors for Double/Triple Quantity can be checked or changed before pressing the STOP/CLEAR pad to exit for Custom Setting function.

11. Express Defrost Setting

Express Defrosting uses 3 stages to defrost foods quickly. The defrosting sequence is preset as follows, but you can change the setting.

	Defrosting Time	Power Level
STAGE 1	T x A1: (0.20*) + B1: (20*) sec.	PL1 (40*) %
STAGE 2	T x A2: (0.13*) + B2: (30*) sec.	PL2 (30*) %
STAGE 3	T - STAGE1 - STAGE2	PL3 (20*) %
Pause Timing	See the table for The Pause Timing below (50*)	

T : INPUT TIME (TOTAL COOKING TIME)

* : The numbers in the parentheses are factory settings and can be adjusted.

Express Defrost is preset to pause during the sequence when 50% of total defrosting time has passed to check food. Pause timings can also be adjusted.

Pause Timing

KEY	Display	Pause Timing
0	0	No pause.
1	1	After 10% of total cooking time.
2	2	After 20% of total cooking time.
3	3	After 30% of total cooking time.
4	4	After 40% of total cooking time.
5	5	After 50% of total cooking time.
6	6	After 60% of total cooking time.
7	7	After 70% of total cooking time.
8	8	After 80% of total cooking time.
9	9	After 90% of total cooking time.
START	A	After ending of each stage

* Suppose you want to change the Express Defrost set factory settings to the following:

	Defrosting Time	Power Level
STAGE 1	T x 0.30 + 10 sec.	50%
STAGE 2	T x 0.15 + 20 sec.	20%
STAGE 3	T - STAGE1 - STAGE2	10%
Pause Timing	When 70% of total defrosting time has passed.	

Procedure **Display**

CUSTOM SETTING x 2 **EXPRESS DEFROST**

























1 Press the CUSTOM SETTING pad twice within 2 seconds and press the EXPRESS DEFROST pad. (The Express Defrost setting of each phase is shown for 1.5 seconds at 0.3 second intervals until the MANUAL/REPEAT pad is pressed.)

2 Press the MANUAL/REPEAT pad and enter desired multiplication for A1 at Stage 1. (Ex: Enter 3,0 for 0.30.)

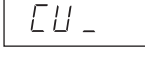

3 Press the MANUAL/REPEAT pad and enter desired time for B1 at Stage 1. (Ex: Enter 1 for 10 seconds.)

4 Press the POWER LEVEL pad and enter desired power level for PL1 at Stage 1. (Ex: Enter 5 for 50%)

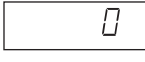

Procedure	Display
5 Press the MANUAL/REPEAT pad and enter desired multiplication for A2 at Stage 2. (Ex: Enter 1, 5 for 0.15.)	     
6 Press the MANUAL/REPEAT pad and enter desired time for B2 at Stage 2. (Ex: Press 2 for 20 seconds.)	   
7 Press the POWER LEVEL pad and enter desired power level for PL2 at Stage 2. (Ex: Enter 2 for 20%)	   
8 Press the MANUAL/REPEAT pad and enter the pause timing. (Ex: Enter 7 for when 70% of total defrosting time has passed.)	   
9 Press the POWER LEVEL pad and enter desired power level for PL3 at Stage 3. (Ex: Enter 1 for 10%)	   
	
10 Press the START pad.	
	
11 Press the STOP/CLEAR pad to exit from the Custom Setting function.	

NOTES:

- See the table for Microwave Power Level on page 7 and The Pause Timing on page 14.
- You can enter minus numbers for B1 and B2 at steps 3 and 6. In that case, press the MANUAL/REPEAT pad twice at step 3 or 6 ( is displayed.) and enter desired time for or B1 and B2 at Stage 1 and 2. Press the MANUAL/REPEAT pad again to enter positive numbers. ( is displayed.)

Saving Memories

- * Memory 0 - 9 are programmed as factory settings. See the table of Programmed Memories and the Memory Input Method on page 5.
- * Memories must be programmed before memory cooking can be used.

Memory banks

Dual Digit: Memory 0-99













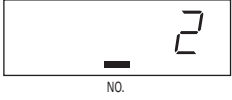



Single Digit: Memory 0-9

Repeat Digit Input: Memory 0-29

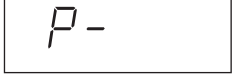
Max. cooking stages: 4 stages

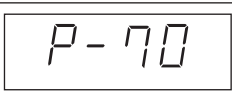
1. Setting time and power level for Single Stage**Single Digit Input**

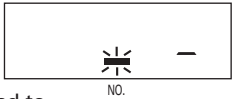
- * Suppose you want to set 1 minute at 70% with memory 2.















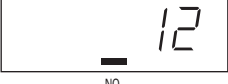

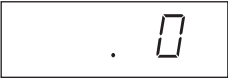

Procedure	Display
 X 2	
1 Press the SET MEMORY pad twice within 2 seconds.	
	
2 Enter memory number.	
	
3 Press the MANUAL/REPEAT pad.	
  	
4 Enter cooking time.	
	
5 Press the POWER LEVEL pad.	
	
6 Enter power level.	
	
7 Press the SET MEMORY pad to save memory.	
	
8 Press the STOP/CLEAR pad to exit.	

**NOTES:**

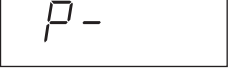
1. Press the SET MEMORY pad twice within 2 seconds.
2. If the cooking time is over the maximum time, the display will show error code EE9. To clear the error code, press the STOP/CLEAR pad and re-programme. See Maximum Cooking Time on page 19.
3. It is not necessary to press the POWER LEVEL pad for 100% in Single Stage.

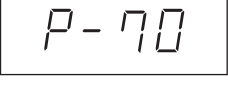
Repeat Digit Input

- * Suppose you want to set 1 minute at 70% with memory 12.











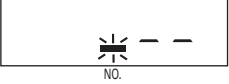

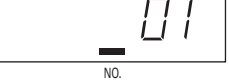

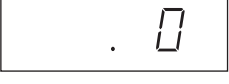



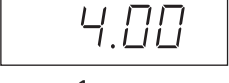

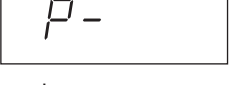

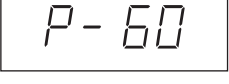

Procedure	Display
 X 2 1 Press the SET MEMORY pad twice within 2 sec.	
  2 Enter memory number.	
 3 Press the MANUAL/REPEAT pad.	
   4 Enter cooking time.	
 5 Press the POWER LEVEL pad.	
 6 Enter power level.	
 7 Press the SET MEMORY pad.	
 8 Press the STOP/CLEAR pad to exit.	

NOTES:

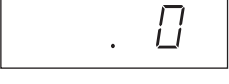
1. Press the SET MEMORY pad twice within 2 seconds.
2. If the programmed cooking time is over the maximum time, the display will show error code EE9. To clear the error code, press the STOP/CLEAR pad and re-programme. See Maximum Cooking Time on page 19.
3. It is not necessary to press the POWER LEVEL pad for 100% in Single Stage.

Dual Digit Input

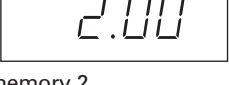
- * Suppose you want to set 4 minutes at 60% with memory 1 and 2 minutes at 30% with memory 2.

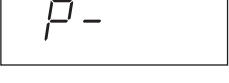
Procedure	Display
 X 2 1 Press the SET MEMORY pad twice within 2 seconds.	
  2 Enter memory number.	
 3 Press the MANUAL/REPEAT pad.	
   4 Enter cooking time for memory 1.	
 5 Press the POWER LEVEL pad.	
 6 Enter power level for memory 1.	
 7 Press the SET MEMORY pad to save memory 1.	
  8 Enter memory number.	
 9 Press the MANUAL/REPEAT pad.	
   10 Enter cooking time for memory 2.	
 11 Press the POWER LEVEL pad.	



Procedure	Display
12 Enter power level for memory 2.	
13 Press the SET MEMORY pad to save memory 2.	
14 Press the STOP/CLEAR pad to exit.	

NOTES:

1. Press the SET MEMORY pad twice within 2 seconds.
2. If the programmed cooking time is over the maximum time, the display will show error code EE9. To clear the error code, press the STOP/CLEAR pad and re-programme. See Maximum Cooking Time on page 19.
3. It is not necessary to press the POWER LEVEL pad for 100% in Single Stage.

2. Programming Multi Stage Cooking

- * Suppose you want to set 4 minutes at 60% for the 1st stage and 2 minutes at 30% for the 2nd stage with memory 2 using of Dual Digt Input.

Procedure	Display
X 2	
1 Press the SET MEMORY pad twice within 2 seconds.	
2 Enter the memory number.	
3 Press the MANUAL/REPEAT pad.	
4 Enter cooking time for 1st stage.	
5 Press the POWER LEVEL pad.	

Procedure	Display
6 Enter power level for 1st stage.	
7 Press the MANUAL/REPEAT pad.	
8 Enter cooking time for 2nd stage.	
9 Press the POWER LEVEL pad.	
10 Enter power level for 2nd stage.	
11 Press the SET MEMORY pad to save memory.	
12 Press the STOP/CLEAR pad to exit.	















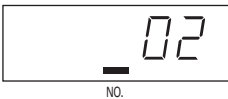

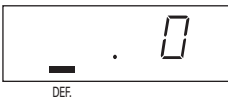
NOTES:

1. Press the SET MEMORY pad twice within 2 seconds.
2. If the programmed cooking time is over the maximum time, the display will show error code EE9. To clear the error code, press the STOP/CLEAR pad and re-programme. See Maximum Cooking Time on page 19.
3. It is not necessary to press the POWER LEVEL pad for 100% in the last stage in Multi Stage Cooking.



3. Setting Total Cooking Time of Express Defrost



- * Suppose you want to set the total cooking time of Express Defrost to 30 minutes with memory 2 using Dual Digit Input.

Procedure	Display
 X 2 1 Press the SET MEMORY pad twice within 2 seconds.	
  2 Enter memory number.	
 3 Press the EXPRESS DEFROST pad.	
    4 Enter cooking time.	
 5 Press the SET MEMORY pad.	
 6 Press the STOP/CLEAR pad.	

NOTES:

1. Press the SET MEMORY pad twice within 2 seconds.
2. If the programmed cooking time is over the maximum time, the display will show error code EE9. To clear the error code, press the STOP/CLEAR pad and re-programme. See Maximum Cooking Time on page 19.
3. Refer to NOTE for Express Defrost on page 8.

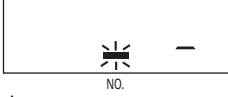

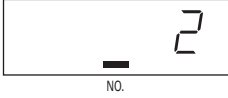
- * Suppose you want to set the Total Cooking Time of Express Defrost to 30 minutes with memory 2 using Single Digit Input.

Procedure	Display
 X 2 1 Press the SET MEMORY pad twice within 2 seconds.	
 2 Enter memory number.	

NOTES:

1. Follow steps 3-6 on the left side of page 18 to complete.
2. Press the SET MEMORY pad twice within 2 seconds.
3. If the programmed cooking time is over the maximum time, the display will show error code EE9. To clear the error code, press the STOP/CLEAR pad and re-programme. See Maximum Cooking Time on page 19.
4. Refer to NOTE for Express Defrost on page 8.

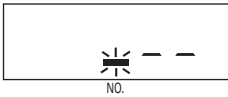
- * Suppose you want to set the Total Cooking Time of Express Defrost to 30 minutes with memory 12 using Repeat Digit Input.

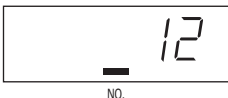
Procedure	Display
 X 2 1 Press the SET MEMORY pad twice within 2 seconds.	
  2 Enter memory number.	

NOTES:

1. Follow steps 3-6 on the left side of page 18 to complete.
2. Press the SET MEMORY pad twice within 2 seconds.
3. If the programmed cooking time is over the maximum time, the display will show error code EE9. To clear the error code, press the STOP/CLEAR pad and re-programme. See Maximum Cooking Time on page 19.
4. Refer to NOTE for Express Defrost on page 8.



Maximum Cooking Time

1. 100%~60% power level : the total cooking time of all cooking stages is maximum 60 minutes.
2. 50%~10% power level : the total cooking time of all cooking stages is maximum 120 minutes.
3. Multi Stage Cooking : the Maximum Cooking Time is limited by the following calculation. Each stage has 100~60% power level or 50~10% power level.

Maximum Cooking Time Calculation

$$\text{Total Cooking Time of 100~60\% Power Level} + \frac{\text{Total Cooking Time of 50~10\% Power Level}}{2} \leq 60 \text{ minutes}$$

- * Suppose you want to cook 5 minutes at 100% for 1st stage, 15 minutes at 80% for 2nd stage, 40 minutes at 30% for 3rd stage and 20 minutes at 10% for 4th stage. In this case actual Cooking Time is 80 minutes, and the calculated time is 50 minutes, see the calculation below.
 $[5\text{min} + 15\text{min}] + [(40\text{min} + 20\text{min})/2] \leq 60 \text{ min.}$

4. 0% power level : maximum 99 minutes and 99 seconds can be input at one stage (max. 4 stages).
5. Express Defrost : the maximum defrosting time is 90 minutes. See Maximum Cooking Time Calculation above.

OTHER CONVENIENT FEATURES

Demonstration Mode

To demonstrate, press the MANUAL/REPEAT pad, 0 and then press the START pad and hold for 3 seconds. Cooking operations can now be demonstrated with no power in the oven. The timer will count down rapidly.

To cancel, press the MANUAL/REPEAT pad, then 0 and the STOP/CLEAR pad or unplug your oven.

To set cooking during the Demonstration mode, press the MANUAL/REPEAT pad and enter time and press the START pad. After cooking, press the STOP/CLEAR pad to show Demonstration again.

When you set Demonstration mode, your oven will not shut down automatically even if you do not operate the oven for 3 minutes or more.

Monitor

Monitor function is used to check the power level during cooking.

To check the power level, press the POWER LEVEL pad and the power level will be displayed. As long as the POWER LEVEL pad is pressed, the power level is displayed. When the POWER LEVEL pad is released, the display will return to the previous display.

Error Mode

Should any of the error indicators appear in the display, follow the instructions:

EE Mode	Reason	Action Required
EE1, EE2	Failure of single magnetron	Call for service.★
EE3	Both magnetrons failed	Call for service.
EE4	Voltage too high	Call for service.
EE5	Voltage too low	Call for service.
EE7	Oven cavity or component temperature too high	It may be caused by poor air circulation. Please, ensure that there is sufficient clearance around the oven (see Installation Instructions on page 3) and that air intake openings are not blocked. Correct the situation if necessary, wait a few minutes and try again. If problem persists, call for service.
EE8	Circuit failure	Call for service.
EE9	Maximum cooking time is exceeded.	Check the NOTE for Cooking Double/Triple Quantity with Memory on page 6, NOTE 2 for Single Stage Cooking on page 7, or NOTE 2 for Multi Stage Cooking on page 8 in the Operation Manual. Press the STOP/CLEAR pad, and re-input by reducing total cooking time or power levels.
EE0	Cooling fan motor or other motor failure. Splash cover is not installed properly.	Cooling fan motor and other motors: Call for service. Splash cover: Check that Splash cover is properly installed (See page 21). If problem persists, call for service.

- ★ EE1 and EE2 : In case of single magnetron failure, oven can be used until servicing by changing Custom Setting, settings to allow operation under single magnetron only (see page 13). However, check food carefully as additional cooking time will be needed when operating with a single magnetron.

Press the STOP/CLEAR pad to clear the error indicator. Any time an error code appears, check the reason and be sure to call for service except EE7 and EE9. As for EE7, follow Action Required and if EE7 is still displayed, be sure to call for service.





Maintenance Mode

Should any of the following maintenance indicators (CC1, CC2, CC3, CC4) appear in the display, please contact your Sharp Approved Service Centre for service.

CARE AND CLEANING

CLEAN THE OVEN AT REGULAR INTERVALS

IMPORTANT

- The oven should be cleaned regularly and any food deposits removed.
- DO NOT OPERATE the oven without the splash cover in place.
- DO NOT REMOVE the splash cover UNLESS THE POWER CORD IS REMOVED FROM THE OUTLET because the rotary antenna, which is located on the ceiling, operates for 1 minute after the door is opened and injury could occur.
- DO NOT REMOVE the antenna cover. It is not designed to be removable.
- Do not use commercial oven cleaners, abrasive or harsh cleaners or scouring pads on any part of your microwave oven.
- Do not sprinkle water onto the oven directly. It may cause electric shock, leakage of electricity or damage of the oven.
- Failure to maintain the oven in a clean condition could lead to deterioration of the surface that could adversely affect the life of the appliance and possibly result in a hazardous situation.

Exterior:

The outside may be cleaned with mild soap and warm water, wipe clean with a damp cloth.

NOTE: Please ensure the oven is not splashed with excessive water at all times as it could lead to an electrical failure.

Door:

Wipe the door and window on both sides, the door seals and adjacent parts frequently with a damp cloth to remove any spills or spatters. Always keep the door seals and seal surfaces clean so that any grease, spills or spatters are not allowed to build up. Build-up could result in leakage of microwave energy from the oven.

Touch Control Panel:

Care should be taken in cleaning the touch control panel. Open the oven door before cleaning to inactivate the control panel. Wipe the panel with a cloth dampened slightly with water only.

Do not scrub or use any sort of chemical cleaners. Avoid the use of excess water.

Interior Walls:

To clean the interior surfaces, wipe with a soft cloth and warm water at the end of each day for hygienic reasons. DO NOT USE A COMMERCIAL OVEN CLEANER, ABRASIVE OR HARSH CLEANERS AND SCOURING PADS ON ANY PART OF YOUR MICROWAVE OVEN. NEVER SPRAY OVEN CLEANERS DIRECTLY ONTO ANY PART OF YOUR OVEN.

Avoid using excess water. After cleaning the oven, ensure any water is removed with a soft cloth.

For heavier soil, use mild soap; rinse thoroughly with hot water. Make sure that mild soap or water does not penetrate through the small vents in the walls which may cause damage to the oven.

Ceramic Shelf:

The ceramic shelf should be kept clean at all times. If you leave grease or fat in the cavity, it may overheat, smoke or even catch fire when next using the oven. Minor spills may be wiped with a damp cloth. Operating the unit with excessive buildup may result in cracking or breakage of the ceramic shelf. Do not operate the unit with a cracked or broken ceramic shelf. DO NOT REMOVE THE CERAMIC SHELF FROM OVEN.



Splash Cover:

AT LEAST ONCE A WEEK, REMOVE THE SPLASH COVER AND WASH BOTH SIDES OF IT IN A MILD DETERGENT SOLUTION. A BUILD UP OF GREASE MAY OVERHEAT AND BEGIN TO SMOKE AND MAY BURN THE SPLASH COVER. THE SPLASH COVER IS LOCATED IN THE TOP OF THE OVEN AND MAY EASILY BE REMOVED. REMEMBER TO UNPLUG THE POWER CORD. INSTALL THE SPLASH COVER PROPERLY. OPERATING THE OVEN WITH AN INCORRECTLY INSTALLED SPLASH COVER MAY DAMAGE THE COMPONENTS IN THE OVEN CAVITY AND SHORTEN THE EXPECTED LIFE SPAN OF YOUR OVEN.

SPLASH COVER (Frame + Cover)

Remove the splash cover as shown in Fig. 2 and separate the frame from the cover.

How to Remove the Splash Cover

Remember to unplug the power cord. Turn the 2 tabs holding the oven ceiling cover to the oven cavity ceiling as shown in Fig. 2, then gently pull the cover downwards to separate from the oven cavity ceiling. Then separate the cover from the frame. It is held in place by 4 catches.

COVER:

Wipe any grease, spills or spatters on the oven ceiling cover with a soft cloth dampened with a mild detergent solution. **Don't soak the splash cover in detergent or wash it.**

FRAME:

Wipe any grease, spills or spatters on the frame with a soft cloth dampened with a mild detergent solution. Scrape hardened spills or spatters with a plastic spatula. **Don't use metallic brushes or sharp-edged tools**, as scratches on the frame may cause the frame to warp or break during heating. To remove hardened spills or spatters, soak the frame in a mild detergent solution for a short period of time. **Don't use detergent with orange oil**, as the frame may melt.

How to Install the Splash Cover

Remember to unplug the power cord. Replace the cover in the frame. Insert projection A (2) into the 2 holes in the rear cavity wall and then insert projection B (2) into the 2 holes in the oven cavity ceiling as shown in Fig. 2. Then slide the tabs in place.

ANTENNA COVER

If antenna cover has grease, spills or spatters, wipe antenna cover with a soft cloth dampened with a mild detergent solution. **Don't use metallic brushes or sharp-edged tools**, as scratches on the antenna cover may cause the cover to warp or break during heating.

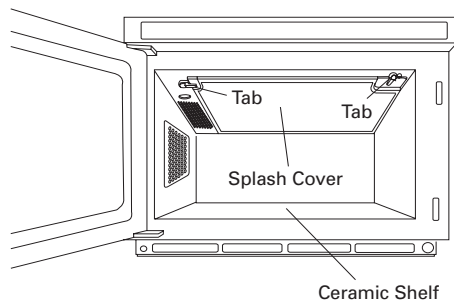

Fig.1

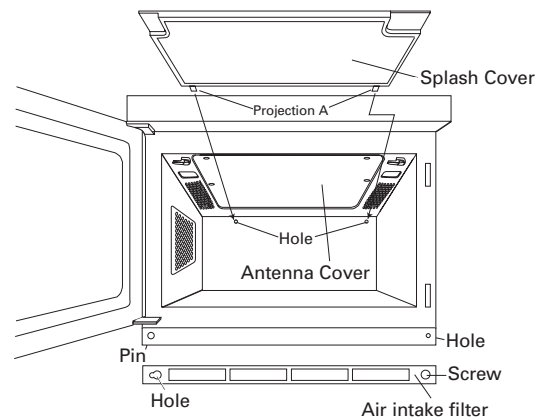

Fig.2

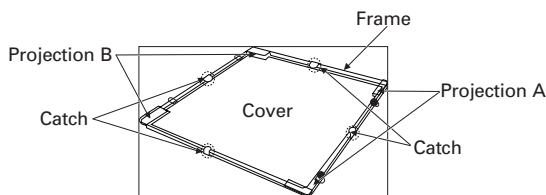

Fig.3 Splash Cover

Keep the air intake filter clean. Clean the air intake filter once every two weeks. (equivalent to 100 hours usage) or more often for heavy use. See Custom Setting 8 Air Intake Filter Counter on page 12. Loosen the screw holding the air intake filter to the oven and move the air intake filter to the left a little bit to remove the air intake filter from the pin.

Wash the air intake filter in mild soapy water, rinse and dry with a soft cloth.

After cleaning re-install the air intake filter.

The screw can be loosened and tightened either by hand or by using a coin.

DO NOT OPERATE THE OVEN WITHOUT THE AIR INTAKE FILTER IN PLACE.





SERVICE CALL CHECK

Please check the following before calling for service:

1. When the door is opened, does the oven lamp come on? YES _____ NO _____
2. Place one cup of water (approx. 250 ml) in a glass measure in the oven and close the door securely. Programme the oven for 30 seconds at 100%.



- A. Does the oven lamp light up during cooking? YES _____ NO _____
- B. Does the "ON" indicator come on? YES _____ NO _____
- C. At the end of 30 seconds, is the water hot? YES _____ NO _____

If "NO" is the answer to any of the above questions, please check your wall socket and the fuse in your meter box. If both the wall socket and the fuse are functioning properly, CONTACT YOUR NEAREST SERVICE CENTRE APPROVED BY SHARP.

IMPORTANT:

If the display shows nothing even if the power supply plug is properly connected, the oven may have shut down automatically. Open the oven door to operate the oven. See Before Operation on page 5.

NOTE:

If time in the display is counting down very rapidly, check Demonstration Mode on page 19.

SPECIFICATIONS

AC Line Voltage:	Single phase 230-240 V, 50 Hz
AC Power Required:	2.8 kW
Output Power:	1900 W *(IEC test procedure)
Microwave Frequency:	2450 MHz **(Class B/Group2)
Outside Dimensions:	445mm(W) x 346mm(H) x 573mm(D) (Single) 445(W) x 692(H) x 573(D) (Two ovens stacked)
Depth with the door open:	932 mm
Cooking Uniformity:	Rotary antenna system
Weight:	Approx. 33.5 kg

* When tested in accordance with AS/NZS 2895.1:2007

** This is the classification of ISM(Industrial, Scientific and Medical) equipment described in the International Standard CISPR 11.



HELPFUL HINTS

1. **THE ARRANGEMENT**
Arrange foods carefully. Place thickest areas toward outside of dish.
2. **TURNING**
Foods such as poultry and joints of meat should be turned over after half the cooking time.
3. **COVERING**
Cover foods in the microwave if you would normally cover the food in your ordinary oven, or to retain moisture. Cover foods such as vegetables, casseroles, or when Reheating.
4. **PIERCING**
Pierce potatoes, eggs, tomatoes or any foods with a skin or membrane to allow steam to escape.
5. **SHIELDING**
Shield using small pieces of aluminium foil to shield thin areas of meat, fish and poultry or edges of cakes to prevent overcooking.
6. **STANDING TIME**
Standing time is important. After cooking or defrosting ensure adequate standing time. This allows the food to continue cooking or heating.
7. **STIRRING**
Stir foods from the outside to the centre of the dish, once or twice during cooking if possible. Eg. casseroles and sauces.
8. **SIZE**
Small pieces cook faster than large ones. To speed cooking, cut pieces smaller than 5 cm so microwaves can penetrate to the centre from all sides. For even cooking, make all the pieces the same size.
9. **DENSITY**
The depth to which microwaves penetrate food varies depending on the food's density. Porous foods like minced beef or mashed potatoes microwave faster than dense ones like steak or whole potatoes
10. **FAT AND BONE**
Marbling within meat, or a thin, even layer of fat on a roast, speeds cooking. Large fatty areas or excess drippings in dish attract energy away from meat, and slows cooking. Centre bones do not affect cooking, but bone on the side of meat conducts heat to the areas next to it.
11. **STARTING TEMPERATURE**
Frozen or refrigerated foods take longer to heat than food at room temperature. Cooking times in this book are based on normal storage temperatures. Since rooms, refrigerators and freezers differ in temperature, check cooking result at the minimum time.
12. **QUANTITY**
Microwave cooking times are directly related to the amount of food in the oven. Because energy is absorbed by the food itself, one potato or a single piece of chicken cooks rapidly. When the energy is divided among several items, cooking takes more time.
13. **CONDENSATION**
Condensation is a normal part of microwave cooking. The humidity and moisture in food will influence the amount of condensation in the oven. Generally, covered foods will not cause as much condensation as uncovered foods. Ensure that the ventilation openings are not blocked.

COOKWARE AND UTENSIL GUIDE

Utensil	Use	Advice
GLASSWARE/ CERAMIC (HEAT RESISTANT)	YES	<p>GLASSWARE</p> <ul style="list-style-type: none"> • Ordinary glass is not suitable for cooking but may be used for short periods for heating foods. <p>CERAMIC</p> <ul style="list-style-type: none"> • Most ovenproof china, and ceramics, are suited. • Avoid dishes that are decorated with gold or silver leaf. • Avoid using antique pottery. • If unsure, check with the manufacturer.
METAL COOKWARE	NO	<ul style="list-style-type: none"> • Metal cookware should be avoided when cooking in the microwave oven. • Microwave energy is reflected by metal.
PLASTIC WRAP OVEN BAGS	YES	<ul style="list-style-type: none"> • Plastic wrap can be used to cover food. • Some shrinkage of the wrap may occur, over an extended cooking time. • When removing wrap, lift it in such a way to avoid steam burns. • Do not tie oven bags with metal twist ties, substitute with string.
ALUMINIUM FOIL	FOR SHIELDING	<ul style="list-style-type: none"> • Small amounts may be used to shield certain parts of meat and fish when cooking or defrosting. • Remove food in foil trays, if possible, and place in a microwave safe dish. • If not possible, place the foil tray onto a heat proof plate allowing 2.5 cm room between the walls of the oven.
STRAW AND WOOD	NO	<ul style="list-style-type: none"> • Excessive over heating of these materials may cause a fire in the microwave oven.
PAPER	YES	<ul style="list-style-type: none"> • Paper towels and waxed paper are suitable to use to prevent splatters. • Ideal for low heat cooking, such as reheating or very short cooking times and for foods with low fat, sugar or water content. <p>Pay special attention as over-heating may cause a fire in your oven.</p>
PLASTIC COOKWARE MICROWAVE SAFE	YES	<ul style="list-style-type: none"> • Ideal for cooking, reheating and defrosting.
THERMOMETERS •MICROWAVE SAFE •CONVENTIONAL	YES NO	



CHARTS

Defrosting Chart

FOOD	DEFROSTING TIME	MICROWAVE POWER LEVEL	METHOD
Beef, Lamb & Pork Joints (uncooked)	8 min. /500g	10%	<ol style="list-style-type: none"> 1. Place on a large plate. 2. Turn over 4-5 times during defrosting. NOTE: If necessary, small pieces of aluminium foil can be used to shield small areas of meat which may become warm during defrosting. 3. After defrosting, wrap in foil and leave to stand for 1-2 hours or until thoroughly defrosted.
Whole Poultry (uncooked)	6-7 min. /500g	10%	As above.
Minced Beef (uncooked)	2-4 min. /500g	30%	<ol style="list-style-type: none"> 1. Place on a plate or in a flan dish. 2. Turn over 2-3 times during defrosting, removing defrosted mince each time. 3. After defrosting, cover any frozen mince remaining with aluminium foil for 15-20 minutes or until thoroughly defrosted.
Sausages (uncooked) Thick Thin	5-6 min. 3-4 min. /500g	10%	<ol style="list-style-type: none"> 1. Place on a large plate, in a single layer if possible. 2. Turn over 2-3 times during defrosting and separate if necessary. 3. After defrosting, cover with aluminium foil and leave to stand for 15-20 minutes or until thoroughly defrosted.
Bacon (uncooked)	5-6 min. /500g	10%	<ol style="list-style-type: none"> 1. Place on a plate. 2. Separate and re-arrange 3-4 times during defrosting. 3. After defrosting, cover with aluminium foil and leave to stand for 5-10 minutes or until thoroughly defrosted.
Sausage Rolls Large (cooked)	1-2 min. for 8 rolls, 375g Total weight	10%	<ol style="list-style-type: none"> 1. Place on a large plate. 2. Turn over and re-arrange halfway through defrosting. 3. After defrosting, cover with foil and leave to stand for 15-30 minutes or until thoroughly defrosted.
Quiche (cooked)	6-7 min. /500g	10%	<ol style="list-style-type: none"> 1. Place on a large plate. 2. After defrosting, cover with foil and leave to stand for 15-30 minutes or until thoroughly defrosted.
Meat Pie (cooked)	4 min. /500g	10%	As above.
Fruit Pie/ Crumble (cooked)	4-5 mins /500g	10%	As above.
Bread Sliced	2-3 min. /800g loaf	30%	<ol style="list-style-type: none"> 1. Arrange and separate slices on the turntable. 2. Turn over, separate and re-arrange twice during defrosting. Remove defrosted slices each time. 3. After defrosting, cover with foil for 5-10 minutes or until thoroughly defrosted.
Bread Buns	1-2 min. for 6 buns	10%	<ol style="list-style-type: none"> 1. Place on turntable. 2. Turn over & re-arrange halfway through defrosting. 3. After defrosting, cover with foil and leave to stand for 10-15 minutes or until thoroughly defrosted.

NOTES:

- Prior to defrosting, food is frozen approx. -18°C.
- If it is necessary to shield small areas of food, use small pieces of foil.
- Only use food which is thoroughly defrosted, use a professional food thermometer to ensure acceptable temperatures have been achieved throughout.





Cooking Chart

FOOD	COOKING TIME	MICROWAVE POWER LEVEL	METHOD
Beef: Medium (Topside, Silverside) Chilled (5°C)	6-7 min. /500g	70%	<ol style="list-style-type: none"> 1. Place fat side down in a flan dish. 2. Turn over halfway through cooking and remove juice. 3. After cooking, wrap in foil and leave to stand for 8 minutes before serving.
Lamb, medium (fillet, shoulder, leg) Chilled (5°C)	6-7 min. /500g	70%	As above.
Pork (loin, leg) Chilled (5°C)	7-8 min. /500g	70%	As above.
Poultry (whole) (max.3.5kg (8lb) Chilled (5°C)	4-5 min. /500g	70%	<ol style="list-style-type: none"> 1. Place breast side down in a flan dish. 2. Turn over halfway through cooking and remove juice. 3. After cooking, wrap in foil and leave to stand for 10 minutes before serving.
Chicken Portions Legs Breast Chilled (5°C)	4-5 min. 6-7 min. /500g	70%	<ol style="list-style-type: none"> 1. Place best side down in a single layer in a flan dish. 2. Turn over halfway through cooking & remove juice. 3. After cooking, wrap in foil and leave to stand for 5 minutes before serving.
Minced Beef Chilled (5°C)	4 min. /500g	70%	<ol style="list-style-type: none"> 1. Place in a large bowl. 2. Stir 2-3 times during cooking. 3. After cooking cover bowl with foil and leave to stand for 2-3 minutes before serving.
Bacon Chilled (5°C)	2 min. for 5 rashers	100%	<ol style="list-style-type: none"> 1. Place in a single layer on a large plate. 2. Turn over halfway through cooking. 3. Leave to stand for 1 minute before serving.
Burgers (Thick) Chilled (5°C)	2 min. for 4 burgers/500g	100%	As above
Sausages (thick) Chilled (50°C) (thin) Chilled (50°C)	3 min. for 6 sausages 3 min. for 8 sausages	100%	As above
Fish Fillet/ Steaks Chilled (5°C)	3 min. /500g	100%	<ol style="list-style-type: none"> 1. Place in a single layer in a large flan dish, cover with microwave cling film and pierce in 4-5 places. 2. Leave to stand for 2-3 minutes before serving.
Trout (whole) Chilled (5°C)	3 min. /500g	70%	As above
Rice/Pasta Room (20°C)	7-8 min. for 230g (one cup)	70%	<ol style="list-style-type: none"> 1. Place Rice/Pasta in a 2.5 litre microwave safe glass bowl. 2. Add three times the volume of boiling water to quantity of rice. Do not cover. 3. Stir 3 times during cooking. 4. Stand for 2-3 minutes before rinsing in boiling water and serving.
Jacket Potatoes Room (20°C)	4-5 min. for 2 potatoes	100%	<ol style="list-style-type: none"> 1. Pierce each potato in several places. 2. Put directly on the oven ceramic shelf. 3. Stand for 3-4 minutes before serving.



Cooking Chart

FOOD	COOKING TIME	MICROWAVE POWER LEVEL	METHOD
Corn on the Cob <i>Fresh</i> (20°C) <i>Frozen</i> (-18°C)	2-3 min. for 2 cobs 4-5 min. for 2 cobs	100%	1. Place in a dish, add 60ml (4tbsp) water. 2. Cover with microwave cling film pierce in 4-5 places. 3. Turn over halfway through cooking. 4. Stand for 1-2 minutes before serving.
Beans (green) <i>Fresh</i> (20°C) <i>Frozen</i> (-18°C)	2 min. for 225g 2-3 min. for 225g	100%	1. Place in a dish, add 30ml (2tbsp) water. 2. Cover with microwave cling film and pierce in 4-5 places. 3. Stir halfway through cooking. 4. Stand for 1-2 minutes before serving.
Broccoli <i>Fresh</i> (20°C) <i>Frozen</i> (-18°C)	2 min. for 225g 3 min. for 225g	100%	As above
Carrots (sliced) <i>Fresh</i> (20°C) <i>Frozen</i> (-18°C)	2 min. for 225g 3 min. for 225g	100%	As above
Carrots (baby, whole) <i>Fresh</i> (20°C) <i>Frozen</i> (-18°C)	2 min. for 225g 3 min. for 225g	100%	As above
Cauliflower <i>Fresh</i> (20°C) <i>Frozen</i> (-18°C)	2 min. for 225g 3 min. for 225g	100%	As above
Peas <i>Fresh</i> (20°C) <i>Frozen</i> (-18°C)	1-2 min. for 225g 2-3 min. for 225g	100%	1. Place in a dish, add 30ml (2tbsp) water. 2. Cover with microwave cling film and pierce in 4-5 places. 3. Stir halfway through cooking. 4. Leave to stand for 1-2 minutes before serving.
New potatoes <i>Room</i> (20°C)	4 min. for 500g	100%	1. Place in a large dish, add 60ml (4tbsp) water. 2. Cover dish with microwave cling film and pierce in 4-5 places. 3. Stir halfway through cooking. 4. Leave to stand for 1-2 minutes before serving.
Mushrooms (fresh) <i>Room</i> (20°C)	1 min. for 225g	70%	1. Chop or leave whole as desired. 2. Place in dish, cover with microwave cling film and pierce in 4-5 places. 3. Stir halfway through cooking.
Tomatoes (fresh) <i>Room</i> (20°C)	1 min for 225g	70%	1. Slice or quarter as desired. NOTE: If you wish to leave whole, pierce in several places. 2. Place in a dish or on a plate, cover with microwave cling film and pierce in 4-5 places. 3. Leave to stand for 1-2 minutes before serving.
Scrambled Egg Chilled (5°C)	2 mins	100%	1. Place 6 large eggs, 150ml milk, 15g butter, salt and pepper in a bowl and beat thoroughly until smooth. 2. Beat 3 times during cooking until desirably set. 3. Leave to stand for 30 seconds before serving.

NOTES:

- Only serve food which is thoroughly cooked, use a professional food thermometer to ensure acceptable temperatures have been reached throughout.
- When cooking joints of meat small pieces of aluminium foil can be used to shield small areas of meat if they start to overcook.
- During standing time food should be covered. If covered during cooking, leave covered. If cooked uncovered, cover with foil.
- The cooking times given above are provided as a guide only. Cooking times will vary according to food weight, quality and initial temperature. Please ensure that food is thoroughly cooked before serving.





Reheating Chart

FOOD	TEMP	QUANTITY	METHOD	REHEATING TIME ON 100%
BREAKFAST				
Porridge	Chilled	125g	Place in a bowl, uncovered	35 sec.
Scrambled Egg	Chilled	125g	Place on a plate, uncovered	30 sec.
Scrambled Egg with bacon or sausage	Chilled	175g	As above	50 sec.
Bacon	Chilled	4 rashers	As above	25 sec.
Sausages - thick	Chilled	4	As above	35 sec.
Sausages-thin	Chilled	8	As above	35 sec.
Smoked Haddock	Chilled	175g	As above	45 sec.
Mushrooms	Chilled	100g	Place in a bowl, uncovered	15 sec.
Fresh Tomatoes	Chilled	100g	As above	15 sec.
HOT SANDWICHES				
Chickenburger	Chilled	135g	Place on a plate, uncovered	35 sec.
Hamburger	Chilled	125g	Place on a plate, uncovered	35 sec.
Cheeseburger	Chilled	175g	As above	35 sec.
Hot Dog	Chilled	175g	As above	35 sec.
Bacon	Chilled	175g	As above	35 sec.
Sausage	Chilled	225g	As above	50 sec.
Beef	Chilled	175g	As above	35 sec.
PREPARED DISHES				
Lasagne	Chilled	300g	1. Place on a plate, cover with cling film 2. Stand covered for 2-3 minutes	2 min. 15 sec.
Chilli con Carne & Rice	Chilled	325g	As above	2 min.
Curry & Rice	Chilled	300g	As above	2 min.
Shepherds Pie	Chilled	300g	As above	1 min. 15 sec.
Stew & Dumplings	Chilled	400g	As above	2 min. 30 sec.
Bangers & Mash	Chilled	325g	Place on a plate, cover with cling film	1 min. 15 sec.





Reheating Chart

FOOD	TEMP	QUANTITY	METHOD	REHEATING TIME ON 100%
PREPARED DISHES				
Duck à l'orange	Chilled	540g	Place on a plate, cover with cling film	3 min. 15 sec.
Spaghetti Bolognese	Chilled	300g	As above	1 min. 15 sec.
Chicken in a sauce	Chilled	300g	As above	2 min. 30 sec.
Beef Stroganoff & Rice	Chilled	375g	As above	2 min. 30 sec.
BBQ Ribs	Chilled	375g	As above	2 min.
Rice/Pasta	Chilled	225g	As above	45 sec.
SAVOURY BREAD AND PASTRY				
Dinner Roll(s)	Chilled	1	Place on the turntable, uncovered	5 sec.
		2	As above	10 sec.
Croissant(s)	Chilled	1	As above	4 sec.
		2	As above	6 sec.
Garlic Bread	Chilled	250g	As above	20 sec.
Pizza Slice	Chilled Frozen	125g	Place on a plate, uncovered	25 sec.
		100g	As above	50 sec.
Pizza - small	Chilled Frozen	75g	As above	15 sec.
		100g	As above	20 sec.
Pizza - large	Chilled Frozen	400g	As above	1 min.
		400g	As above	2 min.
Meat Pie - small	Chilled	125g	1. Place on a plate, uncovered 2. Stand for 2-3 minutes	30 sec.
Meat Pie - large	Chilled	450g	1. Place on a plate, uncovered 2. Stand for 3-4 minutes	1 min. 10 sec.
Quiche - slice	Chilled	125g	1. Place on a plate, uncovered 2. Stand for 2-3 minutes	30 sec.
Quiche - whole	Chilled	540g	1. Place on a plate, uncovered 2. Stand for 3-4 minutes	1 min. 30 sec.
Cornish Pastie(s) (175g) each	Chilled	1	Place on a plate, uncovered	35 sec.
		2	As above	1 min. 10 sec.
Sausage Roll(s) 75g each	Chilled	1	Place on a plate, uncovered	15 sec.
		2	As above	25 sec.



Reheating Chart

FOOD	TEMP	QUANTITY	METHOD	REHEATING TIME ON 100%
CANNED FOODS				
Baked Beans	Room	420g	Place in a bowl, cover with cling film, stir halfway through cooking	1 min. 30 sec.
Soup - thick/thin	Room	420g	As above	1 min. 50 sec.
Hot Dogs	Room	425g	Place in a bowl, cover with cling film	1 min. 45 sec.
Peas	Room	420g	Place in a bowl, cover with cling film, stir halfway through cooking	2 min. 10 sec.
Sweetcorn	Room	420g	As above	1 min. 30 sec.
Carrots - whole, sliced	Room	420g	As above	2 min. 30 sec.
Tomatoes	Room	400g	As above	2 min. 30 sec.
Asparagus	Room	425g	As above	1 min. 50 sec.
Green Beans	Room	410g	Place in a bowl, cover with cling film, stir halfway through cooking	2 min. 30 sec.
FRESH VEGETABLES				
Green Beans	Chilled	125g	Place on a plate, uncovered	30 sec.
Broccoli	Chilled	125g	Place on a plate, uncovered	30 sec.
Carrots - sliced	Chilled	125g	Place on a plate, uncovered	30 sec.
Cauliflower	Chilled	125g	Place on a plate, uncovered	30 sec.
Corn on the Cob	Chilled	200g	Place on a plate, uncovered	1 min. 10 sec.
Peas	Chilled	100g	Place on a plate, uncovered	30 sec.
Jacket Potatoes	Chilled	250g	Place on the turntable, uncovered	1 min.
New Potatoes	Chilled	225g	Place on a plate, uncovered	1 min.
Brussels Sprouts	Chilled	225g	Place on a plate, uncovered	30 sec.



Reheating Chart

FOOD	TEMP	QUANTITY	METHOD	REHEATING TIME ON 100%
MEAT PORTIONS				
Chicken Portions	Chilled	1 (300g)	Place on a plate, cover with cling film	1 min.
Leg Breast	Chilled	1 (400g)	Place on a plate, cover with cling film	1 min. 30 sec.
Lamb Chops	Chilled	3 (225g)	Place on a plate, cover with cling film	1 min. 30 sec.
Pork Chop	Chilled	1 (125g)	Place on a plate, cover with cling film	50 sec.
Sliced Meat with Gravy	Chilled	1 (225g)	Place on a plate, cover with cling film	1 min. 30 sec.
Trout	Chilled	1 (200g)	Place on a plate, cover with cling film	1 min.
Salmon Steak	Chilled	1 (200g)	Place on a plate, cover with cling film	1 min.
SWEET PORTIONS				
Fruit Crumble	Chilled	175g	Place in a bowl, uncovered	35 sec.
Fruit Crumble with custard	Chilled	275g	Place in a bowl, uncovered	1 min.
Fruit Pie	Chilled	175g	Place in a bowl, uncovered	35 sec.
Fruit Pie with Custard	Chilled	275g	Place in a bowl, uncovered	50 sec.
Sponge Pudding	Chilled	125g	Place in a bowl, uncovered	20 sec.
Sponge Pudding with Custard	Chilled	225g	Place in a bowl, uncovered	45 sec.
Suet Pudding	Chilled	175g	Place in a bowl, uncovered	20 sec.
Suet Pudding with Custard	Chilled	275g	Place in a bowl, uncovered	45 sec.
Chocolate Fudge Cake	Chilled	125g	Place on a plate, uncovered	15 sec.

NOTES:

- Only serve food which is thoroughly reheated, use a professional food thermometer to ensure acceptable temperatures have been reached throughout.
- Temperatures referred to in this chart are: *Room*, approx. 20°C, *Chilled*, approx. 5°C, and *Frozen*, approx. -18°C
- During standing time (where recommended) food should be covered. If covered during reheating, leave covered. If reheated uncovered, cover with foil.
- The reheating times given above are provided as a guide only. Reheating times will vary according to food weight, quality and initial temperature. Please ensure that food is thoroughly reheated before serving.

SHARP

WARRANTY

Consumer Electronic Products

Congratulations on Your Purchase!

This Sharp product is warranted against faults in material and manufacture for the period as stated in the table below.

If service is required during the warranty period, please contact your nearest Sharp Approved Service Centre. These repairs would be carried out at no charge to the owner, subject to the conditions specified herein.

This warranty does not extend to defects or injuries caused by or resulting from causes not attributable to faulty parts or the manufacture of the product, including but not limited to, defect or injury caused by or resulting from misuse, abuse, neglect, lack of maintenance, accidental damage, improper voltage, liquid spillage, vermin infestation, software, or any alterations made to the product which are not authorised by Sharp.

Please retain your sales documentation, as this should be produced to validate a warranty claim. This warranty is in addition to and in no way limits, varies or excludes any implied rights and remedies under any relevant legislation in the country of sale.

This warranty does not cover transportation to and from the Sharp Approved Service Centre. Goods presented for repair may be replaced by refurbished goods of the same type rather than being repaired. Refurbished parts may be used to repair the goods. The repair of your goods may result in the loss of user generated data, please ensure that you have saved this data elsewhere prior to repair.

Australian customers: Our goods come with guarantees that cannot be excluded under the Australian Consumer Law. You are entitled to a replacement or refund for a major failure and for compensation for any other reasonably foreseeable loss or damage. You are also entitled to have the goods repaired or replaced if the goods fail to be of acceptable quality and the failure does not amount to a major failure. The criteria of a major failure is defined in the Australian Consumer Law. Should you require any assistance with a major failure please contact Sharp Customer Care.

WARRANTY PERIODS

Home Theatre Projector	12 months	(excluding lamps and air filters)
Audio/Home Theatre	12 months	
Microwave / Steam Oven	12 months	
Slow Juicer	12 months	
Refrigerator	24 months	
DVD/Blu-ray	12 months	
Washing Machine	24 months	
Portable Air Conditioner	12 months	
LCD Television	12 months	
Air Purifier	12 months	
Vacuum Cleaner	24 months	

SHARP
SHARP CORPORATION OF AUSTRALIA PTY. LIMITED
A/BV 40 003 039 405
1 Huntingwood Drive
Huntingwood NSW 2148
SHARP CORPORATION OF NEW ZEALAND LIMITED
59 Hugo Johnston Drive
Penrose, Auckland

SPform 040 (SEPT 2013)

IMPORTANT NOTICE: This warranty applies only to products sold in Australia & New Zealand

SHARP®

FOR LOCATION ENQUIRIES WITHIN

AUSTRALIA

REGARDING YOUR LOCAL
SHARP APPROVED SERVICE CENTRE

VISIT OUR WEBSITE AT

www.sharp.net.au

OR CALL SHARP CUSTOMER CARE

1300 135 022

(LOCAL CALL COSTS APPLY WITHIN AUSTRALIA)

SHARP CORPORATION OF AUSTRALIA PTY LTD

SHARP®

FOR LOCATION ENQUIRIES WITHIN

NEW ZEALAND

REGARDING YOUR LOCAL
SHARP APPROVED SERVICE CENTRE

VISIT OUR WEBSITE AT

www.sharp.net.nz

CONTACT YOUR SELLING DEALER/RETAILER
OR CALL

SHARP CUSTOMER SERVICES

TELEPHONE: 09 573 0111

FACSIMILE: 09 573 0113

SHARP CORPORATION OF NEW ZEALAND LIMITED

SPform019(JUNE 2004)

Free Manuals Download Website

<http://myh66.com>

<http://usermanuals.us>

<http://www.somanuals.com>

<http://www.4manuals.cc>

<http://www.manual-lib.com>

<http://www.404manual.com>

<http://www.luxmanual.com>

<http://aubethermostatmanual.com>

Golf course search by state

<http://golfingnear.com>

Email search by domain

<http://emailbydomain.com>

Auto manuals search

<http://auto.somanuals.com>

TV manuals search

<http://tv.somanuals.com>