

SONY®

3-288-523-13(1)

Digital HD Video Camera Recorder

HANDYCAM®

Operating Guide

HDR-TG1E/TG3E

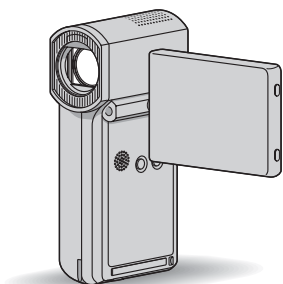

AVCHD

 **MEMORY STICK™**

 **InfoLITHIUM™**  **H**
SERIES

HDMI

For details on the advanced operations, please refer to
“Handycam Handbook” (PDF).



Read this first

Before operating the unit, please read this manual thoroughly, and retain it for future reference.

WARNING

To reduce fire or shock hazard, do not expose the unit to rain or moisture.



Do not expose the batteries to excessive heat such as sunshine, fire or the like.

CAUTION

Replace the battery with the specified type only. Otherwise, fire or injury may result.

Notice for customers in the United Kingdom

A moulded plug complying with BS 1363 is fitted to this equipment for your safety and convenience.

Should the fuse in the plug supplied need to be replaced, a fuse of the same rating as the supplied one and approved by ASTA or BSI to BS 1362 (i.e., marked with an  or  mark) must be used.

If the plug supplied with this equipment has a detachable fuse cover, be sure to attach the fuse cover after you change the fuse. Never use the plug without the fuse cover. If you should lose the fuse cover, please contact your nearest Sony service station.

FOR CUSTOMERS IN EUROPE

ATTENTION

The electromagnetic fields at the specific frequencies may influence the picture and sound of this unit.

This product has been tested and found compliant with the limits set out in the EMC Directive for using connection cables shorter than 3 meters (9.8 feet).

Notice

If static electricity or electromagnetism causes data transfer to discontinue midway (fail), restart the application or disconnect and connect the communication cable (USB, etc.) again.



Disposal of Old Electrical & Electronic Equipment (Applicable in the European Union and other European countries with separate collection systems)

This symbol on the product or on its packaging indicates that this product shall not be treated as household waste. Instead it shall be handed over to the applicable collection point for the recycling of electrical and electronic equipment.

By ensuring this product is disposed of correctly, you will help prevent potential negative consequences for the environment and human health, which could otherwise be caused by inappropriate waste handling of this product. The recycling of materials will help to conserve natural resources. For more detailed information about recycling of this product, please contact your local Civic Office, your household waste disposal service or the shop where you purchased the product.

Applicable Accessories: "Memory Stick PRO Duo," Dedicated USB Terminal Adaptor



Disposal of waste batteries (applicable in the European Union and other European countries with separate collection systems)

This symbol on the battery or on the packaging indicates that the battery provided with this product shall not be treated as household waste.

By ensuring these batteries are disposed of correctly, you will help prevent potentially negative consequences for the environment

and human health which could otherwise be caused by inappropriate waste handling of the battery. The recycling of the materials will help to conserve natural resources.

In case of products that for safety, performance or data integrity reasons require a permanent connection with an incorporated battery, this battery should be replaced by qualified service staff only. To ensure that the battery will be treated properly, hand over the product at end-of-life to the applicable collection point for the recycling of electrical and electronic equipment.

For all other batteries, please view the section on how to remove the battery from the product safely. Hand the battery over to the applicable collection point for the recycling of waste batteries.

For more detailed information about recycling of this product or battery, please contact your local Civic Office, your household waste disposal service or the shop where you purchased the product.

Notice for the customers in the countries applying EU Directives

The manufacturer of this product is Sony Corporation, 1-7-1 Konan Minato-ku Tokyo, 108-0075 Japan. The Authorized Representative for EMC and product safety is Sony Deutschland GmbH, Hedelfinger Strasse 61, 70327 Stuttgart, Germany. For any service or guarantee matters please refer to the addresses given in separate service or guarantee documents.

“Memory Stick”



N50

For customers in the U.S.A.

If you have any questions about this product, you may call:
Sony Customer Information Center 1-800-222-SONY (7669).

The number below is for the FCC related matters only.

Regulatory Information

Declaration of Conformity

Trade Name: SONY

Model No.: HDR-TG1E

Responsible Party: Sony Electronics Inc.

Address: 16530 Via Esprillo, San Diego, CA 92127 U.S.A.

Telephone number: 858-942-2230

This device complies with Part 15 of the FCC Rules. Operation is subject to the following two conditions: (1) This device may not cause harmful interference, and (2) this device must accept any interference received, including interference that may cause undesired operation.

Notes

HDR-TG1E is to be used with the Handycam Station Model DCRA-C230 and AC Adaptor Model AC-L200/L200B.

CAUTION

You are cautioned that any changes or modifications not expressly approved in this manual could void your authority to operate this equipment.

Note

This equipment has been tested and found to comply with the limits for a Class B digital device, pursuant to Part 15 of the FCC Rules.

These limits are designed to provide reasonable protection against harmful interference in a residential installation. This equipment generates, uses, and can radiate radio frequency energy and, if not installed and used in accordance with the instructions, may cause harmful interference to radio communications.

However, there is no guarantee that interference will not occur in a particular installation. If this equipment does cause harmful interference to radio or television reception, which can be determined by turning the equipment off and on, the user is encouraged to try to correct the interference by one or more of the following measures:

- Reorient or relocate the receiving antenna.
- Increase the separation between the equipment and receiver.
- Connect the equipment into an outlet on a circuit different from that to which the receiver is connected.
- Consult the dealer or an experienced radio/TV technician for help.

The supplied interface cable must be used with the equipment in order to comply with the limits for a digital device pursuant to Subpart B of Part 15 of FCC Rules.

Battery pack and “Memory Stick PRO Duo”

This device complies with Part 15 of the FCC Rules. Operation is subject to the following two conditions:

- (1) This device may not cause harmful interference, and (2) this device must accept any interference received, including interference that may cause undesired operation.

This Class B digital apparatus complies with Canadian ICES-003.

Notes on use

Supplied items

The numbers in () are the supplied quantity.

- “Memory Stick PRO Duo” 4 GB (1)
- AC Adaptor (1)
- Power cord (Mains lead) (1)
- Handycam Station (1) **A**
- Component A/V cable (1) **B**
- A/V connecting cable (1) **C**
- USB cable (long) (1) **D**
- USB cable (short) (1) **E**
- Dedicated USB Terminal Adaptor (1) **F**
- USB adaptor cap (1) **G**
- 21-pin adaptor (1)

For the models with **CE** the mark printed on their bottom surfaces only.

- Rechargeable battery pack NP-FH50 (1)
- Wrist strap (1)
- CD-ROM “Handycam Application Software” (1) (p. 26)
 - Picture Motion Browser (Software)
 - PMB Guide
 - Handycam Handbook (PDF)
- “Operating Guide” (This manual) (1)

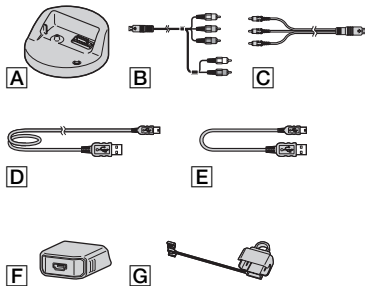



- * The Dedicated USB Terminal Adaptor **F** and the USB adaptor cap **G** are attached to the USB cable (short) **E** beforehand.

Types of “Memory Stick” you can use with your camcorder

- For recording movies, it is recommended that you use a “Memory Stick PRO Duo” of 1 GB or larger marked with:
 - **MEMORY STICK PRO DUO** (“Memory Stick PRO Duo”)*
 - **MEMORY STICK PRO-HG DUO** (“Memory Stick PRO-HG Duo”)
- * Marked with Mark2 or not, either can be used.
- A “Memory Stick PRO Duo” of up to 16 GB has been confirmed to operate correctly with this camcorder.
- See page 14 for the recordable time of a “Memory Stick PRO Duo.”
- “Memory Stick PRO Duo” and “Memory Stick PRO-HG Duo” are both called as “Memory Stick PRO Duo” in this manual.

Using the camcorder

- The camcorder is not dustproofed, dripproofed or waterproofed. See “Precautions” (p. 32).
- Do not do any of the following when the  (Movie) or  (Still) mode lamps (p. 10), the access lamp (p. 12) or the QUICK ON lamp (p. 7) is lit or flashing. Otherwise, the “Memory Stick PRO Duo” may be damaged, recorded images may be lost or other malfunctions could occur.
 - Eject the “Memory Stick PRO Duo”
 - Remove the battery pack or AC Adaptor from the camcorder.
 - Apply mechanical shock or vibration to the camcorder.
- If you close the LCD panel when your camcorder is connected to other devices with the USB cable, the recorded images may be lost.
- When inserting or ejecting the “Memory Stick PRO Duo,” be careful so that the “Memory Stick PRO Duo” does not pop out and drop (p. 12).
- When connecting your camcorder to another device with a cable, be sure to insert the connector plug in the correct way. Pushing the plug forcibly into the terminal will damage the terminal and may result in a malfunction of your camcorder.
- If you repeat recording/deleting images for a long time, fragmentation of data occurs on the media. Images cannot be saved or recorded. In such a case, save your images on some type of

external media first, and then perform [MEDIA FORMAT] (p. 24).

- The LCD screen is manufactured using extremely high-precision technology, so over 99.99% of the pixels are operational for effective use. However, there may be some tiny black points and/or bright points (white, red, blue, or green in color) that appear constantly on the LCD screen. These points are normal results of the manufacturing process and do not affect the recording in any way.

On recording

- Before starting to record, test the recording function to make sure the image and sound are recorded without any problems.
- Compensation for the contents of recordings cannot be provided, even if recording or playback is not possible due to a malfunction of the camcorder, recording media, etc.
- TV color systems differ depending on the country/region. To view your recordings on a TV, you need a PAL system-based TV.
- Television programs, films, video tapes, and other materials may be copyrighted. Unauthorized recording of such materials may be contrary to the copyright laws.

On playing back recorded images on other devices

- Your camcorder is compatible with MPEG-4 AVC/H.264 High Profile for HD (high definition) image quality recording. Therefore, you cannot play back images recorded with HD (high definition) image quality on your camcorder with the following devices:
 - Other AVCHD format compatible devices which are not compatible with High Profile
 - Devices which are not compatible with the AVCHD format

Save all your recorded image data

- To prevent your image data from being lost, save all your recorded images on other media. It is recommended that you save the image data on a disc such as DVD-R using your computer, etc. Also, you can save your image data using a VCR, or a DVD/HDD recorder (p. 23).
- It is recommended that you save your image data periodically, after recording.

Table of Contents

When the camcorder is connected to a computer

- Do not try to format the “Memory Stick PRO Duo” in the camcorder using a computer. If you do so, your camcorder may not operate correctly.

About language setting

- The on-screen displays in each local language are used for illustrating the operating procedures. Change the screen language before using your camcorder if necessary (p. 11).

About this manual



- The images of the LCD screen used in this manual for illustration purposes are captured using a digital still camera, and therefore may appear different from the actual images of the LCD screen.
- Design and specifications of your camcorder and accessories are subject to change without notice.
- The screenshots are from Windows Vista. The scenes may vary depending on the operating system of the computer.
- Refer also to “Handycam Handbook” (PDF) and “PMB Guide.”

Read this first 2

Getting Started

Step 1: Charging the battery pack... 7	
Step 2: Turning the power on, and setting the date and time 10	
Changing the language setting 11	
Step 3: Inserting a “Memory Stick PRO Duo” 12	

Recording/Playback

Recording 13	
Playback 15	
Playing the image on a TV 16	
Name and functions of each part .. 17	
Indicators displayed during recording/playback 19	
Performing various functions - “  HOME” and “  OPTION” 21	
Saving images 23	
Deleting images 24	

Enjoying with a computer

Performing with a computer 26	
Installing and viewing “Handycam Handbook” (PDF) 26	
Installing “Picture Motion Browser” 26	

Troubleshooting

Troubleshooting 30	
--------------------------	--

Additional Information

Precautions 32	
Specifications 33	

Step 1: Charging the battery pack

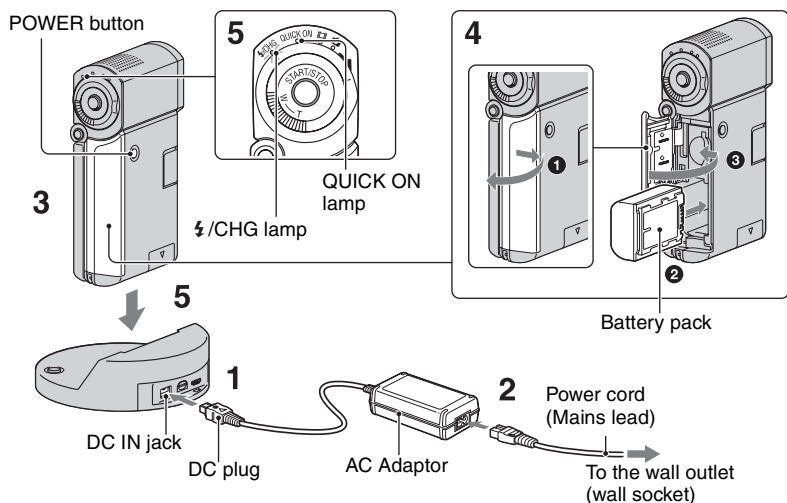

You can charge the “InfoLITHIUM” battery pack NP-FH50 after attaching it to your camcorder.

Notes

- You cannot attach any “InfoLITHIUM” battery pack other than NP-FH50 to your camcorder.

1 Connect the AC Adaptor to the DC IN jack on the Handycam Station.

Be sure that the ▲ mark on the DC plug is facing up.

2 Connect the power cord (mains lead) to the AC Adaptor and the wall outlet (wall socket).

3 Make sure that the LCD panel is closed.

4 Insert the battery.

- Open the battery/Memory Stick Duo cover.
- Insert the battery pack all the way in until it clicks.
- Close the battery/Memory Stick Duo cover.

5 Place the camcorder on the Handycam Station as shown above, and insert it into the Handycam Station securely, all the way to the bottom.

The BATTERY/CHG (charge) lamp lights up and charging starts. The BATTERY/CHG (charge) lamp turns off when the battery pack is fully charged. Remove the camcorder from the Handycam Station.

Notes



- You cannot charge the battery pack while the QUICK ON lamp is flashing. When the QUICK ON lamp is flashing, press POWER to turn off your camcorder. Make sure the QUICK ON lamp is not flashing before charging the battery pack.

To remove the battery pack

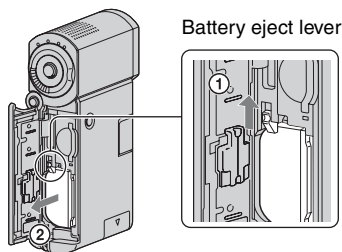
Turn off your camcorder and open the battery/Memory Stick Duo cover. Slide the battery eject lever. Be sure not to drop the battery pack.



Notes

- When you remove the battery pack or disconnect the AC Adaptor, make sure that the  (Movie) lamp/ (Still) lamp (p. 10)/access lamp (p. 12)/QUICK ON lamp are turned off.

To charge the battery pack using only the AC Adaptor

Close the LCD panel with your camcorder turns off, then connect the AC Adaptor to the DC IN jack on your camcorder.

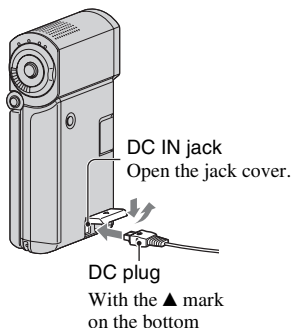

Available running time for the supplied battery pack

Charging time:

Approximate time (min.) required when you fully charge a completely exhausted battery pack.

Recording/Playback time:

Approximate time (min.) available when you use a fully charged battery pack.

“HD” stands for high definition image quality, and “SD” stands for standard image quality.



	(Unit:min.)	
	HD	SD
Charging time	135	
Recording time*1*2		
Continuous recording time	100	120
Typical recording time*3	50	60
Playback time*2	135	145

*1 [REC MODE]: SP

*2 When the LCD backlight is on.

*3 Typical recording time shows the time when you repeat recording start/stop, turning the power on/off and zooming.

On the battery pack

- When you remove the battery pack, turn off your camcorder, and turn off the  (Movie) lamp/ (Still) lamp (p. 10)/access lamp (p. 12)/QUICK ON lamp.
- The power will not be supplied from the battery as long as the AC Adaptor is connected to the DC IN jack of your camcorder or the Handycam Station, even when the power cord (mains lead) is disconnected from the wall outlet (wall socket).

On the charging/recording/playback time

- Times measured when using the camcorder at 25°C (77°F) (10°C to 30°C (50°F to 86°F) is recommended).
- The available recording and playback time will be shorter when you use your camcorder in low temperatures.
- The available recording and playback time will be shorter depending on the conditions under which you use your camcorder.

On the AC Adaptor

- Use the nearby wall outlet (wall socket) when using the AC Adaptor. Disconnect the AC Adaptor from the wall outlet (wall socket) immediately if any malfunction occurs while using your camcorder.
- Do not use the AC Adaptor placed in a narrow space, such as between a wall and furniture.
- Do not short-circuit the DC plug of the AC Adaptor or battery terminal with any metallic objects. This may cause a malfunction.
- Even if your camcorder is turned off, AC power source (mains) is still supplied to it while connected to the wall outlet (wall socket) via the AC Adaptor.

On using abroad

- You can use your camcorder in any countries/regions using the AC Adaptor supplied with your camcorder. Also, you can charge the battery pack.
Use a commercially available AC plug adaptor, if necessary, depending on the design of the wall outlet (wall socket).
See “Handycam Handbook” (PDF) for details.

Step 2: Turning the power on, and setting the date and time

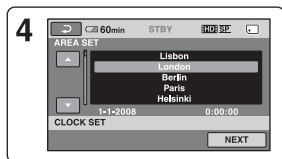

When using the camcorder for the first time, the [CLOCK SET] screen appears on the LCD screen.

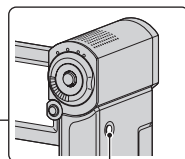

POWER button

↑ (HOME)

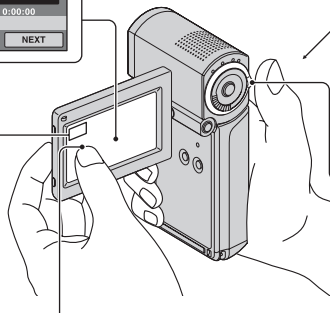

Touch the button on the LCD screen.

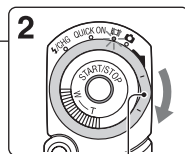

⏏ (Movie) / 📷 (Still)
select switch

1 Open the LCD panel.

Your camcorder turns on.

To turn on your camcorder when the LCD panel is opened, close it and open it again, or press POWER with the LCD panel opened.

To adjust the LCD panel, open the LCD panel 90 degrees to the camcorder (①), then rotate it to the best angle to record or play (②). You can rotate the LCD panel 270 degrees to the lens side (②) to record in mirror mode.

②270 degrees (max.)

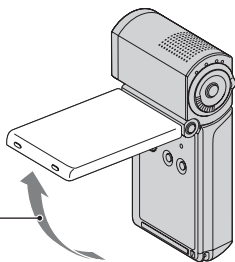
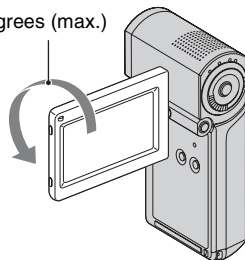

①90 degrees
to the
camcorder

2 Slide the ⏏ (Movie) / 📷 (Still) select switch repeatedly in the direction of the arrow until the respective lamp lights up.

⏏ (Movie): To record movies

📷 (Still): To record still images

Go to step 4 when you turn on your camcorder for the first time.

- When you turn on 📷 (Still) lamp, the screen aspect ratio is changed to 4:3 automatically (the default setting).

3 Touch **HOME** → **SETTINGS** → **[CLOCK/ LANG]** → **[CLOCK SET]**.

4 Select the desired geographical area with **▲/▼**, then touch **[NEXT]**.

5 Set **[SUMMERTIME]**, **[Y]** (year), **[M]** (month), **[D]** (day), hour and minute, then touch **[OK]**.



The clock starts.

Changing the language setting

You can change the on-screen displays to show messages in a specified language.

Touch **HOME** → **SETTINGS** → **[CLOCK/ LANG]** → **[LANGUAGE SET]**, then select the desired language.

To turn off the power

When recording standby/recording mode, close the LCD panel, then press **POWER**. Otherwise, close the LCD panel or press **POWER**.

Tips

- The date and time do not appear during recording, but they are automatically recorded on the “Memory Stick PRO Duo,” and can be displayed during playback.
- You can turn off the operation beeps by touching **HOME** → **SETTINGS** → **[SOUND/DISP SET]** → **[BEEP]** → **[OFF]**.
- When you close the LCD panel during standby/recording, the **QUICK ON** lamp starts flashing and your camcorder goes to sleep mode. If **[QUICK ON STBY]** is set to **[OFF]** on the **HOME MENU** (p. 22), closing the LCD panel makes your camcorder turn off.

Step 3: Inserting a “Memory Stick PRO Duo”

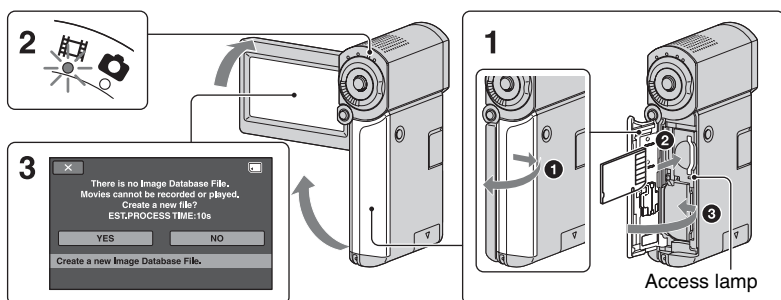

If you insert a new “Memory Stick PRO Duo,” the [Create a new Image Database File.] screen appears.

See page 5 on the “Memory Stick” you can use with your camcorder.

1 Insert the “Memory Stick PRO Duo.”

- 1 Open the battery/Memory Stick Duo cover.
- 2 Insert the “Memory Stick PRO Duo” all the way in until it clicks.
- 3 Close the battery/Memory Stick Duo cover.



2 Open the LCD panel and turn on the (Movie) lamp.

3 On the [Create a new Image Database File.] screen, touch [YES].

To eject a “Memory Stick PRO Duo”

Open the battery/Memory Stick Duo cover, lightly push the “Memory Stick PRO Duo” in once.

Notes

- Do not do any of the following when the  (Movie) /  (Still) mode lamps (p. 10), the access lamp or the QUICK ON lamp (p. 7) is lit or flashing. Otherwise, the media may be damaged, recorded images may be lost or other malfunctions could occur.
 - Eject the “Memory Stick PRO Duo” from the camcorder
 - Remove the battery pack or AC Adaptor
 - Shake or knock your camcorder
- Do not open the battery/Memory Stick Duo cover during recording.
- If you force the “Memory Stick PRO Duo” into the slot in the wrong direction, the “Memory Stick PRO Duo,” the Memory Stick Duo slot, or image data may be damaged.
- If [Failed to create a new Image Database File. It may be possible that there is not enough free space.] is displayed in step 3, format the “Memory Stick PRO Duo” (p. 24). Note that formatting will delete all data recorded on the “Memory Stick PRO Duo.”

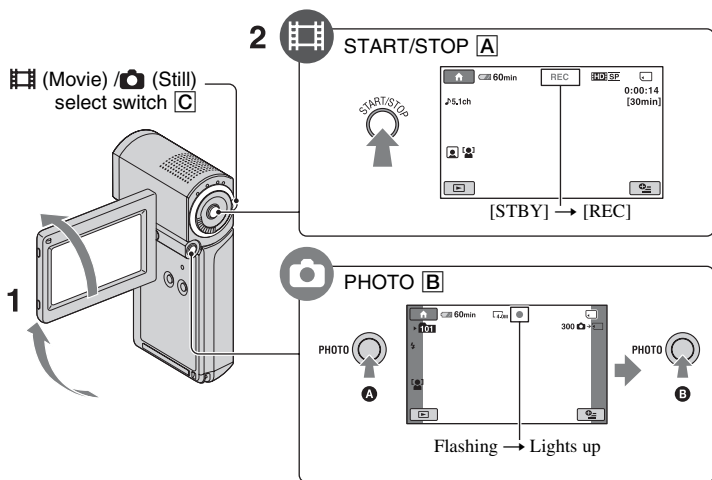

1 Open the LCD panel.

2 Slide the (Movie)/(Still) select switch C until the respective lamp lights up.

- (Movie): To record movies
- (Still): To record still images

3 Start recording.

Movies



Press START/STOP A.

To stop recording, press START/STOP A again.

- See “Handycam Handbook” (PDF) to display the image of SD (standard definition) image quality.

Still Images





Press PHOTO B lightly to adjust the focus A (a beep sounds), then press it fully B (a shutter click sounds).

■■■■■ appears beside □. When ■■■■■ disappears, the image has been recorded.

Notes

- If you close the LCD panel during recording, the recording will be stopped.

Tips

- You can check the free “Memory Stick PRO Duo” space by touching  (HOME) →  (MANAGE MEDIA) → [MEDIA INFO].
- You can capture still images by pressing PHOTO  during movie recording.
- When a movie file exceeds 2 GB, the next movie file is created automatically.
- The maximum recordable time of Sony “Memory Stick PRO Duo” is as follows with recording mode [HD SP] (the default setting);
 - 1 GB: approx. 15 minutes
 - 2 GB: approx. 30 minutes
 - 4 GB: approx. 65 minutes
 - 8 GB: approx. 140 minutes
 - 16 GB: approx. 280 minutes
- When measuring “Memory Stick PRO Duo” capacity, 1 GB equals 1 billion bytes, a portion of which is used for data management.
- Check the number of recordable still images on the LCD screen of your camcorder (p. 19).
- You can capture still images from recorded movies (HDR-TG1E). See “Handycam Handbook” (PDF) for details.

Playback

2 (VIEW IMAGES)

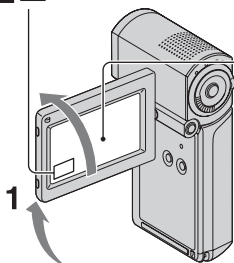

3

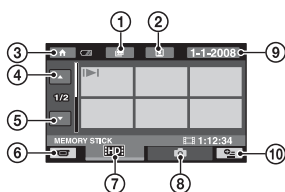

- ① Goes to the (Film Roll Index) screen
- ② Goes to the (Face Index) screen
- ③ Goes to (HOME)
- ④ Previous 6 images
- ⑤ Next 6 images
- ⑥ Returns to the recording screen

- ⑦ Displays movies with HD (high definition) image quality*
- ⑧ Displays still images
- ⑨ Searches for images by date
- ⑩ (OPTION)

* appears when you select the movie with SD (standard definition) image quality.

1 Open the LCD panel to turn on your camcorder.

2 Touch (VIEW IMAGES).

The VISUAL INDEX screen appears on the LCD screen (It may take some time to display the thumbnails).

3 Start playback.

Movies



Touch the or tab, then select the desired movie to play back.

Beginning of the scene/previous scene

Toggles Play or Pause as you touch

Next scene

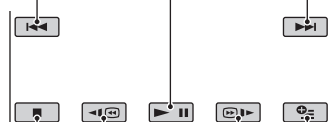

Stop (go to the INDEX screen)

Reverse/Forward

OPTION

Still Images



Touch the tab, then select the desired still image to play back.

Slide show

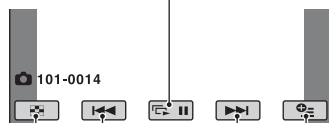

Go to the VISUAL INDEX screen

Previous/Next

OPTION

To adjust the sound volume of movies

When playing back a movie, touch \oplus (OPTION) \rightarrow \square tab \rightarrow [VOLUME], then adjust the volume with \square / \square .

Tips

- On the VISUAL INDEX screen, \blacktriangleright appears with the image on the tab that was most recently played back/recorded (\blacktriangleright for the still image). When you touch a movie marked with \blacktriangleright , you can play it back from the point it was previously stopped.

Playing the image on a TV

Connection methods and quality of the image (HD (high definition)/SD (standard definition)) viewed on the TV screen differ depending on what type of TV is connected, and the connectors used.

Use the supplied AC Adaptor as the power source (p. 7).

Refer also to the instruction manuals supplied with the device to be connected.

Notes

- When recording, set [X.V.COLOR] to [ON] to play back on an x.v.Color-compliant TV. Some settings may need to be adjusted on the TV when playing back. Refer to the instruction manual of your TV for details.

Operation flow

Switch the input on the TV to the connected jack.

Refer to the instruction manuals of the TV.

Connect your camcorder and TV referring to [TV CONNECT Guide].

Touch HOME \rightarrow OTHERS \rightarrow [TV CONNECT Guide].

Make the required output settings on your camcorder.

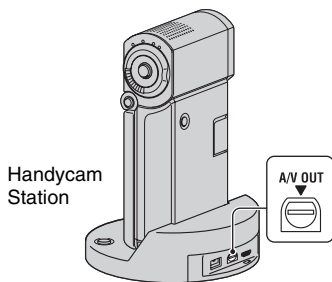
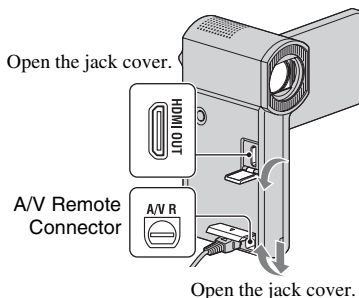

Notes

- When the A/V connecting cable is used to output images, images are output with SD (standard definition) image quality.
- Your camcorder and the Handycam Station are equipped with A/V Remote Connector or A/V OUT jack. Connect the A/V connecting cable or component A/V cable either to the Handycam Station or to your camcorder. If you connect A/V connecting cables or component A/V cable to both the Handycam Station and your camcorder at the same time, image disturbance may occur.

Name and functions of each part

Buttons, jacks, etc., which are not explained in other chapters, are explained here.

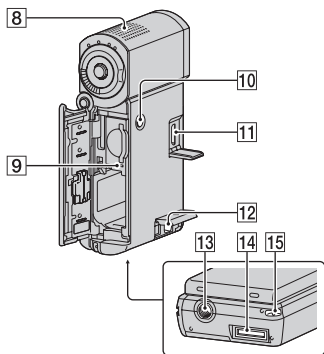
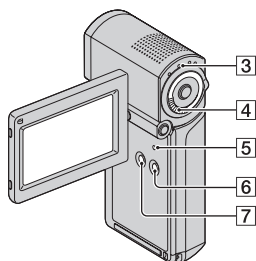
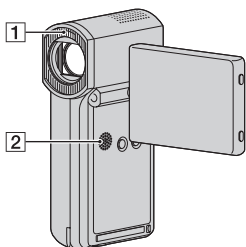

Handycam Station

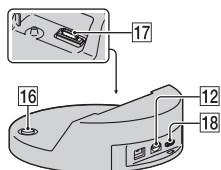

Recording/Playback

1 Flash

The flash will flash automatically depending on recording conditions in the default setting.

Touch (HOME) → (SETTINGS) → [PHOTO SETTINGS] → [FLASH MODE] to change the setting.

2 Speaker

3 QUICK ON lamp

Flashes during sleep mode. When you open the LCD panel while the QUICK ON lamp is flashing, you can start recording in about 1 second (QUICK ON).

The flashing stops and the power turns off automatically if you do not operate your camcorder for a certain period during sleep mode ([QUICK ON STBY], p. 22).

4 Power zoom lever

Move the power zoom lever slightly for a slower zoom. Move it further for a faster zoom.

You can magnify still images from about 1.1 to 5 times the original size (Playback zoom).

- When you touch the screen during playback zoom, the point you touched will be displayed in the center of the LCD screen.

5 RESET button

Press RESET to initialize all the settings including the clock setting.

6 EASY button

Press EASY to display and most of the settings are set automatically for easy recording/playback. To cancel, press EASY again.

7 DISP/BATT INFO button

You can switch the screen display when you press DISP/BATT INFO while the power is on.

You can check the remaining battery when you press it after you open the LCD panel and press POWER to turn off your camcorder.

8 Built-in microphone

Sound picked up by the internal microphone is converted to 5.1ch surround sound and recorded.

9 Access lamp

When the access lamp is lit or flashing, your camcorder is writing/reading data on the “Memory Stick PRO Duo.”

10 POWER button

Press POWER to turn on your camcorder. When you press it while the power is on, your camcorder turns off.

- When you press POWER to turn on your camcorder while the LCD panel is closed, your camcorder goes to sleep mode. When you press POWER while sleep mode, your camcorder turns off.

13 Tripod receptacle (Bottom surface)

Attach a tripod (optional) to the tripod receptacle using a tripod screw (optional: the length of the screw must be less than 5.5 mm (7/32 in.)).

15 Hook for wrist strap (Bottom surface)

Attach the strap and place your hand through the loop to prevent the camcorder from damage by being dropped.

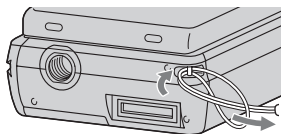

Connecting to other devices

11 HDMI OUT jack

Connect with the HDMI cable (optional).

12 A/V Remote Connector/A/V OUT jack

Connect with the component A/V cable or A/V connecting cable.

14 Interface connector (Bottom surface)

Connect your camcorder and the Handycam Station or the Dedicated USB Terminal Adaptor.

By attaching the Dedicated USB Terminal Adaptor, you can connect the USB cable to your camcorder without using the Handycam Station.

16 (DISC BURN) button

Create a disc by connecting the camcorder to a computer, etc. For details, see “PMB Guide” (p. 28).

17 Interface connector (Handycam Station)

Connect to the interface connector on your camcorder when you attach your camcorder to the Handycam Station.

18 (USB) jack

Connect with the USB cable.

- For HDR-TG3E: output only

Indicators displayed during recording/playback

Recording movies

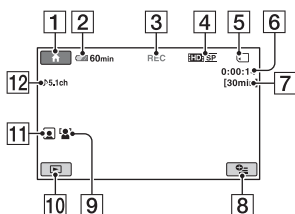

Recording still images

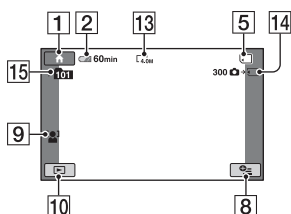

Viewing movies

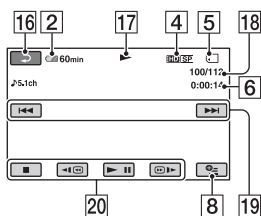

Viewing still images

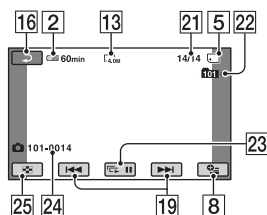

- 1 HOME button
- 2 Remaining battery (approx.)
- 3 Recording status ([STBY] (standby) or [REC] (recording))
- 4 Recording quality (HD/SD) and Recording mode (FH/HQ/SP/LP)
- 5 Media
- 6 Counter (hour/minute/second)
- 7 Recording remaining time
- 8 OPTION button
- 9 FACE DETECTION
- 10 VIEW IMAGES button
- 11 Face Index set
- 12 5.1ch surround recording
- 13 Image size
- 14 Approximate number of recordable still images and media/During still image recording
- 15 Recording folder
- 16 Return button
- 17 Playback mode
- 18 Currently playing movie number/ Number of total recorded movies
- 19 Previous/Next button
- 20 Video operation buttons
- 21 Currently playing still image number/ Number of total recorded still images
- 22 Playback folder
- 23 Slide show button
- 24 Data file name
- 25 VISUAL INDEX button

Indicators on the LCD screens

Following indicators appear during recording/playback to indicate the settings of your camcorder.

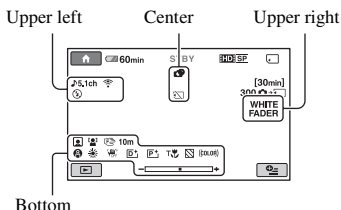

Upper left

Indicator	Meaning
J5.1ch J2ch	AUDIO MODE
	Self-timer recording
	Flash, REDEYE REDUC
	MICREF LEVEL low
	WIDE SELECT
	BLT-IN ZOOM MIC

Center

Indicator	Meaning
	IMAGE SIZE
	Continuous slide show
	Color Slow Shutter
	PictBridge connecting
	Warning

Upper right

Indicator	Meaning
WHITE FADER BLACK FADER	FADER
	LCD backlight off



Bottom

Indicator	Meaning
	Picture effect
	Digital effect
	Manual focus
	SCENE SELECTION
	White balance
	SteadyShot off
	EXPOSURE/ SPOT METER
	TELE MACRO
	ZEBRA
	X.V.COLOR
	Face Index
	FACE DETECTION

💡 Tips

- Indicators and their positions are approximate and differ from what you actually see. See “Handycam Handbook” (PDF) for details.
- The recording date and time are recorded automatically on the “Memory Stick PRO Duo.” They are not displayed while recording. However, you can check them as [DATA CODE] during playback.

Performing various functions - “ HOME” and “ OPTION”

You can display the menu screen by touching  (HOME)/ (OPTION). For details of the menu items, see “Handycam Handbook” (PDF) (p. 26).

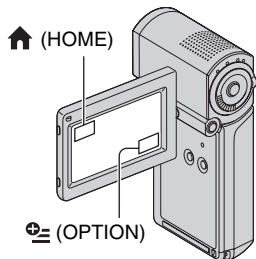

Using the HOME MENU

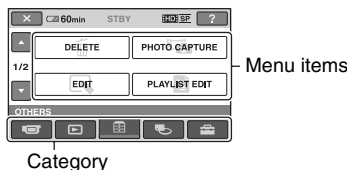

You can change the operating settings for your convenience. Touch  (HOME) to display the menu screen.





1 Touch the desired category then item to change the setting.

2 Follow the instructions on the screen.

Tips

- If the item is not on the screen, touch / to change the page.
- To hide the HOME MENU screen, touch .
- You cannot simultaneously select or activate the grayed items in the current recording/playback situation.

To see the explanation of the HOME MENU (HELP)



- ① Touch .
- ② Touch .

The bottom of  (HELP) turns orange.



- ③ Touch the item you want to learn about. When you touch an item, its explanation appears on the screen. To apply the selected item, touch [YES].

Using the OPTION MENU

The  OPTION MENU appears just like the pop-up window that appears when you right-click the mouse on a computer. Press  (OPTION) to display the menu items you can change in the current situation.

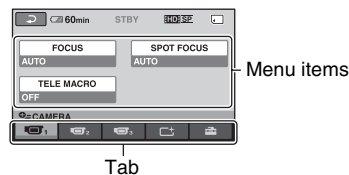

1 Touch the desired tab then item to change the setting.























2 After completing the setting, touch .







Notes

- When the item you want is not on the screen, touch another tab. If you cannot find the item anywhere, the function is not available under the current situation.

- The  (OPTION) MENU cannot be used during Easy Handycam operation.

Items of the HOME MENU

 (CAMERA) category	
MOVIE*	
PHOTO*	
SMTH SLW REC	
 (VIEW IMAGES) category	
VISUAL INDEX*	
 INDEX*	
 INDEX*	
PLAYLIST	
 (OTHERS) category	
DELETE*  DELETE],  DELETE]	
PHOTO CAPTURE (HDR-TG1E)	
EDIT  DELETE],  DELETE], [DIVIDE]	
PLAYLIST  ADD],  ADD],	
EDIT  ADD by date],  ADD by date],  ERASE],  ERASE],  ERASE ALL],  ERASE ALL],  MOVE],  MOVE]	
PRINT	
USB  USB CONNECT], [DISC CONNECT BURN]	
TV CONNECT Guide*	
 (MANAGE MEDIA) category	
  SET	
MEDIA INFO	
MEDIA FORMAT*	
REPAIR IMG.DB F.	

 (SETTINGS) category	
MOVIE [REC MODE], [AUDIO SETTINGS MODE], [WIDE SELECT], [DIGITAL ZOOM], [STEADYSHOT], [AUTO SLW SHUTTR], [X.V.COLOR], [GUIDEFAME], [ZEBRA],  REMAINING SET], [SUB-T DATE], [FLASH MODE]*, [FLASH LEVEL], [REDEYE REDUC], [FACE DETECTION], [ INDEX SET]*	
PHOTO [ IMAGE SIZE]*, [FILE SETTINGS NO.], [GUIDEFAME], [ZEBRA], [FLASH MODE]*, [FLASH LEVEL], [REDEYE DETECTION], [FACE DETECTION]	
VIEW [DATA CODE], IMAGES  DISPLAY]	
SET	
SOUND/ [VOLUME]*, [BEEP]*, [LCD DISP SET** BRIGHT], [LCD BL LEVEL], [LCD COLOR]	
OUTPUT [TV TYPE], [DISP OUTPUT], SETTINGS [COMPONENT]	
CLOCK/  [CLOCK SET]*, [AREA LANG SET], [SUMMERTIME], [ LANGUAGE SET]*	
GENERAL [DEMO MODE], SET [CALIBRATION], [A.SHUT OFF], [QUICK ON STBY], [CTRL FOR HDMI]	

* You can set these items also during Easy Handycam operation.

** The menu name is changed to [SOUND SETTINGS] during Easy Handycam operation.

Saving images

Items of the OPTION MENU

Items you can set only on the OPTION MENU will be described below.

 tab

[FOCUS], [SPOT FOCUS], [TELE MACRO],
[EXPOSURE], [SPOT METER], [SCENE
SELECTION], [WHITE BAL.], [COLOR
SLOW SHTR]

 tab

[FADER], [D.EFFECT], [PICT.EFFECT]

 tab

[BLT-IN ZOOM MIC], [MICREF LEVEL],
[SELF-TIMER], [TIMING], [RECORD
SOUND]

– (The tab depends on the situation/No tab)

[SLIDE SHOW], [SLIDE SHOW SET],
[COPIES], [DATE/TIME], [SIZE]

Due to the limited capacity of the “Memory Stick PRO Duo,” make sure that you save the image data to some type of external media such as a DVD-R or the hard disk of a computer.

You can save the images recorded on the camcorder as described below.

Using a computer

By using “Picture Motion Browser” on the supplied CD-ROM, you can save the images recorded on your camcorder with HD (high definition) image quality or SD (standard definition) image quality. For details, see “PMB Guide” (p. 28).

Creating a disc with One Touch (One Touch Disc Burn)

You can save images recorded on the camcorder directly to a disc with ease by pressing the  (DISC BURN) button.

Saving images on a computer

You can save images recorded on the camcorder on the hard disk of a computer.

Creating a disc with selected images

You can save images copied to your computer on a disc. You can also edit those images.

Connecting your camcorder to other devices

For details, see “Handycam Handbook” (PDF).

Connecting with the A/V connecting cable



You can dub to VCRs, DVD/HDD recorders with SD (standard definition) image quality.

Deleting images

Connecting with the USB cable

You can dub to movie dubbing compatible DVD writers, etc., with HD (high definition) image quality.

Select the image quality of the movie you want to delete before the operation.

1 Touch  (HOME) → 
(OTHERS) → [DELETE].



2 Touch [ DELETE].

3 Touch [ DELETE] or [ DELETE], then touch the movie to be deleted.

The selected movie is marked with ✓.

4 Touch [OK] → [YES] → [OK].

To delete all movies at one time

In step **3**, touch [ DELETE ALL]/[ DELETE ALL] → [YES] → [YES] → [OK].

To delete still images

① In step **2**, touch [ DELETE].

② Touch [ DELETE], then touch the still image to be deleted.



The selected still image is marked with ✓.

③ Touch [OK] → [YES] → [OK].

Tips

- To delete all still images at one time, in step ②, touch [ DELETE ALL] → [YES] → [YES] → [OK].

To delete all images (Format)

Touch  (HOME) →  (MANAGE MEDIA) → [MEDIA FORMAT] → [YES] → [YES] → [OK].

Notes

- Formatting will delete all data recorded on the “Memory Stick PRO Duo.”

Performing with a computer

Handbook/software to be installed

■ “Handycam Handbook” (PDF)

“Handycam Handbook” (PDF) explains in detail about your camcorder and its practical use.

■ “Picture Motion Browser” (only for Windows users)

“Picture Motion Browser” is the supplied software. You can enjoy the following operations.

- Creating a disc with one touch operation
- Importing images to a computer
- Editing imported images
- Creating a disc

⚡ Notes

- The supplied software “Picture Motion Browser” is not supported by Macintosh computers. To use a Macintosh computer connected to your camcorder, see the following website for details.
<http://guide.d-imaging.sony.co.jp/mac/ms/us/>

Installing and viewing “Handycam Handbook” (PDF)

To view “Handycam Handbook” (PDF), you need to install Adobe Reader on your computer.

- ① Turn on the computer.
- ② Place the CD-ROM (supplied) in the disc drive of your computer.
The select screen for installation appears.



- ③ Click [Handycam Handbook].
The installation screen for “Handycam Handbook” (PDF) appears.

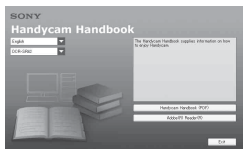

- ④ Select the desired language and the model name of your Handycam, then click [Handycam Handbook (PDF)].
Installation starts. When the installation is completed, the short-cut icon of “Handycam Handbook” (PDF) appears on the desktop of your computer.
 - The model name of your Handycam is printed on the lower side of its side surface.
- ⑤ Click [Exit] → [Exit], then remove the CD-ROM from the disc drive of your computer.
To view “Handycam Handbook,” double-click the short-cut icon of “Handycam Handbook.”

💡 Tips

- For Macintosh users, follow the steps below.
 - ① Turn on the computer.
 - ② Place the CD-ROM (supplied) in the disc drive of your computer.
 - ③ Open the [Handbook] folder in the CD-ROM, double-click the [GB] folder and then drag-and-drop the “Handbook.pdf” on the computer.
To view “Handycam Handbook,” double-click “Handbook.pdf.”

Installing “Picture Motion Browser”

■ System requirements

OS: Microsoft Windows 2000 Professional SP4/Windows XP SP2*/Windows Vista*

* 64-bit editions and Starter (Edition) are not supported.

Standard installation is required.

Operation is not assured if the above OS has been upgraded or in a multi-boot environment.

CPU: Intel Pentium 4 2.8 GHz or faster (Intel Pentium 4 3.6 GHz or faster, Intel Pentium D 2.8 GHz or faster, Intel Core Duo 1.66 GHz or faster, Intel Core 2 Duo 1.66 GHz or faster is recommended.)

- Intel Pentium III 1 GHz or faster enables the following operations:
 - Importing the contents to the computer
 - One Touch Disc Burn
 - Creating an AVCHD format disc/DVD-video
 - Copying a disc
 - Processing only the contents in SD (standard definition) image quality

Memory: For Windows 2000, Windows XP: 512 MB or more (1 GB or more is recommended.)

For processing SD (standard definition) image quality content only, 256 MB of memory or more is necessary.

For Windows Vista: 1 GB or more

Hard disk: Disk volume required for installation: Approximately 500 MB (10 GB or more may be necessary when creating AVCHD format discs.)

Display: Minimum 1,024 × 768 dots

Others: Ψ USB port (this must be provided as standard, Hi-Speed USB (USB 2.0 compatible) is recommended), DVD burner (CD-ROM drive is necessary for installation)

Attention

This camcorder captures high definition footage in the AVCHD format. Using the enclosed PC software, high definition footage can be copied onto DVD media. However, DVD media containing AVCHD footage should not be used with DVD based players or recorders, as the DVD player/recorder may fail to eject the media and may erase its contents without warning. DVD media containing AVCHD footage may be played on a compatible Blu-ray Disc™ player/recorder or other compatible device.

Notes

- You can read images recorded on a “Memory Stick PRO Duo” in a Memory Stick slot of a computer. However, in the following cases, do not use the Memory Stick slot of the computer, but connect your camcorder to the computer with the USB cable:
 - The computer is not compatible with a “Memory Stick PRO Duo.”
 - A Memory Stick Duo adaptor is required.
 - A “Memory Stick PRO Duo” cannot be read in the Memory Stick slot.
 - Reading data from the Memory Stick slot is slow.

Installation procedure

You need to install the software to your Windows computer **before connecting your camcorder to the computer**. The installation is required only for the first time.

Contents to be installed and procedures may differ depending on your OS.

- ① Confirm that your camcorder is not connected to the computer.
- ② Turn on the computer.

Notes

- Log on as an Administrator for installation.
 - Close all applications running on the computer before installing the software.
- ③ Place the supplied CD-ROM in the disc drive of your computer.
- The installation screen appears.



If the screen does not appear

- ① Click [Start], then click [My Computer]. (For Windows 2000, double-click [My Computer].)
- ② Double-click [SONYPICUTIL (E:)] (CD-ROM) (disc drive).*
 - * Drive names (such as (E:)) may vary depending on the computer.
- ④ Click [Install].

- ⑤ Select the language for the application to be installed, then click [Next].
- ⑥ As the screen to confirm the connection appears, connect your camcorder to the computer following the steps below.

When using the Handycam Station

- ① Connect the AC Adaptor to the Handycam Station and a wall outlet (wall socket).
- ② Set your camcorder onto the Handycam Station, then turn on your camcorder.
- ③ Connect the ψ (USB) jack of the Handycam Station (p. 18) to the computer using the supplied USB cable.
The [USB SELECT] screen appears on your camcorder automatically.
- ④ Touch [\square] USB CONNECT] on the [USB SELECT] screen of your camcorder.

When using the Dedicated USB Terminal Adaptor

- ① Attach the Dedicated USB Terminal Adaptor to your camcorder.

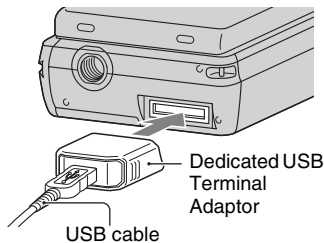

- ② Connect the AC Adaptor to your camcorder and a wall outlet (wall socket), then turn on your camcorder.
- ③ Connect the USB cable connected to the Dedicated USB Terminal Adaptor to the computer.
The [USB SELECT] screen appears on your camcorder automatically.
- ④ Touch [\square] USB CONNECT] on the [USB SELECT] screen of your camcorder.

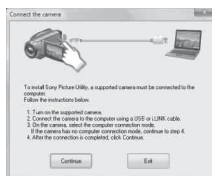

- ⑦ Click [Continue].
- ⑧ Read [License Agreement], select [I accept the terms of the license agreement] if you agree, then click [Next].
- ⑨ Confirm the installation settings, then click [Install].
- ⑩ Follow the on-screen instructions to install the software.
Depending on the computer, you may need to install third party software. If the installation screen appears, follow the instructions to install the required software.
- ⑪ Restart the computer if required to complete the installation.
- ⑫ Remove the CD-ROM from the disc drive of your computer.

To disconnect the USB cable

- ① Click the icon \rightarrow [Safely remove USB Mass Storage Device] \rightarrow [OK] (Windows 2000 only) on the task tray on the bottom right of the desktop of the computer.
- ② Touch [END] \rightarrow [YES] on the screen of your camcorder.
- ③ Disconnect the USB cable.

To operate the "Picture Motion Browser"



To start "Picture Motion Browser," click [Start] \rightarrow [All Programs] \rightarrow [Sony Picture Utility] \rightarrow [PMB - Picture Motion Browser].

For the basic operation of "Picture Motion Browser," see "PMB Guide." To display "PMB Guide," click [Start] \rightarrow [All Programs] \rightarrow [Sony Picture Utility] \rightarrow [Help] \rightarrow [PMB Guide].

Notes

- If you close the LCD panel when your camcorder is connected to other devices with the USB cable, the recorded images may be lost.

Tips

- If the [USB SELECT] screen does not appear, touch  (HOME) →  (OTHERS) → [USB CONNECT].

Troubleshooting

If you run into any problems using your camcorder, use the following table to troubleshoot the problem. If the problem persists, disconnect the power source and contact your Sony dealer.

- For the symptoms of your camcorder, see “Handycam Handbook” (PDF) and for connecting to the computer, see “PMB Guide.”

The power does not turn on.

- Insert a charged battery pack into the camcorder (p. 7).
- Connect the plug of the AC Adaptor to the wall outlet (wall socket) (p. 7).

The camcorder does not operate even when the power is set to on.

- It takes a few seconds for your camcorder to be ready to shoot after the power is turned on. This is not a malfunction.
- Disconnect the AC Adaptor from the wall outlet (wall socket) or remove the battery pack, then reconnect it after about 1 minute. If the functions still do not work, press the RESET button (p. 17) using a pointed object. (If you press the RESET button, all settings, including the clock setting, are reset.)





Your camcorder gets warm.

- This is because the power has been turned on for a long time. This is not a malfunction.

The power abruptly turns off.

- Turn on the power again.
- Use the AC Adaptor.
- Charge the battery pack (p. 7).

Pressing START/STOP or PHOTO does not record images.

- Slide the  (Movie)/ (Still) select switch to turn on the  (Movie) lamp or  (Still) lamp (p. 13).
- You cannot record images in sleep mode. Open the LCD panel.
- Your camcorder is recording the image you have just shot on the “Memory Stick PRO Duo.” You cannot make new recording during this period.
- The “Memory Stick PRO Duo” is full. Use a new “Memory Stick PRO Duo” or format the “Memory Stick PRO Duo.” Or delete the unnecessary images (p. 24).
- Total number of movie scenes or still images exceeds the recordable capacity of your camcorder. Delete the unnecessary images (p. 24).

You cannot install “Picture Motion Browser.”

- Check the computer environment required to install “Picture Motion Browser.”
- Install “Picture Motion Browser” in an orderly manner (p. 26).

“Picture Motion Browser” does not work correctly.

- Finish “Picture Motion Browser” and restart your computer.

Your camcorder is not recognized by the computer.

- Disconnect devices from the USB jack of the computer other than the keyboard, mouse, and your camcorder.
- Disconnect the USB cable from the computer and the Handycam Station or the Dedicated USB Terminal Adaptor, and restart the computer, then connect the computer and your camcorder again in an orderly manner.

Self-diagnosis display/Warning indicators

If indicators appear on the LCD screen, check the following.

If the problem persists even after you have tried a couple of times, contact your Sony dealer or local authorized Sony service facility.

Indicators	Causes/Solutions
C:04:□□	<ul style="list-style-type: none"> The battery pack is not an "InfoLITHIUM" battery pack NP-FH50. Use an "InfoLITHIUM" battery pack NP-FH50 (p. 7). Connect the DC plug of the AC Adaptor to the DC IN jack of the Handycam Station or your camcorder securely (p. 7).
C:13:□□/ C:32:□□	<ul style="list-style-type: none"> Remove the power source. Reconnect it and operate your camcorder again.
E:20:□□/ E:31:□□/ E:61:□□/ E:62:□□/ E:91:□□/ E:94:□□	<ul style="list-style-type: none"> A malfunction that you cannot service has occurred. Contact your Sony dealer or local authorized Sony service facility. Inform them of the 5-digit code, which starts from "E."
101-0001	<ul style="list-style-type: none"> When the indicator flashes slowly, the file is damaged or unreadable.
	<ul style="list-style-type: none"> Battery power is low.
	<ul style="list-style-type: none"> The temperature of your camcorder is getting high. Turn off your camcorder and leave it in a cool place.

Indicators	Causes/Solutions
	<ul style="list-style-type: none"> When the indicator flashes slowly, free space for recording images are running out. For the type of "Memory Stick" you can use with your camcorder, see page 5. No "Memory Stick PRO Duo" is inserted (p. 12). When the indicator flashes quickly, there are not enough free space for recording images. Delete unnecessary images, or format the "Memory Stick PRO Duo" after storing the images on other media (p. 24). The Image Database File is damaged.
	<ul style="list-style-type: none"> The "Memory Stick PRO Duo" is damaged. Format the "Memory Stick PRO Duo" with your camcorder.
	<ul style="list-style-type: none"> An incompatible "Memory Stick PRO Duo" is inserted.
	<ul style="list-style-type: none"> Access to the "Memory Stick PRO Duo" was restricted on another device.
	<ul style="list-style-type: none"> There is something wrong with the flash.
	<ul style="list-style-type: none"> The amount of light is not sufficient. Use the flash. The camcorder is unsteady. Hold the camcorder steady with both hands. However, note that the camera-shake warning indicator does not disappear.
	<ul style="list-style-type: none"> The media is full. Still images cannot be recorded during processing. Wait for a while, then record.

Precautions

On use and care

- Do not use or store the camcorder and accessories in the following locations:
 - Anywhere extremely hot, cold or humid. Never leave them exposed to temperatures above 60°C (140°F), such as under direct sunlight, near heaters or in a car parked in the sun. They may malfunction or become deformed.
 - Near strong magnetic fields or mechanical vibration. The camcorder may malfunction.
 - Near strong radio waves or radiation. The camcorder may not be able to record properly.
 - Near AM receivers and video equipment. Noise may occur.
 - On a sandy beach or anywhere dusty. If sand or dust gets in your camcorder, it may malfunction. Sometimes this malfunction cannot be repaired.
 - Near windows or outdoors, where the LCD screen, or the lens may be exposed to direct sunlight. This damages the LCD screen.
- Operate your camcorder on DC 6.8 V/7.2 V (battery pack) or DC 8.4 V (AC Adaptor).
- For DC or AC operation, use the accessories recommended in these operating instructions.
- Do not let your camcorder get wet, for example, from rain or sea water. If your camcorder gets wet, it may malfunction. Sometimes this malfunction cannot be repaired.
- If any solid object or liquid gets inside the casing, unplug your camcorder and have it checked by a Sony dealer before operating it any further.
- Avoid rough handling, disassembling, modifying, physical shock, or impact such as hammering, dropping or stepping on the product. Be particularly careful of the lens.
- Keep your camcorder turned off when you are not using your camcorder.
- Do not wrap your camcorder with a towel, for example, and operate it. Doing so might cause heat to build up inside.
- When disconnecting the power cord (mains lead), pull it by the plug and not the cord (lead).
- Do not damage the power cord (mains lead) such as by placing anything heavy on it.
- Keep metal contacts clean.

- If the battery electrolytic liquid has leaked:
 - consult your local authorized Sony service facility.
 - wash off any liquid that may have contacted your skin.
 - if any liquid gets in your eyes, wash with plenty of water and consult a doctor.

■ When not using your camcorder for a long time

- Periodically turn on your camcorder and let it run such as by playing back or recording images for about 3 minutes.
- Use up the battery pack completely before storing it.

LCD screen

- Do not exert excessive pressure on the LCD screen, as it may cause damage.
- If your camcorder is used in a cold place, a residual image may appear on the LCD screen. This is not a malfunction.
- While using your camcorder, the back of the LCD screen may heat up. This is not a malfunction.

■ To clean the LCD screen

If fingerprints or dust make the LCD screen dirty, it is recommended you use a soft cloth to clean it. When you use the LCD Cleaning Kit (optional), do not apply the cleaning liquid directly to the LCD screen. Use cleaning paper moistened with the liquid.

On handling the casing

- If the casing is soiled, clean the camcorder body with a soft cloth lightly moistened with water, and then wipe the casing with a dry soft cloth.
- Avoid the following to avoid damage to the finish:
 - Using chemicals such as thinner, benzine, alcohol, chemical cloths, repellent, insecticide and sunscreen.
 - Handling the camcorder with above substances on your hands.
 - Leaving the casing in contact with rubber or vinyl objects for a long period of time.

Specifications

About care and storage of the lens

- Wipe the surface of the lens clean with a soft cloth in the following instances:
 - When there are fingerprints on the lens surface.
 - In hot or humid locations
 - When the lens is exposed to salty air such as at the seaside.
- Store in a well-ventilated location subject to little dirt or dust.
- To prevent mold, periodically clean the lens as described above. It is recommended that you operate your camcorder about once a month to keep it in optimum state for a long time.

On charging the pre-installed rechargeable battery

Your camcorder has a pre-installed rechargeable battery to retain the date, time, and other settings even when your camcorder turned off. The pre-installed rechargeable battery is always charged while your camcorder is connected to the wall outlet (wall socket) via the AC Adaptor or while the battery pack is attached. The rechargeable battery will be fully discharged in **about 3 months** if you do not use your camcorder at all. Use your camcorder after charging the pre-installed rechargeable battery.

However, even if the pre-installed rechargeable battery is not charged, the camcorder operation will not be affected as long as you are not recording the date.

■ Procedures

Connect your camcorder to a wall outlet (wall socket) using the supplied AC Adaptor, and leave it with the power turned off for more than 24 hours.

System

Video compression format: AVCHD (HD)/MPEG2 (SD)/JPEG (Still images)
Audio compression format: Dolby Digital 2/5.1ch
Dolby Digital 5.1 Creator
Video signal: PAL color, CCIR standards
1080/50i specification
Recording format: Movie (HD): AVCHD 1080/50i
Movie (SD): MPEG2-PS
Still image: Exif Ver.2.2*1
Image device: 3.6 mm (1/5 type) CMOS sensor
Recording pixels (still image, 4:3):
Max. 4.0 mega (2 304 × 1 728) pixels*2
Gross: Approx. 2 360 000 pixels
Effective (movie, 16:9): Approx. 1 430 000 pixels
Effective (still image, 16:9): Approx. 1 490 000 pixels
Effective (still image, 4:3): Approx. 1 990 000 pixels
Lens: Carl Zeiss Vario-Tessar
10 × (Optical), 20 ×, 120 × (Digital)
Focal length: F1.8 ~ 2.3
f=3.2 ~ 32.0 mm (5/32 ~ 1 5/16 in.)
When converted to a 35 mm still camera
For movies*3: 43 ~ 507 mm (1 3/4 ~ 20 in.) (16:9)
For still images: 38 ~ 380 mm (1 1/2 ~ 15 in.) (4:3)
Color temperature: [AUTO], [ONE PUSH], [INDOOR] (3 200 K), [OUTDOOR] (5 800 K)
Minimum illumination: 5 lx (lux) ([AUTO SLW SHUTTR] [ON], Shutter speed 1/25 sec)

*1 "Exif" is a file format for still images, established by the JEITA (Japan Electronics and Information Technology Industries Association). Files in this format can have additional information such as your camcorder's setting information at the time of recording.

*2 The unique pixel array of Sony's ClearVid CMOS sensor and image processing system (BIONZ) allows still image resolution equivalent to the sizes described.

*3 The focal length figures are actual figures resulting from wide angle pixel readout.

Input/Output connectors

A/V Remote Connector: Component/video and audio output jack

HDMI OUT jack: HDMI mini Connector

LCD screen

Image: 6.7 cm (2.7 type, aspect ratio 16:9)

Total dot number: 211 200 (960 × 220)

General

Power requirements: DC 6.8 V/7.2 V (battery pack)

DC 8.4 V (AC Adaptor)

Average power consumption: During camera recording using the LCD with normal brightness:

HD: 3.3 W

SD: 2.7 W

Operating temperature: 0 °C to + 40 °C (32 °F to 104 °F)

Storage temperature: -20 °C to + 60 °C (-4 °F to + 140 °F)

Dimensions (approx.): 32 × 119 × 63 mm

(1 5/16 × 4 3/4 × 2 1/2 in.) (w/h/d)

including the projecting parts

32 × 119 × 63 mm

(1 5/16 × 4 3/4 × 2 1/2 in.) (w/h/d)

including the projecting parts, and the supplied rechargeable battery pack attached

Mass (approx.): 240 g (8 oz) main unit only

300 g (10 oz) including the supplied

rechargeable battery pack, and a "Memory Stick PRO Duo"

Handycam Station DCRA-C230

Input/Output connectors

A/V OUT jack: Component/video and audio output jack

USB jack: mini-B

(HDR-TG3E: output only)

Dedicated USB Terminal Adaptor

Input/Output connectors

USB jack: mini-B

(HDR-TG3E: output only)

AC Adaptor AC-L200/L200B

Power requirements: AC 100 V - 240 V, 50/60 Hz

Current consumption: 0.35 - 0.18 A

Power consumption: 18 W

Output voltage: DC 8.4 V*

Operating temperature: 0 °C to + 40 °C (32 °F to 104 °F)

Storage temperature: -20 °C to + 60 °C (-4 °F to + 140 °F)

Dimensions (approx.): 48 × 29 × 81 mm

(1 15/16 × 1 3/16 × 3 1/4 in.) (w/h/d)

excluding the projecting parts

Mass (approx.): 170 g (6.0 oz) excluding the power cord (mains lead)

* See the label on the AC Adaptor for other specifications.

Rechargeable battery pack NP-FH50

Maximum output voltage: DC 8.4 V

Output voltage: DC 6.8 V

Capacity: 6.1 Wh (900 mAh)

Type: Li-ion

Design and specifications are subject to change without notice.

- Manufactured under license from Dolby Laboratories.

On trademarks

- “Handycam” and **HANDYCAM** are registered trademarks of Sony Corporation.
- “AVCHD” and “AVCHD” logotype are trademarks of Matsushita Electric Industrial Co., Ltd. and Sony Corporation.
- “Memory Stick,” “,” “Memory Stick Duo,” “**MEMORY STICK DUO**,” “Memory Stick PRO Duo,” “**MEMORY STICK PRO DUO**,” “Memory Stick PRO-HG Duo,” “**MEMORY STICK PRO-HG DUO**,” “MagicGate,” “**MAGICGATE**,” “MagicGate Memory Stick” and “MagicGate Memory Stick Duo” are trademarks or registered trademarks of Sony Corporation.
- “x.v.Colour” is a trademark of Sony Corporation.
- “BIONZ” is a trademark of Sony Corporation.
- “BRAVIA” is a trademark of Sony Corporation.
- “InfoLITHIUM” is a trademark of Sony Corporation.
- Dolby and the double-D symbol are trademarks of Dolby Laboratories.
- HDMI, the HDMI logo and High-Definition Multimedia Interface are trademarks or registered trademarks of HDMI Licensing LLC.
- Microsoft, Windows, Windows Media, Windows Vista, and DirectX are either registered trademarks or trademarks of Microsoft Corporation in the United States and/or other countries.
- Macintosh and Mac OS are registered trademarks of Apple Inc. in the U.S. and other countries.
- Intel, Intel Core, and Pentium are trademarks or registered trademarks of Intel Corporation or its subsidiaries in the United States and other countries.
- Adobe, the Adobe logo, and Adobe Acrobat are either registered trademarks or trademarks of Adobe Systems Incorporated in the United States and/or other countries.

All other product names mentioned herein may be the trademarks or registered trademarks of their respective companies. Furthermore, ™ and ® are not mentioned in each case in this manual.

Additional information on this product and answers to frequently asked questions can be found at our Customer Support Website.

<http://www.sony.net/>



Printed on 70% or more recycled paper
using VOC (Volatile Organic Compound)-
free vegetable oil based ink.

Printed in Japan



3 2 8 8 5 2 3 1 3 0

Download from [Www.Somanuals.com](http://www.Somanuals.com). All Manuals Search And Download.

Free Manuals Download Website

<http://myh66.com>

<http://usermanuals.us>

<http://www.somanuals.com>

<http://www.4manuals.cc>

<http://www.manual-lib.com>

<http://www.404manual.com>

<http://www.luxmanual.com>

<http://aubethermostatmanual.com>

Golf course search by state

<http://golfingnear.com>

Email search by domain

<http://emailbydomain.com>

Auto manuals search

<http://auto.somanuals.com>

TV manuals search

<http://tv.somanuals.com>