

Video Camera Recorder **8**

Operating Instructions

Before operating the unit, please read this manual thoroughly,
and retain it for future reference.

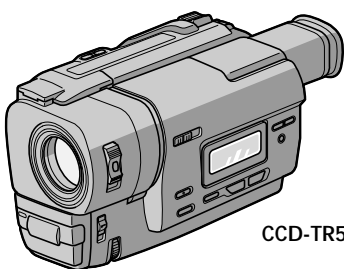

CCD-TR517

Handycam



Video 8 XR
CCD-TR317/TR517

Welcome !

Congratulations on your purchase of this Sony Handycam® camcorder. With your Handycam, you can capture life's precious moments with superior picture and sound quality.

Your Handycam is loaded with advanced features, but at the same time it is very easy to use. You will soon be producing home video that you can enjoy for years to come.

WARNING

To prevent fire or shock hazard, do not expose the unit to rain or moisture.

To avoid electrical shock, do not open the cabinet. Refer servicing to qualified personnel only.

Table of contents

Quick Start Guide	4
--------------------------------	---

Getting started

Using this manual	6
Checking supplied accessories	8
Step 1 Preparing the power supply	9
Installing the battery pack	9
Charging the battery pack	10
Connecting to a wall outlet	14
Step 2 Inserting a cassette	15

Recording – Basics

Recording a picture	16
Shooting backlit subjects (BACK LIGHT)	19
Shooting in the dark (NightShot)	20
Superimposing the date and time on pictures	21
Checking the recording – EDITSEARCH / Rec Review	22

Playback – Basics

Connections for playback	23
Playing back a tape	24

Advanced Recording Operations

Using the wide mode	26
Using the fader function	28
Using special effects – Picture effect	30
Using the PROGRAM AE function	31
Adjusting the exposure manually	33
Focusing manually	34
Superimposing a title	35
Making your own titles	37

Editing

Dubbing a tape	39
----------------------	----

Customizing Your Camcorder

Changing the menu settings	40
Resetting the date and time	44

Additional Information

Playback modes	46
Changing the lithium battery in your camcorder	47
Troubleshooting	49
Self-diagnosis display	52
Warning indicators and messages	53
Using your camcorder abroad	54
Maintenance information and precautions	55
Specifications	59

Quick Reference

Identifying the parts and controls	60
Quick Function Guide	66

Quick Start Guide



This chapter introduces you to the basic features of your camcorder. See the page in parentheses “()” for more information.

1

Connecting the power cord (p. 14)

Use the battery pack when using your camcorder outdoors (p. 9).

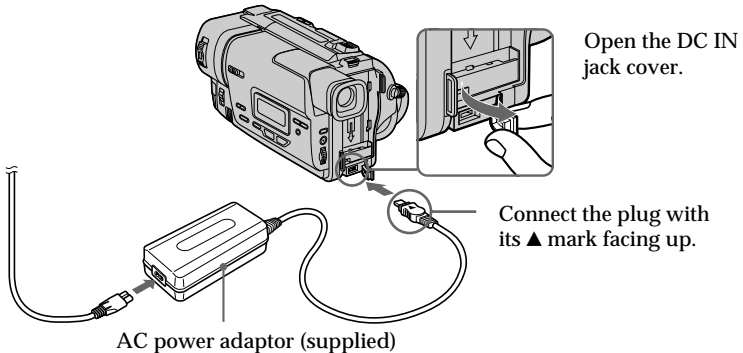

2

Inserting a cassette (p. 15)

- 1 Slide EJECT in the direction of the arrow while pressing the small blue button.

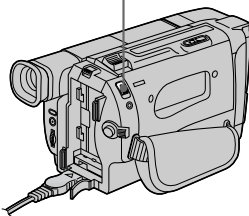

- 2 Insert a cassette into the cassette compartment with its window facing out.

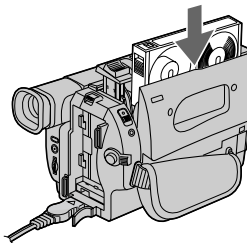

- 3 Close the cassette compartment by pressing the PUSH mark on the cassette compartment. The cassette compartment automatically goes down.

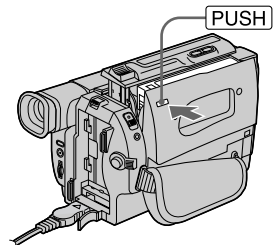

3

Recording a picture (p. 16)

- 1** Set the POWER switch to CAMERA while pressing the small green button.

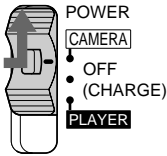

while pressing the small green button.

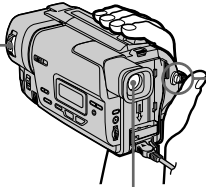

Viewfinder

Use the viewfinder placing your eye against its eyecup.
The picture in the viewfinder is black and white. (CCD-TR317 only)

- 2** Turn STANDBY to STANDBY. The picture appears in the viewfinder.



- 3** Press the red button. Your camcorder starts recording. To stop recording, press the red button again.



4

Monitoring the playback picture in the viewfinder (p. 24)

- 1** Set the POWER switch to PLAYER while pressing the small green button.

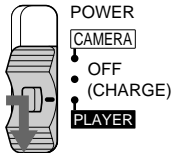

while pressing the small green button.

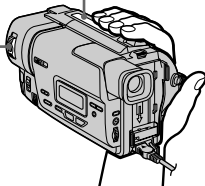

- 2** Press ◀◀ to rewind the tape.



- 3** Press ▶ to start playback.



NOTE

Do not pick up your camcorder by holding the viewfinder or the battery pack.

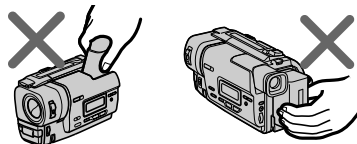

Using this manual

The instructions in this manual are for the two models listed in the table below. Before you start reading this manual and operating your camcorder, check the model number by looking at the bottom of your camcorder. The CCD-TR517 is the model used for illustration purposes. Otherwise, the model name is indicated in the illustrations. Any differences in operation are clearly indicated in the text, for example, “CCD-TR517 only.”

As you read through this manual, buttons and settings on your camcorder are shown in capital letters.

e.g. Set the POWER switch to CAMERA.

When you carry out an operation, you can hear a beep sound to indicate that the operation is being carried out.

Types of differences

CCD-	TR317	TR517
Viewfinder	B/W	color

Note on TV color systems

TV color systems differ from country to country. To view your recordings on a TV, you need an NTSC system-based TV.

Copyright precautions

Television programs, films, video tapes, and other materials may be copyrighted. Unauthorized recording of such materials may be contrary to the provision of the copyright laws.

Precautions on camcorder care

- The viewfinder is manufactured using high-precision technology. However, there may be some tiny black points and/or bright points (red, blue, green or white) that constantly appear in the viewfinder. These points occur normally in the manufacturing process and do not affect the recorded picture in any way.
Effective ratio of pixels and/or screen are 99.99% or more.
- Do not let your camcorder get wet. Keep your camcorder away from rain and sea water. Letting your camcorder get wet may cause your camcorder to malfunction. Sometimes this malfunction cannot be repaired [a].
- Never leave your camcorder exposed to temperatures above 60°C (140°F), such as in a car parked in the sun or under direct sunlight [b].
- Do not place your camcorder so as to point the viewfinder toward the sun. The inside of the viewfinder may be damaged [c].

[a]

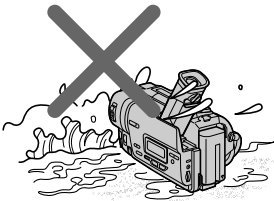

[b]

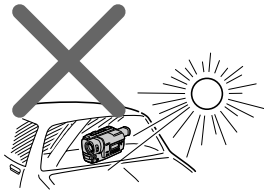

[c]

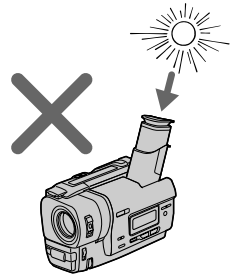

Checking supplied accessories

Make sure that the following accessories are supplied with your camcorder.

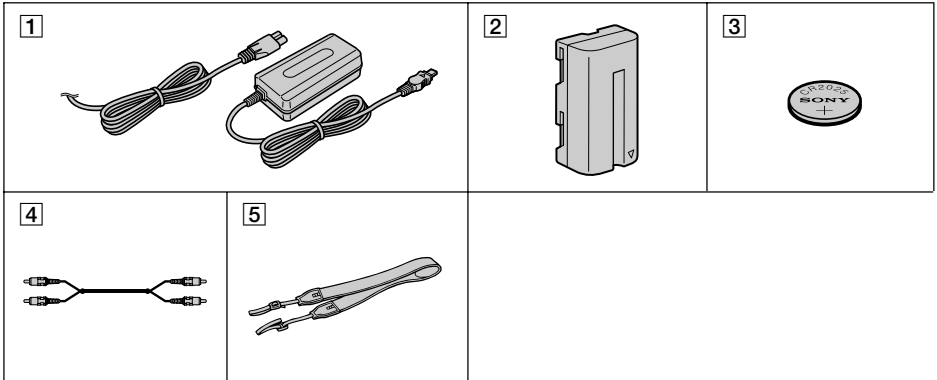

1 AC-L10A/L10B/L10C AC power adaptor (1), Power cord (1) (p. 10)

4 A/V connecting cable (1) (p. 23)

2 NP-F330 battery pack (1) (p. 9, 10)

5 Shoulder strap (1) (p. 62)

3 CR2025 lithium battery (1) (p. 47)
The lithium battery is already installed in your camcorder.

Contents of the recording cannot be compensated if recording or playback is not made due to a malfunction of the camcorder, video tape, etc.

Step 1 Preparing the power supply

Installing the battery pack

Install the battery pack to use your camcorder outdoors.

Slide the battery pack down until it clicks.

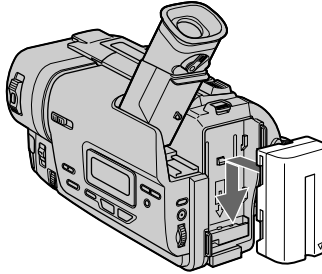

To remove the battery pack

Slide the battery pack out in the direction of the arrow while pressing **BATT RELEASE** down.

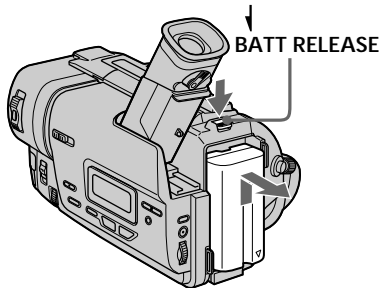

After installing the battery pack

Do not carry your camcorder by holding the battery pack. If you do so, the battery pack may slide off your camcorder unintentionally, damaging your camcorder.

Step 1 Preparing the power supply

Charging the battery pack

Use the battery pack after charging it for your camcorder.

Your camcorder operates only with the "InfoLITHIUM" battery pack (L series).

- (1) Open the DC IN jack cover and connect the AC power adaptor supplied with your camcorder to the DC IN jack with the plug's ▲ mark facing up.
- (2) Connect the power cord to the AC power adaptor.
- (3) Connect the power cord to a wall outlet.
- (4) Set the POWER switch to OFF (CHARGE). Charging begins. The remaining battery time is indicated in minutes on the display window.

When the remaining battery indicator changes to , normal charge is completed. To fully charge the battery (full charge) leave the battery pack attached for about 1 hour after normal charge is completed until FULL appears in the display window. Fully charging the battery allows you to use the battery longer than usual.

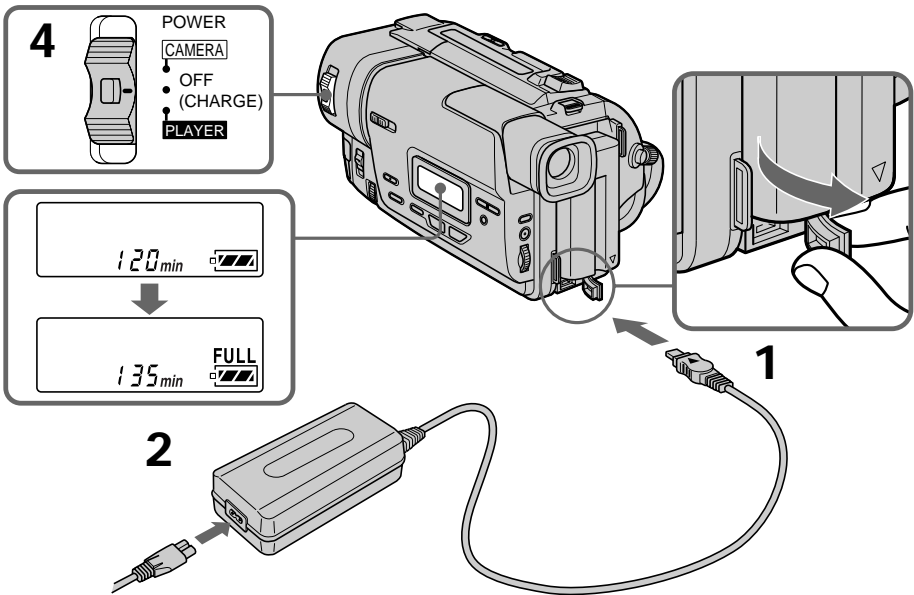

Step 1 Preparing the power supply

Notes

- Prevent metallic objects from coming into contact with the metal parts of the DC plug of the AC power adaptor. This may cause a short-circuit, damaging the AC power adaptor.
- Keep the battery pack dry.
- When the battery pack is not to be used for a long time, charge the battery pack once fully and then use it until it fully discharges again. Keep the battery pack in a cool place.

Remaining battery time indicator

The remaining battery time indicator in the display window roughly indicates the recording time.

Battery pack

The battery pack is charged a little before it leaves the factory.

Until your camcorder calculates the actual remaining battery time

“---- min” appears in the display window.

While charging the battery pack, no indicator appears or the indicator flashes in the display window in the following cases

- The battery pack is not installed correctly.
- The AC power adaptor is disconnected.
- Something is wrong with the battery pack.

Step 1 Preparing the power supply

Charging time

Battery pack	Full charge (Normal charge)
NP-F330 (supplied)	150 (90)
NP-F530/F550	210 (150)
NP-F730/F750	300 (240)
NP-F930/F950	390 (330)
NP-F960	420 (360)

Approximate number of minutes to charge an empty battery pack

Recording time

CCD-TR317

Battery pack	Continuous*	Typical**
NP-F330 (supplied)	140 (125)	75 (70)
NP-F530	245 (220)	135 (120)
NP-F550	280 (250)	155 (135)
NP-F730	500 (450)	275 (245)
NP-F750	580 (525)	320 (290)
NP-F930	780 (705)	430 (385)
NP-F950	900 (790)	495 (435)
NP-F960	1035 (930)	570 (510)

CCD-TR517

Battery pack	Continuous*	Typical**
NP-F330 (supplied)	170 (160)	95 (90)
NP-F530	305 (275)	165 (150)
NP-F550	340 (305)	185 (165)
NP-F730	625 (560)	345 (310)
NP-F750	710 (640)	390 (350)
NP-F930	975 (875)	535 (480)
NP-F950	1080 (970)	595 (535)
NP-F960	1260 (1135)	695 (625)

Approximate number of minutes when you use a fully charged battery

Numbers in parentheses “ () ” indicate the time using a normally charged battery.

* Approximate continuous recording time at 25°C (77°F). The battery life will be shorter if you use your camcorder in a cold environment.

** Approximate number of minutes when recording while you repeat recording start/stop, zooming and turning the power on/off. The actual battery life may be shorter.

Step 1 Preparing the power supply

Playing time

CCD-TR317

Battery pack

NP-F330 (supplied)	145 (130)
NP-F530	260 (230)
NP-F550	295 (260)
NP-F730	525 (475)
NP-F750	610 (550)
NP-F930	825 (740)
NP-F950	930 (830)
NP-F960	1090 (980)

CCD-TR517

Battery pack

NP-F330 (supplied)	180 (160)
NP-F530	325 (295)
NP-F550	360 (325)
NP-F730	665 (600)
NP-F750	750 (680)
NP-F930	1035 (930)
NP-F950	1140 (1030)
NP-F960	1330 (1195)

Approximate number of minutes when you use a fully charged battery

Numbers in parentheses “()” indicate the time using a normally charged battery. The battery life will be shorter if you use your camcorder in a cold environment.

After charging the battery pack

Disconnect the AC power adaptor from the DC IN jack on your camcorder.

Note on the remaining battery time indicator during recording

The indicator may not be correct, depending on the conditions in which you are recording.

What is “InfoLITHIUM”?

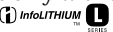
The “InfoLITHIUM” is a lithium ion battery pack which can exchange data such as battery consumption with compatible electronic equipment. This unit is compatible with the “InfoLITHIUM” battery pack (L series). Your camcorder operates only with the “InfoLITHIUM” battery. “InfoLITHIUM” L series battery packs have the  mark.

“InfoLITHIUM” is a trademark of Sony Corporation.

Step 1 Preparing the power supply

Connecting to a wall outlet

When you use your camcorder for a long time, we recommend that you power it from a wall outlet using the AC power adaptor.

- (1) Open the DC IN jack cover, and connect the AC power adaptor to the DC IN jack on your camcorder with the plug's ▲ mark facing up.
- (2) Connect the power cord to the AC power adaptor.
- (3) Connect the power cord to a wall outlet.

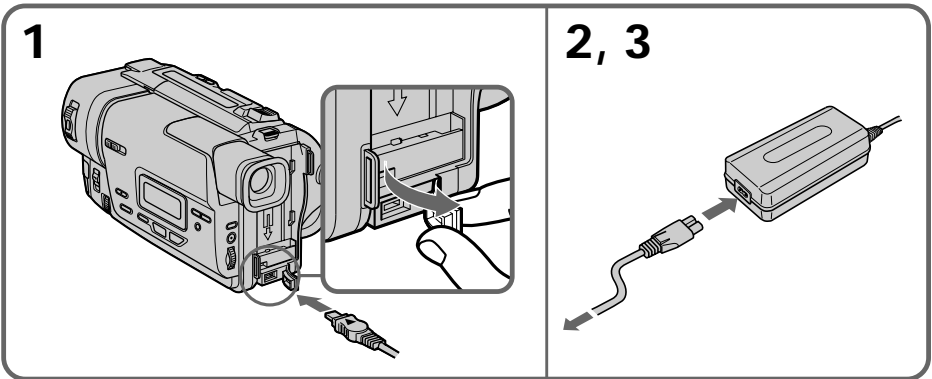

PRECAUTION

The set is not disconnected from the AC power source (house current) as long as it is connected to the wall outlet, even if the set itself has been turned off.

Notes

- The AC power adaptor can supply power even if the battery pack is attached to your camcorder.
- The DC IN jack has "source priority". This means that the battery pack cannot supply any power if the power cord is connected to the DC IN jack, even when the power cord is not plugged into a wall outlet.

Using a car battery

Use Sony DC Adaptor/Charger (not supplied).

Step 2 Inserting a cassette

- (1) Prepare the power supply (p. 9).
- (2) Slide EJECT in the direction of the arrow while pressing the small blue button. The cassette compartment automatically lifts up and opens.
- (3) Insert a cassette with its window facing out and the tab on the cassette up.
- (4) Close the cassette compartment by pressing the **PUSH** mark on the cassette compartment. The cassette compartment automatically goes down.

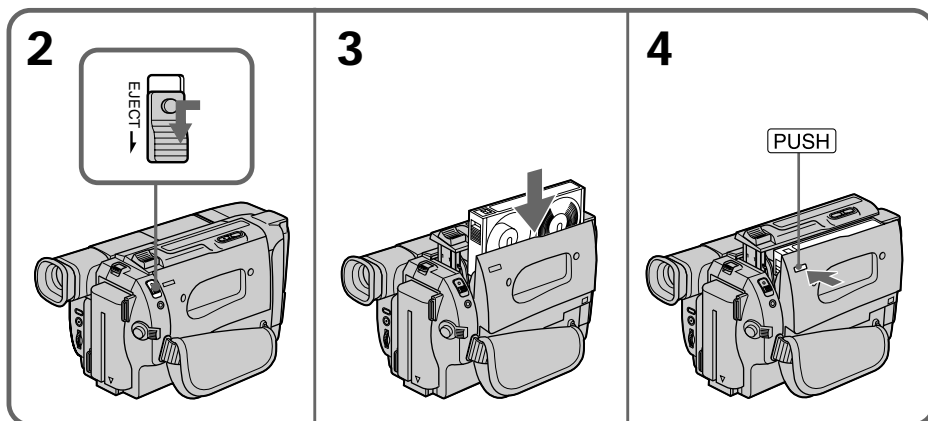

To eject a cassette

Slide EJECT in the direction of the arrow while pressing the small blue button.

Note

Do not press the cassette compartment down. Doing so may cause malfunction.

To prevent accidental erasure

Slide the write-protect tab on the cassette to expose the red mark.

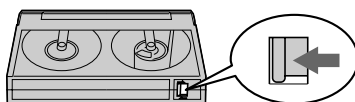

Recording a picture

Your camcorder automatically focuses for you.

You can select English, Spanish, Portuguese or Chinese for the information indicators in the menu settings. The default setting is English.

- (1) Install the power source and insert a cassette. See “Step 1” and “Step 2” for more information (p. 9 to 15).
- (2) Set the POWER switch to CAMERA while pressing the small green button. The lens cover opens.
- (3) Turn STANDBY to STANDBY.
- (4) Press START/STOP. Your camcorder starts recording. The “REC” indicator appears. The camera recording lamp located on the front of your camcorder lights up. To stop recording, press START/STOP again. The recording lamp lights up in the viewfinder. (CCD-TR317 only)

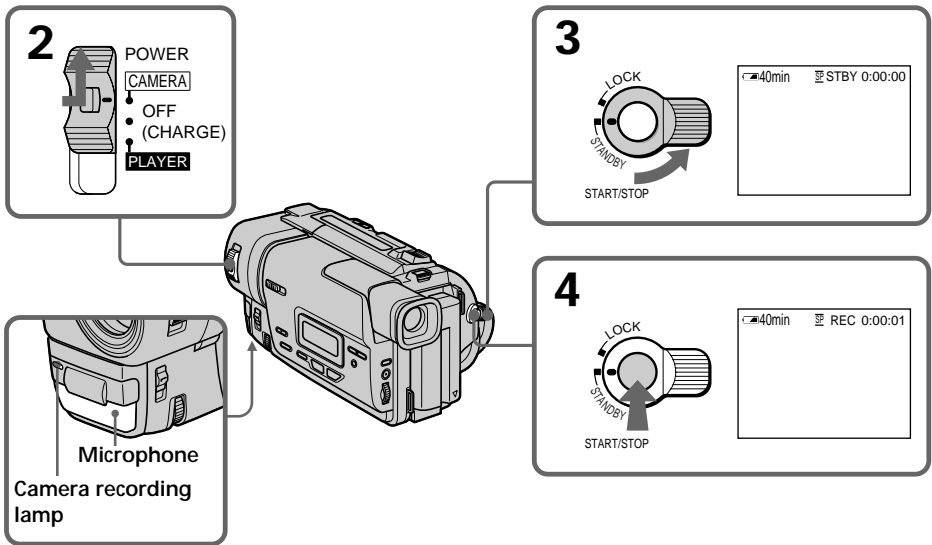

Note

Fasten the grip strap firmly. Do not touch the built-in microphone during recording.

To enable smooth transition

You can make the transition between the last scene you recorded and the next scene smooth as long as you do not eject the cassette. When you exchange the battery pack in the recording mode, set STANDBY to LOCK.

If you leave your camcorder in the standby mode for 5 minutes while the cassette is inserted

Your camcorder automatically turns off. This is to save battery power and to prevent battery and tape wear. To resume the standby mode, turn STANDBY down and up again. To start recording, press START/STOP.

To set the counter to 0:00:00

Press COUNTER RESET (p. 63).

Recording a picture

After recording

- (1) Turn STANDBY down to LOCK.
- (2) Eject the cassette.
- (3) Set the POWER switch to OFF (CHARGE).

To record pictures with the viewfinder – adjusting the viewfinder

Adjust the viewfinder lens to your eyesight so that the indicators in the viewfinder come into sharp focus.

Lift up the viewfinder and move the viewfinder lens adjustment lever.

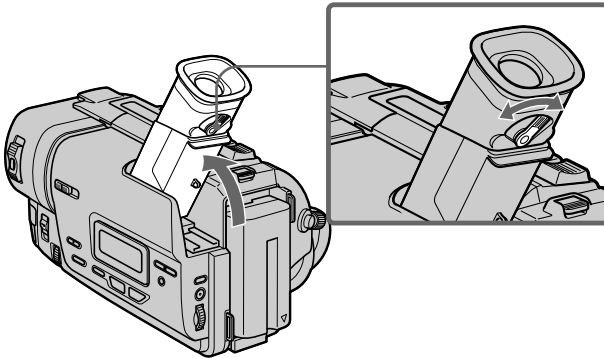

Recording a picture

Using the zoom feature

Move the power zoom lever a little for a slower zoom. Move it further for a faster zoom. Using the zoom function sparingly results in better-looking recordings.

“T” side: for telephoto (subject appears closer)

“W” side: for wide-angle (subject appears farther away)

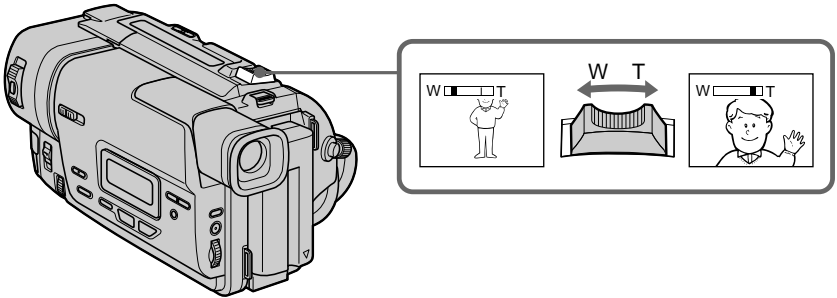

Zoom greater than 20× is performed digitally. To activate digital zoom, select the digital zoom power in D ZOOM in the menu settings. (p. 40)

The picture quality deteriorates as the picture is processed digitally.

The right side of the bar shows the digital zooming zone.
The digital zooming zone appears when you select the digital zoom power in D ZOOM in the menu settings.

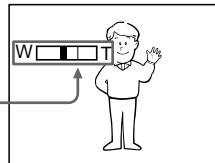

When you shoot close to a subject

If you cannot get a sharp focus, move the power zoom lever to the “W” side until the focus is sharp. You can shoot a subject that is at least about 80 cm away from the lens surface in the telephoto position, or about 1 cm away in the wide-angle position.

Notes on digital zoom

- Digital zoom starts to function when zoom exceeds 20×.
- The picture quality deteriorates as you go toward the “T” side. Set D ZOOM to OFF in the menu settings. Otherwise the digital zoom activates without notice (p. 40).

Recording a picture

Indicators displayed in the recording mode

The indicators are not recorded on tape.

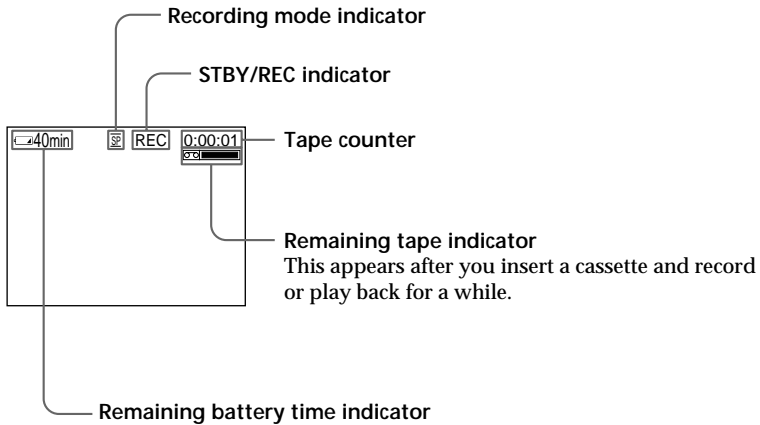

Shooting backlit subjects (BACK LIGHT)

When you shoot a subject with the light source behind the subject or a subject with a light background, use the backlight function.

Press BACK LIGHT in the recording or standby mode.

The  indicator appears in the viewfinder.

To cancel, press BACK LIGHT again.

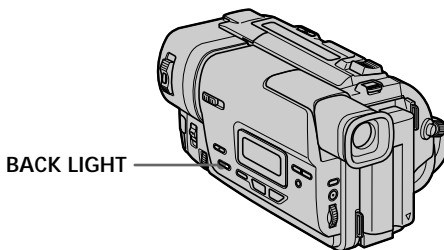

If you press EXPOSURE when shooting backlit subjects

The backlight function will be canceled.

Recording a picture

Shooting in the dark (NightShot)

The NightShot function enables you to shoot a subject in a dark place. For example, you can satisfactorily record the environment of nocturnal animals for observation when you use this function.

While your camcorder is in the standby mode, slide NIGHTSHOT to ON.

☉ and "NIGHTSHOT" indicators flash in the viewfinder. To cancel the NightShot function, slide NIGHTSHOT to OFF.

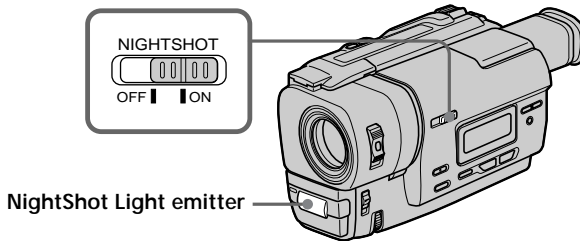

Using the NightShot Light

The picture will be clearer with the NightShot Light on. To enable NightShot Light, set N.S.LIGHT to ON in the menu settings (p. 40).

Notes

- Do not use the NightShot function in bright places (ex. outdoors in the daytime). This may cause your camcorder to malfunction.
- When you keep NIGHTSHOT set to ON in normal recording, the picture may be recorded in incorrect or unnatural colors.
- If focusing is difficult with the autofocus mode when using the NightShot function, focus manually.

While using the NightShot function, you can not use the following functions:

- Exposure
- PROGRAM AE

NightShot Light

NightShot Light rays are infrared and so are invisible. The maximum shooting distance using the NightShot Light is about 3 m.

Recording a picture

Superimposing the date and time on pictures

You can record the date or time displayed in the viewfinder superimposed on the picture.

Carry out the following operations in the standby or recording mode.

Press DATE to record the date.

Press TIME to record the time.

Press DATE (or TIME), then press TIME (or DATE) to record the date and time.

Press DATE and/or TIME again. The date and/or time indicator disappears.

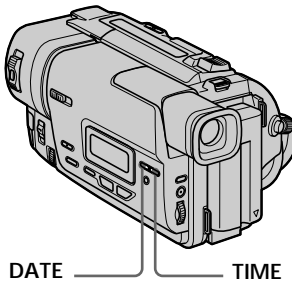

The default clock setting is set to Tokyo time for the models sold in Japan, and to New York time for other models. You can reset the clock in the menu settings (p. 40).

Note

The date and time indicators recorded manually cannot be deleted.

If you do not record the date and time in the picture

Record the date and time in the black screen as the background for about 10 seconds, then erase the date and time indicators before starting actual recording.

Checking the recording

- EDITSEARCH / Rec Review

You can use these buttons to check the recorded picture or shoot so that the transition between the last recorded scene and the next scene you record is smooth.

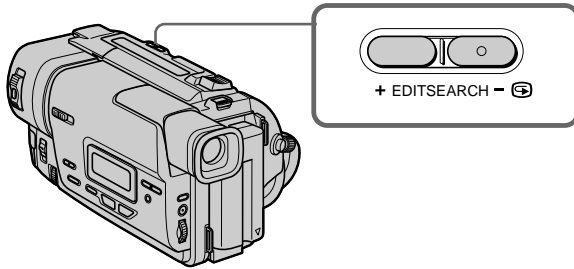

EDITSEARCH

You can search for the next recording start point.

Hold down the +/- (⊖) side of EDITSEARCH in the standby mode. The recorded section is played back.

+ : to go forward

- : to go backward

Release EDITSEARCH to stop playback. If you press START/STOP, re-recording begins from the point you released EDITSEARCH.

Rec Review

You can check the last recorded section.

Press the - (⊖) side of EDITSEARCH momentarily in the standby mode. The last few seconds of the recorded section are played back.

Connections for playback

Connect your camcorder to your TV or VCR with the A/V connecting cable supplied with your camcorder to watch the playback picture on the TV screen. When monitoring the playback picture on the TV screen, we recommend that you power your camcorder from a wall outlet using the AC power adaptor (p. 14). Refer to the operating instructions of your TV or VCR.

Open the jack cover. Connect your camcorder to the TV using the A/V connecting cable. Then, set the TV/VCR selector on the TV to VCR.

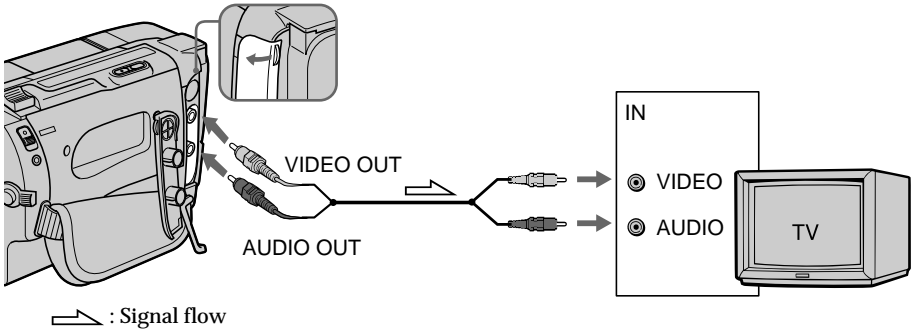

If your TV is already connected to a VCR

Connect your camcorder to the LINE IN input on the VCR by using the A/V connecting cable supplied with your camcorder. Set the input selector on the VCR to LINE.

To connect to a TV or VCR without Video/Audio input jacks

Use an NTSC system RFU adaptor (not supplied).
Refer to the operating instructions of your TV or VCR and the RFU adaptor.

Playing back a tape

You can monitor the playback picture on a TV screen after connecting your camcorder to a TV or VCR. You can also monitor the picture in the viewfinder.

- (1) Install the power source and insert the recorded tape.
- (2) Set the POWER switch to PLAYER while pressing the small green button.
- (3) Press  to rewind the tape.
- (4) Press  to start playback.

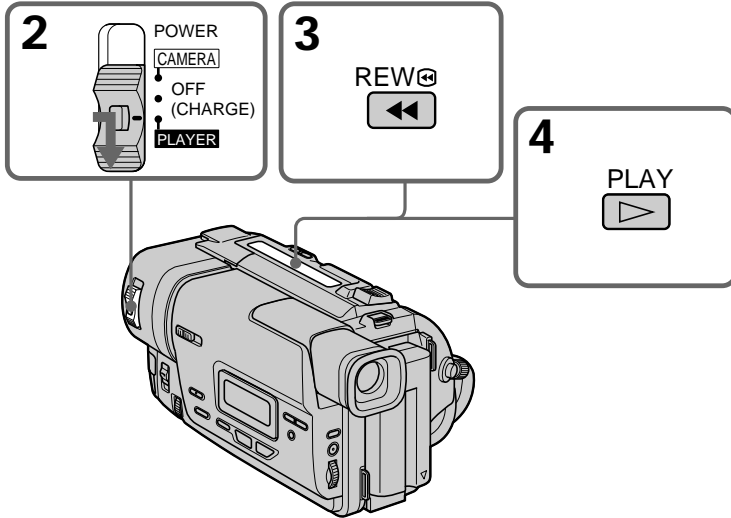

To stop playback

Press .

Playing back a tape

Various playback modes

To operate video control buttons, set the POWER switch to PLAYER.

To view a still picture (playback pause)

Press **II** during playback. To resume playback, press **II** or **▶**.

To advance the tape

Press **▶▶** in the stop mode. To resume normal playback, press **▶**.

To rewind the tape

Press **◀◀** in the stop mode. To resume normal playback, press **▶**.

To locate a scene monitoring the picture (picture search)

Keep pressing **◀◀** or **▶▶** during playback. To resume normal playback, release the button.

To monitor the high-speed picture while advancing or rewinding the tape (skip scan)

Keep pressing **◀◀** while rewinding or **▶▶** while advancing the tape. To resume rewinding or advancing, release the button.

In the various playback modes

Sound is muted.

When the playback pause mode lasts for 5 minutes

Your camcorder automatically enters the stop mode. To resume playback, press **▶**.

When you play back a tape recorded in the LP mode

Noise may appear during playback pause mode or picture search.

The tapes recorded in the Hi8 format

You can play back the tapes recorded in the Hi8 video system on your camcorder.

Using the wide mode

You can record a cinema-like picture (CINEMA) or a 16:9 wide picture to watch on the 16:9 wide-screen TV (16:9FULL). Refer to the operating instructions of your TV.

CINEMA

Black bands appear on the screen during recording in the CINEMA mode [a], playing back on a normal TV [b] or a wide-screen TV [c]. If you set the screen mode of the wide-screen TV to the zoom mode, a picture without black bands appears [d].

16:9FULL

The picture during recording in the 16:9FULL mode [e], or playing back on a normal TV [f] or a wide-screen TV [g] is horizontally compressed. If you set the screen mode of the wide-screen TV to the full mode, you can watch pictures of normal images [h].

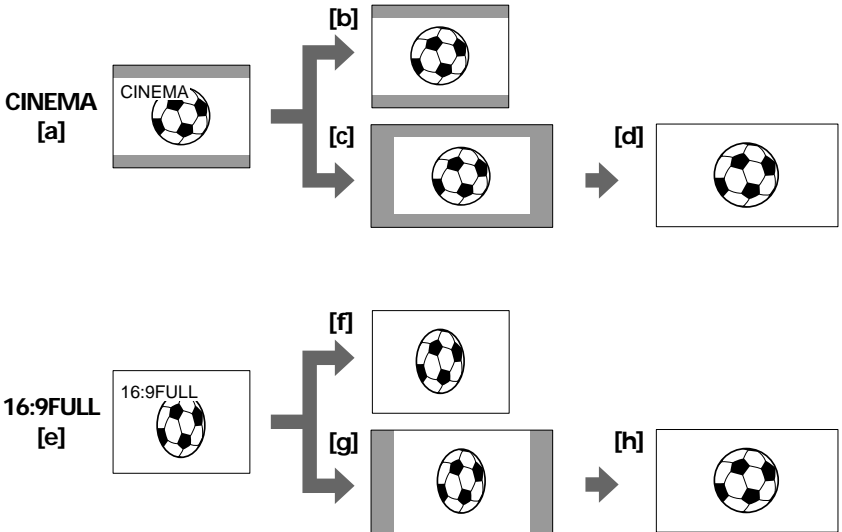

Using the wide mode

In the standby mode, set 16:9WIDE to CINEMA or 16:9FULL in the menu settings (p. 40).

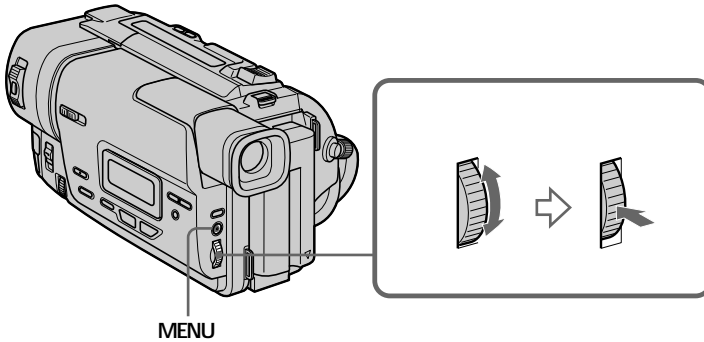

To cancel the wide mode

Set 16:9WIDE to OFF in the menu settings.

In the wide mode

You cannot select the bounce function with FADER.

Date or time indicator

When you record in the 16:9FULL mode, the date or time indicator will be widened on wide-screen TVs.

During recording

You cannot change or cancel the wide mode. When you cancel the wide mode, set your camcorder to the standby mode and then set 16:9WIDE to OFF.

Using the fader function

You can fade in or out to give your recording a professional appearance.

[a] STBY REC

FADER



M.FADER (mosaic)



STRIPE

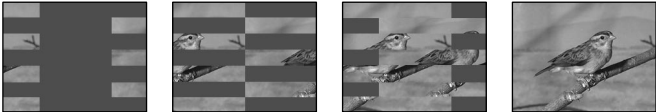

BOUNCE * (Fade in only)



[b] STBY REC

MONOTONE

When fading in, the picture gradually changes from black-and-white to color.
When fading out the picture gradually changes from color to black-and-white.

* You can use this function only when D ZOOM is set to OFF.

Using the fader function

(1) When fading in 

In the standby mode, press FADER until the desired fader indicator flashes.

When fading out 

In the recording mode, press FADER until the desired fader indicator flashes.

The indicator changes as follows:

FADER → M.FADER → STRIPE → BOUNCE → MONOTONE → no indicator

The last selected fader mode is indicated first of all.

(2) Press START/STOP. The fader indicator stops flashing.

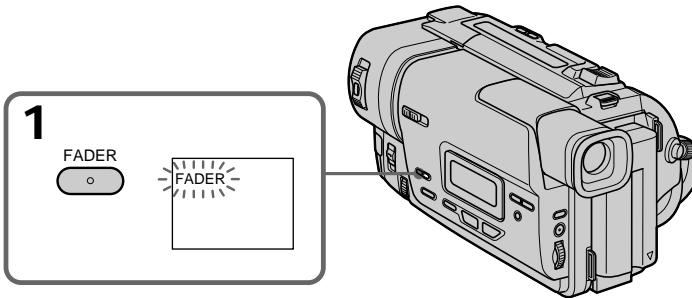

To cancel the fader function

After the fade in/out is carried out : Your camcorder automatically returns to the normal mode.

Before the fade in/out is carried out : Before pressing START/STOP, press FADER until the indicator disappears.

The date, time indicator and title do not fade in or fade out

Erase them before operating the fader function if they are not needed.

While using the bounce function, you cannot use the following functions:

- Exposure
- Focus
- Zoom
- Picture effect

Note on the bounce function

The BOUNCE indicator does not appear in the following mode or functions:

- D ZOOM is set to the mode other than OFF in the menu settings
- Wide mode
- Picture effect
- PROGRAM AE

Using special effects – Picture effect

You can digitally process images to obtain special effects like those in films or on the TV.

PASTEL [a] : The contrast of the picture is emphasized, and the picture looks like an animated cartoon.

NEG. ART [b] : The color and brightness of the picture is reversed.

SEPIA : The picture is sepia.

B&W : The picture is monochrome (black-and-white).

SOLARIZE [c] : The light intensity is clearer, and the picture looks like an illustration.

MOSAIC [d] : The picture is mosaic.

SLIM [e] : The picture expands vertically.

STRETCH [f] : The picture expands horizontally.

[a]



[b]



[c]



[d]



[e]



[f]



(1) Press **PICTURE EFFECT** in the standby or recording mode.

The picture effect indicator appears.

(2) Turn the **SEL/PUSH EXEC** dial to select the desired picture effect mode.

The indicator changes as follows:

PASTEL ↔ NEG.ART ↔ SEPIA ↔ B&W ↔ SOLARIZE ↔ MOSAIC ↔
SLIM ↔ STRETCH

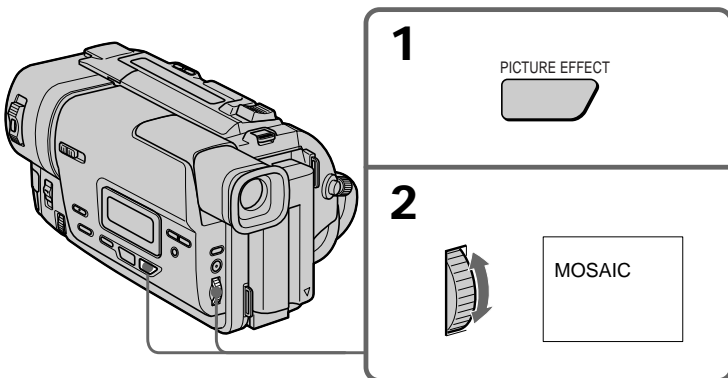

To turn the picture effect function off

Press **PICTURE EFFECT**.

When you turn the power off

Your camcorder automatically returns to the normal mode.

Using the PROGRAM AE function

You can select PROGRAM AE (Auto Exposure) mode to suit your specific shooting requirements.

Spotlight mode

This mode prevents people's faces, for example, from appearing excessively white when shooting subjects lit by strong light in the theater.

Soft portrait mode

This mode brings out the subject while creating a soft background for subjects such as people or flowers.

Sports lesson mode

This mode minimizes shake on fast-moving subjects such as in tennis or golf.

Beach & ski mode

This mode prevents people's faces from appearing dark in strong light or reflected light, such as at a beach in midsummer or on a ski slope.

Sunset & moon mode

This mode allows you to maintain atmosphere when you are recording sunsets, general night views, fireworks displays and neon signs.

Landscape mode

This mode is for when you are recording distant subjects such as mountains and prevents your camcorder from focusing on glass or metal mesh in windows when you are recording a subject behind glass or a screen.



Using the PROGRAM AE function

- (1) Press PROGRAM AE in the standby mode. The PROGRAM AE indicator appears.
- (2) Turn the SEL/PUSH EXEC dial to select the desired PROGRAM AE mode. The indicator changes as follows:

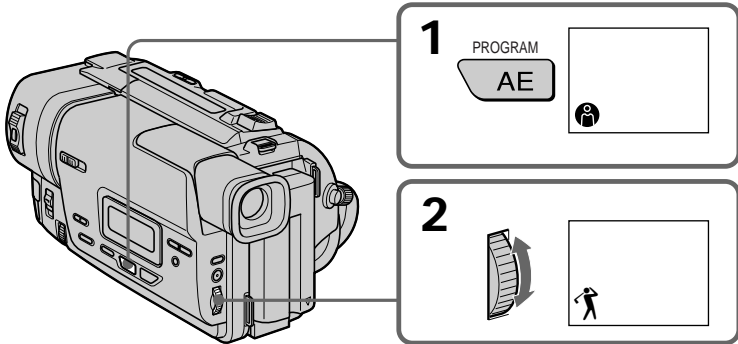
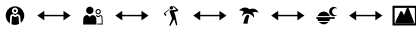

To turn the PROGRAM AE function off

Press PROGRAM AE.

Notes

- In the spotlight, sports lesson and beach & ski modes, you cannot take close-ups. This is because your camcorder is set to focus only on subjects in the middle to far distance.
- In the sunset & moon and landscape modes, your camcorder is set to focus only on distant subjects.
- The following functions do not work in the PROGRAM AE mode:
 - NightShot
 - Bounce
- If you press PROGRAM AE when using the NightShot function, the PROGRAM AE indicator flashes and the PROGRAM AE function does not work.

If you are recording under a discharge tube such as a fluorescent lamp, sodium lamp or mercury lamp

Flickering or changes in color may occur in the following modes. If this happens, turn the PROGRAM AE function off.

- Soft portrait mode
- Sports lesson mode

Adjusting the exposure manually

You can manually adjust and set the exposure.

Adjust the exposure manually in the following cases:

- The subject is backlit
- Bright subject and dark background
- To record dark pictures (e.g. night scenes) faithfully

- (1) Press EXPOSURE in the standby or recording mode.
The exposure indicator appears.
- (2) Turn the SEL/PUSH EXEC dial to adjust the brightness.

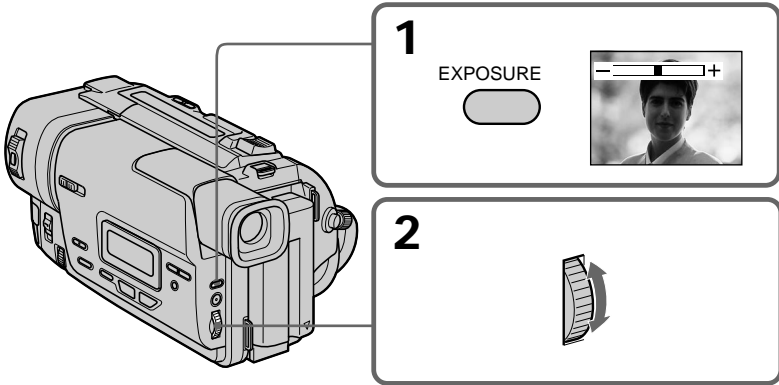

To return to the automatic exposure mode

Press EXPOSURE again.

Note

When you adjust the exposure manually, the backlight function does not work.

Your camcorder automatically returns to the automatic exposure mode:

- if you change the PROGRAM AE mode
- if you slide NIGHTSHOT to ON

Focusing manually

You can gain better results by manually adjusting the focus in the following cases:

- The autofocus mode is not effective when shooting
 - subjects through glass coated with water droplets
 - horizontal stripes
 - subjects with little contrast with backgrounds such as walls and sky
- When you want to change the focus from a subject in the foreground to a subject in the background
- Shooting a stationary subject when using a tripod

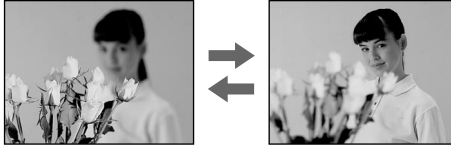

- (1) Set FOCUS to MANUAL in the standby or recording mode. The  indicator appears.
- (2) Turn NEAR/FAR to sharpen focus.

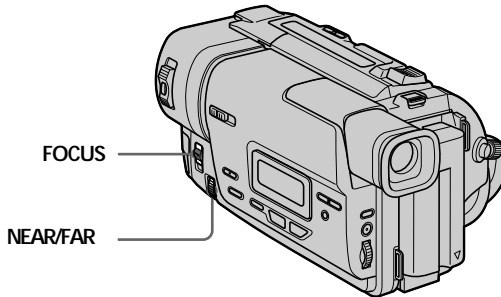

To return to the autofocus mode

Set FOCUS to AUTO.

To record distant subjects

When you press FOCUS down to INFINITY, the lens focuses on infinity and  indicator appears. When you release FOCUS, your camcorder returns to the manual focus mode. Use this mode when your camcorder focuses on near objects even though you are trying to shoot a distant object.



To focus precisely

Adjust the zoom by first focusing at the “T” (telephoto) position and then shooting at the “W” (wide-angle) position. This makes focusing easier.

When you shoot close to the subject

Focus at the end of the “W” (wide-angle) position.

 changes to the following indicators:

-  when recording a distant subject.
-  when the subject is too close to focus on.

Superimposing a title

You can select one of eight preset titles and two custom titles (p. 37). You can also select the language, color, size and position of titles.



- (1) Press TITLE in the standby mode.
- (2) Turn the SEL/PUSH EXEC dial to select \square , then press the dial.
- (3) Turn the SEL/PUSH EXEC dial to select the desired title, then press the dial.
The titles are displayed in the language you selected.
- (4) Change the color, size, or position, if necessary.
 - ① Turn the SEL/PUSH EXEC dial to select the color, size, or position, then press the dial. The item appears.
 - ② Turn the SEL/PUSH EXEC dial to select the desired item, then press the dial.
 - ③ Repeat steps ① and ② until the title is laid out as desired.
- (5) Press the SEL/PUSH EXEC dial again to complete the setting.
- (6) Press START/STOP to start recording.
- (7) When you want to stop recording the title, press TITLE.

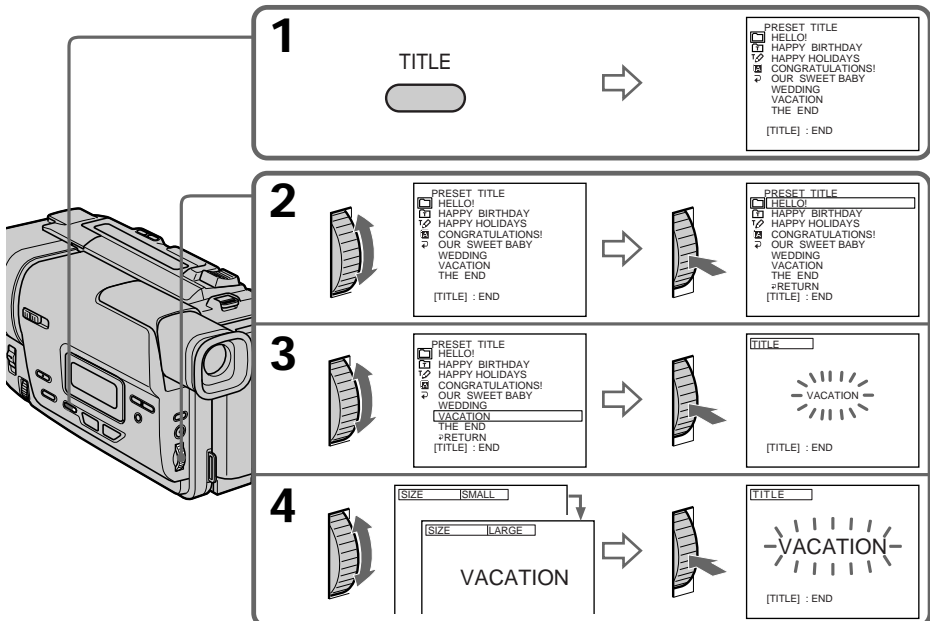

Superimposing a title

To superimpose the title while you are recording

Press TITLE while you are recording, and carry out steps 2 to 5. When you press the SEL/PUSH EXEC dial at step 5, the title is superimposed.

To select the language of a preset title

If you want to change the language, select  before step 2. Then select the desired language and return to step 2.

Note

Both the date and time or either of them may not be displayed depending on the size or position of the title.

If you display the menu or title menu while superimposing a title

The title is not recorded while the menu or title menu is displayed.

To use the custom title

If you want to use the custom title, select  in step 2.

If you have not made any custom title, “- - - - -” appears on the display.

Title setting

- The title color changes as follows :
WHITE ↔ YELLOW ↔ VIOLET ↔ RED ↔ CYAN ↔ GREEN ↔ BLUE
- The title size changes as follows :
SMALL ↔ LARGE
You cannot input more than 13 characters in LARGE size.
- The title position changes as follows :
1 ↔ 2 ↔ 3 ↔ 4 ↔ 5 ↔ 6 ↔ 7 ↔ 8 ↔ 9
The larger the position number, the lower the title is positioned.
When you select the title size “LARGE”, you cannot choose position 9.
When you select the title size “LARGE” in the CINEMA mode, you cannot choose position 8 nor 9.

When you are selecting and setting the title

You cannot superimpose the title displayed on the screen.

When you superimpose a title while you are recording

The beep does not sound.

Making your own titles

You can make up to two titles and store them in your camcorder. Each title can have up to 20 characters.

- (1) Press TITLE in the standby or PLAYER mode.
- (2) Turn the SEL/PUSH EXEC dial to select \varnothing , then press the dial.
- (3) Turn the SEL/PUSH EXEC dial to select the first line (CUSTOM1) or second line (CUSTOM2), then press the dial.
- (4) Turn the SEL/PUSH EXEC dial to select the column of the desired character, then press the dial.
- (5) Turn the SEL/PUSH EXEC dial to select the desired character, then press the dial.
- (6) Repeat steps 4 and 5 until you have selected all characters and completed the title.
- (7) To finish making your own titles, turn the SEL/PUSH EXEC dial to select [SET], then press the dial. The title is stored in memory.
- (8) Press TITLE to make the title menu disappear.

1

TITLE



PRESET TITLE

- HELLO!
- HAPPY BIRTHDAY
- HAPPY HOLIDAYS
- CONGRATULATIONS!
- OUR SWEET BABY
- WEDDING
- VACATION
- THE END

[TITLE] : END



2





TITLE SET

CUSTOM1 "-----"

CUSTOM2 "-----"

[TITLE] : END







TITLE SET

RETURN

[TITLE] : END



3



TITLE SET

RETURN

[TITLE] : END





TITLE SET P1

ABCDE 12345 \$FVWNE

FGHIJ 67890 4i0 :

KLMNO AEIOU [+]

QRST AEIOU [P2]

UVWXY AE0E (SET)

Z & ?1 AONGB

.. /- AIOUA

[TITLE] : END



4



TITLE SET P1

ABCDE 12345 \$FVWNE

FGHIJ 67890 4i0 :

KLMNO AEIOU [+]

QRST AEIOU [P2]

UVWXY AE0E (SET)

Z & ?1 AONGB

.. /- AIOUA

[TITLE] : END





TITLE SET P1

S-----

ABCDE 12345 \$FVWNE

FGHIJ 67890 4i0 :

KLMNO AEIOU [+]

QRST AEIOU [P2]

UVWXY AE0E (SET)

Z & ?1 AONGB

.. /- AIOUA

[TITLE] : END



Advanced Recording Operations

37

Download from Www.Somanuals.com. All Manuals Search And Download.

Making your own titles

To change a title you have stored

In step 3, select CUSTOM1 or CUSTOM2, depending on which title you want to change, then press the SEL/PUSH EXEC dial. Turn the SEL/PUSH EXEC dial to select [←], then press the dial to delete the title. The last character is erased. Enter the new title as desired.

If you take 5 minutes or longer to enter characters in the standby mode while a cassette is in your camcorder

The power automatically goes off. The characters you have entered remain stored in memory. Turn STANDBY down once and then up again, then proceed from step 1. We recommend setting the POWER switch to PLAYER or removing the cassette so that your camcorder does not automatically turn off while you are entering title characters.

If you select [→P2]

The menu for selecting alphabet and Russian characters appear. Select [→P1] to return to the previous screen.

To delete the title

Select [←]. The last character is erased.

Dubbing a tape

Using the A/V connecting cable

Connect your camcorder to the VCR using the A/V connecting cable supplied with your camcorder.

- (1) Insert a blank tape (or a tape you want to record over) into the VCR, and insert the recorded tape into your camcorder.
- (2) Set the input selector on the VCR to LINE.
Refer to the operating instructions of your VCR for more information.
- (3) Set the POWER switch to PLAYER.
- (4) Play back the recorded tape on your camcorder.
- (5) Start recording on the VCR.
Refer to the operating instructions of your VCR for more information.

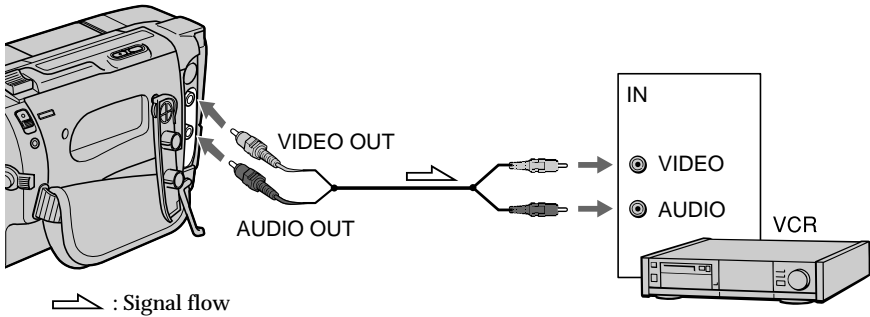

When you have finished dubbing a tape

Press **■** on both your camcorder and the VCR.

To prevent deterioration of pictures from dubbing

Set EDIT to ON in the menu settings before dubbing.

You can edit on VCRs that support the following systems

8 8 mm, **Hi 8** Hi8, **D** Digital8, **VHS** VHS, **S-VHS** S-VHS, **VHS-C** VHS-C, **S-VHS-C** S-VHS-C,
B Betamax, ^{Mini}**DV** mini DV or **DV** DV

Changing the menu settings

To change the mode settings in the menu settings, select the menu items with the SEL/PUSH EXEC dial. The default settings can be partially changed. First, select the icon, then the menu item and then the mode.

- (1) In the standby or PLAYER mode, press MENU.
- (2) Turn the SEL/PUSH EXEC dial to select the desired icon, then press the dial to set.
- (3) Turn the SEL/PUSH EXEC dial to select the desired item, then press the dial to set.
- (4) Turn the SEL/PUSH EXEC dial to select the desired mode, and press the dial to set.
- (5) If you want to change other items, select  RETURN and press the dial, then repeat steps from 2 to 4.

For details, see “Selecting the mode setting of each item” (p. 41).

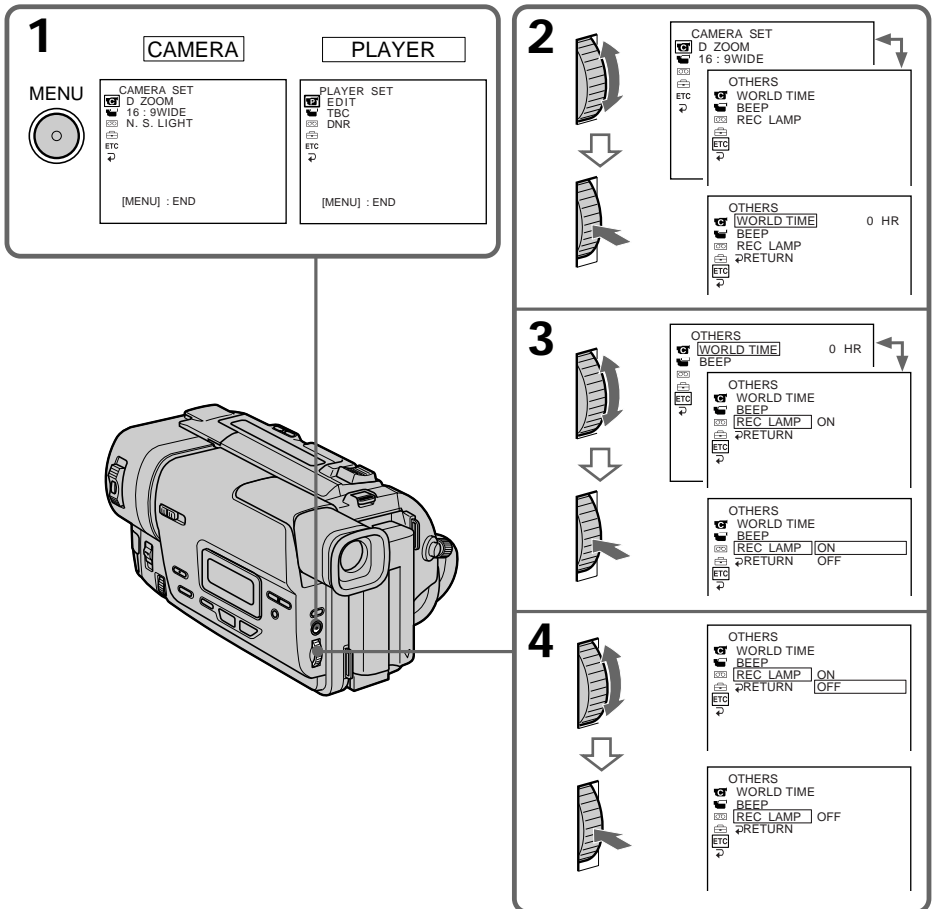

1

MENU

CAMERA SET

D ZOOM

16 : 9WIDE

N. S. LIGHT

[MENU] : END

PLAYER SET

EDIT

TBC

DNR

[MENU] : END

2

CAMERA SET

D ZOOM

16 : 9WIDE

OTHERS

WORLD TIME

BEEP

REC LAMP

OTHERS

WORLD TIME

BEEP

REC LAMP

RETURN

3

OTHERS

WORLD TIME

BEEP

OTHERS

WORLD TIME

BEEP

REC LAMP ON

RETURN

OTHERS

WORLD TIME

BEEP

REC LAMP ON

RETURN OFF

4

OTHERS

WORLD TIME

BEEP

REC LAMP ON

RETURN OFF

OTHERS

WORLD TIME

BEEP

REC LAMP OFF







RETURN

To make the menu display disappear

Press MENU.

Changing the menu settings

Menu items are displayed as the following icons:

-  CAMERA SET
-  PLAYER SET
-  VF SET (CCD-TR517 only)
-  TAPE SET
-  SETUP MENU
-  OTHERS



Depending on your camcorder model

The menu display may be different from that in this illustration.

Selecting the mode setting of each item ● is the default setting.

Menu items differ according to whether the POWER switch is set to PLAYER or CAMERA.

The viewfinder screen shows only the items you can operate at the moment.



Icon/item	Mode	Meaning	POWER switch
 D ZOOM	OFF	To deactivate digital zoom. Up to 20× zoom is carried out.	CAMERA
	40×	To activate digital zoom. More than 20× to 40× zoom is performed digitally. (p. 18)	
	● 200×	To activate digital zoom. More than 20× to 200× zoom is performed digitally. (p. 18)	
16:9WIDE	● OFF	—	CAMERA
	CINEMA	To record in the CINEMA mode (p. 26)	
	16:9FULL	To record in the 16:9FULL mode	
N.S.LIGHT	● ON	To use the NightShot Light function (p. 20)	CAMERA
	OFF	To cancel the NightShot Light function	
 EDIT	● OFF	—	PLAYER
	ON	To minimize picture deterioration when editing	
TBC	● ON	To correct jitter	PLAYER
	OFF	To not correct jitter. Set TBC to OFF when playing back a tape on which you have dubbed over and recorded the signal of a TV game or similar machine.	
TBC stands for “Time Base Corrector”.			
DNR	● ON	To reduce picture noise	PLAYER
	OFF	To reduce a conspicuous afterimage when the picture has a lot of movement	
DNR stands for “Digital Noise Reduction”.			

In more than 5 minutes after removing the power source

The “EDIT” item is returned to its default setting.

The other menu items are held in memory even when the battery is removed, as long as the lithium battery is installed.

Changing the menu settings

Icon/item	Mode	Meaning	POWER switch
 VF B.L. (CCD-TR517 only)	● BRT NORMAL	To set the brightness in the viewfinder normal	PLAYER CAMERA
	BRIGHT	To brighten the viewfinder screen	
 REC MODE	● SP	To record in SP (Standard Play) mode	CAMERA
	LP	To increase the recording time to twice the SP mode	
ORC TO SET		To automatically adjust the recording condition to get the best possible recording. Press START/STOP to start adjustment. Your camcorder takes about 10 seconds to check the tape condition and then returns to the standby mode.	CAMERA
ORC stands for "Optimizing the Recording Condition".			
 REMAIN	● AUTO	To display the remaining tape bar: <ul style="list-style-type: none"> • for about 8 seconds after your camcorder is turned on and calculates the remaining amount of tape • for about 8 seconds after a cassette is inserted and your camcorder calculates the remaining amount of tape • for about 8 seconds after ► is pressed in PLAYER mode • for the period of tape rewinding, forwarding or picture search in the PLAYER mode 	PLAYER CAMERA
	ON	To always display the remaining tape bar	

Note on VF B.L. (CCD-TR517 only)

When you use power sources other than the battery pack, "BRIGHT" is automatically selected.

Notes on the LP mode

- When you record a tape in the LP mode on your camcorder, we recommend playing the tape on your camcorder. When you play back the tape on other camcorders or VCRs, noise may occur in pictures or sound.
- Noise may occur also when you play on your camcorder tapes recorded in the LP mode on other camcorders or VCRs.

Notes on ORC setting

- Each time you eject the cassette, the ORC setting will be canceled. If necessary, reset the setting.
- You cannot use this setting on a tape with the red mark on the cassette exposed. (i. e. the tape is write-protected)
- When you set ORC TO SET, a non-recorded section of about 0.1 seconds appears on the tape. However, note that this non-recorded section disappears from the tape when you continue recording from this section.
- To check if you have already set the ORC setting, select ORC TO SET in the menu settings. "ORC ON" is displayed if ORC TO SET is already set.

Changing the menu settings

Icon/item	Mode	Meaning	POWER switch
 CLOCK SET		To reset the date or time (p. 44)	CAMERA
AUTO DATE	● ON	To record the date for 10 seconds after recording has started	CAMERA
	OFF	To cancel the auto date function	
LTR SIZE	● NORMAL	To display selected menu items in normal size	PLAYER CAMERA
	2×	To display selected menu items at twice the normal size	
LANGUAGE	● ENGLISH	To display the following information indicators in English: REC, STBY, min	PLAYER CAMERA
	ESPAÑOL	To display the information indicators in Spanish	
	PORTUGUÊS	To display the information indicators in Portuguese	
	中文	To display the information indicators in Chinese	
DEMO MODE	● ON	To make the demonstration appear	CAMERA
	OFF	To cancel the demonstration mode	

Notes on DEMO MODE

- You cannot select DEMO MODE when a cassette is inserted in your camcorder.
- DEMO MODE is set to STBY (Standby) at the factory and the demonstration starts about 10 minutes after you have set the POWER switch to CAMERA without a cassette inserted.
To cancel the demonstration, insert a cassette, set the POWER switch to other than CAMERA, or set DEMO MODE to OFF.
- When NIGHTSHOT is set to ON, the NIGHTSHOT indicator appears in the viewfinder and you cannot select DEMO MODE in the menu settings.

Icon/item	Mode	Meaning	POWER switch
 WORLD TIME		To set the clock to the local time. Turn the SEL/PUSH EXEC dial to set a time difference. The clock changes by the time difference you set here. If you set the time difference to 0, the clock returns to the originally set time.	CAMERA
BEEP	● MELODY	To output the melody when you start/stop recording or when an unusual condition occurs on your camcorder	PLAYER CAMERA
	NORMAL	To output the beep sound instead of the melody	
	OFF	To cancel the melody and beep sound	
REC LAMP	● ON	To light up the camera recording lamp at the front of your camcorder	CAMERA
	OFF	To turn the camera recording lamp off so that the subject is not aware of the recording	

Resetting the date and time

To check the preset date and time

Press DATE to display the date indicator.

Press TIME to display the time indicator.

Press DATE (or TIME) and then press TIME (or DATE) to simultaneously display the date and time indicator.

Press DATE and/or TIME again. The date and/or time indicator disappears.

The year changes as follows:

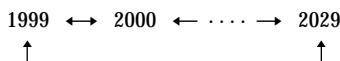

Auto date function

When you use your camcorder for the first time, turn it on and reset the date and time to your time before you start recording (p. 44). The date is automatically recorded for 10 seconds after you start recording (**Auto date function**). This function works only once a day.

Note on the time indicator

The internal clock of your camcorder operates on a 12-hour cycle.

- 12:00 AM stands for midnight.
- 12:00 PM stands for noon.

Note on the auto date function

You can change the AUTO DATE setting by selecting ON or OFF in the menu settings.

The auto date function automatically displays the date once a day.

However, the date may automatically appear more than once a day if:

- you reset the date and time.
- you eject and insert the tape again.
- you stop recording within 10 seconds.
- you set AUTO DATE to OFF once and set it back ON in the menu settings.

Playback modes

What is Video 8 XR ?

“Video 8XR” is a function that further enhances the image quality of Video 8. This function allows you to record and playback pictures with clearer details. Videotapes recorded on a camcorder having the “XR” function show excellent picture quality when they are played back on an “XR” camcorder. The playback quality will be the normal quality of the standard 8 mm camcorder when video tapes recorded on an “XR” camcorder are played back by a conventional standard 8 mm camcorder or when video tapes recorded on a conventional standard 8 mm camcorder are played back on the “XR” camcorder.

* “XR” stands for “Extended Resolution.”

When you play back

The playback mode (SP/LP) is automatically selected according to the recording system in which the tape has been recorded. The quality of the recorded picture in the LP mode, however, will not be as good as the SP mode.

Foreign 8 mm video

Because TV color systems differ from country to country, you may not be able to play back foreign pre-recorded tapes. Refer to “Using your camcorder abroad” to check the TV color systems used in foreign countries.

Changing the lithium battery in your camcorder

When replacing the lithium battery, keep the battery pack or other power source attached. Otherwise, you will need to reset the date, time and other items in the menu settings hold in memory by the lithium battery.

Insert the battery with the positive (+) side facing out. When the battery becomes weak or dead, the  indicator flashes in the viewfinder for about 5 seconds when you set the POWER switch to CAMERA. In this case, replace the battery with a Sony CR2025 or Duracell DL-2025 lithium battery. Use of any other battery may present a risk of fire or explosion. Discard used batteries according to the manufacturer's instructions.

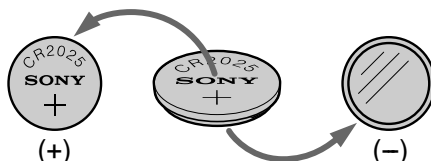

WARNING

The battery may explode if mistreated. Do not recharge, disassemble, nor dispose of it in fire.

Lithium battery

- Keep the lithium battery out of the reach of children.
- Should the battery be swallowed, immediately consult a doctor.
- Wipe the battery with a dry cloth to ensure good contact.

Lithium battery installed at the factory

This battery may not last 1 year.

Changing the lithium battery in your camcorder

Changing the lithium battery

- (1) Open the lid of the lithium battery compartment.
- (2) Push the lithium battery down once and pull it out from the holder.
- (3) Install a Sony CR2025 or Duracell DL-2025 lithium battery with the positive (+) side facing out.
- (4) Close the lid.

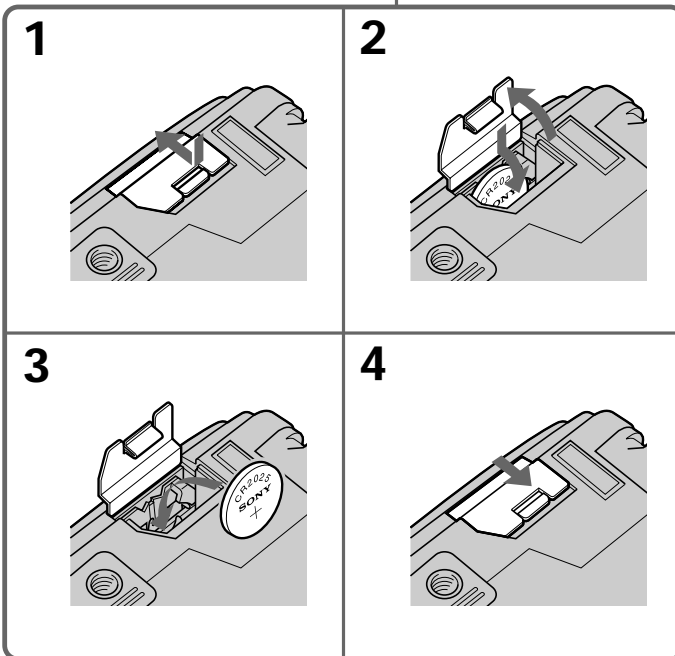
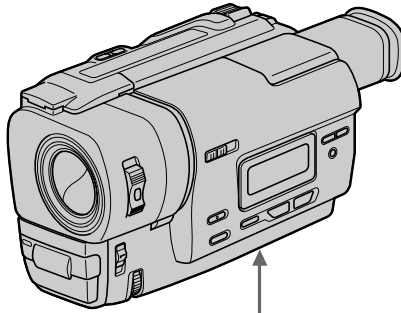

Troubleshooting

If you run into any problem using your camcorder, use the following table to troubleshoot the problem. If the problem persists, disconnect the power source and contact your Sony dealer or local authorized Sony service facility. If "C: □□:□□" appears in the viewfinder, the self-diagnosis display function has worked. See page 52.

In the recording mode

Symptom	Cause and/or Corrective Actions
START/STOP does not operate.	<ul style="list-style-type: none"> • The POWER switch is set to OFF (CHARGE) or PLAYER. → Set it to CAMERA. (p. 16) • STANDBY is set to LOCK. → Turn STANDBY to STANDBY. (p. 16) • The tape has run out. → Rewind the tape or insert a new one. (p. 15, 24) • The write-protect tab is set to expose the red mark. → Use a new tape or slide the tab. (p. 15) • The tape is stuck to the drum (moisture condensation). → Remove the cassette and leave your camcorder for at least 1 hour to acclimatize. (p. 55)
The power goes off.	<ul style="list-style-type: none"> • While being operated in the CAMERA mode, your camcorder has been in the standby mode for more than 5 minutes. → Turn STANDBY down once and then up again. (p. 16)
The image on the viewfinder screen is not clear.	<ul style="list-style-type: none"> • The viewfinder lens is not adjusted. → Adjust the viewfinder lens. (p. 17)
The autofocusing function does not work.	<ul style="list-style-type: none"> • FOCUS is set to MANUAL. → Set it to AUTO. (p. 34) • Shooting conditions are not suitable for autofocus. → Set FOCUS to MANUAL to focus manually. (p. 34)
The  indicator flashes in the viewfinder.	<ul style="list-style-type: none"> • The video heads may be dirty. → Clean the heads using the Sony V8-25CLD cleaning cassette (not supplied). (p. 56)
A vertical band appears when you shoot a subject such as lights or a candle flame against a dark background.	<ul style="list-style-type: none"> • The contrast between the subject and background is too high. This is not a malfunction.
A vertical band appears when you shoot a very bright subject.	<ul style="list-style-type: none"> • This is not a malfunction.
An unknown picture is displayed in the viewfinder.	<ul style="list-style-type: none"> • If 10 minutes elapse after you set the POWER switch to CAMERA or DEMO MODE is set to ON in the menu settings without a cassette inserted, your camcorder automatically starts the demonstration. → Insert a cassette and the demonstration stops. You can also cancel DEMO MODE. (p. 43)

(Continued on the following page)

Troubleshooting

Symptom	Cause and/or Corrective Actions
The picture is recorded in incorrect or unnatural colors.	<ul style="list-style-type: none">• NIGHTSHOT is set to ON. → Set it to OFF. (p. 20)
Picture appears too bright, and the subject does not appear in the viewfinder.	<ul style="list-style-type: none">• NIGHTSHOT is set to ON in a bright place. → Set it to OFF, or use the NightShot function in a dark place. (p. 20)



In the playback mode

Symptom	Cause and/or Corrective Actions
The tape does not move when a video control button is pressed.	<ul style="list-style-type: none">• The POWER switch is set to CAMERA or OFF (CHARGE). → Set it to PLAYER. (p. 24)• The tape has run out. → Rewind the tape. (p. 24)
The playback picture is not clear or does not appear.	<ul style="list-style-type: none">• The television's video channel is not adjusted correctly. → Adjust it. (p. 23)• EDIT is set to ON in the menu settings. → Set it to OFF. (p. 40)• The video head may be dirty. → Clean the heads using the Sony V8-25CLD cleaning cassette (not supplied). (p. 56)

In the recording and playback modes

Symptom	Cause and/or Corrective Actions
The power does not turn on.	<ul style="list-style-type: none">• The battery pack is not installed, or is dead or nearly dead. → Install a charged battery pack. (p. 9, 10)• The AC power adaptor is not connected to a wall outlet. → Connect the AC power adaptor to a wall outlet. (p. 14)
The battery pack is quickly discharged.	<ul style="list-style-type: none">• The operating temperature is too low.• The battery pack is not fully charged. → Charge the battery pack again. (p. 10)• The battery pack is completely dead, and cannot be recharged. → Replace with a new battery pack. (p. 9)
The battery remaining indicator does not indicate the correct time.	<ul style="list-style-type: none">• You have used the battery pack in an extremely hot or cold environment for a long time.• The battery pack is completely dead, and cannot be recharged. → Replace with a new battery pack. (p. 9)• The battery is dead. → Use a charged battery pack. (p. 9, 10)
The power goes off although the battery remaining indicator indicates that the battery pack has enough power to operate.	<ul style="list-style-type: none">→ Charge the battery pack fully again so that the indication on the battery remaining indicator is correct.

Troubleshooting

Symptom	Cause and/or Corrective Actions
The cassette cannot be removed from the holder.	<ul style="list-style-type: none">• The power source is disconnected. → Connect it firmly. (p. 9, 14)• The battery is dead. → Use a charged battery pack. (p. 9, 10)
The  and  indicators flash and no functions except for cassette ejection work.	<ul style="list-style-type: none">• Moisture condensation has occurred. → Remove the cassette and leave your camcorder for at least 1 hour to acclimatize. (p. 55)

Others

Symptom	Cause and/or Corrective Actions
The date or time indicator does not appear, and the bars “--:--:--” appear.	<ul style="list-style-type: none">• Reset the date and time. (p. 44)
The melody or beep sounds for 5 seconds.	<ul style="list-style-type: none">• Moisture condensation has occurred. → Remove the cassette and leave your camcorder for at least 1 hour to acclimatize. (p. 55)• Some troubles has occurred in your camcorder. → Remove the cassette and insert it again, then operate your camcorder.
While charging the battery pack, no indicator appears or the indicator flashes in the display window.	<ul style="list-style-type: none">• The AC power adaptor is disconnected. → Connect it firmly. (p. 10)• Something is wrong with the battery pack. → Contact your Sony dealer or local authorized Sony service facility.

Self-diagnosis display

Your camcorder has a self-diagnosis display function.

This function displays the current condition of your camcorder as a 5-digit code (a combination of a letter and figures) in the viewfinder or the display window. If a 5-digit code is displayed, check the following code chart. The last two digits (indicated by □□) will differ depending on the state of your camcorder.

Viewfinder

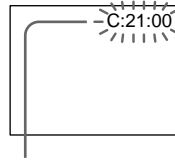

Self-diagnosis display

- C:□□:□□

You can service your camcorder yourself.

- E:□□:□□

Contact your Sony dealer or local authorized Sony facility.

Five-digit display	Cause and/or Corrective Actions
C:04:□□	<ul style="list-style-type: none"> • You are using a battery pack that is not an "InfoLITHIUM" battery pack. → Use an "InfoLITHIUM" battery pack. (p. 13)
C:21:□□	<ul style="list-style-type: none"> • Moisture condensation has occurred. → Remove the cassette and leave your camcorder for at least 1 hour to acclimatize. (p. 55)
C:22:□□	<ul style="list-style-type: none"> • The video heads are dirty. → Clean the heads using the Sony V8-25CLD cleaning cassette (not supplied). (p. 56)
C:31:□□ C:32:□□	<ul style="list-style-type: none"> • A malfunction other than the above that you can service has occurred. → Remove the cassette and insert it again, then operate your camcorder. → Disconnect the power cord of the AC power adaptor or remove the battery pack. After reconnecting the power source, operate your camcorder.
E:61:□□ E:62:□□	<ul style="list-style-type: none"> • A malfunction that you cannot service has occurred. → Contact your Sony dealer or local authorized Sony service facility and inform them of the 5-digit code. (example: E:61:10)

If you are unable to rectify the problem even if you try corrective actions a few times, contact your Sony dealer or local authorized Sony service facility.

Warning indicators and messages

If indicators and messages appear in the viewfinder or the display window, check the following:

See the page in parentheses “ () ” for more information.

The indicators and messages are displayed in yellow. (CCD-TR517 only)

Warning indicators

The video heads are dirty

Slow flashing:

- You need to clean the heads using the Sony V8-25CLD cleaning cassette (not supplied) (p. 56).

The battery is dead or nearly dead

Slow flashing:

- The battery is nearly dead.

Fast flashing:

- The battery is dead (p. 10).
- The battery is completely dead, and cannot be recharged.

Depending on conditions, the  indicator may flash, even if there are 5 to 10 minutes remaining.

Warning indicator as to tape

Slow flashing:

- The tape is near the end.
- No tape is inserted (p. 15).*
- The write-protect tab on the cassette is out (red) (p. 15).*

Fast flashing:

- The tape has run out (p. 15).*

The lithium battery is weak or is not installed (p. 47)

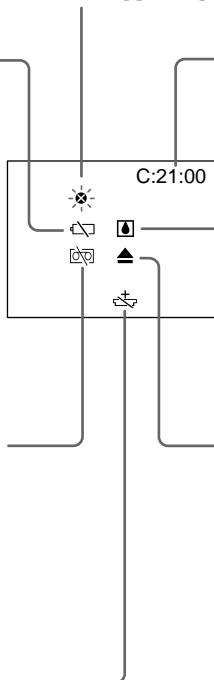

Self-diagnosis display (p. 52)

Moisture condensation has occurred*

Fast flashing:

- Eject the cassette, turn off your camcorder, and leave it for about 1 hour with the cassette compartment open (p. 55).

You need to eject the cassette

Slow flashing:

- The write-protect tab on the cassette is out (red) (p. 15).*

Fast flashing:

- Moisture condensation has occurred (p. 55).
- The tape has run out (p. 15, 24).*
- The self-diagnosis display function is activated (p. 52).*

Warning messages

• CLOCK SET

Reset the date and time (p. 44).

• For “InfoLITHIUM”
BATTERY ONLY

Use an “InfoLITHIUM” battery pack (p. 13).

•  CLEANING CASSETTE

The video heads are dirty (p. 56).

• START/STOP KEY

Press the START/STOP button to activate the ORC setting. This message is displayed in white (p. 42).

• ORC

The ORC setting is working. This message is displayed in white (p. 42).

* You hear the melody or beep sound.

Using your camcorder abroad

Using your camcorder abroad

You can use your camcorder in any country or area with the AC power adaptor supplied with your camcorder within 100 V to 240 V AC, 50/60 Hz.

Your camcorder is an NTSC system based camcorder. If you want to view the playback picture on a TV, it must be an NTSC system based TV with VIDEO/AUDIO input jack. The following shows TV color systems used overseas.

NTSC system

Bahama Islands, Bolivia, Canada, Central America, Chile, Colombia, Ecuador, Jamaica, Japan, Korea, Mexico, Peru, Surinam, Taiwan, the Philippines, the U.S.A., Venezuela, etc.

PAL system

Australia, Austria, Belgium, China, Czech Republic, Denmark, Finland, Germany, Great Britain, Holland, Hong Kong, Italy, Kuwait, Malaysia, New Zealand, Norway, Portugal, Singapore, Slovak Republic, Spain, Sweden, Switzerland, Thailand, etc.

PAL-M system

Brazil

PAL-N system

Argentina, Paraguay, Uruguay

SECAM system



Bulgaria, France, Guyana, Hungary, Iran, Iraq, Monaco, Poland, Russia, Ukraine, etc.

Simple setting of clock by time difference

You can easily set the clock to the local time by setting a time difference. Select WORLD TIME in the menu settings. See page 43 for more information.

Maintenance information and precautions

Moisture condensation

If your camcorder is brought directly from a cold place to a warm place, moisture may condense inside your camcorder, on the surface of the tape, or on the lens. In this condition, the tape may stick to the head drum and be damaged or your camcorder may not operate correctly. If there is moisture inside your camcorder, the beep sounds and the  indicator flashes. When the  indicator flashes at the same time, the cassette is inserted in your camcorder. If moisture condenses on the lens, the indicator will not appear.

If moisture condensation occurred

None of the functions except cassette ejection will work. Eject the cassette, turn off your camcorder, and leave it for about 1 hour with the cassette compartment open. Your camcorder can be used again if the  indicator does not appear when the power is turned on again.

Note on moisture condensation

Moisture may condense when you bring your camcorder from a cold place into a warm place (or vice versa) or when you use your camcorder in a hot place as follows:

- You bring your camcorder from a ski slope into a place warmed up by a heating device
- You bring your camcorder from an air-conditioned car or room into a hot place outside
- You use your camcorder after a squall or a shower
- You use your camcorder in a high temperature and humidity place

How to prevent moisture condensation

When you bring your camcorder from a cold place into a warm place, put your camcorder in a plastic bag and tightly seal it. Remove the bag when the air temperature inside the plastic bag has reached the surrounding temperature (after about 1 hour).

Maintenance information

Cleaning the video head

To ensure normal recording and clear pictures, clean the video heads. The video head may be dirty when:

- The **X** indicator and “ **Ⓢ** CLEANING CASSETTE” message appear one after another or the **X** indicator flashes in the viewfinder.
- Playback pictures contain noise.
- Playback pictures are hardly visible.
- Playback pictures do not appear.

If this happens, clean the video heads with the Sony V8-25CLD cleaning cassette (not supplied).



[a] Slightly dirty

[b] Very dirty

Note on video heads

When the playback pictures are still contain noise even if you have cleaned the video heads with a cleaning cassette, the video heads may have worn down due to long use. If this is the case, they must be replaced with new heads. Contact your Sony dealer or local authorized Sony service facility.

Removing dust from inside the viewfinder

– CCD-TR317 only

- (1) Remove the screw with a screwdriver (not supplied). (2) Then, while holding the RELEASE knob up, (3) turn the eyecup in a counterclockwise direction and pull it out.
- (2) Clean the surface with a commercially available blower for a still camera.
- (3) Turn the eyecup in a clockwise direction, then replace the screw.

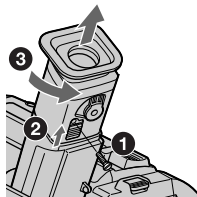

Caution

Do not remove any other screws. You may remove only the screw to remove the eyecup.

Precautions

Camcorder operation

- Operate your camcorder on 7.2 V (battery pack) or 8.4 V (AC power adaptor).
- For DC or AC operation, use the accessories recommended in this operating instructions.
- If any solid object or liquid get inside the casing, unplug your camcorder and have it checked by a Sony dealer before operating it any further.
- Avoid rough handling or mechanical shock. Be particularly careful of the lens.
- Keep the POWER switch set to OFF (CHARGE) when you are not using your camcorder.
- Do not wrap your camcorder with a towel, for example, and operate it. Doing so might cause heat to build up inside.
- Keep your camcorder away from strong magnetic fields or mechanical vibration.

On handling tapes

Do not insert anything into the small holes on the rear of the cassette. These holes are used to sense the type and thickness of the tape and if the recording tab is in or out.

Camcorder care

- When your camcorder is not to be used for a long time, remove the battery.
- Remove the tape, and periodically turn on the power, operate the CAMERA and PLAYER sections and play back a tape for about 5 minutes when your camcorder is not to be used for a long time.
- Clean the lens with a soft brush to remove dust. If there are fingerprints on the lens, remove them with a soft cloth.
- Clean the camcorder body with a dry soft cloth, or a soft cloth lightly moistened with a mild detergent solution. Do not use any type of solvent which may damage the finish.
- Do not let sand get into your camcorder. When you use your camcorder on a sandy beach or in a dusty place, protect it from the sand or dust. Sand or dust may cause your camcorder to malfunction, and sometimes this malfunction cannot be repaired.

AC power adaptor

- Unplug the unit from a wall outlet when you are not using the unit for a long time. To disconnect the power cord, pull it out by the plug. Never pull the power cord itself.
- Do not operate the unit with a damaged cord or if the unit has been dropped or damaged.
- Do not bend the power cord forcibly, or place a heavy object on it. This will damage the cord and may cause fire or electrical shock.
- Prevent metallic objects from coming into contact with the metal parts of the connecting section. If this happens, a short may occur and the unit may be damaged.
- Always keep metal contacts clean.
- Do not disassemble the unit.
- Do not apply mechanical shock or drop the unit.
- While the unit is in use, particularly during charging, keep it away from AM receivers and video equipment. AM receivers and video equipment disturb AM reception and video operation.
- The unit becomes warm during use. This is not a malfunction.
- Do not place the unit in locations that are:
 - Extremely hot or cold
 - Dusty or dirty
 - Very humid
 - Vibrating

Maintenance information and precautions

Battery pack

- Use only the specified charger or video equipment with the charging function.
- To prevent accident from a short circuit, do not allow metal objects to come into contact with the battery terminals.
- Keep the battery pack away from fire.
- Never expose the battery pack to temperatures above 60°C (140°F), such as in a car parked in the sun or under direct sunlight.
- Keep the battery pack dry.
- Do not expose the battery pack to any mechanical shock.
- Do not disassemble nor modify the battery pack.
- Attach the battery pack to the video equipment securely.
- Charging while some capacity remains does not affect the original battery capacity.

If any problem occurs, unplug your camcorder and contact your nearest Sony dealer.

Specifications

Video camera recorder

System

Video recording system

2 rotary heads

Helical scanning FM system

Audio recording system

Rotary heads, FM system

Video signal

NTSC color, EIA standards

Usable cassette

8 mm video format cassette

Standard 8

Recording/playback time (using cassette P6-120)

SP mode: 2 hours

LP mode: 4 hours

Fastforward/rewind time (using cassette P6-120)

Approx. 5 min.

Viewfinder

Electric viewfinder

CCD-TR317: monochrome

CCD-TR517: color

Image device

1/6 inch CCD (Charged Coupled Device)

Approx. 270,000 pixels (Effective:

Approx. 250,000 pixels)

Lens

Combined power zoom lens

Filter diameter 37 mm

20× (Optical), 200× (Digital)

Focal length

3.6 - 72 mm

When converted to a 35 mm still camera

51.8 - 1036 mm

Color temperature

Auto

Minimum illumination

1 lux (F 1.4)

0 lux (in the NightShot mode)*

* Objects unable to be seen due to the dark can be shot with infrared lighting.

Input / output connectors

Video output

Phono jack, 1 Vp-p, 75 ohms, unbalanced

Audio output

Monaural, phone jack, 327 mV

RFU DC OUT

Special minijack, DC 5V

LANC control jack

Stereo mini-minijack (ø 2.5 mm)

MIC jack

Monaural minijack (ø 3.5 mm)

General

Power requirements

7.2 V (battery pack)

8.4 V (AC power adaptor)

Average power consumption (when using the battery pack)

During camera recording

CCD-TR317 : 2.3 W

CCD-TR517 : 1.9 W

Operating temperature

0 °C to 40 °C (32 °F to 104 °F)

Storage temperature

-20 °C to +60 °C (-4 °F to +140 °F)

Dimensions (approx.)

CCD-TR317:

102 × 106 × 212 mm (w/h/d)

CCD-TR517:

102 × 106 × 195 mm (w/h/d)

Mass (approx.)

740 g (1 lb 10 oz)

excluding the battery pack, lithium battery, cassette and shoulder strap

880 g (1 lb 15 oz)

including the battery pack

NP-F330, lithium battery CR2025, cassette P6-120 and shoulder strap

Supplied accessories

See page 8.

AC power adaptor

Power requirements

100 - 240 V AC, 50/60 Hz

Power consumption

23 W

Output voltage

DC OUT: 8.4 V, 1.5 A in operating mode

Operating temperature

0 °C to 40 °C (32 °F to 104 °F)

Storage temperature

-20 °C to +60 °C (-4 °F to +140 °F)

Dimensions (approx.)

125 × 39 × 62 mm (w/h/d)

excluding projecting parts

Mass (approx.)

280 g

excluding power cord

Battery pack

Output voltage

DC 7.2 V

Capacity

5.0 Wh

Dimensions (approx.)

38 × 21 × 71 mm (w/h/d)

Mass (approx.)

95 g

Type

Lithium ion

Design and specifications are subject to change without notice.

Identifying the parts and controls

Camcorder

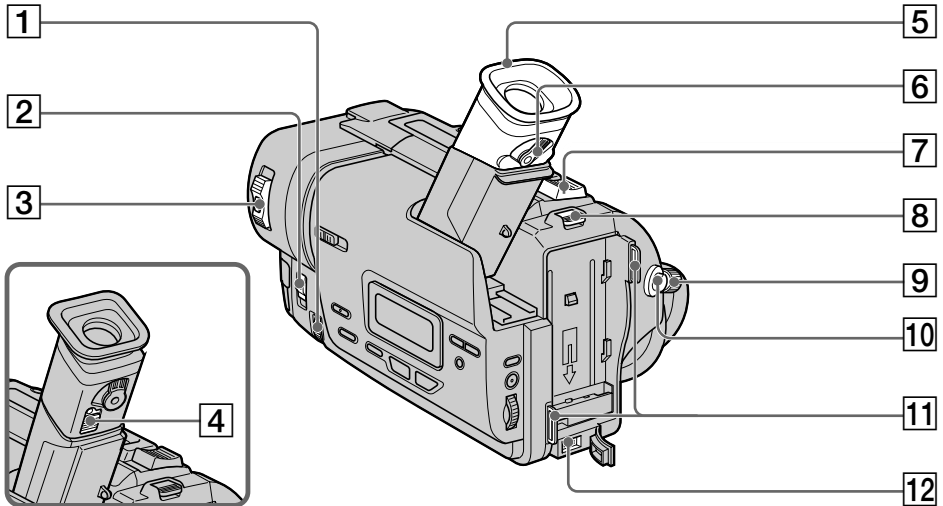

- 1 NEAR/FAR dial (p. 34)
- 2 FOCUS switch (p. 34)
- 3 POWER switch (p. 16)
- 4 Eyecup RELEASE knob (CCD-TR317 only) (p. 56)
- 5 Eyecup (p. 56)
- 6 Viewfinder lens adjustment lever (p. 17)
- 7 Power zoom lever (p. 18)
- 8 BATT RELEASE lever (p. 9)
- 9 STANDBY switch (p. 16)
- 10 START/STOP button (p. 16)
- 11 Hooks for shoulder strap (p. 62)
- 12 DC IN jack (p. 10, 14)

Identifying the parts and controls

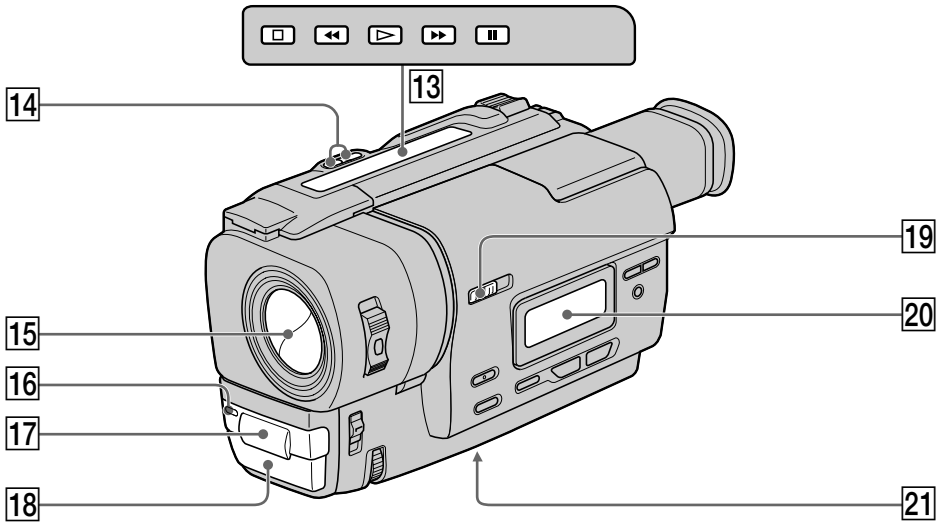

13 Video control buttons (p. 24, 25)

- STOP (stop)
- ◀◀ REW (rewind)
- ▶ PLAY (playback)
- ▶▶ FF (fastforward)
- || PAUSE (pause)

14 EDITSEARCH button (p. 22)

15 Lens cover (p. 16)

16 Camera recording lamp (p. 16)

17 Infrared rays emitter (p. 20)

18 Microphone

19 NIGHTSHOT switch (p. 20)

20 Display window (p. 65)

21 Tripod receptacle (base)

Make sure that the length of the tripod screw is less than 6.5 mm. Otherwise, you cannot attach the tripod securely and the screw may damage your camcorder.

Identifying the parts and controls

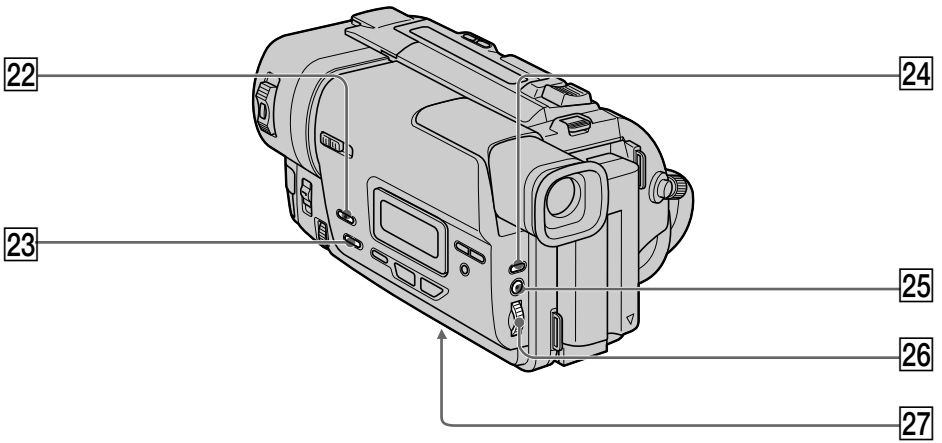

22 FADER button (p. 28)

23 BACK LIGHT button (p. 19)

24 EXPOSURE button (p. 33)

25 MENU button (p. 40)

26 SEL/PUSH EXEC dial (p. 32, 40)

27 Lithium battery compartment (p. 48)

Attaching the shoulder strap

Attaching the shoulder strap
parts

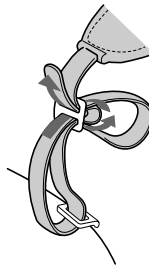

Identifying the parts and controls

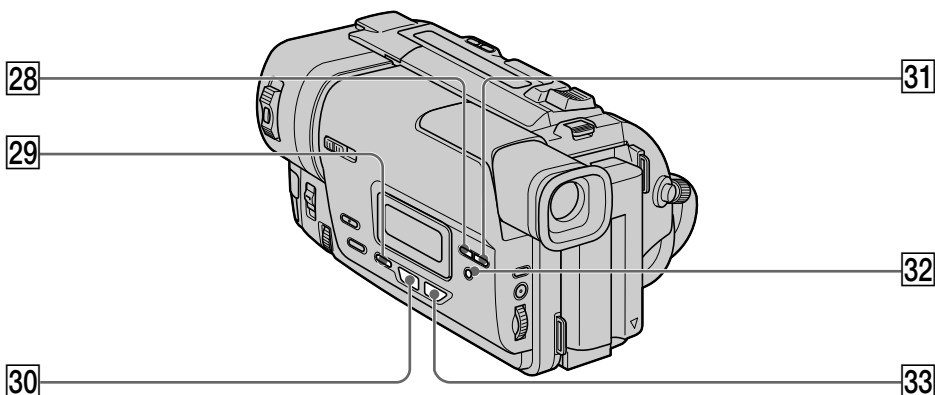

28 DATE button (p. 21)

29 TITLE button (p. 35)

30 PROGRAM AE button (p. 31)



31 TIME button (p. 21)

32 COUNTER RESET button (p. 16)

33 PICTURE EFFECT button (p. 30)

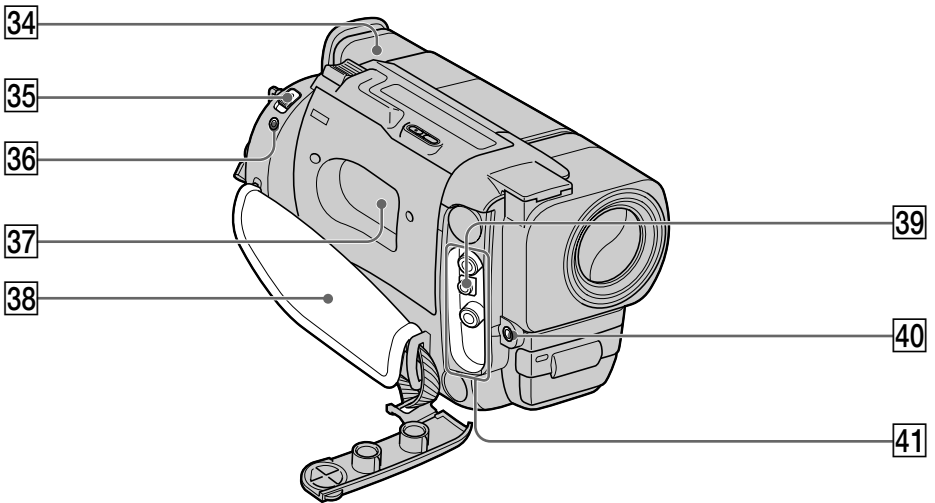
Identifying the parts and controls



- 34** Viewfinder (p. 17)
- 35** EJECT switch (p. 15)
- 36** LANC  control jack
LANC stands for Local Application Control Bus System. The  control jack is used for controlling the tape transport of video equipment and other peripherals connected to the video equipment. This jack has the same function as the jack indicated as CONTROL L or REMOTE.
- 37** Cassette compartment (p. 15)
- 38** Grip strap
- 39** RFU DC OUT (RFU adaptor DC output) jack (p. 23)
- 40** MIC jack (PLUG IN POWER)
Connect an external microphone (not supplied). This jack also accepts a "plug-in-power" microphone. If you connect a 2-pin microphone, supply power from DC OUT jack.
- 41** AUDIO/VIDEO jacks (p. 23)

Fastening the grip strap

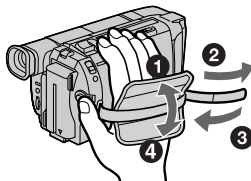

Identifying the parts and controls

Operation indicators

Viewfinder

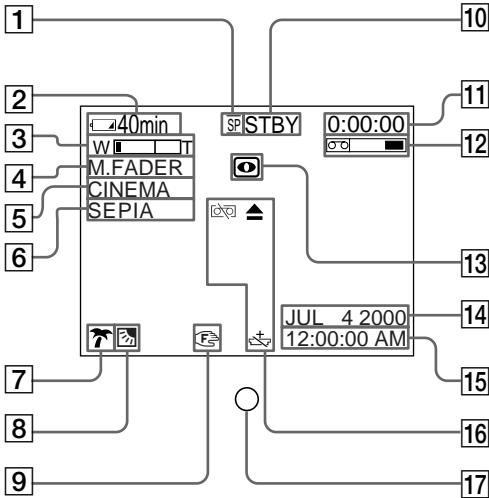

Display window

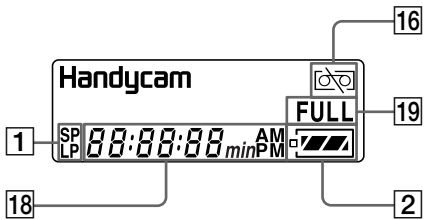

- 1 Recording mode indicator (p. 42)
- 2 Remaining battery time indicator (p. 19)
- 3 Exposure indicator (p. 33)/Zoom indicator (p. 18)
- 4 Fader indicator (p. 29)
- 5 Wide mode indicator (p. 26)
- 6 Picture effect indicator (p. 30)
- 7 PROGRAM AE indicator (p. 32)
- 8 Backlight indicator (p. 19)
- 9 Manual focusing indicator (p. 34)
- 10 STBY/REC indicator (p. 19)/ Video control mode indicator (p. 25)
- 11 Tape counter indicator (p. 19)/Self-diagnosis display indicator (p. 52)

- 12 Remaining tape indicator (p. 19)
- 13 NIGHTSHOT indicator (p. 20)
- 14 AUTO DATE indicator (p. 45)/Date indicator (p. 21, 44)
- 15 Time indicator (p. 21, 44)
- 16 Warning indicators (p. 53)
- 17 Recording lamp (CCD-TR317 only) (p. 16)
- 18 Date or time indicator (p. 21, 44)/Tape counter indicator (p. 19)/Self-diagnosis display indicator (p. 52)/Remaining battery time indicator (p. 10)
- 19 FULL charge indicator (p. 10)

Quick Function Guide

Functions to adjust exposure (in the recording mode)

tesus sa lus sturive kcal nē
wiv tgin larog no
stejhus tilcab gi tds
etakt et ta salus , tgi l tps nē
tneve
tgi l etel fer no tgi l gots nē
ps kansi nē

NGHISHOP
BACKLIGHT(p.19)
D

Functions to give images more impact (in the recording mode)

arecs reetb noit isart hto nē
sgh fo gissecp lat igē
rof dimgcab t fcs a gi tae
eltit a gij nē

FADER
PICTUREEFFECT(p.30)
TITLE(p.35)

Functions to give a natural appearance to your recordings (in the recording mode)

entcip fo noitaciretel gi tae
nē kt igē
y limg sē
ce jhus tratsid gi tds
stejhus givontsaf gidroē

DZOOM[MENU](p.40)
N
D

Functions to use in editing (in the recording mode)

Vmselanatph gē
nētal et hvgicē
set do gicē

V
ORC [MENU] (p. 40)

Functions to use after recording (in the playback mode)

rettij gi tce nē
esin nē gicē

TBC [MENU] (p. 40)
DNR [MENU] (p. 40)

Index

A, B

AC power adaptor	10
Adjusting viewfinder	17
A/V connecting cable	23, 39
BACK LIGHT	19
Battery pack	9
Beep	43
BOUNCE	28

C, D

Charging battery	10
Clock set	44
Connection (viewing on TV)	23
(dubbing a tape)	39
DEMO	43
DNR	41
Dubbing a tape	39

E

EDIT	41
EDITSEARCH	22
Exposure	33
External microphone (not supplied)	64

F, G, H

FADER	28
Fade in/out	28
FOCUS	34
Full charge	10
Grip strap	64
Heads	56

I, J, K, L

"InfoLITHIUM" battery	13
Infrared rays emitter	20
LANC	64
LP mode	42

M, N

Manual focus	34
Menu settings	40
Moisture condensation	55
MONOTONE	28
Mosaic fader	28
NIGHTSHOT	20
Normal charge	10
NTSC system	54

O, P, Q

Operation indicators	65
ORC	42
Picture effect	30
Picture search	25
Playback pause	25
Power sources (house current)	14
(car battery)	14
(battery pack)	9
Power zoom	18
PROGRAM AE	31

R

Rec Review	22
Recording and playback systems	46
Recording mode	42
Recording time	12
Remaining tape indicator	19
Remaining battery time indicator	19
Remote control jack (LANC)	64
RFU adaptor	23

S

Self-diagnosis display	52
SEL/PUSH EXEC dial	62
Shoulder strap	62
Skip scan	25
Standard 8 mm system	46
STRIPE	28
Superimposing the date and time	21

T, U, V

Tape counter	19
TBC	41
Telephoto	18
Title	35
Transition	22
TV color systems	54

W, X, Y, Z

Warning indicators	53
Wide-angle	18
Wide mode	26
WORLD TIME	43
Write-protect tab	15
Zoom	18



Sony  line <http://www.world.sony.com/>

Sony Corporation Printed in Japan

Printed on recycled paper

Download from [Www.Somanuals.com](http://www.Somanuals.com). All Manuals Search And Download.

Free Manuals Download Website

<http://myh66.com>

<http://usermanuals.us>

<http://www.somanuals.com>

<http://www.4manuals.cc>

<http://www.manual-lib.com>

<http://www.404manual.com>

<http://www.luxmanual.com>

<http://aubethermostatmanual.com>

Golf course search by state

<http://golfingnear.com>

Email search by domain

<http://emailbydomain.com>

Auto manuals search

<http://auto.somanuals.com>

TV manuals search

<http://tv.somanuals.com>