

*Sunbeam*

# Café Espresso® II

## 15 BAR pump espresso machine

Instruction Booklet  
EM3820

Please read these instructions carefully and retain for future reference.





# Contents

<b>Sunbeam's Safety Precautions</b>	<b>2</b>
<b>About espresso coffee</b>	<b>3</b>
<b>Features of your Café Espresso® II</b>	<b>4</b>
<b>Operations Guide for your Café Espresso® II</b>	<b>7</b>
<b>Secrets to the perfect cup</b>	<b>11</b>
<b>Easy steps for texturing milk</b>	<b>12</b>
<b>Before using your Café Espresso® II</b>	<b>13</b>
<b>Functions of your Café Espresso® II</b>	<b>14</b>
<b>Care and Cleaning</b>	<b>17</b>
<b>Descaling</b>	<b>19</b>
<b>Trouble Shooting Guide</b>	<b>21</b>
<b>Recipes</b>	<b>24</b>

## Important instructions – retain for future use.

تأكد من تفهم احتياطات السلامة المذكورة اعلاه

請務必理解上述的安全預防措施。

Assurez-vous que les précautions ci-dessus relatives à la sécurité sont bien comprises

Versichern Sie sich daß die obenstehenden Sicherheitsmaßnahmen Verstanden werden

Βεβαιώνετε πως οι παραπάνω προφυλάξεις ασφαλείας γίνονται κατανοητές

Pastikan bahwa tindakan-tindakan keselamatan seperti di atas dimengerti anda

Accertatevi che le suddette norme di sicurezza siano comprese a dovere

上記の注意事項をよくお読みになり、安全を御確認ください

Уверете се дека погоре споменатите мерки на претпазливост се добро разбрани

Asegúrese de que las precauciones de seguridad precedentes sean bien comprendidas

کاری یکنید که احتیاطهای بالا حتماً درک بشوند

ต้องแน่ใจว่า ข้อควรระวังเรื่องความปลอดภัยข้างต้น เป็นที่เข้าใจกันดี

Yukarda belirtilen güvenlik önlemlerinin anlaşıldığınızdan emin olunuz

Xin kiểm chắc rằng những biện pháp làm an toàn kể trên được hiểu rõ

# Sunbeam's Safety Precautions

## SAFETY PRECAUTIONS FOR YOUR SUNBEAM ESPRESSO MACHINE.

- Always place the unit on a flat, level surface.
- Do not operate without water in reservoir.
- Do not remove the filter holder during water flow or coffee flow as the unit is under pressure. Removing the filter holder during operation can lead to a scalding or injury.
- Clean the steam nozzle only when the unit has been switched off and allowed to cool.

**Sunbeam is very safety conscious when designing and manufacturing consumer products, but it is essential that the product user also exercise care when using an electrical appliance. Listed below are precautions which are essential for the safe use of an electrical appliance:**

- Read carefully and save all the instructions provided with an appliance.
  - Always turn the power off at the power outlet before you insert or remove a plug. Remove by grasping the plug - do not pull on the cord.
  - Turn the power off and remove the plug when the appliance is not in use and before cleaning.
  - Do not use your appliance with an extension cord unless this cord has been checked and tested by a qualified technician or service person.
  - Always use your appliance from a power outlet of the voltage (A.C. only) marked on the appliance.
  - This appliance is not intended for use by persons (including children) with reduced physical, sensory or mental capabilities, or lack of experience and knowledge, unless they have been given supervision or instruction concerning use of the appliance by a person responsible for their safety.
  - Children should be supervised to ensure that they do not play with the appliance.
  - The temperature of accessible surfaces may be high when the appliance is operating.
  - Never leave an appliance unattended while in use.
  - Disconnect the plug from the power outlet if there is any problem during the coffee making process or prior to cleaning your appliance.
  - Do not allow the power cord to come into contact with the hot parts of the appliance (cup warming plate, filter holder, steam nozzle).
  - Keep hands away from hot parts of the appliance, including the cup warming plate, filter holder and steam nozzle.
- 
- Do not use an appliance for any purpose other than its intended use.
  - Do not place an appliance on or near a hot gas flame, electric element or on a heated oven.
  - Do not place on top of any other appliance.
  - Do not let the power cord of an appliance hang over the edge of a table or bench top or touch any hot surface.
  - Do not operate any electrical appliance with a damaged cord or after the appliance has been damaged in any manner. If damage is suspected, return the appliance to the nearest Sunbeam Appointed Service Centre for examination, repair or adjustment.
  - For additional protection, Sunbeam recommend the use of a residual current device (RCD) with a tripping current not exceeding 30mA in the electrical circuit supplying power to your appliances.
  - Do not immerse the appliance in water or any other liquid unless recommended.
  - Appliances are not intended to be operated by means of an external timer or separate remote control system.
  - This appliance is intended to be used in household and similar applications such as: staff kitchen areas in shops, offices and other working environments; farm houses; by clients in hotels, motels and other residential type environments; bed and breakfast type environments.

If you have any concerns regarding the performance and use of your appliance, please visit [www.sunbeam.com.au](http://www.sunbeam.com.au) or contact the Sunbeam Consumer Service Line. Ensure the above safety precautions are understood.

# About espresso coffee

The Sunbeam Café Espresso® II utilises technology and engineering from commercial espresso machines to ensure cafe-quality coffee in an easy to use design. With the Café Latte a growing favourite amongst coffee lovers the inclusion of the extra cup height clearance to the design allows the espresso to pour straight into a latte glass or your favourite mug. Enjoy the sweet aroma and taste of the perfect shot of espresso with its signature golden crema every time.

## **What makes a good coffee?**

Sunbeam have consulted with experienced coffee makers and appreciators of coffee through every stage of design, to ensure the machine delivers a great shot of espresso every time. There are many factors that contribute to the perfect espresso. The words 'taste' and 'aroma' are consistently used when describing the perfect cup.

The sweet aroma and taste of the perfect coffee is largely due to the correct combination of temperature and pressure during the brewing process. The Thermoblock heating system ensures the water is at the correct temperature, so that the full coffee flavour is extracted.

Secondly, the combination of the 15 BAR pump, dual-wall filter and stabilising baffle ensures the correct pressure at which the liquid espresso is released from the spout. The flow should consist of both liquid and cream. This cream is commonly known as the 'crema'. The perfect crema should be thick and stable and preserve the coffee flavour, aroma and temperature.

For more tips on how to create the perfect cup of coffee, turn to 'secrets to the perfect cup' page 11.

We hope you have many enjoyable coffee experiences with the Sunbeam Café Espresso® II.

# Features of your Sunbeam Café Espresso® II

## **Warming plate**

Allows up to 9 espresso cups to be warmed before use.

## **Group / Brewing head**

## **Group handle**

## **Water level indicator**

The water level indicator floats through the drip tray indicating how full the drip tray is. The top of the indicator has a red band for easy identification.

## **Non-slip rubber feet**

Makes the unit sturdy, preventing it from slipping or scratching the bench top.

## **Tamp**

## **Measuring spoon**

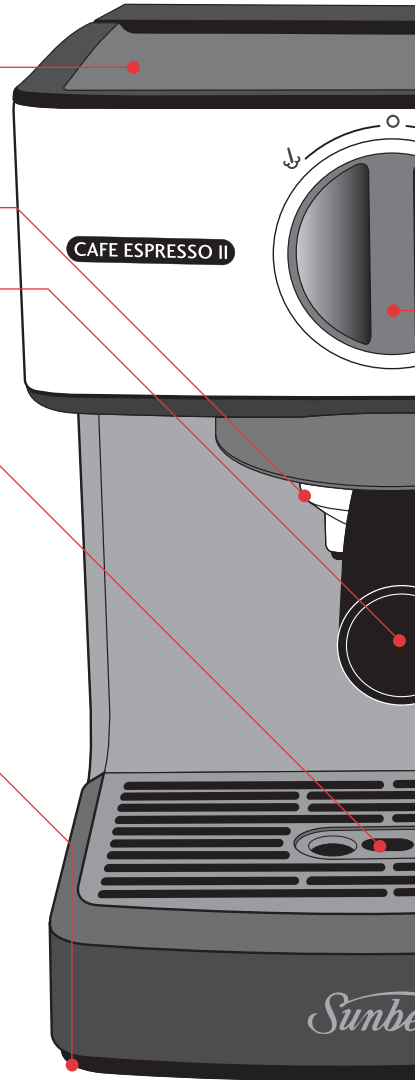
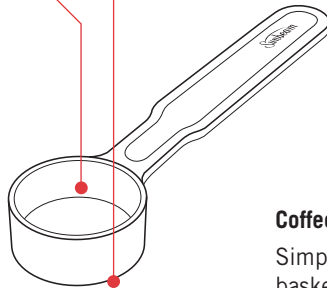

## **Coffee Pod Compatible - Espresso Made Easy**

Simply insert the single coffee pod basket into an empty group handle and place the coffee pod inside. Ensure that no part of the coffee pod filter overhangs the lip of the filter basket, as this will allow water to leak during the coffee making process.

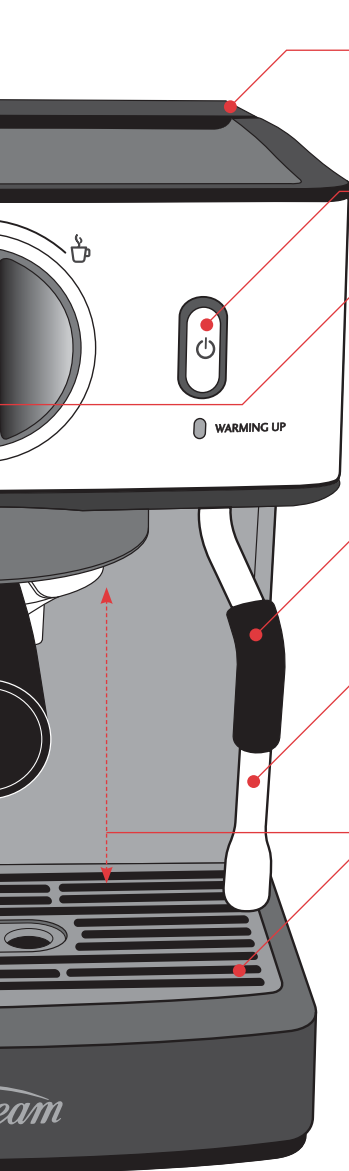

**1.7L removable water reservoir**

The large water reservoir is removable for easy filling. Simply lift and remove in any direction.

**Power button**

**Operating dial**

Easy to operate selector dial - turn to the right to make espresso (☕) or to the left for steam (⬇️).

**Silicone cover**

Allows you to move the steam wand into the desired position without burning your fingers.

**Steam wand**

**Extra cup height clearance**

Additional clearance between the coffee handle and the drip tray – designed to suit taller cups.

**Removable drip tray and grill**

Designed with no dirt traps for small coffee granules, milk or any other spills. You can simply wipe clean all surfaces. The drip tray and grill can be completely removed for easy cleaning.

**500ml jug**

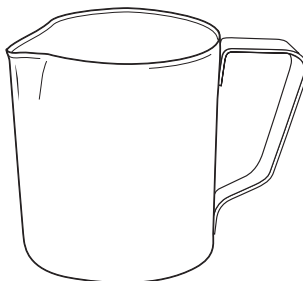

1 cup filter

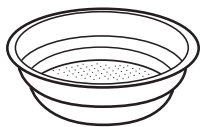

2 cup filter

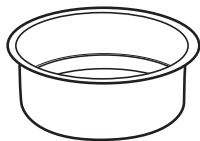

# Features of your Sunbeam Café Espresso® II

## 15 BAR pump

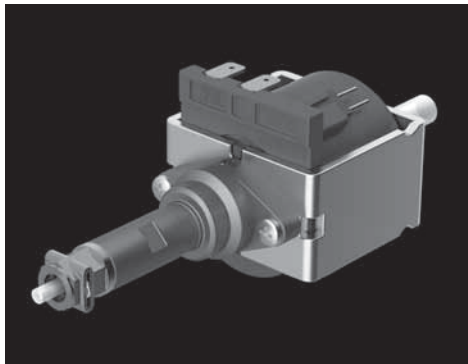

The Café Espresso® II is fitted with a 15 BAR pump delivering the pressure required for complete extraction of oils, coffee solids and aroma.

## Crema System



The dual-wall filter creates additional back pressure and stabilising baffle produces a steady pour and maintains the temperature of the espresso.

## Thermoblock heating system

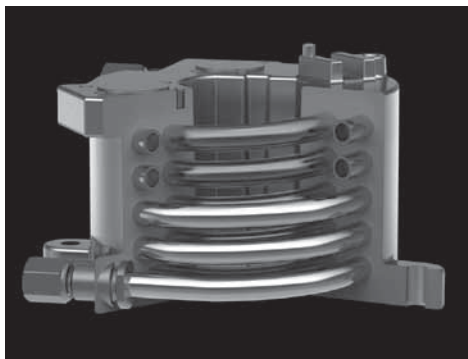

As espresso is made with hot rather than boiling water and the thermoblock heats the water to 92°C (just below boiling point) for optimum extraction of oils from the coffee grinds.



# Operations Guide for your Café Espresso® II

The diagrams below and on the following pages are to assist you in using your Sunbeam Café Espresso® II. Each of the diagrams is numbered. Throughout this instruction manual these numbers will be referred to.

**For example:** Fill the water reservoir (1) (2) (3) (4) (5) with cold tap water...

Each time you see these numbers please refer back to the diagrams at the front of the instruction manual.

## Filling the water reservoir

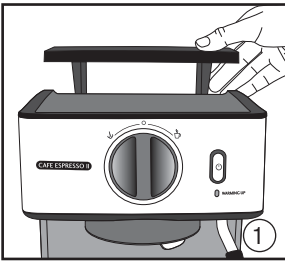

Open lid of water reservoir.

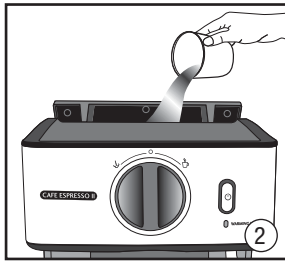

Fill in place with cold water,  
OR

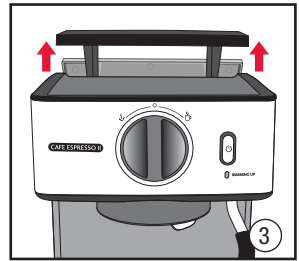

Remove water reservoir.

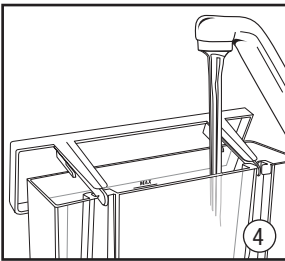

Fill at sink with cold water.

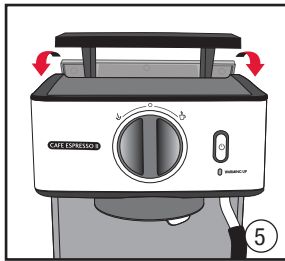

Replace the water reservoir.

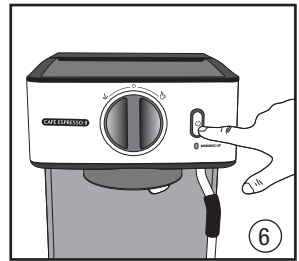

Press 'power' button to  
turn machine on.

## Preparing the espresso machine

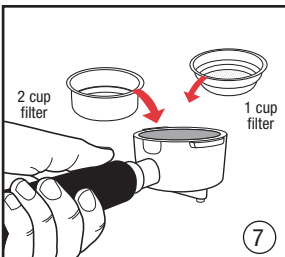

Select filter.

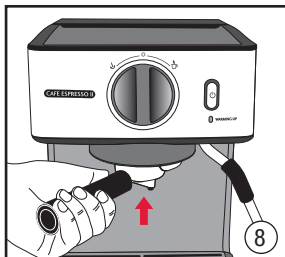

Place filter handle onto  
brewing head.

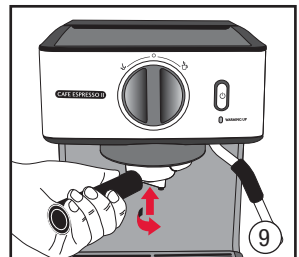

Turn filter handle to the  
right as far as it will go.

# Operations Guide for your Café Espresso® II (continued)

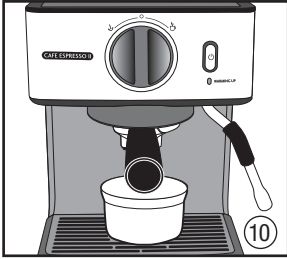

Place container under the group handle pouring spouts.

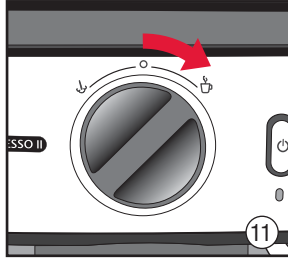

Turn operating dial to the espresso setting and allow water to run through.

## Making an Espresso

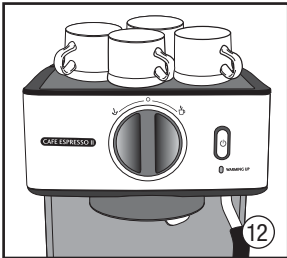

Warming espresso cups.

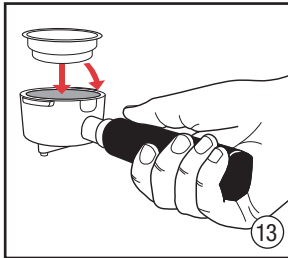

Select appropriate filter and place into handle.

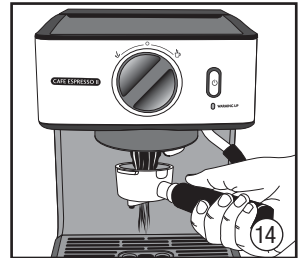

Hold filter handle and purge with water to preheat.

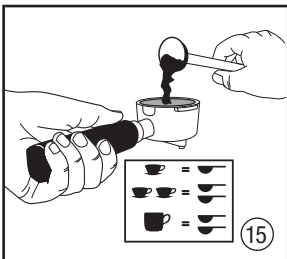

Place coffee in filter.

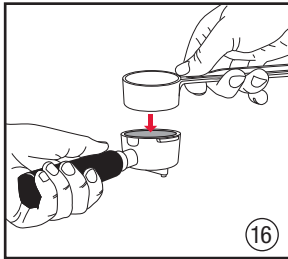

Tamp the coffee.

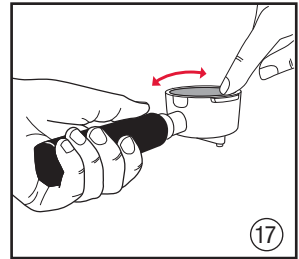

Wipe the edge of filter to remove any coffee grinds.

# Operations Guide for your Café Espresso® II (continued)

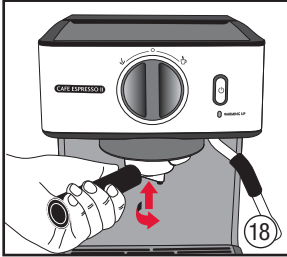

Place filter handle onto brewing head and turn handle to the right, as far as it will go.

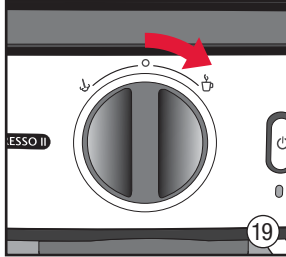

Turn the dial to the right to make an espresso ☕. Turn back to the off '0' position when finished.

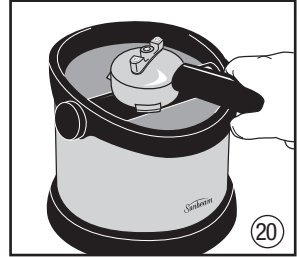

Discard the used coffee grinds.

## Texturing milk

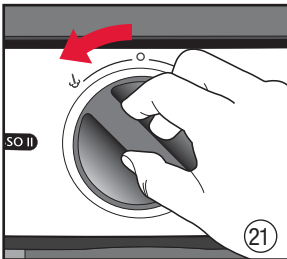

Purge the steam wand by turning dial to the steam setting.

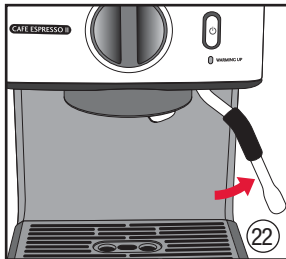

Swing steam wand to the side of espresso machine

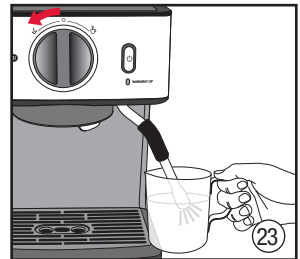

Place steam wand into milk, approx. 1cm below surface and turn the dial to the steam setting.

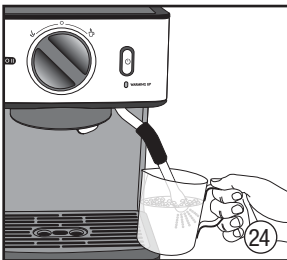

Angle jug to rest steam wand on spout and place nozzle just below surface of the milk.

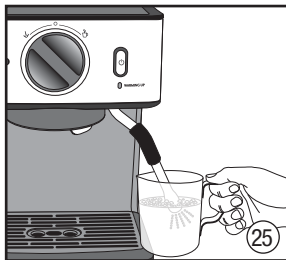

Raise the jug until nozzle is in the centre of milk.

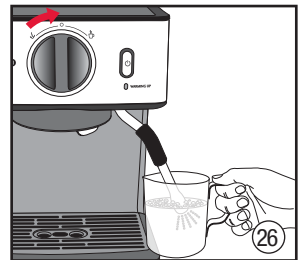

Close the steam by turning dial back to the off '0' position.

### Care and cleaning

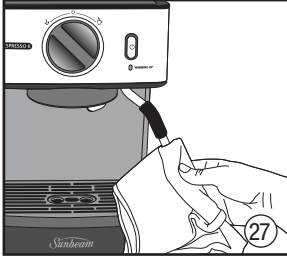

Wipe steam nozzle and wand with damp cloth and purge a small amount of steam.

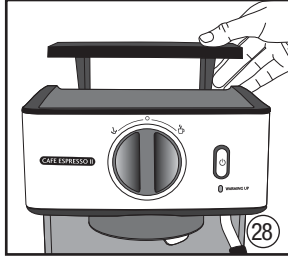

Flip open the lid of the water reservoir and the cleaning pin is located on the inside of the lid.

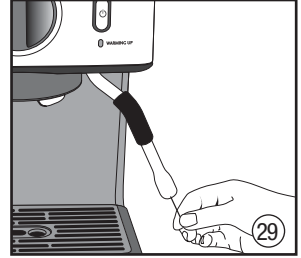

Insert the larger wire into the hole in the base of the steam wand.

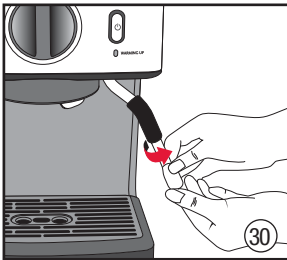

Remove steam nozzle from steam wand.

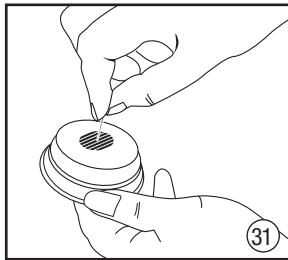

Insert the smaller cleaning wire into the single hole in the base of the filter.

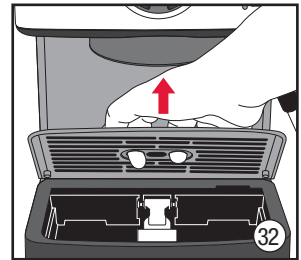

Remove the drip tray grid.

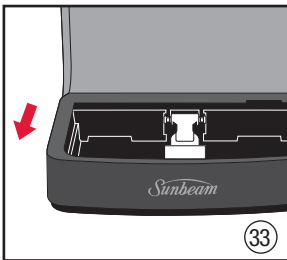

Remove the drip tray, pull tray outward and toward you.

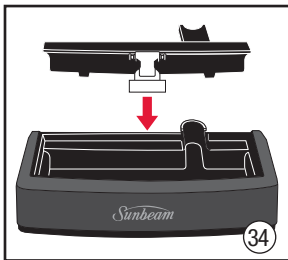

Ensure plastic lining is clipped back into position in the drip tray.

# Secrets to the perfect cup

With a Sunbeam pump espresso machine and a little experience, you can create café-quality coffee at home. Here are a few helpful suggestions:

- The origin of the bean and roasting will affect the taste of the espresso, so test different brands and blends of coffee to find the one you like best.
- The grind of the coffee is critical. Vary the degree of grinding to find the right fineness for the coffee beans being used.
- A regular shot of espresso, the base of all cafe coffees, is approximately 30mls. The shot of espresso is a concentrate, so you will need to vary the quantity of milk and additional hot water to determine the strength and volume of the coffee. If you are using a large cup or mug you may require a double shot of espresso, rather than just a single shot depending on your taste.
- Ensure your coffee grinds are 'tamped' evenly. 'Tamping' refers to the amount of pressure with which coffee grinds are packed into the filter.
- If your espresso pours too slowly, tamp the coffee grind more lightly, or try a coarser grind.
- If your espresso is thin and watery, tamp the coffee grinds harder, or try a finer grind.
- Always use cold milk and a clean stainless steel jug when texturing milk.
- Always use the freshest beans or ground coffee available and store in an airtight container in a cool, dry, dark place.
- Whole coffee beans stay fresh longer than pre-ground coffee.
- When grinding your own coffee, never grind more than you will use for immediate use. Once ground, the coffee will begin to lose its goodness.
- Pre-warm cups prior to making an espresso, either by filling with hot water or placing on the warming plate.
- Once prepared, serve coffee immediately.
- Keep your espresso machine clean and thoroughly rinsed. Run water through the brewing head and flush the steaming nozzle in fresh water after each use.

# Easy steps for texturing milk

Milk texturing is the steaming of milk to heat it and to create froth. Similar to making an espresso, perfecting the art of milk texturing takes time and practice.

- Use fresh, cold milk and fill a stainless steel frothing jug to no more than  $\frac{1}{3}$  full.
- The amount of milk you steam should be adequate for the coffees you are preparing. Keep in mind that the volume of milk will increase or 'stretch' during the texturing process.
- Once you have activated the steam and inserted the steam nozzle into the jug, position the steam wand  $1\frac{1}{2}$  cm from the side of the jug with the tip of the nozzle just below the surface of the milk. The jug needs to be at a slight angle with the steam wand resting on the spout of the jug. This will create a whirlwind motion in the milk.

**Note:** You should hear a hissing sound. If you are creating large bubbles, raise the jug so that the nozzle tip is lowered deeper into the milk.

- As the steam heats the milk, the milk will begin to rise. Follow the level of the milk by lowering the jug, always keeping the tip of the steam nozzle just below the surface.
- Once the milk has stretched to double its original volume, lower the steam nozzle further into the milk and continue to heat the milk. This will give the milk a fine texture and not a mass of large aerated bubbles.
- Cease steaming when the frothing jug becomes too hot to hold your hand against it.
- With the frothing jug in hand, swirl and tap the jug until the milk becomes shiny and no bubbles remain, this ensures an even consistency. Pour the textured milk into your espresso as soon as possible.

## Important cleaning instructions for the steam wand/arm

The steam wand needs to be cleaned each time you froth milk. To clean the steam wand, wipe with a damp cloth and rinse the froth enhancing attachment under warm water.

Should your steam wand become blocked, supplied with your espresso machine is a cleaning wire, located on the underside of the lid to the water reservoir (28).

Insert the larger wire on the cleaning pin into the base of the steam wand (29).

If the steam wand remains blocked, unscrew the steam nozzle from the steam arm. Clean the steam nozzle by once again using the cleaning wire and then flush under running water.

# Before using your Café Espresso® II

Before using your Sunbeam Café Espresso® II for the first time or if you have not used it for some time, rinse the machine by running water through without coffee in the group handle, as follows:

**Note:** Throughout these instructions the numbers you see highlighted and in brackets refer back to the diagrams at the start of this instruction manual.

- Open the lid of the water reservoir **(1)** and fill with cold water **(2)**. Alternatively you can open the lid and remove the water reservoir using both hands **(3)**. Then fill with cold water **(4)**.
- Replace the water reservoir firmly into the unit **(5)** and close lid.
- Insert the power plug into a 230-240V AC power outlet and turn the power **(⏻)** on. Start the unit **(6)**. The red power **(⏻)** light will illuminate and flash to indicate it is warming up.
- Place one of the filters in the group handle **(7)**. Then position the group handle on the machines brewing head **(8)**.

- To ensure that the group handle is in the correct position, turn the handle so it points to the left and place the group handle flat against the brewing head **(8)**, then turn the handle towards the right **(9)**, as far as it can go.

**Note:** Do not over tighten.

- Place a sufficiently large container under the group handle pouring spouts **(10)**.
- When the power button has stopped flashing and is completely illuminated, the machine is ready for the next step.
- Turn the dial to the espresso **(☺)** setting **(11)** and allow all the water in the water reservoir to run through.
- If necessary, you may need to stop the operation by turning the dial to the off **(○)** position, empty the container, then resume the operation.

**Note:** Make sure that the water reservoir is clean and free of any debris, as any fine particles can block the water flow.

# Functions of your Café Espresso® II

## 1. ESPRESSO FUNCTION

For best results, it is ideal to pre-heat your cups, filter handle and filter as follows:

- Insert the power plug into a 230-240V AC power outlet and turn the power on.
- Fill the water reservoir **(1) (2), (3) (4) (5)** with cold water and start the appliance **(6)**.
- Put the group handle and an empty filter in place **(7) (8) (9)**, and place a container underneath the group handle to capture water.
- Turn the dial to the espresso (☞) setting **(11)**.
- Let water run through the group handle for 10 seconds and return the dial to the off (○) position.

**Note:** Once the appliance has been on for a while, the coffee cups can be warmed by placing them upside down on the cup warming plate **(12)**.

### Preparing an espresso:

- Insert the power plug into a 230-240V AC power outlet and turn the power on.
- Fill the water reservoir **(1) (2), (3) (4) (5)** with cold water and start the appliance **(6)**.
- Pre-heat your group handle by holding the group handle under the brewing head and purging with water **(14)**.
- Pre-heat your coffee cups by placing them upside down on the cup warming plate **(12)**.
- Select the required filter **(7)** for 1 or 2 cups of coffee and place in the group handle.
- Using the measuring spoon supplied, place one or two measures of ground coffee into the filter **(15)**. With the other end of the measuring spoon, use the tamp to push (pack) down the coffee grinds **(16)**.

**Important:** Be sure not to over-fill the filter with too much coffee, and wipe around the edge of the filter to remove any coffee grinds **(17)**.

- Place the group handle in the machines brewing head. Position the handle so it points to the left, place the group handle flat against the brewing head, then turn the handle towards the right **(18)** as far as it can go.

**Note:** Do not over tighten.

- Place 1 or 2 pre-heated cups below the pouring spouts.
- Turn the operating dial to the espresso (☞) setting **(19)**. You will hear the machine making a pumping noise, this is normal.
- Once the cup/s are filled to the desired level, turn the operating dial to the off (○) position.
- Remove the group handle and the filter by turning the group handle to the left.
- To remove the used coffee grinds from the filter, simply turn the group handle upside down in a bin and gently tap out the coffee **(20)**.





- After each use of the espresso machine for best results when making consecutive cups of espresso we recommend that you flush a small amount of water through the machine with the group handle already removed from the brewing head. Simply turn the operating dial to the espresso setting and allow the water to run through until you have a consistent flow of water. This will wash out any old or used coffee grinds stuck to the underside of the brewing head and also help ensure the correct water temperature for your next shot of espresso.

**Note:** Do not leave the filter handle locked in position for extended periods, or when machine is not in use. This shortens the life of the brew head rubber seal.

## 2. STEAM FUNCTION

The steam function can be used for texturing/frothing milk.

**Important:** There is a risk of scalding when the steam nozzle is in use. Hot water or hot steam can cause scalding. Only use the steam wand when it is immersed in the milk.

- Fill the water reservoir **(1) (2) (3) (4) (5)** with cold water and start the unit **(6)**.
- Position the steam wand so that the tip is over the drip tray.
- Turn the dial to the steam () position **(21)**. Some water will come out of the steam wand. Once steam starts to come out turn the dial to the off () position **(26)**.
- Swing the steam nozzle to the side of the machine **(22)**.
- Pour cold milk into a stainless steel jug to no more than  $\frac{1}{3}$  full.

**Tip:** For best results we recommend using refrigerated milk and a stainless steel jug that is well chilled. Be sure not to rinse the jug with warm water before use.

- Hold the jug under the steam wand so that the nozzle opening is completely immersed in the milk. Turn the operating dial to the () setting to activate the steam and commence texturing the milk **(23)**.

**Tip:** For instructions on how to froth/texture milk refer to section 'Easy steps for texturing milk'.

- Angle jug so the steam wand is resting on the spout of the jug and position the tip of the steam wand just below the surface of the milk **(24)**.

**Note:** The nozzle must not touch the bottom of the jug to ensure that the steam release is not obstructed.

- Move the jug so that the steam wand is in the centre, this will create a whirlpool motion to the milk. As the steam heats the milk, the milk will begin to rise. Follow the level of the milk by lowering the jug, always keeping the tip of the steam nozzle just below the surface **(25)**.
- When milk is at temperature close the steam by turning the dial back to the off () position **(26)**.

**Note:** Do not boil the milk.

### **Cleaning the steam wand**

You must clean the steam wand immediately after each use. Simply wipe the stainless steel steam wand clean with a damp cloth. Also, briefly turn the operating dial to steam (☺) setting to clear any remaining milk out of the steam wand (27).

**Caution:** Steam from the wand/arm is extremely hot and there is danger of scalding.

**Note:** Should your steam wand/arm become blocked, supplied with your espresso machine is a cleaning wire. The cleaning wire is located on the underside of the lid to the water reservoir (28). With the cleaning wire insert it into the hole in the base of the steam wand (29). Should the steam wand/arm remain blocked, unscrew the steam nozzle from the steam arm (30) clean the steam nozzle by once again using the cleaning wire and flush under running water.

# Care and Cleaning

The coffee making process involves extracting oils out of coffee grinds to make espresso coffee. Deposits of these oils build up over time and affect the taste of the coffee and operation of the espresso machine.

Regular cleaning to remove these oils is essential for espresso machines to keep operating effectively. Flushing water, through the brewing head and the steam wand, is the easiest way to keep your machine clean after making each coffee, and at the end of your coffee making session.

**Important:** Never wash your espresso machine accessories in the dishwasher.

## Drip tray

Remove the grid and drip tray at regular intervals to empty **(32)**, **(33)**. If the red floating level indicator appears through the grid, empty the drip tray immediately.

Clean the drip tray and its grid with water and a little non-abrasive washing up liquid, rinse and dry.

Over time it is normal for the inside of the drip tray to be stained by the oils in the coffee.

**Note:** Ensure that when you are replacing the drip tray that the plastic lining is in position **(34)**.

## The brewing head, filters & group handle

The filter and group handle should be washed after each use by rinsing them under warm water. Wash at regular intervals in warm soapy water using a mild detergent.

To clean the brewing head, flush water through and wipe the head and around the inside rim with a damp cloth.

To assist in keeping the filter and the brew head clean, at the end of each coffee making session we recommend you run the machine, with the filter in place, without coffee – using water only.

Should the holes in the filters become clogged with coffee granules use a fine bristled brush to remove them.

**Important:** Should the filter remain blocked after normal cleaning, supplied with your espresso machine is a cleaning wire. The cleaning wire for the filter is located on the underside of the lid to the water reservoir **(28)** with the cleaning wire insert it into the single hole in the base of the filter **(31)**.

## Care and Cleaning (continued)

### Brew head rubber seal

This seal is located in the brewing head and creates a seal against the filter handle when making an espresso.

**Note:** When your Sunbeam Café Espresso® II is not being used, we recommend that you do not leave the filter handle attached to the machine as this will reduce the life of the seal.

Over time this seal loses its elasticity and will require replacement – usually every 6-12 months. Signs that the seal is deteriorating are when: the filter handle rotates to the far right and feels loose, or steam escapes from around the brewing head during use.

### The cup warming plate and exterior

Wipe over the unit with a damp cloth and wipe dry. Do not use abrasives or metal scourers, as these will scratch the exterior surface.

### Steam wand

The steam wand needs to be cleaned each time you texture milk or heat any other liquid. To clean the steam wand, wipe with a damp cloth and for the froth attachment, simply rinse it under warm water.

**Note:** After each use we recommend that a small amount of steam is purged from the steam wand.

On a monthly basis we recommend thoroughly cleaning the steam wand.

To do this soak the wand/arm in water with the stainless jug resting on the drip tray. Ensure that the water level in the jug is over the wand. Run steam through the wand for 30 seconds, then leave to soak overnight.

In the morning turn the machine on and run steam through the wand again for 30 seconds.

**Important:** Do not wash parts in the dishwasher. Do not immerse the unit in water.

**Important:** Should your steam wand become blocked, supplied with your espresso machine is a cleaning wire.

The cleaning wire for the steam wand is located on the underside of the lid to the water reservoir **(28)**.

With the cleaning wire insert it into the hole in the base of the steam wand **(29)**.

Should the steam wand remain blocked unscrew the steam nozzle from the steam arm **(30)**. Clean the steam nozzle by once again using cleaning wire and then flush under running water.

# Descaling

After continued use, your espresso machine may develop a build-up of mineral deposits. Thus your machine will require occasional 'descaling'.

We recommend that you descale your machine every 2-3 months, although this period will depend on the hardness of water and frequency of use of the machine.

## Descaling solution

Use Sunbeam Liquid Descaler, which is available at any Sunbeam Service Centre listed at [www.sunbeam.com.au](http://www.sunbeam.com.au). Alternatively, dissolve 3 tablespoons of vinegar in two litres of lukewarm water.

## Descaling the espresso machine

**Note:** Ensure that the espresso machine is turned off and the power cord is unplugged.

1. Remove the water reservoir from the machine and if necessary empty any water.
  2. Remove the drip tray and place it out of the way.
  3. Remove the group handle from the machine and rinse it thoroughly under running water and set aside.
  4. Place a cloth/tea towel on the bench and carefully turn the machine upside down. The machine should now be on the warming plate resting on the cloth/tea towel.
  5. Using a screwdriver, unscrew the shower screen from the brewing head.
  6. Remove the shower screen from the centre hold using the tip of a fork or skewer. Wash the shower screen in hot soapy water, rinse and dry well. Set aside in a safe place with the screw and the blue rubber seal.
  7. Using a small brush, scrub in and around the area of the brewing head, removing all coffee granules.
  8. Wipe down the steam wand with a small brush.
- Note:** Follow the steps on page 16 'Cleaning the steam wand' for a more thorough cleaning procedure.
9. Turn the machine upright, so that it is now sitting correctly on the bench.
  10. Fill the water reservoir with water to the 'MAX' line and add 1 capful of Sunbeam Liquid Descaler or, alternatively fill the water reservoir with the vinegar solution. Place the water reservoir onto the espresso machine.
  11. Place a large container under the brewing head and another container under the steam wand.
  12. Insert the power plug into a 230-240V AC power outlet and turn the power 'On'.
  13. When the power button is completely illuminated, turn the dial to the espresso setting. Run through about  $\frac{1}{3}$  of the liquid immediately and return the dial to the off (O) position.
  14. Turn the dial around to the steam (☺) position and move the steam wand over the drip tray.
  15. Allow the solution to come through the steam wand for 1 minutes.

## Descaling (continued)

16. After 1 minute, stop the machine by turning the operating dial to the off (○) position.
  17. Leave the machine off for 10-15 minutes to allow the descaler to take effect.
  18. Turn the dial to the espresso (☞) setting and allow ½ of the rest of the descaler solution to run through the brewing head.
  19. Turn the dial to the steam (☝) position. Place the steam wand over the drip tray.
  20. Allow the hot water to run through the wand for 2 minutes. Return the dial to the off (○) position.
  21. Turn the dial to the espresso (☞) setting and allow the remaining solution in the water reservoir to run through the brewing head.
  22. Remove the water reservoir from the machine and rinse thoroughly under running water, ensuring that all traces of the descaling solution is removed. Fill the water reservoir with clean water and place onto the machine.
  23. Run two (2) full water reservoirs through the brewing head. Refill the water reservoir and run the steam nozzle for 4-5 minutes.
- Note:** Ensure that you continue to run water through the machine until the water runs clean and clear.
24. When this is finished, remove the water reservoir and set aside. Remove the water containers and give the machine a good wipe over.
  25. Turn the machine upside down. The machine should now be on the warming plate resting on the cloth/tea towel once again.
- Important:** The brewing head will be hot from the descaling process. Allow this to cool down before replacing any parts.
26. Carefully replace the rubber seal, filter, washer and screw. Tighten well.
  27. Turn the machine upright, so that it is now sitting correctly on the bench.
  28. Replace the drip tray.
  29. Fill the water reservoir with water and position it on to the machine.

# Trouble Shooting guide

PROBLEM	POSSIBLE CAUSE	WHAT TO DO
<b>Coffee runs down the side of the group handle.</b>	Group handle is not attached correctly, or has not been tightened sufficiently.	Ensure the handle is firmly positioned onto the brewing head. See “Preparing an espresso” pg 14.
	Edge of filter insert is not free of coffee granules.	Clean around the top edge of the filter and wipe the brewing head clean of coffee.
	The brewing head is dirty.	Wipe brewing head with a damp cloth.
	The brewing head is defective.	Contact a Sunbeam Service Centre.
	Brew head rubber seal is damaged, or worn.	Contact a Sunbeam Service Centre.
<b>No coffee runs through.</b>	No water in the water reservoir.	Fill reservoir with water.
	Water reservoir not correctly assembled.	Press firmly down on the water reservoir to ensure it is correctly positioned.
	Brewing filter may be blocked.	See “Descaling the espresso machine” pg 19.
	The filter is blocked, the coffee grounds are too fine or tamped down too hard.	Empty out the filter and rinse under water to clean. Wipe the brewing head with a cloth. Repack the filter and tamp down coffee lightly with compactor.
<b>Coffee pours out in drops.</b>	Coffee grounds are too fine or are too compacted.	Ensure you are using an evenly ground coffee and do not compact the grounds so firmly.
	Machine blocked by scale build up.	See “Descaling the espresso machine” pg 19 .
<b>Espresso does not have any Crema.</b>	Coffee is old or dry.	Use fresh coffee and once you open the coffee be sure to store it in an airtight container.
	Coffee not compacted firmly enough.	Compact coffee grounds more firmly.
	Coffee too coarse.	Grind the coffee to a finer texture or change brands of espresso coffee to a finer grind.

## Trouble Shooting guide (continued)

<b>Espresso does not have any Crema.</b>	Not enough coffee in filter.	See "Preparing an espresso" p14.
<b>Handle comes off during brewing.</b>	Coffee tamped too hard.	Tamp the coffee grounds lighter.
	Coffee grind is too fine.	Change to a coarser grind of coffee.
	Filter handle is not attached correctly, or has not been tightened sufficiently.	Ensure the handle is firmly positioned onto the brewing head. See "Preparing an espresso" pg14.
	Top edge of filter is not free of coffee granules.	Clean around the edge of the filter and wipe the brewing head clean of coffee.
	The brewing head is dirty.	Wipe brewing head with a damp cloth.
	The brewing head is defective.	Contact a Sunbeam Service Centre.
	Brew head rubber seal is worn or damaged.	Contact a Sunbeam Service Centre.
<b>Coffee is too cold.</b>	Cups, filter and filter hand are cold.	Pre-heat cups, filter, handle and filter. See "Functions of your Cafe Espresso II" page 14.
	If making a cappuccino or latte the milk may not be heated enough.	Ensure that milk is heated properly during texturing, but be sure not to boil the milk. See "Easy steps for texturing milk" pg 12.
<b>No steam from the steam nozzle.</b>	Steam nozzle is blocked.	See "Care & Cleaning" pg17.
<b>Not enough froth when texturing</b>	Milk is not fresh.	Ensure the milk is fresh.
	Milk temperature is too warm.	Ensure that the milk is well refrigerated before use.
	Texturing jug.	For best texturing results use a stainless steel jug and if possible refrigerate or run the jug under cold water before use.
	Steam nozzle is blocked.	See "Care & Cleaning" pg17.
	Milk has been boiled.	Start again with fresh, chilled milk.
	The milk is making bubbles rather than frothing.	Ensure that the froth attachment is correctly positioned on the steam nozzle. The tip of the steam nozzle or frothing attachment should be positioned just below the surface of the milk.



## Trouble Shooting guide (continued)

<b>Uneven cup filling.</b>	Uneven tamping or obstruction in the pouring spouts.	Ensure coffee is tamped evenly and check that there is nothing obstructing the pouring spouts.
	Defective baffle in filter handle.	Contact a Sunbeam Service Centre.
<b>Espresso tastes burnt.</b>	Type of coffee being use.	Experiment with different brands of coffee.
	Appliance has not been rinsed after descaling.	Run a reservoir full of water properly through the machine before making another coffee.
<b>Pump makes an unusually loud noise.</b>	No water in reservoir.	Fill the water reservoir.
	Water reservoir not correctly positioned.	Replace the water reservoir firmly into the unit.
<b>Machine does not operate.</b>	Brewing filter may be blocked.	Remove filter holder and clean brewing head. See "Care & Cleaning" pg17.
	Machine blocked by scale build up.	See "Descaling the espresso machine" pg 19.

Please contact Sunbeam directly on 1300 881 861, if this guide does not solve your query. We have experienced staff on hand to assist, Monday to Friday.

# Recipes

## ESPRESSO (SHORT BLACK)

Espresso is a concentrated, full bodied coffee with a stable layer of cream on top – known as ‘crema’. An espresso is the foundation of all café coffee. Variations are achieved by adding different amounts of milk and froth.

- 90mL espresso glass or demitasse cup
- single espresso (30-35mL)



## MACCHIATO

Macchiato, Italian for ‘to stain or mark’. Traditionally served as a standard espresso with a dash of milk and a small dollop of froth into the middle of the ‘crema’.

- 90mL espresso glass or demitasse cup
- single or double espresso
- marked with steamed milk froth



## LONG BLACK

A standard espresso with hot water, served in a regular coffee cup or mug. The hot water is added first so that the ‘crema’ is maintained.

- 190mL cup
- hot water (to taste)
- single or double espresso



## FLAT WHITE

Another old favourite, the Flat White is an espresso with steamed milk, served in a regular coffee cup or mug. The layer of frothed milk on top should be 2mm to seal the coffee.

- 190mL cup
- single or double espresso
- steamed milk



## Recipes (continued)

### CAFFE LATTE

An espresso with steamed milk, typically served in a glass. The layer of frothed milk on top should be 10mm to seal the coffee.

- 220mL glass or cup
- single or double espresso
- steamed milk



### CAFFE MOCHA

Made in a similar way to a cappuccino but with the addition of drinking chocolate. Simply stir the chocolate into the espresso prior to adding the steamed milk and froth.

- 190-240mL cup or tall glass
- single or double espresso
- two teaspoons of drinking chocolate
- two-thirds milky coffee, one-third froth



### CAPPUCCINO

This delicious drink is an espresso with steamed milk, topped with creamy froth and a dusting of chocolate. The resulting drink is approximately two-thirds milky coffee, one-third froth.

- 190-240mL cup
- single or double espresso
- two-thirds milky coffee, one-third froth
- dusted with chocolate



### CON PANNA

A variation on the original Vienna coffee, this delicious drink is made up of an espresso topped with lightly whipped cream. It can also be dusted with cinnamon or drinking chocolate.

- 190mL cup
- single or double espresso
- lightly whipped cream
- dusted with cinnamon or chocolate



# Notes

# Notes

# Notes

# 12 Month Replacement Guarantee

In the unlikely event that this appliance develops any malfunction within 12 months of purchase (3 months commercial use) due to faulty materials or manufacture, we will replace it for you free of charge.

Should you experience any difficulties with your appliance, please phone our customer service line for advice on 1300 881 861 in Australia, or 0800 786 232 in New Zealand. Alternatively, you can send a written claim to Sunbeam at the address listed below. On receipt of your claim, Sunbeam will seek to resolve your difficulties or, if the appliance is defective, advise you on how to obtain a replacement or refund.

Your Sunbeam 12 Month Replacement Guarantee naturally does not cover misuse or negligent handling and normal wear and tear.

Similarly your 12 Month Replacement Guarantee does not cover freight or any other costs incurred in making a claim. Please retain your receipt as proof of purchase.

The benefits given to you by this guarantee are in addition to your other rights and remedies under any laws which relate to the appliance.

Our goods come with guarantees that cannot be excluded under the Australian Consumer Law and under the New Zealand Consumer Guarantees Act.

In Australia you are entitled to a replacement or refund for a major failure and for compensation for any other reasonably foreseeable loss or damage. You are also entitled to have the goods repaired or replaced if the goods fail to be of acceptable quality and the failure does not amount to a major failure.

Should your appliance require repair or service after the guarantee period, contact your nearest Sunbeam service centre.

For a complete list of Sunbeam's authorised service centres visit our website or call:

## Australia

[www.sunbeam.com.au](http://www.sunbeam.com.au)

**1300 881 861**

Units 5 & 6, 13 Lord Street  
Botany NSW 2019 Australia

## New Zealand

[www.sunbeam.co.nz](http://www.sunbeam.co.nz)

**0800 786 232**

26 Vestey Drive, Mt Wellington  
Auckland, New Zealand

## Need help with your appliance?

Contact our customer service team or visit our website for information and tips on getting the most from your appliance.

### In Australia

Visit [www.sunbeam.com.au](http://www.sunbeam.com.au)

Or call 1300 881 861

### In New Zealand

Visit [www.sunbeam.co.nz](http://www.sunbeam.co.nz)

Or call 0800 786 232

 is a registered trademark.

'Café Espresso' is a registered trademark of Sunbeam Corporation.

Made in China.

Due to minor changes in design or otherwise, the product may differ from the one shown in this leaflet.

© Copyright. Sunbeam Corporation Limited 2013.

ABN 45 000 006 771

Units 5 & 6, 13 Lord Street  
Botany NSW 2019 Australia

Unit 3, Building D  
26 Vestey Drive  
Mt Wellington Auckland  
New Zealand

Sunbeam Corporation is a division of GUD Holdings Ltd.



Free Manuals Download Website

<http://myh66.com>

<http://usermanuals.us>

<http://www.somanuals.com>

<http://www.4manuals.cc>

<http://www.manual-lib.com>

<http://www.404manual.com>

<http://www.luxmanual.com>

<http://aubethermostatmanual.com>

Golf course search by state

<http://golfingnear.com>

Email search by domain

<http://emailbydomain.com>

Auto manuals search

<http://auto.somanuals.com>

TV manuals search

<http://tv.somanuals.com>