

Sunbeam

MultiProcessor™ Range

Instruction Booklet

LC6250 Sunbeam MultiProcessor™ – Food processor

LC6950 Sunbeam MultiProcessor™ Plus – 3 in 1 Processor, blender and citrus juicer (Pictured below)

Please read these instructions carefully
and retain for future reference.



Contents

Sunbeam's Safety Precautions	3
Features of your Sunbeam MultiProcessor	4
Features of your Sunbeam MultiProcessor Plus	6
Attachments for your Sunbeam MultiProcessor	8
Using your Sunbeam MultiProcessor	10
Fitting/using the tools on your MultiProcessor	12
Storing your Sunbeam MultiProcessor	16
Handy hints for in-bowl processing	18
A guide to your food processor	20
Handy blending tips	22
A guide to your blender	23
Care and cleaning	24
Recipes	25
Drink recipes (LC6950 only)	38

Important instructions – retain for future use.

تأكد من تفهم احتياطات السلامة المذكورة اعلاه

請務必理解上述的安全預防措施。

Assurez-vous que les précautions ci-dessus relatives à la sécurité sont bien comprises

Versichern Sie sich, dass die obenstehenden Sicherheitsmaßnahmen Verstanden werden

Βεβαιώνετε πως οι παραπάνω προφυλάξεις ασφαλείας γίνονται κατανοητές

Pastikan bahwa tindakan-tindakan keselamatan seperti di atas dimengerti anda

Accertatevi che le suddette norme di sicurezza siano comprese a dovere

上記の注意事項をよくお読みになり、安全を御確認ください

Уверете се дека погоре споменатите мерки на претпазливост се добро разбрани

Asegúrese de que las precauciones de seguridad precedentes sean bien comprendidas

کاری یکنید کہ احتیاطهای بالا حتماً درك بشوند

ต้องแน่ใจว่า ข้อควรระวังเรื่องความปลอดภัยข้างต้น เป็นที่เข้าใจกันดี

Yukarda belirtilen güvenlik önlemlerinin anlaşılığından emin olunuz

Xin kiểm chắc rằng những biện pháp làm an toàn kể trên được hiểu rõ

Sunbeam's Safety Precautions

SAFETY PRECAUTIONS FOR YOUR SUNBEAM FOOD PROCESSOR.

- Always use extreme care when handling processing blades and cutting discs. These are extremely sharp and may cause injury if handled incorrectly. Always store processing blades and cutting discs in their respective covers or processing containers.
- Unplug from power outlet before cleaning.
- Switch off the appliance and disconnect from supply before changing accessories or approaching parts that move in use.
- Always fit the safety cover before using the food processor.
- Do not put hot liquids into the food processor bowl or blender. Cool to room temperature before blending or processing.
- Avoid contacting moving parts at all times.
- Place the processor bowl onto the base of the processor before fitting any attachments.
- All blades and attachments should be removed with care before cleaning.
- Do not over fill the processor.
- Always remove the blade before emptying the processor bowl of its contents.
- When mixing a heavy load, ie. a '1.5kg dough' do not operate food processor for more than 45 seconds at a time. This does not apply for any of the recipes detailed in this booklet.

Sunbeam is very safety conscious when designing and manufacturing consumer products, but it is essential that the product user also exercise care when using an electrical appliance. Listed below are precautions which are essential for the safe use of an electrical appliance:

- Read carefully and save all the instructions provided with an appliance.
- Always turn the power off at the power outlet before you insert or remove a plug. Remove by grasping the plug - do not pull on the cord.
- Turn the power off and remove the plug when the appliance is not in use and before cleaning.
- Do not use your appliance with an extension cord unless this cord has been checked and tested by a qualified technician or service person.
- Always use your appliance from a power outlet of the voltage (A.C. only) marked on the appliance.
- This appliance is not intended for use by persons (including children) with reduced physical, sensory or mental capabilities, or lack of experience and knowledge, unless they have been given supervision or instruction concerning use of the appliance by a person responsible for their safety.
- Children should be supervised to ensure that they do not play with the appliance.
- The temperature of accessible surfaces may be high when the appliance is operating.
- Never leave an appliance unattended while in use.
- Do not use an appliance for any purpose other than its intended use.
- Do not place an appliance on or near a hot gas flame, electric element or on a heated oven.
- Do not place on top of any other appliance.
- Do not let the power cord of an appliance hang over the edge of a table or bench top or touch any hot surface.
- Do not operate any electrical appliance with a damaged cord or after the appliance has been damaged in any manner. If damage is suspected, return the appliance to the nearest Sunbeam Appointed Service Centre for examination, repair or adjustment.
- For additional protection, Sunbeam recommend the use of a residual current device (RCD) with a tripping current not exceeding 30mA in the electrical circuit supplying power to your appliances.
- Do not immerse the appliance in water or any other liquid unless recommended.
- Appliances are not intended to be operated by means of an external timer or separate remote control system.
- This appliance is intended to be used in household and similar applications such as: staff kitchen areas in shops, offices and other working environments; farm houses; by clients in hotels, motels and other residential type environments; bed and breakfast type environments.

If you have any concerns regarding the performance and use of your appliance, please visit www.sunbeam.com.au or contact the Sunbeam Consumer Service Line. Ensure the above safety precautions are understood.

Features of your Sunbeam MultiProcessor

Processing bowl cover

The processing bowl cover activates the automatic safety system. The MultiProcessor will not operate unless the cover is correctly positioned on the processing bowl and locked into place.

850w motor base

The base houses a powerful 850 watt motor, which provides great processing results every time.

Pulse button

Increases the intensity of the standard processing action to assist in the most demanding tasks.

Variable speed control

The large speed control dial with 5 clearly marked speeds makes it easy to select the desired setting.

Blade storage compartment

Enables attachments to be stored conveniently when not in use.

Non-slip feet

Keeps the food processor secure on the bench top during use.

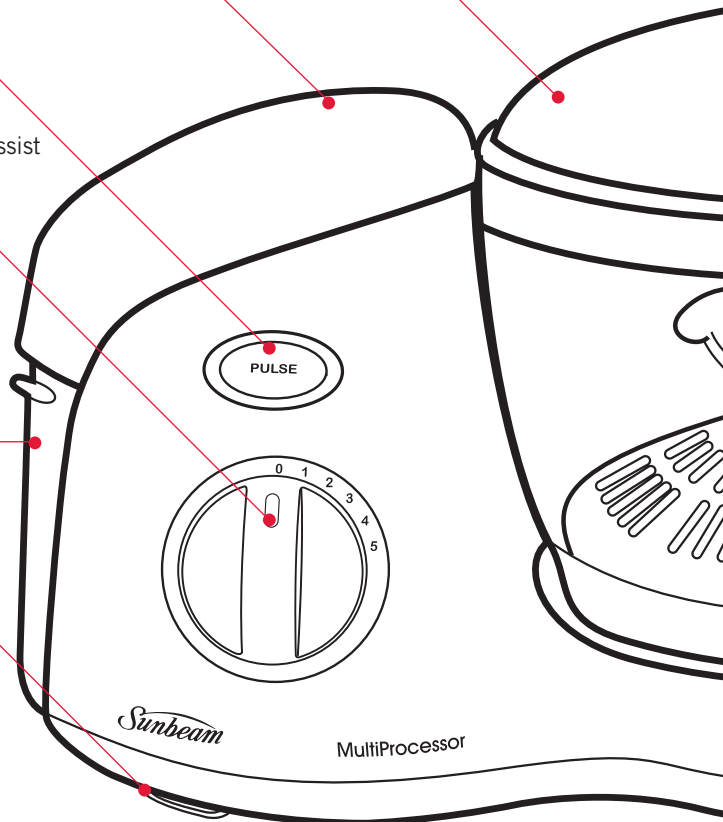

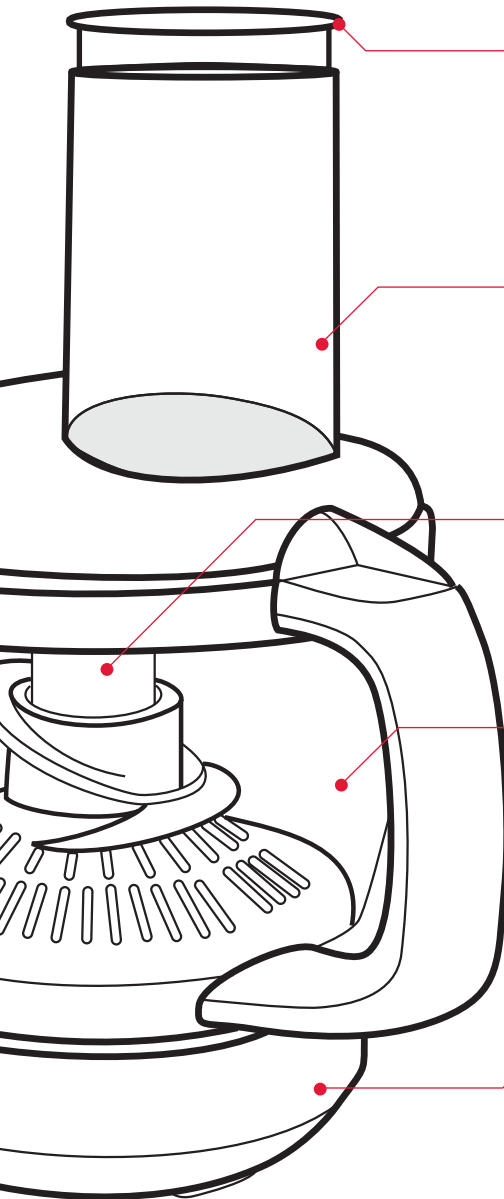

Food pusher

Guides food evenly down the feed tube and can also be used to close the chute while processing to prevent food from escaping through the feed tube.

Feed tube

The feed tube is used to guide ingredients down into the selected blades and allows you to add ingredients during other processing tasks.

Spindle

Drives all the food processing attachments. The spindle must be in place to operate the food processor.

Processing bowl

Capacity is 1.75 litres for liquids and 1.5 kilograms for solids. The bowl locks into place on the motor base and is designed to encourage even, efficient processing.

Cord storage facility

For tidy, convenient storage of the cord on the backside of the motor base.

Features of your Sunbeam MultiProcessor Plus

Blender cover with lid pouring hole

The blender lid securely seals the jug and features a lid pouring hole that allows you to add ingredients during blending.

1.5 litre shatter proof blender jug

The sizeable 1.5 litre jug features an easy grip handle and is marked in both cups and millilitres (ml) for ease of use.

The blender jug locks onto the motor base of the food processor and will not operate unless the jug is in the locked position.

Serrated stainless steel blades

These durable, serrated stainless steel blades are strong enough to crush ice cubes and are ideal for pureeing, blending and mixing. The blade assembly is detachable for easy and thorough cleaning.

Pulse button

Increases the intensity of the standard processing action to assist in the most demanding tasks.

Blade storage compartment

Enables attachments to be stored conveniently when not in use.

Variable speed control

The large speed control dial with 10 clearly marked speeds makes it easy to select the desired setting.

Non-slip feet

Keeps the food processor secure on the bench top during use.

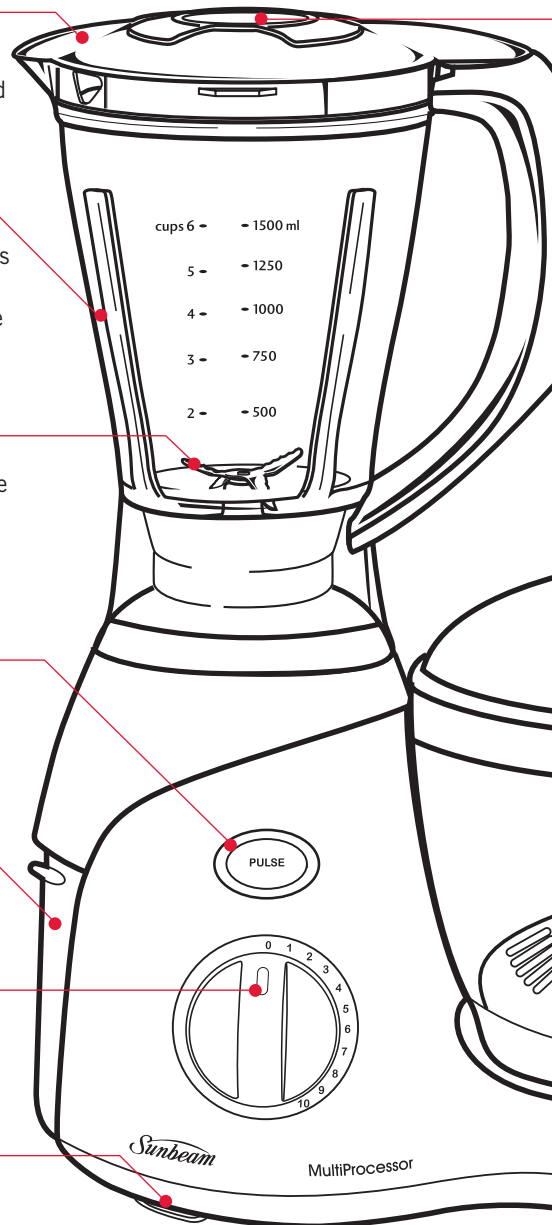

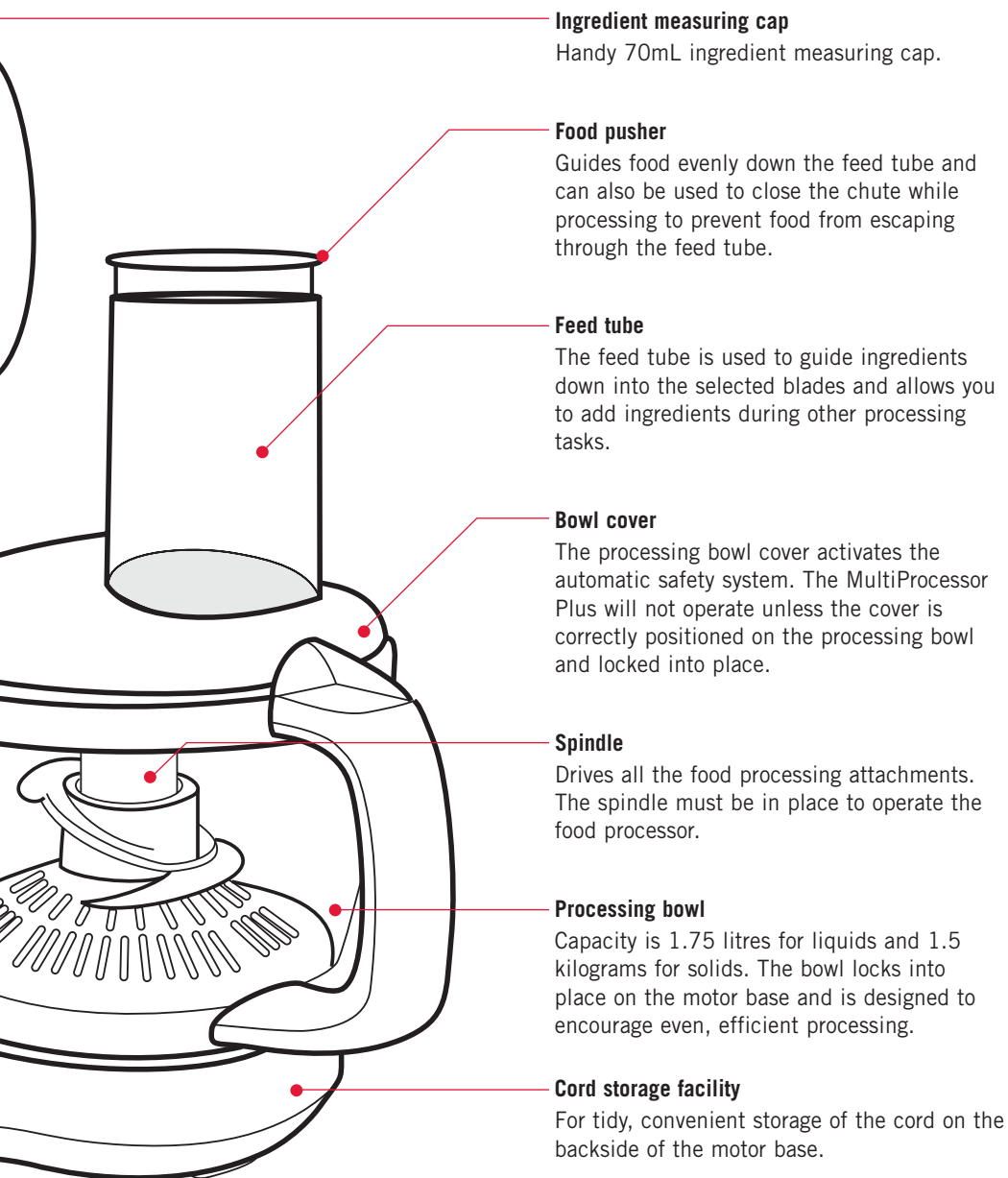

Ingredient measuring cap

Handy 70mL ingredient measuring cap.

Food pusher

Guides food evenly down the feed tube and can also be used to close the chute while processing to prevent food from escaping through the feed tube.

Feed tube

The feed tube is used to guide ingredients down into the selected blades and allows you to add ingredients during other processing tasks.

Bowl cover

The processing bowl cover activates the automatic safety system. The MultiProcessor Plus will not operate unless the cover is correctly positioned on the processing bowl and locked into place.

Spindle

Drives all the food processing attachments. The spindle must be in place to operate the food processor.

Processing bowl

Capacity is 1.75 litres for liquids and 1.5 kilograms for solids. The bowl locks into place on the motor base and is designed to encourage even, efficient processing.

Cord storage facility

For tidy, convenient storage of the cord on the backside of the motor base.

Attachments for your Sunbeam MultiProcessor

1. Processing blade

The stainless steel processing blade is contoured to fit the shape of the processing bowl to provide the most efficient chopping/mixing action.

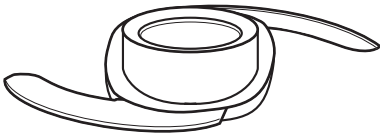

Please ensure that the processing blade protective cover is placed on the processing blade when not in use.

The processing blade can be used to chop raw meats to mince, chocolate to crumbs and nuts to paste.

2. Dough blade

The dough blade is contoured for fast, efficient processing. It is ideal for mixing doughs, heavy cake mixes and batters.

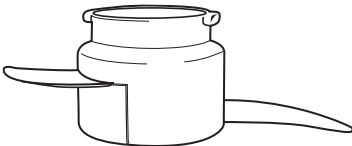

3. Blade holding disc

The blade holding disc houses the various processing attachments – slicing, chipping, grating and shredding.

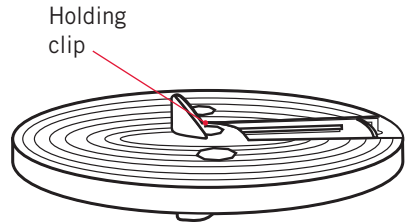

4. Slicing blades - Thick and Thin

The thick slicing blade is ideal for slicing a variety of fruits and vegetables.

The thin slicing blade is ideal for slicing of fruits, vegetables, raw meats, chicken and deli meats like salami.

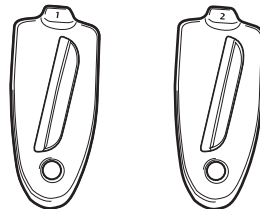

5. Chipping blade

The chipping blade is ideal for making potato chips and vegetable strips.



Attachments for your Sunbeam MultiProcessor continued

6. Grating blade

The grating blade is ideal for grating hard cheeses, especially parmesan.



7. Shredding blades - Coarse and Fine

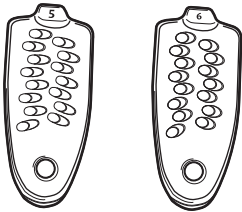

The coarse shredding blade is ideal for a variety of fruits and vegetables.

The fine shredding blade is ideal for chocolate, ginger and garlic and a variety of fruits and vegetables.

8. Whisk attachment

The whisk attachment is ideal for whisking egg whites, creams, light batters and packet cake mixtures.

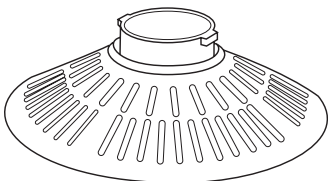

9. Safety cover

This attachment is only available with the MultiProcessor Plus (LC6950).

When the blender is not in use, it is recommended that the blender is removed from the food processor body and the safety cover is locked in place. The MultiProcessor Plus will not operate unless the safety cover or blender jug is locked in place.

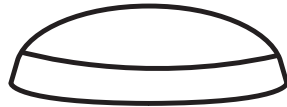

10. Citrus Juicer

This attachment is only available with the MultiProcessor Plus (LC6950).

The citrus juicer sits inside the processing bowl (without the spindle) to filter pips and pulp pieces during juicing.

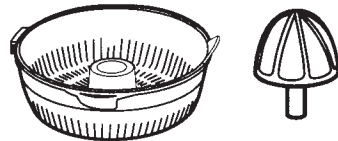

The citrus juicer attachment enables you to juice all types of citrus fruits from limes and lemons to oranges and grapefruit.

11. Spatula

The spatula is ideal for assisting with all food processing tasks.

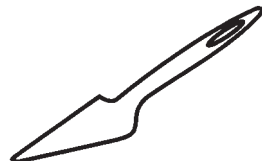

Using your Sunbeam MultiProcessor

Before using your MultiProcessor

- Wash the processing bowl, cover and all attachments in warm water using a mild detergent. Dry each part thoroughly before use.
- Before you assemble the food processor, ensure that the power cord is unplugged.

Before using the processing bowl

- The following steps are only necessary for the MultiProcessor Plus (LC6950).
1. Place the motor base facing you on a dry, level surface.
 2. Fit the safety cover onto the food processor body and twist anti-clockwise, see Figure 1

LC6950
Pictured

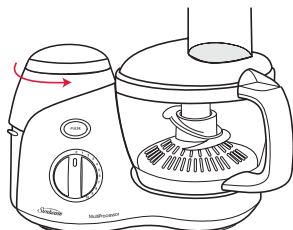

Fig 1

Note: The MultiProcessor Plus processing bowl will not operate if the safety cover or blender jug are not in place.

Positioning the processing bowl and cover

The following steps are for both models LC6250 and LC6950.

1. Place the motor base facing you on a dry, level surface.

2. Position the processing bowl over the drive shaft. The handle of the bowl needs to be facing you (marked "Locate handle") and the bowl should now be resting on the base of the food processor, see Figure 2.

LC6250
Pictured

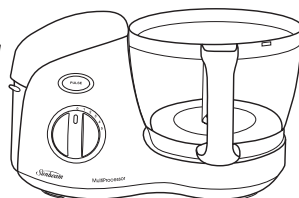

Fig 2

3. To lock the bowl into position for use, turn the handle to the right, as far as it will go, see Figure 3.

LC6250
Pictured

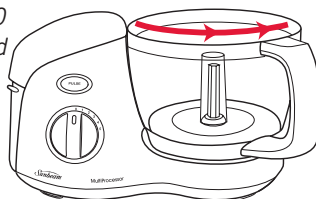

Fig 3

4. Place the processor bowl cover onto the processing bowl, by aligning the icon ▲ marked on the handle with the icon ▼ on the bowl cover. Then rotate lid to lock, see Figures 4 and 5.

UNLOCKED

LC6250
Pictured

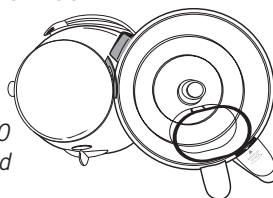

Fig 4

Using your Sunbeam MultiProcessor continued

The holding lip should be flush with the top of the bowl handle.

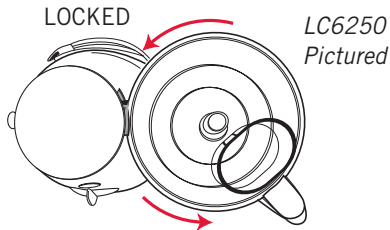

Fig 5

Important: If the processing bowl and cover are not correctly assembled, the MultiProcessor will not function.

Using your MultiProcessor

1. Plug the power cord into a 230-240V AC power outlet and turn the power 'ON'.
2. Using the control dial, select the desired processing speed.

The Pulse function remains on as long as the Pulse button is pressed down.

The variable speed settings will provide continuous processing until the control dial is returned to the '0' position.

Further ingredients can also be added whilst processing by pouring through the feed tube once the food pusher has been removed.

3. After you have completed processing, turn the control dial to the '0' position.

Note: For maximum control when using your food processor, load the feed tube before turning on your food processor. Always use the food pusher for more evenly processed foods and never use your fingers.

Important: When mixing a heavy load, ie. '1.5kg Dough' do not operate food processor for more than 1 minute at a time.

Fitting/using the tools on your MultiProcessor

Note: All attachments must be firmly attached to the spindle. Always adjust the attachments until you are sure that they are correctly fitted.

Placing the spindle

1. Fit the spindle onto the drive shaft, see Figure 6.

LC6250
Pictured

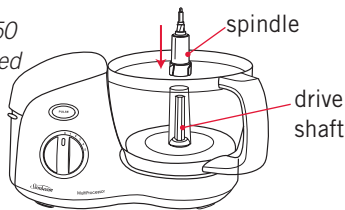

Fig 6

Processing Blade

1. Fit the processor bowl and spindle as detailed previously in Figures 2, 3 & 6.
2. Remove the protective cover from the stainless steel processing blade, see Figure 7.

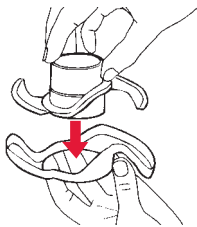

Fig 7

3. Fit the processing blade over the spindle and press firmly into place, see Figure 8.

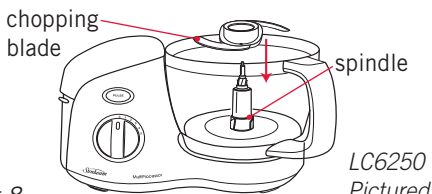

Fig 8

LC6250
Pictured

Warning: Use extreme caution as blades are sharp. Always handle the chopping blade by its central plastic section.

4. Place food into the processing bowl.
5. Fit the processing bowl cover to the processing bowl, see Figures 4 & 5 and place the food pusher in the feed tube.
6. Plug the power cord into a 230-240V AC power outlet and turn the power 'ON'.
7. Select the required speed.
8. When processing is complete, remove the spindle and blade from the processing bowl before removing the processed food.

Note: After cleaning, always replace the protective cover on the stainless steel processing blade.

Dough Blade

1. Fit the processor bowl and spindle as detailed previously, in Figures 2, 3 & 6.
2. Fit the dough blade over the spindle and press firmly into place, see Figure 9.

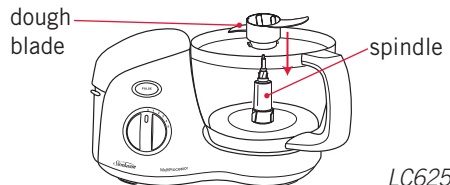

Fig 9

LC6250
Pictured

3. Place ingredients into the processing bowl.
4. Fit the processing bowl cover to the processing bowl, see Figures 4 & 5 and place the food pusher in the feed tube.
5. Plug the power cord into a 230-240V AC power outlet and turn the power 'ON'.
6. Select required speed.
7. When processing is complete, remove the spindle and blade from the processing bowl before removing the dough.

Fitting/using the tools on your MultiProcessor continued

Note: For added safety we recommend that you always leave the food pusher in place whilst operating the processor.

Whisk Attachment

1. Fit the processor bowl and spindle as detailed previously in Figures 2, 3 & 6.
2. Fit the whisk attachment over the spindle and press firmly into place, see Figure 10.

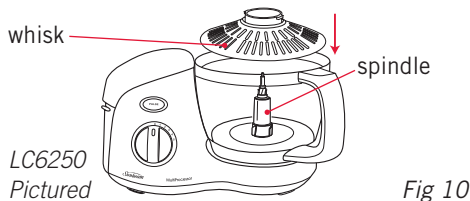

Fig 10

3. Add ingredients into the processing bowl.
4. Fit the processing bowl cover to the processing bowl in Figures 4 & 5 and place the food pusher in the feed tube.
5. Plug the power cord into a 230-240V AC power outlet and turn the power 'ON'.
6. Select the required speed.
7. When processing is complete, remove the spindle and whisk from the processing bowl before removing the processed food.

Slicing, Chipping, Grating and Shredding Blades

1. Place the blade of your choice into the blade holding disc. Hold the blade by the holding clip and insert the other end into the blade holding disc. Press down on the end of the blade with the holding clip until the blade is sitting flat in the blade holding disc, see Figures 11 & 12.

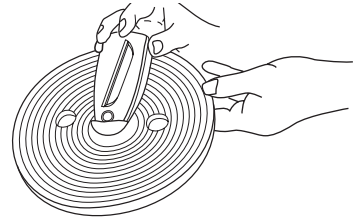

Fig 11

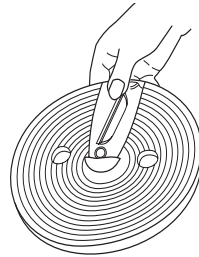

Fig 12

2. Fit the processor bowl and spindle as detailed previously in Figures 2, 3 & 6.
3. Fit the blade holding disc over the spindle and press firmly into place, see Figure 13.

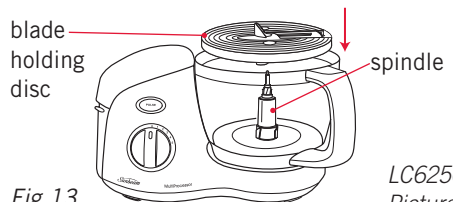

Fig 13

Warning: Use extreme caution as the blades are sharp.

4. Fit the processing bowl cover to the processing bowl in Figures 4 & 5 and place the food pusher in the feed tube.

Fitting/using the tools on your MultiProcessor continued

5. Plug the power cord into a 230-240V AC power outlet and turn the power 'ON'.
6. Select the required speed.
7. When processing is complete, remove the blade holding disc and spindle from the processing bowl before removing the processed food.

Citrus Juicer

Note: This attachment is only available with the MultiProcessor Plus (LC6950).

1. Fit the processor bowl as detailed previously in Figures 2 & 3.
2. Fit the citrus juicer bowl into the food processing bowl, see Figure 14.

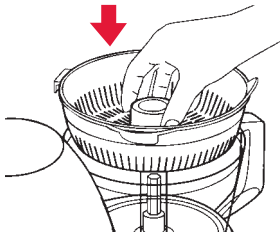

Fig 14

3. Rotate anti-clockwise, ensuring that the citrus juicer bowl tab has locked into place, see Figure 15.

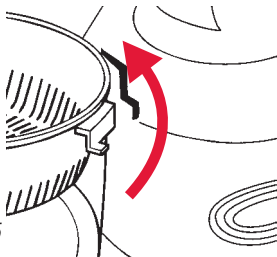

Fig 15

4. Insert the juicing cone into the centre of the citrus juicer bowl; the drive shaft should be inside the central column of the bowl, see Figure 16.

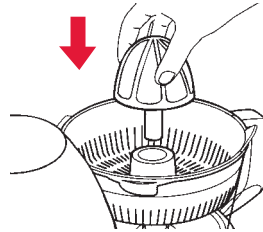

Fig 16

5. Plug the power cord into a 230-240V AC power outlet and turn the power 'ON'.
6. Place fruit on citrus cone and hold with a cupped hand and turn speed control to speed 1.

Note: Always operate the juicer at minimum speed only.

Blender

Note: This feature is only available with the MultiProcessor Plus (LC6950).

1. Remove the safety cover from the food processor body. Simply twist the safety cover clockwise and remove, see Figure 17.

LC6950
Pictured

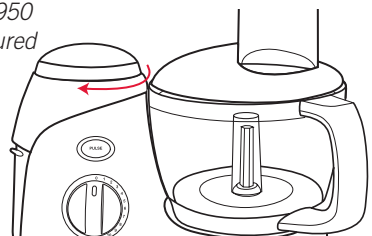

Fig 17

Fitting/using the tools on your MultiProcessor continued

2. Position the blender onto the processor body above the speed control dial with the handle to the left where marked "Locate handle". see Figure 18.

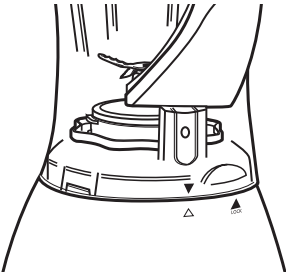

Fig 18

3. To lock the blender into place, simply hold the handle of the jug and turn it to the right as far as it will go. The assembly indicator light will be on if positioned correctly and locked in place, see Figure 19.

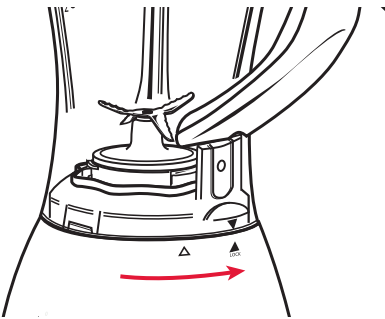

Fig 19

4. Place ingredients into the jug.

Note: Do not exceed the maximum indicated level – 1.5 litres.

5. Position the lid onto the blender jug so that the long holding lip is facing towards you, see Figure 20.

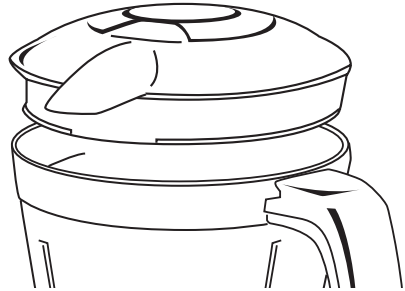

Fig 20

6. Turn the holding lip to the right, the holding lip should be flush with the top of the jug handle, see Figure 21.



Fig 21

7. Fit the processor bowl and cover as detailed previously in Figures 2, 3, 4 & 5.

- Note:** The blender will not operate if the processor lid is not correctly locked in place.
8. Plug the power cord into a 230-240V AC power outlet and turn the power 'ON'.
 9. Select the required blending speed 1-10 or PULSE.

Tip: Further ingredients can be added whilst blending by pouring through the lid hole once the measuring cup has been removed.

Storing your Sunbeam MultiProcessor

The Sunbeam MultiProcessor was designed so that all attachments can be stored within the unit itself, see Figure 22.



Fig 22

LC6250
Pictured

Blade storage compartment

1. Your MultiProcessor is accessorised with 6 blades. Each of these blades are illustrated and numbered above the blade storage compartment, see Figure 23.

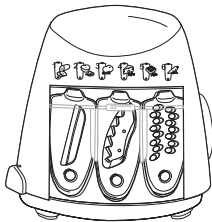

Fig 23

2. Pull down the blade storage door, see Figure 24.

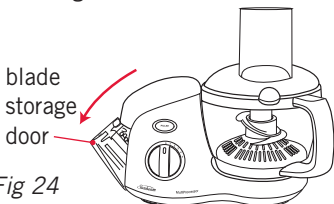

Fig 24

3. Each of the blades is numbered 1 through 6 and corresponds with the numbered illustrations on the unit, see Figure 25.

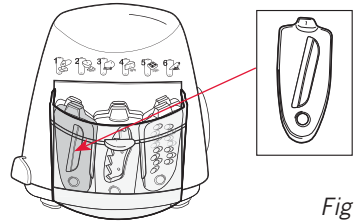

Fig 26

Blade 1 is the 'Thin Slicing' blade and its position in the blade storage compartment is the far left front position, see Figure 26.

4. Blade 2 is the 'Thick Slicing' blade and is positioned directly behind the thin slicing blade.

5. Blade 3 is the 'Chipping' blade and its position in the blade storage compartment is the middle front position, see Figure 27.

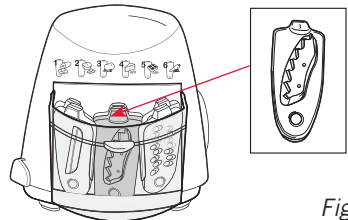

Fig 27

6. Blade 4 is the 'Grating' blade and is positioned directly behind the chipping blade.

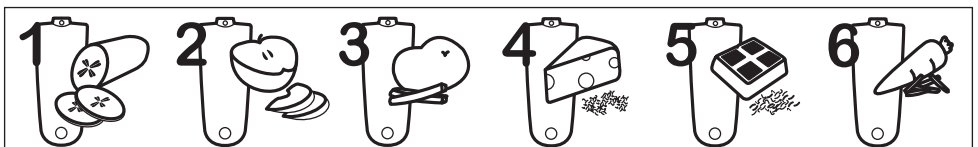

Fig 25

Storing your Sunbeam MultiProcessor continued

7. Blade 5 is the 'Fine Shredding' blade and its position in the blade storage compartment is the far right front position, see Figure 28.

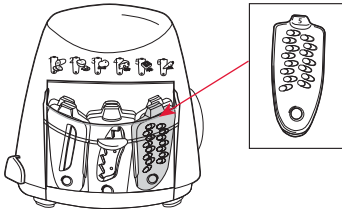

Fig 28

8. Blade 6 is the 'Coarse Shredding' blade and is positioned directly behind the fine shredding blade.

Processing bowl storage, see Figure 29.

1. Place the processing bowl onto the base of the food processor.
2. Fit the spindle over the drive shaft.
3. Fit the whisk attachment over the spindle.
4. Take the processing blade with cover and place over the spindle. The processing blade should be sitting with the blade cover resting on top of the whisk attachment.

Warning: Use extreme caution as blades are sharp. Always handle the chopping blade by its central plastic section.

5. Fit the dough blade over the spindle. The dough blade has a narrow opening on one end and a larger opening on the other. Place the dough blade with the narrow end resting on the top of the chopping blade.

6. Place the blade holding disc over the spindle and then fit the processing bowl cover to the processing bowl.

LC6250
Pictured

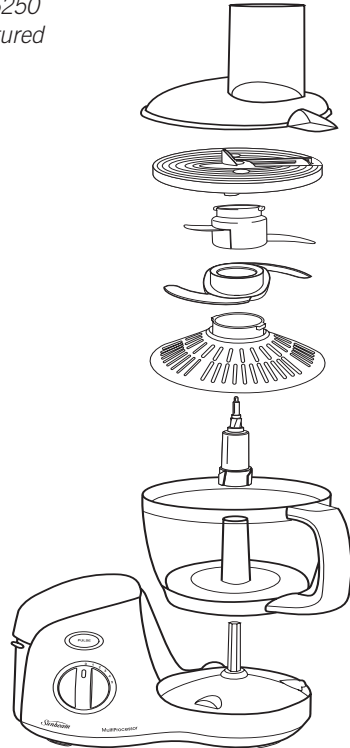

Fig 29

Cord storage

The power cord can be stored by wrapping it around the two clips on the back of the motor base, see Figure 30.

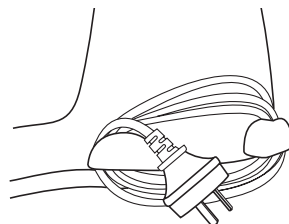

Fig 30

Handy hints for In Bowl Processing

Chopping

For the best, most consistent results, you should try to process pieces of food that are approximately equal in size. When you break, cut or tear food into uniform pieces before you begin processing, the finished results will be more uniform.

More consistent processing results are achieved if the container is not overloaded.

Mincing

Pre-cut meat into cubes approximately 2cm square.

Vegetables

When processing vegetables such as onions, peel and quarter or cut large vegetables into eighths.

Mixing

The quantities that can be processed within the processing bowl will vary with the density of the mixture.

Adding ingredients

When various recipes require dry ingredients such as flour, add them directly into the processing bowl before processing. There is no need to sift ingredients when using your MultiProcessor. Liquid ingredients may be added while the processor is operating by pouring through the feed tube in the processor cover.

Note: When processing sauces or semi-liquid ingredients, stop the food processor and scrape down the bowl sides with the spatula provided.

Using the Feed Tube

The most important factor for successful slicing and shredding is the way in which the food is packed into the feed tube.

Slicing, shredding and grating

Cut all ingredients to a size that fits comfortably into the feed tube. Pack the feed tube and, while holding food steady and upright with the food pusher, press down evenly until all ingredients are sliced or shredded. The more firmly you push, the thicker the slices or shreds. Do not use excessive force or you may damage the food processor.

Note: Never use fingers to push food down the feed tube. Always use the food pusher.

For best results when slicing

The feed tube should always be packed firmly to allow each piece of food to support the others. There will always be a small portion of food left unprocessed between the food pusher and the blade.

Preparing longer slices

Pack food items horizontally in the feed tube, see Figure 31.

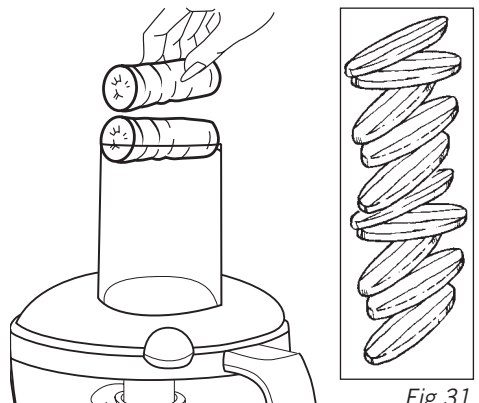

Handy hints for In Bowl Processing continued

Preparing shorter slices

Pack the food items vertically in the feed tube, see Figure 32.

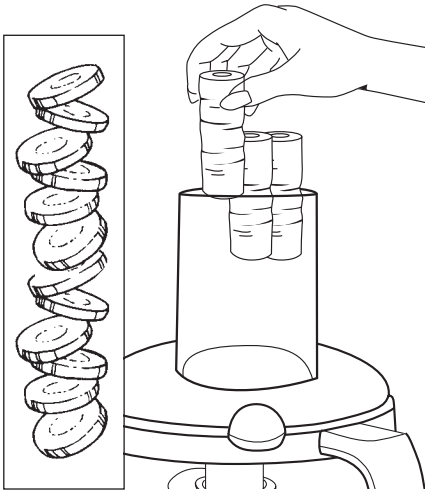

Fig 32

For best results when shredding and grating

Remember that softer foods such as cheese (cheddar, mozzarella or swiss) should be well chilled before processing. Harder foods such as parmesan or Romano cheese should be at room temperature before processing.

Note: When grating parmesan cheese do not apply a lot of pressure to the food pusher.

Disassembly







When processing is completed, remove the cover from the processing bowl first and then remove the processing bowl with the processing blade still in place.

To remove the processing bowl firstly unlock the processing bowl cover by rotating it in a clockwise direction until the cover is unlocked.





Note: Always wait for the processing blade to stop moving completely before removing the bowl cover.

Warning: Use extreme caution, as blades are sharp. Always handle the chopping blade by its central plastic section.

A guide to your food processor

Processing Task	Attachment	Food Product	Max. Qty.	Speed setting	Notes
Chopping		Vegetables – onions	800g	3	Ensure onions are peeled
		Fruits (fresh or dried)	800g	3	Pick fruit and vegetables that are fresh and firm
		A selection of fresh herbs	1 bunch	2	Wash herbs and dry thoroughly
		Nuts - i.e. whole peanuts/cashews/almonds	500g	5	Break into pieces before processing
		Chocolate – whole or buds	400g	4	
Mincing		Chicken fillets, fish fillets (boned), red meat & bacon rashers	500g	5	Trim excess fat off meat and ensure all bones are removed
Crumbing		Biscuits, bread and crackers	125g	3 or 4	Break large biscuits into smaller pieces before processing. Process in batches
Pureeing		Cooked vegetables	2 cups	1	May need to add water during processing
		Cooked fruits	up to 1.75L	1	
Mixing		Cake mixtures , batters, dips and flavoured butters	800ml	1-3	Start on speed 1 to combine ingredients, then slowly increase the speed for thorough mixing
Emulsifying		Mayonnaise, oil based dressings	1ltr	PULSE or 3	Keep processing while adding oil
Kneading		Bread, pasta, pizza doughs, shortcrust and scones	1.5kg	1-5	Start on speed 1 to combine ingredients, then use speed 5 for mixing

A guide to your food processor continued

Processing Task	Attachment	Food Product	Max. Qty.	Speed setting	Notes
Slicing (thick & thin)		Vegetables (cucumber, zucchini carrot, capsicum)	800g	1-2	Trim all vegetables and wash before processing
		<i>Use speed 1 for soft fruit and vegetables</i>			
		Fruits (apples tomatoes, limes)	800g	1-2	Pick fruits and vegetables that are the same size & thickness
<i>Use speed 2 for hard fruit and vegetables.</i>					
Chipping		Vegetables (carrot potato, parsnip sweet potato)	1kg	1-2	Wash and peel vegetables before processing
Grating		Parmesan cheese	500g	1-2	Cut cheeses to fit into the feed tube. Do not apply too much pressure onto the food pusher
Shredding (coarse & fine)		Chocolate (use block)	500g	1-2	Break block of chocolate into 2 or 3 pieces to fit into the feed tube, one piece at a time
		Fruits – i.e. apple	1kg		
		Vegetables – i.e. carrot	1kg		
Whisking		Cake mixture, egg whites, cream and light batters	1kg	4-5	Be careful not to over beat egg whites

Handy blending tips

Note: Only for the MultiProcessor Plus (LC6950).

- Nothing can beat a blender for making smooth purees and sauces or for whipping up frothy drinks - from healthy breakfast shakes to frozen daiquiris.
- Use your blender for chopping small amounts of food like nuts, bread crumbs and whole spices.
- Turn any oil-based salad dressing into a creamy style dressing by blending it until slightly thickened.
- A brief whirl in the blender will rescue a lumpy gravy, or an egg-based sauce that has separated.
- When crushing ice, add $\frac{1}{4}$ cup of water, as this will aid in the ice crushing process. Continue pulsing until the ice is completely crushed and it has a snow flake texture.
- Food items for blending should be cut into cubes (approximately 2-3cm), this will assist in an even result.
- Ensure the lid is firmly and securely placed on the jug. Do not operate the blender without the lid on, if you wish to add any additional ingredients remove the measuring cup and add as necessary.
- Never fill above the maximum level indicator.
- To ensure efficient mixing when blending dry mixtures, it may be necessary to stop the blender and push ingredients down the sides of the jug with a spatula.
- When pureeing fruits or vegetables, cooked or raw, cut into small pieces to facilitate blending.
- When making bread crumbs, use 2 to 3 day old bread, leaving crusts on to minimise the possibility of clumping. If only fresh bread is available, dry it out for a few minutes in a low oven.
- When blending a variety of ingredients together, blend the liquids first, then add dry ingredients.
- Always ensure stones are removed from fruits and bones from meat as these can harm the blades.
- Don't allow a used blender to sit for too long as the food will dry on the blades making it very difficult to clean. If you can't clean the blender straight away, pour some warm water in it and allow to soak.
- Do not process hot liquids in your blender. Allow to cool to room temperature before processing.
- Always ventilate the blender jug when pureeing warm ingredients. This is achieved by lifting the measuring cup out of the lid.

A guide to your blender

PROCESSING TASK	FOOD	SUGGESTED SETTING	SUGGESTED PROCEDURE
Aerating	Milkshakes, Smoothies	2	Use chilled milk. Blend until desired consistency is achieved.
Chopping	Nuts, Chocolate, Garlic or Herbs	PULSE	Process ½ cup at a time to ensure evenly sized pieces.
Crumbing	Bread Crumbs	PULSE & 2	Tear bread roughly. Process until desired consistency.
	Biscuit Crumbs	2	Break into pieces and process until crumbed.
Crushing Ice		PULSE	Add ¼ cup of water. Use the button 3-4 times in succession for crushed ice.
Emulsifying	Salad Dressing	2	Blend until well combined. Oil may be added to the mixture during processing through the pouring hole in the lid.
Mixing	Batters, Cakes	1	Process ingredients until just combined. DO NOT OVERPROCESS.
Pureeing	Soups Vegetables Fruits	2	Blend until smooth.

Note: Times for processing will vary with the quantity in blender jug. These times are only a guide.

Care and cleaning

When you have finished processing, unplug your MultiProcessor from the power outlet. Wash all accessories, processor tools and all surfaces that have come into contact with food in hot soapy water except for the processor body. Clean the processor body by wiping with a damp cloth.

Warning: Care must be taken when handling the metal blades as these items are extremely sharp.

Note: Always unplug the MultiProcessor before cleaning.

Dishwasher use

All plastic components deteriorate through the prolonged use of a dishwasher for cleaning.

We recommend washing all parts of the MultiProcessor in hot soapy water except for the processor body

Cleaning your Blender

Note: Only for the MultiProcessor Plus (LC6950).

Quick cleaning method

Half fill the blender with warm water and a small amount of detergent. Press the PULSE button for a few seconds. Then remove the jug and rinse it under running water.

For thorough cleaning

Unscrew the blade system from the jug by turning anti-clockwise. Remove the silicone rubber seal from the blade assembly. Wash the lid, jug, silicone rubber seal and the blade assembly in warm soapy water.

Caution:

Take care when cleaning the blades, as they are extremely sharp.

Recipes

Carrot Cake

Serves 10

- 3 (375g) medium carrots
- 1 cup caster sugar
- ½ cup vegetable oil
- ¼ cup honey
- 2 eggs
- 1 orange, rind grated
- 1 ½ cups self-raising flour
- ½ teaspoon ground cinnamon
- ¾ cup walnuts pieces

1. Preheat oven to 180°C (160°C fan-forced). Grease and line a 21cm square or a 22cm round cake pan.
2. Using the processing bowl fitted with the blade holding disc (fitted with the coarse shredding blade), feed the carrots through the feed tube using the food pusher.
3. Once carrots are grated, remove the blade holding disk and transfer carrots to a large bowl.
4. Using the processing bowl fitted with the chopping blade, process sugar, oil, honey and eggs on speed 3 until well combined.
5. Add orange rind, flour, cinnamon and walnuts. Pulse until mixture is combined. Stir mixture into carrots. Spoon mixture into prepared pan. Bake for 30-35 minutes or until cooked when tested with a skewer.
6. Stand cake in pan for 5 minutes before transferring to a wire rack to cool.
7. Spread cake with icing and serve.

Cream Cheese Icing

- 250g cream cheese, softened
- 60g butter, softened
- 3 cups icing sugar mixture
- 1 tablespoon orange juice

Using the processing bowl fitted with the chopping blade, process cream cheese, butter and icing sugar mixture until smooth and combined. Add orange juice and process until combined.

Recipes continued

Banana Cake with Passionfruit Frosting

2¼ cups self raising flour
½ teaspoon salt
1 teaspoon cinnamon
½ teaspoon nutmeg
2 eggs
180g butter, softened
½ cup buttermilk
1½ cups raw sugar
1 teaspoon white vinegar
1 teaspoon vanilla essence
1½ cups very ripe mashed banana

1. Preheat oven to 180°C (160°C fan-forced). Grease and line a 20cm baba pan.
2. Sift flour, salt, cinnamon and nutmeg into a large bowl.
3. Using the processing bowl fitted with the chopping blade, process eggs, butter, buttermilk, sugar, vinegar, vanilla and banana on speed 3 for 20 seconds. (Mixture will separate at this stage but will come back together when mixed with dry ingredients).
4. Pour banana mixture into dry ingredients and mix with a wooden spoon until combined.
5. Pour mixture into prepared pan. Bake for 40 minutes or until cooked when tested with a skewer.
6. Stand cake in pan for 5 minutes before transferring to a wire rack to cool.
7. Spread cake with frosting and serve.

Serves 10

Passionfruit Frosting

150g cream cheese, softened
20g butter, softened
1 teaspoon vanilla
⅔ cup icing sugar mixture
¼ cup passionfruit pulp

Using the processing bowl fitted with the chopping blade, process cream cheese, butter, vanilla and icing sugar mixture until smooth and combined. Transfer to a bowl and stir through passionfruit pulp.

Recipes continued

Chocolate Cake

Serves 10

- 1½ cups self-raising
- ½ cup cocoa
- 1½ cups caster sugar
- pinch of salt
- 150g butter, softened
- 2 eggs
- 1 cup milk

1. Preheat oven to 180°C (160°C fan-forced). Grease and line a 20cm round cake pan.
2. Using the processing bowl fitted with the chopping blade, process flour, cocoa, sugar and salt on speed 3 until well combined.
3. Add butter and eggs to mixture and continue to process on speed 3 until combined.
4. Remove the food pusher and add milk through the feed tube. Process for 5-10 seconds.
5. Remove the processing bowl cover and scrape the sides of the bowl. Replace the cover and continue to process on speed 3 until well combined.
6. Pour mixture into prepared pan. Bake for 30-35 minutes or until cooked when tested with a skewer.
7. Stand cake in pan for 5 minutes before transferring to a wire rack to cool.
8. Spread cake with ganache and serve.

Chocolate Ganache

- 200g good quality dark chocolate, chopped
- ½ cup cream

Place cream in a small saucepan. Heat over low heat until hot (not boiling).

Remove from heat, add chocolate and stir until smooth. Stand at room temperature for several hours or until spreadable consistency.

Note: You can place the ganache in the fridge, to speed up the process. Stir regularly and watch it closely to avoid ganache setting hard.

Basic Buttercake

Serves 10

- 185g butter, softened
- 1 cup caster sugar
- ½ teaspoon vanilla essence
- 3 eggs
- 3 cups self-raising flour
- ¼ cup milk

1. Preheat oven to 180°C (160°C fan-forced). Grease and line a 22cm round cake pan.
 2. Using the processing bowl fitted with the chopping blade, process butter, sugar and vanilla on speed 3, until well combined.
 3. Add eggs to the mixture and process until combined.
 4. Add flour and milk and continue to process on speed 3 until well combined.
- Note:** Be careful not to over process.
5. Pour mixture into prepared pan. Bake for 40-50 minutes or until cooked when tested with a skewer.
 6. Stand cake in pan for 5 minutes before transferring to a wire rack to cool.
 7. Serve dusted with icing sugar.

Recipes continued

Chocolate Cherry Ripe Mousse

Serves 6

300ml thickened cream
3 eggs, separated
200g dark chocolate, chopped
30g butter, softened
80g cherry ripe, finely chopped

1. Using the processing bowl fitted with the whisk attachment, process cream on speed 5 until soft peaks form. Transfer to a bowl. Wash and dry bowl and attachment.
2. Place egg whites in processing bowl fitted with the whisk attachment, process on speed 5 until soft peaks form.
3. Place chocolate in a microwave-safe bowl. Microwave on medium power (50%) for 1 minute. Stir. Repeat process in 30 second intervals until melted. Add butter and stir until melted. Stir in egg yolks.
4. Fold through cream and eggwhites in 2 batches. Fold through cherry ripe. Spoon into serving dishes. Refrigerate until firm.

Honey Pikelets

Makes 24 (approx)

3 eggs
¼ cup honey
1 cup milk
1 ½ cups self raising flour
pinch salt
Cooking oil spray

1. Using the processing bowl fitted with the chopping blade, process eggs, honey, milk, flour and salt on speed 1 for 10 seconds. Scrape down sides of processor bowl and process again on speed 1 for a further 15 seconds until well combined.
2. Pour mixture into a jug and refrigerate for 30 minutes.
3. Heat a frypan over medium heat. Grease with cooking oil spray. Cook tablespoons of mixture in pan until golden and cooked through.
4. Serve with butter and jam.

Recipes continued

Chocolate Chip Cookies

Makes 25

- 125g butter, softened
 - ½ cup brown sugar, lightly packed
 - ½ cup caster sugar
 - ½ teaspoon vanilla essence
 - 1 egg
 - 1¾ cups self-raising flour
 - ¼ teaspoon salt
 - 1 cup chocolate chips
- 1 Preheat oven to 180°C (160°C fan-forced). Grease and line two baking trays.
 - 2 Using the processing bowl fitted with the chopping blade, process butter, sugars and vanilla on speed 3 until well combined.
 - 3 Remove the processing bowl cover and scrape the sides of the bowl.
 5. Add egg and continue to process on speed 3 for 5 seconds. Once again remove the processing bowl cover and scrape the sides of the bowl.
 6. Add flour and salt and process until combined. Transfer mixture to a bowl. Fold through chocolate chips. Roll mixture into small balls.
 7. Place on baking trays, allowing room for spreading. Flatten balls slightly with a fork. Bake for 12-15 minutes or until golden. Allow to cool on trays.

Scones

Makes 15

- 3 cups self-raising flour
 - 1 teaspoon icing sugar mixture
 - 60g cold butter, cubed
 - 440ml buttermilk
1. Preheat oven to 220°C (200°C fan-forced). Grease a 19cm square cake pan.
 2. Using the processing bowl fitted with the dough blade, process flour, icing sugar and butter on speed 3, until combined.
 3. Remove the food pusher and pour buttermilk through the feed tube and continue to process for 5-10 seconds.
 4. Remove the processing bowl cover and scrape the sides of the bowl. Replace the cover and continue to process on speed 3 until just combined.
 5. Remove chopping blade and turn mixture out onto a lightly floured surface. Knead lightly and pat out to approximately 3cm thick. Use a round 5cm pastry cutter to cut rounds from dough.
 6. Place slightly touching in prepared pan. Bake for 12-15 minutes or until cooked through.
 7. Serve scones warm with jam and cream.

Recipes continued

Pizza Dough

Makes 2 thin pizzas or 1 thick pizza

- 2 teaspoons (7g) dry yeast
- 1 teaspoon sugar
- $\frac{3}{4}$ cup warm water
- 2 tablespoons olive oil
- 2 cups plain flour
- $\frac{1}{2}$ teaspoon salt

1. Combine yeast, sugar and warm water in a bowl. Stir to combine. Cover mixture and stand in a warm place for 5 minutes until frothy; add oil.
2. Using the processing bowl fitted with the dough blade, process flour, salt and yeast mixture on speed 1 until mixture forms a dough (about 10-15 seconds).
3. Remove dough blade. Turn dough onto a floured surface and knead for about 8-10 minutes or until the dough is firm and elastic. Place dough in a lightly greased bowl. Cover with plastic wrap and allow to rest in a warm place for 20-30 minutes or until dough has doubled in size.
4. Meanwhile, preheat oven to 240°C (220°C fan-forced)
5. Using your fist, punch down dough, fold sides to centre and turn dough over. Place dough onto a floured surface and lightly knead until smooth.

For a thin pizza crust: Halve dough. Roll dough out to about a 4-5mm thickness and place onto 2 oiled pizza trays.

For a thick pizza crust: Press dough onto an oiled pizza tray and allow to rest in a warm place until dough has risen again.

6. Spread with pizza sauce and assorted toppings.
7. Bake for 10-15 minutes or until crisp.

Roast Pumpkin Soup

Serves 4-6

- 1.5kg pumpkin, cut into 3cm pieces
- 2 tablespoons olive oil
- salt and pepper, to taste
- 20g butter
- 1 onion, chopped
- 1 litre chicken stock
- Cream or sour cream, to serve

1. Preheat oven to 200°C (180°C fan-forced)
2. Place pumpkin on a baking tray and drizzle with 1 tablespoon oil. Season with salt and pepper. Bake for 35-40 minutes or until tender.
3. Heat remaining oil and butter in a large saucepan over medium heat. Add onion and cook until soft.
4. Add pumpkin and stock and bring to a boil. Reduce heat, simmer, uncovered, for 10 minutes. Remove from heat and allow to cool to room temperature (**Do not process hot soup**).
5. Using the processing bowl fitted with the chopping blade, process cooled soup in batches until smooth.
6. Return soup to saucepan. Reheat until soup is hot.
7. Serve with cream, if desired.

Recipes continued

Potato and Leek Soup

Serves 4-6

3 medium leeks, whites only
1 tablespoon olive oil
2 small rashers bacon, chopped
1kg potatoes, peeled and chopped
2 litres chicken or vegetable stock
Salt and pepper, to taste
Shaved parmesan cheese, to serve

- 1 Using the processing bowl fitted with the blade holding disk (fitted with the thick slicing blade), feed the leek through the feed tube using the food pusher.
- 2 Heat oil in a large saucepan over medium heat. Add bacon and cook, stirring occasionally, until crisp. Remove from pan.
- 3 Add leeks and cook, stirring for 5 minutes or until soft. Add potatoes and stock and bring to a boil. Reduce heat, simmer, uncovered, for 35-40 minutes or until potatoes are tender. Remove from heat and allow to cool to room temperature before processing (**Do not process hot soup**).
- 4 Using the processing bowl fitted with the chopping blade, process cooled soup in batches until smooth.
- 5 Return soup to saucepan with bacon. Reheat until soup is hot. Season with salt and pepper.
- 6 Serve with parmesan cheese if desired.

Mexican style Tomato Soup

Serves 4-6

2 onions, quartered
2 cloves garlic, peeled
1 tablespoon olive oil
2 teaspoons cumin powder
1 teaspoon chilli powder
3 x 400g can chopped tomatoes
500ml water
1 teaspoon brown sugar
1 tablespoon vinegar
2 x 400g cans red kidney beans, rinsed, drained
Sour cream and flour tortillas, to serve

- 1 Using the processing bowl fitted with the chopping blade, process onions and garlic until chopped.
- 2 Heat oil in a large saucepan over medium heat. Add onions and garlic and cook until tender. Add cumin and chilli powder and cook, stirring, until fragrant.
- 3 Add tomatoes and water and bring to the boil. Reduce heat, simmer, uncovered for 20 minutes.
- 4 Stir through the sugar, vinegar and beans. Remove from heat and allow to cool to room temperature before processing (**Do not process hot soup**).
- 5 Using the processing bowl fitted with the chopping blade, process cooled soup in batches until smooth.
- 6 Return soup to saucepan. Reheat until soup is hot.
- 7 Serve with sour cream and warm flour tortillas.

Recipes continued

Herb and Lemon Lamb Patties

Makes 12

2 slices wholegrain bread
2 cloves garlic, halved
4 green onions, roughly chopped
½ cup flat-leaf parsley leaves
½ cup mint leaves
1 lemon, rind grated, juiced
550g lean lamb mince
1 egg
Salt and pepper, to taste

1. Using the processing bowl fitted with the chopping blade, process bread until crumbs are formed. Transfer to a bowl.
2. Add garlic, onions, parsley, mint and lemon rind. Process on speed 3 until finely chopped.
3. Add mince, 1 tablespoon lemon juice, egg and breadcrumbs. Season with salt and pepper. Pulse until combined and mixture comes together.
4. Remove mixture from bowl; divide into 12 patties. Place on a plate.
5. Heat a frypan over medium heat. Grease with cooking oil spray. Cook patties for 3-4 minutes each side or until cooked through.
6. Serve with a green salad and tzatziki.

Tzatziki

Makes 1 ¼ cups (approx)

1 small Lebanese cucumber
250g Greek-style yoghurt
½ cup mint leaves
Salt and pepper, to taste

1. Using the processing bowl fitted with blade holding disc (fitted with the coarse shredding blade), feed the cucumber through the feed tube using the food pusher. Remove cucumber from bowl and place in sieve. Squeeze out excess liquid.
2. Place yoghurt and mint into the blender jug. Blend until smooth. Transfer mixture to a bowl. Add cucumber and stir to combine. Season with salt and pepper.

Recipes continued

Corn Fritters

Makes 12

4 corn cobs
1/3 cup flat-leaf parsley leaves
1 cup self-raising flour
5 eggs
4 green onions, thinly sliced
salt and pepper, to taste
cream cheese, smoked salmon and rocket,
to serve

1. Remove corn kernels from cobs. Place half the corn in a large mixing bowl.
2. Using the processing bowl fitted with the chopping blade, process remaining corn, parsley, flour and 3 whole eggs on speed 3 until combined.
3. Transfer mixture to corn bowl. Stir in green onions. Season with salt and pepper.
4. Separate remaining eggs. Discard yolks. Using the whisk attachment, whisk egg whites to firm peaks. Fold egg whites into corn mixture.
5. Heat a frypan over medium heat. Spray with cooking oil spray. Add heaped tablespoons mixture. Cook for 2-3 minutes each side or until golden.
6. Serve fritters, topped with cream cheese, smoked salmon and rocket.

Thai Fish Cakes

Makes 25 (approx)

500g firm white fish fillets (ie. Ling, Gemfish, Redfish)
1 teaspoon fish sauce
2 tablespoons mild red curry paste
50g green beans, chopped finely
Oil, for deep frying
Sweet chilli sauce and lime wedges, to serve
Coriander leaves, to garnish

- 1 Using the processing bowl fitted with the chopping blade, process fish, fish sauce and curry on speed 5 for 30-40 seconds or until smooth.
- Note:** Be careful not to over process the seafood as this will toughen the fish cakes.
- 2 Transfer mixture to a bowl and stir through beans.
 - 3 Using wet hands, roll tablespoons of mixture into balls, flatten slightly and place on a plate.
 - 4 Deep-fry fish cakes until golden and cooked through. Remove fish cakes and drain on paper towel.
 - 5 Serve with sweet chilli dipping sauce and lime wedges; garnish with coriander.

Recipes continued

Pesto

Makes 1¼ cups

2 cups fresh basil leaves
3 cloves garlic
2 teaspoons lemon juice
½ cup olive oil
½ pine nuts, roasted
60g pecorino or parmesan, grated
Salt and pepper, to taste

1. Using the processing bowl fitted with the chopping blade, process basil, garlic, lemon juice and oil on speed 3 until finely chopped.
2. Remove the processing bowl cover and scrape the sides of the bowl.
3. Add pine nuts and cheese. Process on speed 3 until mixture is well combined. Season with salt and pepper.
4. Stir pesto through pasta or serve with barbecued chicken or meat.

Note: Store pesto in an airtight jar in the refrigerator, with a little extra oil on top to prevent browning.

Guacamole

Makes 1¼ cups (approx)

2 ripe avocados, peeled, seeds removed
1 clove garlic
1 tablespoon lemon juice
dash Tabasco sauce
1 jalapeno chilli, sliced (optional)
¼ cup fresh coriander leaves
1 small onion, quartered
1 tomato, quartered
Salt and pepper, to taste

1. Using the processing bowl fitted with the chopping blade, process avocado, garlic, juice, tabasco, chilli and coriander on speed 3 for 10 seconds.
2. Add onion and tomato and process on speed 2 until just chopped. Season with salt and pepper. Transfer mixture to a bowl and refrigerate for 1 hour before serving.
3. Serve with corn chips and salsa

Whole Egg Mayonnaise **Makes 1¼ cups (approx)**

2 eggs
2 tablespoons lemon juice
1 tablespoon Dijon mustard
Salt and pepper, to taste
400-500mls vegetable or light olive oil

- 1 Using the processing bowl fitted with the chopping blade, process eggs, lemon juice, mustard and salt on speed 1 for 10 seconds or until combined.
- 2 Increase to speed 3. With the motor operating, add oil through the feed tube in a slow, thin stream until mixture is thick and creamy. Season with salt and pepper.
- 3 Store in the refrigerator in an airtight container for up to 2 weeks.

Recipes continued

Variations

- Add crushed garlic to mayonnaise to make garlic mayonnaise.
- Add finely chopped gerkins, capers and parsley to mayonnaise to make a tartare sauce.

Hummus

Makes 1 cup

400g can chickpeas, rinsed, and drained

¼ cup tahini paste

¼ cup lemon juice

¼ cup water

¼ cup olive oil

1 clove garlic, crushed

½ teaspoon ground cumin

½ teaspoon salt

1. Using the processing bowl fitted with the chopping blade, process all ingredients on speed 3 until smooth.
2. Transfer mixture into a bowl and refrigerate for 1-2 hours before serving.
3. Serve with pita crisps or crackers.

Rocket, Chilli and Cashew Dip

Makes 2 cups (approx)

1 clove garlic, halved

1 large red chilli, seeds removed and sliced

4 cups wild or baby rocket leaves

½ cup olive oil

3 teaspoons lemon juice

⅔ cup unsalted toasted cashews

½ cup grated parmesan cheese

salt and pepper, to taste

1. Using the processing bowl fitted with the chopping blade, process garlic and chilli on speed 5 until chopped.
2. Add rocket, oil and lemon juice. Continue to process until just combined.
3. Scrape the sides of the bowl. Add cashews and cheese. Process until mixture is combined and finely chopped. Season with salt and pepper
4. Serve dip with crackers.

Recipes continued

Herb Crumbed Schnitzel

Makes 4

4 slices mixed grain bread
1/3 cup flat-leaf parsley
1 tablespoon chopped chives
1 tablespoon thyme leaves
2 garlic cloves, halved
1/4 cup finely grated parmesan cheese
Salt and pepper, to taste
1/3 cup flour
2 eggs, lightly beaten
2 tablespoons milk
4 thin veal schnitzels
Vegetable oil, for frying

1. Using the processing bowl fitted with the chopping blade, process bread until crumbs are formed. Transfer to a large bowl.
2. Add herbs and garlic. Process on speed 3 until finely chopped. Add breadcrumbs and cheese. Pulse until combined. Season with salt and pepper. Transfer to a plate.
3. Place flour in a bowl. Whisk egg and milk together in another bowl. Coat veal lightly in flour, shaking off excess. Dip in egg mixture. Lightly press on breadcrumb mixture.
4. Heat oil in a large frypan over medium-high heat. Cook veal in batches for 2-3 minutes each side or until golden and cooked through.
5. Serve veal with crispy potatoes and mixed salad.

Bacon and Mushroom Quiche

Serves 6

125g tasty cheese
Cooking oil spray
1/4 cup packaged breadcrumbs
1 tablespoon olive oil
1 brown onion, finely chopped
100g shortcut bacon, chopped
150g button mushrooms, sliced
4 eggs
1 cup milk
1/2 cup thickened cream
1/2 cup self-raising flour
Salt and pepper, to taste

1. Using the processing bowl fitted with the blade holding disk (fitted with the coarse shredding blade), feed the cheese through the feed tube using the food pusher.
2. Preheat oven to 180°C (160°C fan-forced). Lightly grease a 23cm pie dish with cooking oil spray. Coat the inside of dish with bread crumbs and shake out excess.
3. Heat oil in a frypan over medium heat. Add onion, bacon and mushrooms. Cook for 3-4 minutes or until onions and mushrooms are soft. Transfer to a bowl.
4. Using the processing bowl fitted with the chopping blade, process eggs, milk, cream and flour on speed 4 for 20 seconds. Season with salt and pepper.
5. Place the bacon mixture into the prepared dish. Sprinkle with grated cheese. Pour over the egg mixture.
6. Bake for 45-50 minutes or until set. Stand for 10 minutes before slicing.
7. Serve quiche with salad.

Recipes continued

Baked Lemon Cheesecake

Serves 10

250g plain sweet biscuits
2 teaspoons nutmeg
125g melted butter
250ml thickened cream
3 eggs
½ cup caster sugar
2 teaspoon finely grated lemon rind
2 tablespoons lemon juice
500g cream cheese, softened, chopped

- 1 Preheat oven to 160°C (140°C fan-forced). Grease a 20cm spring form pan; line the base with baking paper.
- 2 Place half of the biscuits in the processing bowl fitted with the chopping blade. Using the pulse button, process biscuits until they resemble fine breadcrumbs. Repeat with remaining biscuits.
- 3 Return all the biscuit crumbs to the processor bowl. Add nutmeg and melted butter, process until combined.
- 4 Press crumb mixture onto the base and sides of prepared pan. Place on a baking tray and refrigerate for 30 minutes.
- 5 Using the cleaned processing bowl, fitted with the chopping blade, process cream, eggs, sugar, rind and lemon juice on speed 3 until combined.
- 6 With the motor operating, add cubes of cream cheese through the feed tube and process until smooth.
- 7 Pour mixture over biscuit crumbs in pan. Bake for 50 minutes or until set.
- 8 Cool in the oven with the door ajar. Refrigerate for 3 hours or overnight before serving.

Drink recipes (LC6950 only)

Classic Banana Smoothie

Serves 2

2 cups skim milk
2 medium bananas, chopped
½ cup low fat yogurt
1 tablespoon honey
¼ teaspoon cinnamon

1. Place all ingredients into blender jug.
2. Blend on 2 for 40 seconds or until smooth.
3. Pour into 2 glasses to serve

Citrus Buzz

Serves 2

60ml fresh lime juice
4 dashes Angostura bitters
8 ice cubes
Lemonade, to serve

1. Place all ingredients except for lemonade into blender jug.
2. Blend on 2 for 30 seconds or until crushed.
3. Pour into 2 glasses to serve; top with lemonade.

Fruity Fantasy

Serves 2

180ml fresh orange juice
90ml pineapple juice
9 strawberries, hulled
1 slice honeydew melon
1 slice rockmelon
8 ice cubes

1. Place all ingredients into blender jug.
2. Blend on 2 for 30 seconds or until smooth.
3. Pour into 2 glasses, to serve.

Frozen Lime Margarita

Serves 2

60ml tequila
30ml fresh lime juice
60ml Cointreau or triple sec
30ml sugar syrup
14 ice cubes

1. Place all ingredients in blender jug.
2. Blend on 2 for 40 seconds or until smooth.
3. Pour into 2 glasses to serve.

Drink recipes (LC6950 only) continued

Strawberry Daiquiri

Serves 2

90ml Bacardi rum
60ml fresh lime juice
60ml sugar syrup
6 strawberries, hulled, quartered
14 ice cubes

1. Place all ingredients in blender jug.
2. Blend on 2 for 40 seconds or until smooth.
3. Pour into 2 glasses to serve.

Mixed berry shake

Serves 4

2 cups milk
300g frozen berries
1 cup vanilla yoghurt

1. Place all ingredients in blender jug.
2. Blend on 2 for 40 seconds or until smooth.
3. Pour into 4 glasses to serve.

Pina Colada

Serves 2

90ml Bacardi rum
120ml pineapple juice
60ml coconut cream
30ml Malibu
30ml sugar syrup
14 ice cubes

1. Place all ingredients in blender jug.
2. Blend on 2 for 40 seconds or until smooth.
3. Pour into 2 glasses to serve.

Note: To make sugar syrup, place 1 cup sugar and 1 cup water in a small saucepan. Stir over low heat until sugar has dissolved. Bring to the boil, reduce heat and simmer for 5 minutes. Store in a screw top jar in the fridge.

Notes

Notes

Notes

12 Month Replacement Guarantee

In the unlikely event that this appliance develops any malfunction within 12 months of purchase (3 months commercial use) due to faulty materials or manufacture, we will replace it for you free of charge.

Should you experience any difficulties with your appliance, please phone our customer service line for advice on 1300 881 861 in Australia, or 0800 786 232 in New Zealand. Alternatively, you can send a written claim to Sunbeam at the address listed below. On receipt of your claim, Sunbeam will seek to resolve your difficulties or, if the appliance is defective, advise you on how to obtain a replacement or refund.

Your Sunbeam 12 Month Replacement Guarantee naturally does not cover misuse or negligent handling and normal wear and tear.

Similarly your 12 Month Replacement Guarantee does not cover freight or any other costs incurred in making a claim. Please retain your receipt as proof of purchase.

The benefits given to you by this guarantee are in addition to your other rights and remedies under any laws which relate to the appliance.

Our goods come with guarantees that cannot be excluded under the Australian Consumer Law and under the New Zealand Consumer Guarantees Act.

In Australia you are entitled to a replacement or refund for a major failure and for compensation for any other reasonably foreseeable loss or damage. You are also entitled to have the goods repaired or replaced if the goods fail to be of acceptable quality and the failure does not amount to a major failure.

Should your appliance require repair or service after the guarantee period, contact your nearest Sunbeam service centre.

For a complete list of Sunbeam's authorised service centres visit our website or call:

Australia

www.sunbeam.com.au

1300 881 861

Units 5 & 6, 13 Lord Street
Botany NSW 2019 Australia

New Zealand

www.sunbeam.co.nz

0800 786 232

26 Vestey Drive, Mt Wellington
Auckland, New Zealand

Need help with your appliance?

Contact our customer service team or visit our website for information and tips on getting the most from your appliance.

In Australia

Visit www.sunbeam.com.au

Or call 1300 881 861

In New Zealand

Visit www.sunbeam.co.nz

Or call 0800 786 232

 is a registered trademark.

'Multiprocessor' is a trademark of Sunbeam Corporation.

Made in China.

Due to minor changes in design or otherwise, the product may differ from the one shown in this leaflet.

© Copyright. Sunbeam Corporation Limited 2011.

ABN 45 000 006 771

Units 5 & 6, 13 Lord Street
Botany NSW 2019 Australia

Unit 3, Building D
26 Vestey Drive
Mt Wellington Auckland
New Zealand

Sunbeam Corporation is a division of GUD Holdings Ltd.

Free Manuals Download Website

<http://myh66.com>

<http://usermanuals.us>

<http://www.somanuals.com>

<http://www.4manuals.cc>

<http://www.manual-lib.com>

<http://www.404manual.com>

<http://www.luxmanual.com>

<http://aubethermostatmanual.com>

Golf course search by state

<http://golfingnear.com>

Email search by domain

<http://emailbydomain.com>

Auto manuals search

<http://auto.somanuals.com>

TV manuals search

<http://tv.somanuals.com>