



Before using this air conditioner, please read the following instructions carefully and keep this manual along with your proof of purchase in a safe place for future reference.

# OWNER'S MANUAL

CANADIAN STANDARDS

**MINI-SPLIT HEAT PUMP (SEER 16)**

**12,000 BTU**

**12,000 BTU COOLING**

**13,000 BTU HEATING**

MODELS: 13-05020 / 13-05024

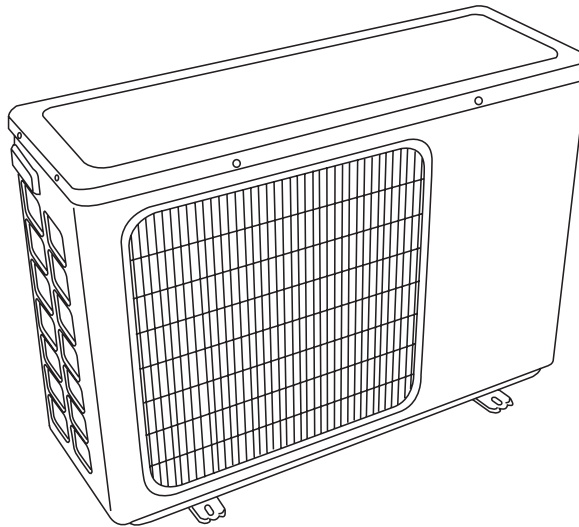
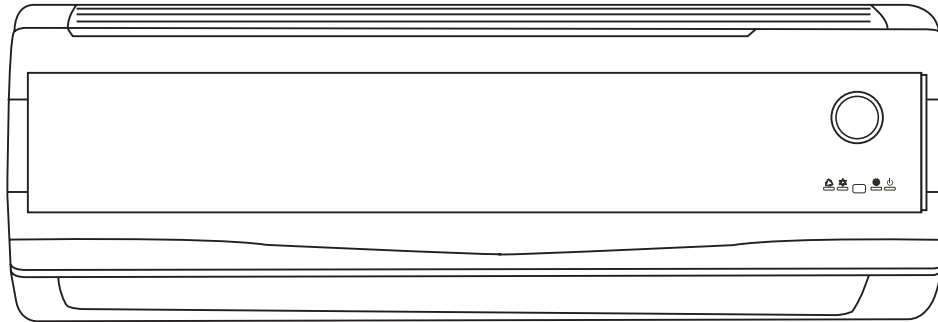

***sunrise* Tradex Corp.**

[www.sunrisetradex.com](http://www.sunrisetradex.com)

3122, Bernard Pilon  
St-Mathieu-de-Beloeil, Qc, J3G 4S5  
Tél. : (450) 536-2175 – Fax : (450) 536-9081  
Sans frais : 1 (800) 686-2175

00228-16/01/07

© Copyright, Sunrise Tradex Corp., 2007







# CONTENTS

Safety precautions	.2
Air conditioner diagram	.3
Remote control	.4
Remote control operation	.5-6
Safety notes	.7
Maintenance	.8-9
Troubleshooting	.10-11
Technical specifications	.12
Installation setup diagram	.13
Installation location	.14
Installation instructions	.15-19
Electrical wiring - indoor unit	.16-17
Electrical wiring - outdoor unit	.18
Air purging and leakage test	.20
Test operation	.21
Important notice	.22
Warranty	.23







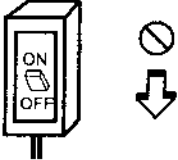
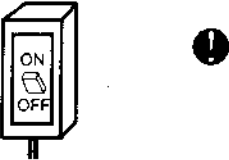

Thank you for choosing this GREE mini-split heat pump, please keep this owner's manual with proof of purchase for reference.

# SAFETY PRECAUTIONS

## Legend of symbols used in this manual :

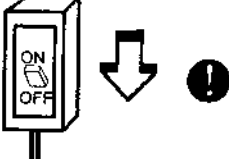
-  Not to do.
-  Feature of the appliance (not a defect).
-  Pay attention.
-  Be sure to follow instructions.
-  Grounding is necessary.
-  Warning: Incorrect handling may cause serious hazards and/or injuries.

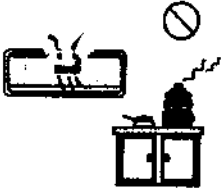
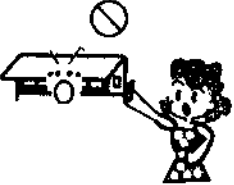
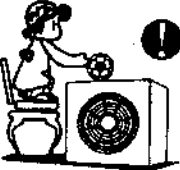
### Disconnecting switch

 <p><b>Only to the attention of electricians or technicians :</b> To eliminate risks of short circuits and fire hazards, do not unplug the air conditioner or switch off the circuit breaker when unit is running.</p>	 <p>Keep clean and in good working order the power supply circuit breaker or plug. To eliminate risks of electric shocks or fire hazards, make sure the power supply cord is correctly plugged in.</p>	 <p>Use 110-120V~60Hz power supply only.</p>
 <p>Always check the power supply cord or wire for signs of damages before installing and using the air conditioner. If the power cord is damaged, contact SUNRISE TRADEX Customer Service.</p>	 <p>Never insert fingers, foreign objects or anything to obstruct the air inlet and outlet grilles of both inside and outside units. Warn children.</p>	 <p>Do not expose skin or eyes directly to cool air over a long period of time.</p>
 <p>Always close the air conditioner before cutting the power off when there is a malfunction of the unit.</p>	 <p>To eliminate risks of electric shocks and fire hazards, do not attempt to repair the air conditioner by yourself.</p>	 <p>Do not put any combustion appliance in the direct path of the unit airflow ; it could affect the combustion efficiency.</p>
 <p>Do not operate the unit with wet hands or spray water or other liquid inside the unit.</p>	 <p>Do not place any foreign objects on the outdoor unit.</p>	 <p>Make sure the air conditioner is well grounded according to local electricity codes and that the work is done by a qualified and certified electrician or technician.</p>

# AIR CONDITIONER DIAGRAM

Actual model may differ from the diagram

## INDOOR UNIT

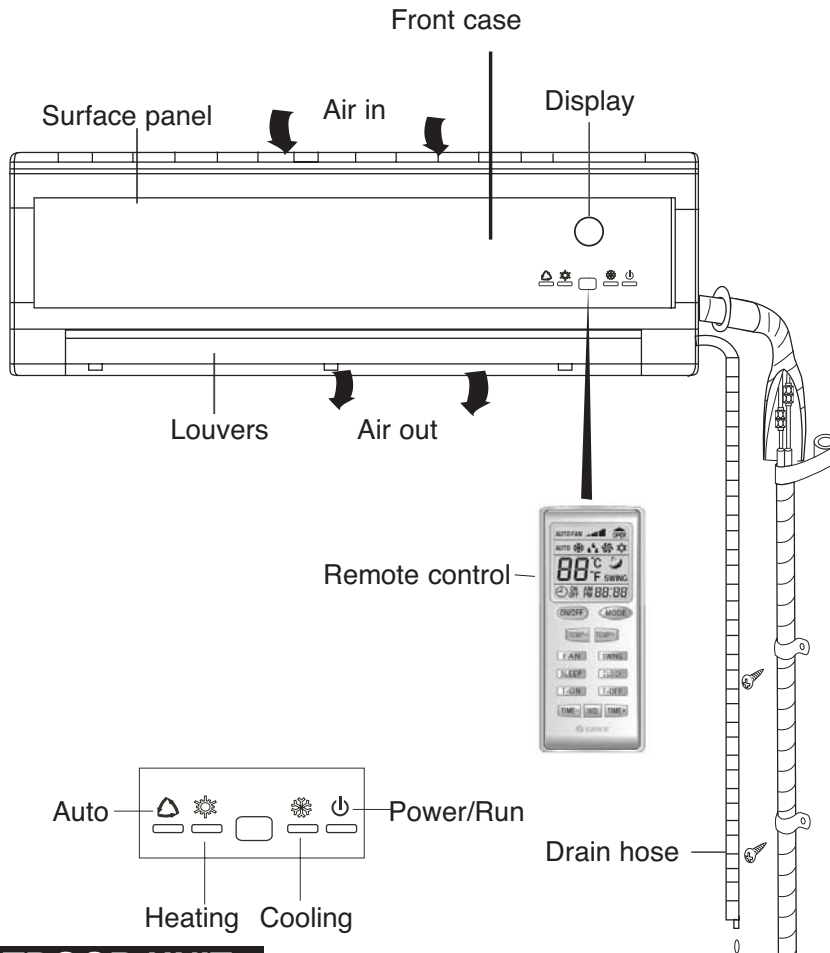

## OUTDOOR UNIT

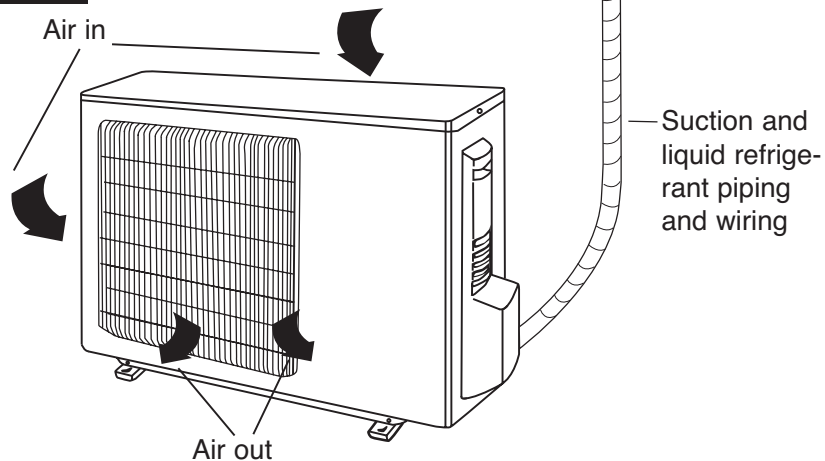

# REMOTE CONTROL

## 2 AAA - 1.5V BATTERIES POWER THE REMOTE CONTROL.

- Do not use rechargeable batteries

### How to insert the batteries

1. Following the arrows (see Figure), remove the battery cover.
2. Insert the 2 batteries, making sure that the terminals (+/-) are correctly fitted. Put the cover back into position.
3. Using the tip of a pen or any other sharp object, press on the **ACL** key.
4. Reinstall the cover.

### NOTE :

- Don't mix new with used batteries or batteries of different types.
- If you are not using the remote control for a long period of time, remove the batteries to eliminate potential battery leakage.
- The remote control should be kept at least 1 m or more away from the TV set or any other electric or electronic appliances.
- Make sure there is nothing blocking the signal from the remote control to the inside unit.
- Do not drop or throw the remote control.
- Do not leave the remote control in a location exposed to direct sunlight or near a heat source.
- Do not spray any liquid or immerse the remote control.

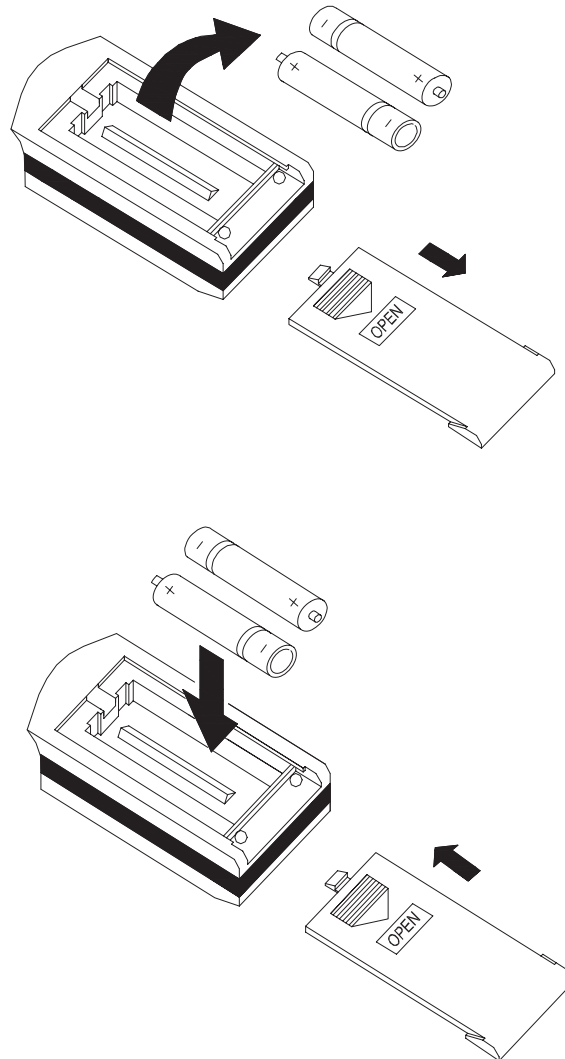

# REMOTE CONTROL OPERATION

**IMPORTANT:**

Some functions on this remote control are not available on models sold in Canada. The usage and operation of these functions are therefore not detailed in this manual.

**NOTE:**

- Make sure that there is no obstruction between the remote and the inside unit.
- Do not drop or throw the remote control
- Do not place the remote control near hot places or exposed to sunlight

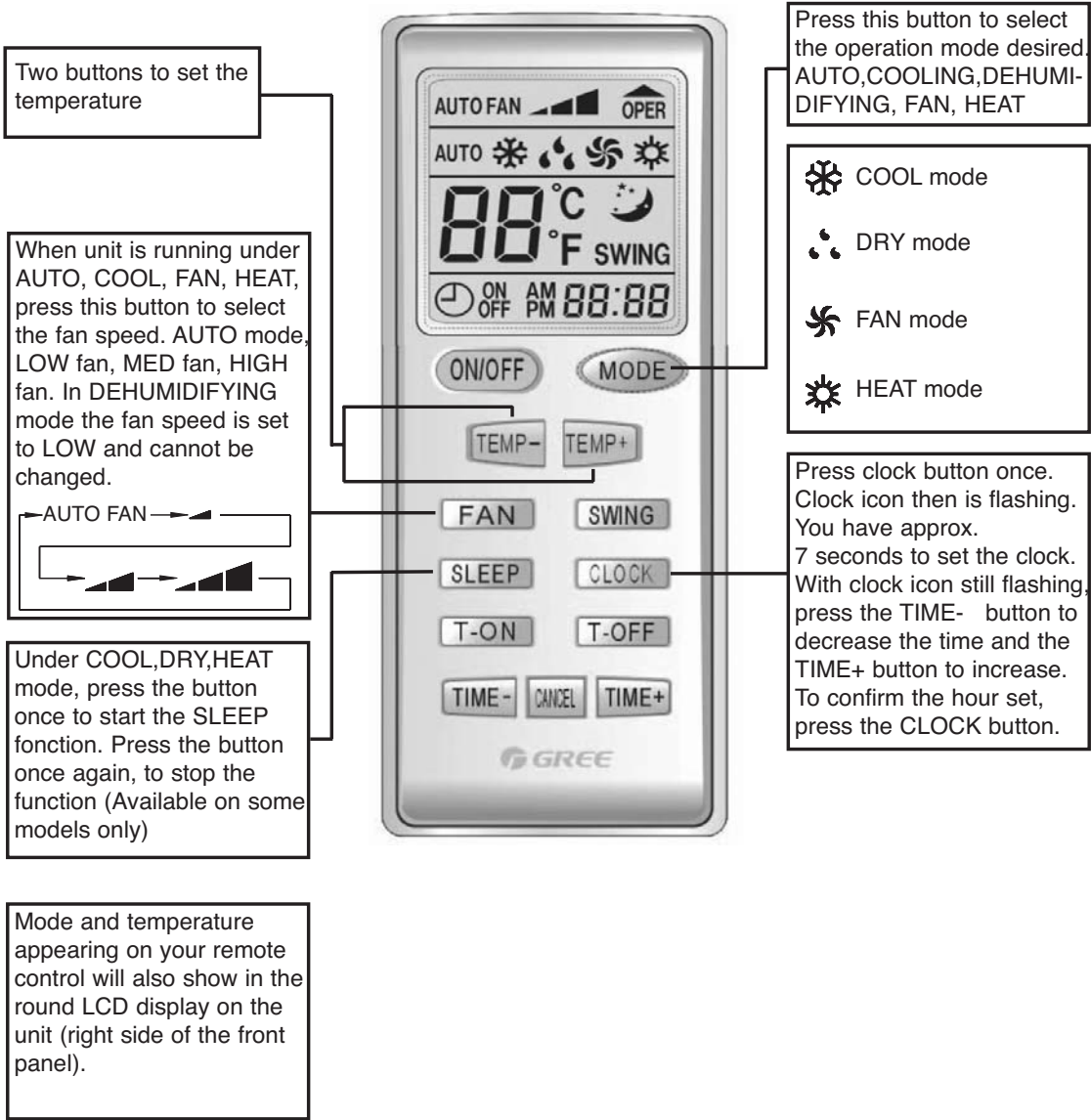

# REMOTE CONTROL OPERATION

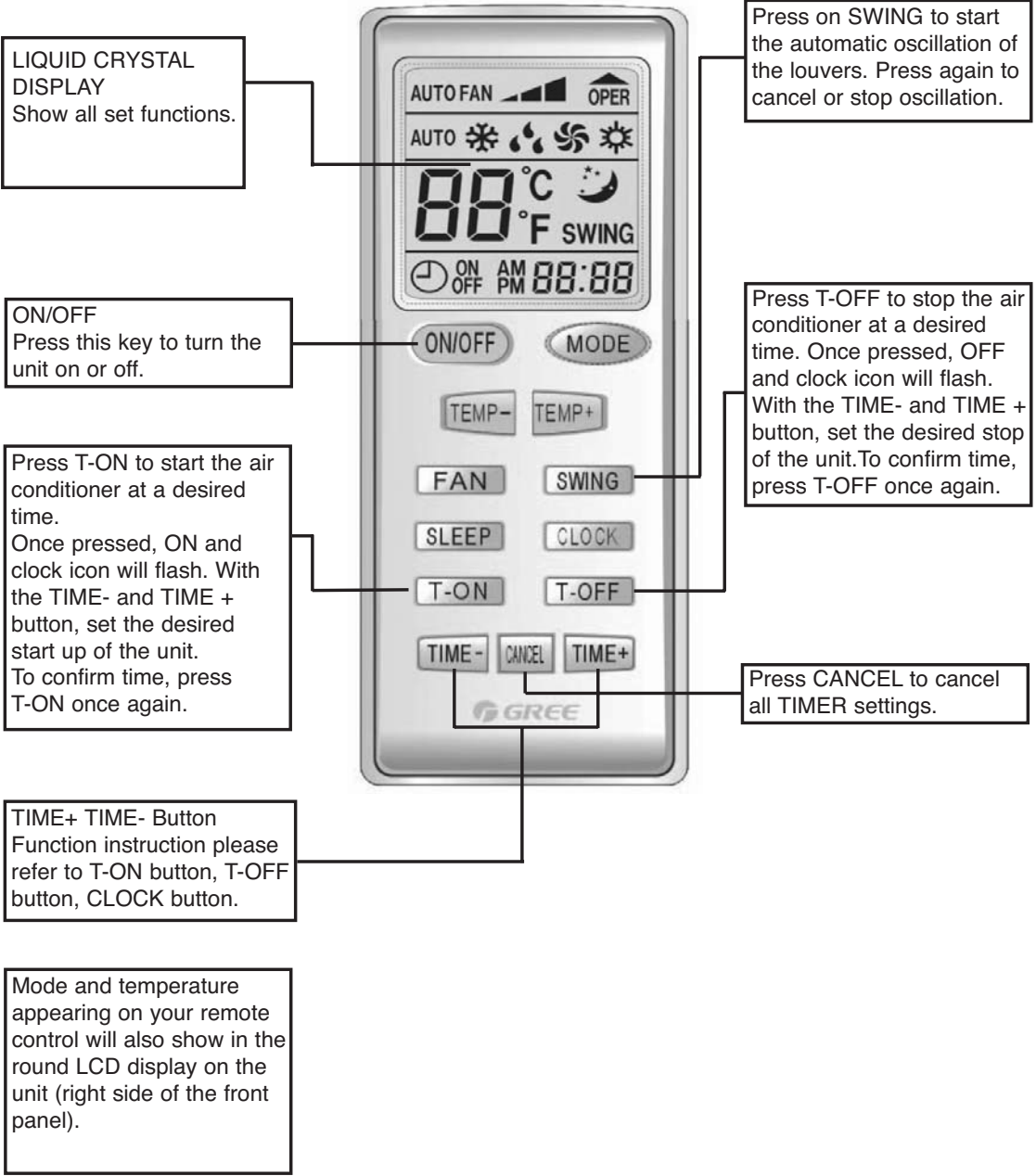

## SAFETY NOTES

Always set the most adequate temperature. It is recommend to set the temperature about 5°C cooler than the outside temperature to reduce energy costs.



- The airflow direction can be moved upward or downward when unit is running.
- Make sure that the air outlet grills and intake vents are free from obstructions.

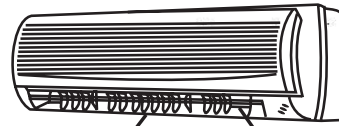

Louver of left/right direction

Louver of upward/downward direction

Keep doors and windows closed when the air conditioner is running, otherwise it could affect the air conditioner cooling efficiency.

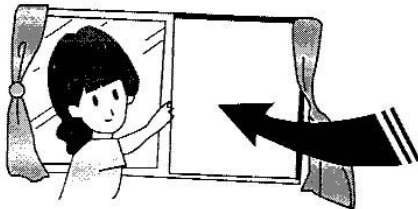

Do not leave animals or plants exposed directly to the cooling airflow for long periods of time.

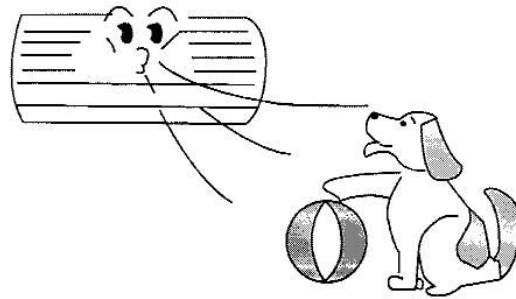

Do not splash water or other liquid on the air conditioner to prevent risks of electric shocks or unit malfunction.



The air conditioner must be properly grounded. Do not connect the ground to gas or water pipes, lightning rods, lighting poles or telephone/cable lines.

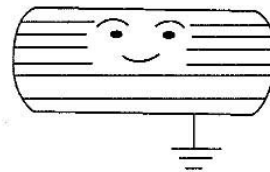

**⚠ WARNING**

To eliminate risks of vibrations and damage to the compressor, make sure the air conditioner is properly connected and powered with 115 V / 1 ph / 60 Hz.

Unit working temperature range:  
Do not operate unit if outside temperature is below -5°C or above 43°C or you could damage the compressor and void the warranty.

Do not use the air conditioner for other purposes than what it is designed for (such as drying clothes, preserving foods, etc.).



# MAINTENANCE

## CAUTION

- Turn power off and then cut the circuit-breaker off before cleaning the air conditioner.
- Never spray water on the indoor and outdoor units when cleaning the air conditioner.
- Always use a dry soft cloth and warm water, without or with a mild detergent.

### Cleaning the front panel

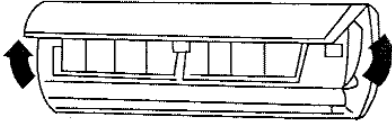
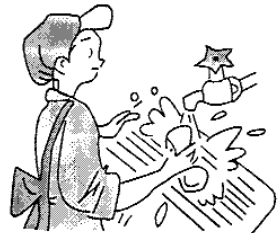
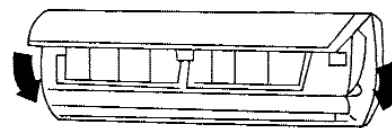
<p>1. To remove, pull the front panel in the direction of the arrows. Gently push aside the brackets holding the panel.</p>	
<p>2. Use a dry soft cloth, or a cloth slightly dampened with warm water, with or without a mild soap. Completely dry it.</p> <ul style="list-style-type: none"><li>• Never use water above 45°C to prevent finish discoloration or plastic distortion.</li></ul>	
<p>3. Push aside the holding brackets to reposition the panel. Make sure the panel is correctly clipped.</p>	

### Cleaning the air filters

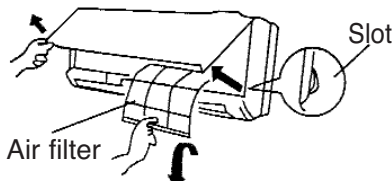
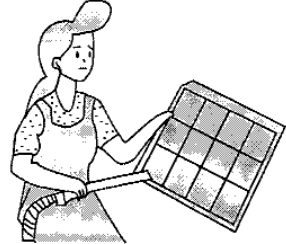
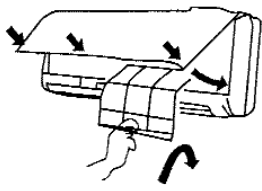
<ul style="list-style-type: none"><li>• For a maximum efficiency, it is recommended to clean the air filters every two weeks, or more if you have animals.</li></ul> <p>1. Open the front panel and carefully remove the air filters.</p>	
<p>2. Gently clean with a vacuum cleaner or wash the filters in warm soapy water. Rinse well and let dry before putting it back.</p> <ul style="list-style-type: none"><li>• Never use water above 45°C to prevent discoloration or plastic distortion.</li></ul>	
<p>3. Reinstall the filters, then close the front panel, making sure all parts are correctly fitted.</p>	

## MAINTENANCE

### Active-carbon air filters (optional)

1. Remove the air filters, as described in step #1 of "Cleaning the air filters" section.
2. Take the active-carbon air filters out of the bag and place them into the filter frames.
  - Be cautious not cut yourself on the fins.
3. Reinstall the air filters, as described in step #3 of "Cleaning the air filters" section.

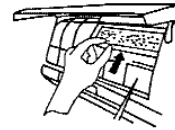

### Not using the air conditioner for a long period of time

- If you are not to use your air conditioner for a long period of time (ex.: during winter time), please follow these instructions :
1. Turn the air conditioner off and cut the circuit-breaker off.
  2. Clean the filters and other parts, as well as the outdoor and indoor unit enclosures.
  3. Before using again your air conditioner :
    - Check the filters, and if necessary, clean them, as well as the indoor and outdoor units.
    - Make sure that all parts and accessories are correctly fitted.
    - Make sure that the air outlet grills and intake vents are cleared out.
    - Do not forget to reset the circuit-breaker.

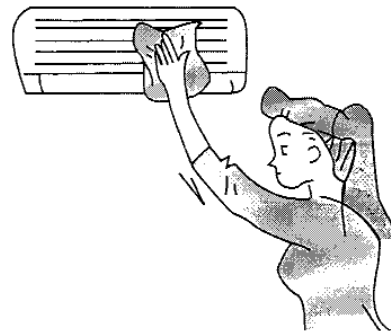

## TROUBLESHOOTING

**WARNING:** Do not attempt to repair your system by yourself. It can cause electric shock or fire. Please verify the following items before calling for a technician, it can save you time and money

Problem	Possible cause and solution
The air conditioner does not run immediately after the power key is pressed on.	In cooling mode, the compressor takes approximately 3 minutes to resume operation.
There is an unusual odour coming out of the air outlet grills when the air conditioner is running.	Air filters are dirty ; simply clean them.
The sound of flowing water can be heard while the air conditioner is running.	This is caused by the refrigerant fluid flowing through the unit.
A clicking noise can be heard when the unit is turned on or shut off.	This is caused by deformation of plastic due to sudden change in temperature.
The air conditioner does not operate at all.	<ul style="list-style-type: none"> <li>• Is there any power failure ?</li> <li>• Is the wiring loose?</li> <li>• Is the power supply circuit breaker on ?</li> <li>• Is the voltage rating high enough ?</li> <li>• Is the TIMER ON function set on ?</li> </ul>
Air cooling is not efficient.	<ul style="list-style-type: none"> <li>• Is the set temperature suitable ?</li> <li>• Are the air inlet and outlet grills obstructed ?</li> <li>• Are the air filters dirty?</li> <li>• Is the indoor fan speed set at low speed ?</li> <li>• Is there any other heat sources in the room?</li> <li>• Are the windows open?</li> </ul>
The remote control does not work.	<ul style="list-style-type: none"> <li>• Is the remote control out of the appropriate working distance with the indoor unit?</li> <li>• Is there anything blocking the signal transmission between the remote control and the indoor unit ?</li> <li>• Are the batteries worned out?</li> </ul>

## TROUBLESHOOTING

If any of the following situations occur, stop all operations and call the Sunrise Tradex Corp. Customer Service: **1-800-686-2175**

- Unusual noise can be heard during operation.
- Power fuse or switch often breaks.
- Carelessly splash water or something into air conditioner.
- Electrical lines and power plug are very hot.
- Wind blowing from the outlet smells bad during operation.
- Water is leaking on the inside wall.

***sunrise*** Tradex Corp.

[www.sunrisetradox.com](http://www.sunrisetradox.com)

1-800-686-2175

### IMPORTANT NOTICE

It is important to have your mini-split air conditioner installed by a Sunrise Tradex Corp. certified installer for your warranty to be valid. A mini-split air conditioner installed by a technician other than a Sunrise Tradex Corp. certified installer will void the warranty.

### WARNING

- ☑ Unit working temperature range: Do not operate unit if outside temperature is below -5°C or above 43°C or you could damage the compressor and void the warranty.
- ☑ Use copper supply wires.
- ☑ Caution mount with the lowest moving parts at least 2.4 m above floor or grade level.
- ☑ Warning: risk of electric shock can cause injury or death. Disconnect all remote electric power supplies before servicing.
- ☑ During connection of the pipes, if great torque is imposed on flare nuts, service valve on narrow pipe may be damaged. When tightening flare nuts or narrow pipe, torque should be adjusted between 13.7~18.6N.M (140~190KGF.CM).
- ☑ Do not put this unit in wet place.
- ☑ Fragile, handle with care.
- ☑ Electrical installation must be in accordance with local electrical codes.
- ☑ The installation of these units requires qualified personnel.
- ☑ Certified (approved) type supply conductors must be used.
- ☑ An independent branch circuit must be used.
- ☑ Maximum inter connecting conductors length should not exceed 11 m (444.875”).
- ☑ Refrigerating pipe length must be limited between 4 ~10 m (157.484” ~ 393.75”). If the length exceeds 7.62 m (300”), the cooling capacity may become impaired.
- ☑ Difference in height between indoor and outdoor unit should not exceed 7 m (275.594”).

## TECHNICAL SPECIFICATIONS

MODEL		13-05020 / 13-05024
FUNCTIONS		Cool/Heat
ACCESSORY		Air cleaner
COOLING CAPACITY (W)		2,500 W (1,350-3,200 W)
HEATING CAPACITY (W)		2,700 W (1,750-4,000 W)
POWER SUPPLY		115 V
FREQUENCY		60 Hz
COOLING / HEATING RATED CURRENT		3.53/3.86 A
MAXIMUM INPUT CURRENT		6.0 A
COOLING / HEATING RATED POWER		1,360/1,390 W
COOLING / HEATING RATED INPUT		730/800 W
RECYCLING AIR VOLUME (m <sup>3</sup> /h)		450 W
REFRIGERANT AND WEIGHT		R410A/1.2 kg
WATER PROOF LEVEL		IP24
NOISE (INDOOR / OUTDOOR) dB (A)		40/53 dBA
CLIMATE TYPE		T1
ANTI-ELECTRIC SHOCK PROTECTION		I
WEIGHT (KG) INDOOR UNIT / OUTDOOR UNIT		8.5/45 kg
SUCTION CONNECTION SIZE		1/2"
LIQUID CONNECTION SIZE		1/4"
DIMENSION (cm)		INDOOR UNIT 83 x 28.5 x 22.5 cm
W X H X D		OUTDOOR UNIT 84.8 x 54 x 32 cm

1. Above information may change without notice. Accurate specifications can be found on the name plate located on the unit.
2. When the unit is restarted after it was stopped, it can automatically resume in its most latest running mode, and the outdoor unit starts a little bit later.

Do not operate unit if outside temperature range as shown below, or you could damage compressor and void the warranty

Working temperature range		
	Indoor side DB/WB(°C)	Outdoor side DB/WB(°C)
Maximum cooling	32/23	43/26
Minimum cooling	21/15	21/-
Maximum heating	27/-	24/18
Minimum heating	20/-	-5/-6

# INSTALLATION SETUP DIAGRAM

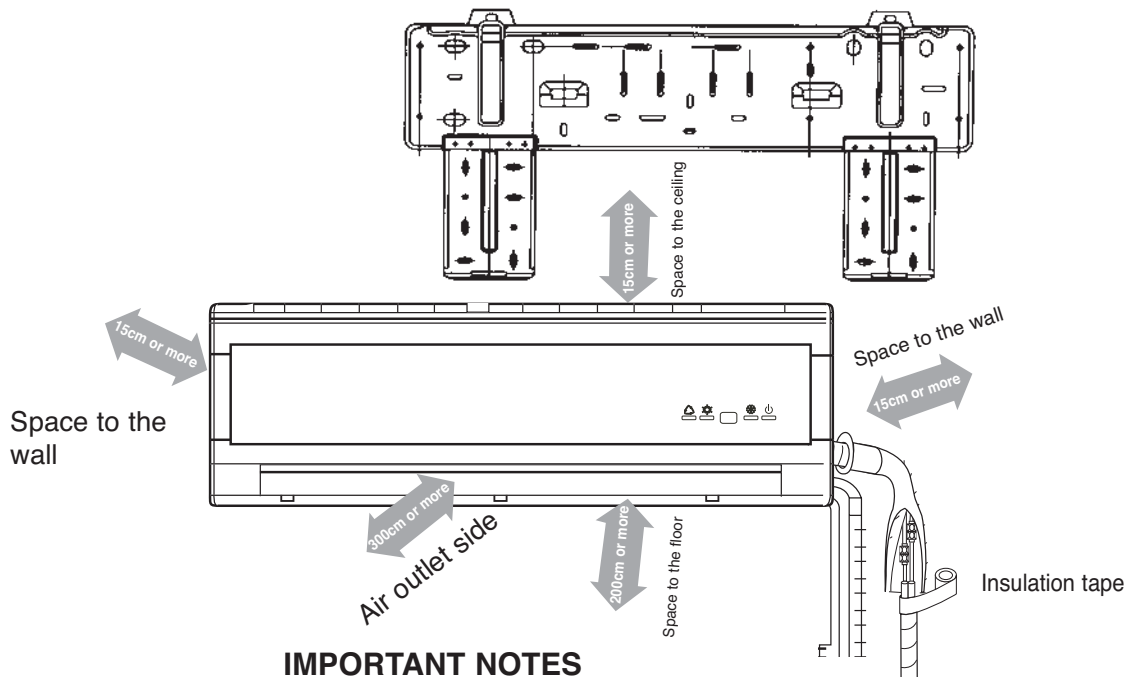

## IMPORTANT NOTES

- The installation must be done by trained and qualified service personnel with reliability according to this manual.
- It is important to have your mini-split air conditioner installed by a Sunrise Tradex Corp. certified installer for your warranty to be valid. A mini-split air conditioner installed by a technician other than a Sunrise Tradex Corp. certified installer will void the warranty.

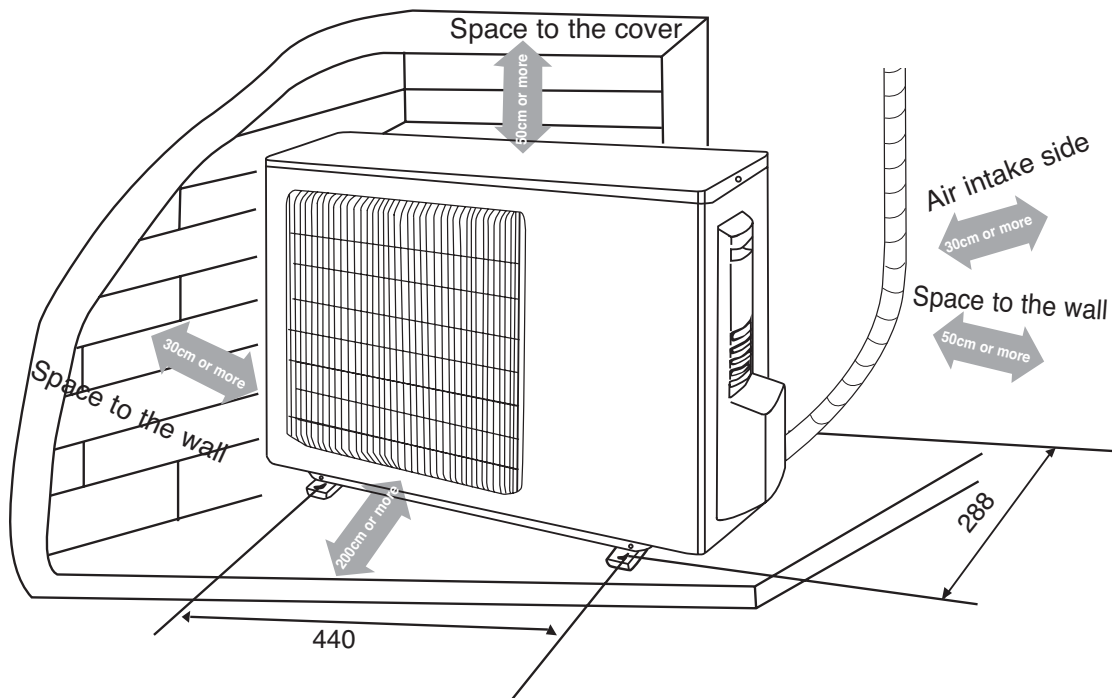

## INSTALLATION LOCATION

### INDOOR UNIT

1. The inlet and outlet should not be covered so that the outflow air can reach all parts of the room.
2. Install in a location where is permitting easy connection with the outdoor unit.
3. A location from which the condensation water can be drained out conveniently.
4. Avoid a location where there is heat source, high humidity or inflammable gas.
5. Install in a location where is strong enough to withstand the full weight and vibration of the unit.
6. Be sure that the installation conforms to the installation dimension diagram.
7. Be sure to leave enough space to allow access for routine maintenance.
8. Install in a location where is a least 1 m (39-3/8") from other electric appliances such as television, audio device, etc.
9. Select location where is easy to remove and clean the filter.

### OUTDOOR UNIT

1. Select location from which noise and outflow air emitted by unit will not inconvenience neighbors.
2. Select location where there should be sufficient ventilation.
3. The inlet and outlet should not be covered.
4. The location should be able to withstand the full weight and vibration of the outdoor unit.
5. There should be no danger of flammable gas or corrosive gas leaks.
6. Be sure that the installation conforms to the installation dimension diagram.
7. Please verify with your local authority if the installation of this unit is permitted.

# INSTALLATION INSTRUCTIONS

## INSTALL THE REAR PANEL

1. Always mount the rear panel horizontally.
2. Fix the rear panel on the selected location with screws supplied with the unit.
3. Be sure that the rear panel has been fixed firmly enough to withstand the weight of an adult of 60 kg (132.3 lbs.), furthermore, the weight should be evenly shared by each screw.

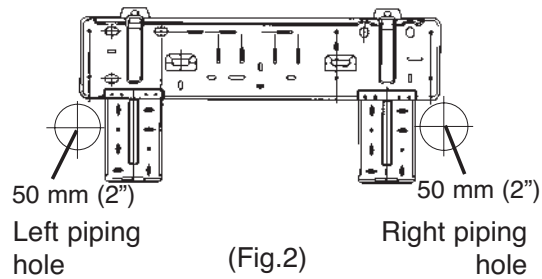

## INSTALL THE DRAIN HOSE

1. For a proper draining, the drain hose should be placed at a downward slant.
2. Do not wrench or bend the drain hose or flood its end in water.
3. The extended drainage pipe in the room should be wrapped with the insulating materials.

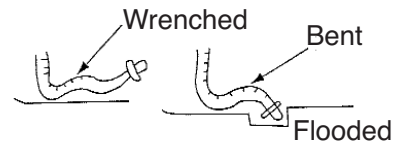

## INSTALL THE PIPING HOLE

1. Make the piping hole 50 mm (2") in the wall at a slight downward slant to the outdoor side. The center of the hole should be determined refer to Fig.2.
2. Insert the piping-hole sleeve into the hole to prevent the connection piping and wiring from being damaged when passing through the hole.

## INSTALL THE CONNECTION PIPES

Connect the connection pipes with the relevant union pipes of the indoor unit of the indoor unit and tighten the flare nut of the connection pipes.

### NOTE:

- Connect the connection pipes with the indoor unit firstly and the outdoor unit secondly.
- Be careful in bending the connection pipes, or you will damage the pipes.
- If the tightening torque is too big in tightening the flare nuts, leakage will happen.

## ELECTRICAL WIRING

**Note: Only an electrician can install the electrical circuit.**

1. Open the surface panel.
2. Remove the wiring cover.
3. Route the power connection cord from the back of the indoor unit and pull it toward the front through the wiring hole for connection.
4. Connect as shown on diagram.
5. Reassemble the wiring cover.



# INSTALLATION INSTRUCTIONS

## ELECTRICAL WIRING - INDOOR UNIT

**\*Only an electrician must do the connection of this unit.**

**Note:** The power of indoor unit is supplied by the outdoor unit. The outside disconnect switch must be installed between electrical panel and condensing unit.

Operation procedures:

1. Open the surface panel.
2. Open the cover and cover plate of electric box. (Right figure).
3. Remove the receiving window as shown in the below left figure.

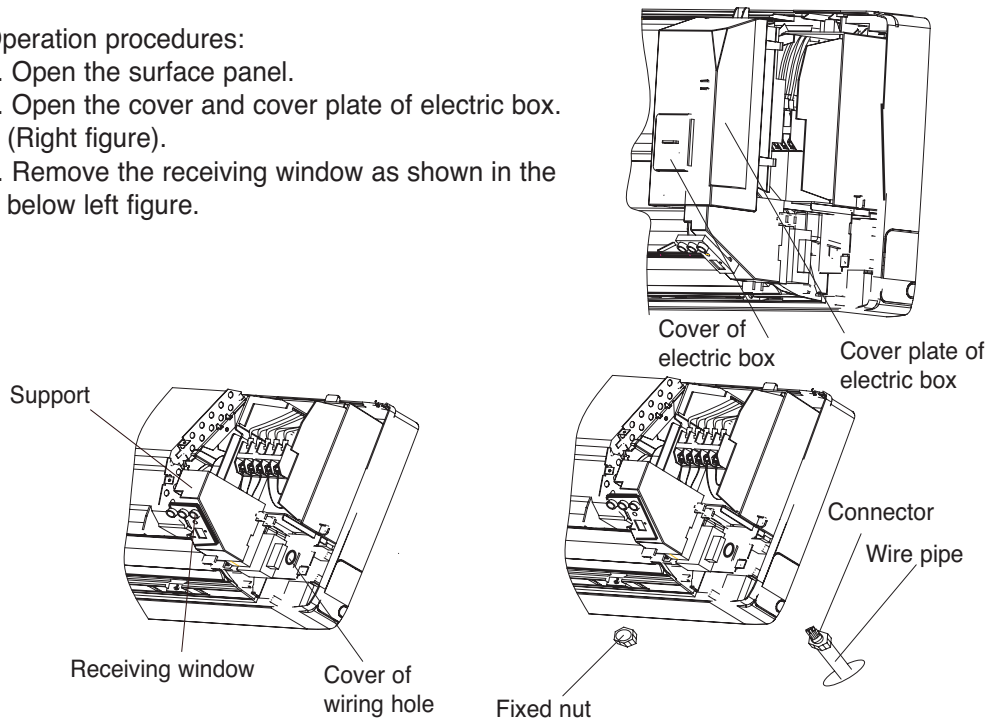

4. Wire pipe should be tightened by the fixed nut and the electric box should be fixed as shown in the above right figure and the below figure.

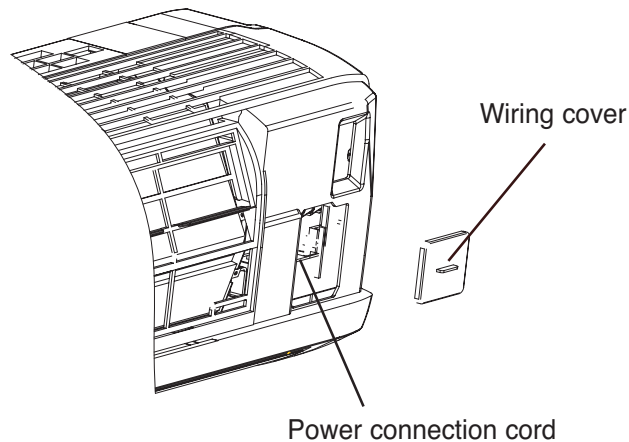

## INSTALLATION INSTRUCTIONS

Note: Wiring must be done by an electrician according to the local rules & regulations and this manual.

The connecting wire should be correctly connected to circuit interface.

Otherwise, it can cause a fire, electrical malfunction or cause damage to the unit.

The diagram is shown as below:

1. Connect the neutral wire of the power connection cables to the "N(1)" terminal
2. Connect signal wire to the "2" terminal
3. Connect Live wire to the "3" terminal
4. Connect ground to ground symbol
5. Put back cover and front panel.

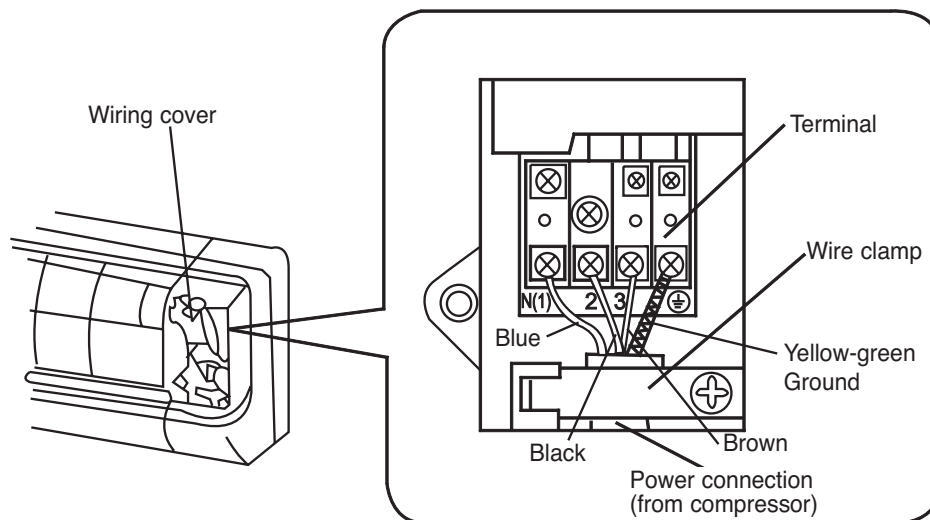

### IMPORTANT NOTICE

1. Wiring should be properly installed.
2. Tighten the screws on the terminal board.
3. Pull on each wire and make sure they are solidly in place.
4. Wrong wiring will cause unit to work abnormally and/or damage the unit.
5. Wrong wire grounding may cause short circuit.

# INSTALLATION INSTRUCTIONS

## ELECTRICAL WIRING - OUTDOOR UNIT

- Open the cover of outdoor unit.
- Make the wire connections according to the following instructions.

1. Remove the big handle
2. Remove the wire clamp and connect the end of the power connection cord with screws to the wiring terminal board. Make sure that the wiring connection is in accordance with the indoor unit (wire colors and numbers).
3. Make sure that the wiring has been connected securely.
4. Reinstall the big handle.

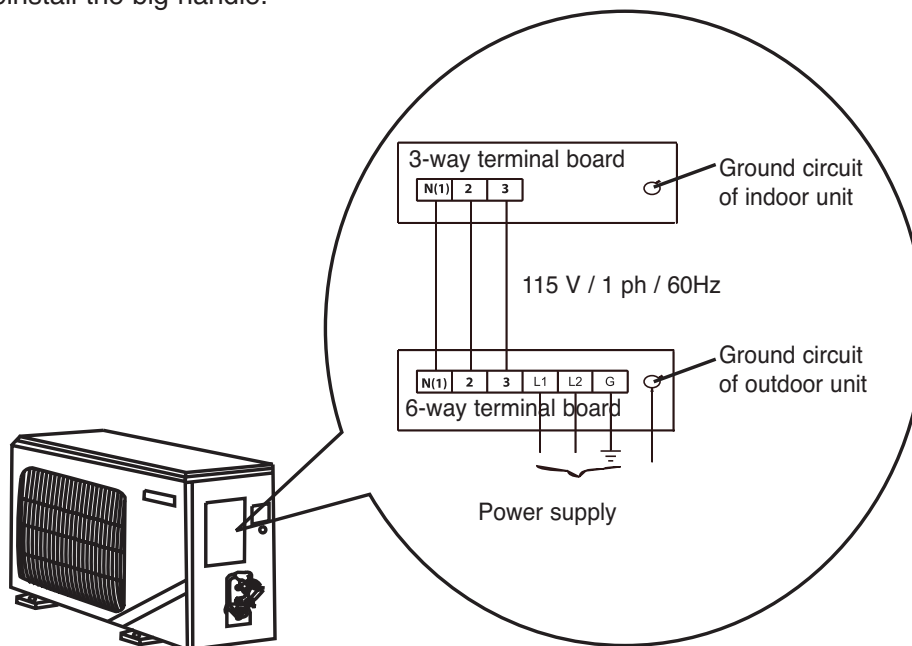

### IMPORTANT NOTICE

1. Wiring should be properly installed.
2. Tighten the screws on the terminal board.
3. Pull on each wire and make sure they are solidly in place.
4. Wrong wiring will cause unit to work abnormally and/or damage the unit.
5. Wrong wire grounding may cause short circuit.

# INSTALLATION INSTRUCTIONS

## Installation of the indoor unit

- When routing the piping and wiring from the left or right side of the indoor unit, cut off the tailings from the chassis in necessary (shown in Fig.4, (a), (b) (c)).  
 (1) Cut off the tailings 1 when routing the wiring only.  
 (2) Cut off the tailings 1 and tailings 2 (or tailings 1, tailings 2 and tailings 3) when routing both the wiring and piping. 1, 2 and 3 in Fig. 4 are the recommended piping.

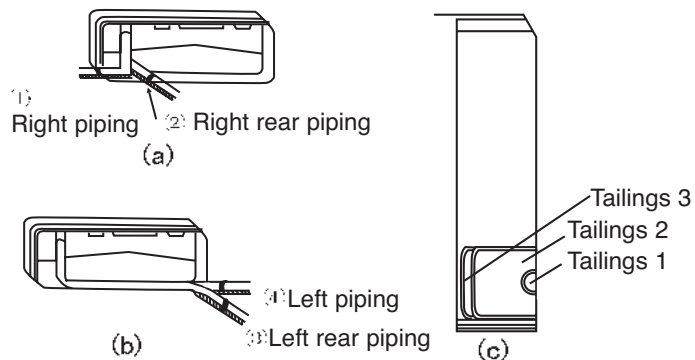

Fig.4

- Wrap the piping and wiring and pull them through the cut-off-tailings hole (Shown in Fig. 5).
- Hang the mounting slots of the indoor unit on the upper tabs of the rear panel and check if it is firm enough. (Shown in Fig. 6).

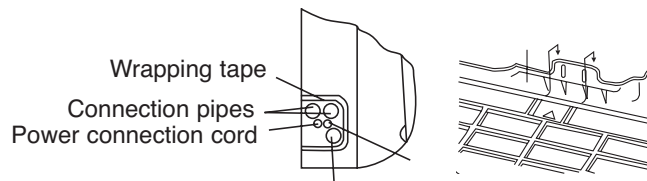

Fig.5

Fig.6

- The height of the installed location should be 2 m (78-3/4") or more from the floor.

## Installation of the outdoor unit

### Install the connection pipe

- Align the center of the piping flare with the relevant valve.
- Screw in the flare nut by hand and then tighten the nut with spanner and torque wrench refer to Fig.7.

**NOTE:** Exceeding tightening torque will damage the flare surface.

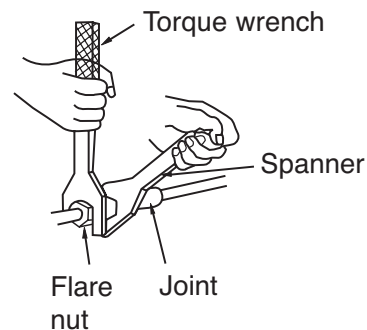

Fig.7

### Tightening torque table

Hex nut diameter (mm)	Tightening torque (N.m)
ø 6	15 ~ 20
ø 12	50 ~ 55

## AIR PURGING AND LEAKAGE TEST

1. Take out the nut cover of the inlet for refrigerant.
2. Connect the tube of the vacuum watch with the vacuum pump, having the low-pressure end linking to the inlet for refrigerant.
3. Starting the vacuum pump, when the indicator turns to -1 bar, closing the low pressure handle and stopping vacuimize. Keep for 15 minutes, ensuring the pressure of the vacuum watch remains.
4. Take out the valve cover of the gas valve and also the one for the liquid valve.
5. Loosing the cord of liquid valve until the pressure rise to 0 bar.
6. Dismantle the tube from the cover of the inlet for refrigerant then, tighten the cover.
7. Loose the valve cord of the gas valve as well as the liquid valve entirely.
8. Tighten the valve cover of the gas valve and liquid valve so as to check whether leakage occurred.

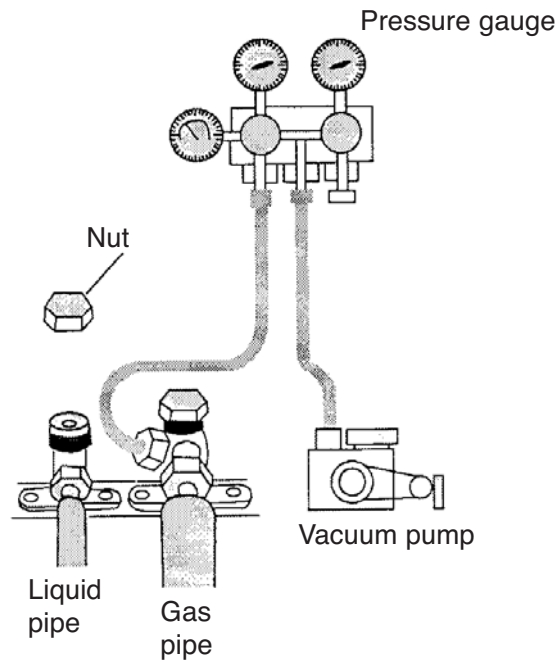

### Outdoor condensation drainage

When the unit is cooling or defrosting, the waste water formed in the outdoor unit can be drained out reliably through the drain hose.

#### Installation:

Install the outdoor drain elbow in the  $\Phi 25$  mm (1") hole on the base plate as shown in Fig.8, and joint the drain hose to the elbow, so that the waste water formed in the outdoor unit can be drained out to a proper place.

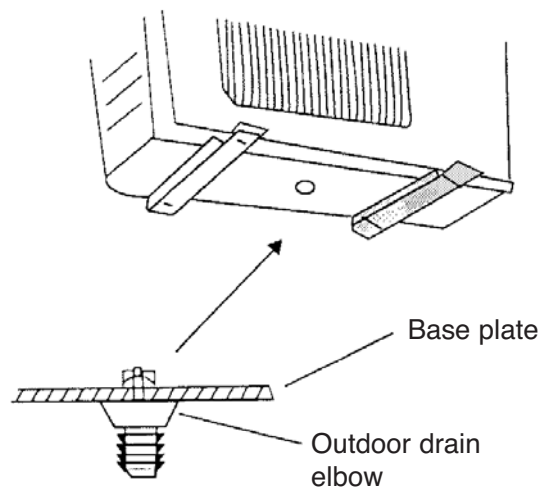
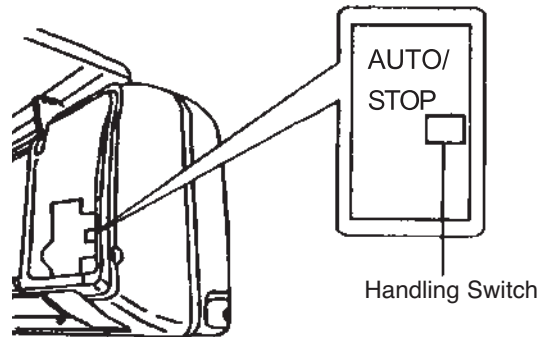

Fig.8

# TEST OPERATION

## 1. Before test operation

- (1) Do not switch on power before installation is finished completely.
- (2) Electric wiring must be connected correctly and securely.
- (3) Cut-off valves of the connection pipes should be opened.
- (4) All the impurities such as scraps and thrums must be clear from the unit.
- (5) Open the surface panel and set the handling switch to "RUN" mode.



## 2. Test operation method

- (1) Switch on power and press "ON/OFF" button on the remote control.
- (2) Press "MODE" button and check the operation condition of COOL, HEAT, SWING mode and so on.
- (3) When the remote control is lost, emergency run operation can be done as following by the ball pen or similar things:
  - (a) At stopping, set the handling switch to "AUTO" mode, then the unit will automatically run in the mode selected by the microcomputer system according to the surrounded temperature. If you want to stop running, you should repress the handling switch.
  - (b) At operation, set the handling switch to "STOP" mode to turn off the unit.

## Check after installation

Items to be checked	Possible malfunction
Has the unit been fixed firmly?	The unit may drop, shake or emit noise
Have you done the refrigerant leakage test?	It may cause insufficient refrigerating capacity.
Is the pipe insulation sufficient?	It may cause condensation and dripping.
Does the unit drain well?	It may cause condensation and dripping.
Is the voltage in accordance with the rated voltage marked on the nameplate?	It may cause electric malfunction or damage the unit.
Is the electrical wiring and piping connection installed correctly and securely?	It may cause electric malfunction or damage the unit.
Has the unit been connected to a secure ground connection?	It may cause electrical malfunction.
Is the electrical wire the appropriate gauge?	It may cause electric malfunction or damage the unit.
Has the inlet and outlet been covered?	It may cause insufficient refrigerating capacity.
Has the length of connection pipes and the refrigerant quantity been verified?	Frost on the evaporator/condensor, lack of capacity, general unit malfunction, possible damage to compressor.

## IMPORTANT NOTICE

- Always consult a qualified electrician to install the unit.
- Please contact the after sales service for any problems.
- If you have to carry your air conditioner in down position, it is suggested to wait 12 hours before you restart the machine.
- During winter, it is recommended to isolate the compressor of the outdoor unit with a special cover (not included).
- Never let the children play with the outdoor unit.
- Never insert any object (stick, rock, sand or others) in the unit.
- Never put chemicals products, gasoline, etc. near the outdoor unit during the operation.
- It is recommended to check regularly the outdoor and the indoor units.
- Always refer to the specifications.
- You may store the empty packaging boxes, for a future move.
- Please note that the outdoor unit is operate with a magnetic contactor.
- Unit working temperature range:  
Do not operate unit if outside temperature is below  $-5^{\circ}\text{C}$  or above  $43^{\circ}\text{C}$  or you could damage the compressor and void the warranty.

# WARRANTY

## LIMITED WARRANTY

This air conditioner is covered by a warranty against defects in materials and workmanship including the compressor, if used for the applications specified in this owner's manual, if installed by a Sunrise Tradex Corp. certified installer, for a period of ONE (1) year from the date of original purchase in Canada.

**NOTE: the compressor is covered by a 5-YEAR limited warranty.**

During the warranty period, if this air conditioner fails under normal use, SUNRISE TRADEX CORP. will, at its option, either repair the unit or replace it, free of charge, within a reasonable period of time after the air conditioner is returned.

As a condition to any warranty service obligation, the customer must present this warranty certificate along with the proof of purchase.

### THIS WARRANTY DOES NOT COVER :

1. Damage, accidental or otherwise, to the air conditioner that are not caused by materials or workmanship defect.
2. Damage caused by misuse, tampering or failure to follow the operating and maintenance instructions provided in this owner's manual.
3. Damage to the finish of the unit enclosure or to other outer features caused by wear.
4. Filter.
5. Damage due to faulty repair and / or installation done by a person/technician not duly authorized by SUNRISE TRADEX CORP
6. Insurance and freight costs for the warranty service.

ALL IMPLIED WARRANTIES, INCLUDING ANY IMPLIED WARRANTY OF MERCHANTABILITY, ARE LIMITED TO A ONE YEAR (1) PERIOD COVERED BY THIS EXPRESS LIMITED WARRANTY. SUNRISE TRADEX CORP. DISCLAIMS ANY LIABILITY FOR CONSEQUENTIAL OR INCIDENTAL DAMAGES AND, IN NO EVENT, SHALL SUNRISE TRADEX CORP. LIABILITY EXCEED THE RETAIL VALUE OF THIS AIR CONDITIONER FOR BREACH OF ANY WRITTEN OR IMPLIED WARRANTY WITH RESPECT TO THIS AIR CONDITIONER.

**Keep this owner's manual along with your proof of purchase in a safe place for future reference. You must provide proof of purchase for warranty service.**

Enter the following information on your air conditioner; it will help you upon getting assistance or service if you ever need it. You will have then to provide the model and serial numbers of the air conditioner – these data are detailed on the rating plate of the unit.

Dealer name: \_\_\_\_\_

Address: \_\_\_\_\_

Model No (Indoor unit): \_\_\_\_\_

Serial number: \_\_\_\_\_

Model No (Outdoor unit): \_\_\_\_\_

Serial number: \_\_\_\_\_

Purchase date: \_\_\_\_\_



## Free Manuals Download Website

<http://myh66.com>

<http://usermanuals.us>

<http://www.somanuals.com>

<http://www.4manuals.cc>

<http://www.manual-lib.com>

<http://www.404manual.com>

<http://www.luxmanual.com>

<http://aubethermostatmanual.com>

Golf course search by state

<http://golfingnear.com>

Email search by domain

<http://emailbydomain.com>

Auto manuals search

<http://auto.somanuals.com>

TV manuals search

<http://tv.somanuals.com>