

# OWNER'S MANUAL 2008

**1190 RC8 EU**

**1190 RC8 AUS/UK**

**1190 RC8 FR**

**1190 RC8 JP**

**ART. NO. 3211250en**



**KTM**



# DEAR KTM CUSTOMER

Congratulations on your decision to purchase a KTM motorcycle. You are now the owner of a state-of-the-art sports motorcycle that will give you enormous pleasure if you service and maintain it accordingly.

We wish you great pleasure riding the vehicle!

Please enter the serial numbers of your vehicle below.

Chassis number/type label (☛ S. 16)	Dealer's stamp
Engine number (☛ S. 17)	
Key number (☛ S. 16)	

The owner's manual corresponded to the latest state of this series at the time of printing. However, it is never possible to exclude small deviations arising from further development in design and construction.

All specifications are non-binding. KTM Sportmotorcycle AG in particular reserves the right to modify or delete technical specifications, prices, colors, forms, materials, services, designs, equipment, etc., without prior notice and without specifying reasons, to adapt these to local conditions, as well as to stop production of a particular model without prior notice. KTM accepts no liability for delivery options, deviations from illustrations and descriptions, as well as printing and other errors. The models portrayed partly contain special equipment that does not belong to the regular scope of delivery.

© 2008 by KTM-Sportmotorcycle AG, Mattighofen Austria

All rights reserved

Reproduction, even in part, is permitted only with the express written permission of the copyright owner.



ISO 9001(12 100 6061)



Within the meaning of the international quality management standard ISO 9001, KTM uses quality assurance processes that lead to the maximum possible quality of the products.















Issued by: TÜV Management Service



REG.NO. 12 100 6061

KTM-Sportmotorcycle AG  
5230 Mattighofen, Austria

MEANS OF REPRESENTATION .....	7	ODO menu .....	33
IMPORTANT NOTES .....	8	FUELDISTANCE menu .....	34
VIEW OF VEHICLE .....	12	FUELRANGE menu .....	35
View of vehicle, front left side .....	12	DISTANCE TO Next Service menu .....	36
View of vehicle, rear right side .....	14	LAPSTOGO menu .....	37
LOCATION OF SERIAL NUMBERS .....	16	TOPSPEED menu .....	38
Chassis number/type label .....	16	LAP/BESTLAP/LastLap menu .....	39
Key number .....	16	LAP/BESTLAP/TopSpeed menu .....	40
Engine number .....	17	Total distance menu in Race mode RACEODO .....	41
Fork part number .....	17	SET-UP menu .....	42
Shock absorber part number .....	18	CHANGE MODE menu .....	43
Steering damper part number .....	18	SET CLOCK menu .....	44
OPERATING ELEMENTS .....	19	SETTINGS menu .....	45
Clutch lever .....	19	SHIFT RPMS menu .....	46
Hand brake lever .....	19	LAP menu, LAP BLANK T button .....	47
Light switch .....	20	SET NUM LAPS menu .....	48
Headlight flasher switch .....	20	TRIP F RESET menu .....	49
Flasher switch .....	21	UNITS menu .....	50
Horn button .....	21	SET KM/MILES menu .....	51
Ignition/steering lock .....	22	SET °C/°F menu .....	52
Emergency OFF switch .....	22	OPTIONS menu .....	53
Electric starter button .....	23	TPMS menu .....	54
Combination instrument - overview .....	24	OPTION OUTERTEMP menu .....	55
Combination instrument - function buttons on handlebar .....	25	Displaying lap times .....	60
Combination instrument - activation and test .....	26	Displaying maximum speed .....	61
display .....	27	Setting ROAD or RACE mode .....	62
info display .....	28	Setting the clock with SET CLOCK .....	62
Indicator lamps .....	29	Adjusting shift speed RPM1/2 .....	63
Notes/warnings on the combination instrument .....	30	Setting the blank time of the LAP button LAP BLANK T .....	65

Setting number of laps SET NUM LAPS.....	66	GREASING AND SERVICE TABLE .....	91
Setting fuel reserve display TRIPF RESET.....	67	Important service tasks to be carried out by an authorized	
Setting kilometers/miles SET KM/MILES.....	68	KTM-RC8 workshop. ....	91
Setting temperature unit SET °C/°F .....	69	Important service tasks to be carried out by an authorized	
Switching external temperature display on/off.....	69	KTM-RC8 workshop. (as additional job) .....	94
Opening the filler cap .....	71	MAINTENANCE WORK ON CHASSIS AND ENGINE.....	95
Closing the filler cap.....	72	Jacking up motorcycle front.....	95
Supporting strap.....	72	Taking front of motorcycle off work stand.....	95
Seat lock .....	73	Jacking up motorcycle rear .....	96
Tool set .....	73	Taking rear of motorcycle off work stand .....	96
Helmet lock .....	74	Fork/shock absorber .....	97
Passenger footrests.....	74	Adjusting compression damping of fork .....	97
Shift lever.....	75	Adjusting rebound damping of fork.....	98
Foot brake pedal .....	76	Adjusting spring preload of fork .....	99
Side stand .....	76	bleeding fork legs.....	100
TIPS ON PUTTING INTO OPERATION .....	77	Compression damping of the shock absorber .....	101
advice on first use .....	77	Adjusting the low-speed compression damping of the	
Running the engine in.....	78	shock absorber .....	101
Loading the vehicle .....	79	Adjusting high-speed compression damping of the shock	
RIDING INSTRUCTIONS .....	81	absorber .....	103
checks to be made before putting into operation.....	81	Adjusting rebound damping of the shock absorber .....	104
Starting.....	82	Adjusting spring preload of shock absorber  .....	104
starting up.....	83	Steering damper.....	107
Shifting, riding.....	84	Adjusting the steering damper .....	107
Braking .....	87	Vehicle level .....	109
Stopping, parking.....	88	Adjusting vehicle level, front  .....	110
Refueling.....	89	Adjusting vehicle level at rear .....	111
		Footrest position.....	113
		Adjusting footrest position.....	113
		Adjusting shift lever stub.....	116

Adjusting shift lever .....	116	Removing passenger seat .....	147
Adjusting the footbrake pedal stub .....	120	Fitting the passenger seat .....	147
Adjusting the footbrake pedal .....	121	Mounting helmet lock on vehicle.....	148
checking for chain dirt .....	121	Removing the battery  .....	148
Cleaning the chain.....	122	Installing the battery  .....	150
Checking the chain tension .....	123	Recharging the battery  .....	151
Adjusting the chain tension .....	124	Changing the main fuse .....	153
Checking rear sprocket / engine sprocket for wear .....	126	Changing fuses of individual power consumers .....	155
Checking chain wear .....	127	Changing the low beam bulb.....	157
Checking chain sliding guard .....	128	Change the high beam bulb.....	160
Checking front brake discs .....	128	Changing the parking light bulb .....	164
Checking rear brake disc .....	129	Checking headlight adjustment.....	167
Adjusting the basic position of the handbrake lever.....	129	Adjusting headlamp range .....	167
Checking brake fluid level of front brake .....	130	Activating/deactivating ignition key .....	168
Topping up brake fluid of front brake  .....	130	Cooling system .....	171
Brake linings.....	132	Checking the coolant level.....	172
Checking the front brake linings.....	132	Filling the cooling system compensating tank.....	173
Checking rear brake fluid level .....	133	Adjusting basic position of clutch lever.....	175
Topping up rear brake fluid  .....	134	Checking fluid level of hydraulic clutch .....	175
Checking the rear brake linings .....	135	Correcting fluid level of hydraulic clutch.....	176
Removing front wheel  .....	136	Adjusting gas Bowden cable  .....	177
Fitting front wheel  .....	137	Handlebar height.....	177
Removing rear wheel  .....	138	Adjusting handlebar height.....	178
fitting the rear wheel  .....	140	Rear frame position .....	179
Checking rear hub shock absorbers  .....	143	Adjusting rear frame position .....	180
Tire condition checking.....	143	Checking engine oil level.....	184
Checking tire air pressure.....	145	Changing engine oil and filter, cleaning oil screen  .....	185
Removing the seat .....	146	Draining engine oil, cleaning oil screens  .....	185
Fitting the seat.....	146	Removing oil filter  .....	188

Fitting oil filter 	190
Filling up with engine oil 	190
Topping up engine oil	192
TROUBLESHOOTING	194
IMMOBILIZER FLASH CODE	197
ENGINE CONTROL FLASH CODE	198
CLEANING	202
Cleaning motorcycle	202
CONSERVATION FOR WINTER OPERATION	204
Conservation for winter operation	204
STORAGE	205
Storage	205
Putting into operation after storage	206
TECHNICAL DATA - ENGINE	207
Capacity - engine oil	208
Capacity - coolant	208
TECHNICAL DATA - ENGINE TIGHTENING TORQUES	209
TECHNICAL DATA - CHASSIS	212
Lighting equipment	213
Capacity - fuel	214
TECHNICAL DATA - FORK	215
TECHNICAL DATA - SHOCK ABSORBER	216
TECHNICAL DATA - CHASSIS TIGHTENING TORQUES	218
SUBSTANCES	221
AUXILIARY SUBSTANCES	224
STANDARDS	226
INDEX	227



## Symbols used

The following explains the meaning of specific symbols.



Identifies an expected reaction (e.g. of an operation or a function).



Identifies an unexpected reaction (e.g. of an operation or a function).



All jobs marked with this symbol require specialist knowledge and technical understanding. In the interests of your own safety, have these jobs done in an authorized KTM-RC8 workshop! There, your motorcycle will be handled optimally by specially trained experts with the necessary special tools.



Identifies a page reference (more information is provided on the specified page).

## Formats used

The type formats used are explained here.

**Specific name**

Identifies a name.

**Name®**

Identifies a protected name.

**Brand™**

Identifies a trademark.

## Use definition

KTM sport motorcycles are designed and constructed to meet the normal demands of regular road and race track operation, but not for use on dirt roads.



### Info

The motorcycle is authorized for public road traffic in the homologous version only.

---

## Maintenance

A prerequisite for fault-free operation and avoiding premature wear is compliance with the maintenance, care and adjustments to the engine and chassis described in the service manual. Poor suspension settings can cause damage and breakage to chassis components. Using the motorcycle in extreme conditions such as racing can lead to above-average wear to components such as the power train or brakes. It may therefore be necessary to service or replace worn parts before the wear limit shown in the greasing and service table is reached.

Pay special attention to the prescribed running-in times, inspection and maintenance intervals. Proper compliance will contribute considerably to a longer service life of your motorcycle.

## Warranty

The maintenance work described in the greasing and service table must be carried out exclusively in an authorized KTM-RC8 workshop and confirmed in the service record, since otherwise any warranty claim is meaningless. No warranty claim can be met for damage resulting from manipulation and/or other changes to the vehicle.

## Materials

The fuels and lubricants named in the owner's manual must be used according to specifications.

## Spare parts, accessories

In the interests of your own safety, use only spare parts and accessories approved and/or recommended by KTM, and have these fitted in an authorized KTM-RC8 workshop. KTM accepts no liability for other products and any resulting damage.

You will find the current **KTM PowerParts** for your vehicle on the KTM website.  
International KTM Website: <http://www.ktm.com>

## Work rules

During assembly, non-reusable parts (e.g. self-locking screws and nuts, seals and seal rings, O-rings, pins, lock washers) must be replaced by new parts.

If a thread lock (e.g. **Loctite**®) is used for screw connections, be sure to comply with the manufacturer's specific advice on its usage. Parts that you want to reuse following repairs and servicing should be cleaned and checked for damage and wear. Change damaged or worn parts.

Following servicing, the vehicle must be checked for roadworthiness.

## Transport

### Note

**Danger of damage** Danger of damage by the vehicle running away or falling over.

- Always place the vehicle on a firm and even surface.

### Note

**Fire hazard** Some components (engine, radiator and exhaust system) get very hot when the engine is running.

- Do not place the vehicle where there are flammable or explosive substances.

- Switch off the engine and remove the ignition key.
- Secure the motorcycle against falling over or running away using straps or other suitable devices.

## Environment

Motorcycling is a wonderful sport and we naturally hope that you can enjoy it to the full. However, it can also lead to problems with the environment and conflict with other persons. Responsible behavior in handling the motorcycle can help to avoid such problems and conflicts. To ensure the future of motorcycle sport, make sure you use the motorcycle legally, demonstrate a consciousness for the environment, and respect the rights of others.

## notes/warnings

Be sure to pay attention to the notes and warnings given here.



### Info

Various notes and warning stickers are attached to the vehicle. Do not remove any notes and warning stickers. If these are removed, you or other persons may not recognize potential danger and therefore be liable to injury.

## Grades of risks



### Danger

Danger of leading to immediate, certain, serious, permanent injuries or death.



### Warning

Danger of probable, serious, permanent injuries or death.

### Note

Danger of considerable engine or material damage.



### Warning

Danger of environmental damage.

## Operating instructions

- Be sure to read these operating instructions carefully and completely before taking your first ride. They contain much information and tips that will help you to operate and handle your motorcycle. Only in this way will you find out how to adjust the motorcycle best for your own use and how to protect yourself from injury. These operating instructions also contain important information about servicing the motorcycle.
- The service manual is an important component of the motorcycle and should be passed on to the new owner if the bike is sold.



## View of vehicle, front left side



---

1	Clutch lever
2	Light switch, headlight flasher switch, indicator switch, horn button
3	Filler cap
4	Seat
5	Seat lock
6	Oil dipstick
7	Side stand
8	Shift lever
9	Passenger footrests

---

## View of vehicle, rear right side

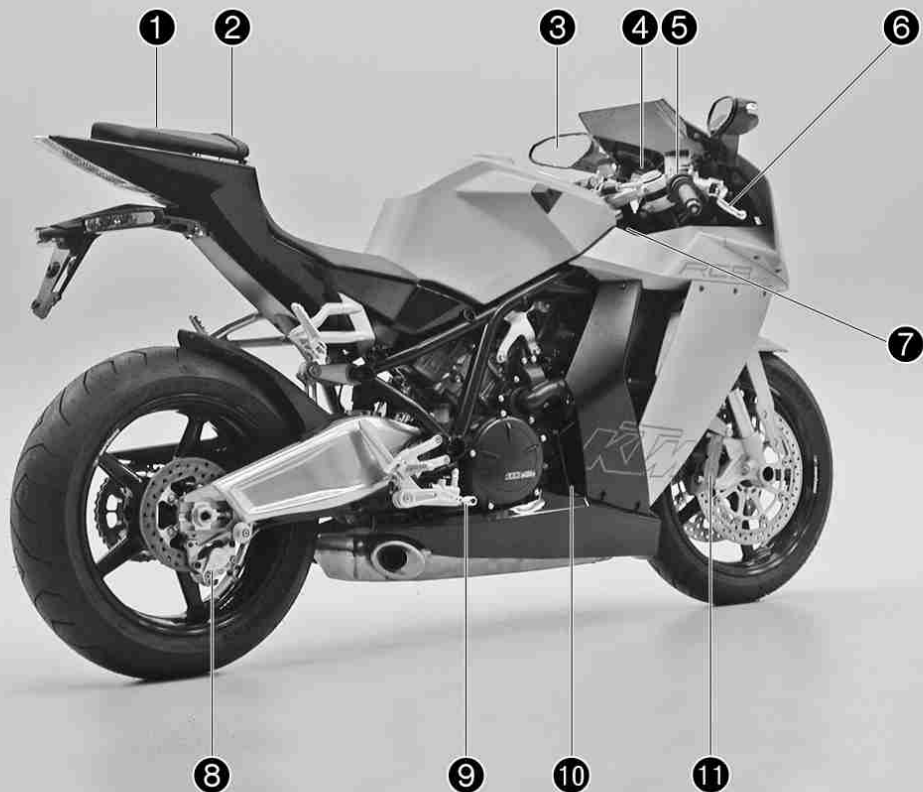



---

1	Passenger seat
2	Supporting strap
3	Rear mirror
4	Combination instrument
5	Emergency OFF switch, electric starter button
6	Hand brake lever
7	Chassis number, type label
8	Rear brake caliper
9	Foot brake pedal
10	Engine number
11	Brake calipers, front

---

## Chassis number/type label

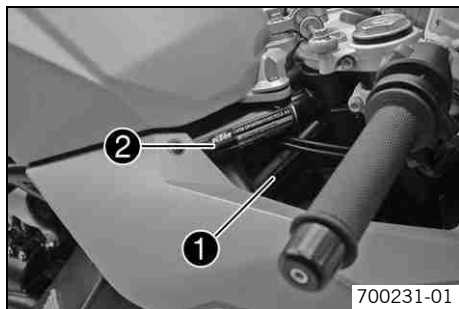

The chassis number **1** is stamped on the frame behind the steering head on the right. The type label **2** is on the frame above the chassis number.

## Key number

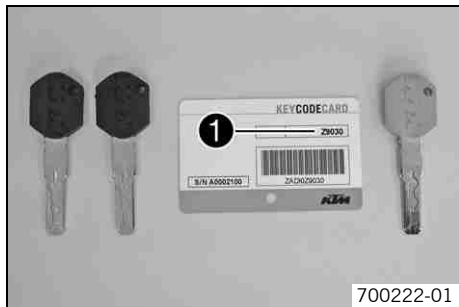

The key number **Code number 1** can be found on the **KEYCODECARD**.



### Info

You need the key number to order a spare key. Keep the **KEYCODECARD** in a safe place.

Use the orange programming key to activate and deactivate the black ignition key. Keep the orange programming key in a safe place: it must only be used for learning and programming functions.

## Engine number

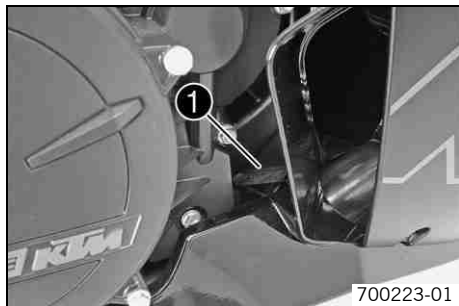

The engine number ❶ is stamped on the right side of the engine.

## Fork part number

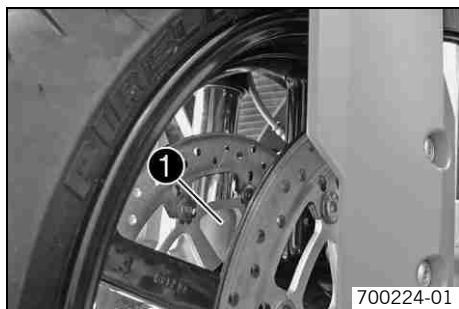

The fork part number ❶ is stamped on the inner side of the fork stub.

## Shock absorber part number

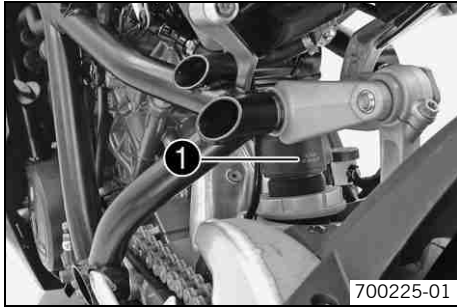

700225-01

The shock absorber part number ❶ is stamped on the upper part of the shock absorber above the adjusting ring towards the rear.

## Steering damper part number

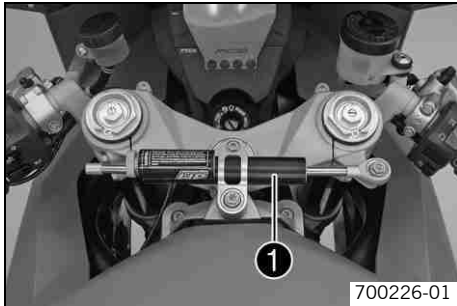

700226-01

The steering damper part number ❶ is stamped on the top of the steering damper.

## Clutch lever

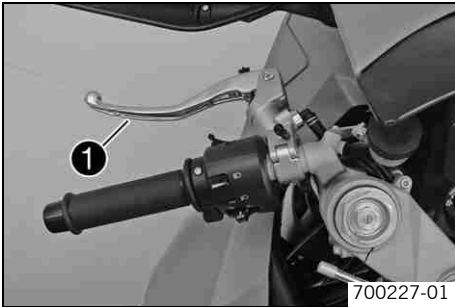

The clutch lever ❶ is fitted on the left side of the handlebar.  
The clutch is hydraulic and self-adjusting.

## Hand brake lever

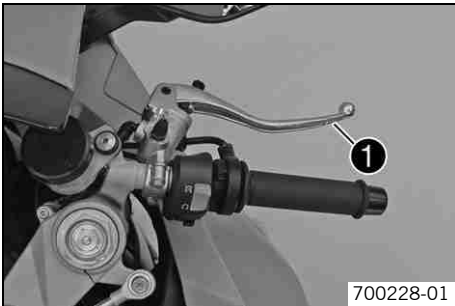

The handbrake lever ❶ is fitted on the right side of the handlebar.  
The hand brake lever operates the front brake.

## Light switch

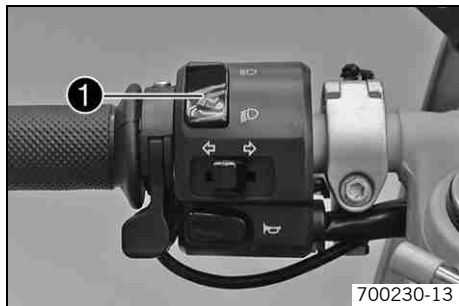

The light switch ❶ is fitted on the left side of the handlebar.

### Possible states



Low beam on – Light switch is turned downwards. In this position, the low beam and tail light are switched on.



High beam on – Light switch is turned upwards. In this position, the low beam, the high beam and the tail light are switched on.

## Headlight flasher switch

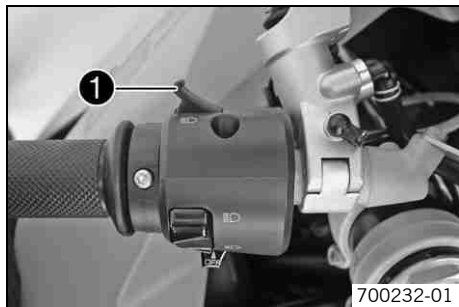

The headlight flasher switch ❶ is fitted on the left side of the handlebar.

### Possible states

- Headlight flasher switch in neutral position
- Headlight flasher switch pressed – The headlight flasher switch (high beam) is operated in this position.

## Flasher switch



The flasher switch ❶ is fitted on the left side of the handlebar.

### Possible states

Flasher light off



Flasher light, left, on – Flasher switch pressed to the right. The flasher switch returns automatically to the central position after use.



Flasher light, right, on – Flasher switch pressed to the left. The flasher switch returns automatically to the central position after use.



To switch off the flasher light, press the flasher switch towards the switch case.

## Horn button



The horn button ❶ is fitted on the left side of the handlebar.

### Possible states

- Horn button  in neutral position
- Horn button  pressed – The horn is operated in this position.

## Ignition/steering lock

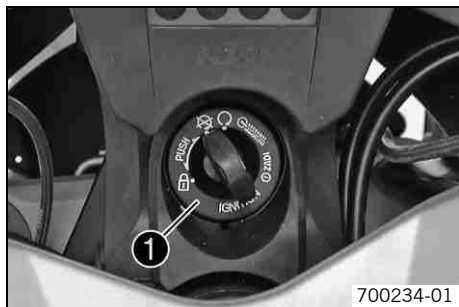

The ignition/steering lock ❶ is located in front of the upper triple clamp.

### Possible states



Ignition off – In this position, the ignition circuit is interrupted, a running engine stops, and a non-running engine will not start. The black ignition key can be removed.



Ignition on – In this position, the ignition circuit is closed, and the engine can be started.



Steering locked – In this position, the ignition circuit is interrupted and the steering locked. The black ignition key can be removed.

## Emergency OFF switch



The emergency OFF switch ❶ is fitted on the right side of the handlebar.

### Possible states



Emergency OFF switch on – This position is necessary for operation, the ignition circuit is closed.



Emergency OFF switch off – In this position, the ignition circuit is interrupted, a running engine stops, and a non-running engine cannot be started.



## Electric starter button

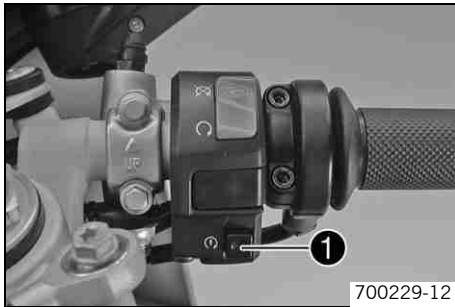

The electric starter button ❶ is fitted on the right side of the handlebar.

### Possible states

- Electric starter button ❸ in neutral position
- Electric starter button ❸ pressed – In this position, the electric starter is operated.

## Combination instrument - overview

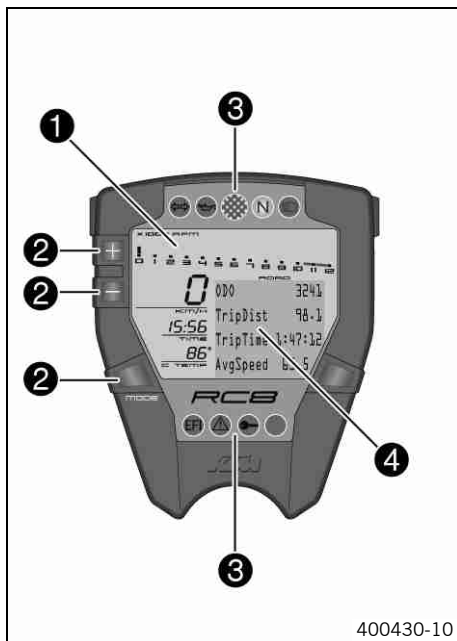

- |   |                           |
|---|---------------------------|
| 1 | display (☛ S. 27)         |
| 2 | Function buttons          |
| 3 | Indicator lamps (☛ S. 29) |
| 4 | info display (☛ S. 28)    |

## Combination instrument - function buttons on handlebar

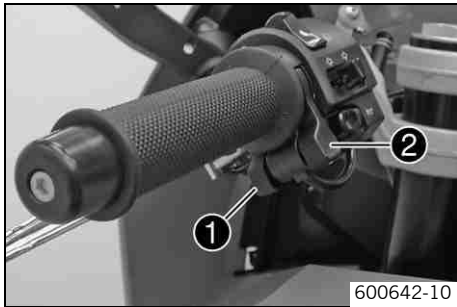

The **Mode** button ❶ is fitted on the handlebar, front left.

The **Lap** button ❷ is fitted on the handlebar, rear left.

## Combination instrument - activation and test



### Activation

The combination instrument is activated when the ignition is switched on.

### Test

The segments of the tachometer light up in and switch off in sequence.

The speed display counts from 0 to 300 and back.

The remaining display segments outside the info display light up briefly.

The **KTM** logo appears in the info display.

In **ROAD** mode, the info display switches to **ODO**, **TripDist**, **TripTime**, **AvgSpeed** mode.

In **RACE** mode, the info display switches to **LAPSTOGO**, **LastLap**, **±Last**, **±Best** mode.

## display

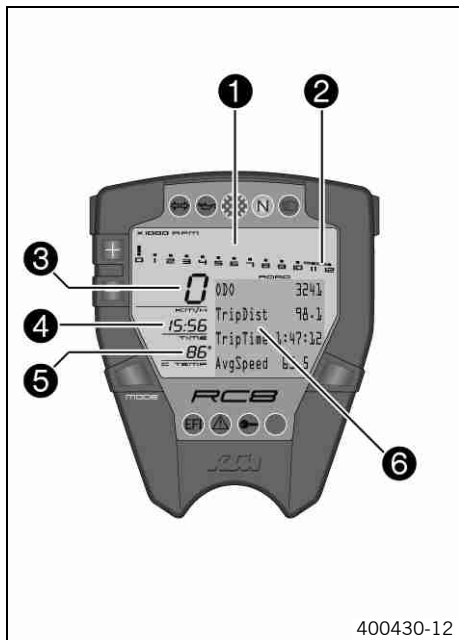

The tachometer **1** displays the engine speed in revolutions per minute (RPM).  
 The red marking **2** marks the over-rev (excessive speed) range of the engine.  
 The speed **3** is displayed in kilometers per hour **km/h** or in miles per hour **Mph**.  
 The time appears in segment **4**.



### Info

After reconnecting the battery or changing the fuse, the time must be reset.

The coolant temperature is shown in degrees Celsius or Fahrenheit in segment **5**.  
 The info display **6** shows additional information.

## info display

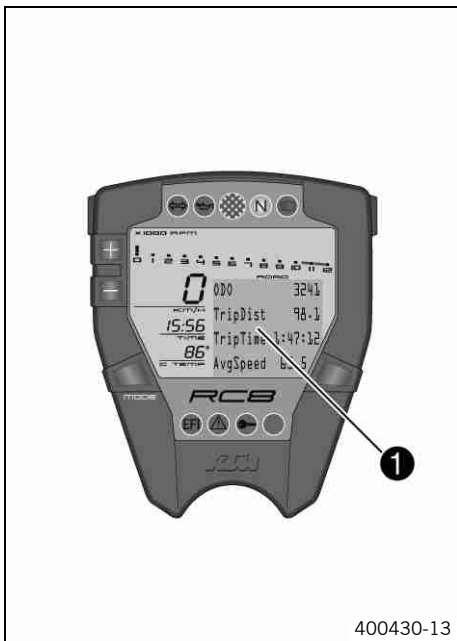

The info display ❶ has two menus.

Menu 1 is **ROAD** mode (standard) for riding on public roads.

Menu 2 is **RACE** mode for riding on race courses. It allows riders to time laps themselves.

If the general warning lamp  lights up, the corresponding message is shown periodically in the info display.

Information repeat	45 s
--------------------	------

The information shown in the info display can be controlled with the function buttons.

## Indicator lamps

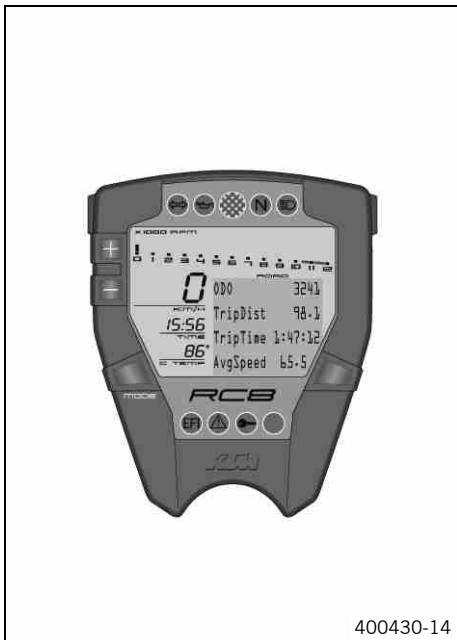

### Possible states



The flasher indicator lamp flashes green in same rhythm as the flasher.  
– The flasher is switched on.



The oil indicator lamp lights up red – The oil pressure is too low.



The shift warning light shows/flashes red – The set shift speed is reached.



The idling speed indicator lamp lights up green – The gearbox is in neutral.



The high beam indicator lamp lights up blue – The high beam is on.



**EFI** warning lamp (**MIL**) lights up / flashes red – The OBD has detected an emission- or safety-critical error.



The general warning light shows green – An operating safety (warning) message was detected. This is also shown periodically in the info display.



The immobilizer indicator lamp lights up or flashes red – Status or error message for immobilizer / alarm system.

## Notes/warnings on the combination instrument

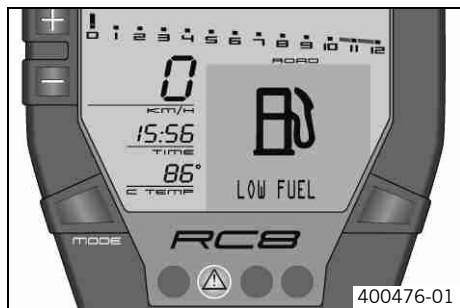

**LOW FUEL** appears on the info display if the minimum range falls below the specified value.

Distance	25 km (15.5 mi)
----------	-----------------

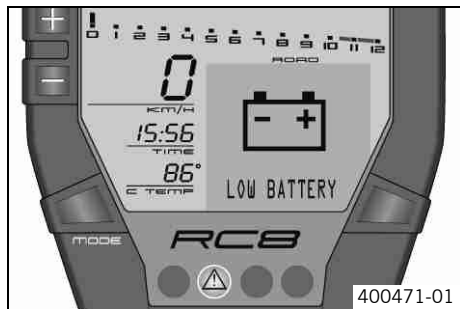

**LOW BATTERY** appears on the info display if the battery voltage falls below the specified value.

Battery voltage	10.80 V
-----------------	---------



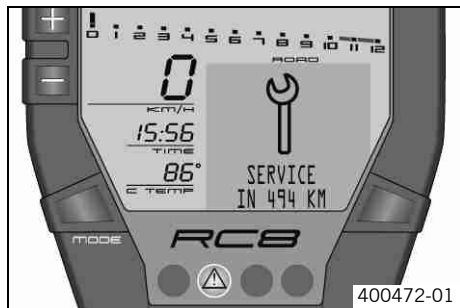

**SERVICE IN xxx KM(MPH)** appears on the info display if the distance to the next service falls below the specified value.

Distance	500 km (310.7 mi)
----------	-------------------

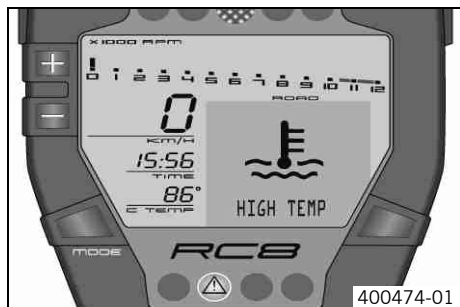

**HIGH TEMP** appears on the info display if the coolant temperature rises above the specified value.

Coolant temperature	120 °C (248 °F)
---------------------	-----------------

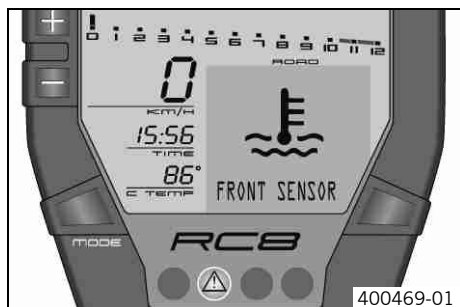

**FRONT SENSOR** appears on the info display if the coolant temperature sensor of the front cylinder is defective.

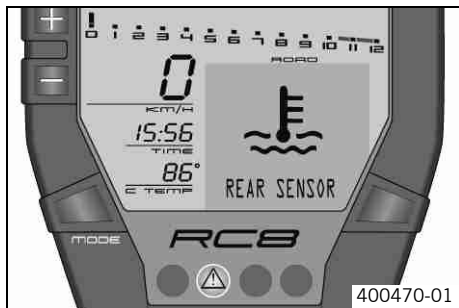

**REAR SENSOR** appears on the info display if the coolant temperature sensor of the rear cylinder is defective.

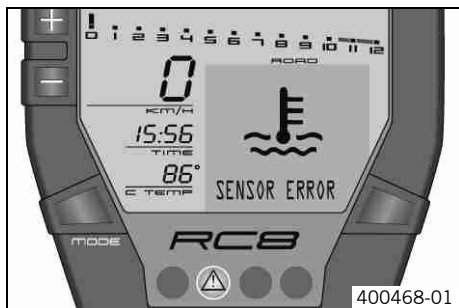

**SENSOR ERROR** appears on the info display if the coolant temperature between the coolant temperature sensors of the front and rear cylinders differs by more than the specified value.

Coolant temperature	10 °C (50 °F)
---------------------	---------------

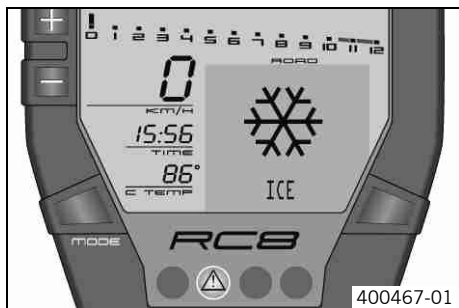

**ICE** appears on the info display if the external temperature falls below the specified value.

Temperature	3 °C (37 °F)
-------------	--------------

**ICE** switches off on the info display if the external temperature rises above the specified value.

Temperature	4 °C (39 °F)
-------------	--------------

## ODO menu

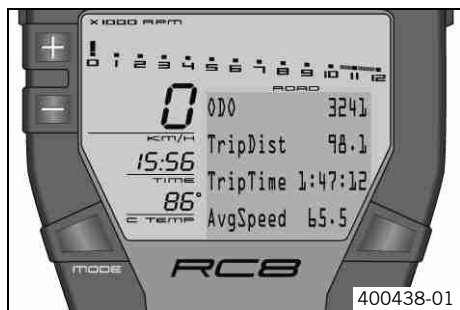

### Condition

- The ignition is on.
- **ROAD** mode
- Press the **MODE** button briefly and repeatedly until **ODO** appears at the top left of the info display.

**ODO** shows the total distance covered.

**TripDist** shows the distance covered since the last reset. For example, between two refueling stops. **TripDist** is always running and counts up to **999.9**.



**TripTime** shows the journey time on the basis of **TripDist** and resumes running as soon as a speed signal is received.

The calculation of this value starts with the first speed signal and ends 3 seconds after the last speed signal.

**AvgSpeed** (average speed) is coupled with **TripDist** and **TripTime**.

Press the button  no function

Press the button  no function

Press the button  The display changes to the **SET-UP** menu and the button  for 3 - 5 seconds.

Press the **MODE** button for 3 - 5 seconds. The display of **TripDist**, **TripTime** and **AvgSpeed** is reset

Press the **MODE** button briefly. Next display mode

## FUELDISTANCE menu

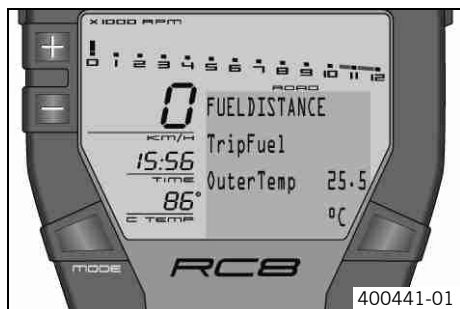

### Condition

- The ignition is on.
- **ROAD** mode
- Press the **MODE** button briefly and repeatedly until **FUELDISTANCE** appears at the top of the info display.

**TripFuel** shows the distance covered since the fuel reserve level was reached.



### Info

This is displayed only after you reach the fuel reserve level.

**OuterTemp** shows the external temperature.

The external temperature can be switched on and off in the **SET-UP** menu.

Press the button . no function

Press the button . no function

Press the button and the button for 3 - 5 seconds. The display changes to the **SET-UP** menu

Press the button . no function

Press the **MODE** button for 3 - 5 seconds.

Press the button . Next display mode

Press the **MODE** button briefly.

## FUELRANGE menu

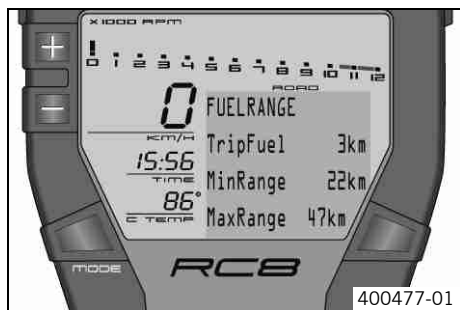

### Condition

- The ignition is on.
- **ROAD** mode
- Press the **MODE** button briefly and repeatedly until **FUELRANGE** appears at the top of the info display.

**TripFuel** shows the distance covered since the fuel reserve level was reached.



### Info

This is displayed only after you reach the fuel reserve level.



**MinRange** shows the minimum range you can cover with the fuel reserve.

**MaxRange** shows the maximum range you can cover with the fuel reserve.

The possible range of the fuel reserve depends on your riding style.

Press the button . no function

Press the button . no function

Press the button . The display changes to the **SET-UP** menu and the button  for 3 - 5 seconds.

Press the . no function

Press the **MODE** button for 3 - 5 seconds.

Press the . Next display mode

Press the **MODE** button briefly.

## DISTANCE TO Next Service menu

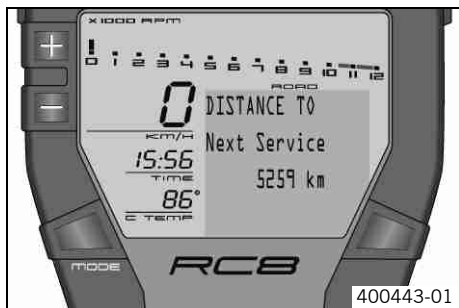

### Condition

- The ignition is on.
- The motorcycle is standing.
- **ROAD** mode
- Press the **MODE** button briefly and repeatedly until **DISTANCE TO Next Service** appears in the info display.

**DISTANCE TO Next Service** shows the distance before the next service is necessary.

Press the button . no function

Press the button . no function

Press the button and the button for 3 - 5 seconds.

Press the button . no function

Press the **MODE** button for 3 - 5 seconds.

Press the button . Next display mode

Press the **MODE** button briefly.

## LAPSTOGO menu

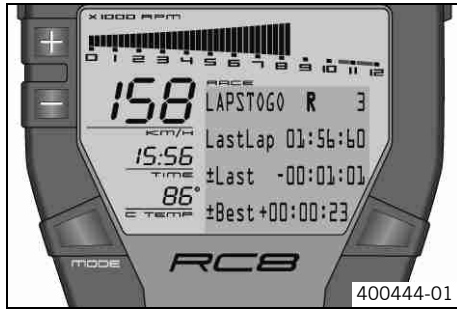

### Condition

- The ignition is on.
- **RACE** mode
- Press the **MODE** button briefly and repeatedly until **LAPSTOGO** appears at the top left of the info display.

**LAPSTOGO** shows the number of remaining laps.

If an **R** appears after **LAPSTOGO**, the stopwatch is running in the background.

If a **P** appears after **LAPSTOGO**, the stopwatch in the background is active but waiting for a speed signal. The time is not running.

This function is controlled by the button "**LAP**".

**LastLap** shows the lap time of the last round.

**±Last** shows the difference between the last lap and the lap before last.

**±Best** shows the difference between the last lap and the best lap.

If the last lap was the fastest, you see behind **±Best**: the **Best!** symbol in the info display.

Press the button . no function

Press the button . no function

Press the button and the button for 3 - 5 seconds.

Press the **MODE** button for 3 - 5 seconds. All values in **RACE** mode are reset (except **RACEODO**)

Press the **MODE** button briefly. Next display mode

## TOPSPEED menu

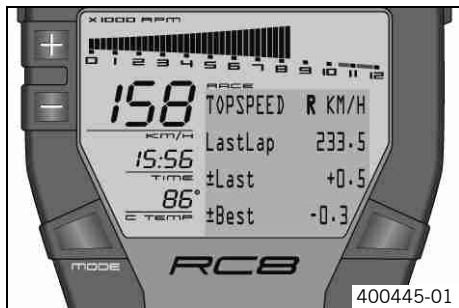

### Condition

- The ignition is on.
- **RACE** mode
- Press the **MODE** button briefly and repeatedly until **TOPSPEED** appears at the top left of the info display.

If an **R** appears after **TOPSPEED**, the stopwatch is running in the background.  
 If a **P** appears after **TOPSPEED**, the stopwatch is not running in the background.  
 This function is controlled by the button "**LAP**".

**TOPSPEED** shows the highest lap speed.

**LastLap** shows the maximum speed of the last round.

**±Last** shows the maximum speed difference between the last lap and the lap before.

**±Best** shows the maximum speed difference between the last lap and the highest maximum speed.

If the last lap was the lap with the highest maximum speed, the info display shows **±Best:**

**Best!**

Press the button . no function

Press the button . no function

Press the button The display changes to the **SET-UP** menu and the button for 3 - 5 seconds.

Press the **MODE** button for 3 - 5 seconds. The display of **LastLap**, **±Last** and **±Best** are set to **0**

Press the **MODE** button briefly. Next display mode



## LAP/BESTLAP/LastLap menu

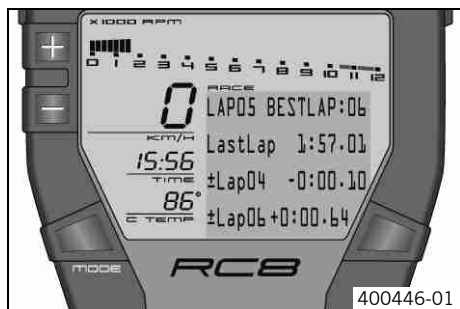

### Condition

- The ignition is on.
- The motorcycle is standing.
- **RACE** mode
- Press the **MODE** button briefly and repeatedly until **LAP/BESTLAP/LastLap** appears in the info display.

**LAP** shows the selected lap.

**BESTLAP** shows the number of the lap with the best lap time.



**LastLap** shows the time of the lap behind **LAP**.

**±Lap** shows the difference to the lap before.

**±Lap** shows the difference to the lap after.

Press the  button. The next lap is displayed

Press the  button. The previous lap is displayed

Press the  button. The display changes to the **SET-UP** menu and the  button for 3 - 5 seconds.

Press the **MODE** button for 3 - 5 seconds. All values in **RACE** mode are reset (except **RACEODO**)

Press the **MODE** button briefly. Next display mode

## LAP/BESTLAP/TopSpeed menu

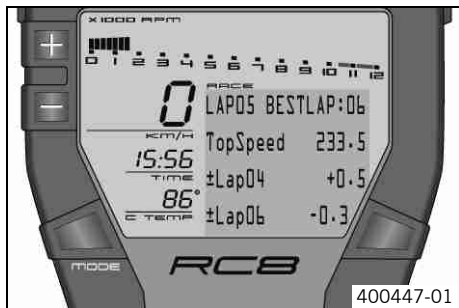

### Condition

- The ignition is on.
- The motorcycle is standing.
- **RACE** mode
- Press the **MODE** button briefly and repeatedly until **LAP/BESTLAP/TopSpeed** appears in the info display.

**LAP** shows the selected lap.

**BESTLAP** shows the lap in which the highest maximum speed was reached.



**TopSpeed** shows maximum speed of the lap behind **LAP**.

**±Lap** shows the difference to the lap before.

**±Lap** shows the difference to the lap after.

Press the  button. The next lap is displayed

Press the  button. The previous lap is displayed

Press the  button. The display changes to the **SET-UP** menu and the  button for 3 - 5 seconds.

Press the **MODE** button for 3 - 5 seconds. All values in **RACE** mode are reset (except **RACEODO**)

Press the **MODE** button briefly. Next display mode

## Total distance menu in Race mode RACEODO

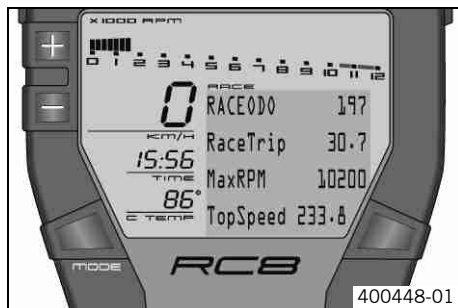

### Condition

- The ignition is on.
- The motorcycle is standing.
- **RACE** mode
- Press the **MODE** button briefly and repeatedly until **RACEODO** appears at the top of the info display.

**RACEODO** shows the total distance covered in **RACE** mode.



**RaceTrip** shows the distance covered since the last reset. For example, between two refueling stops. **RaceTrip** is always running and counts up to **999.9**.

**MaxRPM** shows the highest engine speed reached during the **RaceTrip**.

**TopSpeed** shows the highest speed reached during the **RaceTrip**.

Press the button . no function

Press the button . no function

Press the button  The display changes to the **SET-UP** menu and the button  for 3 - 5 seconds.



Press the **MODE** button for 3 - 5 seconds. All values in **RACE** mode are reset (except **RACEODO**)

Press the **MODE** button briefly. Next display mode

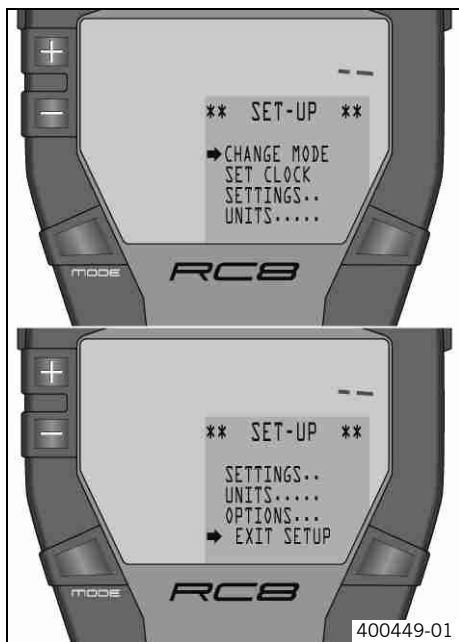
## SET-UP menu



### Condition

- The ignition is on.
- The motorcycle is standing.
- Press the button  and the button  for 3 - 5 seconds.

On the **CHANGE MODE** menu, you can select between **ROAD** and **RACE** mode. You can set the clock on the **SET CLOCK** menu.





On the **SETTINGS** menu, you can set the shift warning light, the lap blank time of the **LAP** button, the number of laps, and the reset time of the fuel reserve display.

On the **UNITS** menu, you can set the units for measuring speed, distance, and temperature.

On the **OPTIONS** menu, you can switch the tire pressure check and external temperature display on/off (available as accessories).

Select **EXIT SETUP** to close the **SET-UP** menu.

The symbol  shows which menu you can activate with the button "**MODE**".

- Press the button . The arrow moves up
- Press the button . The arrow moves down
- Press the button  no function
- and the button  for 3 - 5 seconds.



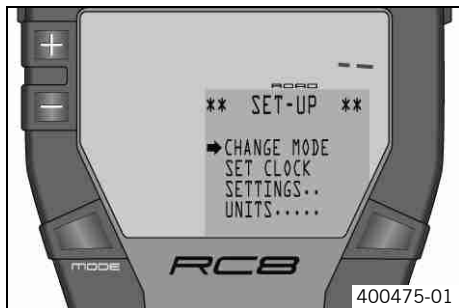

Press the **MODE** button for 3 - 5 seconds. The menu in front of the arrow is selected

Press the **MODE** button briefly. The menu in front of the arrow is selected

## CHANGE MODE menu



### Condition

- The ignition is on.
- The motorcycle is standing.
- Press the button  and the button  for 3 - 5 seconds.
- Press the button  or the button  briefly and repeatedly until the symbol  is on **CHANGE MODE** in the info display.

On the **CHANGE MODE** menu, you can select between **ROAD** and **RACE** mode.

Press the button . Changes the menu

Press the button . Changes the menu

Press the button  no function

and the button  for 3 - 5 seconds.



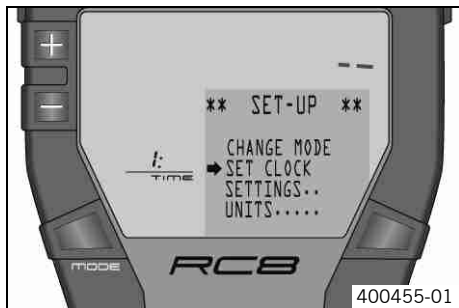

Press the **MODE** button for 3 - 5 seconds. Opening and exiting **CHANGE MODE**

Press the **MODE** button briefly. Opening and exiting **CHANGE MODE**

## SET CLOCK menu



### Condition

- The ignition is on.
- The motorcycle is standing.
- Press the  and the  for 3 - 5 seconds.
- Press the  once until the symbol  is on **SET CLOCK** in the info display.

You can set the clock on the **SET CLOCK** menu.

Press the . increases the value

Press the . reduces the value

Press the  no function

and the  for

3 - 5 seconds.

Press the  Open and exit **SET CLOCK** or change to next value

**MODE** button for 3 - 5

seconds.



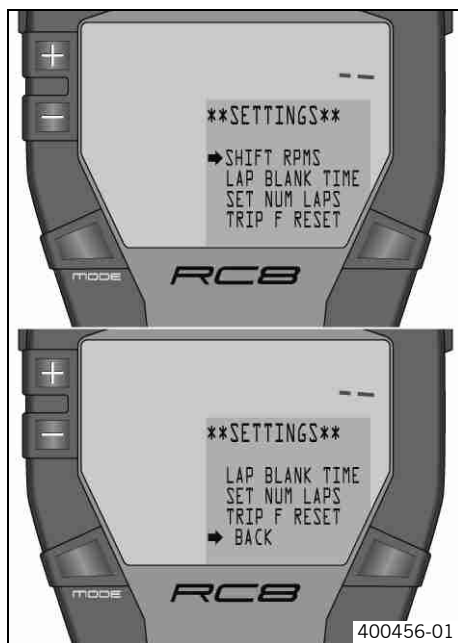

Press the  Open and exit **SET CLOCK** or change to next value

**MODE** button briefly.

## SETTINGS menu



### Condition

- The ignition is on.
- The motorcycle is standing.
- Press the button  and the button  for 3 - 5 seconds.
- Press the button  twice until the symbol  is on **SETTINGS** in the info display.

On the **SHIFT RPMS** menu, you can activate the shift warning light.

On the **LAP BLANK TIME** menu, you set the lap blank time of the **LAP** button.

On the **SET NUM LAPS** menu, you set the number of laps to cover in **RACE** mode.

On the **TRIP F RESET** menu, you set the reaction time of the fuel reserve display to changes of the fuel level.

On the **S.LEARN TPMS** menu, only a KTM-RC8 workshop can make changes.

On the **BACK...** menu, you switch back to the **SET-UP** menu.

The symbol  shows which menu you can activate with the button "**MODE**".

Press the button . The arrow moves up

Press the button . The arrow moves down

Press the button  no function

and the button  for 3 - 5 seconds.

Press the  The menu in front of the arrow is selected





**MODE** button for 3 - 5 seconds.

Press the  The menu in front of the arrow is selected  
**MODE** button briefly.

## SHIFT RPMS menu



### Condition

- The ignition is on.
- The motorcycle is standing.
- Press the  and the  for 3 - 5 seconds.
- Press the  twice until the  is on **SETTINGS** in the info display.
- Press the **MODE** button briefly.

On the **SHIFT RPMS** menu, you can activate the shift warning light.

Press the . increases the value

Press the . reduces the value

Press the  no function

and the  for 3 - 5 seconds.

Press the **MODE** button for 3 - 5 seconds. Open and exit **SHIFT RPMS** or change to next value







Press the **MODE** button briefly. Open and exit **SHIFT RPMS** or change to next value



## LAP menu, LAP BLANK T button



### Condition

- The ignition is on.
- The motorcycle is standing.
- Press the  and the  for 3 - 5 seconds.
- Press the  twice until the  is on **SETTINGS** in the info display.
- Press the  once until the  is on **LAP BLANK T** in the info display.

On the **LAP BLANK T** menu, you set the lap blank time of the **LAP** button.

Press the . increases the value

Press the . reduces the value

Press the  no function

and the  for 3 - 5 seconds.

Press the  Open and exit **LAP BLANK T**

**MODE** button for 3 - 5 seconds.





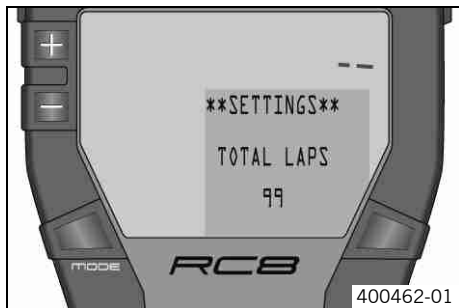

Press the  Open and exit **LAP BLANK T**

**MODE** button briefly.

## SET NUM LAPS menu



### Condition

- The ignition is on.
- The motorcycle is standing.
- Press the button  and the button  for 3 - 5 seconds.
- Press the button  twice until the symbol  is on **SETTINGS** in the info display.
- Press the button  twice until the symbol  is on **SET NUM LAPS** in the info display.

On the **SET NUM LAPS** menu, you set the number of laps to cover in **RACE** mode.

Press the button . increases the value

Press the button . reduces the value

Press the button  no function

and the button  for 3 - 5 seconds.

Press the **MODE** button for 3 - 5 seconds. Open and exit **SET NUM LAPS**

Press the **MODE** button for 3 - 5 seconds.

Press the **MODE** button briefly. Open and exit **SET NUM LAPS**

Press the **MODE** button briefly.

## TRIP F RESET menu



### Condition

- The ignition is on.
- The motorcycle is standing.
- Press the button and the button for 3 - 5 seconds.
- Press the button twice until the symbol is on **SETTINGS** in the info display.
- Press the button three times until the symbol is on **TRIP F RESET** in the info display.

On the **TRIP F RESET** menu, you set the reaction time of the fuel reserve display to changes of the fuel level.

Press the button . increases the value

Press the button . reduces the value

Press the button no function

and the button for 3 - 5 seconds.



Press the **MODE** button for 3 - 5 seconds. Open and exit **TRIP F RESET**

Press the **MODE** button briefly. Open and exit **TRIP F RESET**

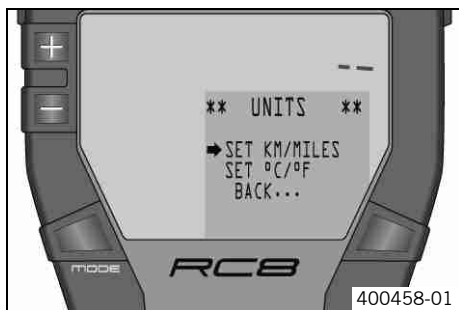
## UNITS menu



### Condition

- The ignition is on.
- The motorcycle is standing.
- Press the  and the  for 3 - 5 seconds.
- Press the  three times until the  is on **UNITS** in the info display.

On the **SET KM/MILES** menu, you can set the units for measuring speed and distance.

On the **SET °C/°F** menu, you set the unit for the temperature display.

On the **BACK...** menu, you switch back to the **SET-UP** menu.

The  shows which menu you can activate with the button "**MODE**".

Press the . The arrow moves up

Press the . The arrow moves down

Press the  no function

and the  for

3 - 5 seconds.

Press the . The menu in front of the arrow is selected

**MODE** button for 3 - 5

seconds.

Press the . The menu in front of the arrow is selected

**MODE** button briefly.

## SET KM/MILES menu

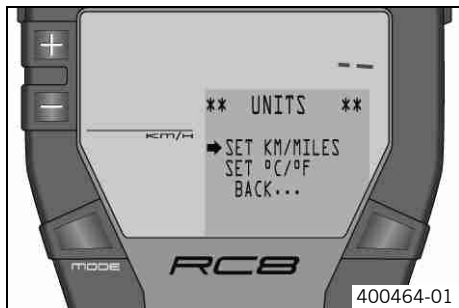

### Condition

- The ignition is on.
- The motorcycle is standing.
- Press the button and the button for 3 - 5 seconds.
- Press the button three times until the symbol is on **UNITS** in the info display.
- Press the button or the button briefly and repeatedly until the symbol is on **SET KM/MILES** in the info display.

On the **SET KM/MILES** menu, you can set the units for measuring speed and distance.

Press the button . Changes the unit

Press the button . Changes the unit

Press the button no function

and the button for

3 - 5 seconds.

Press the Open and exit **SET KM/MILES**

**MODE** button for 3 - 5

seconds.





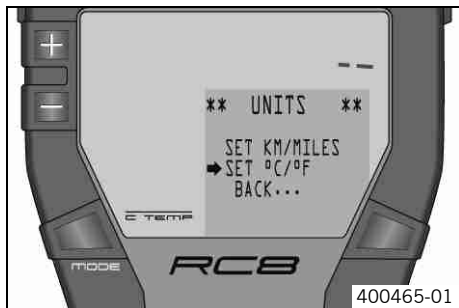

Press the Open and exit **SET KM/MILES**

**MODE** button briefly.

## SET °C/°F menu



### Condition

- The ignition is on.
- The motorcycle is standing.
- Press the button  and the button  for 3 - 5 seconds.
- Press the button  three times until the symbol  is on **UNITS** in the info display.
- Press the button  once until the symbol  is on **SET °C/°F** in the info display.

On the **SET °C/°F** menu, you set the unit for the temperature display.

Press the button . Changes the unit

Press the button . Changes the unit

Press the button  no function

and the button  for 3 - 5 seconds.

Press the **MODE** button for 3 - 5 seconds. Open and exit **SET °C/°F**

Press the **MODE** button for 3 - 5 seconds.



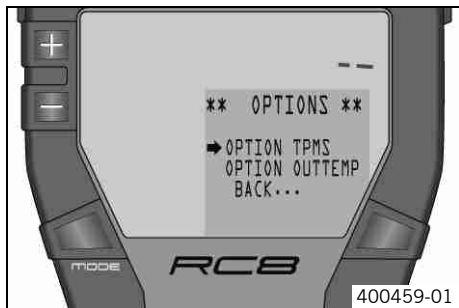

Press the **MODE** button briefly. Open and exit **SET °C/°F**

Press the **MODE** button briefly.

## OPTIONS menu



### Condition

- The ignition is on.
- The motorcycle is standing.
- Press the  and the  for 3 - 5 seconds.
- Press the  four times until the symbol  is on **OPTIONS** in the info display.

On the **OPTION TPMS** menu, you can switch the tire pressure check on/off (available as accessory).

On the **OPTION OUTTEMP** menu, you switch the external temperature display on/off.

On the **BACK...** menu, you switch back to the **SET-UP** menu.

The symbol  shows which menu you can activate with the button "**MODE**".

Press the . The arrow moves up

Press the . The arrow moves down

Press the  no function

and the  for 3 - 5 seconds.

Press the **MODE** button for 3 - 5 seconds. The menu in front of the arrow is selected

Press the **MODE** button briefly. The menu in front of the arrow is selected

## TPMS menu

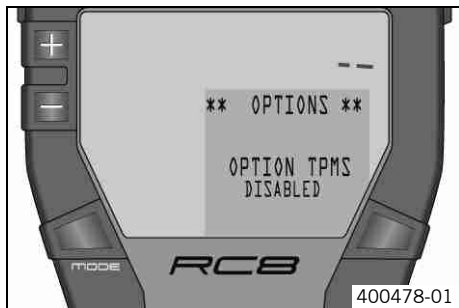

### Condition

- The ignition is on.
- The motorcycle is standing.
- Press the and the for 3 - 5 seconds.
- Press the four times until the symbol is on **OPTIONS** in the info display.
- Press the **MODE** button briefly.

On the **OPTION TPMS** menu, you can switch the tire pressure check on/off (available as accessory).

Press the . Switches the tire pressure display on/off

Press the . Switches the tire pressure display on/off

Press the no function

and the for

3 - 5 seconds.

Press the Open and exit **OPTION TPMS**

**MODE** button for 3 - 5

seconds.

Press the Open and exit **OPTION TPMS**

**MODE** button briefly.



## OPTION OUTERTEMP menu

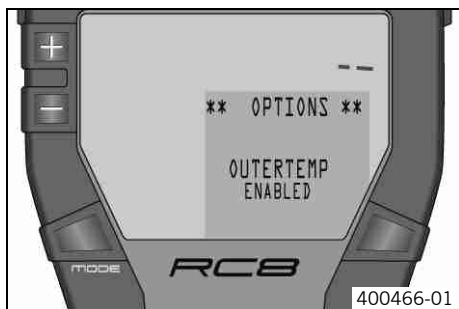

### Condition

- The ignition is on.
- The motorcycle is standing.
- Press the button and the button for 3 - 5 seconds.
- Press the button four times until the symbol is on **OPTIONS** in the info display.
- Press the button once until the symbol is on **OPTIONS OUTERTEMP** in the info display.

On the **OPTION OUTERTEMP** menu, you switch the external temperature display on/off.

Press the button . Switches the external temperature display on/off

Press the button . Switches the external temperature display on/off

Press the button no function

and the button for

3 - 5 seconds.

Press the button. Open and exit **OPTION OUTERTEMP**

**MODE** button for 3 - 5

seconds.

Press the button. Open and exit **OPTION OUTERTEMP**

**MODE** button briefly.

### Table of functions

Display	Press the button .	Press the button .	Press the button  and the button  for 3 - 5 seconds.	Press the <b>MODE</b> button for 3 - 5 seconds.	Press the <b>MODE</b> button briefly.
<b>ODO</b> menu	no function	no function	The display changes to the <b>SET-UP</b> menu	The display of <b>TripDist</b> , <b>TripTime</b> and <b>AvgSpeed</b> is reset	Next display mode





Table of functions					
Display	Press the button  .	Press the button  .	Press the button  and the button  for 3 - 5 seconds.	Press the <b>MODE</b> button for 3 - 5 seconds.	Press the <b>MODE</b> button briefly.
<b>FUELDISTANCE</b> menu	no function	no function	The display changes to the <b>SET-UP</b> menu	no function	Next display mode
<b>FUELRANGE</b> menu	no function	no function	The display changes to the <b>SET-UP</b> menu	no function	Next display mode
<b>DISTANCE TO Next Service</b> menu	no function	no function	The display changes to the <b>SET-UP</b> menu	no function	Next display mode
<b>LAPSTOGO</b> menu	no function	no function	The display changes to the <b>SET-UP</b> menu	All values in <b>RACE</b> mode are reset (except <b>RACEODO</b> )	Next display mode
<b>TOPSPEED</b> menu	no function	no function	The display changes to the <b>SET-UP</b> menu	The display of <b>Last-Lap</b> , <b>±Last</b> and <b>±Best</b> are set to <b>0</b>	Next display mode
<b>LAP/BESTLAP/Last-Lap</b> menu	The next lap is displayed	The previous lap is displayed	The display changes to the <b>SET-UP</b> menu	All values in <b>RACE</b> mode are reset (except <b>RACEODO</b> )	Next display mode
<b>LAP/BESTLAP/TopSpeed</b> menu	The next lap is displayed	The previous lap is displayed	The display changes to the <b>SET-UP</b> menu	All values in <b>RACE</b> mode are reset (except <b>RACEODO</b> )	Next display mode





Table of functions					
Display	Press the button  .	Press the button  .	Press the button  and the button  for 3 - 5 seconds.	Press the <b>MODE</b> button for 3 - 5 seconds.	Press the <b>MODE</b> button briefly.
Total distance menu in <b>Race</b> mode <b>RACEODO</b>	no function	no function	The display changes to the <b>SET-UP</b> menu	All values in <b>RACE</b> mode are reset (except <b>RACEODO</b> )	Next display mode
<b>SET-UP</b> menu	The arrow moves up	The arrow moves down	no function	The menu in front of the arrow is selected	The menu in front of the arrow is selected
<b>CHANGE MODE</b> menu	Changes the menu	Changes the menu	no function	Opening and exiting <b>CHANGE MODE</b>	Opening and exiting <b>CHANGE MODE</b>
<b>SET CLOCK</b> menu	increases the value	reduces the value	no function	Open and exit <b>SET CLOCK</b> or change to next value	Open and exit <b>SET CLOCK</b> or change to next value
<b>SETTINGS</b> menu	The arrow moves up	The arrow moves down	no function	The menu in front of the arrow is selected	The menu in front of the arrow is selected
<b>SHIFT RPMS</b> menu	increases the value	reduces the value	no function	Open and exit <b>SHIFT RPMS</b> or change to next value	Open and exit <b>SHIFT RPMS</b> or change to next value
<b>LAP</b> menu, <b>LAP BLANK T</b> button	increases the value	reduces the value	no function	Open and exit <b>LAP BLANK T</b>	Open and exit <b>LAP BLANK T</b>
<b>SET NUM LAPS</b> menu	increases the value	reduces the value	no function	Open and exit <b>SET NUM LAPS</b>	Open and exit <b>SET NUM LAPS</b>





Table of functions					
Display	Press the button  .	Press the button  .	Press the button  and the button  for 3 - 5 seconds.	Press the <b>MODE</b> button for 3 - 5 seconds.	Press the <b>MODE</b> button briefly.
<b>TRIP F RESET</b> menu	increases the value	reduces the value	no function	Open and exit <b>TRIP F RESET</b>	Open and exit <b>TRIP F RESET</b>
<b>UNITS</b> menu	The arrow moves up	The arrow moves down	no function	The menu in front of the arrow is selected	The menu in front of the arrow is selected
<b>SET KM/MILES</b> menu	Changes the unit	Changes the unit	no function	Open and exit <b>SET KM/MILES</b>	Open and exit <b>SET KM/MILES</b>
<b>SET °C/°F</b> menu	Changes the unit	Changes the unit	no function	Open and exit <b>SET °C/°F</b>	Open and exit <b>SET °C/°F</b>
<b>OPTIONS</b> menu	The arrow moves up	The arrow moves down	no function	The menu in front of the arrow is selected	The menu in front of the arrow is selected
<b>TPMS</b> menu	Switches the tire pressure display on/off	Switches the tire pressure display on/off	no function	Open and exit <b>OPTION TPMS</b>	Open and exit <b>OPTION TPMS</b>
<b>OPTION OUTERTEMP</b> menu	Switches the external temperature display on/off	Switches the external temperature display on/off	no function	Open and exit <b>OPTION OUTERTEMP</b>	Open and exit <b>OPTION OUTERTEMP</b>

Table of conditions and activability						
Display	<ul style="list-style-type: none"> <li>The ignition is on.</li> <li><b>ROAD</b> mode</li> </ul>	<ul style="list-style-type: none"> <li>The ignition is on.</li> <li>The motorcycle is standing.</li> <li><b>ROAD</b> mode</li> </ul>	<ul style="list-style-type: none"> <li>The ignition is on.</li> <li><b>RACE</b> mode</li> </ul>	<ul style="list-style-type: none"> <li>The ignition is on.</li> <li>The motorcycle is standing.</li> <li><b>RACE</b> mode</li> </ul>	<ul style="list-style-type: none"> <li>The ignition is on.</li> <li>The motorcycle is standing.</li> </ul>	Menu can be activated
<b>ODO</b> menu	•					
<b>FUELDISTANCE</b> menu	•					
<b>FUEL RANGE</b> menu	•					
<b>DISTANCE TO Next Service</b> menu		•				
<b>LAPSTOGO</b> menu			•			
<b>TOPSPEED</b> menu			•			
<b>LAP/BESTLAP/LastLap</b> menu				•		
<b>LAP/BESTLAP/TopSpeed</b> menu				•		
Total distance menu in <b>Race</b> mode <b>RACEODO</b>				•		
<b>SET-UP</b> menu					•	
<b>CHANGE MODE</b> menu					•	•
<b>SET CLOCK</b> menu					•	
<b>SETTINGS</b> menu					•	
<b>SHIFT RPMS</b> menu					•	
<b>LAP</b> menu, <b>LAP BLANK T</b> button					•	
<b>SET NUM LAPS</b> menu					•	
<b>TRIP F RESET</b> menu					•	



Table of conditions and activability						
Display	<ul style="list-style-type: none"> <li>The ignition is on.</li> <li><b>ROAD</b> mode</li> </ul>	<ul style="list-style-type: none"> <li>The ignition is on.</li> <li>The motorcycle is standing.</li> <li><b>ROAD</b> mode</li> </ul>	<ul style="list-style-type: none"> <li>The ignition is on.</li> <li><b>RACE</b> mode</li> </ul>	<ul style="list-style-type: none"> <li>The ignition is on.</li> <li>The motorcycle is standing.</li> <li><b>RACE</b> mode</li> </ul>	<ul style="list-style-type: none"> <li>The ignition is on.</li> <li>The motorcycle is standing.</li> </ul>	Menu can be activated
<b>UNITS</b> menu					•	
<b>SET KM/MILES</b> menu					•	
<b>SET °C/°F</b> menu					•	
<b>OPTIONS</b> menu					•	
<b>TPMS</b> menu					•	•
<b>OPTION OUTERTEMP</b> menu					•	•

## Displaying lap times

### Condition

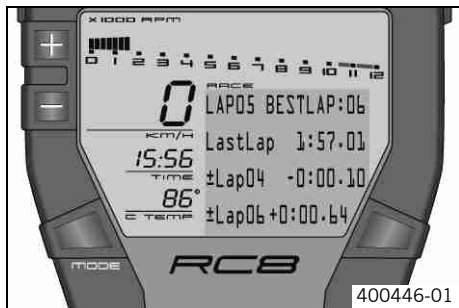
- The ignition is on.
- The motorcycle is standing.
- RACE** mode





- Press the **MODE** button briefly and repeatedly until **LAP/BESTLAP/LastLap** appears in the info display.
  - ✓ **LAP01** appears on the left of the info display.
- Press the button .
  - ✓ The next lap is displayed.
- Press the button .
  - ✓ The previous lap is displayed.
- Press the **MODE** button briefly.
  - ✓ Next display mode

## Displaying maximum speed

### Condition

The ignition is on.  
The motorcycle is standing.

### RACE mode

- Press the **MODE** button briefly and repeatedly until **LAP/BESTLAP/TopSpeed** appears in the info display.
  - ✓ **LAP01** appears on the left of the info display.
- Press the button .
  - ✓ The next lap is displayed.
- Press the button .
  - ✓ The previous lap is displayed.
- Press the **MODE** button briefly.
  - ✓ Next display mode

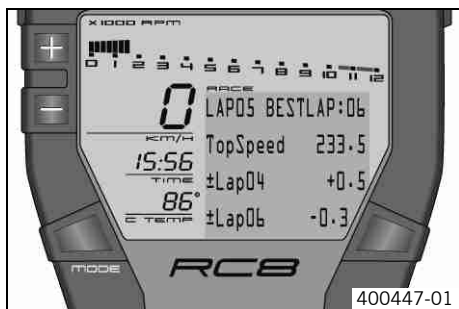



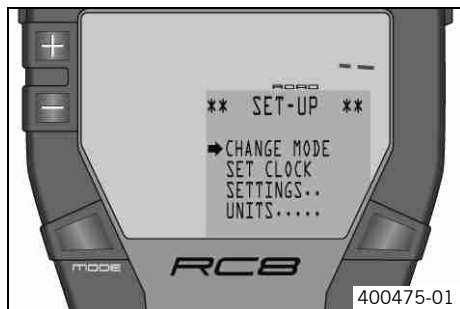





## Setting ROAD or RACE mode



### Condition

The ignition is on.

The motorcycle is standing.

- Press the  and the  for 3 - 5 seconds.
- Press the  or the  briefly and repeatedly until the symbol  is on **CHANGE MODE** in the info display.
- Press the **MODE** button briefly.
  - ✓ The mode set is shown in the info display.
- Select **ROAD** mode or **RACE** mode with the  or the .
- Press the **MODE** button briefly.
  - ✓ The settings are stored and the display changes to the **SET-UP** menu.
- Press the  briefly and repeatedly until the symbol  is on **EXIT SETUP** in the info display.
- Press the **MODE** button briefly.

## Setting the clock with SET CLOCK









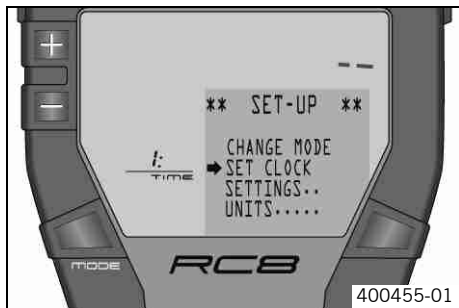

### Condition

The ignition is on.

The motorcycle is standing.









- Press the button  and the button  for 3 - 5 seconds.
- Press the button  once until the symbol  is on **SET CLOCK** in the info display.
- Press the **MODE** button briefly.
  - ✓ The hour is shown.
- Set the hour with the button or the  button .
- Press the **MODE** button briefly.
  - ✓ The minutes are shown.
- Set the minutes with the button or the  button .
- Press the **MODE** button briefly.
  - ✓ The settings are stored and the display changes to the **SET-UP** menu.
- Press the button  briefly and repeatedly until the symbol  is on **EXIT SETUP** in the info display.
- Press the **MODE** button briefly.

## Adjusting shift speed RPM1/2

### Condition

The ignition is on.

The motorcycle is standing.

- Press the button  and the button  for 3 - 5 seconds.
- Press the button  twice until the symbol  is on **SETTINGS** in the info display.





- Press the **MODE** button briefly.
- ✓ **RPM1** and **RPM2** appear on the info display.
- ✓ The engine speed after **RPM1** flashes.



### Info



The engine speed can be set at intervals of 50.  
**RPM1** is the engine speed above which the shift warning light starts to flash.

- Set the engine speed with the  button or the  button.
- Press the **MODE** button briefly.
- ✓ The engine speed after **RPM2** flashes.



### Info





**RPM2** is the engine speed above which the shift warning light lights up constantly. If **RPM1 = RPM2**, the shift warning light lights up constantly when you reach the engine speed set.

- Set the engine speed with the  button or the  button.
- Press the **MODE** button briefly.
- ✓ The settings are stored and the display changes to the **SETTING** menu.



### Info

At delivery, **RPM1** is set to 10000 and **RPM2** to 10500.

- Press the  button briefly and repeatedly until the symbol  is on **BACK...** in the info display.
- Press the **MODE** button briefly.
- Press the  button briefly and repeatedly until the symbol  is on **EXIT SETUP** in the info display.







- Press the **MODE** button briefly.

## Setting the blank time of the LAP button LAP BLANK T

### Condition

The ignition is on.

The motorcycle is standing.

- Press the button  and the button  for 3 - 5 seconds.
- Press the button  twice until the symbol  is on **SETTINGS** in the info display.
- Press the button  once until the symbol  is on **LAP BLANK T** in the info display.
- Press the **MODE** button briefly.

✓ **LAP BLANK T.** appears on the info display.

### Info

At delivery, **LAP BLANK T.** is set to **1** second.

### Tip

With **LAP BLANK T.**, you can prevent the lap from being timed too short. This may happen if you accidentally press the **LAP** button twice in a row.



- Set the blank time of the **LAP** button with the button  or the button .

### Info



**LAP BLANK T.** can be set between **1** and **200**.

- Press the **MODE** button briefly.

✓ The settings are stored and the display changes to the **SETTINGS** menu.

- Press the button  briefly and repeatedly until the symbol  is on **BACK...** in the info display.
- Press the **MODE** button briefly.









- Press the button  briefly and repeatedly until the symbol  is on **EXIT SETUP** in the info display.
- Press the **MODE** button briefly.

## Setting number of laps SET NUM LAPS

### Condition

The ignition is on.

The motorcycle is standing.



- Press the button  and the button  for 3 - 5 seconds.
- Press the button  twice until the symbol  is on **SETTINGS** in the info display.
- Press the button  twice until the symbol  is on **SET NUM LAPS** in the info display.
- Press the **MODE** button briefly.

✓ **TOTAL LAPS** appears on the info display with the number of laps.



### Info





When delivered, the number of **TOTAL LAPS** is set to 99 laps.

- Set the number of laps with the button  or the button .



### Info

You can set **TOTAL LAPS** to between 1 and 99 laps.

- Press the **MODE** button briefly.
- ✓ The settings are stored and the display changes to the **SETTINGS** menu.
- Press the button  briefly and repeatedly until the symbol  is on **BACK...** in the info display.
- Press the **MODE** button briefly.
- Press the button  briefly and repeatedly until the symbol  is on **EXIT SETUP** in the info display.

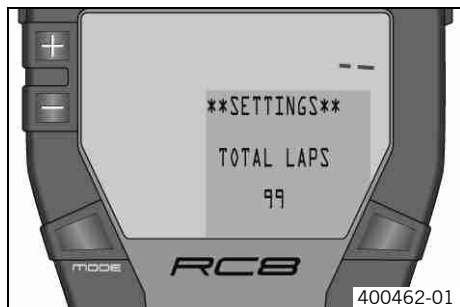







- Press the **MODE** button briefly.

## Setting fuel reserve display TRIPF RESET

### Condition

The ignition is on.



The motorcycle is standing.

- Press the button  and the button  for 3 - 5 seconds.
- Press the button  twice until the symbol  is on **SETTINGS** in the info display.
- Press the button  three times until the symbol  is on **TRIP F RESET** in the info display.
- Press the **MODE** button briefly.

✓ **TRIPF RESET** appears on the info display with the reaction time.





### Info

At delivery, **TRIPF RESET** is set to 300 seconds.

- Set the reaction time of the fuel reserve display with the button  or the button .

### Info

You can set the **TRIPF RESET** to between 10 and 1000 seconds in steps of 10.

- Press the **MODE** button briefly.
- ✓ The settings are stored and the display changes to the **SETTINGS** menu.
- Press the button  briefly and repeatedly until the symbol  is on **BACK...** in the info display.
- Press the **MODE** button briefly.
- Press the button  briefly and repeatedly until the symbol  is on **EXIT SETUP** in the info display.
- Press the **MODE** button briefly.



## Setting kilometers/miles SET KM/MILES



### Info

Making a country-specific setting.

### Condition

The ignition is on.

The motorcycle is standing.

- Press the button and the button for 3 - 5 seconds.
- Press the button three times until the symbol → is on **UNITS** in the info display.
- Press the button or the button briefly and repeatedly until the symbol → is on **SET KM/MILES** in the info display.
- Press the **MODE** button briefly.
  - ✓ The selected unit appears on the left of the display.
- Select the unit with the button or the button.
- Press the **MODE** button briefly.
  - ✓ The settings are stored and the display changes to the **UNITS** menu.
- Press the button briefly and repeatedly until the symbol → is on **BACK...** in the info display.
- Press the **MODE** button briefly.
- Press the button briefly and repeatedly until the symbol → is on **EXIT SETUP** in the info display.
- Press the **MODE** button briefly.

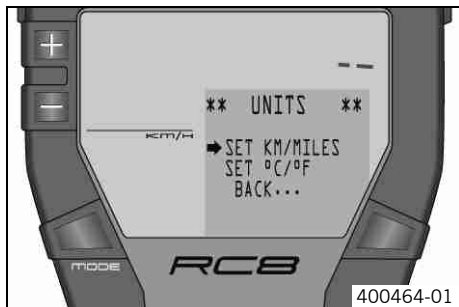



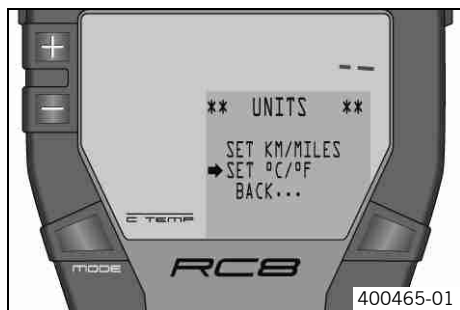









## Setting temperature unit SET °C/°F



### Condition

The ignition is on.

The motorcycle is standing.

- Press the button  and the button  for 3 - 5 seconds.
- Press the button  three times until the symbol  is on **UNITS** in the info display.
- Press the button  once until the symbol  is on **SET °C/°F** in the info display.
- Press the **MODE** button briefly.
  - ✓ The selected unit appears on the left of the display.
- Select the unit with the button  or the button .
- Press the **MODE** button briefly.
  - ✓ The settings are stored and the display changes to the **UNITS** menu.
- Press the button  briefly and repeatedly until the symbol  is on **BACK...** in the info display.
- Press the **MODE** button briefly.
- Press the button  briefly and repeatedly until the symbol  is on **EXIT SETUP** in the info display.
- Press the **MODE** button briefly.









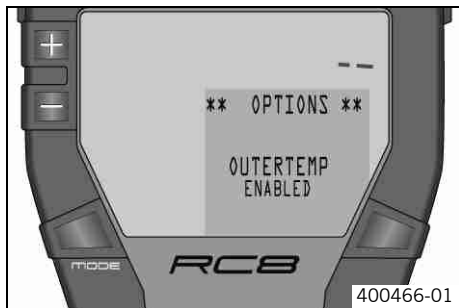



## Switching external temperature display on/off

### Condition

The ignition is on.

The motorcycle is standing.



- Press the button  and the button  for 3 - 5 seconds.
- Press the button  four times until the symbol  is on **OPTIONS** in the info display.
- Press the button  once until the symbol  is on **OPTIONS OUTERTEMP** in the info display.
- Press the **MODE** button briefly.
  - ✓ You see **ENABLED** or **DISABLED** on the info display.
- You can switch the external temperature display on/off with the button  or the button .
- Press the **MODE** button briefly.
  - ✓ The settings are stored and the display changes to the **OPTIONS** menu.
- Press the button  briefly and repeatedly until the symbol  is on **BACK...** in the info display.
- Press the **MODE** button briefly.
- Press the button  briefly and repeatedly until the symbol  is on **EXIT SETUP** in the info display.
- Press the **MODE** button briefly.



## Opening the filler cap



- Lift the cover **1** of the filler cap and insert the ignition key in the lock.
- Turn the ignition key clockwise until the filler cap opens.
- Open the filler cap.



700235-01

## Closing the filler cap

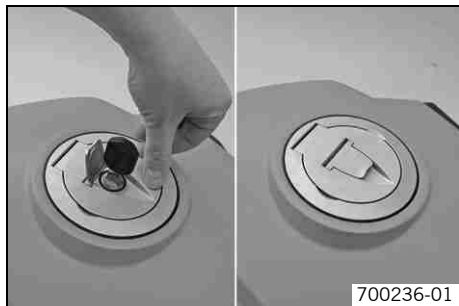

- Close the filler cap. Push down the filler cap slightly until the lock closes.
- Remove the ignition key and close the cover.

## Supporting strap

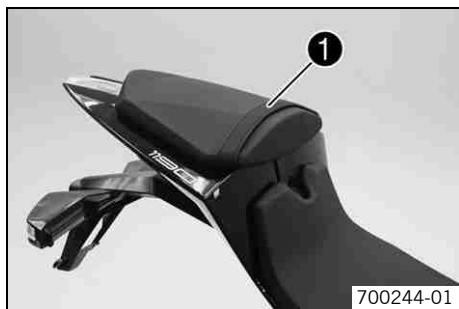

The supporting strap ❶ is provided for the passenger to hold on to.

## Seat lock



The seat lock ❶ is behind the seat.  
It can be locked with the ignition key.

## Tool set

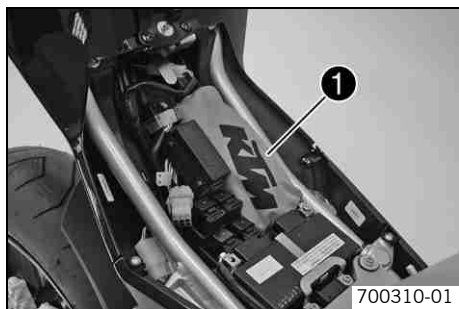

The tool set ❶ is in the storage compartment under the seat.

## Helmet lock



The steel cable in the tool set can be used to lock a helmet to the vehicle to prevent it from being stolen.



### Warning

**Danger of accidents** Impairment of handling characteristics and vehicle operation by a fitted helmet lock or helmet.

- Do not use the helmet lock for holding a helmet or other objects during the journey. Always remove the helmet lock before starting out.

## Passenger footrests

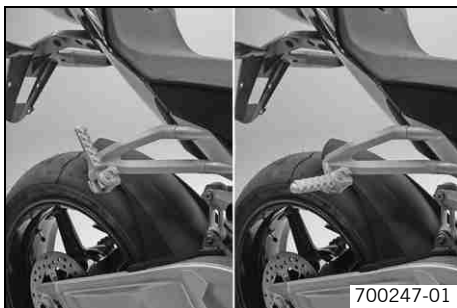

The passenger footrests can be folded up and down.

### Possible states

- Passenger footrests folded up – For operation without a passenger.
- Passenger footrests folded down – For operation with a passenger.

## Shift lever

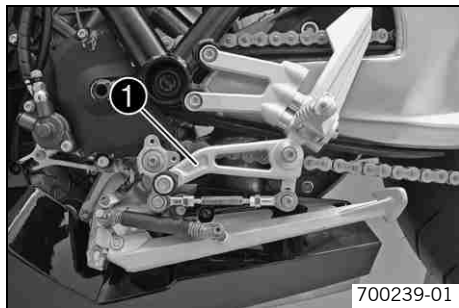

The shift lever ❶ is mounted on the left of the engine.

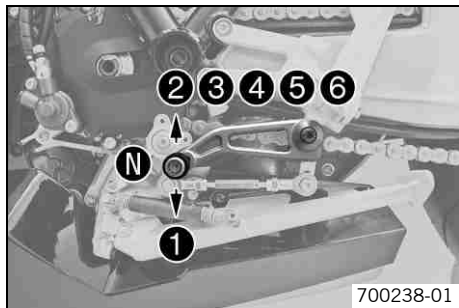

The gear positions can be seen in the picture.

The neutral or idle position ❷ is between the first and second gear.

## Foot brake pedal

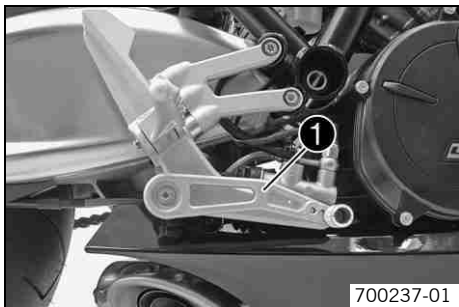

The footbrake pedal ❶ is in front of the right footrest.  
The footbrake pedal operates the rear brake.

## Side stand

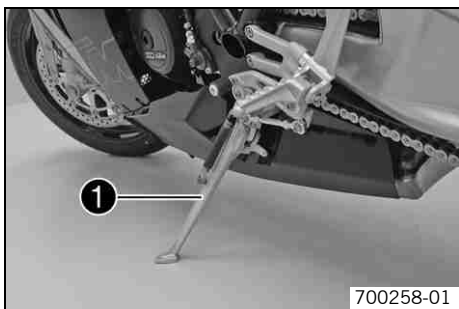

The side stand ❶ is coupled with the safety start system; see the riding instructions.

### Possible states

- Side stand folded out – The vehicle can be leaned on the side stand. The safety start system is active.
- Side stand folded in – This position is mandatory for all journeys. The safety start system is inactive.

## advice on first use



### **Danger**

**Danger of accidents** Danger from insufficient traffic competence.

- Do not use the vehicle if you are not fit to deal with traffic or if you have consumed alcohol and/or medicaments or drugs.



### **Warning**

**Risk of injury** Risk of injury by missing/inadequate protective clothing.

- Wear protective clothing (helmet, boots, gloves, pants and jacket with protectors) every time you ride the motorcycle. Always wear protective clothing, which must be in perfect condition and meet legal requirements.



### **Warning**

**Danger of crashing** Impairment of riding behavior due to different tire tread patterns on front and rear wheels.

- The front and rear wheels must be fitted with tires with similar tread patterns to prevent loss of control over the vehicle.



### **Warning**

**Danger of accidents** Uncontrollable handling characteristics due to non-approved and/or non-recommended tires/wheels.

- Only tires/wheels approved by KTM and with the corresponding speed index should be used.



### **Warning**

**Danger of accidents** Reduced road grip with new tires.

- New tires have a smooth roll surface and therefore cannot provide full road grip. The entire roll surface must be roughened in the first 200 kilometers (124.3 miles) by moderate driving at alternating angles. The full grip is not reached until the vehicle has been run in.



### **Warning**

**Danger of accidents** Brake system failure.

- If the foot brake pedal is not released, the brake linings drag permanently. The rear brake can fail due to overheating. Take your foot off the foot brake pedal if you do not want to brake.

**Info**

When using your vehicle, remember that others may feel disturbed by excessive noise.

- Make sure that the pre-delivery inspection work has been carried out exclusively by an authorized KTM-RC8 workshop. You receive a delivery certificate and the service record at vehicle handover.
- Before your first trip, read the entire operating instructions carefully.
- Get to know the operating elements.
- Adjust the basic position of clutch lever. (☛ S. 175)
- Adjust the basic position of the handbrake lever. (☛ S. 129)
- Adjust the footbrake pedal. (☛ S. 121)
- Get used to handling the vehicle on an empty car park before making a longer trip. Try also to ride as slowly as possible to get a better feeling for the motorcycle.
- Hold the handlebar firmly with both hands and keep your feet on the footrests when riding.
- Do not make any changes to the vehicle, and use only KTM approved/recommended parts.

**Info**

Parts from other manufacturers can reduce the operational safety of the vehicle.

- Run the engine in. (☛ S. 78)

## Running the engine in

- Do not exceed the specified engine speed and load during the running-in period.

Guideline

Maximum engine speed	
During the first: 1,000 km (621.4 mi)	7,500 rpm
After the first: 1,000 km (621.4 mi)	10,500 rpm



- Avoid full-throttle operation!

## Loading the vehicle



### Warning

**Danger of accidents** Unstable riding behavior.

- Do not exceed the maximum permitted weight and axle loads. The overall weight consists of: motorcycle operational and with a full tank, driver and passenger with protective clothing and helmet, baggage.



### Warning

**Danger of accidents** Unstable handling characteristics due to incorrect mounting of suitcase and/or tank rucksack.

- Mount and secure suitcase and tank rucksack according to the manufacturer's instructions.



### Warning

**Danger of accidents** Unstable handling characteristics at high speed.

- Adapt your speed according to your payload. If the motorcycle is loaded with luggage, ride more slowly.  
Maximum speed with luggage 130 km/h (80.8 mph)



### Warning

**Danger of accidents** Destruction of luggage carrier system.

- If the motorcycle is fitted with luggage cases, note the manufacturer's specifications concerning the maximum payload.



### Warning

**Danger of accidents** Poor visibility for other road users due to slipped baggage.

- If the tail light is covered, you are less visible to following traffic, especially in the dark. Check the way your baggage is fixed regularly.



### Warning

**Danger of accidents** Changed handling characteristics and longer stopping distance with excessive payload.

- Adapt your speed according to your payload.



## Warning

**Danger of accidents** Unstable handling characteristics due to slipped baggage.

- Check the way your baggage is fixed regularly.
- 

- If you carry any baggage, make sure it is fixed firmly as close as possible to the center of the vehicle and ensure even weight distribution between the front and rear wheels.
- Do not exceed the overall maximum permitted weight and the axle loads.

### Guideline

Maximum permissible total weight	380 kg (838 lb.)
Maximum permissible front axle load	200 kg (441 lb.)
Maximum permissible rear axle load	220 kg (485 lb.)

## checks to be made before putting into operation



### Info

During operation, the motorcycle must be in a technically perfect condition.

In the interest of riding safety, you should get into the habit of making a general check of the motorcycle before every journey.

- Check the engine oil level. (🔧 S. 184)
- Check the engine for oil leaks.
- Check the fuel level.
- Bleed fork legs. (🔧 S. 100)

### Guideline

every	1,000 km (621.4 mi)
-------	---------------------

- Check the chain tension. (🔧 S. 123)
- Clean the chain. (🔧 S. 122)
- Check the tire condition. (🔧 S. 143)
- Checking the tire air pressure. (🔧 S. 145)
- Check the brake fluid level of the front brake. (🔧 S. 130)
- Check the rear brake fluid level. (🔧 S. 133)
- Check the front brake linings. (🔧 S. 132)
- Check the rear brake linings. (🔧 S. 135)
- Check the brake system.
- Check the coolant level. (🔧 S. 172)
- Check the adjustment and smooth operation of all operating elements.
- Check the functioning of the electrical equipment.
- Check that any luggage is fastened correctly.
- Sit on the motorcycle and check the setting of the rear mirror.

## Starting

---



### **Danger**

**Danger of poisoning** Exhaust gases are poisonous and can result in unconsciousness and/or death.

- When running the engine, always make sure there is sufficient ventilation, and do not start or run the engine in a closed space.

### **Note**

**Engine failure** High engine speeds in cold engines have a negative effect on the service life of the engine.

- Always warm up the engine at low engine speeds.
-

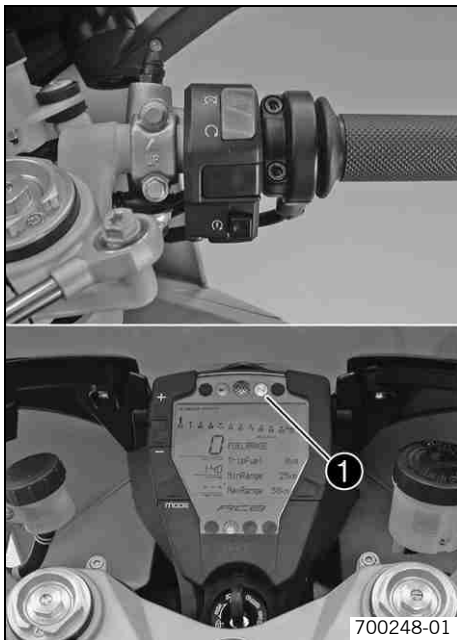

- Press the emergency OFF switch into the position ○.
- Switch on the ignition by turning the black ignition key to the position ○.
- ✓ When you switch on the ignition, you hear the fuel pump working for about 2 seconds. At the same time, the function test of the combination instrument is run.
- Shift into neutral.
- ✓ The green idling speed indicator lamp **N** ● lights up.
- Press the electric starter button (1).

## **i** Info

Do not press the electric starter button until the combination instrument function test finishes.

Do not open the throttle to start. If you open the throttle during starting, the engine management does not supply any fuel, so the engine cannot start.

Press the starter for a maximum of 5 seconds without a break. Wait at least 5 seconds before trying to start again.

This motorcycle is equipped with a safety start system. The engine will only start if in neutral or, if a gear is engaged, when the clutch lever is pulled. If the side-stand is out and the machine is in gear and you release the clutch lever, the engine stops.

- Take the weight off the side stand and swing it upwards with your foot as far as it will go.

## starting up

- Pull the clutch lever, shift into first gear, release the clutch slowly and at the same time open the throttle.

## Shifting, riding

-  **Warning**  
**Danger of accidents** An abrupt load alterations can cause the vehicle to get out of control.
- Avoid abrupt load alterations and sudden braking actions, and adapt your speed to the road conditions.

-  **Warning**  
**Danger of accidents** If you change down at high engine speed, the rear wheel can lock up.
- Do not change into a low gear at high engine speed. The engine races and the rear wheel can block.

-  **Warning**  
**Danger of accidents** Malfunctions caused by incorrect ignition key position.
- Do not change the ignition key position during a journey.

-  **Warning**  
**Danger of accidents** Distraction from traffic activity by adjustments to the vehicle.
- Make all adjustments when the vehicle is at a standstill.

-  **Warning**  
**Risk of injury** The passenger must be able to sit securely on the passenger seat.
- The passenger must hold on to the rider or supporting strap firmly and place his/her feet on the passenger footrests. Observe the regulations concerning the minimum age for passengers in your country.

-  **Warning**  
**Danger of accidents** Danger of accidents caused by dangerous driving.
- Observe the traffic regulations and ride defensively and with foresight in order to recognize danger as early as possible.



## Warning

**Danger of accidents** Reduced road grip with cold tires.

- On every journey, take the first miles carefully at moderate speed until the tires reach operating temperature and optimal road grip is ensured.



## Warning

**Danger of accidents** Reduced road grip with new tires.

- New tires have a smooth roll surface and therefore cannot provide full road grip. The entire roll surface must be roughened in the first 200 kilometers (124.3 miles) by moderate driving at alternating angles. The full grip is not reached until the vehicle has been run in.



## Warning

**Danger of accidents** Unstable riding behavior.

- Do not exceed the maximum permitted weight and axle loads. The overall weight consists of: motorcycle operational and with a full tank, driver and passenger with protective clothing and helmet, baggage.



## Warning

**Danger of accidents** Unstable handling characteristics due to slipped baggage.

- Check the way your baggage is fixed regularly.



## Warning

**Danger of accidents** After a fall, check the vehicle.

- After a fall, check the vehicle as usual before putting it into operation.

## Note

**Engine failure** Unfiltered intake air has a negative effect on the service life of the engine.

- Never ride the vehicle without an air filter since dust and dirt can get into the engine and result in increased wear.

## Note

**Engine damage** Engine overheating.

- If the coolant temperature warning lamp lights up, stop the vehicle and switch off the engine. Let the engine cool down, and then check the coolant level in the radiator and top up if necessary. If you continue your journey with the coolant temperature warning lamp on, you can cause an engine failure.



## Info

If you hear unusual noises while riding, stop immediately, switch off the engine and contact an authorized KTM-RC8 workshop.

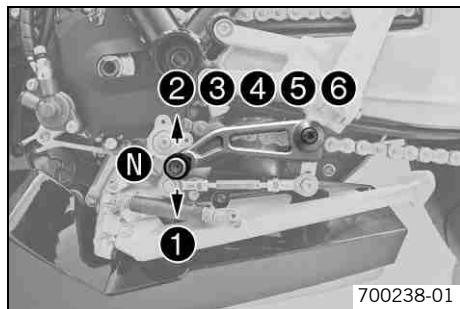

- When conditions allow (incline, road situation, etc.), you can shift into a higher gear.
- Release the throttle while simultaneously pulling the clutch lever, shift into the next gear, release the clutch and open the throttle.



## Info

For the positions of the 6 forward gears, see the illustration. The neutral or idle position is between the first and second gear. First gear is used for starting off or for steep inclines.

- When you reach maximum speed after fully opening the throttle, turn back the throttle to about  $\frac{3}{4}$  of its range; the speed hardly drops, but the fuel consumption falls considerably.
- Open the throttle only as far as the road and weather conditions permit. Particularly in bends, do not shift and open the throttle only very cautiously.
- To shift down, brake if necessary and close the throttle at the same time.
- Pull the clutch lever and shift into a lower gear, release the clutch lever slowly and open the throttle or shift again.
- For example, if the engine stalls at a junction, just pull the clutch and press the electric starter button. You do not need to shift into neutral.
- Switch off the engine if you expect to be standing for a long time.



- If the **EFI** warning lamp (**MIL**) starts to light up during the journey, stop immediately. If you shift to neutral, the **EFI** warning lamp (**MIL**) begins to flash.

---

## Info

From the flash rhythm, you can deduce a two-digit number, the so-called flash code. The flash code tells you which component is affected by a fault.

---

## Braking

---



### Warning

**Danger of accidents** If you brake too hard, the wheels can lock.

- Adapt your braking to the traffic situation and the road conditions.



### Warning

**Danger of accidents** Reduced braking due to wet or dirty brakes.

- Clean or dry dirty or wet brakes by riding and braking gently.



### Warning

**Danger of accidents** Reduced braking effect caused by spongy pressure point of front or rear brake.

- Have the brake system checked in an authorized KTM-RC8 workshop before continuing your journey.



### Warning

**Danger of accidents** Brake system failure.

- If the foot brake pedal is not released, the brake linings drag permanently. The rear brake can fail due to overheating. Take your foot off the foot brake pedal if you do not want to brake.



### Warning

**Danger of accidents** Longer stopping distance due to higher overall weight.

- Take the longer stopping distance into account when carrying a passenger and baggage.



## Warning

**Danger of accidents** Delayed brake action on salted roads.

- Salt can be deposited on the brake discs. To achieve the normal braking effect, the brake discs must first be cleaned by braking.

- 
- When braking, first throttle back and then apply the front and rear brakes at the same time.
  - On wet or slippery surfaces, mainly use the rear brake.
  - Make sure you complete braking before going into a bend. Change down to a lower gear corresponding to your speed.
  - On long downhill stretches, use the braking effect of the engine. Do this by changing down two gears, but do not race the engine. You then do not need to brake so much, and the brakes do not overheat.

## Stopping, parking



## Warning

**Risk of misappropriation** Usage by unauthorized persons.

- Never leave the vehicle while the engine is running. Secure the vehicle against use by unauthorized persons. If you leave the vehicle, lock the steering and remove the ignition key.



## Warning

**Danger of burns** Some vehicle components get very hot when the machine is driven.

- Do not touch hot components such as exhaust system, radiator, engine, shock absorber and brakes. Allow these components to cool down before starting work on them.

## Note

**Danger of damage** Danger of damage by the vehicle running away or falling over.

- Always place the vehicle on a firm and even surface.

## Note

**Fire hazard** Some components (engine, radiator and exhaust system) get very hot when the engine is running.

- Do not place the vehicle where there are flammable or explosive substances.

## Note

**Material damage** Damage and destruction of components by excessive load.

- The side stand is designed for the weight of the motorcycle only. Do not sit on the motorcycle when it is supported by the side stand only. The side stand and/or the frame could be damaged and the motorcycle could fall over.

- 
- Apply the brakes.
  - Shift into neutral.
  - Switch off the ignition by turning the black ignition key to the position ☒.



## Info

If you switch off the engine with the emergency OFF switch but the ignition remains switched on at the ignition lock, power continues to flow to most power consumers and the battery is soon discharged. Therefore, always switch off the engine with the ignition key, the emergency OFF switch is provided for emergency situations only.

- 
- Park the motorcycle on firm ground.
  - Swing the side stand to the front with your foot as far as it will go, and lean the motorcycle onto it.
  - Lock the steering by moving the handlebar to the left, pressing down the black ignition key to the position ☒ and turning it to the position ☑. To make locking the steering easier, move the handlebar a little to the left and right. Remove the black ignition key.

## Refueling



## Danger

**Fire hazard** Fuel can easily catch fire.

- Never fill up the vehicle near open flames or burning cigarettes, and always switch off the engine first. Be careful that no fuel is spilt, especially on hot vehicle components. Clean up spilt fuel immediately.
- Fuel in the fuel tank expands when warm and can escape if the tank is overfilled. See specifications on filling up with fuel.



## Warning

**Danger of poisoning** Fuel is poisonous and a health hazard.

- Avoid contact between fuel and skin, eyes and clothing. Do not inhale fuel vapors. If fuel gets into your eyes, rinse immediately with water and contact a doctor. Wash affected skin areas immediately with soap and water. If fuel is swallowed, contact a doctor immediately. Change clothing that has come into contact with fuel.



## Warning

**Environmental hazard** Improper handling of fuel is a danger to the environment.

- Do not allow fuel to get into the ground water, the ground, or the sewage system.



## Info

This motorcycle is equipped with a regulated catalyst. Leaded fuel will destroy the catalyst. You should therefore use unleaded fuel only.

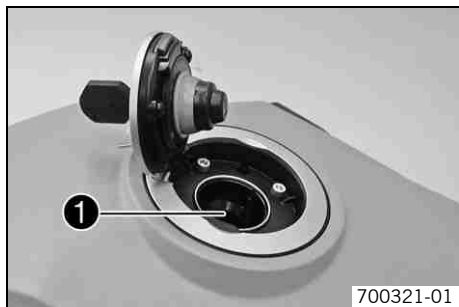

- Switch off engine.
- Open the filler cap. (☛ S. 71)
- Fill the fuel tank with fuel up to the lower edge ❶ of the fuel filler.

Fuel tank content	16.5 l (4.36 US gal)	Super unleaded (ROZ 95 / RON 95 / PON 91) (☛ S. 223)
-------------------	-------------------------	---

- Close the filler cap. (☛ S. 72)

## Important service tasks to be carried out by an authorized KTM-RC8 workshop.

		K10N	K75A	K150A	J1A	J2A
Engine	Change the engine oil and filter, clean the oil screen. 🛠️ (📖 S. 185)	•	•	•	•	•
	Check the valve clearance and adjust if necessary. 🛠️			•		
	Replace the spark plugs. 🛠️			•		
	Check the engine fixing screws and other engine screws accessible from outside to ensure that they are tight. 🛠️	•	•	•		
	Check the clutch. 🛠️			•		
	Clean the oil jet for clutch lubrication. 🛠️			•		
Fuel injection	Read out the status query and fault memory with <b>KTM DIA</b> . 🛠️	•	•	•		
	Check bellows for tears and leaks, and check the linkage of the throttle valve spigot for freedom of movement. 🛠️			•		
	Check the cable harness of the throttle valve body for damage and correct routing. 🛠️			•		
	Check hoses of vacuum sensors, SLS hoses and vent hoses for damage, correct routing and leaks. 🛠️	•	•	•	•	•
	Check the fuel hose for damage, correct routing and leaks. 🛠️	•	•	•	•	•
	Check fuel pressure. 🛠️		•	•		
Attachments	Check the cooling system for leaks. 🛠️	•	•	•	•	•
	Check the water pump for leaks (visual check). 🛠️	•	•	•		
	Check the coolant level. (📖 S. 172)	•	•	•	•	•
	Check the antifreeze. 🛠️	•	•	•	•	•
	Check the functioning of the radiator fan. 🛠️	•	•	•		
	Check the exhaust system for leaks and correct fitting and check that the exhaust holders are tight. 🛠️	•	•	•		

		K10N	K75A	K150A	J1A	J2A
Attachments	Check bowden cables for damage, smooth operation, kink-free routing and adjustment. 🛠️	•	•	•	•	•
	Check the fluid level of the hydraulic clutch. (🔧 S. 175)		•	•	•	•
	Check the air filter and change if necessary. Clean the air filter box. 🛠️			•		
	Drain the drainage hose of the air filter box. 🛠️	•	•	•	•	•
	Check cables for damage and kink-free routing. 🛠️	•	•	•		
	Check the headlight adjustment. (🔧 S. 167)	•	•	•	•	•
	Check the functioning of the electrical equipment.	•	•	•	•	•
	Check the fairing parts for damage and breakage. 🛠️	•	•	•		
	Check screws and for tightness. 🛠️	•	•	•		
Brakes	Check the front brake linings. (🔧 S. 132)	•	•	•		
	Check the rear brake linings. (🔧 S. 135)	•	•	•		
	Check the front brake discs. (🔧 S. 128)	•	•	•		
	Check the rear brake disc. (🔧 S. 129)	•	•	•		
	Check the brake fluid level of the front brake. (🔧 S. 130)	•	•	•	•	•
	Check the rear brake fluid level. (🔧 S. 133)	•	•	•	•	•
	Change brake fluid. 🛠️			•		•
	Check that brake lines are undamaged and free of leaks. 🛠️	•	•	•	•	•
	Check the free play of the foot brake lever.	•	•	•	•	•
	Check the braking. 🛠️	•	•	•	•	•
Check screws and guide pins of the brake system for tightness. 🛠️	•	•	•			
Chassis	Check the shock absorber and fork for leaks and function. 🛠️	•	•	•	•	•
	Bleed fork legs. (🔧 S. 100)	•	•	•	•	•

		K10N	K75A	K150A	J1A	J2A
Chassis	Check the steering head bearing and adjust if necessary. 🛠️	•	•	•		
	Check the swingarm bearing. 🛠️	•	•	•		
	Check deflector. 🛠️			•		•
	Check the eccentric shaft adjustment. 🛠️			•		•
	Check all screws to make sure they are tight. 🛠️	•	•	•		
Wheels	Check the tire condition. (🔧 S. 143)	•	•	•		
	Checking the tire air pressure. (🔧 S. 145)	•	•	•	•	•
	Check the chain wear. (🔧 S. 127)	•	•	•		
	Check the rear sprocket / engine sprocket / chain sliding guard to ensure that they are tight. 🛠️	•	•	•		
	Check the rear sprocket / engine sprocket for wear. (🔧 S. 126)	•	•	•		
	Check the chain tension. (🔧 S. 123)	•	•	•		
	Clean the chain. (🔧 S. 122)	•	•	•	•	•
	Check chain sliding guard. (🔧 S. 128)	•	•	•	•	•
	Check wheel bearings for play. 🛠️	•	•	•		
	Check the rear hub shock absorbers. 🛠️ (🔧 S. 143)	•	•	•	•	•

**K10N:** after 1,000 km (621.4 mi)

**K75A:** every 7,500 km (4,660 mi)

**K150A:** every 15,000 km (9,320 mi) / after every sporting use

**J1A:** annually

**J2A:** every 2 years

**Important service tasks to be carried out by an authorized KTM-RC8 workshop. (as additional job)**

	K150A	K300A	J1A	J2A
Completely service fork. 🛠️		•		
Completely service shock absorber. 🛠️		•		
Clean and grease the steering head bearing and sealing elements. 🛠️	•	•		•
Clean battery poles and treat with contact grease.			•	•
Change the coolant. 🛠️				•

**K150A:** every 15,000 km (9,320 mi) / after every sporting use

**K300A:** every 30,000 km (18,640 mi)

**J1A:** annually

**J2A:** every 2 years



## Jacking up motorcycle front

### Note

**Danger of damage** Danger of damage by the vehicle running away or falling over.

- Always place the vehicle on a firm and even surface.



- Jack up the motorcycle rear end. (👉 S. 96)
- Move the handlebar to the straight-ahead position. Align the work stand at the front with the adapters to the fork legs.

Work stand front (61029055300)



### Info

Always jack up the rear of the motorcycle first.

- Jack up the motorcycle at the front.

## Taking front of motorcycle off work stand

### Note

**Danger of damage** Danger of damage by the vehicle running away or falling over.

- Always place the vehicle on a firm and even surface.

- Secure the motorcycle against falling over.
- Remove the work stand from the front.

## Jacking up motorcycle rear

### Note

**Danger of damage** Danger of damage by the vehicle running away or falling over.

- Always place the vehicle on a firm and even surface.



- Insert the work stand adapter in the rear of the work stand.

Work stand adapter (61029055120)
----------------------------------

Work stand rear (61029055100)
-------------------------------

- Stand the motorcycle upright, align the work stand to the link fork and the adapters, and jack up the motorcycle.

## Taking rear of motorcycle off work stand

### Note

**Danger of damage** Danger of damage by the vehicle running away or falling over.

- Always place the vehicle on a firm and even surface.
- Secure the motorcycle against falling over.
- Remove the work stand from the rear and lean the vehicle on the sidestand.

## Fork/shock absorber

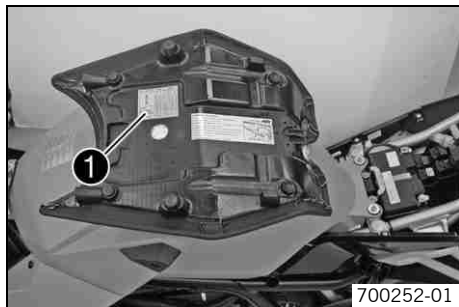

The fork and the shock absorber offer many options of adapting the chassis to your riding style and the payload.



### Info

To help you adapt the vehicle, we have summarized our findings in Table ❶. You will find the table on the underside of the seat. For all damping steps, start from the maximum screwed-in position with the highest damping factor and set to the specified values. Do not use excessive force to turn the adjusting screws against the stop, and take the last perceptible click as the end position.

These adjustments should be understood as a guideline and should always be the basis of your own personal chassis adaptation. Do not change the adjustments at random or by more than  $\pm 40\%$ , since otherwise the riding characteristics could deteriorate, particularly at high speeds.

## Adjusting compression damping of fork



### Info

The hydraulic compression damping determines the fork suspension behavior. An optimally adjusted compression damping ensures that the fork does not compress too far and fast when you brake hard or when the load shifts very fast. It gives the rider good feedback about the road conditions.

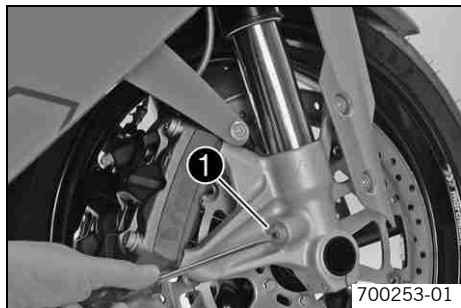

- Turn adjusting screws ❶ clockwise until they stop.

**i** **Info**

The adjusting screws are located at the bottom end of the fork legs. Make the same adjustment on both fork legs.

- Turn back counterclockwise the number of clicks corresponding to the fork type.

**Guideline**

Compression damping	
Comfort	15 clicks
Standard	10 clicks
Sport	5 clicks
full payload	5 clicks

**i** **Info**

Turn clockwise to increase damping, turn counterclockwise to reduce suspension damping.

## Adjusting rebound damping of fork

**i** **Info**

The hydraulic rebound damping determines the fork suspension behavior. An optimally adjusted rebound damping brakes the springing energy and enables a fast, vibration-free resetting of the fork to the zero position.

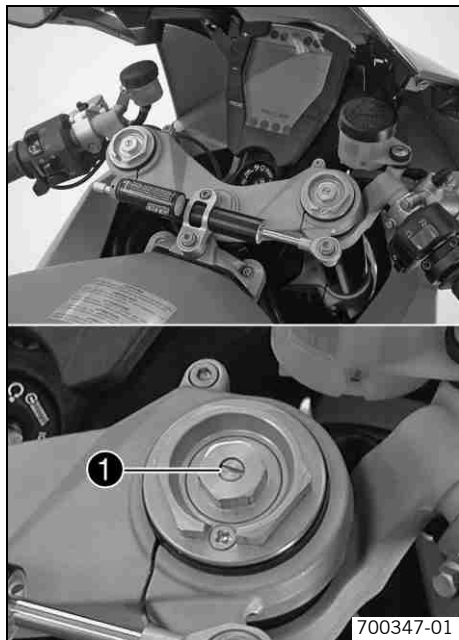

- Turn adjusting screws ❶ clockwise until they stop.

**i** **Info**

The adjusting screws are located at the top end of the fork legs. Make the same adjustment on both fork legs.

- Turn back counterclockwise the number of clicks corresponding to the fork type.

Guideline

Rebound damping	
Comfort	15 clicks
Standard	10 clicks
Sport	5 clicks
Full payload	5 clicks

**i** **Info**

Turn clockwise to increase damping, turn counterclockwise to reduce suspension damping.

## Adjusting spring preload of fork

**i** **Info**

The spring preload defines the initial situation of the spring process of the fork. An optimally adjusted spring preload is adapted to the rider's weight and ensures a compromise between easy handling and stability.

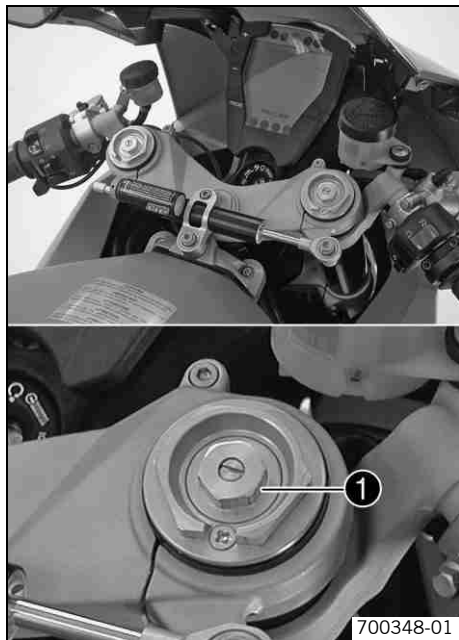

700348-01

- Turn the adjusting spindles ❶ clockwise until they stop.

**i Info**

The adjusting spindles are located at the top end of the fork legs. Make the same adjustment on both fork legs.

- Turn back counterclockwise the number of turns corresponding to the fork type.

Guideline

Spring preload - <b>Preload Adjuster</b>	
Comfort	5 turns
Standard	5 turns
Sport	3 turns
full payload	3 turns

**i Info**

Turn clockwise to increase preload, turn counterclockwise to reduce spring preload. Changing the spring preload has no influence on the rebound damping although the adjusting screws turn during the adjustment work. However, you should also adjust the rebound damping when you alter the spring preload.

## bleeding fork legs

- Lean the motorcycle on the side stand.

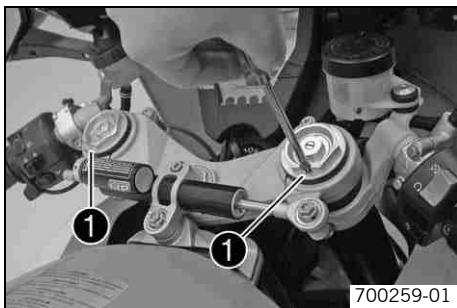

- Remove bleeder screws ❶ briefly.
- ✓ Any excess pressure escapes from the interior of the fork.
- Mount and tighten bleeder screws.

**i Info**  
Perform this action on both fork legs.

## Compression damping of the shock absorber

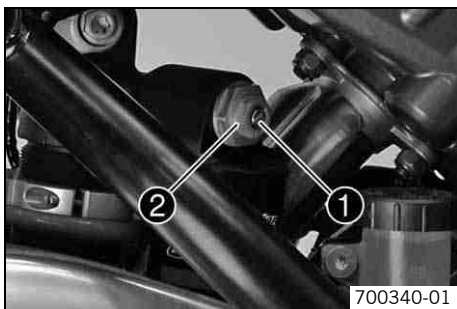

The shock absorber can coordinate the compression damping separately in the low ❶ and high ❷ speed range (Dual Compression Control). The term low and high speed refers to the movement of the shock absorber during compression and not the riding speed of the motorcycle. The low and high speed adjustment works for all areas.

## Adjusting the low-speed compression damping of the shock absorber



### Danger

**Danger of accidents** The shock absorber is under high pressure.

- The shock absorber is filled with highly compressed nitrogen, so never dismantle the shock absorber or carry out any maintenance on it yourself.

**i** Info

The low-speed setting can be seen during the slow to normal compression of the shock absorber.

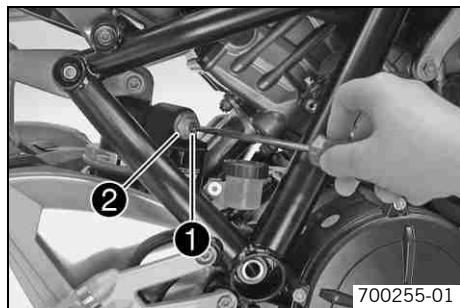

- Turn the adjusting screw ❶ clockwise with a screwdriver up to the last perceptible click.

**i** Info

Do not loosen nut ❷!

- Turn back counterclockwise the number of clicks corresponding to the shock absorber type.

## Guideline

Compression damping, low-speed	
Comfort	20 clicks
Standard	15 clicks
Sport	10 clicks
full payload	10 clicks

**i** Info

Turn clockwise to increase damping, turn counterclockwise to reduce suspension damping.



## Adjusting high-speed compression damping of the shock absorber



### Danger

**Danger of accidents** The shock absorber is under high pressure.

- The shock absorber is filled with highly compressed nitrogen, so never dismantle the shock absorber or carry out any maintenance on it yourself.



### Info

The high-speed setting can be seen during the fast compression of the shock absorber.

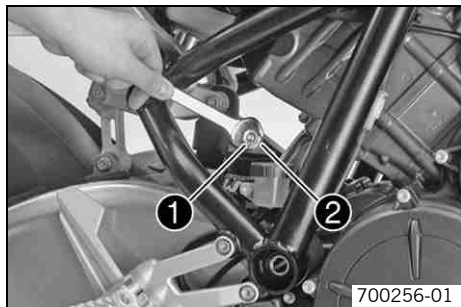

- Turn the adjusting screw ❶ clockwise with an open-ended spanner until it stops.



### Info

Do not loosen nut ❷!

- Turn back counterclockwise the number of turns corresponding to the shock absorber type.

### Guideline

Compression damping, high-speed	
Comfort	2 turns
Standard	1.5 turns
Sport	1 turn
full payload	1 turn



### Info

Turn clockwise to increase damping, turn counterclockwise to reduce suspension damping.

## Adjusting rebound damping of the shock absorber



### Danger

**Danger of accidents** The shock absorber is under high pressure.

- The shock absorber is filled with highly compressed nitrogen, so never dismantle the shock absorber or carry out any maintenance on it yourself.

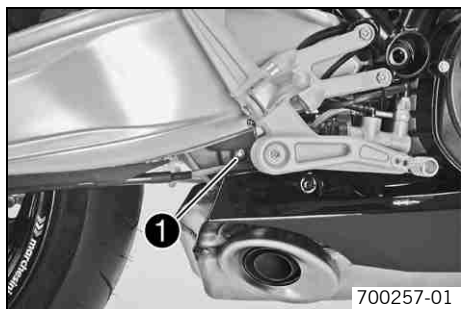

- Turn the adjusting screw ❶ clockwise up to the last perceptible click.
- Turn back counterclockwise the number of clicks corresponding to the shock absorber type.

Guideline

Rebound damping	
Comfort	15 clicks
Standard	10 clicks
Sport	5 clicks
full payload	10 clicks



### Info

Turn clockwise to increase damping, turn counterclockwise to reduce suspension damping.

## Adjusting spring preload of shock absorber ↴



### Warning

**Danger of accidents** Modifications to the chassis can seriously alter the vehicle's handling characteristics.

- Following modifications, ride slowly at first to get the feel of the new handling characteristics.

## **i** Info

The spring preload defines the initial situation of the spring process on the shock absorber. An optimally adjusted spring preload is adapted to the rider's weight and ensures a compromise between easy handling and stability.

- Take the weight off the rear wheel and swingarm.

## **i** Info

The spring preload can be adjusted correctly only if the rear wheel and the swingarm are fully relieved of weight.

- Loosen screw ❶ two turns, but do not remove.

- Turn the adjusting ring anticlockwise with the toolset wrench until the spring is completely relaxed.

Hook wrench (69012022000)
Extension (60012060000)

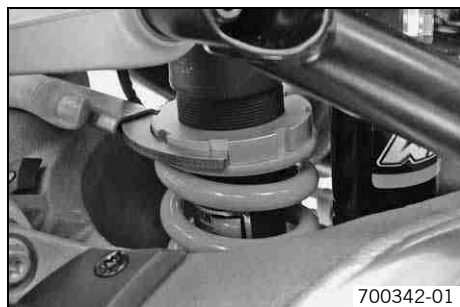
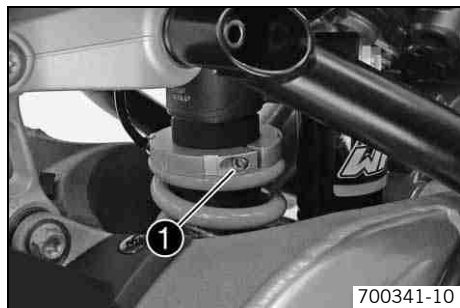

- Turn the adjusting ring clockwise and tension it to the specified value.

Guideline

Spring preload	
Comfort	6 mm (0.24 in)
Standard	6 mm (0.24 in)
Sport	8 mm (0.31 in)
full payload	8 mm (0.31 in)



**Info**

Turn clockwise to increase preload, turn counterclockwise to reduce spring preload.

- Tighten screw ②.

Guideline

Remaining chassis screws	M5	5 Nm (3.7 lbf ft)
--------------------------	----	-------------------

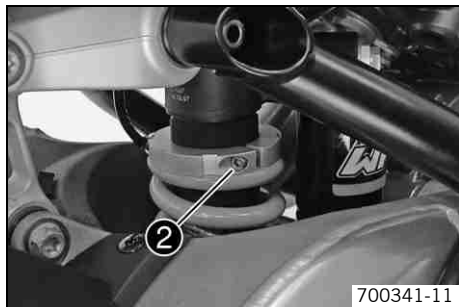

700341-11

## Steering damper



The steering damper suppresses shocks to the steering arising from acceleration on uneven ground at high speed or when the load is temporarily taken from the front wheel. The steering damper is adjusted to suit the manner of driving and the road conditions. For high speeds, an adjustment with high damping can be chosen in order to use the steering damping function optimally. In slow, tight bends, intensive damping can negatively affect handling and steering precision, so the damping should be set to low.

## Adjusting the steering damper

### **i** Info

The hydraulic steering damper stabilizes the steering if the front wheel is raised off the ground or carries no load. In contrast to other damping elements, the steering damper is adjusted with the damping element open.

- Turn the adjusting screw ❶ anticlockwise towards "-" as far as the last perceptible click.



- Adjust the steering damper according to your riding style and the road conditions by turning the adjust screw clockwise towards "+".

Guideline

Steering damper adjustment range	1... 32 clicks
Recommended range for use	1... 20 clicks
Standard	1 click

## Info

Do not change the adjustment of the steering damper during the journey!  
After adjusting the steering damper, check the steering for smooth operation, making sure that the handlebar can be moved from extreme left to extreme right without a tendency to lock.

## Vehicle level



### Warning

**Danger of accidents** Modifications to the chassis can seriously alter the vehicle's handling characteristics.

- Following modifications, ride slowly at first to get the feel of the new handling characteristics.

The vehicle level can be adjusted at the front by means of the fork leg clamp and at the rear by the eccentric shaft.

The fork legs can be clamped at three positions in the triple clamps.

Upper triple clamp flush with upper edge of fork legs	0 mm (0 in)
Upper triple clamp flush with 1st ring of fork legs	2.5 mm (0.098 in)
Upper triple clamp flush with 2nd ring of fork legs (standard)	5 mm (0.2 in)

The chassis height can be adjusted steplessly by turning the eccentric shaft.

Chassis height difference <b>HIGH - LOW</b>	7 mm (0.28 in)
Maximum adjustment range between <b>HIGH - LOW</b>	180°

## Adjusting vehicle level, front



### Warning

**Danger of accidents** Modifications to the chassis can seriously alter the vehicle's handling characteristics.

- Following modifications, ride slowly at first to get the feel of the new handling characteristics.

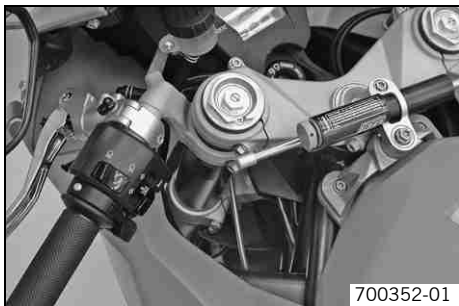

- Loosen the clamp screws of the lower and upper triple clamps and of the handlebar stub.

### Info

Loosen the clamp screws far enough to prevent damage to the lacquer when the fork legs are moved.

Make the adjustments first on one fork leg and then on the other. If the clamp screws of both fork legs are loosened, the vehicle sags towards the front.





- The fork legs can be fixed at three different positions.

#### Guideline

Upper triple clamp flush with upper edge of fork legs	0 mm (0 in)
Upper triple clamp flush with 1st ring of fork legs	2.5 mm (0.098 in)
Upper triple clamp flush with 2nd ring of fork legs (standard)	5 mm (0.2 in)



#### Info

The standard adjustment is optimal for handling the vehicle. When the fork is compressed, the chassis setting changes, the vehicle becomes more stable, but handling is more difficult.

- Tighten the screws.

#### Guideline

Screw, top triple clamp	M8	17 Nm (12.5 lbf ft)
Screw, bottom triple clamp	M8	15 Nm (11.1 lbf ft)
Screw, handlebar stub	M8	20 Nm (14.8 lbf ft)

- Repeat the adjustment on the other fork leg.

## Adjusting vehicle level at rear



#### Warning

**Danger of accidents** Modifications to the chassis can seriously alter the vehicle's handling characteristics.

- Following modifications, ride slowly at first to get the feel of the new handling characteristics.

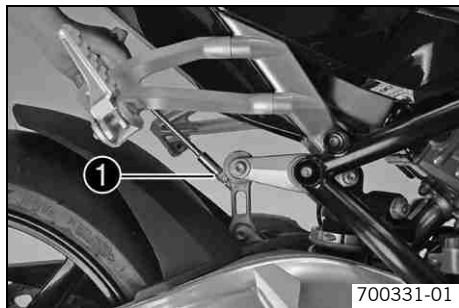

- Loosen screw ❶ but do not remove it.

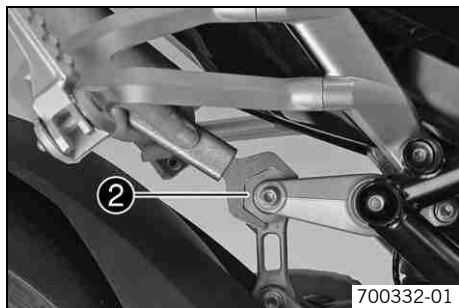

- Turn the eccentric shaft ❷ to the desired position using the tool from the tool set.

Guideline

Standard	<b>LOW</b>
Maximum adjustment range between <b>HIGH - LOW</b>	180°

Open end wrench SW 38 (69012021000)

**i** **Info**  
You can adjust the chassis height in both directions.

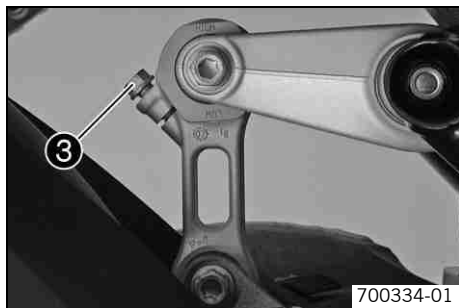

- Tighten screw ③.

Guideline

Remaining chassis screws	M8	25 Nm (18.4 lbf ft)
--------------------------	----	---------------------

## Footrest position

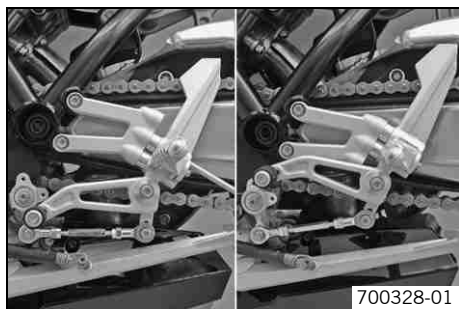

The adjustable footrest system enables an individual setting of the footrest height and an individual adjustment of the operating elements. The lower footrest position enables a more comfortable knee angle, the upper footrest position a sporting sitting position and more forward-leaning freedom for use in racing.

## Adjusting footrest position



### Info

The footrest position must be identical on the left and the right.

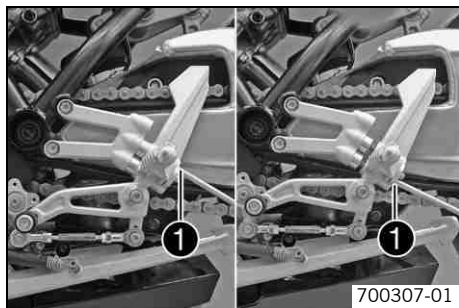

- Remove screws ❶.

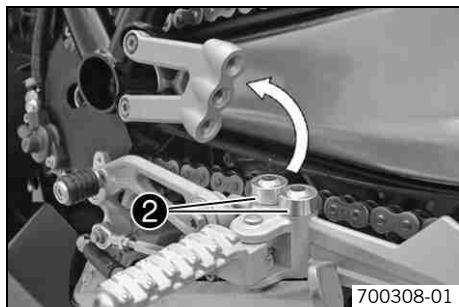

- Position the footrest bracket with spacers ❷ and screws.

Guideline

Standard	Lower position
----------	----------------

**i** **Info**

The adjustable footrest bracket enables a more comfortable lower footrest position or a sporting upper footrest position.

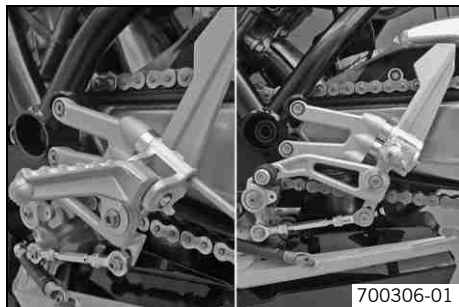

- Mount and tighten screws.

Guideline

Screw, front footrest bracket	M8	25 Nm (18.4 lbf ft)	<b>Loctite® 243™</b>
-------------------------------	----	------------------------	----------------------



- Repeat adjustment work on the footrest bracket on the other side.
- Adjust the shift lever. (☛ S. 116)
- Adjust the footbrake pedal. (☛ S. 121)

## Adjusting shift lever stub

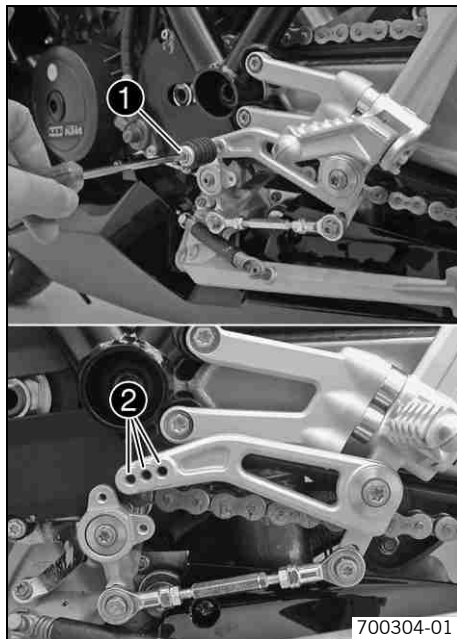

- Remove the screw ❶ with the shift lever stub.
- Position the shift lever stub with the screw in one of the holes ❷ according to the desired lever length.

Guideline

Standard	Central hole
----------	--------------

- Tighten screw.

Guideline

Screw, shift lever stub	M6	10 Nm (7.4 lbf ft)	<b>Loctite® 243™</b>
-------------------------	----	-----------------------	----------------------

## Adjusting shift lever

- i Info** The footrest system offers many ways of adjusting the shift lever to your riding style and requirements.

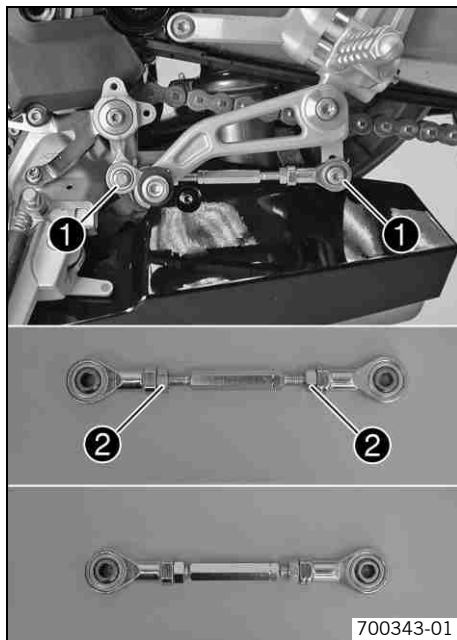

- Remove screws ❶ and take off the shift rod.
- The length of the shift rod can be adjusted by means of the screw thread.

## Guideline

Shift rod	115... 130 mm (4.53... 5.12 in)
-----------	---------------------------------

- Loosen the counter nuts ❷.
- Adjust the shift shaft.

## **i** Info

Make the same adjustments on both sides.

After the counter nuts have been tightened, the bearings of the shift shaft must be central and aligned identically to each other in order to ensure freedom of movement in the bearing shells.

At least 5 screw threads must be screwed into the seating.

- Tighten the counter nuts.

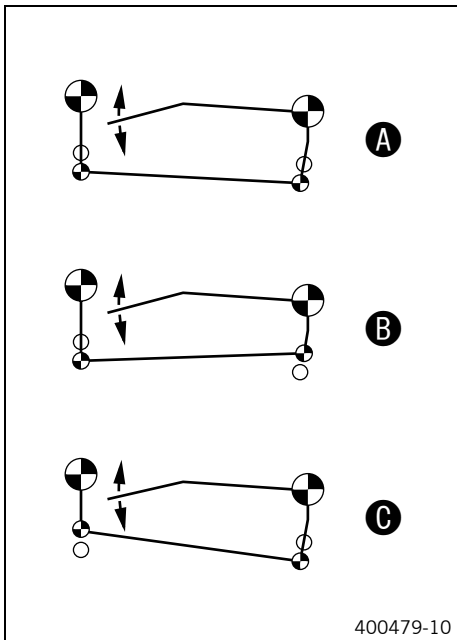

- The shift rod can be mounted both on the shift lever variably at an upper or lower position, and on the reverse gear change of the shift shaft in two different positions.

Guideline

Standard <b>A</b>	Shift lever: lower drill hole, shift shaft: lower drill hole
Shift power low, shift way long <b>B</b>	Shift lever: lower drill hole, shift shaft: upper drill hole
Shift power high, shift way short <b>C</b>	Shift lever: upper drill hole, shift shaft: lower drill hole

- Position the shift rod.
- Tighten the screws.

Guideline

Screw, shift rod	M6	12 Nm (8.9 lbf ft)	<b>Loctite® 243™</b>
------------------	----	-----------------------	----------------------



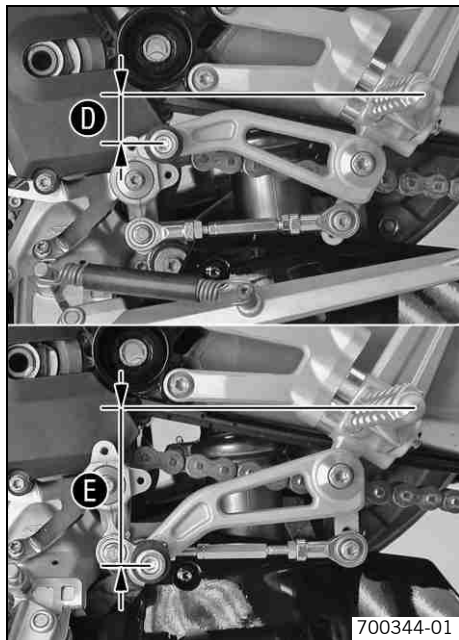

- The position of the shift lever can be greatly varied, depending on the length of the shift rod and the drill holes selected. As seen from the footrest, there is either a high position of the shift lever **D** or a low position of the shift lever **E**.

**i** **Info**

If you turn the reverse shift shaft 2 teeth on the serration of the shift shaft, you can adjust the footrest system optimally for the upper footrest position.

- After adjusting the shift lever, conduct a function test. There must be a minimum distance between the moving parts of the shift lever and other parts of the vehicle.

Guideline

Minimum distance	5 mm (0.2 in)
------------------	---------------

## Adjusting the footbrake pedal stub

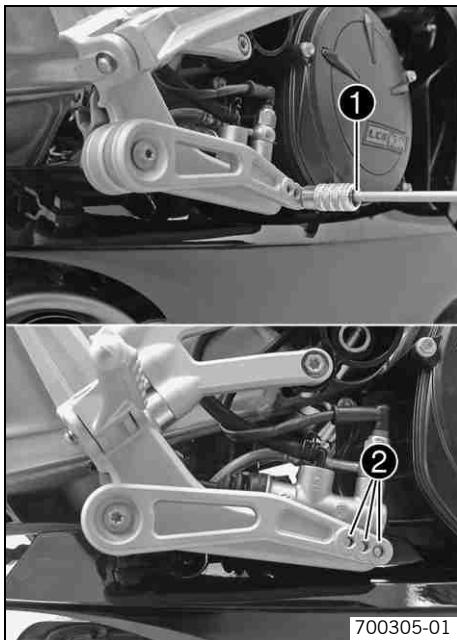

- Remove the screw ❶ with the footbrake pedal stub.
- Position the footbrake pedal stub with the screw in one of the holes ❷ according to the desired lever length.

Guideline

Standard	Central hole
----------	--------------

- Tighten screw.

Guideline

Screw, footbrake pedal stub	M6	10 Nm (7.4 lbf ft)	<b>Loctite® 243™</b>
-----------------------------	----	-----------------------	----------------------

## Adjusting the footbrake pedal

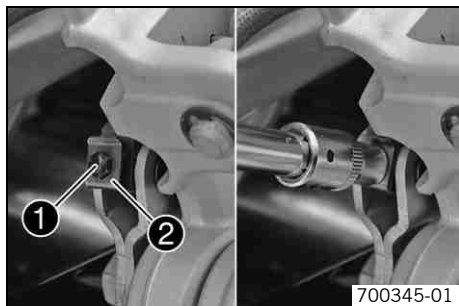

- Use the tool to press in the anti-rotation lock **2**, then turn the piston rod **1**.



### Info

The range of adjustment is limited.

- Remove the tool.
  - ✓ The spring tension on the anti-rotation lock is released and the hex nut is locked.

- Check the footbrake pedal setting.



### Info

Position **A** of the shift lever can vary considerably, depending on the setting.

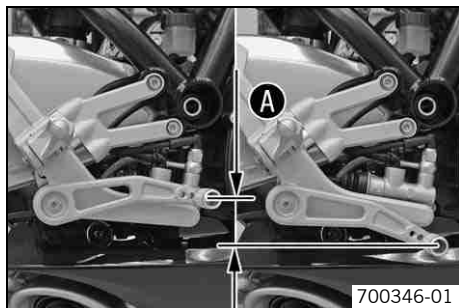

## checking for chain dirt

- Check the chain for loose dirt.
  - » If the chain is very dirty:
    - Clean the chain. (🔧 S. 122)

## Cleaning the chain



### Warning

**Danger of accidents** Oil or grease on the tires reduces their grip.

- Remove oil and grease with a suitable cleaning material.



### Warning

**Danger of accidents** Reduced braking due to oil or grease on the brake discs.

- Always keep the brake discs free of oil and grease, and clean them with brake cleaner when necessary.



### Warning

**Environmental hazard** Problem materials cause environmental damage.

- Dispose of oil, grease, filters, fuel, cleaning substances, brake fluid, batteries, etc. according to regulations.



### Info

The service life of the chain depends largely on its maintenance.

- Clean the chain regularly.
- Rinse off loose dirt with a soft jet of water.
- Remove old grease remains with chain cleaner.

Chain cleaner (☛ S. 224)

- After drying, apply chain spray.

Onroad chain spray (☛ S. 225)

## Checking the chain tension



### Warning

**Danger of accidents** Danger caused by incorrect chain tension.

- If the chain tension is too high, the components of the secondary power train (chain, engine sprocket, rear sprocket, bearings in transmission and rear wheel) are under additional load. Apart from premature wear, in extreme cases the chain can rupture or the countershaft of the transmission can break. On the other hand, if the chain is loose, it can fall off the engine sprocket or the rear sprocket and block the rear wheel or damage the engine. Check for correct chain tension and adjust if necessary.

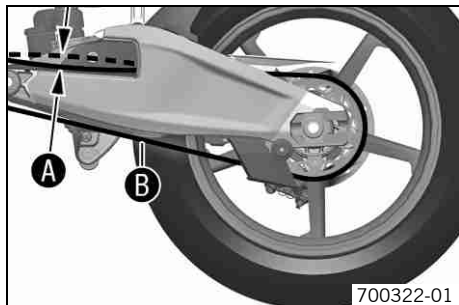

- Lean the motorcycle on the side stand.
- Shift into neutral.
- In the area before where the chain passes through the link fork, push the chain downwards and measure the chain tension **A**.

### **i** Info

The lower chain section **B** must be taut.

Chain wear is not always even, so you should repeat this measurement at different chain positions.

Chain tension	15... 20 mm (0.59... 0.79 in)
---------------	-------------------------------

- » If the chain tension does not meet specifications:
  - Adjust the chain tension. (🔧 S. 124)

## Adjusting the chain tension



### Warning

**Danger of accidents** Danger caused by incorrect chain tension.

- If the chain tension is too high, the components of the secondary power train (chain, engine sprocket, rear sprocket, bearings in transmission and rear wheel) are under additional load. Apart from premature wear, in extreme cases the chain can rupture or the countershaft of the transmission can break. On the other hand, if the chain is loose, it can fall off the engine sprocket or the rear sprocket and block the rear wheel or damage the engine. Check for correct chain tension and adjust if necessary.

- Check the chain tension. (👉 S. 123)

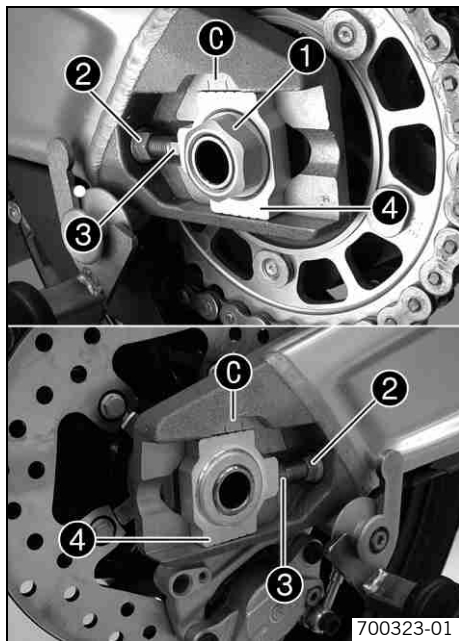

- Loosen nut ❶.
- Loosen nuts ❷.
- Adjust chain tension by turning the adjustment screws ❸ on the left and right.

Guideline

Chain tension	15... 20 mm (0.59... 0.79 in)
Turn the adjusting screws ❸ on the left and right so that the markings on the left and right chain adjuster ❹ are in the same position in relation to the reference marks C. The rear wheel is then correctly aligned.	

## **i** Info

The lower chain section must be taut.

Chain wear is not always even, so you should check the setting at different chain positions.

- Tighten nuts ❷.
- Make sure that the chain adjusters ❹ are on the adjusting screws ❸.
- Tighten nut ❶.

Guideline

Nut, rear wheel spindle	M25x1.5	90 Nm (66.4 lbf ft)	Thread greased
-------------------------	---------	------------------------	----------------

## **i** Info

The wide adjustment range of the chain adjuster (35mm / 1.38") allows different secondary transmission ratios to be used with the same chain length.

The chain adjusters ❹ can be turned through 180°.

## Checking rear sprocket / engine sprocket for wear

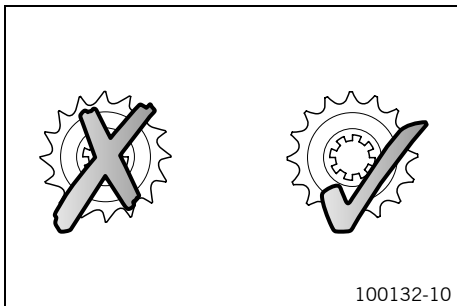

- Check the rear sprocket / engine sprocket for wear.
  - » If the rear sprocket / engine sprocket are worn:
    - Change the rear sprocket / engine sprocket, chain and chain sliding guard. 



### Info

The rear sprocket, engine sprocket, chain and chain sliding guard should always be changed together.



## Checking chain wear

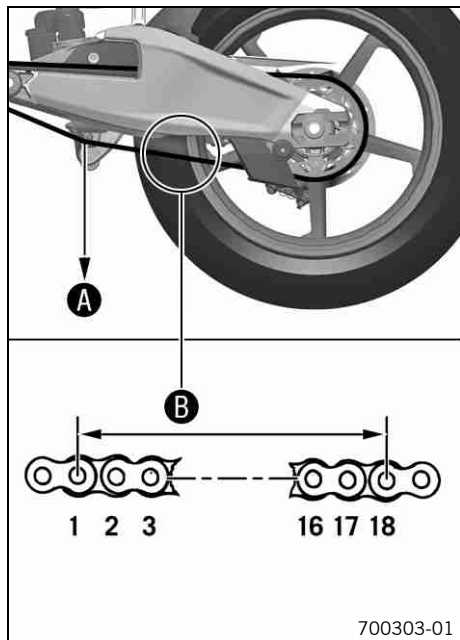

- Engage neutral gear.
- Pull the lower chain section with specified weight **A**.

Guideline

Weight, chain wear measurement	15 kg (33 lb.)
--------------------------------	----------------

- Measure distance **B** of 18 chain links in the lower chain section.

### **i** Info

Chain wear is not always even, so you should repeat this measurement at different chain positions.

Maximum distance <b>B</b> at the longest chain section	272 mm (10.71 in)
--	-------------------

- » If the distance **B** is greater than the specified measurement:
  - Change the rear sprocket / engine sprocket, chain and chain sliding guard.

### **i** Info

New chains wear out faster on old, worn sprockets. For safety reasons, the chain has no chain joint. Always have the chain changed in an authorized KTM-RC8 workshop, where they have the necessary special tools.

## Checking chain sliding guard

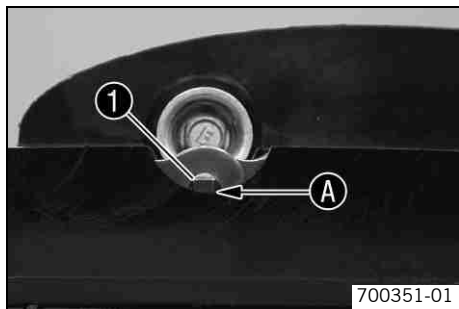

- Check the chain sliding guard for wear at the opening.
  - » If the rivets ❶ of the chain are no longer visible at the lower edge ❷ of the opening of the chain sliding guard:
    - Change the chain sliding guard. 🛠️

## Checking front brake discs



### Warning

**Danger of accidents** Reduced braking effect caused by worn brake discs.

- Have worn brake discs replaced immediately in an authorized KTM-RC8 workshop.

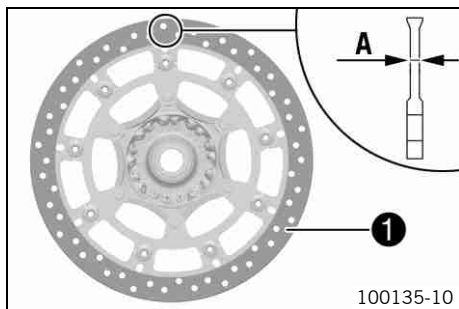

- Check the thickness of the brake disc in several places to see if it conforms to measurement ❷.



### Info

Wear reduces the thickness of the brake discs in area ❶ of the brake discs.

Brake discs - wear limit	
front	4.0 mm (0.157 in)

front	4.0 mm (0.157 in)
-------	-------------------

- » If the brake disc thickness is less than the specified value:
  - Change the brake discs. 🛠️

## Checking rear brake disc



### Warning

**Danger of accidents** Reduced braking effect caused by worn brake discs.

- Have worn brake discs replaced immediately in an authorized KTM-RC8 workshop.

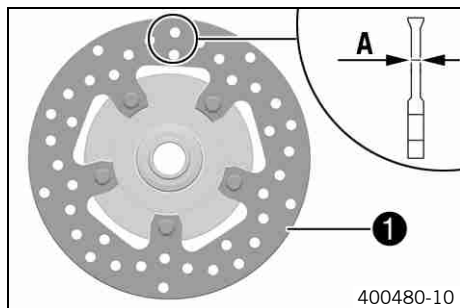

- Check the thickness of the brake disc in several places to see if it conforms to measurement **A**.

### Info

Wear reduces the thickness of the brake disc in area **1** of the brake disc.

#### Brake discs - wear limit

rear	4.5 mm (0.177 in)
------	-------------------

- » If the brake disc thickness is less than the specified value:
  - Change brake disc. 🛠️

## Adjusting the basic position of the handbrake lever

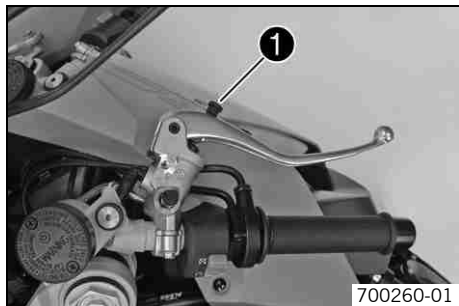

- Pull the brake lever forwards.
- Adjust the neutral position of the handbrake lever to your hand position by turning the adjusting screw **1**.

### Info

Do not make any adjustments while riding!

## Checking brake fluid level of front brake



### Warning

**Danger of accidents** Failure of brake system.

- If the brake fluid level falls below the **MIN** mark, there may be a leak in the brake system or the brake linings are completely worn out. Have the brake system checked in an authorized KTM-RC8 workshop before continuing your journey.



### Warning

**Danger of accidents** Reduced braking effect caused by old brake fluid.

- Have the brake fluid of the front and rear brakes changed according to the service plan in an authorized KTM-RC8 workshop.

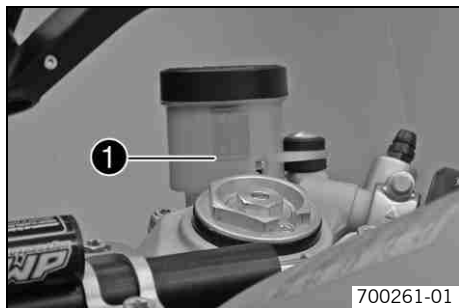

- The brake fluid level must not fall below the **MIN** marking ❶ when the brake fluid reservoir is vertical.
  - » If the brake fluid is below the **MIN** marking:
    - Top up the brake fluid of the front brake. 🛠️ (👉 S. 130)

## Topping up brake fluid of front brake 🛠️



### Warning

**Danger of accidents** Failure of brake system.

- If the brake fluid level falls below the **MIN** mark, there may be a leak in the brake system or the brake linings are completely worn out. Have the brake system checked in an authorized KTM-RC8 workshop before continuing your journey.



## Warning

**Skin irritations** Brake fluid can cause skin irritation on contact.

- Avoid contact with skin and eyes, and keep out of the reach of children.
- If brake fluid gets into your eyes, rinse thoroughly with water and contact a doctor immediately.



## Warning

**Danger of accidents** Reduced braking effect caused by old brake fluid.

- Have the brake fluid of the front and rear brakes changed according to the service plan in an authorized KTM-RC8 workshop.



## Warning

**Environmental hazard** Problem materials cause environmental damage.

- Dispose of oil, grease, filters, fuel, cleaning substances, brake fluid, batteries, etc. according to regulations.



## Info

Never use DOT 5 brake fluid! This is based on silicone oil and is colored purple. Oil seals and brake lines are not designed for DOT 5 brake fluid.

Avoid contact between brake fluid and painted parts. Brake fluid attacks paint!

Use only clean brake fluid from a sealed container!

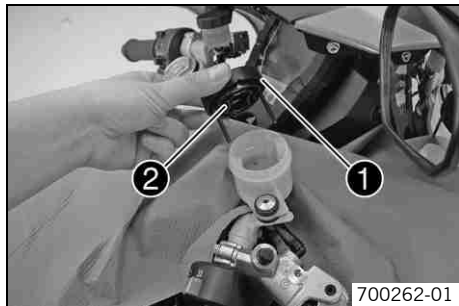

- Loosen screw.
- Remove cover ① with membrane ②.
- Top up the brake fluid to **MAX** level.

Brake fluid DOT 4 / DOT 5.1 (☞ S. 221)

- Position the cover with the membrane. Mount and tighten screws.



## Info

Clean up overflowed or spilt brake fluid immediately with water.

## Brake linings

The brake linings fitted by KTM have been tested over long periods and guarantee optimal braking characteristics. The type names of the brake linings are entered in the homologation documents.



### Info

Brake linings available in accessories shops are often untested and unapproved for use on KTM vehicles. The structure and friction coefficient of the brake linings, and therefore the brake power, can vary considerably from the original KTM brake linings. If brake linings other than those supplied as originals are used, there is no guarantee that they correspond to the original homologation. The vehicle then no longer corresponds to the condition at delivery and the guarantee is no longer valid.

## Checking the front brake linings



### Warning

**Danger of accidents** Reduced braking caused by worn brake linings.

- Have worn brake linings replaced immediately in an authorized KTM-RC8 workshop.

### Note

**Danger of accidents** Reduced braking due to damaged brake discs.

- If the brake linings are not changed in time, the steel brake lining carriers grind on the brake disc. The braking effect is greatly reduced and the brake discs are destroyed.

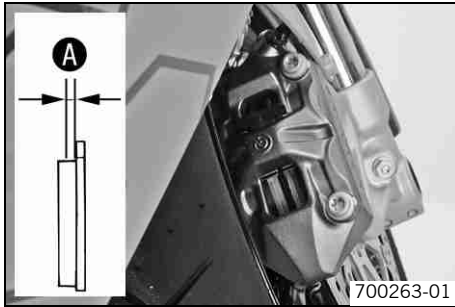

- Check the brake linings for minimum thickness **A**.

Minimum thickness <b>A</b>	$\geq 1 \text{ mm } (\geq 0.04 \text{ in})$
----------------------------	---

- » If the minimum thickness is less than specified:
  - Change the front brake linings. 

## Checking rear brake fluid level



### Warning

**Danger of accidents** Failure of brake system.

- If the brake fluid level falls below the **MIN** mark, there may be a leak in the brake system or the brake linings are completely worn out. Have the brake system checked in an authorized KTM-RC8 workshop before continuing your journey.



### Warning

**Danger of accidents** Reduced braking effect caused by old brake fluid.

- Have the brake fluid of the front and rear brakes changed according to the service plan in an authorized KTM-RC8 workshop.

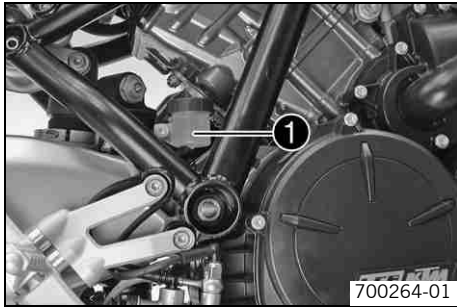

- Stand the vehicle upright.
- Check the brake fluid level of the brake fluid reservoir.
  - » If the fluid level reaches the **MIN** mark ❶:
    - Top up the rear brake fluid. 🛠️ (👉 S. 134)

## Topping up rear brake fluid 🛠️

 **Warning**  
**Danger of accidents** Failure of brake system.

- If the brake fluid level falls below the **MIN** mark, there may be a leak in the brake system or the brake linings are completely worn out. Have the brake system checked in an authorized KTM-RC8 workshop before continuing your journey.

 **Warning**  
**Skin irritations** Brake fluid can cause skin irritation on contact.

- Avoid contact with skin and eyes, and keep out of the reach of children.
- If brake fluid gets into your eyes, rinse thoroughly with water and contact a doctor immediately.

 **Warning**  
**Danger of accidents** Reduced braking effect caused by old brake fluid.

- Have the brake fluid of the front and rear brakes changed according to the service plan in an authorized KTM-RC8 workshop.





## Warning

**Environmental hazard** Problem materials cause environmental damage.

- Dispose of oil, grease, filters, fuel, cleaning substances, brake fluid, batteries, etc. according to regulations.



## Info

Never use DOT 5 brake fluid! This is based on silicone oil and is colored purple. Oil seals and brake lines are not designed for DOT 5 brake fluid.

Avoid contact between brake fluid and painted parts. Brake fluid attacks paint!

Use only clean brake fluid from a sealed container!

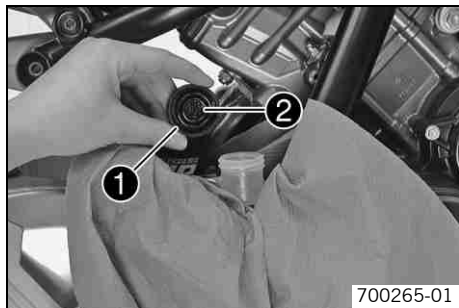

- Stand the vehicle upright.
- Remove screw cover ❶ with membrane ❷.
- Top up the brake fluid to **MAX** level.

Brake fluid DOT 4 / DOT 5.1 (☞ S. 221)

- Refit screw with membrane.



## Info

Clean up overflowed or spilt brake fluid immediately with water.

## Checking the rear brake linings



## Warning

**Danger of accidents** Reduced braking caused by worn brake linings.

- Have worn brake linings replaced immediately in an authorized KTM-RC8 workshop.

## Note

**Danger of accidents** Reduced braking due to damaged brake discs.

- If the brake linings are not changed in time, the steel brake lining carriers grind on the brake disc. The braking effect is greatly reduced and the brake discs are destroyed.

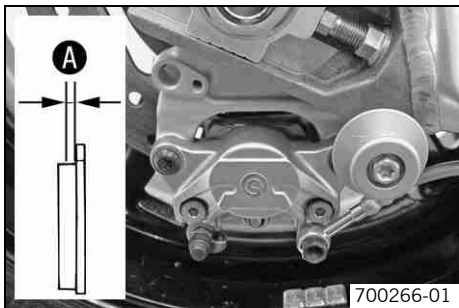



- Check the brake linings for minimum thickness **A**.

Minimum thickness <b>A</b>	$\geq 1 \text{ mm } (\geq 0.04 \text{ in})$
----------------------------	---

- » If the minimum thickness is less than specified:
  - Change the rear brake linings. 

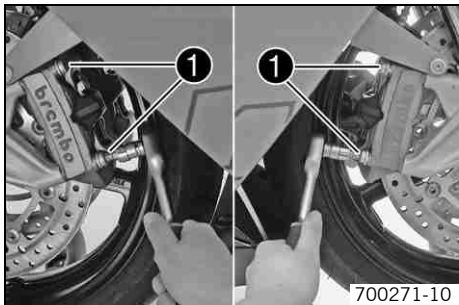
## Removing front wheel



- Jack up the motorcycle rear end. ( S. 96)
- Jack up the motorcycle at the front. ( S. 95)
- Remove the screws **1** from both brake calipers.
- Press back the brake linings with a light lateral tilting of the brake calipers on the brake disc. Pull the brake caliper carefully back from the brake disc and hang it to one side.

### Info

Do not pull the handbrake lever when the brake calipers are removed.

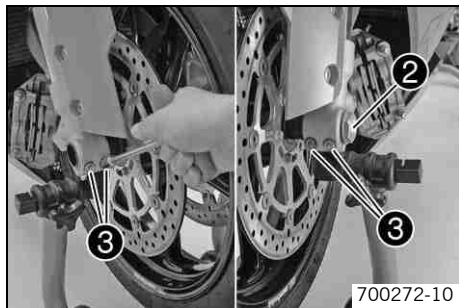

- Loosen screws ② and ③.
- Unscrew screw ② about 6 turns, press your hand on the screw to push the wheel spindle out of the fork stub. Remove screw ②.



**Warning**

**Danger of accidents** Reduced braking effect caused by damaged brake discs.

- Always lay the wheel down in such a way that the brake discs are not damaged.

- Holding the front wheel, withdraw the wheel spindle. Take the front wheel out of the fork.

## Fitting front wheel

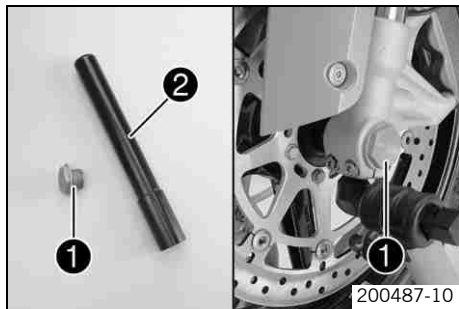

**Warning**

**Danger of accidents** Reduced braking due to oil or grease on the brake discs.

- Always keep the brake discs free of oil and grease, and clean them with brake cleaner when necessary.

- Clean screw ① and wheel spindle ②.
- Lift the front wheel into the fork, position it, and insert the wheel spindle.
- Mount and tighten screw ①.

Guideline

Screw, front wheel spindle	M25x1.5	45 Nm (33.2 lbf ft)
----------------------------	---------	---------------------

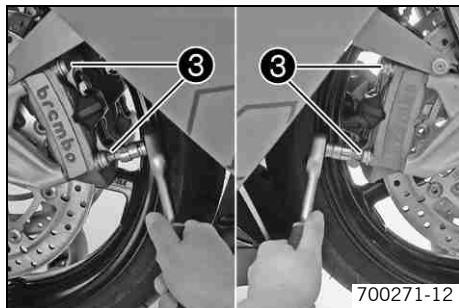

- Position the brake calipers and check that the brake linings are seated correctly.
- Mount and tighten screws ③.

Guideline

Screw, front brake caliper	M10x1.25	45 Nm (33.2 lbf ft)	<b>Loctite® 243™</b>
----------------------------	----------	------------------------	----------------------

- Operate the hand brake lever several times until the brake pads are lying correctly on the brake disc.
- Take the front of the motorcycle off the work stand. (🔧 S. 95)
- Take the rear of the motorcycle off the work stand. (🔧 S. 96)
- Pull the front brake and compress the fork powerfully a few times.
- ✓ The fork legs straighten.
- Fully tighten screws ④.

Guideline

Screw, fork stub	M8	15 Nm (11.1 lbf ft)
------------------	----	---------------------

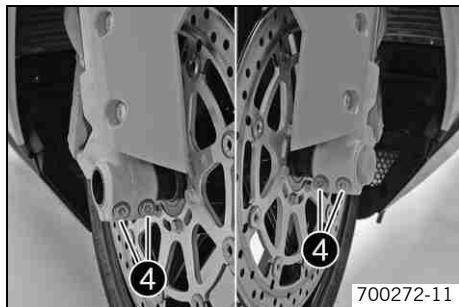

## Removing rear wheel 🛠️

- Jack up the motorcycle rear end. (🔧 S. 96)

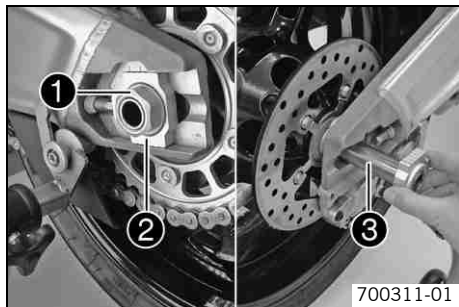

- Remove nut ❶. Remove chain adjuster ❷. Withdraw the wheel spindle ❸.

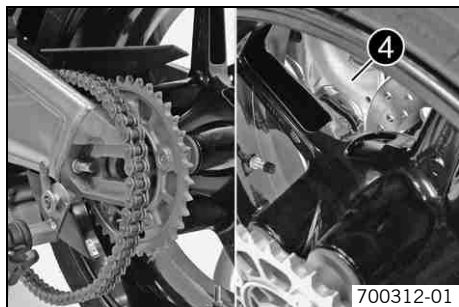

- Push the rear wheel forwards as far as possible and take the chain off the rear sprocket.
- Pull the rear wheel backwards until the brake caliper support ❹ hangs free between the brake disc and the wheel rim.



## Warning

**Danger of accidents** Reduced braking effect caused by damaged brake discs.

- Always lay the wheel down in such a way that the brake discs are not damaged.

- Take the rear wheel carefully out of the swingarm without damaging the rim and/or brake disc.



## Info

Do not operate the foot brake when the rear wheel is removed.

## fitting the rear wheel



### Warning

**Danger of accidents** Reduced braking due to oil or grease on the brake discs.

- Always keep the brake discs free of oil and grease, and clean them with brake cleaner when necessary.



### Warning

**Danger of accidents** No braking effect when operating the rear brake.

- After installing the rear wheel, always operate the footbrake until the pressure point is reached.

- Check the rear hub shock absorbers.  ( S. 143)

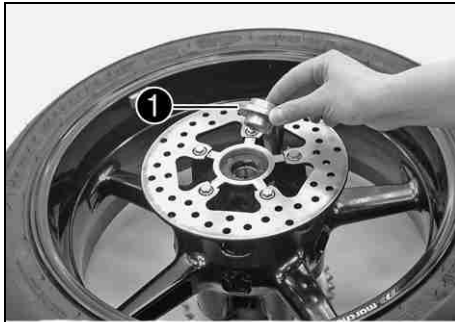

- Remove bushing ❶ and bushing ❷. Clean and grease the roll surfaces of the bushing and the shaft seal rings.

Long-life grease (☛ S. 224)

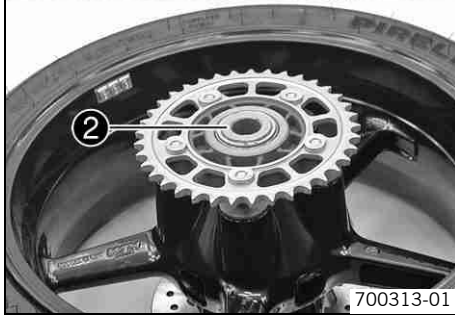

- Fit the bushings.
- Clean the thread of the wheel spindle and nut.
- Clean the contact areas of the brake caliper support and swingarm.

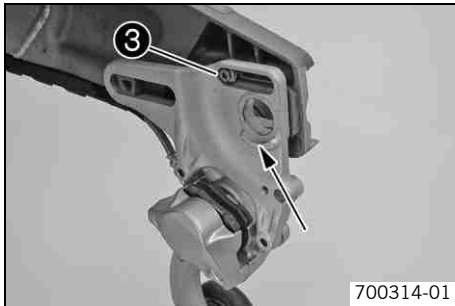

- Push the brake caliper support ❸ completely to the rear.
- Position the rear wheel, and position the brake caliper support between the rim and the brake disc.
- Position the brake caliper on the brake disc.
- Position the rear wheel on the bearing surfaces in the swingarm.

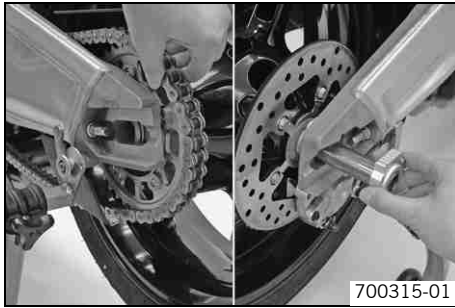

- Push the rear wheel forward as far as possible and place the chain on the rear sprocket.
- Pull the rear wheel back and push in the wheel spindle.

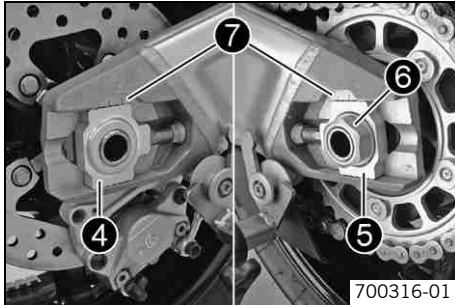

- Lay the chain adjuster ④ on the tensioning screw.
- Position the chain adjuster ⑤ and place it on the tensioning screw.
- Tighten nut ⑥.

Guideline

In order for the rear wheel to be correctly aligned, the markings on the left and right chain adjusters must be in the same position relative to the reference marks ⑦.

Nut, rear wheel spindle	M25x1.5	90 Nm (66.4 lbf ft)	Thread greased
-------------------------	---------	------------------------	----------------

- Operate the foot brake lever repeatedly until the brake linings lie on the brake disc and there is a tight spot.
- Take the rear of the motorcycle off the work stand. (🔧 S. 96)
- Check the chain tension. (🔧 S. 123)



## Checking rear hub shock absorbers 🛠️

### **i** Info

The engine power is transmitted by the rear sprocket to the rear wheel through 5 shock absorbers. They are subject to wear during operation. If the shock absorbers are not changed in time, the rear sprocket carrier and the rear hub are damaged.

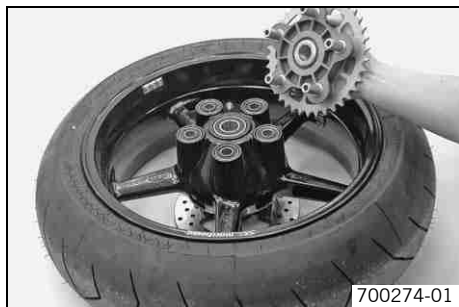

- Remove the rear wheel. 🛠️ (👉 S. 138)
- Remove the rear sprocket carrier.
- Check the rear hub for damage and wear.
  - » If the rear hub shock absorbers are damaged or worn:
    - Change the shock absorber. 🛠️
- Position the rear sprocket carrier.

### **i** Info

A set of bolts and shock absorbers with as little free play as possible increases the service life of the shock absorbers.

- Fitting the rear wheel. 🛠️ (👉 S. 140)

## Tire condition checking



### **Warning**

**Danger of accidents** Uncontrollable handling behavior caused by a flat tire.

- For your own safety, have damaged tires changed immediately.



### **Warning**

**Danger of crashing** Impairment of riding behavior due to different tire tread patterns on front and rear wheels.

- The front and rear wheels must be fitted with tires with similar tread patterns to prevent loss of control over the vehicle.

- Warning**  
**Danger of accidents** Uncontrollable handling characteristics due to non-approved and/or non-recommended tires/wheels.
- Only tires/wheels approved by KTM and with the corresponding speed index should be used.

- Warning**  
**Danger of accidents** Reduced road grip with new tires.
- New tires have a smooth roll surface and therefore cannot provide full road grip. The entire roll surface must be roughened in the first 200 kilometers (124.3 miles) by moderate driving at alternating angles. The full grip is not reached until the vehicle has been run in.

- i** **Info**  
The type, condition and air pressure of the tires all have an important impact on the riding behavior of the motorcycle. Worn tires have a negative effect on riding behavior, especially on wet surfaces.



- Check the front and rear tire for cuts, penetrations and other damage.
  - » If the tires exhibit cuts, penetrations or other damage:
    - Change the tires.
- Check the depth of the tread.

- i** **Info**  
Note local national regulations concerning the minimum tread depth.

Minimum tread depth	$\geq 2 \text{ mm } (\geq 0.08 \text{ in})$
---------------------	---

- » If the minimum tread depth is insufficient:
  - Change the tires.

## Checking tire air pressure

### **i** Info

Low tire air pressure leads to abnormal wear and overheating of the tire.  
Correct tire air pressure ensures optimal riding comfort and maximum tire service life.

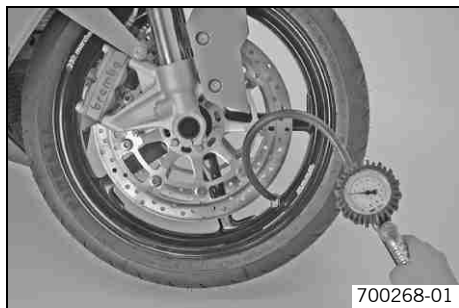

- Remove dust cap.
- Check tire air pressure when tires are cold.

Tire air pressure, Solo	
front	2.5 bar (36 psi)
rear	2.5 bar (36 psi)
Tire air pressure with passenger / full payload	
front	2.5 bar (36 psi)
rear	2.9 bar (42 psi)

- » If the tire pressure does not meet specifications:
  - Correct tire pressure.
- Mount dust cap.

### **i** Info

The rubber seal in the dust cap prevents air leaking out of the tire if the valve is defective.

## Removing the seat

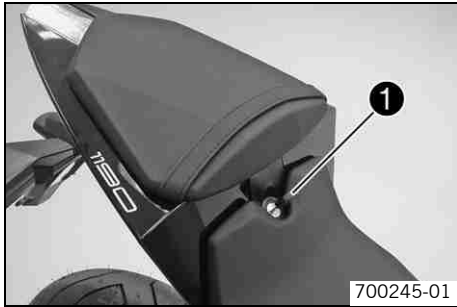

- Insert the ignition key in the seat lock ❶ and turn it anticlockwise.
- Raise the rear of the seat, push it towards the rear, and remove it upwards.

## Fitting the seat

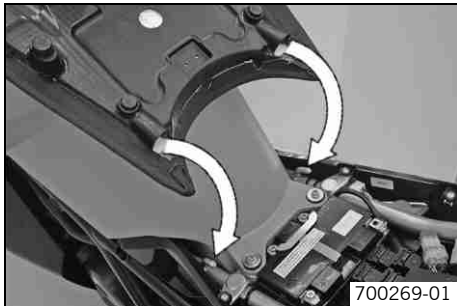

- Position the recesses of the seat to the lugs on the frame, lower the rear end and simultaneously push it forward.
- Lock the seat by turning the ignition key in the seat lock.
- Remove the ignition key from the seat lock.
- Finally, check that the seat is correctly mounted.

## Removing passenger seat

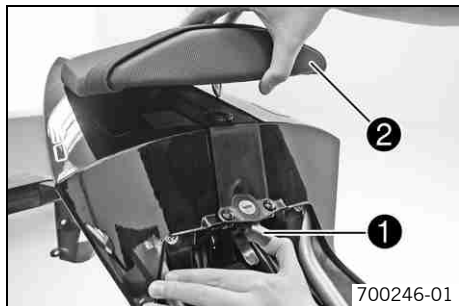

- Remove the seat. (☛ S. 146)
- Operate lever ①.
- Take off the passenger seat ② toward the top.

## Fitting the passenger seat



- Position the passenger seat in the space provided.
- Press down the passenger seat until it clicks into place.
- Finally, check that the passenger seat is correctly mounted.

## Mounting helmet lock on vehicle

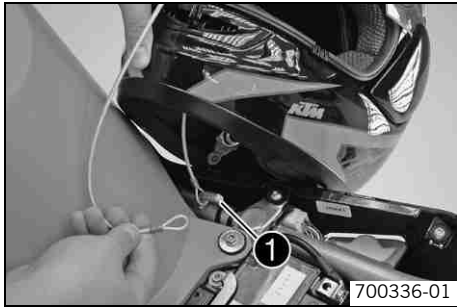

- Remove the seat. (🔧 S. 146)
- Position the steel cable from the toolset with one loop on the lug ❶.

Steel cable (60012015000)

- Guide the steel cable through the helmet opening.
- Then position the free loop of the steel cable on the lug.
- Position the helmet carefully on the side of the motorcycle.
- Fit the seat. (🔧 S. 146)

## Removing the battery 🛠️



### Warning

**Risk of injury** Battery acid and battery gases cause serious cauterization.

- Keep batteries out of the reach of children.
- Wear suitable protective clothing and goggles.
- Avoid contact with battery acid and battery gases.
- Keep the battery away from sparks or open fire. Charge only in well ventilated rooms.
- In the event of skin contact, rinse with large amounts of water. If battery acid gets in the eyes, rinse with water for at least 15 minutes and contact a doctor.

- Switch off all power-consuming components and switch off the engine.
- Remove the seat. (🔧 S. 146)

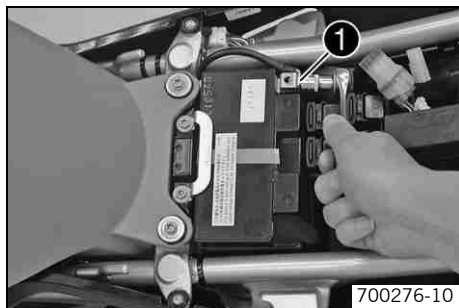

- Disconnect the negative (minus) cable ❶ of the battery.

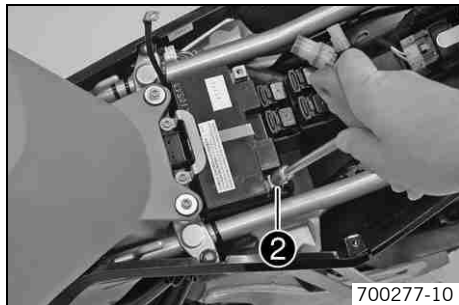

- Remove the plus pole cover.
- Disconnect the positive (plus) cable ❷ of the battery.

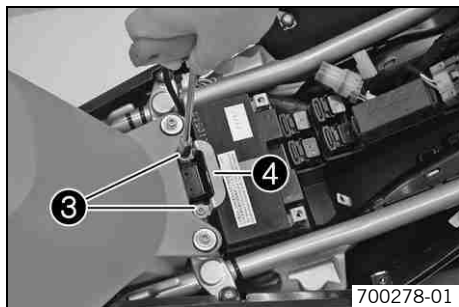

- Remove screws ❸.
- Removing the securing bracket ❹.
- Pull the battery upwards out of the battery rack.

---

**i** **Info**

Never operate the motorcycle with a discharged battery or without a battery. In both cases, electrical components and safety equipment can be damaged. The vehicle is then no longer safe to ride.

---

## Installing the battery

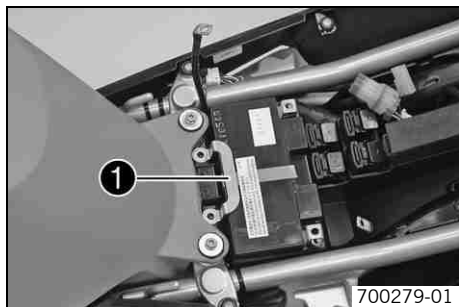

- Position the battery in the battery rack.



### Info

The poles of the battery must face the rear of the vehicle.

- Position the bracket **1**.

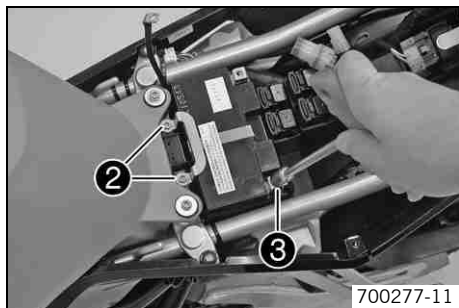

- Mount and tighten screws **2**.

### Guideline

Remaining chassis screws	M6	10 Nm (7.4 lbf ft)
--------------------------	----	--------------------

- Reconnect the positive (plus) **3** cable of the battery.
- Position positive terminal cover.



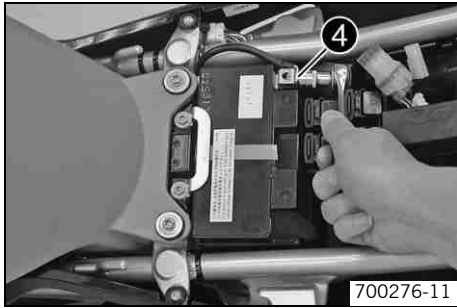

- Reconnect the negative (minus) cable ④ of the battery.
- Fit the seat. (☛ S. 146)

## Recharging the battery ☛



### Warning

**Risk of injury** Battery acid and battery gases cause serious cauterization.

- Keep batteries out of the reach of children.
- Wear suitable protective clothing and goggles.
- Avoid contact with battery acid and battery gases.
- Keep the battery away from sparks or open fire. Charge only in well ventilated rooms.
- In the event of skin contact, rinse with large amounts of water. If battery acid gets in the eyes, rinse with water for at least 15 minutes and contact a doctor.



### Warning

**Environmental hazard** Components and battery acid are a danger to the environment.

- Do not dispose of batteries in normal household waste. Take defective or used batteries to a battery recycling operator.



## Warning

**Environmental hazard** Problem materials cause environmental damage.

- Dispose of oil, grease, filters, fuel, cleaning substances, brake fluid, batteries, etc. according to regulations.
- 



## Info

Even if there is no load on the battery, it loses power every day.

The charge state and the type of charge are very important for the service life of the battery.

Fast recharging with a high charge current shortens the battery's service life.

If the charge current, the charge voltage and the charge time are exceeded, electrolyte escapes through the breathing holes. The battery capacity is then reduced.

If the battery becomes discharged from starting, it must be recharged immediately.

If the battery rests for an extended time in a discharged state, it becomes over-discharged and sulfated, which will result in its destruction.

The battery is maintenance-free, i.e., the acid level does not have to be checked.

---

- Switch off all power-consuming components and switch off the engine.
- Remove the seat. (👉 S. 146)
- Disconnect the negative (minus) cable of the battery to prevent damage to the vehicle's electronics.

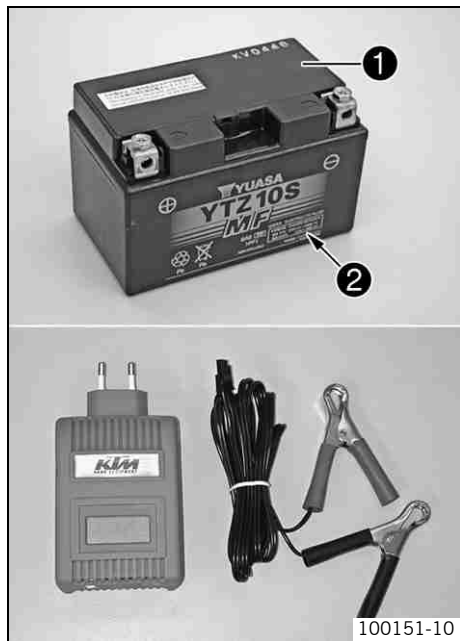

- Connect the battery charger to the battery. Switch on the battery charger.

Battery charger (58429074000)
-------------------------------

You can also use the battery charger to test rest potential and start potential of the battery, and to test the generator. With this device, you cannot overcharge the battery.



### Info

Never remove the lid ❶.

Charge the battery according to the instructions ❷ on the battery casing.

- After charging the battery, switch off the battery charger. Reconnect the battery.

### Guideline

The charge current, charge voltage and charge time must not be exceeded.	
--	--

Charge the battery regularly when the motorcycle is not in use.	3 months
---	----------

- Fit the seat. (☛ S. 146)

## Changing the main fuse



### Warning

**Fire hazard** The electrical system can be overloaded by the use of incorrect fuses.

- Use only fuses with the prescribed amperage. Never by-pass or repair fuses.

## **i** Info

The main fuse protects all power-consuming components of the vehicle. The main fuse is under the seat.

- Switch off all power-consuming components and switch off the engine.
- Remove the seat. (🔧 S. 146)
- Remove protection covers ❶.
- Remove a defective main fuse ❷ with a needle nose plier.

## **i** Info

A reserve fuse ❸ is located in the starter relay.

- Fit a new main fuse.

Fuse (58011109130) (🔧 S. 213)

## **i** Info

If the new fuse burns out, contact an authorized KTM-RC8 workshop.

- Attach the protection covers ❶.
- Fit the seat. (🔧 S. 146)

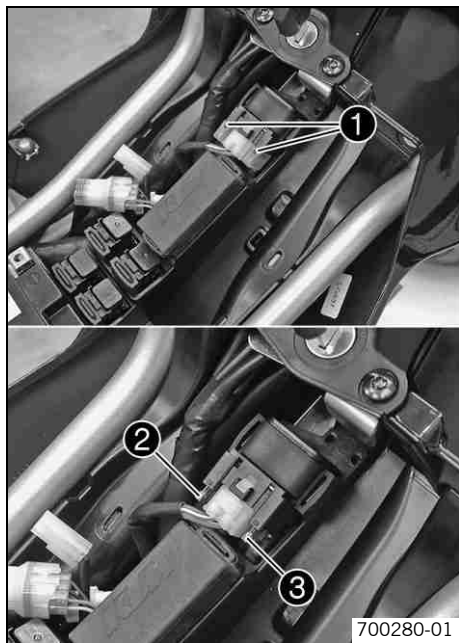

## Changing fuses of individual power consumers

### **i** Info

The fuse box containing the fuses of individual power consumers is located under the seat.

- Switch off all power-consuming components and switch off the engine.
- Remove the seat. (☛ S. 146)
- Open the fuse box cover **1**.

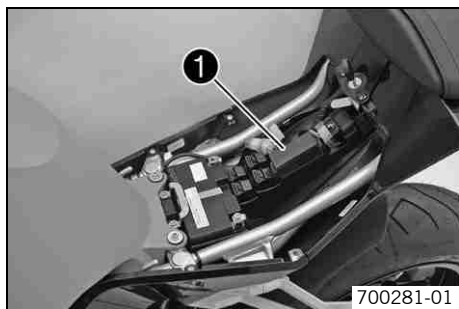

- Check the fuses.

### **i** Info

A defective fuse is shown by a burned-out fuse wire **A**.

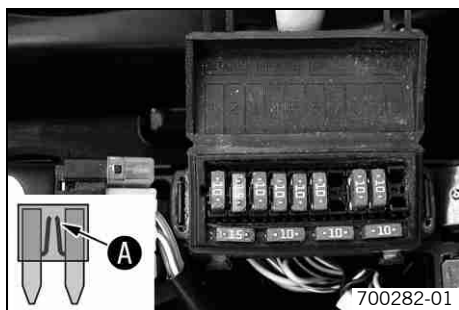

- Remove defective fuse.

## Guideline

Fuse <b>1</b> - 10A - ignition, combination instrument, immobilizer, alarm system (optional)
Fuse <b>2</b> - 15A - high beam, low beam, parking light, tail light, license plate lamp
Fuse <b>3</b> - 10A - horn, brake light
Fuse <b>4</b> - 10A - radiator fan
Fuse <b>5</b> - 10A - fuel pump
Fuse <b>6</b> - 10A - ignition / fuel injection
Fuse <b>7</b> - not used
Fuse <b>8</b> - 10A - for supplementary equipment (standard accessories)
Fuse <b>9</b> - 10A - for supplementary equipment (accessories connected with ignition switch)
Fuse <b>10</b> - not used
Fuse <b>SPARE</b> - 10A/15A - spare fuses

**Warning**

**Fire hazard** The electrical system can be overloaded by the use of incorrect fuses.

- Use only fuses with the prescribed amperage. Never by-pass or repair fuses.

- Use spare fuses with the correct rating only.

Fuse (75011088010) (☛ S. 213)
-------------------------------

Fuse (75011088015) (☛ S. 213)
-------------------------------

**Info**

If the new fuse burns out, contact an authorized KTM-RC8 workshop.

**Tip**

Replace the spare fuse in the fuse box so that it is available if needed.

- Close the fuse box cover.
- Fit the seat. (☛ S. 146)

## Changing the low beam bulb

**Note**

**Damage to reflector** Keep the glass of the bulb free of grease.

- Clean the glass bulb with a clean cloth before mounting. Any grease on the glass will evaporate by the heat and be deposited on the reflector.

- Switch off all power-consuming components and switch off the engine.

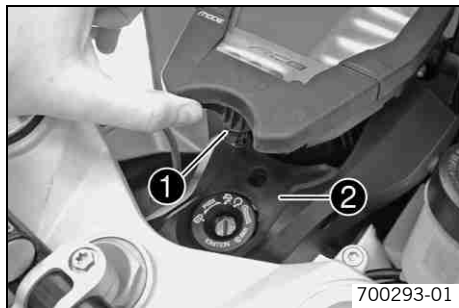

- Fold up the combination instrument. Pull the lug ① out of the rubber holder ②.
- Remove the rubber holder.

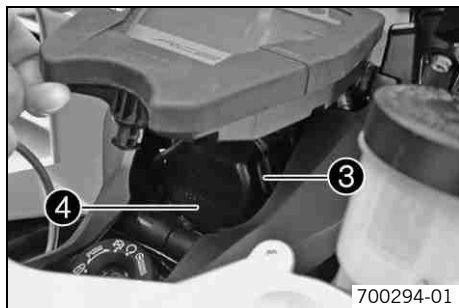

- Release the latch ③.
- Remove the lamp cover ④.

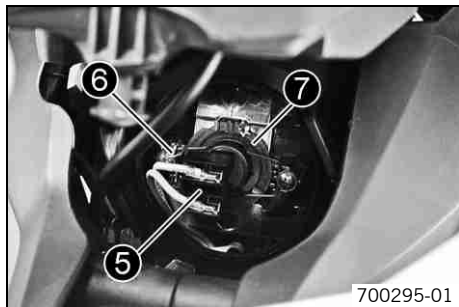

- Disconnect plug-in connector ⑤.
- Push off the retaining clamp ⑥ on both sides, squeeze and fold to the side.
- Remove headlight bulb ⑦.



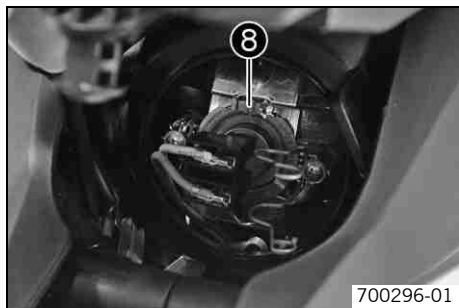

- Position the new headlight bulb in the headlight housing.

Low beam / high beam (H7) (☛ S. 213)

**i** Info

Insert the headlight bulb so that the lug ⑧ is positioned in the cut-out.

- Position the retaining clamp.
- Position the plug-in connector.

- Position the lug ⑨ of the lamp cover in the notch. Engage the latch ⑩.
- Check lighting function.

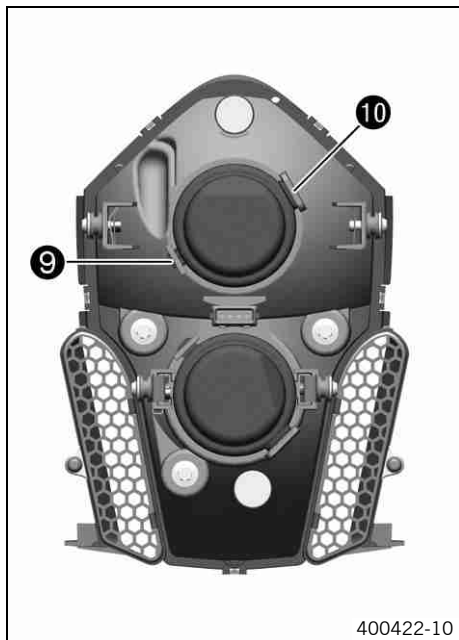

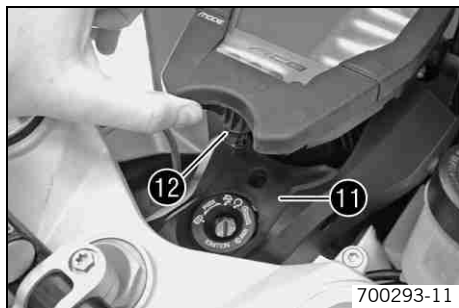

- Position the rubber holder ⑪.
- Fold down the combination instrument. Position the lug ⑫ in the rubber holder.

## Change the high beam bulb.

### Note

**Damage to reflector** Keep the glass of the bulb free of grease.

- Clean the glass bulb with a clean cloth before mounting. Any grease on the glass will evaporate by the heat and be deposited on the reflector.
- 
- Switch off all power-consuming components and switch off the engine.



- Remove screws ❶. Remove cover.

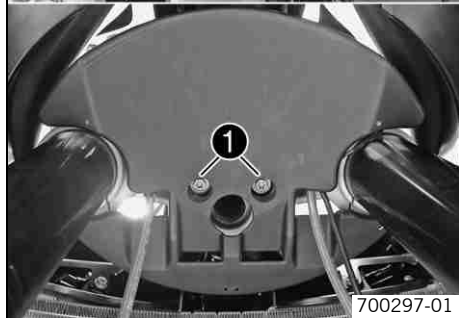

700297-01

- Release the latch ❷.
- Remove the lamp cover ❸.

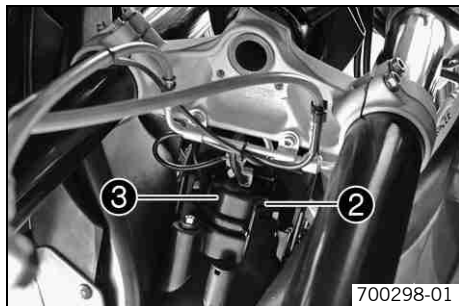

700298-01

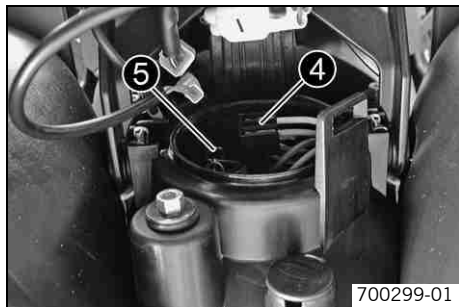

- Disconnect plug-in connector ④.
- Push off the retaining clamp ⑤ on both sides, squeeze and fold to the side.
- Remove headlight bulb.
- Position the new headlight bulb in the headlight housing.

Low beam / high beam (H7) (☛ S. 213)

**i** **Info**

Insert the headlight bulb so that the lug is positioned in the cut-out.

- Position the retaining clamp.
- Position the plug-in connector.

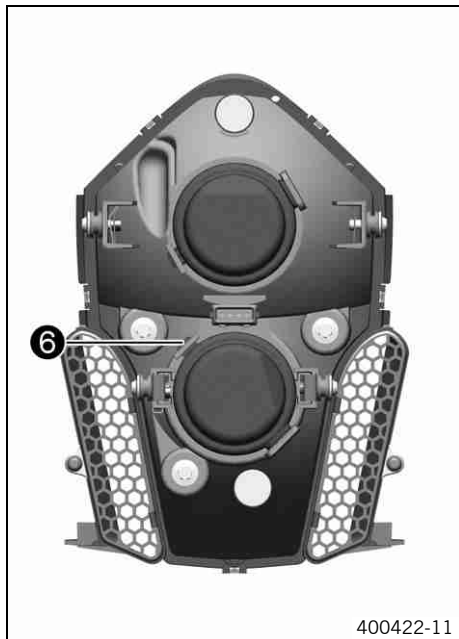

- Position the lug ⑥ of the lamp cover in the notch. Engage the latch.
- Check lighting function.

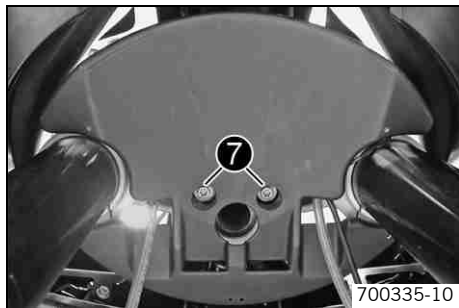

- Position cover.



**Info**

Check for correct positioning and freedom of movement of the brake lines.

- Mount and tighten screws ⑦.

Guideline

Remaining chassis screws	M6	10 Nm (7.4 lbf ft)
--------------------------	----	--------------------

## Changing the parking light bulb

### Note

**Damage to reflector** Keep the glass of the bulb free of grease.

- Clean the glass bulb with a clean cloth before mounting. Any grease on the glass will evaporate by the heat and be deposited on the reflector.

- Switch off all power-consuming components and switch off the engine.
- Remove screws ❶. Remove cover.



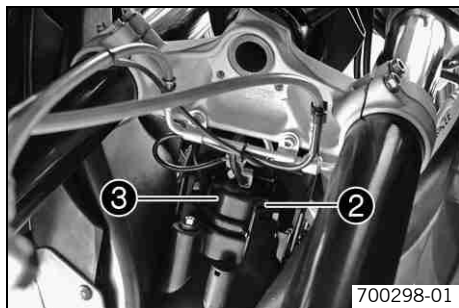

- Release the latch ②.
- Remove the lamp cover ③.

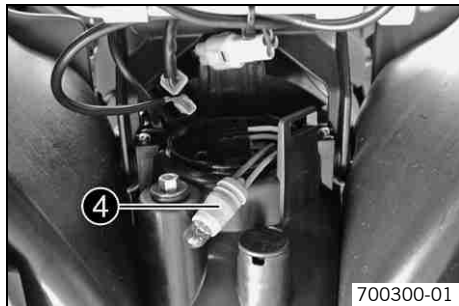

- Pull the parking light ④ carefully out of the holder.
- Remove the light bulb.
- Position a new light bulb in the holder.

Parking light (W2, 1x9,5d) (☛ S. 213)

- Carefully position the holder with the bulb in the holder in the headlight.

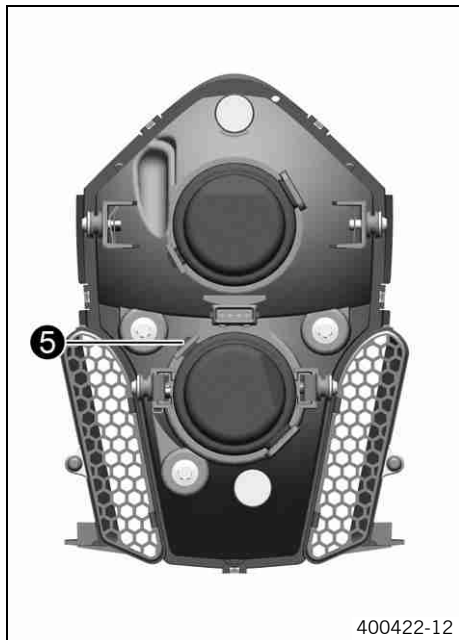

- Position the lug ⑤ of the lamp cover in the notch. Engage the latch.
- Check lighting function.

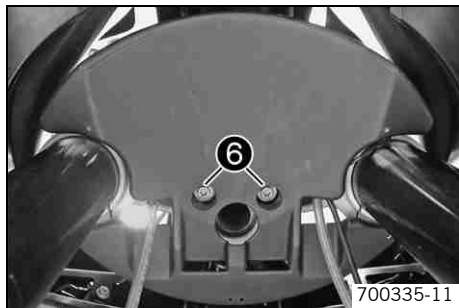

- Position cover.



**Info**

Check for correct positioning and freedom of movement of the brake lines.

- Mount and tighten screws ⑥.

Guideline

Remaining chassis screws	M6	10 Nm (7.4 lbf ft)
--------------------------	----	--------------------



## Checking headlight adjustment

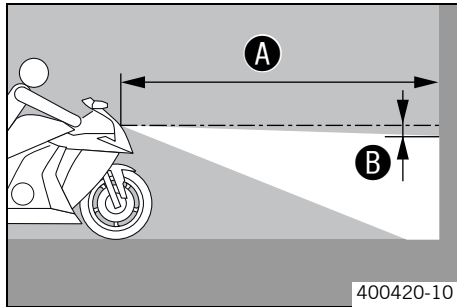

- On a light-colored wall behind a horizontal area, make a mark as high as the center of the low beam headlight.
- Make another mark at a distance of **B** under the first mark.

Guideline

Distance <b>B</b>	5 cm (2 in)
-------------------	-------------

- Stand the motorcycle at distance **A** in front of the wall and switch on the ignition and the low beam.

Guideline

Distance <b>A</b>	5 m (16 ft)
-------------------	-------------

- Check the headlight adjustment.

The border between light and dark must be exactly at mark <b>B</b> when the motorcycle is operational and complete with rider.
--

- » If the boundary between light and dark does not meet specifications:
  - Adjust the headlamp range. (🔧 S. 167)

## Adjusting headlamp range

- Check the headlight adjustment. (🔧 S. 167)



- Adjust the beam distance of the headlight by turning screw ❶.

### Guideline

The boundary between light and dark must be exactly on the lower mark for a motorcycle with a rider (mark is applied under: Checking headlight adjustment).

### **i** Info

Turn clockwise to increase the light range, turn counterclockwise to reduce the light range.

If you have a payload, you may have to correct the headlight range.

## Activating/deactivating ignition key

### **i** Info

The orange programming key must only be used for activating and deactivating!

If a black ignition key is lost or replaced, the black ignition keys must be activated/deactivated using the orange programming key. You can activate or deactivate up to four black ignition keys. Only the black ignition keys trained during an activation procedure are valid. All black ignition keys not trained in the activation procedure are invalid, but can be retrained in a further activation procedure.

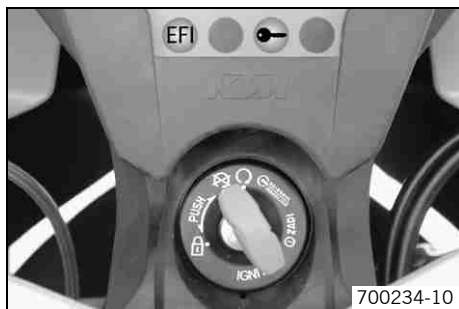

### Loss of a black ignition key (second black ignition key available):

- Press the emergency OFF switch into the position ○.
- Insert the orange programming key in the ignition lock.
- Switch on the ignition by turning the orange programming key to the position ○.
- ✓ **EFI** warning lamp (MIL) lights up, switches off, and then starts to flash.
- ✓ The immobilizer indicator lamp lights up.
- Switch off the ignition by turning the orange programming key to the position ☒.
- Pull out the orange programming key.
- Insert the black ignition key in the ignition lock.

- Switch on the ignition by turning the black ignition key to the position ○.
- ✓ **EFI** warning lamp (MIL) lights up, switches off, and then starts to flash.
- ✓ The immobilizer indicator lamp lights up, switches off briefly, and switches on again.
- Switch off the ignition by turning the black ignition key to the position ☒.
- Remove the black ignition key.
- Insert the orange programming key in the ignition lock.
- Switch on the ignition by turning the orange programming key to the position ○.
- ✓ **EFI** warning lamp (MIL) lights up, switches off, and then starts to flash.
- ✓ The immobilizer indicator lamp lights up, switches off briefly, and flashes according to the number of functioning black ignition keys including the orange programming key. In this case, twice.
- Switch off the ignition by turning the orange programming key to the position ☒.
- Pull out the orange programming key.
- ✓ The lost black ignition key is deactivated.
- ✓ The existing black ignition key is reactivated.

### **Loss of both black ignition keys (no black ignition key available):**

- Press the emergency OFF switch into the position ○.
- Insert the orange programming key in the ignition lock.
- Switch on the ignition by turning the orange programming key to the position ○.
- ✓ **EFI** warning lamp (MIL) lights up, switches off, and then starts to flash.
- ✓ The immobilizer indicator lamp lights up.
- Switch off the ignition by turning the orange programming key to the position ☒.

- Switch on the ignition by turning the orange programming key to the position ○.
- ✓ **EFI** warning lamp (MIL) lights up, switches off, and then starts to flash.
- ✓ The immobilizer indicator lamp lights up, switches off briefly, and flashes according to the number of functioning black ignition keys including the orange programming key. In this case once, since all black ignition keys are deactivated.
- Switch off the ignition by turning the orange programming key to the position ⊗.
- Pull out the orange programming key.
- ✓ All black ignition keys are deactivated.
- Order a new black ignition key according to the key number on the **KEYCODECARD** and activate it.

## Activating ignition key:

- Press the emergency OFF switch into the position ○.
- Insert the orange programming key in the ignition lock.
- Switch on the ignition by turning the orange programming key to the position ○.
- ✓ **EFI** warning lamp (MIL) lights up, switches off, and then starts to flash.
- ✓ The immobilizer indicator lamp lights up.
- Switch off the ignition by turning the orange programming key to the position ⊗.
- Pull out the orange programming key.
- Insert the black ignition key in the ignition lock.
- Switch on the ignition by turning the black ignition key to the position ○.
- ✓ **EFI** warning lamp (MIL) lights up, switches off, and then starts to flash.
- ✓ The immobilizer indicator lamp lights up, switches off briefly, and switches on again.
- Switch off the ignition by turning the black ignition key to the position ⊗.
- Remove the black ignition key.

- To activate further ignition keys, repeat the last 4 steps with the respective ignition key.
- Insert the orange programming key in the ignition lock.
- Switch on the ignition by turning the orange programming key to the position  $\odot$ .
  - ✓ **EFI** warning lamp  $\oplus$  (**MIL**) lights up, switches off, and then starts to flash.
  - ✓ The immobilizer indicator lamp  $\ominus$  lights up, switches off briefly, and flashes according to the number of functioning black ignition keys including the orange programming key.
- Switch off the ignition by turning the orange programming key to the position  $\otimes$ .
- Pull out the orange programming key.
  - ✓ All black ignition keys are activated included in this job sequence are activated.

## Cooling system

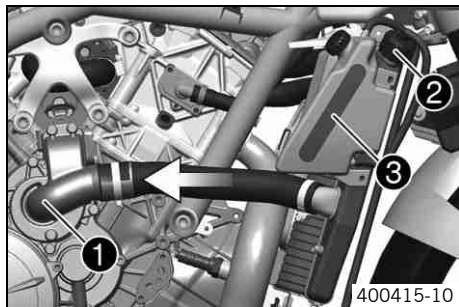

The water pump with a 3D water pump wheel ① in the engine ensures forced circulation of the coolant. The heat exchanger enables faster warming of the engine oil at the start of a journey and better heat dissipation for the engine oil during the journey.

The pressure in the cooling system resulting from heat is regulated by a valve in the radiator cap ②. The heat expansion causes the surplus coolant to flow into the compensating tank ③. When the temperature falls, this surplus coolant is sucked back into the cooling system.

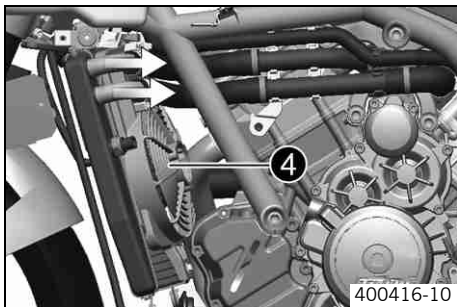

Cooling takes place by means of the air stream and a radiator fan ④, which is controlled by a thermostat.

The lower the speed, the less the cooling effect. Dirty cooling fins also reduce the cooling effect.

## Checking the coolant level



### Warning

**Danger of scalding** The coolant gets very hot when the motorcycle is driven and is under high pressure.

- Do not open the radiator, radiator hoses or other cooling system components when the engine is hot. Allow the engine and cooling system to cool down. If you scald yourself, hold the affected area under cold water immediately.



### Condition

Engine is cold.

- Stand the motorcycle upright on a horizontal surface.

- Check the coolant level in the compensating tank.

The coolant level must be between **MIN** and **MAX**.

- » If there is no coolant in the compensating tank:
  - Check the cooling system for leaks. 🛠️



## Info

Do not operate the motorcycle!

- » If the coolant level in the compensating tank does not meet specifications, but the tank is not empty:
  - Fill the cooling system compensating tank. (🔧 S. 173)

## Filling the cooling system compensating tank



### Warning

**Danger of scalding** The coolant gets very hot when the motorcycle is driven and is under high pressure.

- Do not open the radiator, radiator hoses or other cooling system components when the engine is hot. Allow the engine and cooling system to cool down. If you scald yourself, hold the affected area under cold water immediately.



### Warning

**Danger of poisoning** Coolants are poisonous and a health hazard.

- Avoid contact between coolants and skin, eyes and clothing. If fuel gets into your eyes, rinse immediately with water and contact a doctor. Wash affected skin areas immediately with soap and water. If coolant is swallowed, contact a doctor immediately. Change clothes that have come into contact with coolants. Keep coolants out of the reach of children.

## Note

**Engine damage** After draining coolant and refilling the cooling system, the motorcycle must be raised at the front according to the model type. This is the only way of ensuring that the cooling system is filled without air bubbles. Air in the cooling system can lead to engine failure.

- Have the coolant changed by an authorized KTM-RC8 workshop.

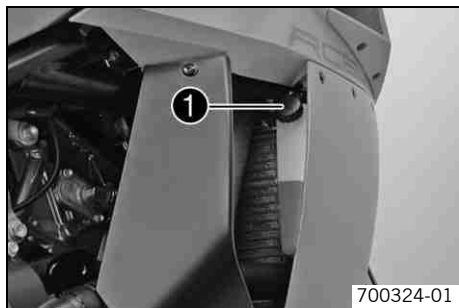

- Check the coolant level. (☛ S. 172)
- Remove the cap ❶ of the compensating tank.
- Top up with coolant until the specified coolant level is reached.

### Guideline

The coolant level must be between **MIN** and **MAX**.

### Alternative 1

Coolant (☛ S. 221)

### Alternative 2

Coolant (mixed ready to use) (☛ S. 221)

- Mount the cap of the compensating tank.



## Adjusting basic position of clutch lever



- Adjust the basic setting of the clutch lever to your hand size by turning adjusting screw ❶.

### **i** Info

Turn the adjusting screw clockwise to increase the distance between the clutch lever and the handlebar.  
Turn the adjusting screw counterclockwise to decrease the distance between the clutch lever and the handlebar.  
The range of adjustment is limited.  
Turn the adjusting screw by hand only, and do not apply any force.  
Do not make any adjustments while riding!

## Checking fluid level of hydraulic clutch

### **i** Info

The fluid level rises with increasing wear of the clutch lining disc.  
Do not use brake fluid.

- Move the clutch fluid reservoir mounted on the handlebar to a horizontal position.



- Check the fluid level.

The fluid level must be between the **MIN** and **MAX** markings.

- » If the fluid level does not meet specifications:
  - Correct the fluid level of the hydraulic clutch. (☛ S. 176)

## Correcting fluid level of hydraulic clutch



### Info

The fluid level rises with increasing wear of the clutch lining disc.  
Do not use brake fluid.



- Move the clutch fluid reservoir mounted on the handlebar to a horizontal position.
- Remove screw cover with membrane.
- Correct the fuel level.

Guideline

The fluid level must be between the **MIN** and **MAX** markings.

Hydraulic fluid (15) (☛ S. 223)

- Refit screw with membrane.

## Adjusting gas Bowden cable ↩

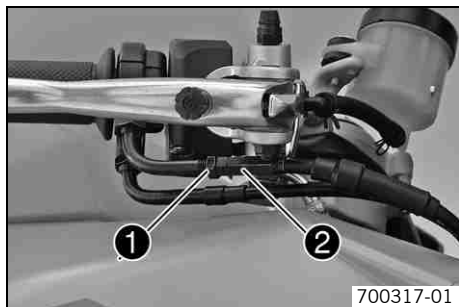

- Move the handlebar to the straight-ahead position.
- With the diagnostics tool **KTM DIA**, place the control motor for the throttle valve position into the neutral position.
- Loosen the counter nut ❶.
- Adjust the gas Bowden cable with the adjusting screw ❷.

Guideline

Play in gas Bowden cable	3... 5 mm (0.12... 0.2 in)
--------------------------	----------------------------

- Tighten the counter nut ❶.

## Handlebar height

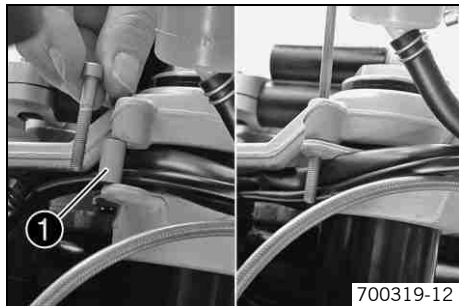

By removing or inserting the spacing sleeves ❶, you can set the handlebar height at two different positions.

Long distance sleeve ❶	15 mm (0.59 in)
------------------------	-----------------

With distance sleeves, the handlebar stub is positioned low for sports use. Removing the distance sleeves gives a more upright sitting position.

Standard	Low position with distance sleeve
----------	-----------------------------------

## Adjusting handlebar height

**i Info**  
The handlebar stub position must be identical on the left and the right of the vehicle.

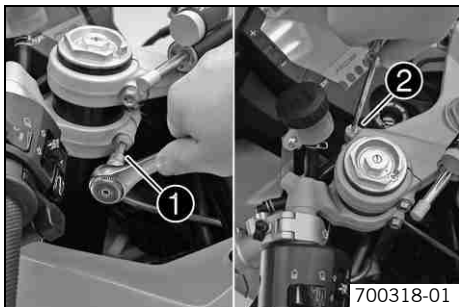

- Loosen screw ①.

**i Info**  
Loosen the screw several turns to prevent damaging the fork lacquer when moving the handlebar stub.

- Remove screw ②.

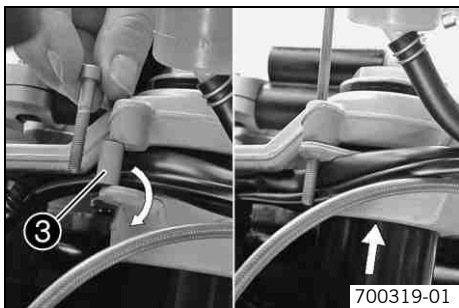

- Remove the spacer ③.
- All cables routed under the upper triple clamp must now be routed under the handlebar stub.
- Push the handlebar stub carefully up to the upper triple clamp.
- Mount and tighten screw.

### Guideline

Remaining chassis screws	M5	5 Nm (3.7 lbf ft)
--------------------------	----	-------------------



- Tighten the screw.

Guideline

Screw, handlebar stub	M8	20 Nm (14.8 lbf ft)
-----------------------	----	---------------------

- Repeat the adjustments on the other handlebar stub.
- Move the handlebar to and fro over the entire steering range.
  - » If the cables restrict the freedom of movement of the steering:
    - Correct the cable routing.
- When fitting the spacers, carry out these steps in the same way.

**i** Info

The cables must then be positioned between the upper triple clamp and the handlebar stub.

## Rear frame position

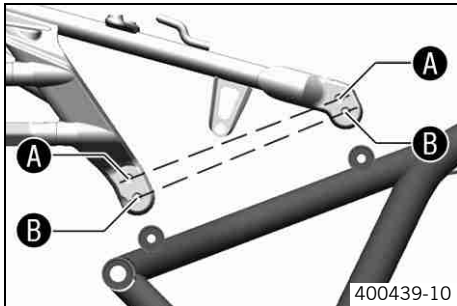

The frame rear height can be set to two different positions, enabling ergonomic adjustment of the seat height.

Seat height <b>A</b> (standard)	805 mm (31.69 in)
Seat height <b>B</b>	825 mm (32.48 in)

## Adjusting rear frame position



### Warning

**Danger of accidents** Modifications to the chassis can seriously alter the vehicle's handling characteristics.

- Following modifications, ride slowly at first to get the feel of the new handling characteristics.

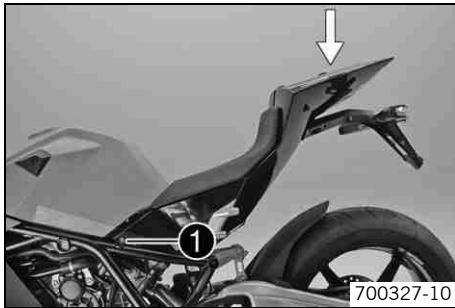

### Setting a higher seat position:

- Remove screw ❶ with washer on the left and right side of the vehicle.
- Press the rear end down until the drill holes of the frame are level with the lower front drill holes of the frame rear.



- Fit the screw and washer on the left and right sides of the vehicle, but do not tighten.

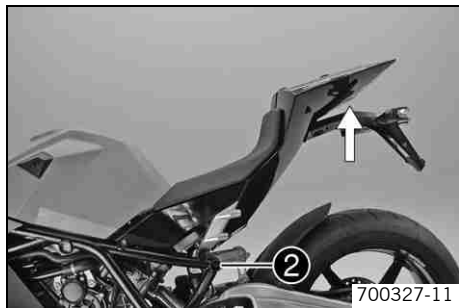

- Remove screw ❷ with washer on the left and right side of the vehicle.
- Press the rear end up until the drill holes of the frame are level with the lower rear drill holes of the frame rear.
- Fit the screw and washer on the left and right sides of the vehicle, and tighten.

Guideline

Screw, subframe	M8	25 Nm (18.4 lbf ft)	<b>Loctite® 243™</b>
-----------------	----	------------------------	----------------------

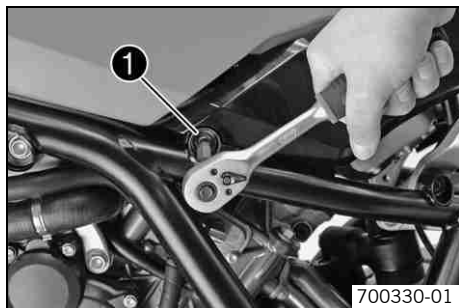

- Tighten the screw ❶ on the left and right sides of the vehicle.

Guideline

Screw, subframe	M8	25 Nm (18.4 lbf ft)	<b>Loctite® 243™</b>
-----------------	----	------------------------	----------------------

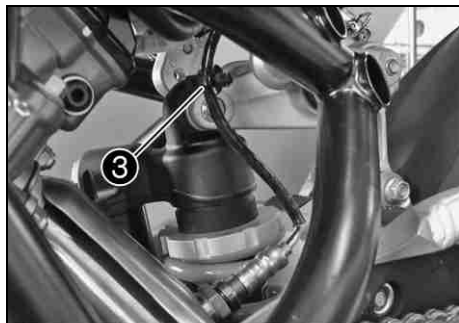

- When you screw in the rear left fixing screw, the plug-in cable binder ③ is pushed out of the thread. To reposition the cable of the lambda probe, fix the plug-in cable binder in the remaining free drill hole.

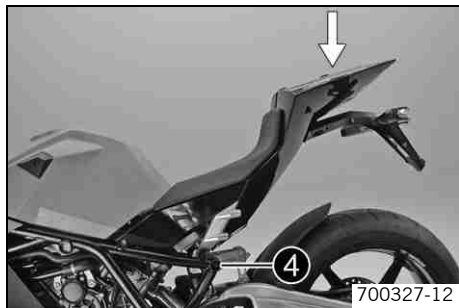

## Setting a lower seat position:

- Remove screw ④ with washer on the left and right side of the vehicle.
- Press the rear end down until the drill holes of the frame are level with the upper rear drill holes of the frame rear.
- Fit the screw and washer on the left and right sides of the vehicle, but do not tighten.

### **i** Info

Check the cable routing. The cable of the lambda probe must not be taut.



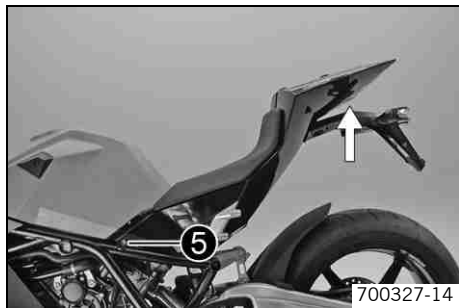

- Remove screw ⑤ with washer on the left and right side of the vehicle.
- Press the rear end up until the drill holes of the frame are level with the upper front drill holes of the frame rear.



- Fit the screw and washer on the left and right sides of the vehicle, and tighten.

Guideline

Screw, subframe	M8	25 Nm (18.4 lbf ft)	<b>Loctite® 243™</b>
-----------------	----	------------------------	----------------------

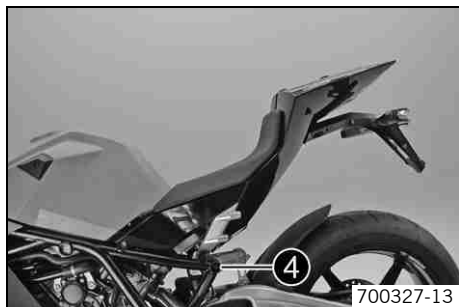

- Tighten the screw ④ on the left and right sides of the vehicle.

Guideline

Screw, subframe	M8	25 Nm (18.4 lbf ft)	<b>Loctite® 243™</b>
-----------------	----	------------------------	----------------------

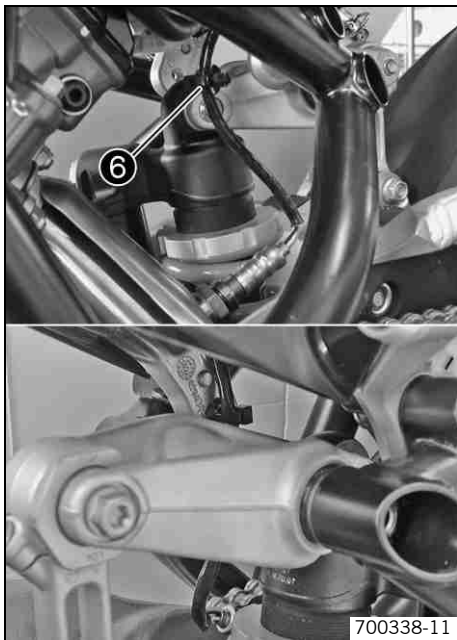

- When you screw in the rear left fixing screw, the plug-in cable binder ⑥ is pushed out of the thread. To reposition the cable of the lambda probe, fix the plug-in cable binder in the remaining free drill hole.



## Info

Check the cable routing. The cable of the lambda probe must not be taut.

## Checking engine oil level



## Info

The engine oil level must be checked at normal engine operating temperature.

- Stand the motorcycle upright on a horizontal surface.

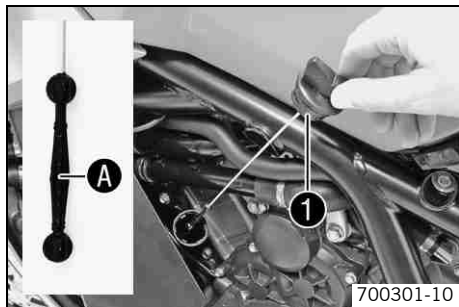

- Remove oil dipstick ❶. Check the engine oil level in the measurement range.

## **i** Info

After switching off the engine, wait one minute before checking the level.

The engine oil level must be in the middle **A** of the measurement range of the oil dipstick.

- » If the engine oil level is outside the specified range:
  - Top up the engine oil. (🔧 S. 192)
- Replace the oil dipstick.

## Changing engine oil and filter, cleaning oil screen 🛠

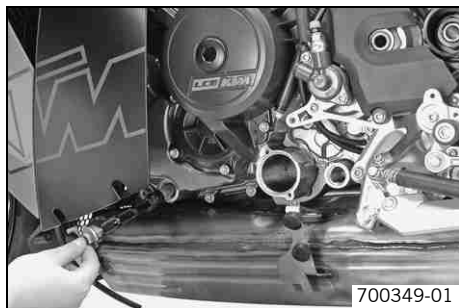

- Drain the engine oil and clean the oil screens. 🛠 (🔧 S. 185)
- Fill up with engine oil. 🛠 (🔧 S. 190)

## Draining engine oil, cleaning oil screens 🛠



### **Warning**

**Danger of scalding** Engine oil and gear oil get very hot when the motorcycle is driven.

- Wear suitable protective clothing and gloves. If you scald yourself, hold the affected area under cold water immediately.



## Warning

**Environmental hazard** Problem materials cause environmental damage.

- Dispose of oil, grease, filters, fuel, cleaning substances, brake fluid, batteries, etc. according to regulations.



## Info

Drain the engine oil only when the engine is warm.

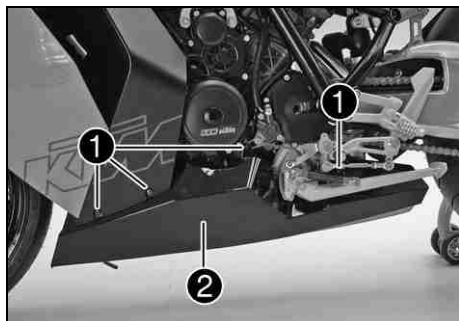

- Remove screws ❶.
- Take off the left exhaust cover ❷.

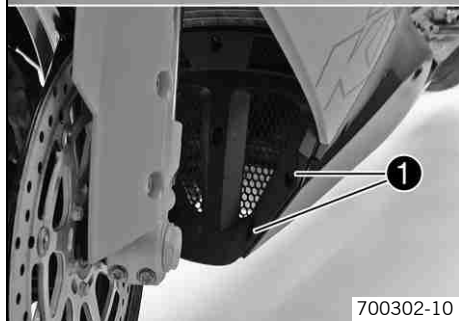

700302-10

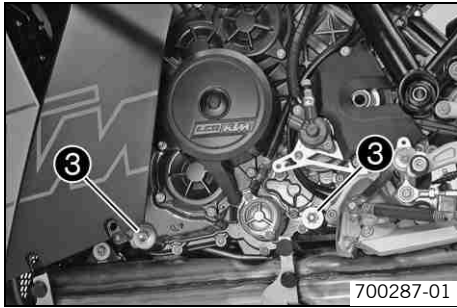

- Stand the motorcycle on its side stand on a horizontal surface.
- Place a suitable container under the engine.
- Remove the oil drain plug ❸ with the magnet, O-rings and oil screen.
- Remove the oil filter. 🛠️ (📖 S. 188)
- Completely drain the engine oil.

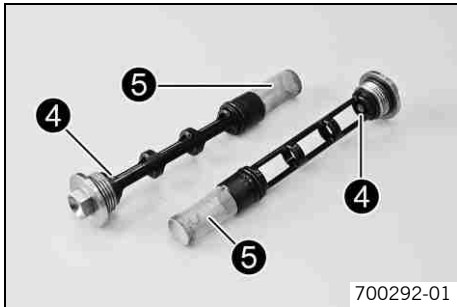

- Thoroughly clean the magnet ❹ and oil screen ❺ of the oil drain plug.

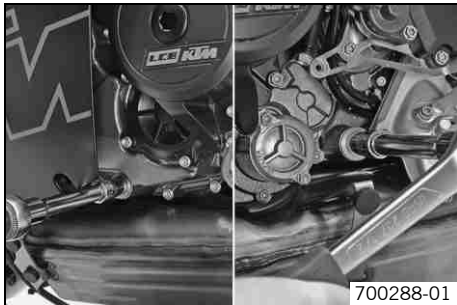

- Fit and tighten the oil drain plug with the magnet, O-rings and oil screen.

**Guideline**

Oil drain plug	M20x1.5	20 Nm (14.8 lbf ft)
----------------	---------	---------------------

- Fit the oil filter. 🛠️ (📖 S. 190)

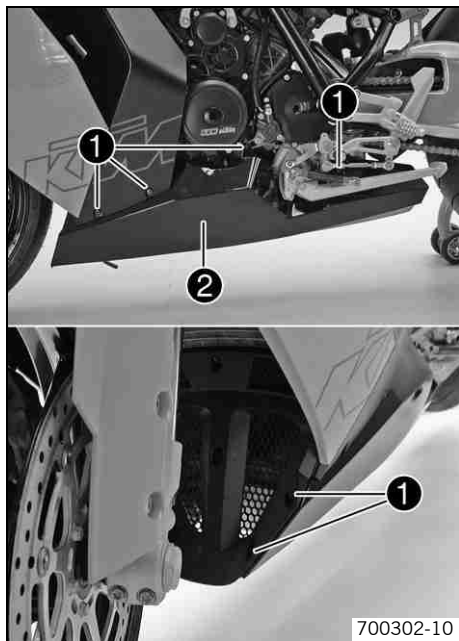

- Position the left exhaust cover ②.
- Mount and tighten screws ①.

Guideline

Remaining chassis screws	M5	5 Nm (3.7 lbf ft)
--------------------------	----	-------------------

## Removing oil filter



### Warning

**Danger of scalding** Engine oil and gear oil get very hot when the motorcycle is driven.

- Wear suitable protective clothing and gloves. If you scald yourself, hold the affected area under cold water immediately.



## Warning

**Environmental hazard** Problem materials cause environmental damage.

- Dispose of oil, grease, filters, fuel, cleaning substances, brake fluid, batteries, etc. according to regulations.

- Place a suitable container under the engine.
- Remove screws ❶. Remove the oil filter cover ❷ with the O-ring.

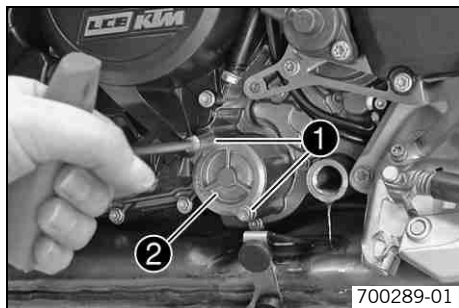

- Pull the oil filter element ❸ out of the oil filter case.

Circlip pliers reverse (51012011000)

- Completely drain the engine oil.
- Clean the parts and the sealing area thoroughly.

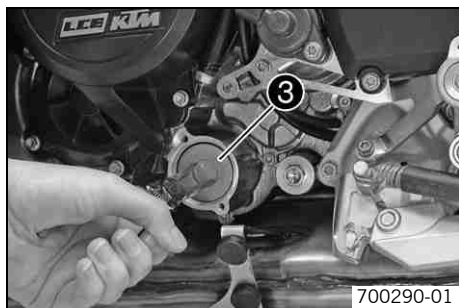

## Fitting oil filter ↩

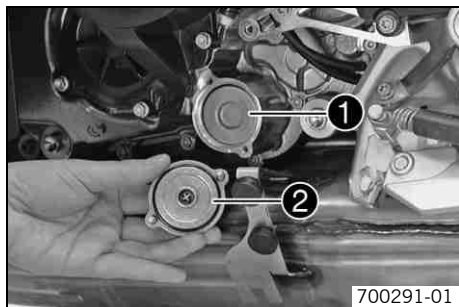

- Insert the oil filter ❶.
- Lubricate the O-ring of the oil filter cover. Fit the oil filter cover ❷.
- Mount and tighten screws.

### Guideline

Remaining engine screws	M5	6 Nm (4.4 lbf ft)
-------------------------	----	-------------------

## Filling up with engine oil ↩



### Info

Too little engine oil or poor-quality engine oil results in premature wear to the engine.

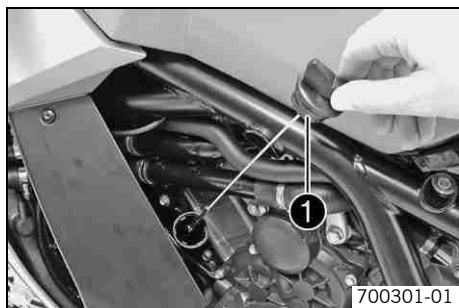

- The oil must be topped up in two steps.

Engine oil	3.60 l (3.8 qt.)	External temperature: ≥ 0 °C (≥ 32 °F)	Engine oil (SAE 10W/50) (☛ S. 222)
		External temperature: < 0 °C (< 32 °F)	Engine oil (SAE 5W/40) (☛ S. 222)



- Remove the dipstick ❶ and top up the engine oil.

Engine oil (1st quantity)	3.00 l (3.17 qt.)	External temperature: ≥ 0 °C (≥ 32 °F)	Engine oil (SAE 10W/50) (☛ S. 222)
		External temperature: < 0 °C (< 32 °F)	Engine oil (SAE 5W/40) (☛ S. 222)

- Replace the oil dipstick ❶.



**Danger**

**Danger of poisoning** Exhaust gases are poisonous and can result in unconsciousness and/or death.

- When running the engine, always make sure there is sufficient ventilation, and do not start or run the engine in a closed space.

- Start the engine and check that it is oil-tight.
- Remove the dipstick ❶ and pour in the remaining engine oil.

Engine oil (2nd quantity)	0.60 l (0.63 qt.)	External temperature: ≥ 0 °C (≥ 32 °F)	Engine oil (SAE 10W/50) (☛ S. 222)
		External temperature: < 0 °C (< 32 °F)	Engine oil (SAE 5W/40) (☛ S. 222)

- Replace the oil dipstick ❶.



## Danger

**Danger of poisoning** Exhaust gases are poisonous and can result in unconsciousness and/or death.

- When running the engine, always make sure there is sufficient ventilation, and do not start or run the engine in a closed space.
- 
- Start the engine and check that it is oil-tight.
  - Check the engine oil level. (🔧 S. 184)

## Topping up engine oil



### Info

Too little engine oil or poor-quality engine oil results in premature wear to the engine.

- Check the engine oil level. (🔧 S. 184)

Engine oil (SAE 10W/50) (🔧 S. 222)

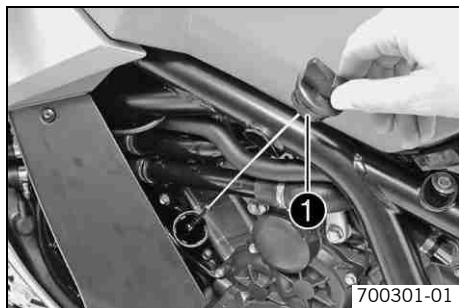

- Remove the dipstick ❶ and top up the engine oil.

**Condition**

External temperature:  $\geq 0$  °C ( $\geq 32$  °F)

Engine oil (SAE 10W/50) (☛ S. 222)

**Condition**

External temperature:  $< 0$  °C ( $< 32$  °F)

Engine oil (SAE 5W/40) (☛ S. 222)

**Info**

For optimal performance of the engine oil, do not mix different types of engine oil.

If appropriate, change the engine oil.

- Replace the oil dipstick ❶.

**Danger**

**Danger of poisoning** Exhaust gases are poisonous and can result in unconsciousness and/or death.

- When running the engine, always make sure there is sufficient ventilation, and do not start or run the engine in a closed space.
- 
- Start the engine and check that it is oil-tight.
  - Check the engine oil level. (☛ S. 184)

Faults	Possible cause	Action
Engine doesn't crank when the electric starter button is pressed	Operating error	– Carry out the steps for starting. (☛ S. 82)
	Battery discharged	– Recharge the battery. ☛ (☛ S. 151) – Check closed-circuit current. ☛
	Fuse <b>1</b> , or <b>6</b> blown	– Change the fuses of individual power consumers. (☛ S. 155)
	Main fuse blown	– Change the main fuse. (☛ S. 153)
	Ignition/steering lock or emergency OFF switch defective	– Check the ignition/steering lock. ☛ – Check the emergency OFF switch. ☛
	Safety start system defective	– Check the safety start system. ☛
	Immobilizer active	– Read flash code of immobilizer.
	EFI control unit not activated	– Activate the EFI control unit. ☛
	Malfunction of CAN-Bus communication	– Check the CAN-Bus communication. ☛
Combination instrument defective	– Check the combination instrument. ☛	
Engine cranks only if the clutch lever is pulled	A gear is engaged	– Shift into neutral.
	Safety start system defective	– Check the safety start system. ☛
Engine cranks although it is in gear	Safety start system defective	– Check the safety start system. ☛
Engine cranks but doesn't start	Fuse <b>5</b> blown	– Change the fuses of individual power consumers. (☛ S. 155)
	Coupling of fuel hose connection not joined together	– Join coupling of fuel hose connection together.
	Plug connector of wiring harness oxidized	– Clean plug connector and treat with contact spray.
	Fault in fuel injection system	– Read the fault memory with <b>KTM DIA</b> . ☛

Faults	Possible cause	Action
Engine cranks but doesn't start	Fuel pump control defective	– Check fuel pump control. 🛠️
	Fuel quality insufficient	– Add suitable fuel.
Engine has too little power	Air filter very dirty	– Change the air filter. 🛠️
	Fuel filter very dirty	– Change the fuel filter. 🛠️
	Fault in fuel injection system	– Read the fault memory with <b>KTM DIA</b> . 🛠️
Engine overheats <b>HIGH TEMP</b>	Too little coolant in cooling system	– Check the cooling system for leaks. 🛠️ – Check the coolant level. (🔧 S. 172)
	Cooling fins very dirty	– Clean cooling fins.
	Kinked or damaged radiator hose	– Change the coolant hose. 🛠️
	Thermostat defective	– Check the thermostat. 🛠️
	Fuse <b>4</b> blown	– Change the fuses of individual power consumers. (🔧 S. 155)
	Defect in radiator fan system	– Check the radiator fan system. 🛠️
	Air in cooling system	– Fill up and aerate the cooling system. 🛠️
<b>EFI</b> warning lamp ( <b>MIL</b> ) lights up / flashes	Fault in fuel injection system	– Read the fault memory with <b>KTM DIA</b> . 🛠️
Engine dies during the journey	Lack of fuel	– Fill up with fuel. (🔧 S. 89)
	Fuse <b>1</b> , <b>5</b> or <b>6</b> blown	– Change the fuses of individual power consumers. (🔧 S. 155)
High oil consumption	Engine oil level too high	– Check the engine oil level. (🔧 S. 184)
	Engine oil too thin (viscosity)	– Change the engine oil and filter, clean the oil screen. 🛠️ (🔧 S. 185)
Headlight and parking light do not work	Fuse <b>2</b> blown	– Change the fuses of individual power consumers. (🔧 S. 155)

Faults	Possible cause	Action
Brake light and horn do not work	Fuse <b>3</b> blown	– Change the fuses of individual power consumers. (🔧 S. 155)
Battery discharged	Ignition not switched off when vehicle parked	– Recharge the battery. 🔌 (🔧 S. 151)
	Battery is not charged by the generator	– Check charging voltage. 🔌
Combination instrument shows nothing in display	Fuse <b>1</b> blown	– Change the fuses of individual power consumers. (🔧 S. 155)
Speedometer in combination instrument doesn't work	Wiring harness of wheel revolution counter damaged or plug-in connector oxidized	– Check the wheel speed sensor.

Fault	Description	Possible cause	Action
12	Immobilizer indicator lamp flashes 1x short, 1 second pause, 2x short	All ignition keys inactive	<ul style="list-style-type: none"> <li>– Activate/deactivate the ignition key. (☛ S. 168)</li> </ul>
13	Immobilizer indicator lamp flashes 1x short, 1 second pause, 3x short	Malfunction, antenna of immobilizer control unit	<ul style="list-style-type: none"> <li>– Check the antenna of the immobilizer control unit. ☛</li> </ul>
14	Immobilizer indicator lamp flashes 1x short, 1 second pause, 4x short	Malfunction in transponder of black ignition key	<ul style="list-style-type: none"> <li>– Use spare black ignition key.</li> <li>– Order new spare key.</li> <li>– Activate/deactivate the ignition key. (☛ S. 168)</li> </ul>
15	Immobilizer indicator lamp flashes 1x short, 1 second pause, 5x short	Black ignition key inactive	<ul style="list-style-type: none"> <li>– Activate/deactivate the ignition key. (☛ S. 168)</li> </ul>
16	Immobilizer indicator lamp flashes 1x short, 1 second pause, 6x short	Malfunction, encryption, immobilizer control unit to black ignition key	<ul style="list-style-type: none"> <li>– Use the black ignition key belonging to the vehicle.</li> </ul>
21	Immobilizer indicator lamp flashes 2x short, 1 second pause, 1x short	Immobilizer control unit not activated	<ul style="list-style-type: none"> <li>– Activate the immobilizer control unit. ☛</li> </ul>
31	Immobilizer indicator lamp flashes 3x short, 1 second pause, 1x short	Malfunction, encryption query from EFI control unit to immobilizer control unit	<ul style="list-style-type: none"> <li>– Activate the EFI control unit. ☛</li> </ul>
32	Immobilizer indicator lamp flashes 3x short, 1 second pause, 2x short	Malfunction of CAN-Bus communication	<ul style="list-style-type: none"> <li>– Check the CAN-Bus communication. ☛</li> </ul>
60	Immobilizer indicator lamp flashes 6x short	<b>EEPROM</b> malfunction	<ul style="list-style-type: none"> <li>– Change the immobilizer control unit. ☛</li> </ul>

Fault	Description	Possible cause	Action
02	<b>EFI</b> Warning lamp ( <b>MIL</b> ) flashes 2x short	Malfunction in ignition pulse generator circuit	– Check the ignition pulse generator. 🔧
06	<b>EFI</b> Warning lamp ( <b>MIL</b> ) flashes 6x short	Input signal of throttle valve position generator circuit A too low	– Check circuit A of throttle valve position generator. 🔧
		Input signal of throttle valve position generator circuit A too high	– Check circuit A of throttle valve position generator. 🔧
07	<b>EFI</b> Warning lamp ( <b>MIL</b> ) flashes 7x short	Input signal of throttle valve position generator circuit B too low	– Check circuit B of throttle valve position generator. 🔧
		Input signal of throttle valve position generator circuit B too high	– Check circuit B of throttle valve position generator. 🔧
09	<b>EFI</b> Warning lamp ( <b>MIL</b> ) flashes 9x short	Input signal from pressure sensor, induction manifold (cylinder 1) too low	– Check pressure sensor, induction manifold (cylinder 1). 🔧
		Input signal from pressure sensor, induction manifold (cylinder 1) too high	– Check pressure sensor, induction manifold (cylinder 1). 🔧
11	<b>EFI</b> Warning lamp ( <b>MIL</b> ) flashes 1x long, 1x short	Input signal from pressure sensor, induction manifold (cylinder 2) too low	– Check pressure sensor, induction manifold (cylinder 2). 🔧
		Input signal from pressure sensor, induction manifold (cylinder 2) too high	– Check pressure sensor, induction manifold (cylinder 2). 🔧
13	<b>EFI</b> Warning lamp ( <b>MIL</b> ) flashes 1x long, 3x short	Input signal from intake air temperature sensor too low	– Check the intake air temperature sensor. 🔧



Fault	Description	Possible cause	Action
13	<b>EFI</b> Warning lamp ( <b>MIL</b> ) flashes 1x long, 3x short	Input signal from intake air temperatur sensor too high	– Check the intake air temperature sensor. 🛠️
14	<b>EFI</b> Warning lamp ( <b>MIL</b> ) flashes 1x long, 4x short	Input signal of pressure sensor ambient air too low	– Check pressure sensor, ambient air. 🛠️
		Input signal of pressure sensor ambient air too high	– Check pressure sensor, ambient air. 🛠️
15	<b>EFI</b> Warning lamp ( <b>MIL</b> ) flashes 1x long, 5x short	Input signal from roll angle sensor too low	– Check the roll angle sensor. 🛠️
		Input signal from roll angle sensor too high	– Check the roll angle sensor. 🛠️
17	<b>EFI</b> Warning lamp ( <b>MIL</b> ) flashes 1x long, 7x short	Malfunction in lambda probe circuit (cylinder 1)	– Check lambda probe (cylinder 1). 🛠️
18	<b>EFI</b> Warning lamp ( <b>MIL</b> ) flashes 1x long, 8x short	Malfunction in lambda probe circuit (cylinder 2)	– Check lambda probe (cylinder 2). 🛠️
24	<b>EFI</b> Warning lamp ( <b>MIL</b> ) flashes 2x long, 4x short	Malfunction in voltage supply circuit to EFI control unit	– Check voltage supply to EFI control unit. 🛠️
25	<b>EFI</b> Warning lamp ( <b>MIL</b> ) flashes 2x long, 5x short	Malfunction in sidestand switch circuit	– Check the sidestand switch. 🛠️
33	<b>EFI</b> Warning lamp ( <b>MIL</b> ) flashes 3x long, 3x short	Malfunction in injection valve circuit (cylinder 1)	– Check injection valve (cylinder 1). 🛠️
34	<b>EFI</b> Warning lamp ( <b>MIL</b> ) flashes 3x long, 4x short	Malfunction in injection valve circuit (cylinder 2)	– Check injection valve (cylinder 2). 🛠️
37	<b>EFI</b> Warning lamp ( <b>MIL</b> ) flashes 3x long, 7x short	Malfunction in ignition coil circuit (cylinder 1)	– Check the ignition coil (cylinder 1). 🛠️
38	<b>EFI</b> Warning lamp ( <b>MIL</b> ) flashes 3x long, 8x short	Malfunction in ignition coil circuit (cylinder 2)	– Check the ignition coil (cylinder 2). 🛠️

Fault	Description	Possible cause	Action
41	<b>EFI</b> Warning lamp ( <b>MIL</b> ) flashes 4x long, 1x short	Interruption/short-circuit to ground in fuel pump control circuit	– Check fuel pump control. 🛠️
		Short-circuit to plus in fuel pump control circuit	– Check fuel pump control. 🛠️
45	<b>EFI</b> Warning lamp ( <b>MIL</b> ) flashes 4x long, 5x short	Malfunction or short circuit to ground in lambda probe heating circuit (cylinder 1)	– Check heating of lambda probe (cylinder 1). 🛠️
		Malfunction or short circuit to plus in lambda probe heating circuit (cylinder 1)	– Check heating of lambda probe (cylinder 1). 🛠️
46	<b>EFI</b> Warning lamp ( <b>MIL</b> ) flashes 4x long, 6x short	Malfunction or short circuit to ground in lambda probe heating circuit (cylinder 2)	– Check heating of lambda probe (cylinder 2). 🛠️
		Malfunction or short circuit to plus in lambda probe heating circuit (cylinder 2)	– Check heating of lambda probe (cylinder 2). 🛠️
49	<b>EFI</b> Warning lamp ( <b>MIL</b> ) flashes 4x long, 9x short	Malfunction in idling control system circuit	– Check idle speed control. 🛠️
50	<b>EFI</b> Warning lamp ( <b>MIL</b> ) flashes 5x long	Malfunction in throttle valve stepper circuit, circuit B	– Check circuit B of throttle stepper motor. 🛠️
54	<b>EFI</b> Warning lamp ( <b>MIL</b> ) flashes 5x long, 4x short	Interruption/short-circuit to ground in secondary air valve circuit	– Check the secondary air valve. 🛠️
		Short-circuit to plus in secondary air valve circuit	– Check the secondary air valve. 🛠️
61	<b>EFI</b> Warning lamp ( <b>MIL</b> ) flashes 6x long, 1x short	Malfunction in idling control system basic setting	– Check idle speed control. 🛠️

Fault	Description	Possible cause	Action
62	<b>EFI</b> Warning lamp ( <b>MIL</b> ) flashes 6x long, 2x short	Malfunction in idling control system	– Check idle speed control. 🛠️
68	<b>EFI</b> Warning lamp ( <b>MIL</b> ) flashes 6x long, 8x short	Connection of pressure sensor, induction manifold (cylinder 1) leaky	– Check pressure sensor, induction manifold (cylinder 1). 🛠️
69	<b>EFI</b> Warning lamp ( <b>MIL</b> ) flashes 6x long, 9x short	Connection of pressure sensor, induction manifold (cylinder 2) leaky	– Check pressure sensor, induction manifold (cylinder 2). 🛠️
72	<b>EFI</b> Warning lamp ( <b>MIL</b> ) flashes 7x long, 2x short	Malfunction of throttle valve stepper, circuit B	– Check circuit B of throttle stepper motor. 🛠️
91	<b>EFI</b> Warning lamp ( <b>MIL</b> ) flashes 9x long, 1x short	Malfunction of CAN-Bus communication	– Check the CAN-Bus communication. 🛠️

## Cleaning motorcycle

### Note

**Material damage** Damage and destruction of components by high-pressure cleaning equipment.

- Never clean the vehicle with high-pressure cleaning equipment or a strong water-jet. The excessive pressure can penetrate electrical components, connects, Bowden cables, and bearings, etc., and can damage or destroy these parts.



### Warning

**Environmental hazard** Problem materials cause environmental damage.

- Dispose of oil, grease, filters, fuel, cleaning substances, brake fluid, batteries, etc. according to regulations.



### Info

To maintain the value and appearance of the motorcycle over a long period, clean it regularly.  
Avoid direct sunshine when cleaning the motorcycle.

- Before cleaning, seal the exhaust system to prevent water from entering.
- Remove loose dirt first with a soft jet of water.
- Spray very dirty parts with a normal commercial engine cleaner and then brush off with a soft brush.

Motorcycle cleaner (☛ S. 225)



### Info

Use warm water mixed with a normal commercial engine cleaner and a soft sponge.  
If the vehicle has been used on salted roads, clean it with cold water. Warm water intensifies the effects of salt.

- After cleaning the motorcycle thoroughly with a soft jet of water, dry it with compressed air and a cloth.



## Warning

**Danger of accidents** Reduced braking due to wet or dirty brakes.

- Clean or dry dirty or wet brakes by riding and braking gently.

- After cleaning, ride a short distance until operating temperature is reached, and apply the brakes.



## Info

The heat causes water to evaporate from inaccessible parts of the engine and brakes.

- After the engine has cooled down, lubricate or grease all moving parts and bearings.
- Clean the chain. (🔧 S. 122)
- Treat bare metal (except for brake discs and the exhaust system) with an anticorrosive.

Cleaning and polishing materials for metal, rubber and plastic (🔧 S. 224)

- Treat all painted parts with a mild lacquer care spray.

High-luster polish for paint (🔧 S. 224)

- Oil the ignition/steering lock, tank lock, and seat lock.

Universal oil spray (🔧 S. 225)

## Conservation for winter operation

---

### Info

If you use the motorcycle in the winter, you have to expect salt on the roads. You therefore have to take precautions against the aggressive road salt.

If the vehicle has been used on salted roads, clean it with cold water. Warm water intensifies the effects of salt.

---

- Clean the motorcycle. (🔧 S. 202)
  - Treat the engine, swingarm and all other bare or galvanized parts (except the brake discs) with a wax-based anticorrosive.
- 

### Info

Avoid getting anticorrosive on the brake discs: this would badly affect the braking.

After riding on salted roads, thoroughly wash the motorcycle with cold water and dry it well.

---

- Clean the chain. (🔧 S. 122)

## Storage

### Info

If you want to garage the motorcycle for a longer period, take the following actions.

Before storing the motorcycle, check all parts for function and wear. If service, repairs or replacements are necessary, you should do this during the storage period (less workshop overload). In this way, you can avoid long workshop waiting times at the start of the new season.

- Make sure the tank is as empty as possible so that you can fill up with fresh fuel when you put the motorcycle back into operation.
- Clean the motorcycle. (🔧 S. 202)
- Change the engine oil and filter, clean the oil screen. 🛠️ (🔧 S. 185)
- Check the coolant level. (🔧 S. 172)
- Check the antifreeze. 🛠️
- Checking the tire air pressure. (🔧 S. 145)
- Remove the battery. 🛠️ (🔧 S. 148)
- Recharge the battery. 🛠️ (🔧 S. 151)

### Guideline

Storage temperature of battery without direct sunshine.	0... 35 °C (32... 95 °F)
---	--------------------------

- The storage place should be dry and not subject to large temperature differences.

### Info

KTM recommends jacking up the motorcycle.

- Jack up the motorcycle rear end. (🔧 S. 96)
- Jack up the motorcycle at the front. (🔧 S. 95)

- Cover the motorcycle with a porous sheet or blanket.



## Info

Do not use non-porous materials since they prevent humidity from escaping, thus causing corrosion. Avoid running the engine for a short time only. Since the engine cannot warm up properly, the water vapor produced during combustion condenses and causes valves and exhaust system to rust.

---

## Putting into operation after storage

- Take the front of the motorcycle off the work stand. (🔧 S. 95)
- Take the rear of the motorcycle off the work stand. (🔧 S. 96)
- Recharge the battery. 🔌 (🔧 S. 151)
- Install the battery. 🔌 (🔧 S. 150)
- Set the clock with **SET CLOCK**. (🔧 S. 62)
- Fill up with fuel. (🔧 S. 89)
- Make checks before putting into operation. (🔧 S. 81)
- Make a test ride.



Design	2-cylinder 4-stroke Otto motor, 75° V arrangement, water-cooled
Displacement	1,150 cm <sup>3</sup> (70.18 cu in)
Stroke	69 mm (2.72 in)
Bore	103 mm (4.06 in)
Compression ratio	12,5:1
Control	DOHC, 4 valves per cylinder, chain-driven
Valve - diameter	
Intake	42 mm (1.65 in)
Exhaust	34 mm (1.34 in)
Valve clearance	
Exhaust at: 20 °C (68 °F)	0.25... 0.30 mm (0.0098... 0.0118 in)
Intake at: 20 °C (68 °F)	0.10... 0.15 mm (0.0039... 0.0059 in)
Crankshaft bearing	Sleeve bearing
Conrod bearing	Sleeve bearing
Piston pin bearing	No bearing bushes - DLC-coated piston pins
Piston	Forged light alloy
Piston ring	1 L-ring, 1 tapered compression piston ring, 1 oil scraper ring
Engine lubrication	Pressure circulation lubrication with 3 rotor pumps
Primary transmission	40:76
Clutch	Multi-disc clutch in oilbath / hydraulically operated
Transmission	6-speed claw gears
Transmission ratio	
1st gear	14:36
2nd gear	16:30

3rd gear	20:30
4th gear	21:27
5th gear	23:26
6th gear	25:26
Mixture preparation	Electronically controlled fuel injection
Ignition system	Contactless controlled fully electronic ignition with digital ignition adjustment
Generator	12 V, 390 W
Spark plug	NGK LKAR9BI9
Electrode gap, spark plug	0.8... 0.9 mm (0.031... 0.035 in)
Cooling	Water cooling, permanent circulation of coolant by water pump
Cold start device	Electric starter

## Capacity - engine oil

Engine oil	3.60 l (3.8 qt.)	External temperature: $\geq 0\text{ }^{\circ}\text{C}$ ( $\geq 32\text{ }^{\circ}\text{F}$ )	Engine oil (SAE 10W/50) (☛ S. 222)
		External temperature: $< 0\text{ }^{\circ}\text{C}$ ( $< 32\text{ }^{\circ}\text{F}$ )	Engine oil (SAE 5W/40) (☛ S. 222)

## Capacity - coolant

Coolant	2.60 l (2.75 qt.)	Coolant (☛ S. 221)
		Coolant (mixed ready to use) (☛ S. 221)

Hose clip, intake flange	M4	1.5 Nm (1.11 lbf ft)	–
Screw, gear sensor	M5	3 Nm (2.2 lbf ft)	<b>Loctite® 243™</b>
Screw, pulse generator	M5	10 Nm (7.4 lbf ft)	<b>Loctite® 243™</b>
Screw, bearing retainer	M5	6 Nm (4.4 lbf ft)	<b>Loctite® 243™</b>
Remaining engine screws	M5	6 Nm (4.4 lbf ft)	–
Oil jet	M6x0.75	4 Nm (3 lbf ft)	<b>Loctite® 243™</b>
Nut, cylinder head	M6	10 Nm (7.4 lbf ft)	–
Screw, locking lever	M6	10 Nm (7.4 lbf ft)	<b>Loctite® 243™</b>
Screw, freewheel holder	M6	10 Nm (7.4 lbf ft)	<b>Loctite® 243™</b>
Screw, freewheel ring	M6	13 Nm (9.6 lbf ft)	<b>Loctite® 648™</b>
Screw, generator cover	M6	10 Nm (7.4 lbf ft)	–
Stud, chain shaft	M6	8 Nm (5.9 lbf ft)	–
Screw, coolant connection on cylinder head	M6	10 Nm (7.4 lbf ft)	–
Screw, clutch cover	M6	10 Nm (7.4 lbf ft)	–
Screw, clutch spring	M6	12 Nm (8.9 lbf ft)	<b>Loctite® 243™</b>
Screw, engine housing	M6x60	10 Nm (7.4 lbf ft)	–
Screw, engine housing	M6x80	10 Nm (7.4 lbf ft)	–
Screw, engine housing	M6x90	10 Nm (7.4 lbf ft)	–
Screw, camshaft bearing support	M6	10 Nm (7.4 lbf ft)	–
Screw, oil pump cover	M6	10 Nm (7.4 lbf ft)	<b>Loctite® 243™</b>
Screw, shift drum locating	M6	10 Nm (7.4 lbf ft)	<b>Loctite® 243™</b>
Screw, shift lever	M6	10 Nm (7.4 lbf ft)	<b>Loctite® 243™</b>
Screw, starter motor	M6	10 Nm (7.4 lbf ft)	–

# TECHNICAL DATA - ENGINE TIGHTENING TORQUES

Screw, stator clamp	M6	10 Nm (7.4 lbf ft)	<b>Loctite® 243™</b>
Plug, vacuum connection	M6	5 Nm (3.7 lbf ft)	<b>Loctite® 243™</b>
Screw, valve cover	M6	10 Nm (7.4 lbf ft)	–
Screw, water pump cover	M6	10 Nm (7.4 lbf ft)	–
Screw, water pump wheel	M6	10 Nm (7.4 lbf ft)	<b>Loctite® 243™</b>
Remaining engine screws	M6	10 Nm (7.4 lbf ft)	–
Vacuum connection	M6	5 Nm (3.7 lbf ft)	<b>Loctite® 243™</b>
Stud, exhaust flange	M8	10 Nm (7.4 lbf ft)	–
Screw, timing chain guide rail	M8	15 Nm (11.1 lbf ft)	<b>Loctite® 243™</b>
Plug, crankshaft retainer	M8	15 Nm (11.1 lbf ft)	–
Screw, engine housing	M8	18 Nm (13.3 lbf ft)	–
Screw, engine console	M8	20 Nm (14.8 lbf ft)	<b>Loctite® 243™</b>
Screw, camshaft bearing support	M8	Step 1 10 Nm (7.4 lbf ft) Step 2 18 Nm (13.3 lbf ft)	–
Screw, camshaft bearing support	M8	Step 1 8.5 Nm (6.27 lbf ft) Step 2 14.5 Nm (10.7 lbf ft)	Only applies when using: Hex key bit (61229025000)
Screw, timing chain tensioning rail	M8	15 Nm (11.1 lbf ft)	<b>Loctite® 243™</b>
Screw, heat exchanger	M8	15 Nm (11.1 lbf ft)	–
Oil pressure sensor	M10x1	10 Nm (7.4 lbf ft)	–
Screw, timing chain tensioner release	M10x1	10 Nm (7.4 lbf ft)	–
Plug, clutch lubrication	M10x1	15 Nm (11.1 lbf ft)	–

# TECHNICAL DATA - ENGINE TIGHTENING TORQUES

Screw, conrod bearing	M10x1	Step 1 25 Nm (18.4 lbf ft) Step 2 30 Nm (22.1 lbf ft) Step 3 90°	–
Plug, cam lever axis	M10x1	15 Nm (11.1 lbf ft)	–
Screw, cylinder head	M11x1.5	Step 1 15 Nm (11.1 lbf ft) Step 2 30 Nm (22.1 lbf ft) Step 3 90° Step 4 90°	lubricated with engine oil
Coolant temperature sensor	M12x1.5	12 Nm (8.9 lbf ft)	–
Screw, ignition rotor	M12x1.5	90 Nm (66.4 lbf ft)	–
Spark plug	M12x1.5	12 Nm (8.9 lbf ft)	–
Oil drain plug	M20x1.5	20 Nm (14.8 lbf ft)	–
Nut, inner clutch hub	M22x1.5	130 Nm (95.9 lbf ft)	<b>Loctite® 243™</b>
Screw in generator cover	M24x1.5	8 Nm (5.9 lbf ft)	–
Plug, timing-chain tensioner	M24x1.5	25 Nm (18.4 lbf ft)	–
Nut, primary gear	M33LHx1.5	130 Nm (95.9 lbf ft)	<b>Loctite® 243™</b>

Frame	Lattice frame made of chromium molybdenum steel tubing, powder-coated
Fork	<b>WP Suspension</b> Up Side Down 4354
Shock absorber	<b>WP Suspension</b> 4014 VP
Suspension travel	
front	120 mm (4.72 in)
rear	125 mm (4.92 in)
Brake system	
front	Double disc brake with radially screwed four-piston brake calipers, float-mounted brake discs
rear	Single disc brake with dual-piston brake caliper, rigid-mounted brake disc
Brake discs - diameter	
front	320 mm (12.6 in)
rear	220 mm (8.66 in)
Brake discs - wear limit	
front	4.0 mm (0.157 in)
rear	4.5 mm (0.177 in)
Tire air pressure, Solo	
front	2.5 bar (36 psi)
rear	2.5 bar (36 psi)
Tire air pressure with passenger / full payload	
front	2.5 bar (36 psi)
rear	2.9 bar (42 psi)
Secondary drive	17:37

Chain	5/8 x 5/16" X-ring
Steering head angle	66.7°
Wheelbase	1,435 mm (56.5 in)
Seat height, unloaded	
Lower frame rear position	805 mm (31.69 in)
Upper frame rear position	825 mm (32.48 in)
Ground clearance, unloaded	110 mm (4.33 in)
Weight without fuel	188 kg (414 lb.)
Maximum permissible front axle load	200 kg (441 lb.)
Maximum permissible rear axle load	220 kg (485 lb.)
Maximum permissible total weight	380 kg (838 lb.)

Battery	YTZ14S	Battery voltage: 12 V Nominal capacity: 11 Ah maintenance-free
Fuse	58011109130	30 A
Fuse	75011088015	15 A
Fuse	75011088010	10 A

## Lighting equipment

Low beam / high beam	H7	12 V 55 W
Parking light	W2,1x9,5d	12 V 5 W
Instrument lights and control lamps	LED	
Flasher light	LED	

Brake/tail light	LED	
License plate lamp	W2,1x9,5d	12 V 5 W

<b>Front tire</b>	<b>Rear tire</b>
<b>120/70 ZR 17 58 W TL</b> Pirelli Dragon Supercorsa Pro	<b>190/55 ZR 17 75 W TL</b> Pirelli Dragon Supercorsa Pro
For further information, see the Service section under: <a href="http://www.ktm.com">http://www.ktm.com</a>	

## Capacity - fuel

Fuel tank content	16.5 l (4.36 US gal)	Super unleaded (ROZ 95 / RON 95 / PON 91) (☛ S. 223)
Fuel reserve	3.5 l (3.7 qt.)	



Fork part number	05.18.7D.07
Fork	<b>WP Suspension</b> Up Side Down 4354
Compression damping	
Comfort	15 clicks
Standard	10 clicks
Sport	5 clicks
full payload	5 clicks
Rebound damping	
Comfort	15 clicks
Standard	10 clicks
Sport	5 clicks
Full payload	5 clicks
Spring preload - <b>Preload Adjuster</b>	
Comfort	5 turns
Standard	5 turns
Sport	3 turns
full payload	3 turns
Spring length with preload spacer(s)	405 mm (15.94 in)
Spring rate	
Weight of rider: 75... 85 kg (165... 187 lb.)	10 N/mm (57 lb/in)
Air chamber length	80 <sup>+20</sup> <sub>-10</sub> mm (3.15 <sup>+0.79</sup> <sub>-0.39</sub> in)
Fork length	735 mm (28.94 in)
Fork oil (☛ S. 223)	SAE 5

Shock absorber part number	17.18.7D.07
Shock absorber	<b>WP Suspension</b> 4014 VP
Compression damping, high-speed	
Comfort	2 turns
Standard	1.5 turns
Sport	1 turn
full payload	1 turn
Compression damping, low-speed	
Comfort	20 clicks
Standard	15 clicks
Sport	10 clicks
full payload	10 clicks
Rebound damping	
Comfort	15 clicks
Standard	10 clicks
Sport	5 clicks
full payload	10 clicks
Spring preload	
Comfort	6 mm (0.24 in)
Standard	6 mm (0.24 in)
Sport	8 mm (0.31 in)
full payload	8 mm (0.31 in)
Spring rate	
Weight of rider: 75... 85 kg (165... 187 lb.)	110 N/mm (628 lb/in)

Spring length	160 mm (6.3 in)
Gas pressure	10 bar (145 psi)
Static sag	15 mm (0.59 in)
Riding sag	30 mm (1.18 in)
Inbuilt length	290 mm (11.42 in)

# TECHNICAL DATA - CHASSIS TIGHTENING TORQUES

Screw, side stand switch	M4	2 Nm (1.5 lbf ft)	<b>Loctite® 243™</b>
Screw, brake fluid reservoir of rear brake	M5	5 Nm (3.7 lbf ft)	<b>Loctite® 243™</b>
Screw, brake line holder	M5	5 Nm (3.7 lbf ft)	–
Screw, chain sliding piece	M5	5 Nm (3.7 lbf ft)	–
Screw, chain guard	M5	5 Nm (3.7 lbf ft)	–
Screw, fuel level indicator	M5	3 Nm (2.2 lbf ft)	–
Screw, steering damper fixing bracket	M5	5 Nm (3.7 lbf ft)	<b>Loctite® 243™</b>
Remaining chassis screws	M5	5 Nm (3.7 lbf ft)	–
Remaining chassis nuts	M6	15 Nm (11.1 lbf ft)	–
Screw, exhaust heat shield	M6	15 Nm (11.1 lbf ft)	–
Screw, exhaust clamp	M6	8 Nm (5.9 lbf ft)	–
Screw, foot brake pedal	M6	15 Nm (11.1 lbf ft)	<b>Loctite® 243™</b>
Screw, footbrake pedal stub	M6	10 Nm (7.4 lbf ft)	<b>Loctite® 243™</b>
Screw, footbrake cylinder	M6	10 Nm (7.4 lbf ft)	<b>Loctite® 243™</b>
Screw, fuel pump	M6	6 Nm (4.4 lbf ft)	–
Screw, shift lever stub	M6	10 Nm (7.4 lbf ft)	<b>Loctite® 243™</b>
Screw, shift rod	M6	12 Nm (8.9 lbf ft)	<b>Loctite® 243™</b>
Screw, shift shaft deflector on chain securing guide	M6	10 Nm (7.4 lbf ft)	<b>Loctite® 243™</b>
Screw, shift shaft deflector on shift shaft	M6	18 Nm (13.3 lbf ft)	<b>Loctite® 243™</b>
Remaining chassis screws	M6	10 Nm (7.4 lbf ft)	–
Remaining chassis nuts	M8	30 Nm (22.1 lbf ft)	–
Nut, forked bracket on footbrake pedal	M8	30 Nm (22.1 lbf ft)	<b>Loctite® 243™</b>
Screw, rear brake disc	M8	30 Nm (22.1 lbf ft)	<b>Loctite® 243™</b>

# TECHNICAL DATA - CHASSIS TIGHTENING TORQUES

Screw, front brake disc	M8	30 Nm (22.1 lbf ft)	<b>Loctite® 243™</b>
Screw, spring holder on side stand bracket	M8	15 Nm (11.1 lbf ft)	<b>Loctite® 243™</b>
Screw, rear footrest bracket	M8	25 Nm (18.4 lbf ft)	–
Screw, front footrest bracket	M8	25 Nm (18.4 lbf ft)	<b>Loctite® 243™</b>
Screw, top triple clamp	M8	17 Nm (12.5 lbf ft)	–
Screw, bottom triple clamp	M8	15 Nm (11.1 lbf ft)	–
Screw, fork stub	M8	15 Nm (11.1 lbf ft)	–
Screw, steering stem	M8	20 Nm (14.8 lbf ft)	–
Screw, handlebar stub	M8	20 Nm (14.8 lbf ft)	–
Screw, steering damper fixing bracket	M8	20 Nm (14.8 lbf ft)	<b>Loctite® 243™</b>
Screw, steering damper clamp on console	M8	20 Nm (14.8 lbf ft)	<b>Loctite® 243™</b>
Screw, work stand adapter	M8	25 Nm (18.4 lbf ft)	<b>Loctite® 243™</b>
Screw, subframe	M8	25 Nm (18.4 lbf ft)	<b>Loctite® 243™</b>
Screw, shift lever	M8	25 Nm (18.4 lbf ft)	<b>Loctite® 243™</b>
Screw, side stand bracket	M8	25 Nm (18.4 lbf ft)	<b>Loctite® 243™</b>
Screw, ignition lock (ratchet screw)	M8		<b>Loctite® 243™</b>
Remaining chassis screws	M8	25 Nm (18.4 lbf ft)	–
Remaining chassis nuts	M10	50 Nm (36.9 lbf ft)	–
Rear sprocket bolt	M10x1.25	50 Nm (36.9 lbf ft)	<b>Loctite® 243™</b>
Screw, front brake caliper	M10x1.25	45 Nm (33.2 lbf ft)	<b>Loctite® 243™</b>
Screw, shock absorber	M10	45 Nm (33.2 lbf ft)	<b>Loctite® 243™</b>
Screw, engine bearer	M10	45 Nm (33.2 lbf ft)	–
Screw, sidestand	M10	35 Nm (25.8 lbf ft)	<b>Loctite® 243™</b>

# TECHNICAL DATA - CHASSIS TIGHTENING TORQUES

Screw, connecting lever, shock absorber deflector	M10	45 Nm (33.2 lbf ft)	<b>Loctite® 243™</b>
Remaining chassis screws	M10	45 Nm (33.2 lbf ft)	–
Nut, deflection lever on frame	M14x1.5	100 Nm (73.8 lbf ft)	–
Lambda probe	M18x1.5	45 Nm (33.2 lbf ft)	–
Nut, swingarm pivot	M19x1.5	130 Nm (95.9 lbf ft)	Thread greased
Screw, seat lock	M22x1.5	8 Nm (5.9 lbf ft)	–
Nut, rear wheel spindle	M25x1.5	90 Nm (66.4 lbf ft)	Thread greased
Screw, front wheel spindle	M25x1.5	45 Nm (33.2 lbf ft)	–
Screw, steering head	M25x1.5	18 Nm (13.3 lbf ft)	–

## Brake fluid DOT 4 / DOT 5.1

### according to

- DOT

### Specification

- Use only brake fluid that complies with the specified standards (see specifications on the container) and that possesses the corresponding properties. KTM recommends **Castrol** and **Motorex®** products.

### Supplier

#### Castrol

- **RESPONSE BRAKE FLUID SUPER DOT 4**

#### Motorex®

- **Brake Fluid DOT 5.1**

## Coolant

### Specification

- Use only suitable coolant (even in countries with high temperatures). Using inferior antifreeze can result in corrosion and foaming. KTM recommends **Motorex®** products.

### Mixture ratio

Antifreeze: -25... -45 °C (-13... -49 °F)	50 % Anti-corrosion/antifreeze 50 % distilled water
---	--

## Coolant (mixed ready to use)

Antifreeze	-40 °C (-40 °F)
------------	-----------------

### Supplier

#### Motorex®

- **Anti Freeze**

## Engine oil (SAE 10W/50)

### according to

- JASO T903 MA (☛ S. 226)
- SAE (☛ S. 226) (SAE 10W/50)

### Specification

- Use only engine oils that comply with the specified standards (see specifications on the container) and that possess the corresponding properties. KTM recommends **Motorex®** products.

fully synthetic engine oil

### Supplier

**Motorex®**

- **Power Synt 4T**

## Engine oil (SAE 5W/40)

### according to

- JASO T903 MA (☛ S. 226)
- SAE (☛ S. 226) (SAE 5W/40)

### Specification

- Use only engine oils that comply with the specified standards (see specifications on the container) and that possess the corresponding properties. KTM recommends **Motorex®** products.

Synthetic engine oil

### Supplier

**Motorex®**

- **Power Synt 4T**



## Fork oil (SAE 5)

### according to

- SAE (☛ S. 226) (SAE 5)

### Specification

- Use only oils that comply with the specified standards (see specifications on the container) and that possesses the corresponding properties. KTM recommends **Motorex®** products.

### Supplier

#### Motorex®

- **Racing Fork Oil**

## Hydraulic fluid (15)

### according to

- ISO VG (15)

### Specification

- Use only hydraulic fluid that complies with the specified standards (see specifications on the container) and that possesses the corresponding properties. KTM recommends **Motorex®** products.

### Supplier

#### Motorex®

- **Hydraulic Fluid 75**

## Super unleaded (ROZ 95 / RON 95 / PON 91)

### according to

- DIN EN 228 (ROZ 95 / RON 95 / PON 91)

## Chain cleaner

### Specification

- KTM recommends **Motorex®** products.

### Supplier

#### Motorex®

- **Chain Clean 611**

## Cleaning and polishing materials for metal, rubber and plastic

### Specification

- KTM recommends **Motorex®** products.

### Supplier

#### Motorex®

- **Protect & Shine 645**

## High-luster polish for paint

### Specification

- KTM recommends **Motorex®** products.

### Supplier

#### Motorex®

- **Moto Polish**

## Long-life grease

### Specification

- KTM recommends **Motorex®** products.

### Supplier

#### Motorex®

- **Fett 2000**

## Motorcycle cleaner

### Specification

- KTM recommends **Motorex®** products.

### Supplier

#### Motorex®

- **Moto Clean 900**

## Onroad chain spray

### Specification

- KTM recommends **Motorex®** products.

### Supplier

#### Motorex®

- **Chain Lube 622 Strong**

## Universal oil spray

### Specification

- KTM recommends **Motorex®** products.

### Supplier

#### Motorex®

- **Joker 440 Universal**

## JASO T903 MA

Different technical development directions required a new specification for 4-stroke motorcycles – the JASO T903 MA Standard. Earlier, engine oils from the automobile industry were used for 4-stroke motorcycles because there was no separate motorcycle specification. Whereas long service intervals are demanded for automobile engines, high performance at high engine speeds are in the foreground for motorcycle engines. With most motorcycles, the gearbox and the clutch are lubricated with the oil as the engine. The JASO MA Standard meets these special requirements.

## SAE

The SAE viscosity classes were defined by the Society of Automotive Engineers and are used for classifying oils according to their viscosity. The viscosity describes only one property of oil and says nothing about quality.

**B****Battery**

fitting	150
recharging	151
removing	148

**Blank time of the LAP button LAP BLANK T**

adjusting	65
-----------	----

**Brake disc of rear brake**

checking	129
----------	-----

**Brake discs, front**

checking	128
----------	-----

**Brake fluid**

topping up brake fluid of front brake	130
topping up for rear brake	134

**Brake fluid level**

of front brake, checking	130
of rear brake, checking	133

**Brake linings** 132

of front brake, checking	132
of rear brake, checking	135

**Brakes** 87**Braking** 87**C****Chain**

checking for dirt	121
checking for wear	127

cleaning	122
----------	-----

**Chain sliding guard**

checking	128
----------	-----

**Chain tension**

adjusting	124
checking	123

**Chassis number** 16**Cleaning** 202-203**Clutch**

checking fluid level	175
correcting fuel level	176

**Clutch lever** 19

adjusting basic position	175
--------------------------	-----

**Combination instrument**

activation and test	26
display	27
function buttons, handlebar	25
indicator lamps	29
info display	28
Notes/warnings	30

**Conservation for winter operation** 204**Coolant level**

checking	172
----------	-----

**Cooling system** 171

filling compensating tank	173
---------------------------	-----

<b>E</b>	
<b>Electric starter button</b> .....	23
<b>Emergency OFF switch</b> .....	22
<b>Engine</b>	
running in .....	78
<b>Engine number</b> .....	17
<b>Engine oil</b>	
changing .....	185
draining .....	185
refilling .....	190
topping up .....	192
<b>Engine oil level</b>	
checking .....	184
<b>Environment</b> .....	9
<b>External temperature display</b>	
switching on/off .....	69
<b>F</b>	
<b>Filler cap</b>	
closing .....	72
opening .....	71
<b>Filling up</b>	
fuel .....	89
<b>Flasher switch</b> .....	21
<b>Flashing code</b>	
Engine control .....	198-201
immobilizer .....	197

<b>Foot brake pedal</b> .....	<b>76</b>
adjusting .....	121
<b>Footbrake pedal stub</b>	
adjusting .....	120
<b>Footrest position</b> .....	<b>113</b>
adjusting .....	113
<b>Fork</b> .....	<b>97</b>
Adjusting compression damping .....	97
Adjusting rebound .....	98
adjusting spring preload .....	99
bleeding fork legs .....	100
<b>Fork part number</b> .....	17
<b>Front wheel</b>	
fitting .....	137
removing .....	136
<b>Fuel reserve display TRIP F RESET</b>	
adjusting .....	67
<b>Fuse</b>	
of individual power consumer, changing .....	155
<b>H</b>	
<b>Hand brake lever</b> .....	<b>19</b>
adjusting basic position .....	129
<b>Handlebar height</b> .....	<b>177</b>
adjusting .....	178
<b>Headlight adjustment</b>	
adjusting .....	167

checking	167
<b>Headlight flasher switch</b>	20
<b>Helmet lock</b>	<b>74</b>
fitting to vehicle	148

<b>High beam bulb</b>	
changing	160
<b>Horn button</b>	21

## I

<b>Ignition key</b>	
activating/deactivating	168
<b>Ignition lock</b>	22

## K

<b>Key number</b>	16
<b>Kilometers/miles SET KM/MILES</b>	
adjusting	68

## L

<b>Lap times</b>	
displaying	60
<b>Light switch</b>	20
<b>Loading the vehicle</b>	79
<b>Low beam bulb</b>	
changing	157
<b>Luggage</b>	79

## M

<b>Main fuse</b>	
changing	153
<b>Maintenance</b>	8
<b>Materials</b>	8
<b>Maximum speed</b>	
displaying	61
<b>Motorcycle</b>	
cleaning	202
jacking up front	95
jacking up rear	96
taking front off work stand	95
taking rear off work stand	96

## N

<b>Number of laps SET NUM LAPS</b>	
adjusting	66

## O

<b>Oil filter</b>	
changing	185
fitting	190
removing	188
<b>Oil screen</b>	
cleaning	185
<b>Operating instructions</b>	
Basics	10

<b>P</b>	
<b>Parking</b> .....	88
<b>Parking light bulb</b>	
changing .....	164
<b>Passenger footrests</b> .....	74
<b>Passenger seat</b>	
mounting .....	147
removing .....	147
<b>Play in gas Bowden cable</b>	
adjusting .....	177
<b>Putting into operation</b>	
advice on first use .....	77
after storage .....	206
checks to be made before putting into operation .....	81
<b>R</b>	
<b>RACE mode</b>	
adjusting .....	62
<b>Rear frame position</b> .....	179
adjusting .....	180
<b>Rear hub shock absorber</b>	
checking .....	143
<b>Rear sprocket / engine sprocket</b>	
checking for wear .....	126
<b>Rear wheel</b>	
fitting .....	140
removing .....	138

<b>Riding</b> .....	84
starting up .....	83
<b>ROAD mode</b>	
adjusting .....	62
<b>S</b>	
<b>Seat</b>	
fitting .....	146
removing .....	146
<b>Seat lock</b> .....	73
<b>SET °C/°F temperature unit</b>	
adjusting .....	69
<b>SET CLOCK</b>	
adjusting .....	62
<b>Shift lever</b> .....	75
adjusting .....	116
<b>Shift lever stub</b>	
adjusting .....	116
<b>Shift speed RPM1/2</b>	
adjusting .....	63
<b>Shifting</b> .....	84
<b>Shock absorber</b> .....	97
adjusting rebound damping .....	104
adjusting spring preload .....	104
compression damping, general .....	101
compression damping, high-speed, adjusting .....	103
compression damping, low-speed, adjusting .....	101



<b>Shock absorber part number</b> .....	18
<b>Side stand</b> .....	76
<b>Spare parts, accessories</b> .....	8
<b>Starting</b> .....	82
<b>Steering damper</b> .....	<b>107</b>
adjusting .....	107
<b>Steering damper part number</b> .....	18
<b>Steering lock</b> .....	22
<b>Stopping</b> .....	88
<b>Storage</b> .....	205
<b>Supporting strap</b> .....	72

## T

### Technical data

chassis .....	212-214
chassis tightening torques .....	218-220
engine .....	207-208
engine tightening torques .....	209-211
fork .....	215
shock absorber .....	216-217

### Tire air pressure

checking .....	145
----------------	-----

### Tire condition

checking .....	143
----------------	-----

<b>Tool set</b> .....	73
-----------------------	----

<b>Transport</b> .....	9
------------------------	---

<b>Troubleshooting</b> .....	194-196
------------------------------	---------

<b>Type label</b> .....	16
-------------------------	----

## V

<b>Vehicle level</b> .....	<b>109</b>
----------------------------	------------

adjusting, rear .....	111
front, adjusting .....	110

### View of vehicle

front left .....	12
rear right side .....	14

## W

<b>Warranty</b> .....	8
-----------------------	---

<b>Work rules</b> .....	9
-------------------------	---



3211250en



02/2008 Photo Mitterbauer



**KTM-Sportmotorcycle AG**  
5230 Mattighofen/Austria  
<http://www.ktm.com>

## Free Manuals Download Website

<http://myh66.com>

<http://usermanuals.us>

<http://www.somanuals.com>

<http://www.4manuals.cc>

<http://www.manual-lib.com>

<http://www.404manual.com>

<http://www.luxmanual.com>

<http://aubethermostatmanual.com>

Golf course search by state

<http://golfingnear.com>

Email search by domain

<http://emailbydomain.com>

Auto manuals search

<http://auto.somanuals.com>

TV manuals search

<http://tv.somanuals.com>