

Panasonic®

DIGITAL Palmcorder®
CAMCORDER

Digital Video Camcorder

Operating Instructions

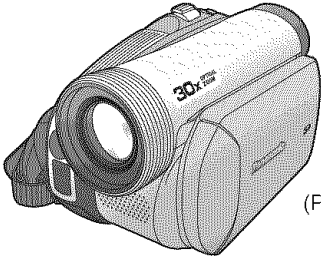

(PV-GS59 Shown)

Models No. **PV-GS59**
PV-GS39
PV-GS29

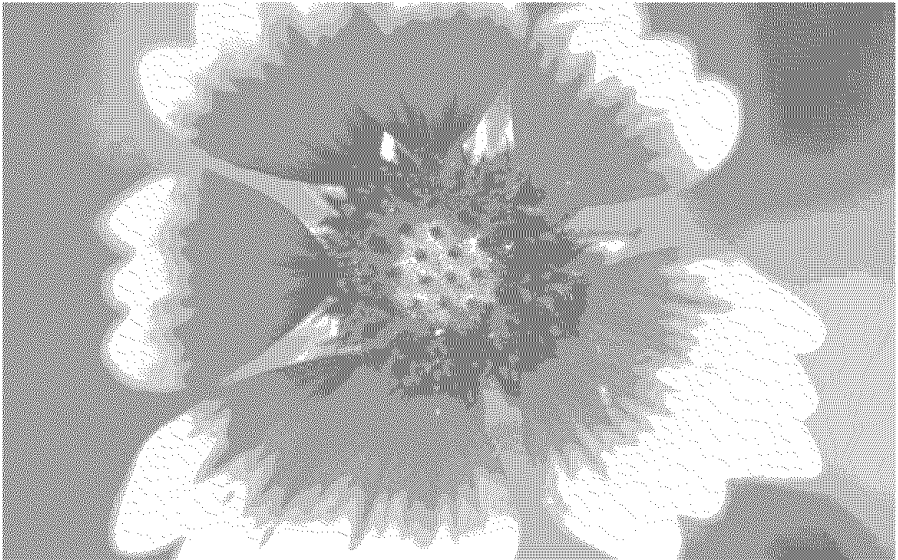

Before attempting to connect, operate or adjust this product, please read these instructions thoroughly.

Spanish Quick Use Guide is included.

Guía para rápida consulta en español está incluida.



For assistance, please call : 1-800-211-PANA(7262) or, contact us via the web at: <http://www.panasonic.com/contactinfo>

For assistance, please call : 1-800-561-5505 or visit us at www.panasonic.ca

P PC

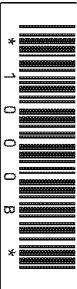

LSQT1000 B

Things You Should Know

Thank you for choosing Panasonic!

You have purchased one of the most sophisticated and reliable products on the market today. Used properly, we're sure it will bring you and your family years of enjoyment. Please take time to fill in the information on the right.

The serial number is on the tag located on the underside of your Camcorder. Be sure to **retain this manual** as your convenient Camcorder information source.

Date of Purchase

Dealer Purchased From

Dealer Address

Dealer Phone No.

Model No.

Serial No.

Safety Precautions

WARNING :

TO PREVENT FIRE OR SHOCK HAZARD, DO NOT EXPOSE THIS EQUIPMENT TO RAIN OR MOISTURE.

Your ^{Mini}DV Camcorder is designed to record and play back in Standard Play (SP) mode and Long (LP) mode.

It is recommended that only cassette tapes that have been tested and inspected for use in Camcorders with the ^{Mini}DV mark be used.

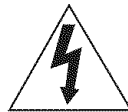
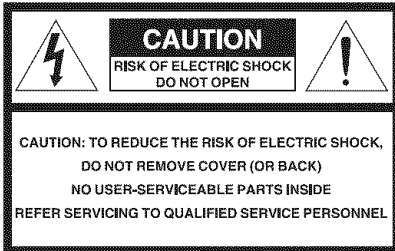

This symbol warns the user that uninsulated voltage within the unit may have sufficient magnitude to cause electric shock. Therefore, it is dangerous to make any kind of contact with any inside part of this unit.



This symbol alerts the user that important literature concerning the operation and maintenance of this unit has been included. Therefore, it should be read carefully in order to avoid any problems.

The above markings are located on the appliance bottom cover.

CAUTION:

TO PREVENT FIRE OR SHOCK HAZARD AND ANNOYING INTERFERENCE, USE THE RECOMMENDED ACCESSORIES ONLY.

CAUTION:

DANGER OF EXPLOSION IF BATTERY IS INCORRECTLY REPLACED. REPLACE ONLY WITH THE SAME OR EQUIVALENT TYPE.

- Since this product gets hot during use, operate it in a well ventilated place; do not install this equipment in a confined space such as a bookcase or similar unit.

⚠ WARNING

AS WITH ANY SMALL OBJECT, SD CARDS CAN BE SWALLOWED BY YOUNG CHILDREN. DO NOT ALLOW CHILDREN TO HANDLE THE SD CARD.

- U.S.A. CONSUMERS Only-

Declaration of Conformity

Trade Name : Panasonic
Model No. : PV-GS29/PV-GS39/PV-GS59
Responsibility Party : Panasonic Corporation of North America
Address : One Panasonic Way Secaucus New Jersey 07094
Telephone Number : 1-800-211-PANA(7262)

This device complies with Part 15 of the FCC Rules. Operation is subject to the following two conditions: (1) This device may not cause harmful interference, and (2) this device must accept any interference received, including interference that may cause undesired operation.

FCC Note:

This equipment has been tested and found to comply with the limits for a Class B digital device, pursuant to Part 15 of the FCC Rules. These limits are designed to provide reasonable protection against harmful interference in a residential installation. This equipment generates, uses, and can radiate radio frequency energy and, if not installed and used in accordance with the instructions, may cause harmful interference to radio communications. However, there is no guarantee that interference will not occur in a particular installation. If this equipment does cause harmful interference to radio or television reception, which can be determined by turning the equipment off and on, the user is encouraged to try to correct the interference by one or more of the following measures:

- Reorient or relocate the receiving antenna.
- Increase the separation between the equipment and receiver.
- Connect the equipment into an outlet on a circuit different from that to which the receiver is connected.
- Consult the dealer or an experienced radio/TV technician for help.

FCC Caution:

To assure continued compliance, follow the attached installation instructions and use only shielded interface cables when connecting to computer or peripheral devices. Any changes or modifications not expressly approved by the party responsible for compliance could void the user's authority to operate this equipment.

Panasonic

PV-GS29/PV-GS39/
PV-GS59



Tested To Comply
With FCC Standards

FOR HOME OR OFFICE USE

U.S.A. /CANADA CONSUMERS: ATTENTION:



A lithium ion/polymer battery that is recyclable powers the product you have purchased. Please call 1-800-8-BATTERY for information on how to recycle this battery.

- CANADA CONSUMERS Only-

This class B digital apparatus complies with CANADIAN ICES-003.

Important Safety Instructions

- 1) Read these instructions.
- 2) Keep these instructions.
- 3) Heed all warnings.
- 4) Follow all instructions.
- 5) Do not use this apparatus near water.
- 6) Clean only with dry cloth.
- 7) Do not block any ventilation openings. Install in accordance with the manufacturer's instructions.
- 8) Do not install near any heat sources such as radiators, heat registers, stoves, or other apparatus (including amplifiers) that produce heat.
- 9) Do not defeat the safety purpose of the polarized or grounding-type plug. A polarized plug has two blades with one wider than the other. A grounding type plug has two blades and a third grounding prong. The wide blade or the third prong are provided for your safety. If the provided plug does not fit into your outlet, consult an electrician for replacement of the obsolete outlet.
- 10) Protect the power cord from being walked on or pinched particularly at plugs, convenience receptacles, and the point where they exit from the apparatus.
- 11) Only use attachments/accessories specified by the manufacturer.
- 12) Use only with the cart, stand, tripod, bracket, or the table specified by the manufacturer, or sold with the apparatus. When a cart is used, use caution when moving the cart/apparatus combination to avoid injury from tip-over.
- 13) Unplug this apparatus during lightning storms or when it will be left unused for long periods of time.
- 14) Refer all servicing to qualified service personnel. Servicing is required when the apparatus has been damaged in any way, such as when the power-supply cord or plug is damaged, liquid has been spilled or objects have fallen into the apparatus, the apparatus has been exposed to rain or moisture, does not operate normally, or has been dropped.



Precautions

USE & LOCATION

WARNING

- **TO AVOID SHOCK HAZARD ...** Your Camcorder and power supply should not be exposed to rain or moisture. Do not connect the power supply or operate your Camcorder if it gets wet. Your Camcorder has been designed for outdoor use, however it is not designed to sustain direct exposure to water, rain, sleet, snow, sand, dust, or a direct splashing from a pool or even a cup of coffee. This action could permanently damage the internal parts of your Camcorder. Do not attempt to disassemble this unit. There are no user serviceable parts inside. Unplug your Camcorder from the power supply before cleaning.

CAUTION

- **DO NOT AIM YOUR CAMCORDER AT THE SUN OR OTHER BRIGHT OBJECTS**
- **DO NOT LEAVE THE CAMCORDER WITH THE EVF AIMED DIRECTLY AT THE SUN AS THIS MAY CAUSE DAMAGE TO THE INTERNAL PARTS OF THE EVF**
- **DO NOT EXPOSE YOUR CAMCORDER TO EXTENDED HIGH TEMPERATURE**
... Such as, in direct sunlight, inside a closed car, next to a heater, etc... This action could permanently damage the internal parts of your Camcorder.

- **AVOID SUDDEN CHANGES IN TEMPERATURE ...** If the unit is suddenly moved from a cold place to a warm place, moisture may form on the tape and inside the unit.
- **DO NOT LEAVE YOUR CAMCORDER OR THE POWER SUPPLY TURNED ON WHEN NOT IN USE.**
- **STORAGE OF YOUR CAMCORDER ...** Store and handle your Camcorder in a manner that will not subject it to unnecessary movement (avoid shaking and striking). Your Camcorder contains a sensitive pick-up device which could be damaged by improper handling or storage.

CARE

- **TO CLEAN YOUR CAMCORDER ...** Do not use strong or abrasive detergents when cleaning your Camcorder body.
- **TO PROTECT THE LENS ...** Do not touch the surface of the lens with your hand. Use a commercial Camcorder lens solution and lens paper when cleaning the lens. Improper cleaning can scratch the lens coating.
- **TO PROTECT THE FINISH OF YOUR CAMCORDER ...** Before handling your Camcorder, make sure your hands and face are free from any chemical products, such as suntan lotion, as it may damage the finish.

Apparatus Claims of U.S. Patent Nos. 4,631,603, 4,577,216, and 4,819,098, licensed for limited viewing.

This product incorporates copyright protection technology that is protected by method claims of certain U.S. patents and other intellectual property rights owned by Macrovision Corporation and other rights owners. Use of this copyright protection technology must be authorized by Macrovision Corporation, and is intended for home and other limited viewing uses only unless otherwise authorized by Macrovision Corporation. Reverse engineering or disassembly is prohibited.

- If you see this symbol -

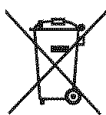

Information on Disposal in other Countries outside the European Union

This symbol is only valid in the European Union.

If you wish to discard this product, please contact your local authorities or dealer and ask for the correct method of disposal.

End User License Agreement (for USB Driver, MotionDV STUDIO and Quick Movie Magic)

Before opening the CD-ROM package (PV-GS59 Only), please read the following.

You ("Licensee") are granted a license for the Software defined in this End User Software Agreement ("Agreement") on condition that you agree to the terms and conditions of this Agreement. If Licensee does not agree to the terms and conditions of this Agreement, promptly return the Software to Matsushita Electric Industrial Co., Ltd. ("Matsushita"), its distributors or dealers from which you made the purchase.

Article 1 License

Licensee is granted the right to use the software, including the information recorded or described on the CD-ROM, instruction manuals, and any other media provided to Licensee (collectively "Software"), but all applicable rights to patents, copyrights, trademarks and trade secrets in the Software are not transferred to Licensee.

Article 2 Use by a Third Party

Licensee may not use, copy, modify, transfer or allow any third party, whether free of charge or not, to use, copy or modify the Software, except as expressly provided for in this Agreement.

Article 3 Restrictions on Copying the Software

Licensee may make a single copy of the Software in whole or in part solely for back-up purpose.

Article 4 Computer

Licensee may only use the Software on a single computer at a single location.

Article 5 Reverse Engineering, Decompiling or Disassembly

Licensee may not reverse engineer, decompile, or disassemble the Software, except to the extent either of them is permitted under law or regulation of the country where Licensee resides. Matsushita, or its distributors or dealers will not be responsible for any defects in the Software or damage to Licensee caused by Licensee's reverse engineering, decompiling, or disassembly of the Software.

Article 6 Limitation of Liability

The Software is provided "AS-IS" without warranty of any kind, either expressed or implied, including, but not limited to, warranties of non-infringement, merchantability and/or fitness for a particular purpose. Further, Matsushita does not warrant that the operation of the Software will be uninterrupted or error free. Matsushita or any of its distributors or dealers will not be liable for any damage suffered by Licensee arising from or in connection with Licensee's use of the Software.

Article 7 Export Control

Licensee agrees not to export or re-export to any country the Software in any form without the appropriate export licenses under regulations of the country where Licensee resides, if necessary.

Article 8 Termination of License

The right granted to Licensee hereunder will be automatically terminated if Licensee violates any of the terms and conditions of this Agreement. Upon such automatic termination, Licensee must destroy the Software and related documentation together with all the copies thereof at Licensee's own expense.

Differences between models

This operating instruction book is designed for use with models **PV-GS29**, **PV-GS39** and **PV-GS59**. The **PV-GS59** is the model used for illustrative purposes. Features may vary, so please read carefully.

Model Number	PV-GS29	PV-GS39	PV-GS59
Battery Pack (Supplied)	CGR-DU06 (640 mAh)	CGR-DU06 (640 mAh)	For U.S.A. customers: CGR-DU06 (640 mAh) For Canada customers: CGA-DU12 (1 150 mAh)
CD-ROM	–	–	Supplied (LSFT0648)
USB Cable	–	For U.S.A. customers: – For Canada customers: Supplied (K1HA05CD0014)	Supplied (K1HA05CD0014)
Card Feature	No	Yes	Yes
Monitor	2.5-inch LCD	2.7-inch Wide LCD	2.7-inch Wide LCD
USB Jack*	No	Yes (Full-Speed)	Yes (High-Speed)
Audio Dubbing	No	No	Yes
Recording a Still Picture on a Tape	Yes	No	No
Cinema Function	Yes	No	No
Wide/4:3 Function	No	Yes	Yes
Remote Control Sensor	No	No	Yes

* It is only compatible with USB 2.0 PCI Card and/or connection.

■ How to Turn off the Demo Mode

To terminate the demonstration mode, insert a cassette or set the [ DEMO MODE] to [OFF] as follows.

1 Set [ SETUP] >> [ DEMO MODE] >> [OFF].

With a PC (Operating System Compatibility Chart)

Before using the PC function (pp. 56–69), please refer to the OS (operating system) compatibility chart, below.

■ For Windows

Model Number	Windows OS	Built-in SD Drive	Web Camera	MotionDV STUDIO/ Quick Movie Magic
PV-GS29	Windows 2000	–	–	–
	Windows XP	–	–	–
PV-GS39	Windows 2000	Yes*	Yes (SP4 or later)	–
	Windows XP	Yes*	Yes (SP2 or later)*	–
PV-GS59	Windows 2000	Yes*	Yes (SP4 or later)	Yes (SP4 or later)
	Windows XP	Yes*	Yes (SP1 or later)	Yes (SP2 or later)

■ For Macintosh

Model Number	Macintosh OS	Built-in SD Drive	Web Camera	MotionDV STUDIO/ Quick Movie Magic
PV-GS29	X v 10.1 - v 10.4	–	–	–
PV-GS39	X v 10.1 - v 10.4	Yes*	–	–
PV-GS59	X v 10.1 - v 10.4	Yes*	–	–

* The USB equipment operates with the driver installed standard on your OS.

■ For Macintosh (DV connection)

Model Number	Macintosh OS	iMovie/iMovieHD
PV-GS29	X v 10.3 - v 10.4	Yes
PV-GS39	X v 10.3 - v 10.4	Yes
PV-GS59	X v 10.3 - v 10.4	Yes

Contents

Before Using

Things You Should Know	2
Safety Precautions	2
Precautions	5
End User License Agreement	6
Differences between models	7
With a PC (Operating System Compatibility Chart)	8
Quick Guide	10
Standard Accessories	12
Parts Identification and Handling	12
The Remote Control (PV-GS59 Only : Optional)	14
Power Supply	15
Charging Time and Available Recording Time	16
How to remove the Sensor tag (For U.S.A. customers)	17
To Use as a Grip Belt	17
Re-attaching the Lens Cap	17
Attaching the Shoulder Strap	18
Inserting/Removing a Cassette	18
Using a Memory Card (Optional) (For PV-GS39/PV-GS59)	19
Turning on the Camcorder	20
Setting Date and Time	21
Using the Viewfinder/LCD Monitor	21
Easy to Use Mode Dial	23
How to Use the Joystick Control	23
Using the Menu Screen	25
Selecting Language	26
List of Menus	26
LP Mode	29

Recording Mode

About Recording	30
Recording on a Tape	30
To Check the Recording	31
Finding the End of Recording (Blank Search Function)	31
Recording a Still Picture on a Tape (PV-GS29 Only)	31
Recording a Still Picture on a Card (Photoshot) (For PV-GS39/PV-GS59)	32
Recording Yourself	33
Recording with the Built-in LED Video Light	33
Quick Start	34
Self-timer Recording (For PV-GS39/PV-GS59)	35
Zoom In/Out Functions	35
Digital Zoom Function	36
Image Stabilizer Function	36
Fade In/Out Functions	37
Backlight Compensation Function	37
MagicPix Function	38
Soft-Skin Mode	38
Wind Noise Reduction Function	39
Cinema Function (PV-GS29 Only)	39
Wide/4:3 Function (For PV-GS39/PV-GS59)	39
Recording in Special Situations (Scene Mode)	40
Recording in Natural Colors (White Balance)	41
Manual Shutter Speed Adjustment	42
Manual Iris Adjustment (F Number)	43
Manual Focus Adjustment	44

Playback Mode

Playing Back a Tape	45
Finding a Scene You Want to Play Back	46
Slow Motion Playback (PV-GS59 Only)	46
Still Playback/Still Advance Playback	47
Playing Back a Memory Card (For PV-GS39/PV-GS59)	47
Slide Show (For PV-GS39/PV-GS59)	48
Deleting the Files Recorded on a Card (For PV-GS39/PV-GS59)	49
Writing Printing Data on a Card (DPOF Setting) (For PV-GS39/PV-GS59)	50
Protecting the Files on a Card (Lock Setting) (For PV-GS39/PV-GS59)	50
Formatting a Card (For PV-GS39/PV-GS59)	51
Playing Back on Your TV	51

Editing Mode

Recording from a Tape onto a Card (For PV-GS39/PV-GS59)	53
Audio Dubbing (PV-GS59 Only)	53
Copying onto a DVD Recorder or a VCR (Dubbing)	54
Using the DV Cable for Recording (Digital Dubbing)	54
PC Connection With DV Interface Cable	55

With a PC

Using Camcorder with a PC	56
Using the USB Function	56
To disconnect USB cable safely	59
Using as a Web Camera	60
Using the Motion Picture Editing Software (PV-GS59 Only)	64
If you no longer need software or driver (Uninstall)	67
Transferring Motion DV Tape Pictures (Camcorder→Macintosh) via DV Cable (iMovie / iMovie HD)	67
Notes	68

Others

Indications	70
Warning/Alarm Indications	71
Cautions for Use	72
Before Requesting Service (Problems and Solutions)	75
Using the RESET button	78
Explanation of Terms	79
Specifications	80
Camcorder Accessory System	81
Camcorder Accessory Order Form (For U.S.A. customers)	82
Request for Service Notice (For U.S.A. customers)	83
Limited Warranty (For U.S.A. customers)	84
Customer Services Directory	85
Warranty (For Canada customers)	86
Spanish Quick Use Guide/Guía Para Uso Rápido	87
Guía rápida	88
Index	90

Quick Guide

Using the Battery

- 1 Attach the Battery to the AC Adaptor and charge it.

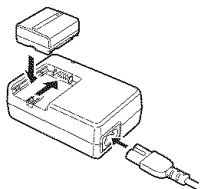

- Before use, fully charge the Battery.
- Since the Battery will not be charged when the DC Cable is connected to the AC Adaptor, disconnect it from the AC Adaptor.
- The [CHARGE] Lamp lights up, and charging starts.
- When the [CHARGE] Lamp goes off, charging is completed.

- 2 Attach the charged Battery to the Camcorder.

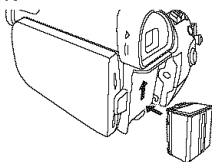

Inserting a Cassette

- 1 Slide the [OPEN/EJECT] Lever ① toward the front and pull up to fully open the Cassette Compartment Cover.
- To protect the tape, if the cover is not fully opened, the cassette holder cannot be ejected.

- 2 After the Cassette Holder is opened, insert a Cassette.

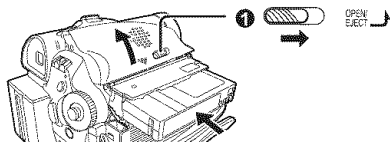

- 3 Close the Cassette Holder by pressing the [PUSH] mark ②.

- 4 Only after the Cassette Holder is completely housed, close the Cassette Compartment Cover by pressing the mark ③.

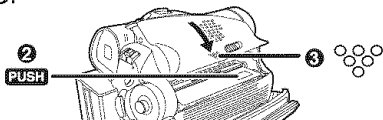

Inserting a Card

- 1 Place your Thumb on the [OPEN] ① Knob and pull the LCD Monitor ② out in the direction of the arrow.

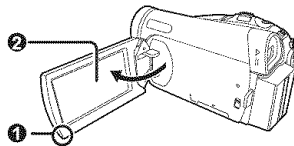

- 2 Open the Card Slot Cover ③.
- 3 While holding the Memory Card with its cut corner facing right ④ insert it into the Card Slot ⑤.
- 4 Close the Card Slot Cover ③ securely.

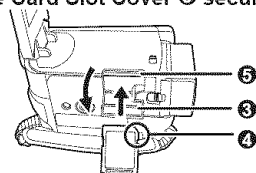

Turning on the Camcorder

- Open the LCD Monitor or extend the Viewfinder before turning on the power.

■ How to Turn on the Power

- 1 Set the [OFF/ON] Switch to [ON] while pressing the button ①.
- The [STATUS] Indicator lights Red.

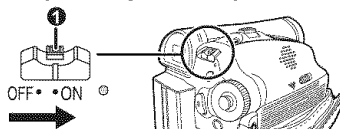

■ How to Turn off the Power

- 2 Set the [OFF/ON] Switch to [OFF] while pressing the button ①.
- The [STATUS] Indicator goes off.

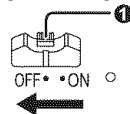

Using the Viewfinder

Before using the Viewfinder, adjust the field of view so that the displays inside the Viewfinder become clear and easy to read.

- 1 Pull the Viewfinder.

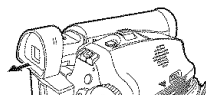

2 Adjust by turning the Eyepiece Corrector Knob ①.

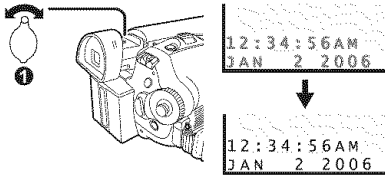

Recording on a Tape

1 Set the Mode Dial to Tape Recording Mode.

- The [TAPE RECORDING MODE] is displayed on the screen.

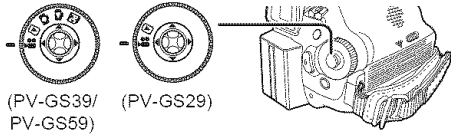

2 Press the Recording Start/Stop Button.

- Recording starts.

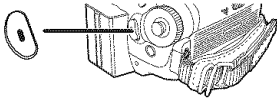

3 Press the Recording Start/Stop Button again to pause the recording.

Recording a Still Picture on Card (Photoshot) (For PV-GS39/PV-GS59)

1 Set the Mode Dial to Card Recording Mode.

- The [CARD RECORDING MODE] is displayed on the screen.

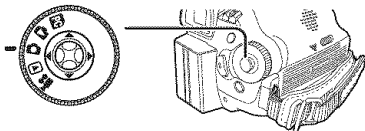

2 Press the [PHOTO SHOT] Button.

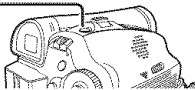

Playing Back a Tape

1 Set the Mode Dial to Tape Playback Mode.

- The [TAPE PLAYBACK MODE] is displayed on the screen.
- The One-Touch Navigation icon is displayed on the lower right of the screen.

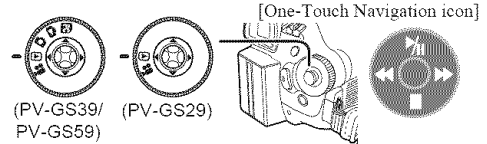

2 Move the Joystick Control [◀] ① to rewind the tape.

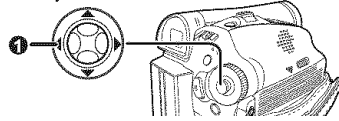

3 Move the Joystick Control [▶] ② to start playback.

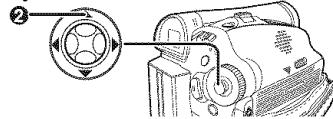

4 Move the Joystick Control [▼] ③ to stop playback.

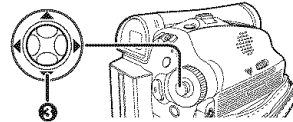

Playing Back a Card (For PV-GS39/PV-GS59)

1 Set the Mode Dial to Picture Playback Mode.

- The [CARD PLAYBACK MODE] is displayed on the screen.
- The One-Touch Navigation icon is displayed on the lower right of the screen.

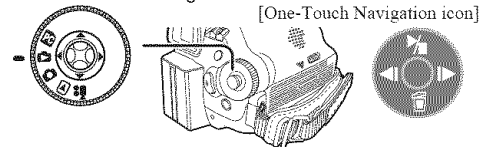

2 Start Playback.

Joystick Control [▶]: Starting the Slide Show
Stop the Slide Show

Joystick Control [▼]: Erase the pictures









Joystick Control [◀]: Playing back the previous picture

Joystick Control [▶]: Playing back the next picture

Before Using

Standard Accessories

The following accessories are supplied with your Camcorder.

1)		
		
PV-DAC14D	K2GJ2DC00011	K2CA2CA00025
2)		3)
		
CGA-DU12 (PV-GS59 Canada Only)	CGR-DU06	K2KC4CB00020
4)	5)	
		
LSFC0018	K1HA05CD0014 (For PV-GS39 (Canada Only)/ PV-GS59)	LSFT0648 (PV-GS59 Only)

1) AC Adaptor, DC Cable and AC Cable (pp. 15~16)

CAUTION:

This unit will operate on 110/120/220/240 V AC. An AC plug adaptor may be required for voltages other than 120 V AC. Please contact either a local or foreign electrical parts distributor for assistance in selecting an alternate AC plug.

We recommend using the accessory power plug adaptor (VJSS0070/KZDB4ZE00001) in an area which has special AC outlets.

- 2) Battery Pack (pp. 15~16)
- 3) AV Cable (pp. 51, 54)
- 4) Shoulder Strap (p. 18)
- 5) USB Cable and CD-ROM
(pp. 56, 58~59, 61, 67)

Parts Identification and Handling

■ Camcorder

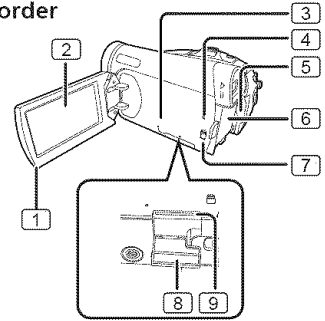

- 1) LCD Monitor Open Knob [OPEN] (p. 22)
- 2) LCD Monitor (pp. 20~22, 75)

Due to limitations in LCD production technology, there may be some tiny bright or dark spots on the LCD Monitor screen. However, this is not a malfunction and does not affect the recorded picture.

- 3) Card Access Lamp (p. 20)
- 4) Reset Button [RESET] (pp. 76, 78)
- 5) DC Input Jack [DC IN] (p. 15)
- 6) Battery Holder (p. 16)
- 7) Mode Selector Switch [AUTO/MANUAL/FOCUS] (pp. 30, 40~44)
- 8) Card Slot Cover (pp. 19~20)
- 9) Card Slot (pp. 19~20)

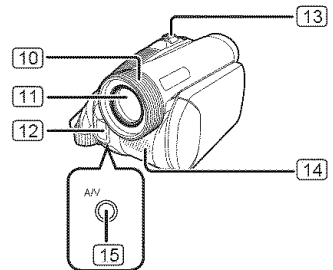

- 10) Lens Hood (p. 75)
- 11) Lens
- 12) White Balance Sensor (p. 42)
Remote Control Sensor (PV-GS59 Only)
(p. 15)
- 13) Zoom Lever [W/T] (pp. 35, 36)
Volume Lever [- / VOL +] (pp. 45, 47)
- 14) Microphone (built-in, stereo) (pp. 35, 39)

- 15 Audio-Video Output Jack [AV OUT]** (pp. 51, 54)
 - Connecting an AV Cable to this jack activates the Camcorder's built-in speaker.
 - When connecting the pin plug of the AV Cable to this jack, plug it in as far as it goes.

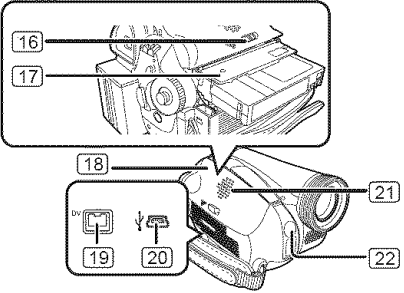

- 16 Cassette Eject Lever [OPEN/EJECT]** (p. 18)
- 17 Cassette Holder** (pp. 18~19)
- 18 Cassette Compartment Cover** (pp. 18~19)
- 19 DV Input/Output Terminal** (pp. 54~55, 67~68)
 - Connect this to the digital video equipment.
- 20 USB Jack [↔]** (For PV-GS39/PV-GS59) (pp. 58~59, 61, 67)
- 21 Speaker** (p. 45)
- 22 Built-in LED Light** (pp. 33~34)

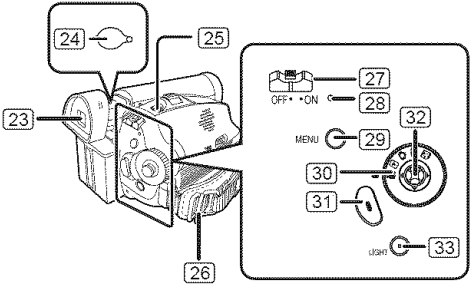

- 23 Viewfinder** (pp. 20~22, 75)

Due to limitations in LCD production technology, there may be some tiny bright or dark spots on the Viewfinder screen. However, this is not a malfunction and does not affect the recorded picture.

- 24 Eyepiece Corrector Knob** (p. 21)
- 25 Photoshot Button [PHOTO SHOT]** (pp. 31, 32)
- 26 Shoulder Strap Holders** (p. 18)
- 27 Power Switch [OFF/ON]** (p. 20)
- 28 Status Indicator [STATUS]** (pp. 20~21, 34)
- 29 Menu Button [MENU]** (p. 25)

- 30 Mode Dial** (p. 23)
- 31 Recording Start/Stop Button** (p. 30)
- 32 Joystick Control** (pp. 23, 25)
- 33 Light Button [LIGHT]** (pp. 33~34)

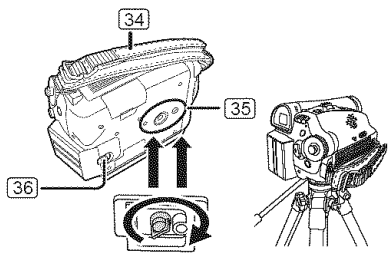

- 34 Grip Belt** (p. 17)
- 35 Tripod Receptacle**
 - This is a hole for attaching the Camcorder to optional tripod. (Please carefully read the Operating Instructions for how to attach the tripod to the Camcorder.)
 - You cannot open the Card Slot Cover when the tripod is used. Insert the card first and then attach the tripod.
- 36 Battery Eject Switch [BATTERY RELEASE]** (p. 16)

- **Remote Control (PV-GS59 Only : Optional)**
 Using the Remote Control with the Camcorder, most of the Camcorder functions can be operated from a distance.

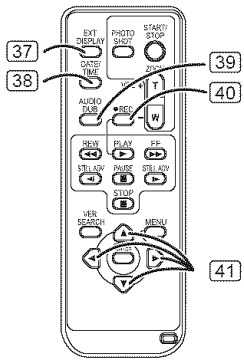

- 37 Indication Output Button [EXT DISPLAY]** (pp. 52, 54)
- 38 Date/Time Button [DATE/TIME]** (p. 28)
- 39 Audio Dubbing Button [AUDIO DUB]** (p. 53)
- 40 Recording Button [● REC]** (p. 55)
- 41 Cursor buttons for Variable Speed Search Function [▲, ▼] (p. 46) Select Button [▲▼◀▶] (p. 26)**

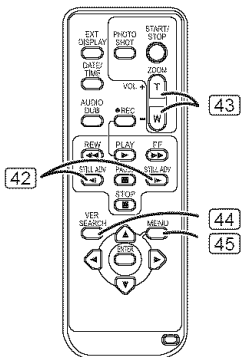

- 42 Slow Motion/Still Advance Buttons [◀I, I▶] (◀I: reverse, I▶: forward) (p. 46)
- 43 Zoom/Volume Button [ZOOM/VOL+]* (pp. 35~36, 45)
- 44 Variable Speed Search Button [VER SEARCH] (p. 46)
- 45 Menu Button [MENU]* (p. 26)

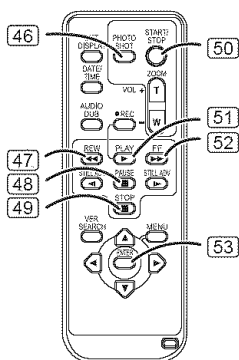

- 46 Photoshot Button [PHOTO SHOT]* (p. 32)
- 47 Rewind/Review Button [◀◀] (p. 46)
- 48 Pause Button [⏸] (pp. 47, 53, 55)
- 49 Stop Button [■] (pp. 15, 55)
- 50 Recording Start/Stop Button [START/STOP]* (p. 30)
- 51 Play Button [▶] (pp. 46~47, 55)
- 52 Fast Forward/Cue Button [▶▶] (p. 46)
- 53 Enter Button [ENTER] (p. 26)

* means that these buttons function in the same manner as the corresponding buttons on the Camcorder.

The Remote Control (PV-GS59 Only : Optional)

Inserting the Button-type Battery

Before using the Remote Control, insert a button-type battery (not supplied).

- 1 While pressing the Lock Button ①, pull out the Battery Holder.

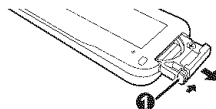

- 2 Insert a button-type battery (CR2025) with the (+) marking facing upward.

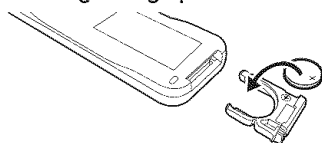

- 3 Insert the Battery Holder into the Remote Control.

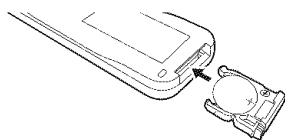

- When the button-type battery is exhausted, replace it with a new CR2025 battery. (A battery is normally expected to last about 1 year. However, it depends on operation frequency.)
- Make sure to match the poles correctly when inserting the button-type battery.

⚠ WARNING

- Use Battery with Panasonic type CR2025 only. Use of another battery may present a risk of fire or explosion.
- Battery may explode if mistreated.
- As with any small object, this type of Battery can be swallowed by young children. Do not allow children to handle this Battery.

⚠ CAUTION

- Dispose of used battery promptly.
- Do not recharge, disassemble or dispose of in fire.

Using the Remote Control (PV-GS59 Only : Optional)

- 1 Direct the Remote Control at the Remote Control Sensor of the Camcorder and press an appropriate button.

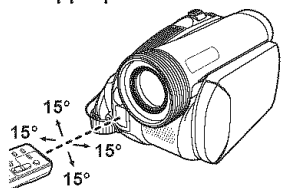

- Distance from the Camcorder: Within approximately 15 feet (5 meters)
 - Angle: Within approximately 15° in the vertical and horizontal directions from the central axis
- The above operating ranges are for indoor use. Outdoors or under strong light, the Camcorder may not operate properly even within the above ranges.

■ Selecting Remote Control Modes

When 2 Camcorders are used simultaneously, they can be operated individually by selecting different Remote Control Modes.

- If the Remote Control Mode of the Camcorder and that of the Remote Control do not match with each other, [REMOTE] will appear. When the Remote Control is operated for the first time after the Camcorder is turned on, [CHECK REMOTE MODE] (p. 71) will appear and operation is impossible. Set the same Remote Control Mode.

■ Setup on the Camcorder

Set [REMOTE] on the [SETUP] Sub-Menu to the desired Remote Control Mode. (pp. 27, 28)

■ Setup on the Remote Control

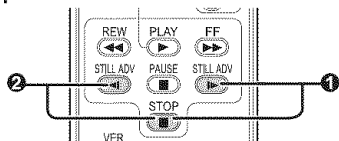

[VCR1]:

Press the [] Button and [] Button simultaneously. ①

[VCR2]:

Press the [] Button and [] Button simultaneously. ②

- When the battery in the Remote Control is replaced, the mode is automatically reset to [VCR1] Mode.

Power Supply

Using the AC Adaptor

- Before connecting or disconnecting the power supply, set the [OFF/ON] Switch on the Camcorder to [OFF] and make sure that [STATUS] Indicator is not lit. (p. 20)

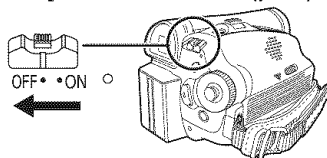

- 1 Connect the DC Cable to the Camcorder.
- 2 Connect the DC Cable to the AC Adaptor.
- 3 Connect the AC Cable to the AC Adaptor and the AC Jack.

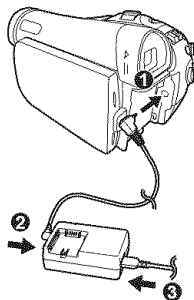

Using the Battery

Before use, fully charge the Battery.

- We recommend using a Panasonic Battery.
- We cannot guarantee the quality of this Camcorder when batteries from other companies are used.

- 1 Attach the Battery to the AC Adaptor and charge it.
- 2 Put the Battery on the Battery Mount by aligning the mark, and then securely plug it in.

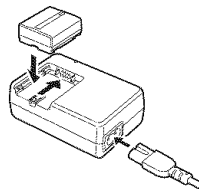

- Since the Battery will not be charged when the DC Cable is connected to the AC Adaptor, disconnect it from the AC Adaptor.
- The [CHARGE] Lamp lights up, and charging starts.
- When the [CHARGE] Lamp goes off, charging is completed.
- When the battery is completely discharged, the [CHARGE] Lamp blinks at first, but the battery is charged normally. When the temperature of the battery is too high or low, the [CHARGE] Lamp blinks and the charging time becomes longer than usual.

3 Attach the charged Battery to the Camcorder.

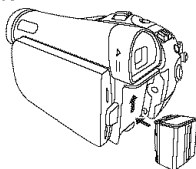

■ Disconnecting the Power Source

Set the [OFF/ON] Switch to [OFF], and while sliding the [BATTERY RELEASE] Switch, remove the Battery downward or DC Cable.

- When attaching or removing Battery, set the [OFF/ON] Switch to [OFF] and make sure the [STATUS] Indicator is not lit.

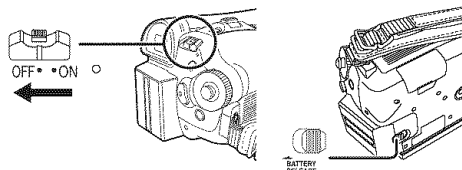

- Hold down the battery with your hand so it does not fall.

Notes:

- When the Camcorder has been used for a long time, the Camera body becomes warm, but this is not a malfunction.
- If the [CHARGE] Lamp does not light up although the Battery is attached to the AC Adaptor, detach the Battery and reattach it.

Charging Time and Available Recording Time







Supplied battery (PV-GS29) CGR-DU06 (7.2 V / 640 mAh)	Ⓐ	1 h 40 min.
	Ⓑ	1 h 50 min. (1 h 25 min.)
	Ⓒ	55 min. (45 min.)
Supplied battery (PV-GS39/PV-GS59 U.S.A.) CGR-DU06 (7.2 V / 640 mAh)	Ⓐ	1 h 40 min.
	Ⓑ	1 h 45 min. (1 h 20 min.)
	Ⓒ	55 min. (40 min.)
Supplied battery (PV-GS59 Canada Only) CGA-DU12 (7.2 V / 1 150 mAh)	Ⓐ	2 h 25 min.
	Ⓑ	3 h 10 min. (2 h 30 min.)
	Ⓒ	1 h 35 min. (1 h 15 min.)
Optional battery (PV-GS59 Canada Only) CGR-DU06 (7.2 V / 640 mAh)	Ⓐ	1 h 40 min.
	Ⓑ	1 h 45 min. (1 h 20 min.)
	Ⓒ	55 min. (40 min.)
Optional battery (PV-GS29) CGA-DU12 (7.2 V / 1 150 mAh)	Ⓐ	2 h 25 min.
	Ⓑ	3 h 15 min. (2 h 40 min.)
	Ⓒ	1 h 40 min. (1 h 20 min.)
Optional battery (PV-GS39/PV-GS59 U.S.A.) CGA-DU12 (7.2 V / 1 150 mAh)	Ⓐ	2 h 25 min.
	Ⓑ	3 h 10 min. (2 h 30 min.)
	Ⓒ	1 h 35 min. (1 h 15 min.)
Optional battery (PV-GS29) CGA-DU21 (7.2 V / 2 040 mAh)	Ⓐ	3 h 55 min.
	Ⓑ	5 h 45 min. (4 h 30 min.)
	Ⓒ	2 h 55 min. (2 h 15 min.)
Optional battery (PV-GS39/PV-GS59) CGA-DU21 (7.2 V / 2 040 mAh)	Ⓐ	3 h 55 min.
	Ⓑ	5 h 30 min. (4 h 15 min.)
	Ⓒ	2 h 45 min. (2 h 10 min.)

Ⓐ Charging Time

Ⓑ Maximum Continuous Recording Time

Ⓒ Intermittent Recordable Time

(The intermittent recordable time refers to recordable time when the recording and stopping operations are repeated.)

- "1 h 40 min." indicates 1 hour and 40 minutes.
- Battery CGR-DU06 (PV-GS29/PV-GS39/PV-GS59 U.S.A.) or CGA-DU12 (PV-GS59 Canada) is supplied.
- The times shown in the table are approximate times. The numbers indicate the recording time when the Viewfinder is used. The numbers in parentheses indicate the recording time when the LCD Monitor is used. In actual use, the available recording time may be shorter.
- The times shown in the table are for continuous recording at a temperature of 25 °C (77 °F) and humidity of 60 %. If the Battery is charged at a higher or lower temperature, the charging time may be longer.
- We recommend the Battery Pack CGA-DU12 and CGA-DU21 for long time recording (2 hours or more for continuous recording, 1 hour or more for intermittent recording.)
- The available recording time becomes shorter if you use both of Viewfinder and LCD Monitor simultaneously when rotating the LCD Monitor forward to record yourself.
- The batteries heat up after use or charging. The Camcorder being used will also heat up. This is normal.
- Along with the reduction of the battery capacity, the display will change:  →  →  →  → . If the battery discharges, then  will flash.

**How to remove the Sensor tag
(For U.S.A. customers)**

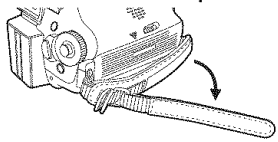
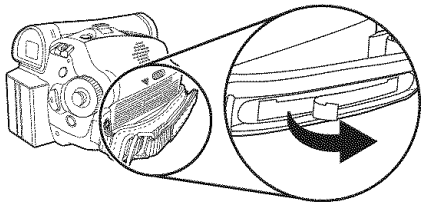
- 1 Detach the end of the Grip Belt.**

- 2 Remove the Sensor tag. Then, replace the Grip Belt.**

To Use as a Grip Belt

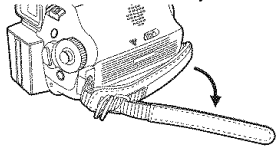
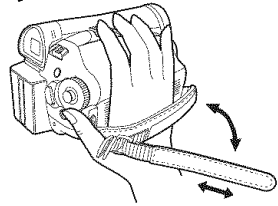
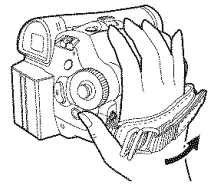
Adjust the length of the Grip Belt to the size of your hand.

- 1 Detach the end of the Grip Belt.**

- 2 Adjust the length of the Grip Belt to the size of your hand.**

- 3 Reattach the Grip Belt.**

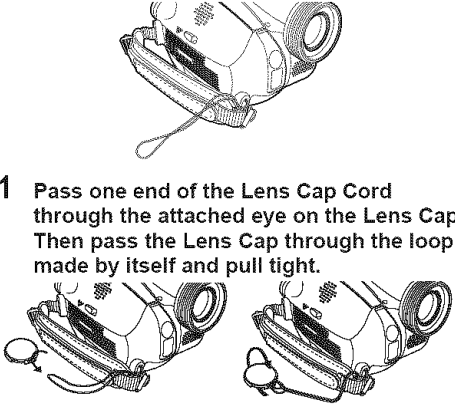
Re-attaching the Lens Cap

To protect the Lens surface, attach the Lens Cap.
• The Lens Cap and Lens Cap Cord come preattached to the Grip Belt.

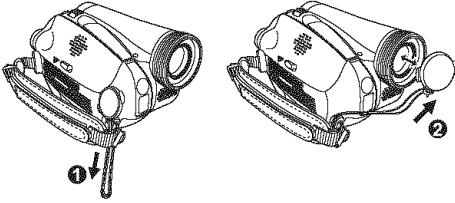
- 1 Pass one end of the Lens Cap Cord through the attached eye on the Lens Cap. Then pass the Lens Cap through the loop made by itself and pull tight.**

- When not using the Lens Cap, pull the Lens Cap Cord in the direction of the arrow. ❶
- When you are not recording, be sure to cover the Lens with the Lens Cap for protection. ❷



- When you remove the Lens Cap, press the knobs firmly.



Attaching the Shoulder Strap

We recommend that you attach the Shoulder Strap before going out to avoid dropping the Camcorder.

- 1 Pull the end of the Shoulder Strap through the Shoulder Strap Holder on the Camcorder.**

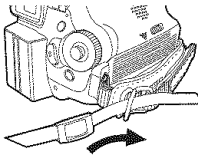

- 2 Fold the end of the Shoulder Strap, run it through the Shoulder Strap Length Adjuster, and pull it.**

- Pull it out more than 1 inch (2 cm) ❶ from the Shoulder Strap Length Adjuster so that it cannot slip off.

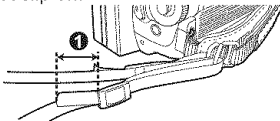

- Attach the other end of the Shoulder Strap to the other Shoulder Strap Holder in the same way.

Inserting/Removing a Cassette

- Please use Genuine Panasonic DVC Tapes for more information please contact your local dealer or visit www.panasonic.com.
- For your reference if you travel frequently you should also purchase a Panasonic head cleaning tape AY-DVMCLA and use when HEAD CLOG message appears on the LCD/EVF of your Camcorder.

- 1 Fit the AC Adaptor or the Battery and turn on the Power.**
- 2 Slide the [OPEN/EJECT] Lever toward the front and pull up to fully open the Cassette Compartment Cover.**
 - To protect the tape, if the cover is not fully opened, the cassette holder cannot be ejected.

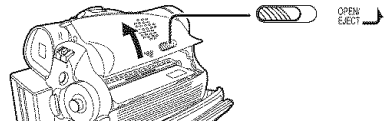

- 3 After the Cassette Holder is opened, insert/remove a Cassette.**

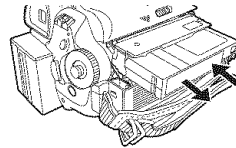

- When inserting a cassette, orient it as shown in the above, and then securely insert it as far as it goes.
- When removing, pull it straight out.

- 4 Close the Cassette Holder by pressing the [PUSH] mark ❶.**

- The Cassette Holder is housed.

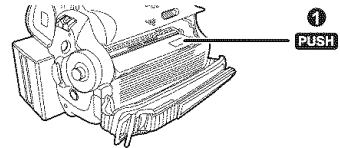

Caution :

Before closing the Cassette Holder ②, be sure your fingers have not been placed underneath the Cassette Holder as shown below. This may cause your fingers to jam in the cassette holder.

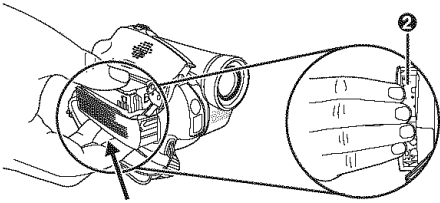

Do not place fingers here. [Bottom View]

- 5** Only after the Cassette Holder is completely housed, close the Cassette Compartment Cover by pressing the mark ③.

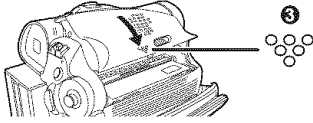

■ When the Cassette Holder does not come out

- Close the Cassette Compartment Cover completely, and then open it again completely.
- Check if the battery has run down.
- Check if the Cassette Compartment Cover is in contact with grip belt as shown below. If so, be sure the grip belt stays clear of the cover when opening.

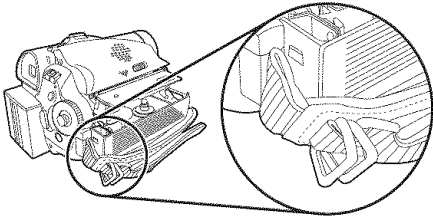

■ When the Cassette Holder cannot be housed

- Set the [OFF/ON] Switch to [OFF], then to [ON] again.
- Check if the battery has run down.

Notes:

- After use, be sure to rewind the cassette completely, remove it and put it in a case. Store the case in an upright position. (p. 74)
- If the indicator of the condensation does not display on the LCD screen and/or Viewfinder and you notice condensation on the lens or the main unit, do not open the cassette cover otherwise condensation may be formed on the heads or the cassette tape. (p. 73)
- When inserting a previously recorded Cassette, use the Blank Search Function (p. 31) to find the position where you want to continue recording. If you overwrite-record on a previously recorded cassette, be sure to find the position where you want to continue recording.
- If a new Cassette is inserted, rewind to the beginning of the tape before starting recording.
- When inserting the cassette, make sure it faces in the right direction and then push it in until it stops.
- When the Cassette Holder is in action, do not touch anything except the [PUSH] mark.
- Close the Cassette Compartment Cover tightly.
- When closing the Cassette Compartment Cover, do not get anything, such as a cable, caught in the cover.

Accidental Erasure Prevention

Opening the accidental erasure prevention slider ① on the cassette (by sliding it to the [SAVE] arrow direction) prevents recording. To enable recording, close the accidental erasure prevention slider (by sliding it to the [REC] arrow direction).

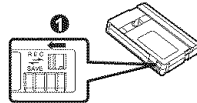

**Using a Memory Card (Optional)
(For PV-GS39/PV-GS59)**

A Card can be used to record still pictures.
• Use a genuine SD Memory Card manufactured by Panasonic only.

Before inserting or removing a Card, be sure to turn off the Camcorder.

- Otherwise, the Camcorder may not function properly or it may cause the loss of recorded data in a Card.

Inserting/Removing a Card

- 1** Turn off the Power.
- 2** Open the LCD Monitor and then open the Card Slot Cover.

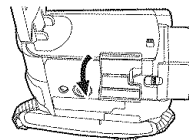

- 3** While holding the Memory Card with its cut corner facing right ❶, insert/remove it into/from the Card Slot.

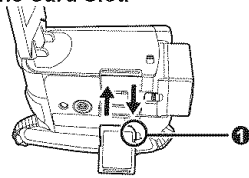

- 4** Close the Card Slot Cover securely.

■ **Removing the Card**

Open the Card Slot Cover and press the center of the Card and then pull it straight out.

- After removing the Card, close the Card Slot Cover.
- The Camcorder may be damaged if the Card is forced out when the Card is fully inserted.

■ **Concerning the Write Protection Switch on the SD Memory Card**

The SD Memory Card has a write protection switch on it. If the switch is moved to [LOCK], you cannot write to the card, erase the data on it, or format it. If it is moved back, you can.

■ **Concerning the Card**

- Do not touch the terminals on the back of the card.
- Do not format the card with another Camcorder or any personal computer. This operation may make the card unusable.
- Electrical noise, static electricity, or failure of the Camcorder or the card may damage or erase the data stored on the card. We recommend saving important data on a personal computer by using a USB Cable, PC Card Adaptor, and USB Reader/Writer.

■ **SD Memory Card**

- The memory capacity indicated on the SD Memory Card label corresponds to the total amount of capacity to protect and manage the copyright and the capacity available as conventional memory for a Camcorder, personal computer or other equipment.

Card Access Lamp

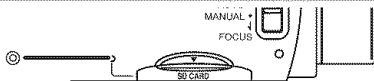

While the Camcorder is accessing the Card (reading, recording, playback or erasing), the Card Access Lamp lights up.

- While the Card Access Lamp is on, **never** attempt to open the Card Slot Cover, to pull out the Card, to turn off the Camcorder, or to turn the Mode Dial. Such actions will damage the Card, and recorded data, and cause the Camcorder to malfunction.

Turning on the Camcorder

Turn on the power first and then select modes.

■ **How to Turn on the Power**

- 1** Set the [OFF/ON] Switch to [ON] while pressing the button ❶.

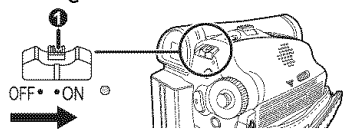

- 2** Open the LCD Monitor or extend the Viewfinder to use.

- The [STATUS] Indicator lights Red and turn on the power.
- The LCD Monitor or Viewfinder will be activated.

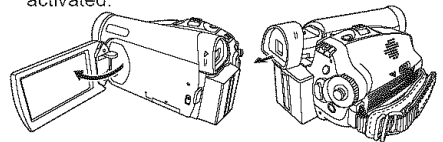

■ **How to Turn off the Power**

- 1** Set the [OFF/ON] Switch to [OFF] while pressing the button ❶.

- The [STATUS] indicator goes off when the power turns off.
- In Tape Recording Mode or Card Recording Mode, if the [OFF/ON] Switch is set to [ON] while the LCD Monitor and Viewfinder are closed, the power turns off.

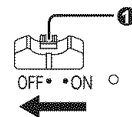

How to turn the power on and off with the LCD Monitor/Viewfinder

When the [OFF/ON] Switch is set to [ON], the power can be turned on and off with the LCD Monitor and the Viewfinder when the unit is in Tape Recording Mode or Card Recording Mode.

- 1** Open the LCD Monitor or extend the Viewfinder to use.

- The LCD Monitor or the Viewfinder will be activated.

- 2** Close the LCD Monitor and retract the Viewfinder.

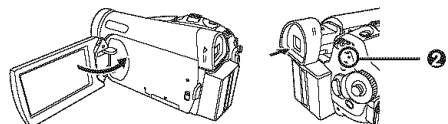

- The power will not turn off if the LCD Monitor is closed and the Viewfinder is retracted.
- The [STATUS] Indicator  automatically goes off and the power turns off. (If Quick Start is set to [ON] (p. 34), the unit goes into Quick Start standby mode and the [STATUS] Indicator lights Green.)
- Even if the LCD Monitor is closed or the Viewfinder is retracted while recording on a tape, the power does not turn off. (The Viewfinder stays lit up.)

3 Open the LCD Monitor or extend the Viewfinder again.

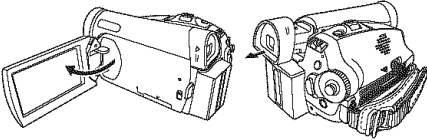

- The [STATUS] Indicator lights Red and turn on the power.

Setting Date and Time

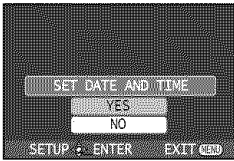

When the Camcorder is turned on for the first time, [SET DATE AND TIME] will appear. Select [YES] and set the date and time.

- If the screen shows the incorrect Date/Time, then adjust it.



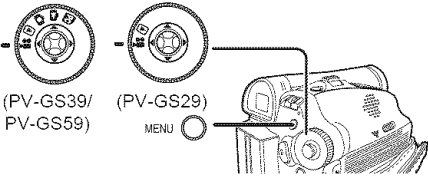



• Set to Tape/Card Recording Mode.



1 Set [ BASIC] >> [ CLOCK SET] >> [YES].



2 Move the Joystick Control [] or [] to select the item to be set. Then move the Joystick Control [] or [] to set the desired value.

- Year will cycle in the order shown below.
2000, 2001, ..., 2089, 2000, ...

3 Press the Joystick Control to finish setting the date and time.

- The clock operation starts from [00] second.
- If the built-in battery is weak, the [] Indication flashes. In this case, charge the built-in battery.
- The clock uses the 12-hour system.

■ About Date/Time

- The Date and Time function are driven by a built-in lithium battery.
- Make sure to check the time before recording because the built-in clock is not very accurate.

■ Recharging the built-in lithium battery

If [] or [-] is appears when the Camcorder is turned on, then the built-in lithium battery has run down. Use the steps below to charge the battery. When the battery is inserted for the first time after charging, [SET DATE AND TIME] will appear. Select [YES] and set the date and time. Connect the AC adaptor to the Camcorder or place the battery on the Camcorder, and the built-in lithium battery will be recharged. Leave the camera as is for approx. 24 hours, and the battery will drive the date and time for approx. 6 months. (Even if the [OFF/ON] Switch is set to [OFF], the battery is still being recharged.)

Using the Viewfinder/LCD Monitor

Using the Viewfinder

Before using the Viewfinder, adjust the field of view so that the displays inside the Viewfinder become clear and easy to read.

1 Pull the Viewfinder.

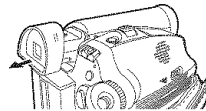

- The Viewfinder will be activated.

2 Adjust by turning the Eyepiece Corrector Knob.

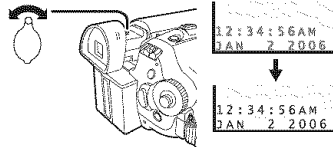

- You can adjust the brightness of the Viewfinder from the Menu.

Using the LCD Monitor

With the LCD Monitor open, you can also record the picture while watching it.

1 Place your Thumb on the [OPEN] Knob and pull the LCD Monitor out in the direction of the arrow.

- The LCD Monitor will be activated.
- It can open up to 90°.

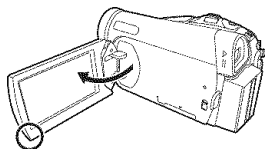

2 Adjust the LCD Monitor angle according to the desired recording angle.

- The LCD Monitor can rotate a maximum of 180° ① from the vertical position upwards and a maximum of 90° ② to the downward direction. Forcefully rotating the LCD Monitor beyond these ranges will damage the Camcorder.

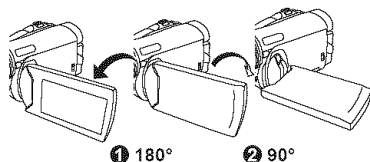

- The brightness and color level of the LCD Monitor can be adjusted from the Menu.
- If it is forcibly opened or rotated, the Camcorder may be damaged or fail.
- Check that the Card Slot Cover is closed before closing the LCD Monitor.
- If the LCD Monitor is rotated by 180° towards the lens and the Viewfinder is opened (when recording yourself), the LCD Monitor and the Viewfinder simultaneously light.

■ Closing the LCD Monitor

Push the LCD Monitor until it is securely locked.

- Make sure the Card Slot Cover is closed.

Adjusting Brightness and Color Level

When [LCD SET] or [EVF SET] on the [MENU] SETUP Sub-Menu is set to [YES], the following items are displayed.

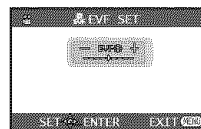
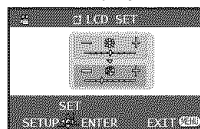

[LCD SET] LCD Brightness [*]

Adjusts the brightness of the image on the LCD screen.

[LCD SET] LCD Color Level [*]

Adjusts the color saturation of the image on the LCD screen and the Viewfinder.

[EVF SET] Brightness of the Viewfinder [EVF*]

Adjusts the brightness of the image in the Viewfinder.

■ To Adjust

Move the Joystick Control [▲] or [▼] and select the item to be adjusted, and then move the Joystick Control [◀] or [▶] to raise or lower the number of vertical bars in the Bar Indication.

- More vertical bars indicates stronger brightness or color saturation.
- Press the [MENU] Button or the Joystick Control to complete the settings.

Notes:

- In order to adjust the brightness of the Viewfinder, close the LCD Monitor, and the Viewfinder will be activated.
- When the LCD Monitor is rotated by 180° towards the lens, the brightness of the LCD Monitor cannot be adjusted.
- These settings will not affect the images actually recorded.

Easy to Use Mode Dial

You can choose a desired mode by rotating the Mode Dial.

1 Rotate the Mode Dial.

- Set your desired mode to ①.

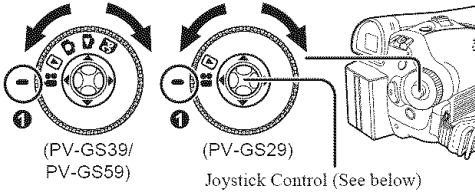

Tape Recording Mode

Use this mode when recording pictures on a tape.

Tape Playback Mode

Use this mode when playing back the recorded scene on a tape.

Card Recording Mode (For PV-GS39/PV-GS59)

Use this mode when recording still pictures on a card.

Picture Playback Mode (For PV-GS39/PV-GS59)

Use this mode when playing back the recorded still picture on a card.

PC Mode (For PV-GS39/PV-GS59)

Use this mode when you want to connect the Camcorder to your Personal Computer. You can view or edit the images recorded on a card on your personal computer.

How to Use the Joystick Control

Basic Joystick Control Operations

Operations on the menu screen and selection of files to be played back on the multi-image display.

Move the Joystick Control [**▲**, **▼**, **◀**, or **▶**] to select an item or file, and then press in the center to set it.

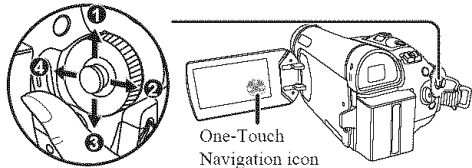

- | | |
|---|-------------------------------------|
| ① | Select by moving [▲]. |
| ② | Select by moving [▶]. |
| ③ | Select by moving [▼]. |
| ④ | Select by moving [◀]. |
| ⑤ | Push the center to select the item. |

Joystick Control and Screen Display

Press the center of the Joystick Control, and the One-Touch Navigation icon will be displayed on the lower right of the screen.

- Press the Joystick Control again to turn off the One-Touch Navigation icon.
- Pressing the center button of the Joystick Control again to redisplay the One-Touch Navigation icon will display the last page used.

Each press of [**▼**] switches the display as follows depending on the mode.

- ➡ Press Center e.g., Tape Recording Mode [AUTO]
- ➡ Press **▼**

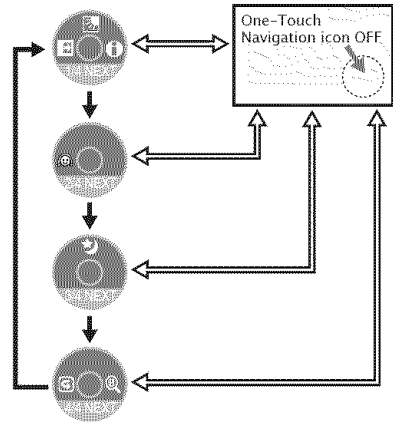

Move the Joystick Control [**▲**, **▼**, **◀**, or **▶**] to select an item.

- In the Tape Playback Mode or the Picture Playback Mode, the One-Touch Navigation icon will be automatically on the lower right of the screen.

■ Tape Recording Mode

- When the [AUTO/MANUAL/FOCUS] Switch is set to [AUTO].

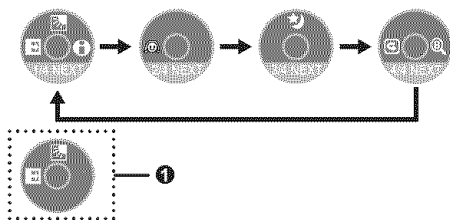

1/4	◀	[INFO]	Fade	p. 37
	▶	[INFO]	Help Mode*	p. 25
	▲	[INFO]	Backlight compensation	p. 37
2/4	▼		Go to next page.	–
	◀	[INFO]	Soft Skin Mode	p. 38
3/4	▼		Go to next page.	–
	▲	[INFO]	MagicPix Mode	p. 38
4/4	▼		Go to next page.	–
	◀	[INFO]	Recording Check	p. 31
	▶	[INFO]	Blank Search Mode	p. 31
	▼		Go to next page.	–

- [INFO] is displayed while recording on a tape.

■ Tape Recording Mode

- When the [AUTO/MANUAL/FOCUS] Switch is set to [MANUAL].

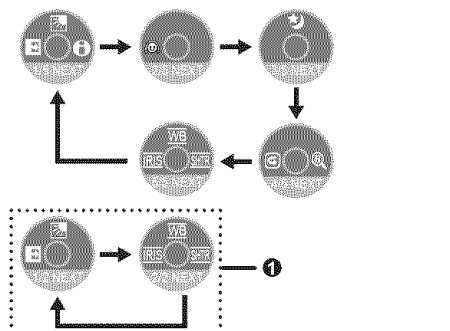

5/5	◀	[IRIS]	Manual Iris Adjustment Mode	p. 43
	▶	[SHTR]	Manual Shutter Speed Adjustment Mode	pp. 42~43
	▲	[WB]	Manual White Balance Adjustment Mode	pp. 41~42
	▼		Go to next page.	–

- [INFO] is displayed while recording on a tape.

■ Tape Recording Mode

- When the [AUTO/MANUAL/FOCUS] Switch is set to [FOCUS].

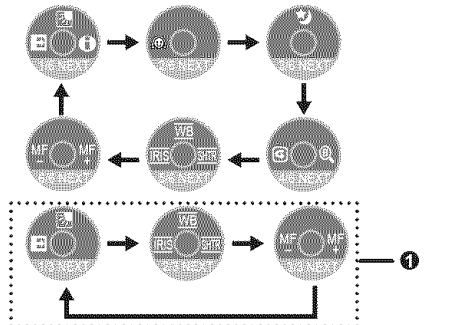

6/6	◀	MF -	Manual Focus Adjustment Mode	p. 44
	▶	MF +	Manual Focus Adjustment Mode	p. 44
	▼		Go to next page.	–

- [INFO] is displayed while recording on a tape.

■ Card Recording Mode

(For PV-GS39/PV-GS59)

- When the [AUTO/MANUAL/FOCUS] Switch is set to [AUTO].

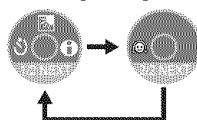

1/2	◀	[INFO]	Self-timer Mode	p. 35
	▶	[INFO]	Help Mode*	p. 25
	▲	[INFO]	Backlight compensation	p. 37
2/2	▼		Go to next page.	–
	◀	[INFO]	Soft Skin Mode	p. 38
	▼		Go to next page.	–

■ Card Recording Mode

(For PV-GS39/PV-GS59)

- When the [AUTO/MANUAL/FOCUS] Switch is set to [MANUAL].

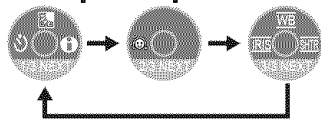

3/3	◀	[IRIS]	Manual Iris Adjustment Mode	p. 43
	▶	[SHTR]	Manual Shutter Speed Adjustment Mode	pp. 42~43
	▲	[WB]	Manual White Balance Adjustment Mode	pp. 41~42
	▼		Go to next page.	–

■ Card Recording Mode (For PV-GS39/PV-GS59)

- When the [AUTO/MANUAL/FOCUS] Switch is set to [FOCUS].

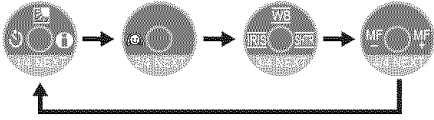

4/4	◀	MF -	Manual Focus Adjustment Mode	p. 44
	▶	MF +	Manual Focus Adjustment Mode	p. 44
	▼		Go to next page.	-

■ Tape Playback Mode



-	▲	⏮	Playback / Pause	p. 45
	▶	⏭	Fast (Cue Playback)	p. 46
	◀	⏪	Rewind (Review Playback)	p. 46
	▼	■	Stop	p. 45

■ Picture Playback Mode (For PV-GS39/PV-GS59)



-	▲	⏮	Start the Slide Show Stop the Slide Show	pp. 47~48
	▶	▶	Playback the next picture	p. 47
	◀	◀	Playback the previous picture	p. 47
	▼	🗑	Erase the picture	p. 49

*Help Mode

• Set to Tape/Card Recording Mode.

You can view function help information using One-Touch Navigation.

1 Press the Joystick Control to display the One-Touch Navigation icon on the lower right of the screen.

2 Move the Joystick Control [▼] until the page with [📄] indication is displayed.
[One-Touch Navigation icon]

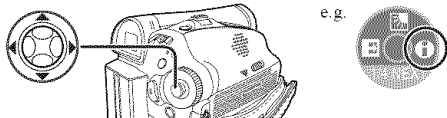

3 Move the Joystick Control [▶] to select [📄].



4 Move the Joystick Control [▲▼◀▶] to select the desired function.



- An explanation of the selected icon is displayed on the screen.
- Each time the Joystick Control is moved down, the indication changes.

■ To end the Help Mode

Move the Joystick Control [▶] to select [EXIT] or press the [MENU] Button.

Notes:

- When the Help Mode is used, functions cannot be set.
- The Help Mode only displays the information available in [AUTO] Mode.

Using the Menu Screen

To facilitate the selection of a desired function or setup, this Camcorder displays various function setups on Menus.

1 Press the [MENU] Button.

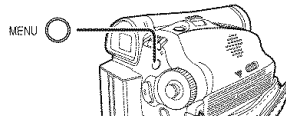

- The Menu corresponding to the Mode selected by the Mode Dial is displayed.
- Do not switch the Mode Dial when the Menu is displayed.

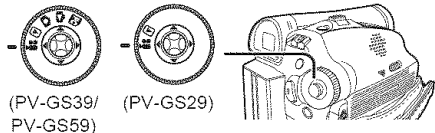

2 Move the Joystick Control [▲] or [▼] to select the top menu.

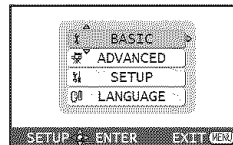

- 3 Move the Joystick Control [▶] or press it to set the selection.
- 4 Move the Joystick Control [▲] or [▼] to select the Sub-Menu.

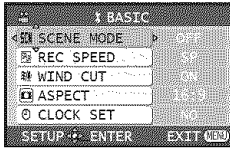

- 5 Move the Joystick Control [▶] or press it to set the selection.
- 6 Move the Joystick Control [▲] or [▼] to select the item to be set.

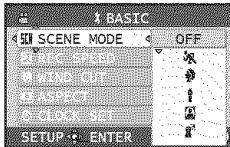

- 7 Press the Joystick Control to determine the setting.

- While a Menu is displayed, you cannot record or play back. Menus can be displayed during playback but not during recording.

- **To Return to the Previous Screen**
Move the Joystick Control [◀].

- **To Exit the Menu Screen**
Press the [MENU] Button again.

- **About the Menu Mode Setting**
The setting selected on the Menu will be retained even when the Camcorder is turned off. However, if the Battery or AC Adaptor is disconnected before turning off the Camcorder, the selected setup may not be retained.

- Menu operation flow is shown in this text by >>.

Operating with Remote Control (PV-GS59 Only : Optional)

The menu screen transition is the same as when the buttons on the main unit are used.

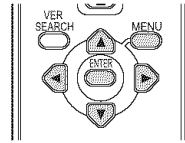

- 1 Press the [MENU] Button.
- 2 Select a menu item.
 - Use the Select Button (▲▼◀▶) and [ENTER] Button in place of the Joystick Control on the main unit.
- 3 Press the [MENU] Button to exit the menu screen.

Selecting Language

You can select the desired language.

- 1 Set [LANGUAGE] >> [English], [Français] or [Español].



List of Menus

The figures of the Menus are for explanation purposes only, and they are different from the actual Menus.

■ [TAPES RECORDING MENU]

e.g.

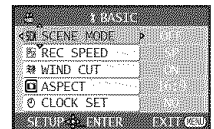
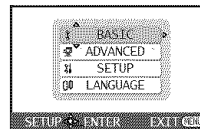

[BASIC]

Basic Setup Sub-Menu

[SCENE MODE]

Scene Mode (p. 40)

[REC SPEED]

Recording Speed Mode (p. 29)

[WIND CUT]

Wind Noise Reduction (p. 39)

[ASPECT] (For PV-GS39/PV-GS59)

Wide Screen Mode (p. 39)

[CINEMA] (For PV-GS29)

Cinema-like Format Recording (p. 39)

[CLOCK SET]

Date and Time Setting (p. 21)

[ADVANCED]

Advance Setup Sub-Menu

[PICT.QUALITY] (For PV-GS39/PV-GS59)

Picture Quality (p. 32)

[EIS]

Image Stabilizer (p. 36)

[FADE COLOR]

Fade color (p. 37)

[AUDIO REC]

Audio Recording Mode (p. 28)

[USB FUNCTION] (PV-GS59 Only)

USB Functions Mode (pp. 61, 67)

[D.ZOOM]

Digital Zoom (p. 36)

[ZOOM MIC]

Zoom Microphone (p. 35)

[SHTR EFFECT] (PV-GS29 Only)

Shutter effect (p. 31)

[SETUP]

Setup Sub-Menu

[DISPLAY]

Display Mode (p. 28)

[DATE/TIME]

Date and Time Indication (pp. 28, 70)

[POWER SAVE]

Power Save Mode (p. 29)

[QUICK START]

Quick Start Mode (p. 34)

[REMOTE] (PV-GS59 Only)

Remote Control Mode (p. 15)

[BEEP SOUND]

Beep Sound (p. 28)

[LCD SET]

LCD Adjustment (p. 22)

[EVF SET]

Viewfinder Adjustment (p. 22)

[INITIAL SET]

Initial Setting Mode (p. 29)

[DEMO MODE]

Demonstration Mode (p. 29)

[LANGUAGE]

Language Setup Sub-menu (p. 26)

[TAPE PLAYBACK MENU]

e.g.,

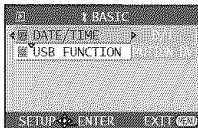
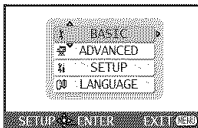
**[BASIC]**

Basic Setup Sub-Menu

[DATE/TIME]

Date and Time Indication (pp. 28, 70)

[USB FUNCTION] (PV-GS59 Only)

USB Functions Mode (pp. 61, 67)

[ADVANCED]

Advance Setup Sub-Menu

[REC SPEED]

Recording Speed Mode (p. 29)

[REC STDBY]

Recording Standby Mode (p. 54)

[PICT.QUALITY] (For PV-GS39/PV-GS59)

Picture Quality (p. 32)

[REPEAT PLAY]

Repeat Play Mode (p. 45)

[SETUP]

Setup Sub-Menu

[12bit AUDIO]

Audio Selector (p. 45)

[AUDIO OUT]

Audio Output Mode (p. 29)

[DISPLAY]

Display Mode (p. 28)

[REMOTE] (PV-GS59 Only)

Remote Control Mode (p. 15)

[LCD SET]

LCD Adjustment (p. 22)

[EVF SET]

Viewfinder Adjustment (p. 22)

[POWER SAVE]

Power Save Mode (p. 29)

[TV ASPECT] (For PV-GS39/PV-GS59)

TV Aspect Mode (p. 51)

[LANGUAGE]

Language Setup Sub-menu (p. 26)

**[CARD RECORDING MENU]
(For PV-GS39/PV-GS59)**

e.g.,

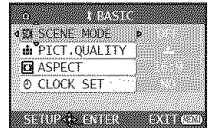
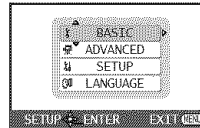
**[BASIC]**

Basic Setup Sub-Menu

[SCENE MODE]

Scene Mode (p. 40)

[PICT.QUALITY]

Picture Quality (p. 32)

[ASPECT]

Wide Screen Mode (p. 39)

[CLOCK SET]

Date and Time Setting (p. 21)

[ADVANCED]

Advance Setup Sub-Menu

[BURST MODE]

RapidFire Consecutive Photoshot (p. 33)

[SHTR EFFECT]

Shutter Effect (p. 32)

[SETUP]

Setup Sub-Menu

[DISPLAY]

Display Mode (p. 28)

[DATE/TIME]

Date and Time Indication (pp. 28, 70)

[POWER SAVE]

Power Save Mode (p. 29)

[QUICK START]

Quick Start Mode (p. 34)

[REMOTE] (PV-GS59 Only)

Remote Control Mode (p. 15)

[BEEP SOUND]

Beep Sound (p. 28)

[LCD SET]

LCD Adjustment (p. 22)

[EVF SET]

Viewfinder Adjustment (p. 22)

[INITIAL SET]

Initial Setting Mode (p. 29)

[LANGUAGE]

Language Setup Sub-menu (p. 26)

■ [PICTURE PLAYBACK MENU] (For PV-GS39/PV-GS59)

e.g.,

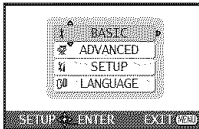

[BASIC]

Basic Setup Sub-Menu

[DATE/TIME]

Date and Time Indication (pp. 28, 70)

[PROTECT]

Setting the Lock (p. 50)

[ADVANCED]

Advance Setup Sub-Menu

[DPOF SET]

Setting DPOF (p. 50)

[FORMAT CARD]

Formatting a Card (p. 51)

[SETUP]

Setup Sub-Menu

[DISPLAY]

Display Mode (p. 28)

[REMOTE] (PV-GS59 Only)

Remote Control Mode (p. 15)

[LCD SET]

LCD Adjustment (p. 22)

[EVF SET]

Viewfinder Adjustment (p. 22)

[POWER SAVE]

Power Save Mode (p. 29)

[TV ASPECT]



TV Aspect Mode (p. 51)

[LANGUAGE]

Language Setup Sub-menu (p. 26)



Menus Related to Taking Pictures

■ DATE/TIME

This switches between date and time indications. Set [ BASIC] or [ SETUP] >> [ DATE/TIME] >> [D/T], [DATE] or [OFF].

- The Camcorder automatically records the date and time of picture taking on the tape.
- You can also show or change the Date/Time Indication by repeatedly pressing the [DATE/TIME] Button on the Remote Control (PV-GS59 Only).

■ DISPLAY



Set [ SETUP] >> [ DISPLAY] >> [ON] or [OFF].

Set to [ON] and the display mode can be switched to all functions. Set to [OFF] and it can be switched to minimum display.

■ AUDIO REC

• Set to Tape Recording Mode.

You can select the sound quality of the recorded sound.

Set [ ADVANCED] >> [ AUDIO REC] >>



[12bit] or [16bit].

[12bit]: Records audio in "12 bit 32 kHz 4 tracks". (The original audio signals can be kept after the other audio signals are dubbed.)

[16bit]: Records audio in "16 bit 48 kHz 2 tracks". Audio can be recorded in higher quality. (If audio signals are dubbed, then the original audio signals will be erased.)

■ BEEP SOUND

• Set to Tape/Card Recording Mode.

When [ BEEP SOUND] on the [ SETUP] is set to [ON], confirmation/alarm beeps are issued as follows.

- 1 Beep
 - When you start recording
 - When you turn on the power
 - When the unit goes from Quick Start standby mode to recording pause

2 Beeps

- When you pause recording
- When you turn off the power
- When the unit goes into Quick Start standby mode

2 Beeps 4 times

- When a cassette with its erasure prevention tab set to [SAVE] is inserted, condensation occurs (p. 73), and at other times. Check the sentence displayed on the screen (p. 71).

■ POWER SAVE

Set [SETUP] >> [POWER SAVE] >> [5 MINUTES] or [OFF].

[OFF]:

When about 5 minutes passed without any operation, the standby mode automatically will be set. In the standby mode, [] blinks and it takes time more than usual to start recording after you press the Recording Start/Stop Button.

[5 MINUTES]:

When about 5 minutes passed without any operation, the Camcorder automatically turns off to protect the tape or to prevent the battery from running down. When you use the Camcorder, turn it on again.

- In the following cases, the power may not turn off even when set [POWER SAVE] >> [5 MINUTES].
 - When connecting to the AC Jack (When using the AC Adaptor)
 - When connecting the USB Cable or the DV Cable to a PC or other equipment
 - When the PC Mode (For PV-GS39/PV-GS59)

Menus Related to Playback

■ AUDIO OUT

This switches the sound to be played back.

Set [SETUP] >> [AUDIO OUT] >>

[STEREO], [L] or [R].

[STEREO]: Stereo sound (main sound and sub sound)

[L]: Left channel sound (main sound)

[R]: Right channel sound (sub sound)

Other Menus

■ INITIAL SET

- **Set to Tape/Card Recording Mode.**

Set [SETUP] >> [INITIAL SET] >> [YES] or [NO].

Set to [YES] to change menu settings back to their factory default condition.

- The initializing takes a little while.
- Language setting cannot be back to the initial shipping condition.

■ DEMO MODE

- **Set to Tape Recording Mode.**

If you set [SETUP] >> [DEMO MODE]

>> [ON] without inserting a cassette or a card, the Camcorder is automatically set to the demonstration mode for introducing its functions. If any button is pressed or operated, the demonstration mode is canceled. If no operations take place for approx. 10 minutes, the demonstration mode automatically starts.

To terminate the demonstration mode, insert a cassette or a card, or set to [DEMO MODE] >> [OFF]. For normal use, set this function to [OFF].

LP Mode

You can switch the tape recording speed.

- **Set to Tape Recording/Playback Mode.**



1 Set [BASIC] or [ADVANCED] >> [REC SPEED] >> [LP].

If the LP mode is selected, the recording time will be 1.5 times the SP mode, but some functions will be disabled.

- We recommend using the SP mode for important recordings.
- In order to fully exhibit the performances of the LP mode, we recommend using Panasonic cassettes marked LP mode.
- Audio dubbing is not possible with LP Mode. (p. 53)
- In the LP mode, the picture quality will not be degraded in comparison with the SP mode, but mosaic noise may appear on the playback image or some functions may be disabled.
 - Playback on other digital video equipment or on digital video equipment without the LP mode.
 - Playback of the image on other digital video equipment recorded in the LP mode.
 - Slow Motion/Still Advance playback.

Recording Mode

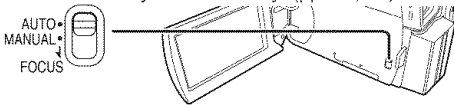

About Recording

- When recording pictures on a tape, set the Mode Dial to Tape Recording Mode [].
- When recording still pictures on a card, set the Mode Dial to Card Recording Mode [] (For PV-GS39/PV-GS59).
- When recording with the [AUTO/MANUAL/FOCUS] Switch set to [AUTO], the Camcorder automatically adjusts the Focus and White Balance. In some cases, they cannot be adjusted automatically and need to be adjusted manually. (pp. 41, 44)



- Before turning on the power, remove the Lens Cap. If the Lens Cap is still attached when the power is turned on, Automatic White Balance Adjustment (p. 41) may not function correctly.

Recording on a Tape

- Open the LCD Monitor or extend the Viewfinder before turning on the power.
- When this unit is purchased, the aspect ratio is set to [16:9] for recording images compatible with a wide-screen TV. To make this unit compatible with regular TVs (4:3), change the [ ASPECT] setting before recording the images (p. 39) or change the [ TV ASPECT] setting when watching them on the connected TV (p. 51).

1 Set the [OFF/ON] Switch to [ON].

- The [STATUS] Indicator lights Red.

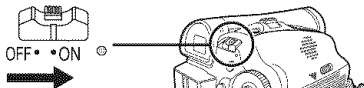

2 Set the Mode Dial to Tape Recording Mode.

- The [ TAPE RECORDING MODE] is displayed on the screen.

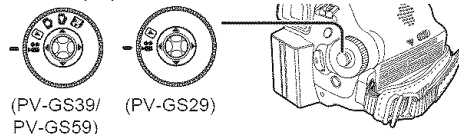

3 Press the Recording Start/Stop Button.

- Recording starts.
- The [RECORD] and [] Indication appears.

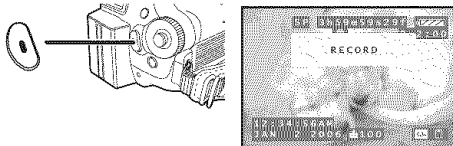

4 Press the Recording Start/Stop Button again to pause the recording.

- The [PAUSE] and [] Indication appears.

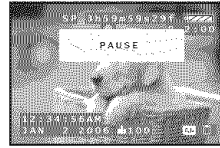

- For the recording time on a tape, refer to page 16.
- Carry out a recording check (p. 31) to verify that the image is recorded properly.
- In order to find the unrecorded section, carry out the blank search (p. 31).

■ On-screen Display in the Tape Recording Mode

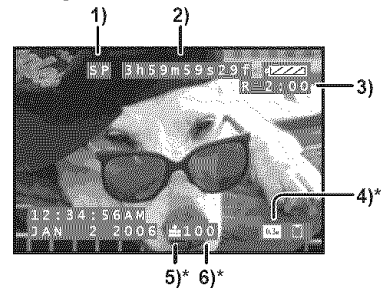

- * These indications are displayed only when the card is inserted. (For PV-GS39/PV-GS59)

- 1) Recording mode
- 2) Recording time elapse
- 3) Remaining tape indication
- 4) Still picture size
- 5) Quality of still pictures
- 6) Number of recordable still pictures (When no picture can be recorded, this indication will flash in red.)

■ Concerning the remaining tape time indication on the screen

- The remaining tape time is indicated in minutes. (When it reaches less than 3 minutes, the indication starts flashing.)
- During a 15-second or shorter recording, the remaining tape time indication may not be displayed or the remaining tape time may not be displayed correctly.
- In some cases, the remaining tape time indication may display remaining tape time that is 2 to 3 minutes shorter than the actual remaining tape time.

To Check the Recording

You can play back the last few seconds of the recorded scene in the Recording Pause Mode.

- Set to Tape Recording Mode.

- 1 Press the Joystick Control to display the One-Touch Navigation icon on the lower right of the screen.
- 2 Move the Joystick Control [▼] until the page with [Ⓞ] indication is displayed.

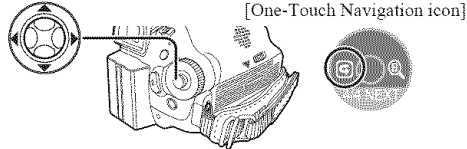

- 3 Move the Joystick Control [◀] to select [Ⓞ].
 - The [RECORDING CHECK STARTED] and the [Ⓞ] indication is displayed. After checking, the Camcorder resumes the Recording Pause Mode.

Finding the End of Recording (Blank Search Function)

The Blank Search Function aids you in locating the end of the recording on the Cassette quickly (unused part of the tape).

- Set to Tape Recording/Playback Mode.

- 1 Press the Joystick Control to display the One-Touch Navigation icon on the lower right of the screen.
- 2 Move the Joystick Control [▼] until the page with [Ⓞ] indication is displayed.

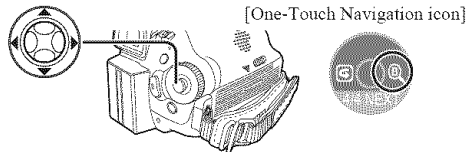

- 3 Move the Joystick Control [▶] to select [Ⓞ].
 - A confirmation message appears.
- 4 Move the Joystick Control [▲] or [▼] to select [YES] and press the Joystick Control.

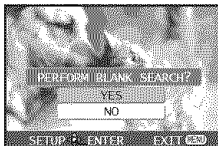

- The [Ⓞ] indication and the One-Touch Navigation icon appears during the Blank Search.

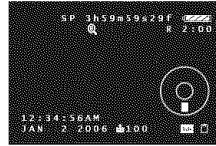

- Approximately 1 second before the last recorded scene, the Camcorder switches to the Recording Pause Mode or the Still Playback Mode.
- If there is no blank left on the Cassette, the Camcorder stops at the end of the tape.

To Cancel the Blank Search Function Before Completion

Move the Joystick Control [▼] to select [■].

Recording a Still Picture on a Tape (PV-GS29 Only)

Still pictures can be recorded on a tape.

- Set to Tape Recording Mode.

- 1 Press the [PHOTO SHOT] Button in the Recording Pause Mode.

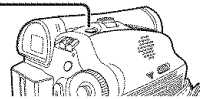

- The Camcorder records a still picture for about 7 seconds and then switches back to the recording pause mode.
- If you set [⚙ ADVANCED] >> [☁ SHTR EFFECT] >> [ON], you can add an image and a sound effect for releasing the shutter.
- Photoshot recording results in slightly inferior image quality.

Continuous photoshot

If you set [⚙ ADVANCED] >> [☁ SHTR EFFECT] >> [ON] and keep the [PHOTO SHOT] Button pressed, the Camcorder will continuously record still pictures in approx. 0.7 seconds intervals until the button is released.

- The screen blinks and, at the same time, a shutter clicking sound is recorded.

Recording a Still Picture on a Card (Photoshot) (For PV-GS39/PV-GS59)

Still pictures can be recorded on the Memory Card from the Camcorder.

- Open the LCD Monitor or extend the Viewfinder before turning on the power.

1 Set the [OFF/ON] Switch to [ON].

- The [STATUS] Indicator lights Red.

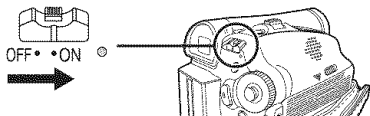

2 Set the Mode Dial to Card Recording Mode.

- The [CARD RECORDING MODE] is displayed on the screen.

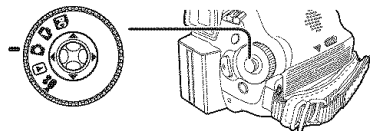

3 Press the [PHOTO SHOT] Button.

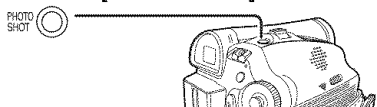

- The [] Indication lights up in red.

Recording with a shutter operation effect

You can add a shutter operation simulating sound.

1 Set [ADVANCED] >> [SHTR EFFECT] >> [ON].

Selecting the quality of Photoshot images

1 Set [BASIC] >> [PICT.QUALITY] >> [(High Picture Quality)] or [(Normal Picture Quality)].

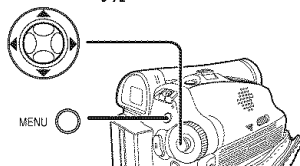

- You can also change the picture quality on [ADVANCED] >> [PICT. QUALITY] in the Tape Recording Mode.

Maximum number of still pictures recordable on an SD Memory card (optional)

PICTURE QUALITY	📷 (High)	📷 (Normal)
32 MB	220	440
64 MB	440	880
128 MB	880	1 760
256 MB	1 760	3 520
512 MB	3 520	7 040
1 GB	7 040	14 080
2 GB	14 080	28 160

- The numbers shown in the table are approximations.
- These figures vary depending on the subject being photographed.

On-screen display in the Card Recording Mode

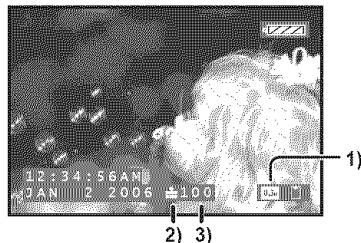

- 1) Still picture size
- 2) Quality of still pictures
- 3) Number of recordable still pictures (When no pictures can be recorded, the red light will flash.)

To record still pictures clearly

- When zooming in on the subject with a magnification of 4× to 10× or higher, it is difficult to reduce the slight hand shaking from holding the Camcorder. We recommend decreasing the zoom magnification and approaching the subject when recording.
- When recording still pictures, hold the Camcorder firmly with your hands and keep your arms stationary at your side so as not to shake the Camcorder.
- You can record stable pictures without hand shaking by using a tripod and the Remote Control. (PV-GS59 Only)

Notes:

- Even if the [SHTR EFFECT] is set to [ON], the Shutter Effect cannot be recorded on the picture.
- When the color of the screen changes or blurs, adjust the shutter speed manually to 1/60 or 1/100.
- Photoshot Recording results in slightly inferior image quality.
- For the number of still pictures to be recorded on a card, refer to page 32.
- The sound cannot be recorded.
- While data is being recorded on a card, do not operate the Mode Dial.
- When the Access Lamp is lit, do not insert or remove a card.
- Another product may degrade or not play back data recorded on this Camcorder.
- If set [PICT. QUALITY] >> [Mosaic], mosaic-pattern noise may appear on a playback image depending on the picture content.

RapidFire Consecutive Photoshot

The still pictures can be recorded on a Card at regular intervals.

- 1 Set [ADVANCED] >> [BURST MODE] >> [ON].

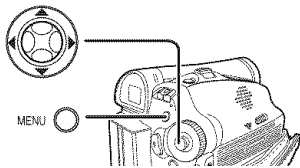

- The [] Indication appears.



- 2 Press and hold the [PHOTO SHOT] Button.



- When [ON] is selected, the still pictures can be recorded in approximately 0.5 second intervals until the [PHOTO SHOT] Button is released or 10 pictures are recorded.

To Stop the RapidFire Consecutive Photoshot in Progress

Release the [PHOTO SHOT] Button.

Notes:

- One more still picture may be recorded after you release the [PHOTO SHOT] Button.
- If the Self-timer Function is set, the Camcorder records up to 10 still pictures continuously.
- Intervals between recording pictures may become longer depending on the card. We recommend using a Panasonic SD Memory Card.
- When using the card formatted by other equipment or a card that was recorded and erased repeatedly, the intervals between recording pictures may become longer. If so, back up your important data on a PC, and format your card with this Camcorder.

Recording Yourself

You can record yourself while viewing the LCD Monitor. You can record persons in front of the camera while presenting them the image. The image is horizontally flipped as if you see a mirror image. (The image to be recorded is the same as that recording.)

- Extend the Viewfinder to see the picture while recording.
- Set to Tape/Card Recording Mode.

- 1 Rotate the LCD Monitor towards the lens side.

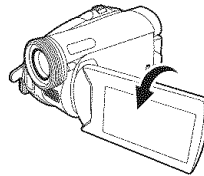

- A vertically oriented display appears on the Viewfinder screen, this is normal and not indicative of any trouble.
- When the LCD Monitor is rotated towards the lens side, the One-Touch Navigation icon will not be displayed even if you press the center of the Joystick Control.

Recording with the Built-in LED Video Light

To brighten the natural colors in a scene. Gain Up mode works with the Built-in Video Light to enhance the light's brightness.

- Set to Tape/Card Recording Mode.

- 1 Press the [LIGHT] Button.

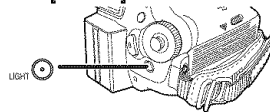

- The Built-in LED Video Light lights and the Gain Up mode is set to on.
- Gain Up mode will be brighter than when only the Video Light is on, however, washed out images will appear.

2 Press the [LIGHT] Button. ②

- Gain Up mode is set to off.
- To eliminate washed out images, use this mode.

3 Press the [LIGHT] Button. ③

- The Video Light turns off.
- Pressing the [LIGHT] Button again returns to ①.

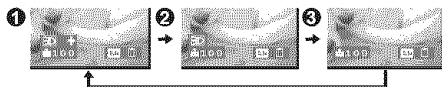

Notes:

- The subject should be within 4.9 feet (1.5 meters) of the Camcorder.
- Using the LED Video Light reduces battery time.
- Set the LED Video Light to off when not in use.
- Do not look directly into the light.
- If the LED Video light is used with a Conversion lens attached, a slight vignetting (darkening around edges) effect occurs on the screen.
- Using the MagicPix Function at the same time will make conditions even brighter.
- The LED video light enables simply lightening the images taken in a dimly-lit place. We also recommend using it in a bright place to obtain high quality images.

Quick Start

When Quick Start is ON the battery power is still being consumed, even when the LCD Monitor and the Viewfinder are closed.

The Camcorder will resume recording/pause mode about 1.7 seconds after the LCD Monitor and the Viewfinder are reopened.

- Please note in Quick Start Mode approximately half the pause recording power is being consumed. Using Quick Start Mode will reduce the battery recording/playback time.
- This function is only activated in the following cases:
 - A tape or a card is inserted while the Tape Recording Mode is set.
 - A card is inserted while the Card Recording Mode is set.

• Set to Tape/Card Recording Mode.

1 Set [SETUP] >> [QUICK START] >> [ON].

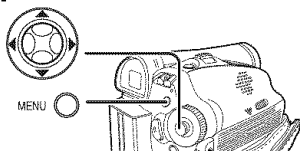

2 While the [OFF/ON] Switch is still set to [ON], close the LCD Monitor and retract the Viewfinder.

- The Green Lamp ① lights up and the unit goes into Quick Start Standby mode.

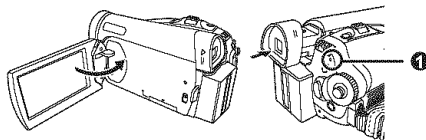

3 Open the LCD Monitor or the Viewfinder.

- The Red Lamp lights up and the camera will be put into recording pause approx. 1.7 seconds after it is turned on.

■ To Cancel the Quick Start

- Set [SETUP] >> [QUICK START] >> [OFF].
- If the standby continues for approx. 30 minutes, then the Lamp (Green) will go off and the Camcorder will be completely turned off.

Notes:

- When you set [POWER SAVE] to [5 MINUTES] and the Camcorder is left in the Recording Pause Mode for 5 minutes, the unit will turn off. (Green LED will lit up.) Close the LCD Monitor and retract the Viewfinder. To turn the Camcorder on open the LCD Monitor and/or the Viewfinder.
- If the Mode Dial is moved or the battery is removed in Quick Start standby mode, Quick Start is canceled and the power turns off even if the [OFF/ON] Switch is set to [OFF]. (However, changing the mode between Tape Recording Mode and Card Recording Mode will not cancel Quick Start.)
- When the Camcorder is Quick-Started with the White Balance on automatic, it may take some time until the White Balance is adjusted if the scene being recorded has a light source different from the scene last recorded. (When the MagicPix Function is used, however, the White Balance of the scene last recorded is retained.)
- If the power is turned on in Quick Start standby, the zoom magnification becomes 5x and the picture size may differ from what it was before Quick Start standby.
- When using the AC Adaptor, Quick Start can be used even if a tape is not inserted.

Self-timer Recording (For PV-GS39/PV-GS59)

When you set the self-timer, the recording starts automatically after 10 seconds on the Card.

• Set to Card Recording Mode.

1 Press the Joystick Control to display the One-Touch Navigation icon on the lower right of the screen.

2 Move the Joystick Control [▼] until the page with [⏻] indication is displayed.

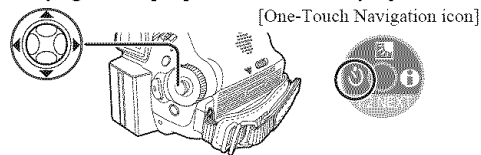

3 Move the Joystick Control [◀] to select [⏻].

- The [SELF-TIMER ON] and the [⏻] Indication appears.

4 Press the [PHOTO SHOT] Button.

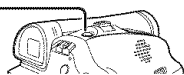

- The [⏻] Indication flashes and the recording starts after 10 seconds. After recording, the Self-Timer will be canceled.

■ To Stop the Self-timer in Progress

Press the [MENU] Button.

■ To Cancel the Self-timer

Move the Joystick Control [◀] to select [⏻] again.

- The [SELF-TIMER OFF] is displayed.

Notes:

- When [BEEP SOUND] on the [SETUP] Sub-Menu is set to [ON], the beep sound will be emitted along with the Recording Lamp flashing in the Self-timer Standby Mode.
- By operating the [OFF/ON] Switch or Mode Dial, the Self-timer Standby Mode is canceled.
- If the RapidFire Consecutive Photoshot is set, the maximum recordable pictures (max. 10 pictures) are recorded. (p. 33)

Zoom In/Out Functions

This feature gives special effects to the picture by recording objects close by or with wide-angle shot. You can zoom in up to 30× optically.

• Set to Tape/Card Recording Mode.

- 1** For wide-angle shots (zoom out) :
Push the [W/T] Lever towards [W].
For close-ups (zoom in) :
Push the [W/T] Lever towards [T].

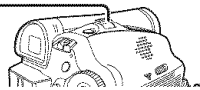

- Zoom Magnification Indication is displayed for a few seconds.

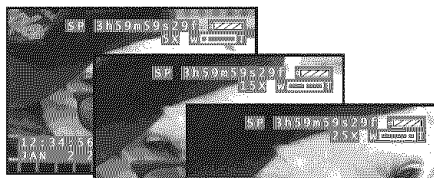

Notes:

- When zooming in and taking a picture while holding the Camcorder by hand, we recommend using the image stabilizer function.
- When you are zooming in on a faraway subject, a sharper focus is achieved if the recording subject is 4.3 feet (1.3 meters) or further from the Camcorder.
- When the zoom speed is high, the subject may not be focused easily.
- When the zoom magnification is 1×, the Camcorder can focus on a subject approx. 0.8 inches (20 mm) away from the lens.

To Use the Zoom Microphone Function

Along with the zooming operation, the microphone's directional angle and sensitivity are varied for recording sounds.

• Set to Tape Recording Mode.

- 1** Set [ADVANCED] >> [ZOOM MIC] >> [ON].

- The [ZOOM MIC] Indication is displayed.



■ To Cancel the Zoom Microphone Function

Set [ADVANCED] >> [ZOOM MIC] >> [OFF].

Note:

- The Zoom Microphone Function may not work effectively if the surrounding noise is too loud.

Digital Zoom Function

This function is useful when you want to record close-up shots of subjects located beyond a normal zoom range of 1× to 30× magnification. With the Digital Zoom Function, you can select a magnification from 50× up to 1000×.

• **Set to Tape Recording Mode.**

1 Set [ADVANCED] >> [D.ZOOM] >> [50×] or [1000×].

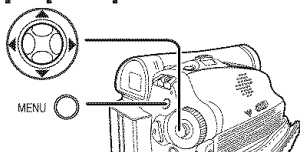

OFF	Optical zoom only (Up to 30×)
50×	Digital zooming to 50×
1000×	Digital zooming to 1000×

2 Push the [W/T] Lever towards [W] or towards [T] to zoom in or out.

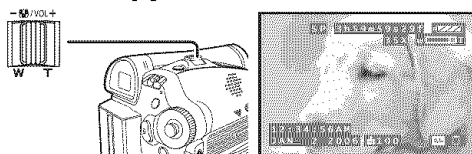

■ **To Cancel the Digital Zoom Function**

Set [ADVANCED] >> [D.ZOOM] >> [OFF].

Notes:

- The larger the digital zoom magnification, the more the image quality is degraded.
- When the Card Recording mode is used, the Digital Zoom Function cannot be used.
- White Balance cannot be set in the Digital Zoom range.

About the Variable Speed Zoom Function

- When pushing the [W/T] Lever as far as it will go, you can zoom from 1× to 30× in 3.3 seconds at the maximum in the Recording Mode.
- The zoom speed varies according to the amount of movement of the [W/T] Lever.
- The Variable Speed Zoom Function cannot be used with the Remote Control. (PV-GS59 Only)

Image Stabilizer Function

If the Camcorder is shaken while recording, the camera shake in the image can be corrected.

- If the Camcorder shakes too much, the images may not be stabilized.

• **Set to Tape Recording Mode.**

1 Set [ADVANCED] >> [EIS] >> [ON].

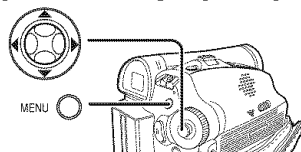

- The [EIS] Indication appears.

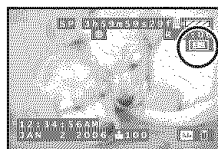

2 Press the Recording Start/Stop Button or [PHOTO SHOT] Button to start recording.

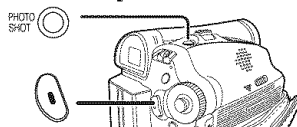

■ **To Cancel the Image Stabilizer Function**

Set [ADVANCED] >> [EIS] >> [OFF].

Notes:

- When the MagicPix Function is used, the image stabilizer function does not work. If so, the [EIS] indication flashes.
- When the Gain Up mode is set to ON, the image stabilizer function does not work. If so, the [EIS] indication flashes.
- Under fluorescent lighting, image brightness may change or colors may not look natural.
- After-images may appear.
- When a tripod is used, we recommend that you turn the Image Stabilizer off.
- In the following cases, the Image Stabilizer Function may not work effectively.
 - When the digital zoom is used
 - When a conversion lens is used
 - When recording is done in an extremely dark place
 - When the Camcorder is shaken greatly
 - When you record a moving subject while tracking it

Fade In/Out Functions

- **Fade In :**
The image and audio gradually appear.
- **Fade Out :**
The image and audio gradually disappear.
- **Set to Tape Recording Mode.**

1 Press the Joystick Control to display the One-Touch Navigation icon on the lower right of the screen.

2 Move the Joystick Control [▼] until the page with [] indication is displayed.

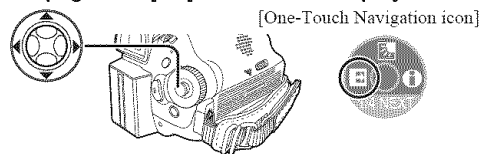

3 Move the Joystick Control [◀] to select [].

- The [FADE ON] is displayed.
- The [] W or [] B Indication flashes and then is displayed.

4 Press the Recording Start/Stop Button.

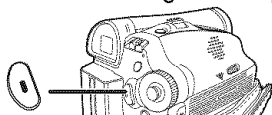

Start recording. (Fade in)

- The [RECORD (NOW FADING)] is displayed.
- When you start recording, the image/audio disappeared completely and the image/audio gradually appears.

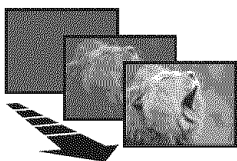

Pause recording. (Fade out)

- The [PAUSE (NOW FADING)] is displayed.
- The image/audio gradually disappears. After the image/audio completely disappears, recording stops.

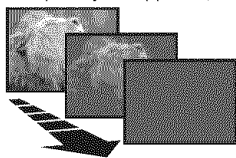

To Cancel Fading

Move the Joystick Control [◀] to select [] again.

- The [FADE OFF] is displayed.

To Select the Color For Fade in/out

The color which appears in fading pictures can be selected.

1 Set [] ADVANCED >> [] FADE COLOR >> [BLACK] or [WHITE].

Note:

- While the Fade in/Fade out function is selected, it takes several seconds to display the image when you start recording images. Besides, it also takes several seconds to pause recording.

Backlight Compensation Function

This prevents the subject from being recorded too darkly when backlit. (Backlight is the light that shines from behind the subject being recorded.)

- **Set to Tape/Card Recording Mode.**

1 Press the Joystick Control to display the One-Touch Navigation icon on the lower right of the screen.

2 Move the Joystick Control [▼] until the page with [] indication is displayed.

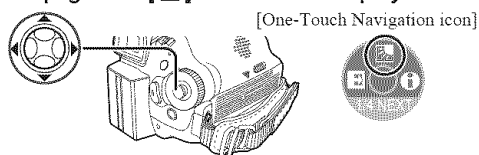

3 Move the Joystick Control [▲] to select [].

- The [BACKLIGHT COMPENSATION ON] is displayed. The [] Indication flashes and then is displayed.
- The entire screen becomes brighter.

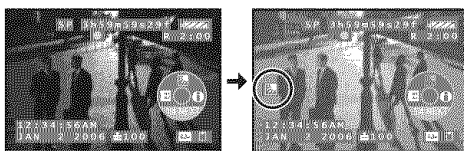

To Resume Normal Recording

Move the Joystick Control [▲] to select [] again.

- The [BACKLIGHT COMPENSATION OFF] is displayed.

Notes:

- When setting the Iris manually, the Backlight Compensation Function does not work.
- If you operate the [OFF/ON] Switch or Mode Dial, the Backlight Compensation Function is canceled.

MagicPix Function

This function allows you to record color images brightly in a dark place without using the Video Light.

• **Set to Tape Recording Mode.**

- 1 Press the Joystick Control to display the One-Touch Navigation icon on the lower right of the screen.
- 2 Move the Joystick Control [▼] until the page with [👉] indication is displayed.

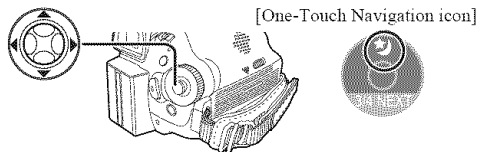

- 3 Move the Joystick Control [▲] to select [👉].
 - The [MAGICPIX ON] is displayed. The [👉] Indication flashes and then is displayed.

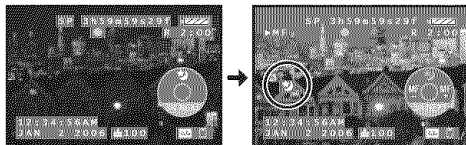

- 4 Move the Joystick Control [◀] or [▶] to adjust.

■ To Cancel the MagicPix Function

Move the Joystick Control [▲] to select [👉] again.

• The [MAGICPIX OFF] is displayed.

Notes:

- If set in a bright place, the screen may become whitish for a while.
- The MagicPix Function is canceled when you operate the [OFF/ON] Switch or the Mode Dial.
- In a dark place, the recorded picture is presented in a time-lapse-like manner.
- Adjust the Focus manually.
- White Balance cannot be set.
- The Shutter Speed cannot be adjusted.
- The Scene Mode cannot be set.
- When recording with the MagicPix Function, it is recommended that you use a tripod.
- The MagicPix Function makes the signal charging time of CCD longer up to approx. 30× longer than usual, so that dark scenes that are invisible to the naked eyes can be recorded brightly. For this reason, bright dots may be seen, but this is not a malfunction.
- The Image Stabilizer Function does not work. In this case, the [EIS] Indication flashes.
- The Backlight Compensation Function cannot be changed.

Soft-Skin Mode

This enables you to record skin colors in a softer tone. In order to get the best result, avoid background colors similar to the skin color of the subject. Otherwise, this may result in a softer background lacking in detail.

• **Set to Tape/Card Recording Mode.**

- 1 Press the Joystick Control to display the One-Touch Navigation icon on the lower right of the screen.
- 2 Move the Joystick Control [▼] until the page with [👉] indication is displayed.

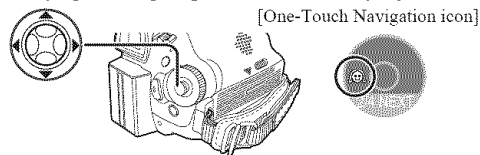

- 3 Move the Joystick Control [◀] to select [👉].
 - The [SOFT SKIN MODE ON] is displayed. The [👉] Indication flashes and then is displayed.

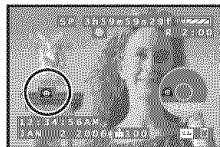

• To obtain the best effect, we recommend framing the subject as shown above in the picture.

■ To Cancel the Soft-Skin Mode

Move the Joystick Control [◀] to select [👉] again.

• The [SOFT SKIN MODE OFF] is displayed.

Notes:

- If the background or anything else in the scene has colors similar to the skin color, they will also be smoothed.
- If the brightness is insufficient, the effect may not be clear.

Wind Noise Reduction Function

This function reduces the sound of wind hitting the microphone when recording.

- Set to Tape Recording Mode.

1 Set [**WIND CUT**] >> [**ON**].

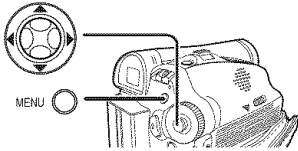

- The [**WIND CUT**] Indication appears.



■ To Cancel the Wind Noise Reduction Function

Set [**WIND CUT**] >> [**OFF**].

Notes:

- The default setting is [**ON**].
- Reduces the wind noise depending on the wind strength. (If this function is activated in strong winds, the stereo effect may be reduced. When the wind weakens, the stereo effect will be restored.)

Cinema Function (PV-GS29 Only)

This function is for recording a cinema-like image.

- Set to Tape Recording Mode.

1 Set [**CINEMA**] >> [**ON**].

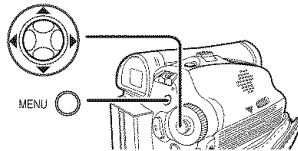

- Black bars appear at the top and bottom of the screen.

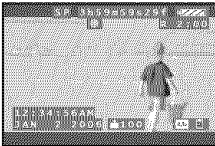

■ To Cancel the Cinema Function

Set [**CINEMA**] >> [**OFF**].

Notes:

- Images played back vary depending on the TV connected. Please refer to the operating instructions for your TV.
- This function does not widen the recording range.
- When images are played back on a TV screen, the Date/Time Indication may be erased in some cases.
- Depending on the TV, the picture quality may deteriorate.
- When a Cinema picture is imported onto a personal computer, the imported picture may not be displayed correctly, depending on the software in used.

Wide/4:3 Function (For PV-GS39/PV-GS59)

This allows you to record images compatible with wide-screen TVs.

Wide Function: Images are recorded with a 16:9 aspect ratio.

4:3 Function: Images are recorded with a 4:3 aspect ratio.

- Set to Tape/Card Recording Mode.

1 Set [**ASPECT**] >> [**4:3**]
(4:3 Function) or [**16:9**] (Wide Function).

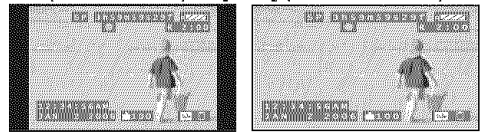

(4:3 Function)

(Wide (16:9) Function)

■ To Cancel the Wide/4:3 Function

Wide Function:

Set [**ASPECT**] >> [**4:3**].

4:3 Function:

Set [**ASPECT**] >> [**16:9**].

Notes:

- In the wide-screen mode, the menu screens, operation icons and other screen displays appear horizontally oriented.
- When images are played back on a TV screen, the Date/Time Indication may be erased in some cases.
- Depending on the TV, the picture quality may deteriorate.
- If the 4:3 Function is set, the menu screen appears expanded vertically outside the screen.
- Concerning the TV to be connected and TV used for playback
 - When playing back images taken by this unit on a TV screen, change the setting established by tape playback mode [**SETUP**] >> [**TV ASPECT**] to match the aspect ratio (4:3 or 16:9) of the TV monitor to be connected. (p. 51)
- Depending on the settings of the TV connected, the images may not be displayed properly. For more information, please read the operating instructions for the TV.

Recording in Special Situations (Scene Mode)

You can select optimal scene mode under specific recording situations.

- Set to **Tape/Card Recording Mode**.

- 1 Set the [AUTO/MANUAL/FOCUS] Switch to [MANUAL].

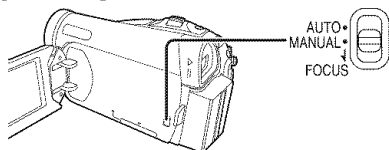

- The [MNL] Indication and the One-Touch Navigation icon appears.

- 2 Set [{ BASIC } >> [SCN SCENE MODE] >> a desired mode ([S], [P], [L], [SP] or [SS]).

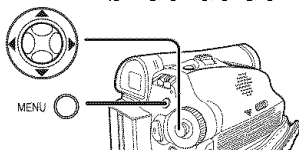

- The Indication of the selected Mode appears.



- 1) [S] Sports Mode
 - For recording scenes involving quick movements, such as sports scenes.
- 2) [P] Portrait Mode
 - Use when you want to make people (subjects) stand out from the background.
- 3) [L] Low Light Mode
 - To make the scene brighter in dark conditions.
- 4) [SP] Spotlight Mode
 - To make the subject under a spotlight look more attractive.
- 5) [SS] Surf & Snow Mode
 - To record images in bright places such as ski slopes and beaches.

■ To Cancel the Scene Mode

Set [{ BASIC } >> [SCN SCENE MODE] >> [OFF].
Or, set the [AUTO/MANUAL/FOCUS] Switch to [AUTO].

Notes:

- If any of the Scene Modes are selected, you cannot adjust the shutter speed (p. 42) or iris (p. 43).
- Using the MagicPix Function cancels any of the Scene Modes.
- Using the Light Function cancels any of the Scene Modes.

Sports Mode

- For slow motion playback (PV-GS59 Only) or playback pause of recorded pictures, this mode reduces camera shakes.
- During normal playback, the image movement may not look smooth.
- Avoid recording under fluorescent light, mercury light or sodium light because the color and brightness of the playback image may change.
- If you record a subject illuminated with strong light or a highly reflective subject, vertical lines of light may appear.
- If the light is insufficient, the Sports Mode does not function. The [S] Indication flashes.
- If this mode is used indoors, the screen may flicker.

Sports Mode/Portrait Mode

- If you record a still picture in Progressive Photoshot Mode, the brightness and hue of the recorded still picture may become unstable.
- If this mode is used for indoors, the screen may flicker. If so, change the [SCN SCENE MODE] setting to [OFF].

Low Light Mode

- Extremely dark scenes may not be able to be recorded with detail.

Spotlight Mode

- If the subject is extremely bright, the recorded image may become whitish and the periphery of the recorded image extremely dark.

Surf & Snow Mode

- If the recording subject is extremely bright, the recorded image may become whitish.

Recording in Natural Colors (White Balance)

Depending on the scene or lighting conditions, the Automatic White Balance Adjustment Mode may not be able to bring out natural colors. In this case, the white balance can be adjusted manually.

When the Camcorder is turned on with the Lens Cap on, the Automatic White Balance Adjustment may not function properly. Please turn on the Camcorder after removing the Lens Cap.

• Set to Tape/Card Recording Mode.

1 Set the [AUTO/MANUAL/FOCUS] Switch to [MANUAL].

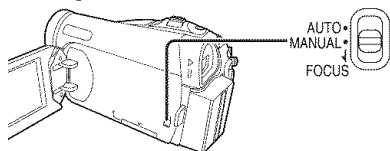

• The [MNL] Indication and the One-Touch Navigation icon appears.

2 Move the Joystick Control [▲] to select [WB].

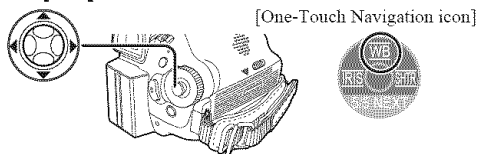

• The White Balance indication appears. ([AWB] etc.)



3 Move the Joystick Control [◀] or [▶] to select a desired White Balance Mode.

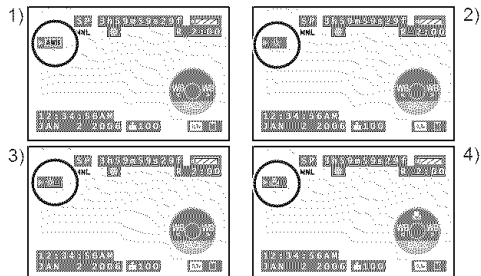

- 1) Automatic White Balance Adjustment [AWB]
- 2) Indoor Mode (recording under incandescent lamp) [★]
- 3) Outdoor Mode [※]
- 4) The white balance setting that was previously set manually [☺]

■ To Resume Automatic Adjustment

Move the Joystick Control [◀] or [▶] until the [AWB] Indication appears. Or, set the [AUTO/MANUAL/FOCUS] Switch to [AUTO].

Adjusting White Balance Manually

White Balance Adjustment recognizes the color of light and adjusts so that white will appear pure white. The Camcorder determines the hue of light that comes through the Lens and White Balance Sensor, thereby judging the recording condition, and selects the closest hue setting. This function is called Automatic White Balance Adjustment.

For light outside the functional Auto White Balance Adjustment range, use the Manual White Balance Adjustment Mode.

• Set to Tape/Card Recording Mode.

1 Set the [AUTO/MANUAL/FOCUS] Switch to [MANUAL].

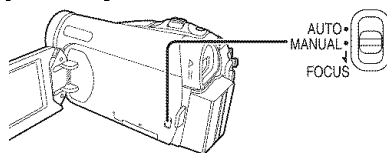

• The [MNL] Indication and the One-Touch Navigation icon appears.

2 Move the Joystick Control [▲] to select [WB].

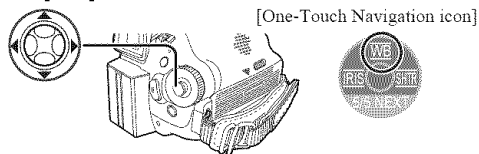

• The White Balance indication appears. ([AWB] etc.)



- 3 Move the Joystick Control [◀] or [▶] until the [AWB] Indication is displayed.



- 4 Point the Camcorder at a full-screen white subject.

- 5 Move the Joystick Control [▲] until the [MNL] Indication stops flashing.

■ **To Resume Automatic Adjustment**

Move the Joystick Control [◀] or [▶] until the [AWB] Indication appears. Or, set the [AUTO/MANUAL/FOCUS] Switch to [AUTO].

About White Balance Sensor

The White Balance Sensor ① determines the nature of the light source during recording.

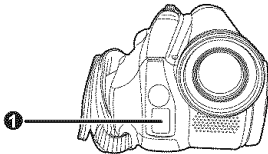

- Do not cover the White Balance Sensor with your hand during recording because White Balance will not function normally.

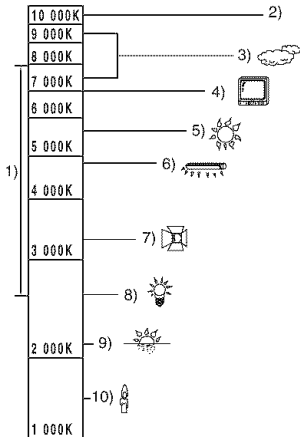

Outside of the effective range of Automatic White Balance Adjustment, the image will become reddish or bluish. Even within the effective range of Automatic White Balance Adjustment, the Automatic White Balance Adjustment may not function properly if there is more than one light source. In this case, adjust the White Balance.

- 1) The effective range of Automatic White Balance Adjustment on this Camcorder
- 2) Blue sky
- 3) Cloudy sky (rain)
- 4) TV screen
- 5) Sunlight
- 6) White fluorescent lamp
- 7) Halogen light bulb
- 8) Incandescent light bulb
- 9) Sunrise or sunset
- 10) Candlelight

Notes:

- When the Camcorder is turned on with the Lens Cap attached, the automatic White Balance adjustment may not function properly. Please turn the Camcorder on after removing the Lens Cap.
- When setting both the White Balance and the Iris/Gain, set the White Balance first.
- Whenever recording conditions change, re-set the White Balance for correct adjustment.

In the following cases, you cannot change White Balance:

- When you set the Zoom higher than 30×
- When you display a Menu
- When you use the MagicPix Mode

About flashing of the [MNL] Indication:

- When the manual adjustment mode is selected**
 - Flashing indicates that the White Balance previously adjusted is stored. This setting is stored until the White Balance is adjusted again.

When white balance cannot be set in the manual adjustment mode

- White balance may not be adjusted properly in the manual adjustment mode in dark places. If so, use the auto white balance mode.

During setting in the manual adjustment mode

- When the setting is completed, it will keep lit.

Manual Shutter Speed Adjustment

Useful for recording fast-moving subjects.

- Set to Tape/Card Recording Mode.

- 1 Set the [AUTO/MANUAL/FOCUS] Switch to [MANUAL].

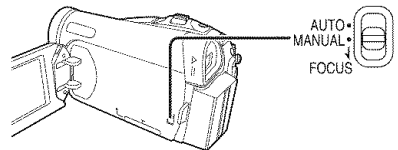

- The [MNL] Indication and the One-Touch Navigation icon appears.

2 Move the Joystick Control [▶] to select [SHR].

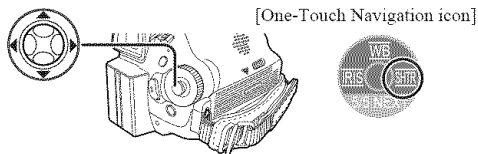

- The Shutter Speed Indication appears.

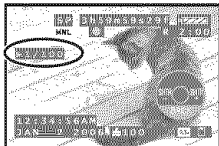

3 Move the Joystick Control [◀] or [▶] to adjust the shutter speed.

■ Range of Shutter Speed Adjustment

1/60–1/8000 s in Tape Recording Mode

1/60–1/500 s in Card Recording Mode

The standard shutter speed is 1/60 s when the EIS is OFF.

Selecting a speed closer to [1/8000] causes the shutter speed to be faster.

■ To Resume Automatic Adjustment

Set the [AUTO/MANUAL/FOCUS] Switch to [AUTO].

Notes:

- If you increase the shutter speed manually, the sensitivity lowers and accordingly the gain value increases automatically, which may increase the noises on the screen.
- You may see vertical lines of light in the playback image of a brightly shining subject or highly reflective subject, but this is not a malfunction.
- During normal playback, image movement may not look smooth.
- Avoid recording under fluorescent light, mercury light or sodium light because the color and brightness of the playback image may change.
- When recording in the extremely bright place, the color of the screen may change or flickers. If so adjust the shutter speed manually to 1/60 or 1/100.
- If you are using MagicPix Mode (p. 38) or Scene Mode (p. 40), you cannot adjust the shutter speed.

Manual Iris Adjustment (F Number)

You can use this function when the screen is too bright or too dark.

- Set to Tape/Card Recording Mode.

1 Set the [AUTO/MANUAL/FOCUS] Switch to [MANUAL].

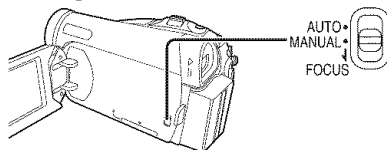

- The [MNL] Indication and the One-Touch Navigation icon appears.

2 Move the Joystick Control [◀] to select [IRIS].

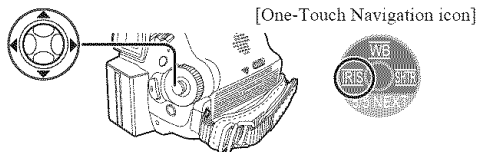

- The Iris Indication appears.

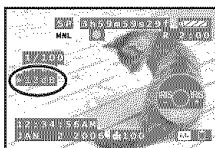

3 Move the Joystick Control [◀] or [▶] to adjust the iris.

■ Range of Iris Adjustment

CLOSE (Closed), F16, ..., F2.0,

OPEN (Opened: F1.8) + 0dB, ..., 18dB

When a value closer to [CLOSE] is selected, the image becomes darker.

When a value closer to [18dB] is selected, the image becomes brighter.

The value to which + dB is attached indicates a Gain-up value. If this value is too large, the quality of the image deteriorates.

■ To Resume Automatic Adjustment

Set the [AUTO/MANUAL/FOCUS] Switch to [AUTO].

Notes:

- Depending on zoom magnification, there are iris values that are not displayed.
- If the value does not become [OPEN], you cannot adjust the gain value.
- If the gain value is increased, the noise on the screen increases.
- If you are using MagicPix Mode (p. 38) or Scene Mode (p. 40), you cannot adjust the iris.
- If you attempt to adjust the Shutter Speed after setting the Iris, the value set for the Iris will be canceled.

Manual Focus Adjustment

Focus can be adjusted manually for recording in a situation where auto focus may not function well.

- Set to Tape/Card Recording Mode.

- 1 Set the [AUTO/MANUAL/FOCUS] Switch to [MANUAL].

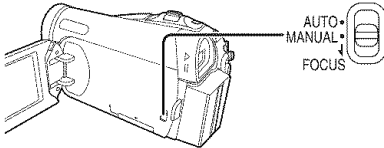

- The [MNL] Indication and the One-Touch Navigation icon appears.

[One-Touch Navigation icon]



- 2 Slide the [AUTO/MANUAL/FOCUS] Switch to [FOCUS].

- The [▶MF] Indication (Manual Focus Mode) appears.



[One-Touch Navigation icon]



- 3 Move the Joystick Control [◀] or [▶] to adjust the focus.

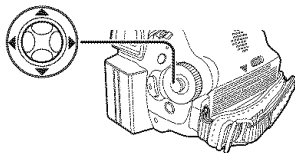

- If you keep moving the Joystick Control [▶] or [◀], the speed of adjusting becomes faster.

- When focused with a wide angle, the subject may not be in focus when zoomed in. First, zoom in on the subject, and then focus on it.

■ To Resume Automatic Adjustment

Set the [AUTO/MANUAL/FOCUS] Switch to [AUTO] or [FOCUS].

Playback Mode

Playing Back a Tape

The recorded scene can be played back immediately after the recording.

- Open the LCD Monitor or extend the Viewfinder before turning on the power.

1 Set the [OFF/ON] Switch to [ON].

- The [STATUS] Indicator lights Red.

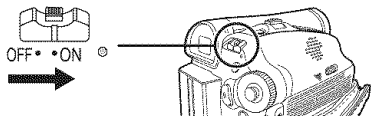

2 Set the Mode Dial to Tape Playback Mode.

- The [T] TAPE PLAYBACK MODE] is displayed on the screen.
- The One-Touch Navigation icon is displayed on the lower right of the screen.

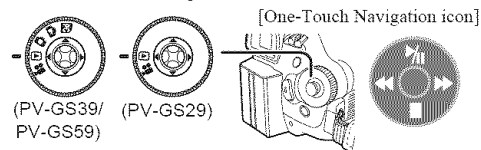

3 Move the Joystick Control [◀] to rewind the tape.

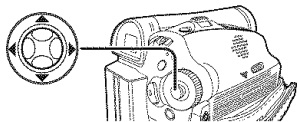

- Rewind the tape to the point where you want to start playback.
- When the tape reaches the beginning, rewinding stops automatically.

4 Move the Joystick Control [▲] to start playback.

- The [▶] Indication appears.

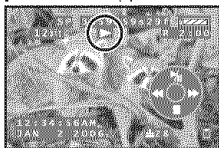

- If a cassette recorded with copyright protection signal is played back, the picture is distorted by mosaic-like patterns.

■ To Pause Playback

Move the Joystick Control [▲] to select [⏸] during playback.

■ To Stop Playback

Move the Joystick Control [▼] to select [■].

Adjusting the Sound Volume

Adjust the speaker volume for playback.

1 Push the [-] / VOL +] Lever to adjust the volume.

- Towards [+]: increases the volume
- Towards [-]: decreases the volume (Nearer the bar to [+], larger the volume.)

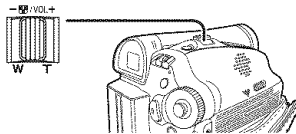

On the Remote Control, press the [T] Button to increase the volume or the [W] Button to decrease it. (PV-GS59 Only)



Notes:

- When the adjustment is completed, the volume indication [T] will disappear.
- If you do not hear the sound, check the settings of [SETUP] >> [12bit AUDIO].

Repeat Playback

When the tape end is reached, the tape will be rewound and played back again.

1 Set [ADVANCED] >> [REPEAT PLAY] >> [ON].

2 Move the Joystick Control [▲] to start playback.

- The [▶] Indication appears.

■ To cancel Repeat Playback Mode

- Set [REPEAT PLAY] >> [OFF] or set [OFF/ON] Switch to [OFF].
- When you set [USB FUNCTION] >> [WEB CAM] and then connect the USB Cable, the Repeat Playback Mode is canceled.

Settings on the audio

- If you cannot listen to the desired audio when playing back a tape, check the settings in [SETUP] >> [12bit AUDIO].
- When you record or dub the audio in [12bit] and set [SETUP] >> [12bit AUDIO] >> [MIX], the audio will be played back in stereo sound regardless of the settings in [AUDIO OUT].

Finding a Scene You Want to Play Back

- **Set to Tape Playback Mode.**
- The One-Touch Navigation icon is displayed on the lower right of the screen.

Cue/Review Playback

1 Move the Joystick Control [◀] or [▶] during Playback.

- It turns to Cue Playback (A) or Review Playback (B).

[One-Touch Navigation icon]

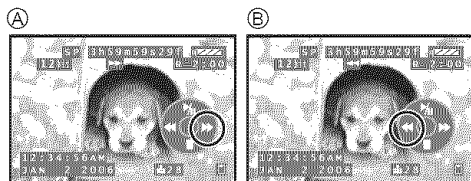

Notes:

- If the Joystick Control is held continuously, it turns to Cue Playback or Review Playback until you release it.
- During Cue/Review playback, fast-moving images may show noise as a mosaic.
- Before and after Cue/Review playback, the screen may become blue for a moment or images may be disturbed.

Variable Speed Search Function (PV-GS59 Only)

The speed of Cue Playback or Review Playback can be varied.

1 During playback, press the [VER SEARCH] Button.

- The [1×▶] Indication appears.

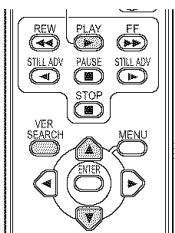

2 Press the [▲▼] Button to select a desired search speed.

- The following 6 playback speeds are available for the Variable Speed Search Function in both the fast-forwarding and rewinding directions:
1/5× (slow playback in SP Mode only), 1/3× (slow playback in LP Mode only), 1×, 2×, 5×, 10× and 20×.

■ To Resume Normal Playback

Press the [▶] Button or [VER SEARCH] Button.

Notes:

- During Cue or Review Playback, fast-moving images may show mosaic-like patterns.
- The sound is muted during search.
- This function is canceled when the One-Touch Navigation icon is displayed.
- The Variable Speed Search function is not available when the Repeat Playback is active.

Slow Motion Playback (PV-GS59 Only)

This Camcorder can play back at a slow speed.

- Scenes recorded in the SP Mode are played back at approximately 1/5th of the normal speed.
- Scenes recorded in the LP Mode are played back at approximately 1/3rd of the normal speed.
- **Set to Tape Playback Mode.**
- The One-Touch Navigation icon is displayed on the lower right of the screen.

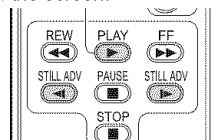

1 Press the [▶] Button.

2 Press the [◀|] Button or [|▶] Button on the Remote Control.

- The [|▶] or [◀|] Indication appears.



- When the [◀|] Button is pressed, Slow Motion Playback proceeds in the reverse direction.
- When the [|▶] Button is pressed, Slow Motion Playback proceeds in the forward direction.
- If the Slow Motion Playback continues for approx. 10 minutes or more, then the playback will automatically stop. (10 minutes of Slow Motion playback is equivalent to approx. 2 minutes in the SP mode or approx. 3 minutes in the LP mode.)
- In the reversed Slow-Motion Playback, the time code indication may be unstable.

■ To Resume Normal Playback

Press the [▶] Button.

Still Playback/Still Advance Playback

This Camcorder is capable of still picture playback and frame-advance playback.

• Set to Tape Playback Mode.

- The One-Touch Navigation icon is displayed on the lower right of the screen.

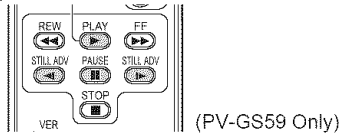

1 Press the [▶] Button.

2 Press the [⏏] Button.

- The playback image stops in the Still Playback Mode.

3 Press the [◀] Button or [▶] Button on the Remote Control.

- The [▶] or [◀] Indication appears.
- With each press of the [◀] Button, still pictures advance in the reverse direction. With each press of the [▶] Button, still pictures advances in the forward direction. If one of the buttons continues to be pressed, still pictures advance continuously 1 frame at a time until the button is released.

■ To Resume Normal Playback

Press the [▶] Button.

Playback with Zoom Lever

By pushing the [W/T] Lever of the Camcorder in the Still Playback Mode, still pictures can be advanced one frame at a time in the forward or backward direction. If you keep pushing the Lever, still pictures advance continuously.

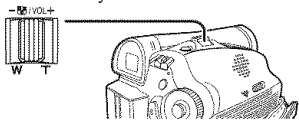

- If the Camcorder is left in the Still Playback Mode for more than 5 minutes, the Camcorder switches to the Stop Mode to protect the video heads from excessive wear and tear.

Playing Back a Memory Card (For PV-GS39/PV-GS59)

It plays back files recorded on a Card.

- Open the LCD Monitor or extend the Viewfinder before turning on the power.

1 Set the [OFF/ON] Switch to [ON].

- The [STATUS] Indicator lights Red.



2 Set the Mode Dial to Picture Playback Mode.

- The [CARD PLAYBACK MODE] is displayed on the screen.
- The One-Touch Navigation icon is displayed on the lower right of the screen.

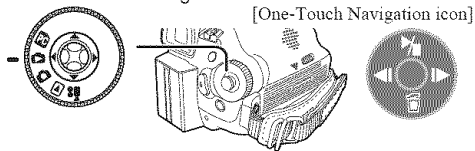

3 Start Playback.

Joystick Control [▲] : Starting the Slide Show
Stop the Slide Show

Joystick Control [▼] : Erase the pictures

Joystick Control [◀] : Playing back the previous picture

Joystick Control [▶] : Playing back the next picture

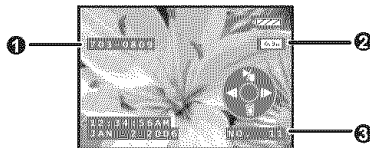

① Folder File Number

② Picture Size (p. 70)

③ File Number

To Select a Desired File and Playing Back

Multiple files on the card (6 files on 1 screen) are displayed.

1 Push the [- / VOL +] Lever to switch the images.

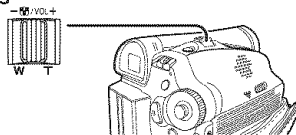

Towards [+]: Full-screen display
(Displays 1 image.)

Towards [-]: Multi-screen display
(Displays 6 files on 1 screen.)

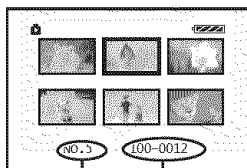

① File Number

② Folder File Number

2 Move the Joystick Control [▲, ▼, ◀, or ▶] to select a desired file.

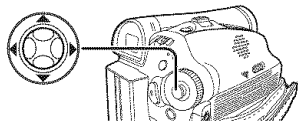

- In the Multi-screen display,
 - Move the Joystick Control [▲, ▼, ◀, or ▶] to select a file (The selected file will be encircled by a yellow frame) and press to determine it. The selected file is full-screen displayed.
 - If there are 7 files or more, then move the Joystick Control. The next, or previous Multi-Screen will be displayed.

■ About the compatibility of still pictures

- The Camcorder is compliant with the unified standard DCF (Design rule for Camera File system) established by JEITA (Japan Electronics and Information Technology Industries Association).
- The file format supported by this Camcorder is JPEG. (Not all JPEG formatted files will be played back.)
- If an out-of-specs file is played back, the folder/file name may not be displayed.
- The Camcorder may degrade or not play back data recorded or created on another product and another product may degrade or not play back data recorded on the Camcorder.

Notes:

- While the data on a card are played back, do not operate the Mode Dial.
- If a blank (nothing recorded) Card is played, the screen becomes white.
- If you attempt to play back file recorded in a different format or file data is defective, the whole display becomes bluish and the [UNPLAYABLE CARD] Indication may appear as warning.
- When the Access Lamp is lit, do not insert or remove a card.
- When playing back a picture recorded on other equipment, its size and that of this Camcorder may appear differently.
- It takes time to display the file depending on the number of pixels of the file.
- When playing back a file recorded on other equipment, the date and time display is different from when it was recorded.
- When playing back a picture recorded on other equipment, the picture may not be played back or the quality of pictures may be deteriorated.
- When playing back a non standardized file, the Folder File Number may not be displayed.

Slide Show (For PV-GS39/PV-GS59)

The recorded still pictures in the Card can be played back like a Slide Show.

- **Set to Picture Playback Mode.**
- The One-Touch Navigation icon is displayed on the lower right of the screen.

1 Move the Joystick Control [▲] to select [▶].

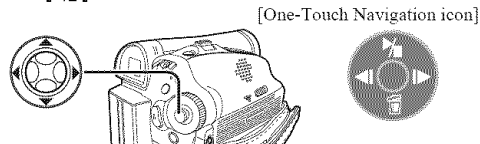

- The [▶] Indication is displayed.



- Each of the pictures are played back for several seconds.

■ To Stop the Slide Show

- Move the Joystick Control [▲] to select [▶] again.

Note:

- Playback time may take longer than usual depending on the picture.

Deleting the Files Recorded on a Card (For PV-GS39/PV-GS59)

Using the Camcorder, you can delete the files recorded on a Card. After the file is deleted, it cannot be restored.

- Set to Picture Playback Mode.
- The One-Touch Navigation icon is displayed on the lower right of the screen.

To Select and Delete Files

- 1 Move the Joystick Control [◀] or [▶] to select the file to be deleted.

[One-Touch Navigation icon]



- 2 Move the Joystick Control [▼] to select [OK].

[One-Touch Navigation icon]



- 3 Move the Joystick Control [▲] or [▼] to select [DELETE 1 FILE] and press the Joystick Control.



- 4 Move the Joystick Control [▲] or [▼] to select [YES] and press the Joystick Control.



- The selected file is deleted from the Card.
- If [NO] is selected, the file selection is canceled.

To Select and Delete All Files

- 1 Move the Joystick Control [▼] to select [OK].

[One-Touch Navigation icon]

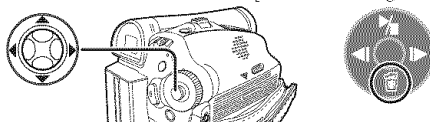

- 2 Move the Joystick Control [▲] or [▼] to select [ALL FILES] and press the Joystick Control.



- 3 Move the Joystick Control [▲] or [▼] to select [YES] and press the Joystick Control.

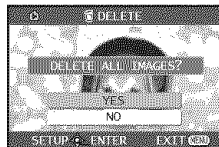

- All files of Picture Playback Mode are erased.
- A locked file cannot be erased.

Deleting still picture files recorded on a card by other equipment

- A still picture file (other than JPEG) that cannot be played back on the Camcorder may be erased.
- To delete multiple files on the SD Card (selected files) connect to a PC and use the SD Drive feature.

Notes:

- Do not turn off the power while deleting.
- To delete files, use the AC Adapter or a sufficiently charged battery.
- In case of [ALL FILES], the deletion may take time if there are many files on the card.
- When [CARD FULL] is shown during recording, switch to the Picture Playback Mode and then delete unnecessary files.
- If files conforming to DCF standard are deleted, all the data related to the files will be deleted.

Writing Printing Data on a Card (DPOF Setting) (For PV-GS39/PV-GS59)

DPOF Setting Printing data (DPOF Settings), such as the number of images to be printed, can be written to the Card. "DPOF" means Digital Print Order Format.

- **Set to Picture Playback Mode.**
- The One-Touch Navigation icon is displayed on the lower right of the screen.

1 Set [ADVANCED] >> [DPOF SET] >> [SET].

- When all images are not printed, select [CANCEL ALL].

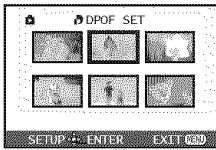
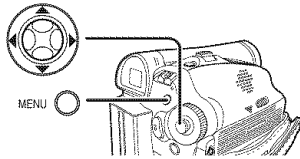

2 Move the Joystick Control [, , , or] to select a desired picture and press the Joystick Control.

- The selected picture is marked with a frame.
- The number of prints  set to be in DPOF is displayed.

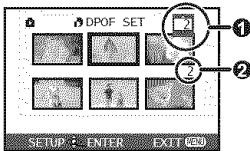

3 Move the Joystick Control [, or] to select the number of prints, and press the Joystick Control.

- The number of prints  is displayed in the picture set.
- You can select from 0 to 999. (Selected number of pictures can be printed as you set the number of prints with the printer supporting DPOF.)
- 2 or more files can be set in succession.

4 Repeat Steps 2 and 3 and press the [MENU] Button when the setup is completed.

■ About the DPOF

DPOF stands for Digital Print Order Format. This enables the printing information to be added to the pictures on the card so that it can be used on a system supporting DPOF.

Notes:

- DPOF setting made on another camera may not be recognized by Camcorder. Perform the DPOF Settings on your Camcorder.
- Verifying the DPOF Settings may take a little time. Wait until the Card Access Lamp goes out.

Protecting the Files on a Card (Lock Setting) (For PV-GS39/PV-GS59)

Precious files recorded on a Card can be locked to prevent accidental erasure. (Even if files are locked, the files will be deleted if the Card is formatted.)

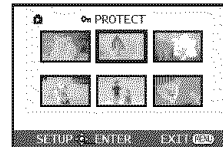
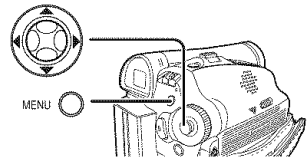

- **Set to Picture Playback Mode.**
- The One-Touch Navigation icon is displayed on the lower right of the screen.

1 Set [BASIC] >> [PROTECT] >> [YES].

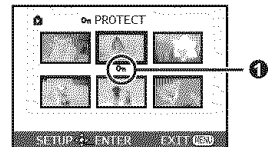

2 Move the Joystick Control [, , , or] to select the file to be locked, and press the Joystick Control.



- The selected file is locked and the [] Indication  appears. Repeat this procedure to lock 2 or more files.
- Press the Joystick Control again to cancel.

3 Repeat Step 2 and press the [MENU] Button when the setup is completed.

Notes:

- The Lock Setting carried out by this Camcorder is only effective for this Camcorder.
- The SD Memory Card has a write protection switch on it. If the switch is moved to the [LOCK] side, you cannot write to or format the Card. If it is moved back, you can.

Formatting a Card (For PV-GS39/PV-GS59)

If a Card becomes unreadable by the Camcorder, format it for reuse. Formatting erases all the data recorded on a Card.

- When formatting the card all protected files (lock) are also deleted.
- Set to Picture Playback Mode.
- The One-Touch Navigation icon is displayed on the lower right of the screen.

- 1 Set [ ADVANCED] >> [ FORMAT CARD] >> [YES].

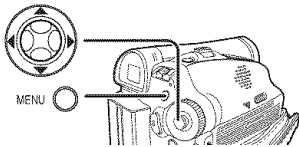

- A confirmation message appears, select [YES] and formatting will be carried out.

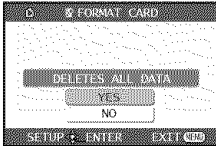

- When the formatting is completed, the screen becomes gray.

Notes:

- Normally, it is not necessary to format the card. If a message appears even though you insert and remove the card several times, format it.
- In order to maintain full compatibility, you must format the SD Memory Card using the Camcorder.
- PC formatted SD Memory Cards are not compatible with the Camcorder.
- The Camcorder supports SD Memory Cards formatted in FAT12 system (for SD Memory Card of 8, 16, 32 and 64 MB) and FAT16 system (for SD Memory Card of 128, 256, 512 MB, 1 GB and 2 GB).

Playing Back on Your TV





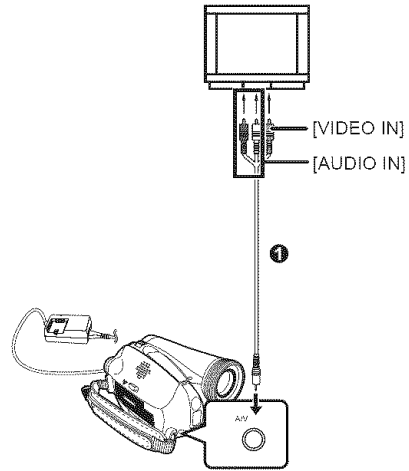

By connecting your Camcorder with your TV, the recorded scenes can be viewed on your TV screen.

- Before connecting them, turn off the power of both the Camcorder and TV.

- 1 Insert a recorded tape into this Camcorder.
- 2 Connect the [AV OUT] Jack of the Camcorder and the Video and Audio Input Jacks of the TV.



- Connect to the TV with the AV Cable ①.

- 3 Turn on this Camcorder and set the Mode Dial to the Tape Playback Mode.
- 4 For PV-GS39/PV-GS59 users : Set [ SETUP] >> [ TV ASPECT] >> [4:3] or [16:9].
- 5 Select the input channel on the TV.
- 6 Move the Joystick Control [] to select the [] to start playback.
 - The image and audio are output on the TV.
- 7 Move the Joystick Control [] to select the [] to stop playback.

■ If the image or audio from this Camcorder is not output on the TV

- Check that the plugs are inserted as far as they go.
- Check the [12 bit AUDIO] settings.
- Check the connected terminal.
- Check the TV's input setting (input switch). (For more information, please read the operating instructions for the TV.)

■ To Display the On-screen Information on the TV

The information displayed on the LCD Monitor or the Viewfinder (One-Touch Navigation icon, time code and mode indication, etc.), date and time can be displayed on the TV.

1 Press the [EXT DISPLAY] Button on the Remote Control. (PV-GS59 Only)

- Press the button again to erase the OSD information.

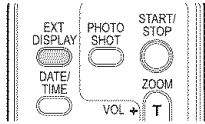

Note:

- Use the AC adaptor to avoid battery depletion.

Editing Mode

Recording from a Tape onto a Card (For PV-GS39/PV-GS59)

Still pictures can be recorded on the Memory Card from scenes that have already been recorded on a cassette.

1 Set the Mode Dial to Tape Playback Mode.

- The One-Touch Navigation icon is displayed on the lower right of the screen.

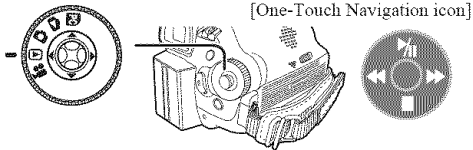

2 Insert a tape which already has recorded contents and a card.

3 Move the Joystick Control [▲] to start playback and set the Camcorder to Still Playback Mode at the scene you wish to record, and press the [PHOTO SHOT] Button.

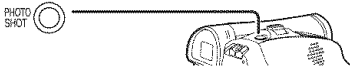

- Audio will not be recorded.

Note:

- If you press the [PHOTO SHOT] Button without pausing, blurred pictures may be recorded.

Audio Dubbing (PV-GS59 Only)

You can add music or narration to the recorded Cassette.

- If the tape recorded in the [16bit] Mode is dubbed with the Audio Dubbing function, the original sound is erased. (If you wish to preserve the original sound, use the [12bit] Mode when recording.)
- Audio Dubbing cannot be performed on a recording made in LP Mode. (p. 29)
- Set to Tape Playback Mode.

1 Find a scene that you want to add sound to, and press the [■] Button on the Remote Control.

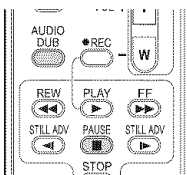

2 Press the [AUDIO DUB] Button on the Remote Control.

- The [AUDIO] Indication appears.

3 To start Audio Dubbing, press the [■] Button on the Remote Control. Or, move the Joystick Control [▲] to select [■].

- The [AUDIO] Indication appears.
- Talk into the microphone.



4 Press the [■] Button on the Remote Control to stop audio dubbing. Or, move the Joystick Control [▲] to select [■] again.

- The Camcorder is in the Still Playback Mode again.

■ Before Recording with Audio Dubbing

• Set to Tape Recording Mode

- When you want to preserve the original sound taken during recording, set [ADVANCED] >> [AUDIO REC] >> [12bit] to take pictures. (When set [16bit], the sounds taken during recording are erased after recording with audio dubbing.)
- Set [BASIC] >> [REC SPEED] >> [SP] to take pictures.

■ To Play Back the Sound Recorded by 12bit Audio Dubbing

Set [SETUP] >> [12bit AUDIO] >> [ST1], [ST2] or [MIX].

ST1: It plays back only the original sound.

ST2: It plays back only the sound added by Audio Dubbing.

MIX: It plays back both the original sound and the sound added by Audio Dubbing simultaneously.

- During Audio Dubbing, it is automatically set to [ST2].

Notes:

- The blank section of a tape cannot be dubbed.
- Sounds sent through the DV terminal cannot be dubbed.
- If a tape has a non-recorded portion when the tape is dubbed, images and sounds may be disturbed when this portion of the tape is played back.
- In the case of importing data recorded with Audio Dubbing to a PC using the PC's software, only the original sound (ST1) may be imported, depending on the software.

Copying onto a DVD Recorder or a VCR (Dubbing)

Pictures recorded by the Camcorder can be stored on a DVD-RAM or other such media. Refer to the instructions for the recorder.

- Place a recorded cassette in the Camcorder, and an unrecorded DVD-RAM or cassette in the DVD Recorder or VCR.

1 Connect the Camcorder and the Recorder.

■ Connecting with the AV Cable

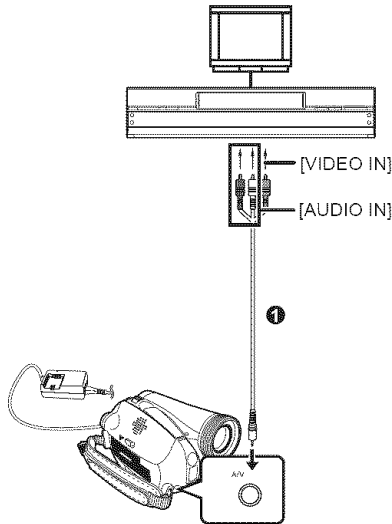

- Connect the Camcorder and the Recorder by using the AV Cable ①.

■ Connecting with the optional DV cable (Only for equipment with a DV terminal)

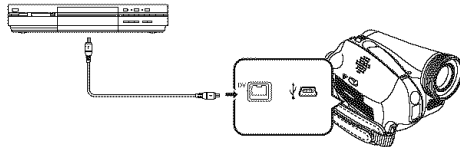

- 2 Turn on the Camcorder and set to Tape Playback Mode.
- 3 Select the input channel on the TV set and recorder.

[One-Touch Navigation icon]

- 4 Move the Joystick Control [▲] to start playback.

- The image and sound are reproduced.



- 5 Start recording.

- 6 Move the Joystick Control [▼] to stop playback.

- 7 Stop recording.

- If you record (dub) images onto another video device and then play them back on a wide screen TV, the images may be stretched vertically. In this case, refer to the operating instructions for the device that you are recording (dubbing) to or read the operating instructions for the TV and set to 16:9 (full).
- For more information, refer to the operating instructions for your TV set and recorder.
- When you do not need functional indications or date and time indications, press the [EXT DISPLAY] Button on the Remote Control for no indication. (When you connect the Camcorder and a recorder with the DV cable, these indications may not appear.) (PV-GS59 Only)

■ When neither image nor sound from the Camcorder is output to the TV set

- Check that the plugs are inserted as far as they go.
- Check the [12bit AUDIO] settings.
- Check the connected terminal.

Using the DV Cable for Recording (Digital Dubbing)

By connecting this Camcorder with other digital video equipment (such as another Camcorder of the same format/model) that has a DV input/output Terminal, and using a 4-pin to 4-pin DV Interface Cable PV-DDC9/PV-DDC9-K (optional) ①, high quality images and sounds can be dubbed in the digital mode.

- Set to Tape Playback Mode (Player/Recorder)

- 1 Connect the Camcorder and digital video equipment with the DV cable.

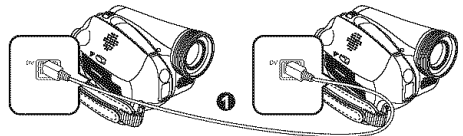

Player/Recorder:

- 2 Insert the Cassette and set to Tape Playback Mode.

Player:

3 Press the [▶] Button to start playback.

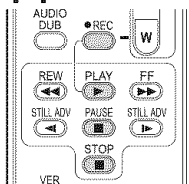

Recorder:

4 Set [ADVANCED] >> [REC STDBY] >> [YES], then move the Joystick Control [▲] to select [%].



Or, while pressing the [REC] Button, press the [▶] Button on the Remote Control. (PV-GS59 Only)

• Recording starts.

■ **To Cancel the Standby for Recording**

When the Camcorder is on standby for recording, move the Joystick Control [▼] and select the [■] or press the [■] Button on the Remote Control.

■ **To Stop Dubbing**

Press the [■] Button or the [■] Button, or move the Joystick Control [▲] to select [%] again.

CAUTION:

Unauthorized exchanging and/or copying of copyrighted recordings may be copyright infringement.

Notes:

- Do not plug or unplug the DV Cable during dubbing, or the dubbing may not be completed properly.
- If a picture (bilingual video, etc.) containing main sound and sub sound has been dubbed, select the desired sound by [SETUP] >> [AUDIO OUT] on playback.
- Regardless of the menu settings on the recorder, digital dubbing is carried out in the same mode as the [AUDIO REC] mode of the playback tape.
- The images on the recorder monitor may be disturbed, but it does not affect the recorded images.
- Even if you use a device equipped with DV Terminals such as IEEE1394, you may not be able to perform Digital Dubbing in some cases. For more information, see the instructions for equipment connected.

- Date or other information to be displayed cannot be displayed if the software of the connected equipment does not support the display function.
- While pictures are input from the DV terminal, the One-Touch Navigation icon blinks on instead of appearing from the side of the screen when you press the center of the Joystick Control.
- While pictures are input from the DV terminal, the TV aspect will not change even if you change the setting for [TV ASPECT] in the [SETUP] menu.

PC Connection With DV Interface Cable

A video clip can be transferred directly to your PC (Personal Computer) via a DV Interface Cable (Optional) using products and software from a number of video editing software companies. Using products from video editing software companies allows you to capture and edit video clips using the DV Interface.

Our DVC being OHCI compliant should have no problem working with any OHCI compliant Firewire Card/video - Editing software package.

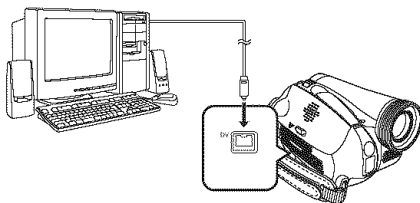

- Personal Computer must be equipped with an DV Terminal.
- During Camcorder playback, do not disconnect the DV Interface Cable or turn the Camcorder off as this may cause a PC hang-up error.
- 1394 (i.LINK) Interface must conform to OHCI (Open Host Controller Interface Specification).

With a PC:

- This function is available for models **PV-GS39 and PV-GS59.**

Using Camcorder with a PC

An image stored on the DV Cassette or Memory Card can be transferred to your personal computer.

Software Installation (For Windows) (PV-GS59 Only)

- 1 Turn on the personal computer and start up Windows.
- 2 Insert the CD-ROM into the personal computer's CD-ROM drive.
 - The [Setup Menu] screen appears.

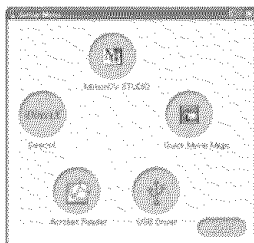

(PV-GS59: Supplied)

- 3 Select the software to be installed from [Setup Menu].

■ USB Driver (pp. 56~58) :

When the Camcorder is connected to your PC, you can send video from the Camcorder to other parties via a network or the Internet. This driver is also needed when using MotionDV Studio and Quick Movie Magic with USB connection.

■ MotionDV STUDIO (pp. 64~67) :

This software allows you to capture video recorded on a tape or images viewed through the Camcorder lens. Connecting the Camcorder with the DV cable also lets you output images edited on your PC to the Camcorder tape.

■ Quick Movie Magic (pp. 64~67) :

Recordings made with the Camcorder can easily be transferred to your PC where you can enhance them with titles and music.

■ DirectX :

To activate MotionDV STUDIO and Quick Movie Magic, Microsoft DirectX 9.0b or later should be installed. (When USB Driver is installed, DirectX 9.0b will be installed automatically depending on the operating system environment of the personal computer used.)

■ Acrobat Reader :

To view the included Operating Instructions, Adobe Acrobat Reader 5.0 or later is required. Please install Adobe Acrobat Reader from the CD-ROM.

- 4 Follow the instructions on the computer screen until the installation is complete.

- Setup window will disappear when the installation is complete.
- If a window does not appear automatically, click the "Start" Button on your desktop and then click "Run". When the "Run" Box is open, type in "D:\InstMenu.exe" and click "OK". ("D" applies when the CD-ROM drive is drive D.)

Software Installation (For Windows) (PV-GS39 Only)

- If you have Internet access, please download the USB Driver.
- **USB Driver (pp. 56~58)**
When the Camcorder is connected to your PC, you can send video from your Camcorder to other parties via a network or the Internet.

- 1 To download and install the Driver, go to:
(For U.S.A. consumers)
<http://www.panasonic.com/consumerdownloads>



(For CANADA consumers)

<http://www.panasonic.ca/english/customer-care/downloads.asp>

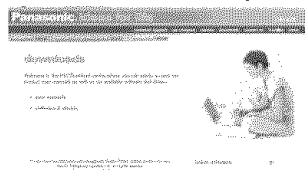

- 2 Click the software to be downloaded.

Using the USB Function

The USB connection can be used in one of the following two ways.

- ① In PC Mode, with the PC connected, the SD drive can be used (pp. 58~59).
 - ② In Tape Recording or Tape Playback Mode, with the PC connected, a motion image can be used (pp. 60~63).
- Check your OS in the Operating Environment section on page 57 and if necessary, install the USB Driver before using the USB function.

Operating environment

- Despite having the Operating environment indicated, it may not be possible to use the program with some types of personal computers.
- When you connect to an USB 2.0 interface board, use a certified board with the USB 2.0 (HI-SPEED USB) logo.

■ For Windows

OS:

① Function:

- IBM PC/AT compatible personal computer with pre-installed:
Microsoft Windows XP Professional/Home Edition
Microsoft Windows 2000
- The USB equipment operates with the driver installed standard on your OS.

② Function:

- This is the Operating environment for the USB Driver which can be installed from the supplied CD-ROM (PV-GS59) or the Web Site (PV-GS39).

- IBM PC/AT compatible personal computer with pre-installed:
Microsoft Windows XP Professional/Home Edition
SP1 (PV-GS59) / SP2 (PV-GS39) or later
Microsoft Windows 2000 SP4 or later

(PV-GS39 Only)

- For Windows 2000 users:
Please download and install the USB Driver from the Web Site.
- For Windows XP SP2 users:
The USB equipment operates with the driver installed standard on your OS.

(PV-GS59 Only)

- You'll need to install the USB Driver from the supplied CD-ROM.

CPU:

Intel Pentium II 300 MHz or higher
(including compatible CPU)

RAM:

32 MB or more (64 MB or more recommended)

Free hard disk space:

At least 30 MB or more

Interface:

USB 1.1 or more - A Type

■ For Macintosh

OS:

Mac OS X v 10.1 - X v 10.4

(Function ① Only)

CPU:

Power PC G3 (400 MHz or higher), G4, G5

RAM:

64 MB or more

- The USB equipment operates with the driver installed standard on your OS.

Installing the USB Driver

PV-GS59 Only

Install the USB Driver first before connecting the Camcorder to your PC with the USB Cable.

- When DirectX9.0b is installed, applications supported by previous versions of DirectX may not run. In this case, consult the manufacturers of the disabled applications.
- If DirectX 9.0b is not already installed, it must be installed on your PC.

1 Turn on the personal computer and start up Windows.

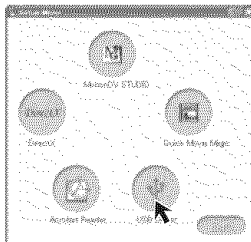

[PV-GS59: Supplied]

2 Insert the CD-ROM into the personal computer's CD-ROM drive.

- Quit all applications.
- The [Setup Menu] Screen appears.

3 Click the [USB Driver].

- The set up program starts running.

4 For Windows XP users:

Depending on your system environment, installation of "DirectX9.0b" may be required. Click [Yes] and continue with installation.

- After "DirectX9.0b" is installed, the computer will restart.
- Do not remove the CD-ROM.

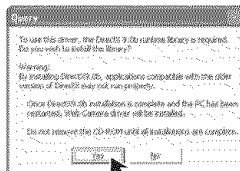

5 Finish installation by following the on-screen instructions.

- Click [Next] and proceed with installation.
- After completing the installation, click [Finish].

6 Click [Finish] if the [InstallShield Wizard] dialog appears.

- Do not remove the CD-ROM.

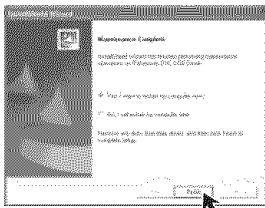

7 After the USB Driver is installed, please restart your computer.

- Reboot the computer to finish installing USB driver.
- Installation continues after the computer reboots if you selected additional software.

PV-GS39 Only

- For Windows XP users, the USB equipment operates with the driver installed standard on your OS.
- If you have Internet access, please download the USB Driver.

**1 To download and install the Driver, go to:
(For U.S.A. consumers)
<http://www.panasonic.com/consumerdownloads>**



**(For CANADA consumers)
<http://www.panasonic.ca/english/customer care/downloads.asp>**



- 2 (For U.S.A. consumers)
Click [Camcorder] on the screen.
(For CANADA consumers)
Click [software & drivers].**
- 3 Click [USB Driver (for Web Camera)].**
- 4 Decompress the downloaded data.**
- 5 Double click  icon.**
 - The set up program starts running.

- 6 Finish installation by following the on-screen instructions.**
 - Click [Next] and proceed with installation.
 - After completing the installation, click [Finish].
- 7 After the USB Driver is installed, please restart your computer.**

Connecting the Personal Computer and Camcorder

- **Never connect the USB Cable until the USB Driver is installed.**
- Before making these connections, turn off all devices, which are to be connected.
- It is recommended that you use the AC Adaptor as the power supply of the Camcorder.

Using Built-in SD Drive

By connecting the Camcorder and Personal Computer with the USB Cable, you can transfer still images saved on a Memory Card directly to your Personal Computer.

■ For Windows OS:

Microsoft Windows XP Professional/Home Edition
Microsoft Windows 2000

- 1 Insert the Memory Card into the Camcorder.**
- 2 Set the Camcorder to PC Mode.**

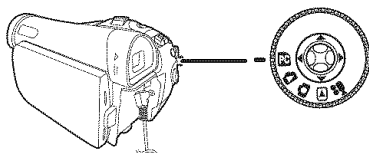

- 3 Connect the Camcorder to your personal computer with USB Cable and turn the Camcorder to "ON".**

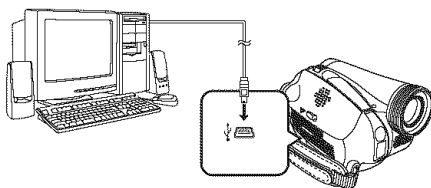

- It enters PC Connecting Mode.
- Appropriate driver to recognize Camcorder is automatically installed by Windows Plug and Play when connected for the first time.

4 Open [My Computer] and click [Removable Disk] ① (For Windows 2000 users).

5 Click [Open folder to view files using Windows Explorer] ② and then [OK] (For Windows XP users).

[Windows 2000]



[Windows XP]

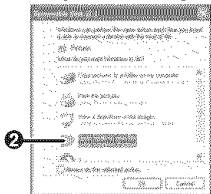

- After the USB Connection Cable is connected to the Camcorder, open [My Computer] or [Windows Explorer] to check that the drive is displayed as a removable disk drive (only when card is inserted into the Camcorder). It enables you to operate it in the same way as a floppy disk drive, and you can use the same drag and drop or copy methods.
- You can view images stored on the Memory Card and also save them to your hard disk.
- Please do not change file or folder names on the Personal Computer. The images on the Memory Card may not be able to be viewed on the Camcorder.

■ For Macintosh

OS:

Mac OS X v 10.1 – X v 10.4

1 Insert the Memory Card into the Camcorder.

2 Set the Camcorder to PC Mode.

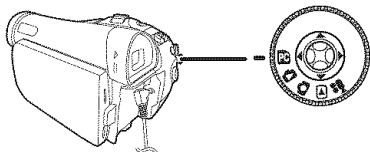

3 Connect the Camcorder to your Macintosh with USB Cable.

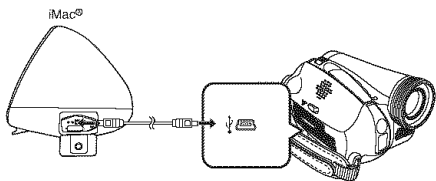

4 Double click the “NO_NAME” icon.

- You can view images stored on the Memory Card and also save them to your hard disk.
- Please do not change file or folder names on the Personal Computer. The images on the Memory Card may not be able to be viewed on the Camcorder.

To disconnect USB cable safely

■ For Windows

If USB Cable is disconnected while computer is on, error dialog may appear. In such case click [OK] and close the dialog box. By following the steps below you can disconnect the cable safely.

1 Double click the icon in task tray.

- Hardware disconnect dialog appears.



2 Select [USB Mass Storage Device] and click [Stop].

3 Verify [Matshita DVC USB Device] is selected and click [OK].

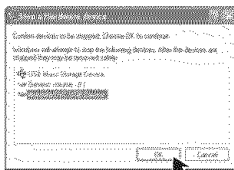

- You can safely disconnect the cable.

Note on the driver name displayed

The driver name displayed will differ depending on your OS, operating environment and the mode of the Camcorder.

Windows XP/2000:

- When the Camcorder is in PC Mode:
[USB Mass Storage Device] or [Matshita DVC USB Device]
- Make sure Camcorder's Card Access lamp is off and disconnect the cable.

CAUTION:

If you disconnect the USB Cable while the Card Access Lamp is on, it may damage the Card data.

■ For Macintosh

Removing the USB Cable safely for Macintosh

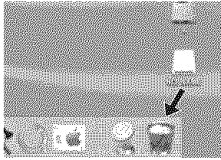

- ❶ Drop the [NO_NAME] icon which appeared when you connected the Camcorder with the USB Cable into the recycle bin, then disconnect the USB Cable.

If the above operation is not performed correctly, when data is copied from the personal computer to an SD Memory Card, the copied data may be damaged.

Even when the following operations are performed, the same results will occur as when the USB Cable is removed (above). Therefore, it is imperative that the above operation ❶ is completed before proceeding.

- When Camcorder power is turned OFF.

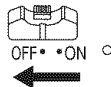

- When SD Memory Card is removed.

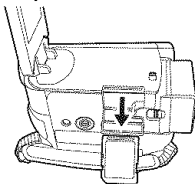

- When Mode Dial is turned to change modes.

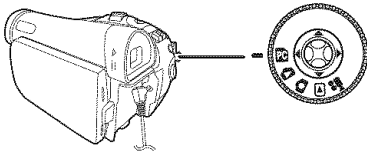

Using as a Web Camera

If the Camcorder is connected to your personal computer, you can send video and sound from the Camcorder to the other parties via the network.

- **Do not connect the USB Cable until the USB Driver is installed. (pp. 57-58)**

Please see chart below.

[Send]		[Receive]	[Software]
Windows XP	← OK →	Windows XP	Windows Messenger/ MSN Messenger
Windows XP	← OK →	Windows 2000	MSN Messenger
Windows 2000	← OK →	Windows 2000	MSN Messenger

Operating environment

OS:

IBM PC/AT compatible personal computer with preinstalled:
Microsoft Windows XP Home Edition/Professional SP1 (PV-GS59) / SP2*1 (PV-GS39) or later
Microsoft Windows 2000 Professional SP4 or later

CPU:

Intel Pentium III 450 MHz or higher
(including compatible CPU)

RAM:

128 MB or more (256 MB or more recommended)

Free hard disk space:

At least 250 MB or more

Interface:

USB 1.1 or more - A Type

To use the Camcorder as a Web Camera, the additional minimum requirements must be met.

Graphic display:

High Color (16 bit or more)
Desktop resolution of 800 × 600 pixels or more

Communication Speed:

56 kbps or faster is recommended.

Necessary software:

Windows Messenger 5.0/5.1 (Windows XP)
MSN Messenger 7.0/7.5 (Windows XP/2000)
DirectX 9.0b/9.0c (Windows XP SP1 (PV-GS59 Only))

*1 When your OS is Windows XP SP2, the USB Driver is not needed.

Other requirements (to send/receive audio):

Sound card
Speaker or headphones

To use the Camcorder as a Web Camera, the following conditions must be met.

- To upgrade Windows XP to SP1 (PV-GS59) / SP2 (PV-GS39) or later, click [Start] >> [All Programs] >> [Windows Update]. (Requires Internet connection.)
- To upgrade Windows 2000 to SP4 or later, click [Start] >> [All Programs] >> [Windows Update]. (Requires Internet connection.)
- You have direct dial-up connection capability to the Internet. Also, you and the other person(s) are in the same Network (LAN).
- Install Windows Messenger (Windows XP). If you have a version older than 5.0/5.1, download the latest version (5.0/5.1) from the Microsoft Home Page. The latest version of MSN Messenger can also be downloaded from the Microsoft Home Page. <http://www.microsoft.com/> (For download and installation instructions, please refer to Help on the Home Page.)
- If you are connected to the Internet through a firewall or a router, proper communication will not be possible.

Connecting the Camcorder to Personal Computer (For Using as a Web Camera)

- 1 Install the USB Driver. (pp. 57~58)**
- 2 Set the Camcorder to Tape Recording Mode or Tape Playback Mode.**

- To send the live camera picture to a PC, set the Camcorder to Tape Recording mode.
- To send pictures recorded on a tape to a PC, set the Camcorder to Tape Playback mode.

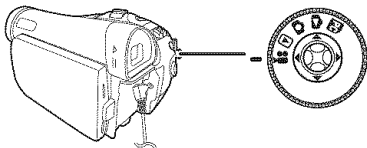

- 3 For PV-GS59 users :**
Tape Recording Mode :
 Set [ADVANCED] >> [USB FUNCTION] >> [WEB CAM].
Tape Playback Mode :
 Set [BASIC] >> [USB FUNCTION] >> [WEB CAM].

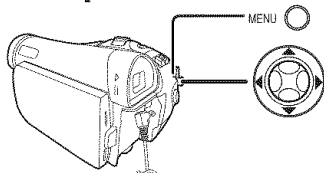

- 4 Connect the Camcorder to your personal computer with USB Cable.**

- The [] is displayed on the screen.

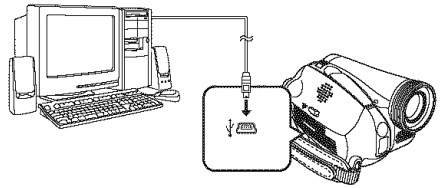

- When the Camcorder and personal computer (with Windows 2000) are connected via USB Cable, a message, such as the one below, is displayed. However, testing by the manufacturer has confirmed functionality of this Camcorder with Windows 2000. Click [Yes] and proceed.



- **When you use the Camcorder as a Web camera**

When you use the Camcorder as a Web camera in the Tape Playback Mode, the indication of the One-Touch Navigation icon is different from the one in usual operation.



- 1 In usual operation
 - 2 In the WEB CAMERA mode (Tape Playback Mode)
- Even if you move the Joystick Control [], the selected direction on the One-Touch Navigation icon is not lit in yellow.
 - The One-Touch Navigation icon blinks on instead of appearing from the side of the screen when you press the center of the Joystick Control.

- 5 Start the Windows Messenger (For Windows XP users) or MSN Messenger (For Windows 2000 users).**

- Click [Start] >> [All Programs (Program)] >> [Windows Messenger] or [MSN Messenger].

- When you use Windows XP, the other parties via the network have to use the Windows Messenger on Windows XP. When you use other than Windows XP, the other parties via the network have to use MSN Messenger on an OS other than Windows XP.
- If the Camcorder is used as a Web Camera, the quality of the video to be exchanged will depend on the Internet connection status.
- If the USB Cable is disconnected from the personal computer, the Web Camera mode is canceled.
- If the Camcorder is used as a Web Camera, video cannot be recorded onto a tape or a card.
- You cannot output the video input from the DV terminal to the display of the PC.
- In the Web Camera mode, the audio may be interrupted in the middle of communication depending on the communication environment or the performance of the personal computer.
- For Windows XP SP2 users, if the [Windows Security Alert] screen is displayed, click [Unblock] and proceed.

Setting up the Windows Messenger

When starting the Windows Messenger for the first time, its setup screen is displayed. (However, the screen is not displayed if the Windows Messenger setup has already been done.) For more details, please read the corresponding Help file.

- 1 Click [Click here to sign in].



- 2 Select [.NET Messaging Service] and click [OK].



- 3 Click [Next] when the [.NET Passport Wizard] dialog appears.

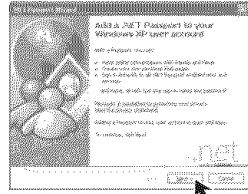

- 4 Please carefully read the displayed contents and then proceed.

- 5 After the setup is completed, sign in and start the Windows Messenger.

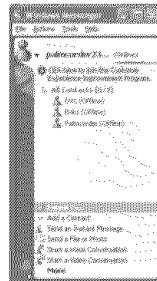

- 6 Click on [Audio Tuning Wizard...] in the [Tools] menu to confirm that equipment is connected correctly.

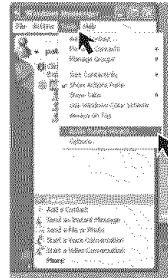

- 7 Select [USB Video Device] in the [Camera] menu.

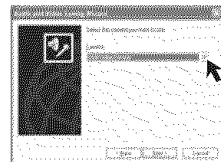

8 Select [DVC] in the [Microphone] menu.

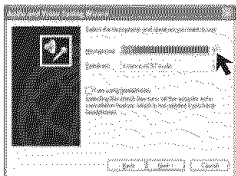

- For other information about Windows Messenger, please refer to Help.
- When access is finished, close Windows Messenger, then turn off the Camcorder. Finally, disconnect the USB cable.
- If the Camcorder is used as Web Camera continuously for two hours, the communication is automatically shut OFF. In this case, restart Windows Messenger and set up the communication again.

Setting up the MSN Messenger

When starting the MSN Messenger for the first time, its setup screen is displayed. (However, the screen is not displayed if the MSN Messenger setup has already been done.) For more details, please read the corresponding Help file.

■ In the case of MSN Messenger 7.0

1 Click [Sign In].

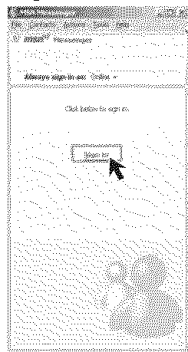

2 Type in your Sign-in name and password.

- If you do not have your Sign-in name and password, click [Get one here].

3 Please carefully read the displayed contents and then proceed.

4 After the setup is completed, sign in and start MSN Messenger.

5 Click on [Audio Tuning Wizard...] in the [Tools] menu to confirm that equipment is connected correctly.

6 Select the microphone attached to the PC in the [Microphone] menu.

7 Click [Web Camera Settings...] in the [Tools] menu.

8 Confirm that the [Panasonic DVC Web Camera Device] is selected.

■ In the case of MSN Messenger 7.5

1 Type in your E-mail address and password.

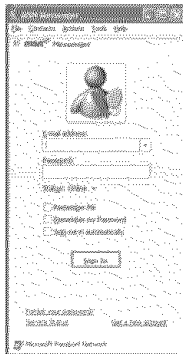

- If you do not have a password, click [Get a new account].

2 After setup is completed, sign in and start MSN Messenger.

3 Click [Audio and Video Setup] in the [Tools] menu and then click [Next].

4 Set up the speaker settings.

5 Select [DVC] in the microphone setup screen.

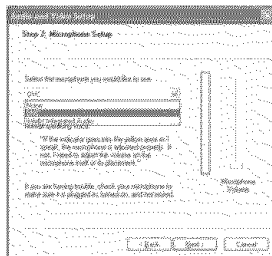

6 Select [USB Video Device] in the Webcam setup screen and then click [Finish].

- For other information about MSN Messenger, please refer to Help.
- When access is finished, close MSN Messenger, then turn off the Camcorder. Finally, disconnect the USB cable.

Using the Motion Picture Editing Software (PV-GS59 Only)

■ Quick Movie Magic

You can easily transfer recordings made with your Camcorder to a PC where you can enhance them with titles and music

- For advanced users who want to make more precise edits, MotionDV STUDIO offers convenient features.

The edited contents set with Quick Movie Magic can be opened in the MotionDV STUDIO where the recording can be made as desired.

■ MotionDV STUDIO

The Motion DV STUDIO is the software that allows videos to be captured from a video device, edited and outputted. Digital edition on a PC (Non-linear edit) enables you to create video works with minimum deterioration of image quality. You can also apply various special effects such as fade effects, transition effects and titles to videos.

Operating environment

The Camcorder can be connected to the personal computer with the DV Cable.

The Camcorder can be connected to the personal computer with the USB Cable, however, USB Driver must be installed.

- **Do not connect the USB Cable until the USB Driver is installed. (pp. 57~58)**
- USB Driver must be installed when you connect the Camcorder to the PC with the USB Cable and use Quick Movie Magic or MotionDV STUDIO.
- Despite having the Operating environment indicated, it may not be possible to use the program with some types of personal computers.
- When you connect to an USB 2.0 interface board, use a certified board with the USB 2.0 (HI-SPEED USB) logo.

OS:

IBM PC/AT compatible personal computer with pre-installed:

Microsoft Windows XP Home Edition/Professional SP2 or later

Microsoft Windows 2000 Professional SP4 or later

CPU:

Intel Pentium III 800 MHz or higher (including compatible CPU)

Graphic display:

High Color (16 bit) or more

(32 bit or more recommended)

Desktop resolution of 1 024 × 768 pixels or more (Supporting the overlay of DirectDraw)

4 MB or more video memory

(16 MB or more recommended)

Sound:

PCM sound source (Compatible Direct Sound)

RAM:

256 MB or more

(Adding more memory enables you to operate the personal computer more comfortably.)

Hard disk:

Ultra DMA – 33 or more

Free hard disk space:

640 MB

(When you capture video, 1 GB is needed for data of approx. 4 minutes.)

Interface:

DV (IEEE1394) terminal (IEEE1394.a)

USB 2.0 (Hi-Speed compliant) - A Type

DirectX 9.0b or later

Windows Media Player 6.4 or later

Other requirements:

Mouse

CD-ROM Drive

- This software is not compatible with a multi-CPU environment.
- This software is not compatible with a multi-boot environment.
- Operation on Microsoft Windows XP Media Center Edition, Tablet PC Edition and 64 bit operating system is not guaranteed.

Installation of Quick Movie Magic

1 Insert the supplied CD-ROM into the personal computer's CD-ROM drive.

- Quit all applications.
- The [Setup Menu] screen appears.

2 Click [Quick Movie Magic].

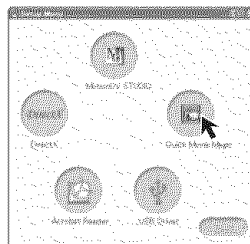

[PV-GS59: Supplied]

3 Click [Next].



- After reading the displayed contents, please carry out the installation according to instructions.

4 Select the Video system.

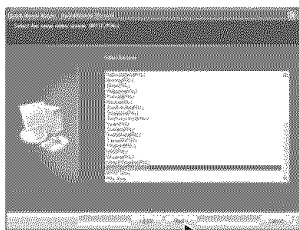

- The [Readme] screen is displayed. Please carefully read the displayed contents and close the [Readme] screen.

5 After the completion of setup, click on [Finish].

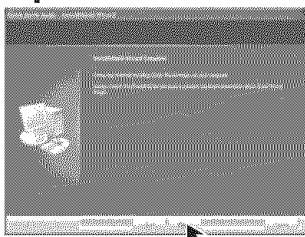

- Sample data is installed concurrently with the Quick Movie Magic software.

6 Click [Finish] when the [Restarting Windows] dialog appears.

- Reboot the computer to finish installing Quick Movie Magic.

Installation of MotionDV STUDIO

1 Insert the supplied CD-ROM into the personal computer's CD-ROM drive.

- Quit all applications.
- The [Setup Menu] screen appears.

2 Click [MotionDV STUDIO].

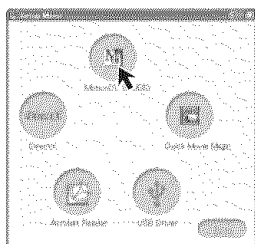

[PV-GS59: Supplied]

3 Click [Next].

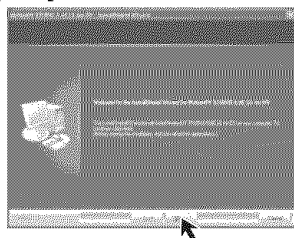

- After reading the displayed contents, please carry out the installation according to instructions.

4 Select the Video system.

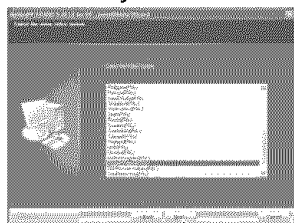

- The [Readme] screen is displayed. Please carefully read the displayed contents and close the [Readme] screen.

5 After the completion of setup, click on [Finish].

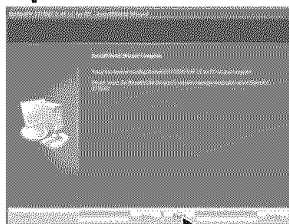

- Sample data is installed concurrently with the MotionDV STUDIO software.

6 Click [Finish] when the [Restarting Windows] dialog appears.

- Reboot the computer to finish installing MotionDV STUDIO.

To start Quick Movie Magic or MotionDV STUDIO

If you wish to capture data from a tape, set the Camcorder to Tape Playback Mode and insert the tape. If you wish to capture images from the lens of the Camcorder, set the Camcorder to the Tape Recording Mode and remove the tape and the card.

■ With USB (supplied)

OS:

Windows XP SP2 or later

Windows 2000 SP4 or later

- The personal computer should be compatible with USB 2.0 Hi-Speed.

Confirmation before connection

(For Windows XP/2000)

When you connect the personal computer and the Camcorder with the USB Cable and then use Quick Movie Magic or MotionDV STUDIO on Windows XP (SP2 or later) or Windows 2000 (SP4 or later), check the driver of the USB host controller.

- It is required to use the driver for which [Microsoft] is displayed on [Driver Provider] in [Driver] tab.

1 Select [Start] >> [Settings] >> [Control Panel] to start [System].

- [System Properties] is displayed.

2 Click [Hardware] tab and then click [Device Manager] then [Universal Serial Bus controllers].

3 Right-click [Enhanced Host Controller] and then select [Properties].



- The indication [Enhanced Host Controller] is changed as [EHCI] depending on the host controller you use.

4 Click [Driver] tab to check the description on [Driver Provider].



- If [Microsoft] is displayed on [Driver Provider], the confirmation procedure is completed.

If a description other than [Microsoft] is displayed

- Update the driver with the following procedure.

1 Click [Update Driver...].

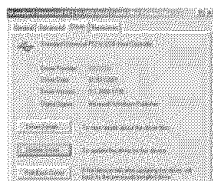

2 Check [Install from a list or specific location (Advanced)] and then click [Next].



- When your OS is Windows 2000, click [Next] after [Update Device Driver Wizard] appears.

3 For Windows XP Users: Check [Don't search. I will choose the driver to install] and then click [Next].

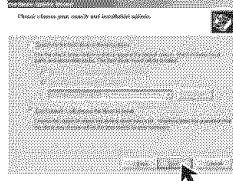

For Windows 2000 Users: Check [Display a list of the known drivers for this device so that I can choose a specific driver] and then click [Next].



4 Click [Standard Universal PCI to USB Host Controller] and then click [Next].





5 Click [Finish].

- The update of the driver is completed. Connect the Camcorder.

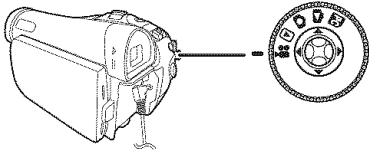
Connecting the Camcorder to a personal computer

- 1 Set the Camcorder to Tape Recording Mode or Tape Playback Mode.



- 2 Set [ BASIC] or [ ADVANCED] >> [ USB FUNCTION] >> [ MOTION DV].

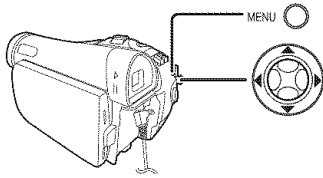

- It enters MotionDV STUDIO (Quick Movie Magic) Mode.

- 3 Connect the Camcorder to your personal computer with USB Cable.

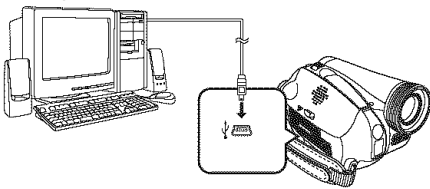

- 4 To start Quick Movie Magic: Select [Start] >> [All Programs (Programs)] >> [Panasonic] >> [Quick Movie Magic 1.0E] >> [Quick Movie Magic].

To start MotionDV STUDIO:

Select [Start] >> [All Programs (Programs)] >> [Panasonic] >> [MotionDV STUDIO 5.6E LE for DV] >> [MotionDV STUDIO LE for DV].

- Using the Quick Movie Magic or MotionDV STUDIO for Windows, a variety of visual effects can be added and titles can be created.
- You cannot record a video edited by the PC onto the Tape in the Camcorder.

■ With DV Cable (optional)

OS:

Windows 2000/XP

- 1 Set the Mode Dial to Tape Recording Mode or Tape Playback Mode.

- 2 Connect the Camcorder to the personal computer with DV Cable.

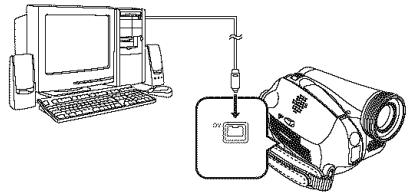

- 3 Start Quick Movie Magic or MotionDV STUDIO LE for DV.

- You can record the video edited by the PC onto the Tape in the Camcorder.
- When 2 or more USB devices are connected to a personal computer, or when devices are connected through USB hubs or by using extension cables, proper operation is not guaranteed.
- When connected to the keyboard USB terminal, normal function may not be possible.

If you no longer need software or driver (Uninstall)

■ For Windows

The screens may vary with the type of the OS.

- 1 Select [Start] >> [Settings] >> [Control Panel], select the software or the driver from [Add/Remove Programs] to uninstall.

- Uninstalling steps may vary depending on the OS. Please refer to the user manual of your OS.

- 2 After software or driver is uninstalled, please restart your computer.

Transferring Motion DV Tape Pictures (Camcorder → Macintosh) via DV Cable (iMovie / iMovie HD)

By connecting the Camcorder and Macintosh with the DV Cable, you can transfer motion pictures saved on a DV Tape directly to your Macintosh.

- iMovie HD, included with any new Macintosh or sold with iLife.

■ For Macintosh

OS:

Mac OS X v 10.3 - X v 10.4

- 1 Set the Camcorder to Tape Playback Mode.

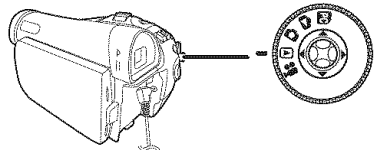

2 Connect the Camcorder to your Macintosh with the DV Cable.

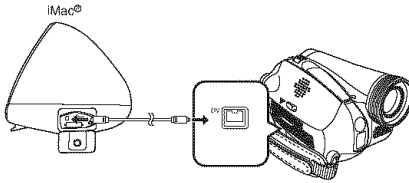

3 Click the [ iMovie HD] icon.



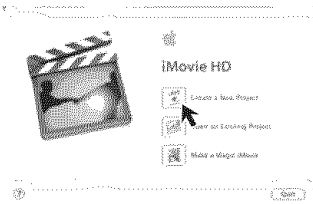

4 Click [Create a New Project].

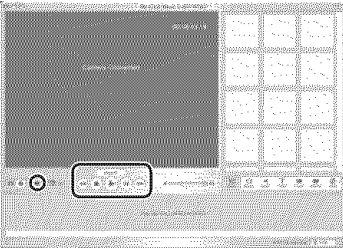

5 Click [Create] in the [Create Project] screen and select a folder in which to save the motion pictures.

- "Camera connected" is displayed.
- Confirm the [] is selected.



6 Click [] to playback the tape.

7 Click [Import] to capture the motion pictures you wish to save.

- For more information about iMovie HD, please refer to Help.

For more information, please contact Apple at <http://www.apple.com>

Notes

- Macintosh and iMovie HD from Apple are the registered trademark of Apple Computer, Inc.
- Microsoft® Windows®, Windows Messenger®, MSN Messenger® and DirectX® are either trademarks or registered trademarks of the Microsoft Corporation in the United States and/or other countries.
- Intel®, Pentium® and Celeron® are the registered trademarks or trademarks of the Intel Corporation.
- All other names, company names, product names, etc. in these instructions are the trademarks or registered trademarks of their respective corporations.
- The names of the products you are using may differ from the names given in the text. Depending on the operating environment and other factors, the contents of the screens used in these instructions may not necessarily match what you will see on your screen.
- Although the screens in these Operating Instructions are shown in English for the sake of example, other languages are supported as well.
- In this Manual, the Panasonic make digital video camera with USB Jack is referred to as Camcorder.
- These instructions do not cover the basic operations of the personal computer or define any terms. For this information, refer to the Operating Instructions which accompany your personal computer.
- Do not disconnect USB Cable while the operation light of Camcorder is on. It may freeze the software or destroy the data in transfer.
- We recommend using the AC adaptor as the power source for the Camcorder when connecting to the personal computer. Data may be lost if the battery power is lost while transferring data.
- If the Camcorder is used as a Web Camera while virus checking software is running, the Camcorder's operation may stop midway through. In this case, exit the Windows Messenger or MSN Messenger, reconnect the Camcorder and restart the Windows Messenger or MSN Messenger.
- Do not delete the folders in the memory card such as picture folder. Memory card may not be recognized if folders are deleted.
- When the Camcorder is switched to the PC Mode while it is connected to the personal computer, the operation mode of the Camcorder cannot be switched. In this case, disconnect the USB Connection Cable. Switch the operation mode of the Camcorder and reconnect the Cable.
- When the Tape Recording Mode of the Camcorder is switched to the PC Mode, a warning message may be displayed. You may simply ignore it.
- When you are using Windows XP or Windows 2000, you may install or uninstall this software after logging ON by setting the user name to Administrator or to a user name having equivalent authority.

- If you install the USB Driver after the USB Cable is connected, or if you do not follow these Operating Instructions, the Camcorder will not be recognized correctly. In this case, delete the USB Driver from [Device Manager] as described below, uninstall the USB Driver, and re-install it.

- With the Camcorder and personal computer connected via a USB Cable, open the [Device Manager]. Right-click [IDVC] ❶ in [Ports] or [Other devices], and select [Uninstall]. ([IDVC] ❶ will differ depending on the OS or operating environment of your personal computer.)

(For Windows)

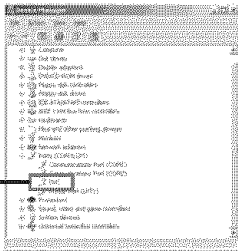

About the SD Memory Card

SD Memory Card (Optional)

The SD Memory Card is an external Memory Card that is available in larger capacities. It has a write protect switch to prevent data writing and card formatting, as well as a copyright protection function.

- SD Logo is a trademark.
- All other company and product names in the operating instructions are trademarks or registered trademarks of their respective corporations.

Files recorded on an SD Memory Card

It may not be possible to play back the files on this Camcorder recorded on and created by other equipment or vice versa. For this reason, check the compatibility of the equipment in advance.

About the compatibility of the card files

Data files recorded on an "SD Memory Card" by this Camcorder conform with DCF (Design rule for Camera File system) established by JEITA (Japan Electronics and Information Technology Industries Association).

- If you attempt to play back files recorded with this Camcorder on other equipment or to play back files recorded with other equipment on this Camcorder, you may not be able to play them back. Please check the compatibility with the other equipment in advance.

About the folder structure when using the Memory Card in a personal computer

- When a Card with data recorded on it is inserted into a personal computer, folders will be displayed as shown in the following figure.

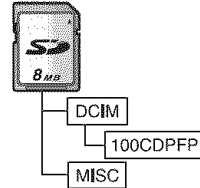

[100CDPFP]:

The images (IMGA0001.JPG, etc.) in this folder are recorded in the JPEG format.

[MISC]:

Files in which DPOF Data has been set to the image are in this folder.

- [DCIM], etc. are necessary items in the folder structure. They have nothing to do with actual operation.
- In the Card Mode, the Camcorder automatically saves file numbers (IMGA0001.JPG, etc.) along with the images. The file numbers are recorded with each image as consecutive numbers.
- When using software without an indication function, indication data, such as date, are not displayed. Depending on the software in use, the date and the time may not be displayed correctly.
- The memory capacity indicated on the SD Card label corresponds to the total card capacity. Some of this capacity is used to protect and manage the copyright data, and not all capacity is available as a conventional memory for a Camcorder, Personal Computer or others.

Others

Indications

Various functions and the Camcorder status are shown on the screen.

Basic indications:

: Remaining battery power

0h00m00s00f: Time code

12:34:56PM: Date/Time indication

Recording indications:

R0:45: Remaining tape time

- Remaining tape time is indicated in minutes.
(When it reaches less than 3 minutes, the indication starts flashing.)

: Tape Recording Mode (p. 30)

: Tape Playback Mode (p. 45)

: Card Recording Mode (p. 32)

: Picture Playback Mode (p. 47)

: PC Mode (pp. 58~59)

SP : Standard Play Mode (Recording Speed Mode) (p. 29)

LP : Long Play Mode (Recording Speed Mode) (p. 29)

: Automatic Mode (p. 30)

: Manual Mode (pp. 40~44)

: Image Stabilizer (p. 36)

12 bit, 16 bit : Audio Recording Mode (p. 28)

MF: Manual Focus (p. 44)

: Back Light Mode (p. 37)

: Sports Mode (Scene Mode) (p. 40)

: Portrait Mode (Scene Mode) (p. 40)

: Low Light Mode (Scene Mode) (p. 40)

: Spotlight Mode (Scene Mode) (p. 40)

: Surf & Snow Mode (Scene Mode) (p. 40)

• : Recording (p. 30)

|| (Green) : Recording Pause (p. 30)

|| (Green Flash) : Standby Mode

|| : Still Playback (p. 47)

: Self-Timer Recording (p. 35)

: Playback (p. 45)

: Fast-forward/Cue Playback (p. 46)

: Rewind/Review Playback (p. 46)

: Slow Motion Playback (p. 46)

: Still Advance Playback (p. 47)

: Recording Check (p. 31)

: Audio Dubbing (p. 53)

: Audio Dubbing Pause (p. 53)

: Blank Search (p. 31)

: Repeat Playback (p. 45)

: Variable Speed Search (p. 46)

1/500 : Shutter Speed (pp. 42~43)

: Slide Show Playback (p. 48)

F2.4 : F Number (p. 43)

6dB : Gain Value (p. 43)

W : Fade (White) (p. 37)

B : Fade (Black) (p. 37)

: Auto White Balance (p. 41)

: White Balance Adjustment Mode (pp. 41~42)

* : Outdoor Mode (p. 41)

☀ : Indoor Mode (recording under incandescent lamp) (p. 41)

: MagicPix Function (p. 38)

: Zoom Microphone (p. 35)

: Wind Noise Reduction (p. 39)

: Soft Skin Mode (p. 38)

: Volume adjustment (p. 45)

12:34:56AM: Date/Time Indication (p. 28)

: Photoshot Picture Quality (p. 32)

0 : Remaining Number of Photoshot pictures (When the remaining number of Photoshot pictures reaches 0, the red indication flashes.)

100-0001 : Folder/File Display

No. 00 : File Number

1 : Number of DPOF Setting (p. 50)

: RapidFire Consecutive Photoshot Recording (p. 33)

: Lock Setting (p. 50)

: LED Video Light is on. (pp. 33~34)

: Gain up (pp. 33~34)

: Web Camera Mode (p. 61)

: Wide Mode (p. 39)

: [640 × 480] Image size

: [640 × 320] Image size

- For images not recorded with this Camcorder, the size display is determined as follows according to the number of horizontal pixels.

(White): Photoshot Mode

(Red): While Photoshot recording is activated







(Green): While the Card being read

(Red): Using a card that cannot be reorganized



Warning/Alarm Indications

If any one of the following indications lights up or flashes, please check the Camcorder.

Confirmatory Indications

-  : A cassette with the accidental erasure prevention slider placed in the [SAVE] position is inserted.
No cassette is inserted.
- [--] /  : The built-in battery is low. (p. 21)
-  : The Warning/Alarm Indication appears when you record yourself. Turn the LCD Monitor towards the Viewfinder and check the Warning/Alarm Indication.
-  : No card is inserted.
- REMOTE: An incorrect Remote Control mode has been selected. (p. 15)
-  END : The tape came to the end during recording.
-  : The video heads are dirty. (p. 73)

Textual Indications

-  DEW DETECT /  EJECT TAPE:
Condensation has occurred. Take out the cassette and wait for a while. It takes some time until the cassette holder opens, but this is not a malfunction. (p. 73)
- TAPE END:
The tape came to the end during recording.
- NEED HEAD CLEANING:
The video heads are dirty. (p. 73)
- PUSH THE RESET SWITCH:
An irregularity in the equipment has been detected. Press the [RESET] Button (p. 78). This may solve the problem.
- LOW BATTERY:
The Battery is low. Recharge it. (p. 15)
- NO TAPE:
No tape is inserted. (p. 18)
- CHECK REMOTE MODE:
An incorrect Remote Control Mode has been selected. This is only displayed at the first operation of the Remote Control after powering-on. (p. 15)
- CHECK REC TAB:
You are attempting to record pictures on a tape with the accidental erasure prevention slider placed in the [SAVE] position.
You are attempting Audio Dubbing or Digital Dubbing on a tape with the accidental erasure prevention slider placed in the [SAVE] position.
- WRONG TAPE FORMAT:
You are attempting to play back a tape section that has been recorded with a different TV system. This cassette is incompatible.

CLOSE CASSETTE DOOR:

The cassette cover is open. Close the cassette cover. (pp. 18~19)

UNABLE TO A.DUB (LP RECORDED):

Because the original recording was in LP Mode, audio dubbing cannot be performed.

UNABLE TO A.DUB:

You are attempting to perform audio dubbing on a non-recorded tape.

COPY PROTECTED:

Images cannot be recorded correctly because the medium is protected by a copy guard.

CARD ERROR:

The Card is not compatible with this Camcorder. You are attempting to format a failed card. It displays, when you attempt to insert the incompatible card to Card Slot.

NO CARD:

No card is inserted.

CARD FULL:

Card does not have sufficient memory remaining.
Select Picture Playback Mode and delete unnecessary files.

NO DATA:

There are no recorded files on the card.

UNPLAYABLE CARD:

You are attempting to play back data not compatible with this Camcorder.

FILE LOCKED:

You are attempting to erase protected files.

CARD LOCKED:

The write protection switch on the SD Memory Card is set to [LOCK].

CHANGE MODE TO USE USB:

The USB Cable is connected to the Camcorder in Card Recording Mode.

CANCEL MAGICPIX MODE:

You are attempting to select an item other than [OFF] in [SCN SCENE MODE] during MagicPix Mode.

DISCONNECT USB CABLE:

You are attempting to turn the Mode Dial in PC Mode with the USB Cable connected to the Camcorder.

You are attempting to record pictures on a Tape/Card with the USB Cable connected to the Camcorder.

PC DOES NOT SUPPORT USB2.0:

The Camcorder is connected to a personal computer that does not support USB2.0.

CAN NOT USE USB:

You are connecting the USB Cable with the DV Cable connected in MotionDV Mode.

CHANGE TO MANUAL MODE:

You are attempting to select an item other than [OFF] in [**SCN** SCENE MODE] when the [AUTO/MANUAL/FOCUS] Switch is set to [AUTO].

CAN NOT OPERATE

(MOTION DV MODE) (PV-GS59 Only):

You are attempting to change [**D.ZOOM**] setting during MotionDV Mode.

TURN OFF THE VIDEO LIGHT:

You are attempting to select an item in [**SCN** SCENE MODE] when Light is on.

REVERSE THE LCD MONITOR:

When the LCD Monitor is rotated by 180° towards the lens, the brightness of the LCD Monitor cannot be adjusted.

Cautions for Use

■ After Use

- 1 Take out the Cassette. (pp. 18~19)
- 2 Set the [OFF/ON] Switch to [OFF].
- 3 Take out the Card. (pp. 19~20)
- 4 Detach the power supply and retract the Viewfinder or the LCD Monitor. (pp. 21~22)
- 5 To protect the Lens, attach the supplied Lens Cap.

■ Cautions for Use

When you use your Camcorder on a rainy or snowy day or on a beach, make sure that no water enters the Camcorder.

- Water may cause the Camcorder or Cassette to malfunction. (Irreparable failure may occur.)
- If sea water splashes onto the Camcorder, wet a soft cloth with tap water, wring it well, and use it to wipe the camera body carefully. Then, wipe it again thoroughly with a soft dry cloth.

Keep the Camcorder away from magnetized equipment (such as a microwave oven, TV, video game equipment, etc.).

- If you use the Camcorder on or near a TV, images or sounds may be disturbed due to electromagnetic wave radiation.
- Do not use near a cell phone because doing so may cause noise to adversely affect the picture and sound.
- Recordings on the tape may be damaged, or images may be distorted, by strong magnetic fields created by speakers or large motors.
- Electromagnetic wave radiation generated by a microprocessor may adversely affect the Camcorder, causing the disturbance of images and sounds.

- If the Camcorder is affected by magnetically charged equipment and does not function properly, turn off the Camcorder power and detach the Battery or AC Adaptor and then connect the Battery or AC Adaptor again. Thereafter, turn on the Camcorder power.

Do not use your Camcorder near radio transmitters or high-voltage cables.

- If you record pictures near radio transmitters or high-voltage cables, recorded images or sounds may be adversely affected.

Do not use this Camcorder for surveillance purposes or other business use.

- If you use the Camcorder for a long period of time, the internal temperature increases and, consequently, this may cause malfunction.
- This Camcorder is not intended for business use.

When you use your Camcorder on a beach or similar place, do not let sand or fine dust get into the Camcorder.

- Sand or dust may damage the Camcorder or Cassette. (Care should be taken when inserting and removing the Cassette.)

Do not spray insecticides or volatile chemicals onto the Camcorder.

- If the Camcorder is sprayed with such chemicals, the camera body may be deformed and the surface finish may peel off.
- Do not keep rubber or plastic products in contact with the Camcorder for a long period of time.

Do not use benzine, thinner or alcohol for cleaning the Camcorder.

- The Camcorder body may be deformed and the surface finish may peel off.
- Before cleaning, detach the Battery or pull out the AC Cable from the AC Jack.
- Wipe the Camcorder with a soft dry cloth. To remove stubborn stains, wipe with a cloth that is soaked in a detergent diluted with water and afterwards finish wiping with a dry cloth.
- For storing or transporting the Camcorder, place it in a bag or case lined with soft pads so as to prevent the coating on the camera body from being worn.



After use, be sure to take the Cassette out and detach the Battery from the Camcorder or pull out the AC Cable from AC Jack.

- If the Cassette is left in the Camcorder, the tape sags and deteriorates.
- If the Battery is left on the Camcorder for a long time, the voltage drops excessively, and the Battery will not function even after it is recharged.

■ About AC Adaptor

- If the temperature of the Battery is extremely high or extremely low, the [CHARGE] Lamp may continue flashing, and the Battery may not be charged. After the temperature of the Battery has decreased or increased sufficiently, charging starts automatically. If the [CHARGE] Lamp continues to flash even after the Battery temperature has decreased or increased sufficiently, the Battery or AC Adaptor may be faulty. In this case, please contact a dealer.
- If the Battery is warm, charging takes a longer time than normal.
- If you use the AC Adaptor near a radio, radio reception may be disturbed. Keep the AC Adaptor 3 feet (1 meter) or more away from radio.
- When using the AC Adaptor, it may generate whirring sounds. However, this is normal.
- After use, be sure to pull out the AC Cable from the AC Jack. (If they are left connected, a minute amount of current is consumed.)
- Always keep the electrodes of the AC Adaptor and Battery clean.

■ Condensation

If you turn the Camcorder on when condensation occurs on the head or the tape, Condensation Indication [] is displayed on the Viewfinder or the LCD Monitor and the messages [ DEW DETECT] or [ EJECT TAPE] (only when the tape is inserted) appear. In this case, follow the procedure below.

- 1 Remove the tape if it is inserted.**
 - It takes about 20 seconds to open the Cassette Holder. This is not a malfunction.
- 2 Leave the Camcorder with the Cassette Compartment Cover closed to cool or warm it to the ambient temperature.**
- 3 Turn the Camcorder on again, set it to the Tape Recording/Playback Mode and then check if the condensation indication disappears.**

Especially in cold conditions, dew may be frozen. In this case, it may take more time before the condensation indication disappears.

Watch for Condensation even before the Condensation Indication is displayed.

- The condensation indication may not appear depending on circumstances. When condensation occurs on the lens or the Camcorder, it also may occur on the head and the tape. Do not open the Cassette Compartment Cover.

When the Lens Is Fogged:

Set the [OFF/ON] Switch to [OFF] and leave the Camcorder in this condition for about 1 hour. When the lens temperature becomes close to the ambient temperature, the fog disappears naturally.

■ Video Head Clogging and Care

If the heads (the parts that make contact with the tape) are dirty, mosaic-pattern noise may appear on the playback image, or the screen as a whole becomes black. If the heads are extremely dirty, recording performance deteriorates, and, in the worst case, the Camcorder cannot record at all.

Causes of Dirty Heads

- Large quantity of dust in the air
- High-temperature and high-humidity environment
- Damaged tape
- Long operating hours

Using Panasonic cleaning cassette (AY-DVMCLA)

- 1 Set the Mode Dial to Tape Playback Mode.**
 - The One-Touch Navigation icon is displayed on the lower right of the screen.
- 2 Insert the Head Cleaner into the Camcorder in the same manner as a Video Cassette.**
- 3 Move the Joystick Control [▲], and approximately 15 seconds later, move the Joystick Control [▼]. (Do not rewind the tape.)**
- 4 Take out the Head Cleaner. Insert a Video Cassette and start recording. Then, play the tape back to check the recorded image.**
- 5 If the image is not still clear, repeat Steps 1 to 4. (Do not use the Head Cleaner 3 times or more consecutively.)**



Notes:

- Do not rewind every time you use the Head Cleaner. Rewind only when the tape reaches the end, and then use it again from the beginning in the same manner as before.
- If the heads become dirty soon after cleaning, the tape may be damaged. In this case, immediately stop using that Cassette.
- Do not clean the heads excessively. (Excessive cleaning may cause excessive wear of the heads. If the heads are worn, images cannot be played back even after the heads are cleaned.)
- If the dirty heads cannot be cleaned with the Head Cleaner, the Camcorder needs to be cleaned at a Servicenter. Please consult a dealer.
- Head cleaning due to dirty heads is not considered a malfunction of the product. It is not covered by the warranty.

Periodical Check-up

To maintain the highest image quality, we recommend replacement of worn parts, such as heads, etc., after approximately 1000 hours of use. (This, however, depends on operating conditions, such as temperature, humidity, dust, etc.)

■ Optimal Use of the Battery

Battery Characteristics

This Battery is a rechargeable lithium ion battery. Its ability to generate power is based upon the chemical reaction that takes place inside it. This reaction is susceptible to the surrounding temperature and humidity, and, if the temperature is too high or too low, the operating time of the Battery becomes shorter. If the Battery is used in an extremely cold environment, the Battery may operate only for about 5 minutes. If the Battery becomes extremely hot, a protective function may operate, and the Battery may become unusable for a while.

Be Sure to Detach the Battery after Use

Be sure to detach the Battery from the Camcorder. (If it is left attached to the Camcorder, a minute amount of current is consumed even when the Camcorder power is off.) If the Battery is left attached to the Camcorder for a long time, over-discharge takes place. The Battery may become unusable after it is charged.

Disposing of an Unusable Battery

- The Battery has a limited life.
- Do not throw the Battery into fire because it may cause an explosion.

Always Keep the Terminals of the Battery Clean

Prevent the terminals from getting clogged with dirt, dust, or other substances. If you drop the Battery accidentally, check to see if the Battery body and terminals are deformed. Attaching a deformed Battery to the Camcorder or AC Adaptor may damage the Camcorder or AC Adaptor.

■ Cautions for Storage

Before storing the Camcorder, take the Cassette out and detach the Battery.

Store all the components in a dry place with a relatively stable temperature.

(Recommended Temperature: 15 °C to 25 °C (59 °F to 77 °F), Recommended Humidity: 40 % to 60 %)

Camcorder

- Wrap it with a soft cloth to prevent dust from getting into the Camera.
- Do not leave the Camcorder in places that expose it to high temperature.

Battery

- Extremely high temperatures or low temperatures will shorten the life of the Battery.
- If the Battery is kept in smoky or dusty places, the terminals may rust and cause malfunctions.
- **Do not allow the Battery terminals to come in contact with metal objects (such as necklaces, hairpins, etc.). This can result in a short circuit or heat generation and, if you touch the Battery in this condition, you may be badly burned.**

- Store the Battery in a completely discharged state. To store the Battery for a long period of time, we recommend you charge it once every year and store it again after you completely use up the charged capacity.

Cassette

- Before storing it, rewind the tape to the beginning. If the Cassette is left for more than 6 months with the tape stopped midway, the tape sags (although it depends on the storage condition). Be sure to rewind to the beginning.
- Store the Cassette in its case. Dust, direct sunlight (ultraviolet rays), or humidity may damage the tape. Dust contains hard mineral particles, and dusty Cassettes damage the heads of the Camcorder and other components. Develop a habit of returning the Cassette back to its case.
- Once every half year, wind the tape to the end and then rewind it to the beginning. If the Cassette is left for 1 year or longer without winding or rewinding, temperature and humidity changes may cause the Cassette to deform due to swelling, shrinking, and so forth. The wound tape may stick to itself.
- Do not place a Cassette near highly magnetic substances or equipment.
- The surface of tape is covered with extremely minute magnetic particles, upon which signals are recorded. Magnetic necklaces, toys, etc., have magnetic force that is stronger than you may normally expect, and they may erase the contents of a recording or may cause noise in images and sounds.

Card

- When the Card is being read, do not remove the Card, turn off the power, or subject it to vibration or impact.
- Do not leave the Card in places where there is high temperature or direct sunlight, or where electromagnetic waves or static electricity are easily generated.
- Do not bend or drop the Card. The Card or the recorded content may be damaged.
- After use, be sure to remove the Card from the Camcorder.
- After usage, store the supplied SD Memory Card in the enclosed bag.
- Do not touch the terminals on the back of the Card with your fingers. Do not allow dirt, dust or water to enter it.
- Keep the Memory Card out of reach of children to prevent swallowing.

■ LCD Monitor/Viewfinder/Lens Hood

LCD Monitor

- In a place with drastic temperature changes, condensation may form on the LCD Monitor. Wipe it with a soft dry cloth.
- If your Camcorder is extremely cold when you turn its power on, the image on the LCD Monitor is slightly darker than usual at first. However, as the internal temperature increases, it goes back to the normal brightness.

Extremely high precision technology is employed to produce the LCD Monitor screen featuring a total of approximately 105,000 pixels (PV-GS29) / 112,000 pixels (PV-GS39/PV-GS59). The result is more than 99.99 % effective pixels with a mere 0.01 % of the pixels inactive or always lit. However, this is not a malfunction and does not affect the recorded picture.

Viewfinder

- Do not direct the Viewfinder or Lens to the sun. Internal components may be seriously damaged.
- When the Camcorder is used with a large capacity Battery attached to it, it is not practical to look in the Viewfinder from behind the Battery.

Extremely high precision technology is employed to produce the Viewfinder screen featuring a total of approximately 113,000 pixels. The result is more than 99.99 % effective pixels with a mere 0.01 % of the pixels inactive or always lit. However, this is not a malfunction and does not affect the recorded picture.

Lens Hood

- When you wish to attach the Tele Conversion Lens (not supplied), Wide Conversion Lens (not supplied), MC Protector (not supplied), or ND Filter (not supplied), rotate these in a clockwise direction.
- If you push the [W/T] Lever toward [W] during recording with the filter and conversion lens attached to the Camcorder, 4 corners of the image may become dark (vignetting). For details, please refer to the operating instructions of your accessories.

Before Requesting Service (Problems and Solutions)

Power/Body

The Camcorder power cannot be turned on.

- Is the battery fully charged? Use a fully charged battery.
- The battery protection circuit may have operated. Attach the battery to the AC adaptor for 5 to 10 seconds. If the Camcorder still cannot be used, the battery is faulty.
- Is the LCD Monitor or the Viewfinder open?

The Camcorder power is turned off automatically.

- If you set [α^2 POWER SAVE] to [5 MINUTES] and do not operate the Camcorder for about 5 continuous minutes, the power is automatically turned off for tape protection and power conservation. To resume recording, turn the [OFF/ON] switch to [OFF]. Then turn it to [ON] again. (p. 29) Also, if you set [α^2 POWER SAVE] to [OFF], the power does not automatically turn off.

The Camcorder power does not stay on long enough.

- Is the battery low? If the remaining battery power indication is flashing or the message [LOW BATTERY] is displayed, the battery has run down. Charge the battery or attach a fully charged battery. (p. 15)
- Has condensation occurred? When you carry the Camcorder from a cold place into a warm place, condensation may occur inside it. If so, the power is turned off automatically, disabling all operations except for taking cassettes out. Wait until the condensation indication disappears. (p. 73)

Battery runs down quickly.

- Is the battery fully charged? Charge it with the AC adaptor. (p. 15)
- Are you using the battery in an extremely cold place? The battery is affected by ambient temperature. In cold places, the operating time of the battery becomes shorter.
- Has the battery worn out? The battery has a limited life. If the operating time is still too short even after the battery is fully charged, depending on the usage, the battery has worn out and can no longer be used.

The Camcorder cannot be operated though powered up.

The Camcorder does not operate normally.

- The Camcorder cannot be operated unless you open the LCD Monitor or extend the Viewfinder.
- Remove the cassette and then press the [RESET] button. (p. 78) If normal conditions are not restored yet, turn off the power. Then, about 1 minute later, turn on the power again. (Conducting the above operation when the Access Lamp is on may destroy the data on the card.)

The cassette cannot be removed.

- Does the power lamp comes on when opening the cassette cover? (p. 18) Make sure that the battery and the AC adaptor are properly connected. (p. 15)
- Is the battery in use discharged? Charge the battery and remove the cassette.
- Close the cassette cover completely, and fully open it again. (p. 18)

No operation other than cassette removal can be performed.

- Has condensation occurred? Wait until the condensation indication disappears. (p. 73)

The Remote Control does not function (PV-GS59 Only).

- Has the button-type battery of the Remote Control run out? Replace it with a new button-type battery. (p. 14)
- Is the setting on the Remote Control correct? If the setting on the Remote Control is not in agreement with the [REMOTE] setting on the Camcorder, the Remote Control does not operate. (p. 15)

Recording

Recording does not start although power is supplied to the Camcorder and the cassette is correctly inserted.

- Is the accidental erasure prevention slider on the cassette open? If it is open (set to [SAVE]), recording cannot be performed. (p. 19)
- Is the tape wound to the end? Insert a new cassette.
- Is the Recording Mode set? When in the Playback Mode, recording cannot be performed. (p. 30)
- Has condensation occurred? No operation other than cassette removal can be performed when condensation occurs. Wait until the condensation indication disappears. (p. 73)
- Is the cassette cover open? If the cover is open, the Camcorder may not operate normally. Close the cassette cover. (p. 18)

The screen has changed suddenly.

- Has the demonstration started? In the Tape Recording mode, if you set [DEMO MODE] >> [ON] without inserting a cassette or a card, the demonstration starts. For normal use, set this function to [OFF]. (p. 29)

A cassette cannot be inserted.

- Has condensation occurred? Wait until the condensation indication disappears.

Auto focus function does not work.

- Is manual focus mode selected? If auto focus mode is selected, focus is automatically adjusted.
- There are some recording subjects and surroundings for which the auto focus does not operate correctly. (p. 79) If so, use the manual focus mode to adjust the focus. (p. 44)
- Is the MagicPix function set? When the MagicPix function is working, focusing shifts into the manual mode.

Indications

A sentence is displayed in red or yellow in the screen center.

- Read the contents and respond to them. (pp. 71~72)

The time code becomes inaccurate.

- The time code indication counter may not be constant in the reversed slow-motion playback, but this is not a malfunction.

The remaining tape time indication disappears.

- The remaining tape time indication may disappear temporarily during Still Advance Playback or other operation. If you continue ordinary recording or playback, the indication is restored.

The remaining tape time Indication does not match the actual remaining tape time.

- If scenes of less than 15 seconds are continuously recorded, the remaining tape time cannot be correctly displayed.
- In some cases, the remaining tape time indication may show remaining tape time that is 2 to 3 minutes shorter than the actual remaining tape time.

A function indication such as mode indication, remaining tape time indication, or time code indication is not shown.

- If you set [SETUP] >> [DISPLAY] >> [OFF], indications other than the tape running condition, warning, and date indications disappear.

Playback (Sound)

Sound is not played back from the built-in speaker of the Camcorder.

- Is the volume too low? During playback, push the [- M / VOL +] lever to display the volume indication and adjust it. (p. 45)

Different sounds are reproduced at the same time.

- Have you set [F SETUP] >> [12bit AUDIO] >> [MIX]? If you set [M AUDIO REC] >> [12bit] and dub audio to a recorded tape, you can hear the sound on recording and the sound dubbed at a later time. To hear the sounds separately, set to [ST1] or [ST2]. (p. 53)
- Have you set [F SETUP] >> [M AUDIO OUT] >> [STEREO] and reproduced a picture containing the main sound and sub sound? Set to [L] to hear main sound, and set to [R] to hear the sub sound. (p. 29)

Audio dubbing cannot be performed (PV-GS59 Only).

- Is the accidental erasure prevention slider on the cassette open? If it is open (set to [SAVE]), audio dubbing cannot be performed. (p. 19)
- Are you attempting to edit a tape portion that was recorded in LP mode? LP mode does not allow audio dubbing. (p. 29)

The original sound was erased when audio dubbing was performed (PV-GS59 Only).

- If you perform audio dubbing on a recording made in [16bit] mode, the original sound will be erased. If you wish to preserve the original sound, be sure to select [12bit] mode when recording.

Sounds cannot be played back.

- Although a cassette with no audio dubbing is being played, have you set [F SETUP] >> [12bit AUDIO] >> [ST2]? To play back a cassette with no audio dubbing, set [12bit AUDIO] >> [ST1]. (PV-GS59 Only) (p. 53)
- Is the variable speed search function activated? Press the [VER SEARCH] button on the Remote Control to cancel the variable speed search function. (PV-GS59 Only) (p. 46)

Playback (Pictures)

Mosaic-pattern noise appears on images during cue or review playback.

- This phenomenon is characteristic of digital video systems. It is not a malfunction.

Horizontal stripes appear on images during cue and review playback.

- Horizontal stripes may appear depending on the scene, but this is not a malfunction.

Although the Camcorder is correctly connected to a TV, playback images cannot be seen.

- Have you selected video input on the TV? Please read the operating instructions of your TV and select the channel that matches the input terminals used for the connection.

Playback picture is not clear.

- Are the heads of the Camcorder dirty? If the heads are dirty, playback image cannot be clear. Clean the heads by using the head cleaner for digital video. (p. 73)
- If the terminal for the AV cable is soiled, noises may appear on the screen. Wipe the soil off the terminal with a soft cloth, and then connect the cable to the AV terminal.
- Is a picture containing a copyright protection signal (copy guard) being recorded? When a protected picture is played back by the Camcorder, mosaic-like patterns appear on the picture.

Card

Recorded pictures are not clear.

- Have you set [X BASIC] >> [PICT. QUALITY] >> [. (Normal)]? If recording is done with it set to [. (Normal)], pictures with fine details may include a mosaic-like pattern. Set [PICT. QUALITY] >> [(High)]. (p. 32)

A file recorded on a card cannot be deleted.

- Is the file locked? Locked files cannot be deleted. (p. 50)
- For the SD Memory Card, if its write protect switch is set to [LOCK], then deletion is disabled. (p. 20)

Photoshot playback images do not look normal.

- The picture may be damaged. In order to prevent the loss of image data, backing up on a cassette or a personal computer is recommended.

Even if a card is formatted, it cannot be used.

- Either the Camcorder or the card may be damaged. Please consult a dealer.

During playback, [UNPLAYABLE CARD] is displayed.

- The image was either recorded in a different format, or data is damaged.

Others

The indication disappears, the screen is frozen, or no operation can be performed.

- Turn off the power to the Camcorder. If the power cannot be turned off, press the [RESET] button (p. 78), or detach the battery or AC adaptor and then reattach it. After that, turn on the power again. If normal operation is still not restored, detach the power connected, and consult the dealer who you purchased the Camcorder from.

[PUSH THE RESET SWITCH] is displayed.

- An irregularity in the Camcorder has been automatically detected. Remove the cassette or the card for data protection and then press the [RESET] Button with the protection on the Lens Cap. The Camcorder will be activated.
- An irregularity in the Camcorder has been automatically detected. Remove the cassette or the card for data protection and then press the [RESET] Button. The Camcorder will be activated.
- If you do not press the [RESET] Button, the power to the Camcorder is turned off automatically about 1 minute later.
- Even after you press the [RESET] button, the indication may still appear repeatedly. If so, the Camcorder needs repair. Detach the power connected, and consult the dealer who you purchased the Camcorder from. Do not attempt to repair the appliance by yourself.

Even if connected by the USB cable, the Camcorder is not recognized by the PC.

- Is the USB driver installed? For information, refer to pages 56~58.

When the USB cable is disconnected, an error message will appear on PC.

- For Windows: To disconnect the USB cable safely, double-click the [] icon in the task tray and follow the instructions on the screen.
- For Macintosh: To disconnect the USB cable safely, drop the [NO_NAME] icon which appeared when you connected the Camcorder with the USB Cable into the recycle bin.

The Camcorder malfunctions on editing, dubbing from digital video equipment, or using "MotionDV STUDIO 5.6E LE for DV".

- If a tape is recorded in multiple modes such as SP and LP (recording mode), 12bit and 16bit (sound recording mode), recorded and unrecorded parts, the Camcorder may malfunction at a point where the mode switches. When you edit, do not record in multiple modes.

The Warning/Alarm indication [] appears when the Camcorder is operated in the Web Camera mode.

- Did you press the [MENU] Button, the Recording Start/Stop Button or the [PHOTO SHOT] Button? You cannot use the menu or record onto the Tape/Card in the Web Camera mode.
- Is the setting for the Remote Control correct?
- Did you attempt to play a tape without inserting it? Insert a tape.
- Did you attempt to play a tape with copyright protection (copy guard)? Pictures of the tape with copyright protection (copy guard) cannot be displayed on the PC. (The audio of the tape can be played.)
- Is the USB Driver installed? (pp. 56~58)

Using the RESET button

1 Open the LCD Monitor.

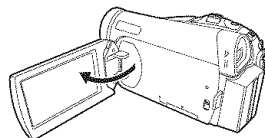

2 Undo Grip Belt end ① and pull Lens Cap Cord ② downward to loosen Grip Belt.

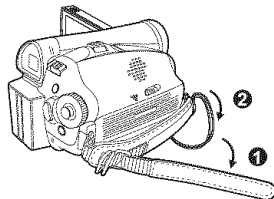

3 Use projection ③ on the Lens Cap to press the [RESET] Button ④.

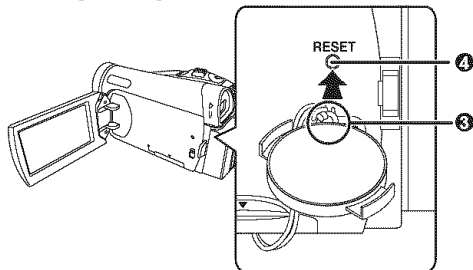

Explanation of Terms

■ Digital Video System

In a digital video system, images and sounds are converted into digital signals and recorded on a tape. This complete digital recording is capable of recording and playback with minimal image and sound deterioration.

In addition, it automatically records data, such as Time Code and Date/Time, as digital signals.

■ Compatibility with S-VHS or VHS Cassettes

Because this Camcorder employs a digital system for recording image and sound data, it is not compatible with conventional S-VHS or VHS video equipment that employs an analog recording system.

The size and shape of the Cassettes are also different.

■ Compatibility with Output Signals

Because AV signal output from the AV signal output Jack is analog (the same as conventional video systems), this Camcorder can be connected with S-VHS or VHS video or a TV for playback.

■ Focus

Auto Focus Adjustment

The Auto Focus System automatically moves forward and backward the focusing lens inside the Camcorder to bring the subject into focus so that the subject can be seen clearly.

However, the Auto Focus System does not function properly for the following subjects or under the following recording conditions.

Please use the Manual Focus Mode instead.

1) Recording a subject whose one end is located closer to the Camcorder and the other end farther away from it

- Because Auto Focus makes adjustments at the center of an image, it may be impossible to focus on a subject that is located in both foreground and background.

2) Recording a subject behind dirty or dusty glass

- Because the focus is on the dirty glass, the subject behind the glass will not be focused.

3) Recording a subject in dark surroundings

- Because the light information that comes through the lens decreases considerably, the Camcorder cannot focus correctly.

4) Recording a subject that is surrounded by objects with glossy surfaces or by highly reflective objects

- Because the Camcorder focuses on the objects with glossy surfaces or on highly reflective objects, the subject may become blurry.

5) Recording a fast-moving subject

- Because the focus lens-inside moves mechanically, it cannot keep up with the fast-moving subject.

6) Recording a subject with little contrast

- Because the Camcorder achieves focus based upon the vertical lines of an image, a subject with little contrast, such as a white wall, may become blurry.

■ Time Code

Time Code signals are data that indicate time measured in hours, minutes, seconds, and frames (30 frames per second). If this data is included in a recording, an address is assigned to each image on the tape.

- The Time Code is automatically recorded as a part of the sub-code at each recording.
- When a new (previously unrecorded) Cassette is inserted, the Time Code automatically starts from zero. If a recorded Cassette is inserted, the Time Code picks up from the point where the last scene was recorded. (In this case, when the Cassette is inserted, the zero display [0h00m00s00f] may appear, but the Time Code starts from the previous value.)
- The Time Code cannot be reset to zero.
- Unless the Time Code is continuously recorded from the beginning of a tape, accurate editing may not be possible. To ensure that the Time Code will be recorded with no breaks, we recommend the use of the Blank Search Function (p. 31) before recording a new scene.

Specifications

Digital Camcorder

Information for your safety

Power Source:

DC 7.9/7.2 V

Power Consumption:

Recording

4.2 W (PV-GS29)

4.4 W (PV-GS39/PV-GS59)

Recording Format:

Mini DV (Consumer-use Digital Video SD Format)

Tape Used:

6.35 mm digital video tape

Recording/Playback Time:

SP: 80 min.; LP: 120 min. (with DVM80)

Video**Recording System:**

Digital Component

Television System:

EIA Standard: 525 lines, 60 fields NTSC color signal

Audio**Recording System:**

PCM Digital Recording

16 bit (48 kHz/2ch), 12 bit (32 kHz/4ch)

Image Sensor:

1/6-inch CCD Image Sensor

Lens:

Auto Iris, F1.8 to F3.9, Focal Length; 1.9-57 mm, Macro (Full Range AF)

Filter Diameter:

30.5 mm

Zoom:

30:1 Power Zoom

Monitor:

2.5-inch LCD (PV-GS29)

2.7-inch Wide LCD (PV-GS39/PV-GS59)

Viewfinder:

Color Electronic Viewfinder

Microphone:

Stereo

Speaker:

1 round speaker 20 mm

Standard Illumination:

1,400 lx

Minimum Required Illumination:

2 lx (MagicPix Mode)

Video Output Level:

1.0 Vp-p, 75 Ω

Audio Output Level (Line):

316 mV, 600 Ω

Mic Input:

Mic sensitivity -50 dB (0 dB=1 V/Pa, 1 kHz)

USB:

Card reader/writer function, USB 2.0 compliant (Hi-Speed (PV-GS59)) (Full-Speed (PV-GS39))
No copyright protection support

Digital Interface:

DV Input/Output Jack (IEEE1394, 4-pin)

Dimensions:

Approx. 69 (H) × 82 (W) × 120 (D) mm

Approx. 2-11/16 (H) × 3-1/4 (W) × 4-3/4 (D) inch

Mass:

Approx. 0.41 kg (0.90 lbs.)

(without Battery and DV cassette)

Operating Temperature:

0 °C to 40 °C (32 °F to 104 °F)

Operating Humidity:

10 % to 80 %

Card Memory Functions**Recording Media:**

SD Memory Card

(8 MB /16 MB /32 MB /64 MB / 128 MB /256 MB

/512 MB /1 GB/2 GB (Maximum))

Please confirm the latest information on the following website.

<http://panasonic.co.jp/pavc/global/cs>

(This Site is English only.)

Still picture recording file format:

JPEG (Design rule for Camera File system, based on Exif 2.2 standard), DPOF corresponding

Still Image Size:

640 × 480 pixels (VGA)

WEB Camera**Compression:**

Motion JPEG

Image Size:

320 × 240 pixels (QVGA)

AC Adaptor

Information for your safety

Power Source:

AC 110 to 240 V, 50/60 Hz

Power Consumption:

19 W

DC Output:

DC 7.9 V, 1.4 A (Camcorder Operation)

DC 8.4 V, 0.65 A (Battery Charging)

Dimensions:

61 (W) × 32 (H) × 91 (D) mm







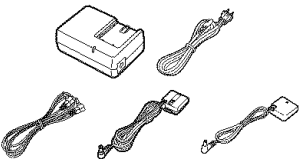

2-6/16 (W) × 1-4/16 (H) × 3-9/16 (D) inch

Mass:

Approx. 0.11 kg (0.24 lbs.)

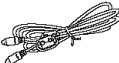
Mass and dimensions are approximate values.
Specifications may change without prior notice.

Camcorder Accessory System

Accessory #	Figure	Description
PV-DAC14		AC Adaptor with AC Cable and DC Cables
CGR-DU06A/1B		640 mAh/Rechargeable Lithium Ion Battery Pack
CGA-DU12A/1B		1 150 mAh/Rechargeable Lithium Ion Battery Pack
CGA-DU21A/1B		2 040 mAh/Rechargeable Lithium Ion Battery Pack
PV-DDC9 (For USA) PV-DDC9-K (For Canada)		DV Interface Cable (i.LINK) (4-pin to 4-pin)
RP-SDK02GU1A RP-SDK01GU1A RP-SDK512U1A RP-SDH256U1A RP-SDQ02GU1A RP-SDQ01GU1A RP-SD512BU1A RP-SD256BU1A RP-SD128BU1A RP-SD064BPPA RP-SD032BPPA		Pro High Speed 2 GB SD Memory Card Pro High Speed 1 GB SD Memory Card Pro High Speed 512 MB SD Memory Card Super High Speed 256 MB SD Memory Card High Speed 2 GB SD Memory Card High Speed 1 GB SD Memory Card High Speed 512 MB SD Memory Card High Speed 256 MB SD Memory Card High Speed 128 MB SD Memory Card High Speed 64 MB SD Memory Card High Speed 32 MB SD Memory Card
N2QAEC000017 (PV-GS59 Only)		IR Remote Control
BN-SDPC3E		SD PCMCIA Adaptor (compatible with MultiMediaCard)
PV-HB002 (USA only)		Carrying Case

• Please refer to page 82, when placing an order.

***NOTE:** Accessories and/or model numbers may vary by country. Please consult your local dealer.

Camcorder Accessory Order Form (For U.S.A. customers)

Please photocopy this form when placing an order.

1. Camcorder Model # _____
 2. Items Ordered _____

Accessory #	Description	Price Each	Quantity	Total Price
Subtotal				
Your State & Local Sales Tax				
Shipping & Handling				6.95
Total Enclosed				

3. Method of payment (check one)

- Check of Money Order enclosed (NO C.O.D.SHIPMENTS)
 VISA Credit Card # _____
 MasterCard Expiration Date _____
 Discover Customer Signature _____

Make Check or Money Order to: PANASONIC ACCESSORIES

(Please do not send cash)

4. Shipping information (UPS delivery requires complete street address)

Ship To:

Mr.
Mrs.
Ms.

First

Last

Phone #:

Day () _____

Street Address

Night () _____

City

State

Zip

TO OBTAIN ANY OF OUR CAMCORDER ACCESSORIES YOU CAN DO ANY OF THE FOLLOWING:

VISIT YOUR LOCAL PANASONIC DEALER

OR

CALL PANASONIC'S ACCESSORY ORDER LINE AT 1-800-332-5368

[6 AM-5 PM M-F, 6 AM-10:30 AM SAT, PACIFIC TIME]

OR

MAIL THIS ORDER TO: PANASONIC SERVICES COMPANY ACCESSORY ORDER OFFICE
 20421 84th Avenue South Kent, WA. 98032

Request for Service Notice (For U.S.A. customers)

Please photocopy this form when making a request for service notice.

Request for Service Notice:

In the unlikely event this product needs service.

- Please include your **proof of purchase**.
(Failure to do so will delay your repair.)
- To further speed your repair, please provide an explanation of what is wrong with the unit and any symptom it is exhibiting.

Mail this completed form and your Proof of Purchase along with your unit to:
Panasonic Services Company
410B Airport Road
Elgin, IL 60123-9333
Attn: Camcorder Repair

Limited Warranty (For U.S.A. customers)

PANASONIC CONSUMER ELECTRONICS COMPANY,
DIVISION OF PANASONIC CORPORATION OF
NORTH AMERICA
One Panasonic Way Secaucus, New Jersey 07094

PANASONIC SALES COMPANY, DIVISION OF
PANASONIC PUERTO RICO, INC.,
AVE. 65 de Infantería, Km. 9.5 San Gabriel Industrial
Park, Carolina, Puerto Rico 00985

Panasonic Video Products Limited Warranty

Limited Warranty Coverage

If your product does not work properly because of a defect in materials or workmanship, Panasonic Consumer Electronics Company or Panasonic Sales Company (collectively referred to as "the warrantor") will, for the length of the period indicated on the chart below, which starts with the date of original purchase ("warranty period"), at its option either (a) repair your product with new or refurbished parts, or (b) replace it with a new or a refurbished product. The decision to repair or replace will be made by the warrantor.

Product	Parts	Labor	Service	Contact Number
Camcorder	One (1) Year (except CCD Image Sensor)	Ninety (90) Days	Carry-In or Mail-In	1-800-211-PANA(7262)
	CCD Image Sensor - 6 (Six) Months	Ninety (90) Days		
DVD/VCR Deck, A/V Mixer	One (1) Year	Ninety (90) Days	Carry-In or Mail-In	1-800-211-PANA(7262)
TV/VCR, TV/DVD, TV/DVD/VCR Combination	One (1) Year (except CRT) CRT - Two (2) Years	Ninety (90) Days Ninety (90) Days	Carry-In: 21" CRT and Smaller In-Home or Carry-In: 22" CRT and Larger	1-800-211-PANA(7262)
TV/HDR Combination	One (1) Year (except CRT) CRT - Two (2) Years	Ninety (90) Days Ninety (90) Days	In-Home or Carry-In	1-888-643-9788
Rechargeable Batteries (in exchange for defective item)	Ten (10) Days	Not Applicable	Carry-In or Mail-In	1-800-211-PANA(7262)
Tape (in exchange for defective item)	Five (5) Days	Not Applicable	Carry-In or Mail-In	1-800-211-PANA(7262)
Memory Cards (in exchange for defective item)	Ninety (90) Days	Not Applicable	Carry-In or Mail-In	1-800-211-PANA(7262)

During the "Labor" warranty period there will be no charge for labor. During the "Parts" warranty period, there will be no charge for parts. You must carry-in or mail-in (prepaid) your product or arrange for in-home service, as applicable, during the warranty period. If non-rechargeable batteries are included, they are not warranted. This warranty only applies to products purchased and serviced in the United States or Puerto Rico. This warranty is extended only to the original purchaser of a new product which was not sold "as is". A purchase receipt or other proof of the original purchase date is required for warranty service.

Carry-In, Mail-In (Prepaid) or In-Home Service

For Carry-In, Mail-In (Prepaid) or In-Home Service (as applicable) in the United States call toll free contact number listed above or visit Panasonic Web Site: <http://www.panasonic.com>

For assistance in Puerto Rico call Panasonic Sales Company (787)-750-4300 or fax (787)-768-2910.

In-Home service, if applicable, requires clear, complete and easy access to the product by the authorized servicer and does not include removal or re-installation of an installed product. It is possible that certain in-home repairs will not be completed in-home, but will require that the product, or parts of the product, be removed for shop diagnosis and/or repair and then returned.

Limited Warranty Limits And Exclusions

This warranty ONLY COVERS failures due to defects in materials or workmanship, and DOES NOT COVER normal wear and tear or cosmetic damage, nor does it cover markings or retained images on the picture tube resulting from viewing fixed images (including, among other things, letterbox pictures on standard 4:3 screen TV's, or non-expanded standard 4:3 pictures on wide screen TV's, or onscreen data in a stationary and fixed location). The warranty ALSO DOES NOT COVER damages which occurred in shipment, or failures which are caused by products not supplied by the warrantor, or failures which result from accidents, misuse, abuse, neglect, bug infestation, mishandling, misapplication, alteration, faulty installation, set-up adjustments, misadjustment of consumer controls, improper maintenance, power line surge, lightning damage, modification, or commercial use (such as in a hotel, office, restaurant, or other business), rental use of the product, service by anyone other than a Factory Servicenter or other Authorized Servicer, or damage that is attributable to acts of God.

THERE ARE NO EXPRESS WARRANTIES EXCEPT AS LISTED UNDER "LIMITED WARRANTY COVERAGE". THE WARRANTOR IS NOT LIABLE FOR INCIDENTAL OR CONSEQUENTIAL DAMAGES RESULTING FROM THE USE OF THIS PRODUCT, OR ARISING OUT OF ANY BREACH OF THIS WARRANTY. (As examples, this excludes damages for lost time, cost of having someone remove or re-install an installed unit if applicable, or travel to and from the servicer, loss of media or images, data or other memory or recorded content. The items listed are not exclusive, but are for illustration only.)

ALL EXPRESS AND IMPLIED WARRANTIES, INCLUDING THE WARRANTY OF MERCHANTABILITY, ARE LIMITED TO THE PERIOD OF THE LIMITED WARRANTY.

Some states do not allow the exclusion or limitation of incidental or consequential damages, or limitations on how long an implied warranty lasts, so the exclusions may not apply to you.

This warranty gives you specific legal rights and you may also have other rights which vary from state to state. If a problem with this product develops during or after the warranty period, you may contact your dealer or Servicenter. If the problem is not handled to your satisfaction, then write to the warrantor's Consumer Affairs Department at the addresses listed for the warrantor.

PARTS AND SERVICE (INCLUDING COST OF AN IN-HOME SERVICE CALL, WHERE APPLICABLE) WHICH ARE NOT COVERED BY THIS LIMITED WARRANTY ARE YOUR RESPONSIBILITY.

Customer Services Directory

Obtain Product Information and Operating Assistance; locate your nearest Dealer or Servicenter; purchase Parts and Accessories; or make Customer Service and Literature requests by visiting our Web Site at:

<http://www.panasonic.com/consumersupport>

or, contact us via the web at:

<http://www.panasonic.com/contactinfo>

You may also contact us directly at:

1-800-211-PANA (7262).

Monday-Friday 9 am-9 pm; Saturday-Sunday 10 am-7 pm, EST.

For hearing or speech impaired TTY users, TTY : 1-877-833-8855

Accessory Purchases

Purchase Parts, Accessories and Instruction Books online for all Panasonic Products by visiting our Web Site at:

<http://www.pasc.panasonic.com>

or, send your request by E-mail to:

npcparts@us.panasonic.com

You may also contact us directly at:

1-800-332-5368 (Phone) 1-800-237-9080 (Fax Only) (Monday – Friday 9 am to 8 pm, EST.)

Panasonic Services Company

20421 84th Avenue South,

Kent, WA 98032

(We Accept Visa, MasterCard, Discover Card, American Express, and Personal Checks)

For hearing or speech impaired TTY users, TTY : 1-866-605-1277

Product Repairs

Centralized Factory Servicenter

Panasonic Services Company

410B Airport Road

Elgin, IL 60123-9333

Attention: Camcorder Repair

MAIL TO :

Please carefully pack and ship, prepaid and insured, to the Elgin Centralized Factory Servicenter. Customer's in Puerto Rico, please ship or carry in to location below ("Service in Puerto Rico").

Service in Puerto Rico

Panasonic Puerto Rico, Inc. Panasonic Sales Company

Factory Servicenter:

Ave. 65 de Infantería, Km. 9.5, San Gabriel Industrial Park,

Carolina, Puerto Rico 00985

Phone (787)750-4300, Fax (787)768-2910

Warranty (For Canada customers)

Panasonic Canada Inc.

5770 Ambler Drive, Mississauga, Ontario L4W 2T3

PANASONIC PRODUCT – LIMITED WARRANTY

Panasonic Canada Inc. warrants this product to be free from defects in material and workmanship and agrees to remedy any such defect for a period as stated below from the date of original purchase.

Camcorder Product – One (1) year, parts and labour

LIMITATIONS AND EXCLUSIONS

This warranty does not apply to products purchased outside Canada or to any product which has been improperly installed, subjected to usage for which the product was not designed, misused or abused, damaged during shipping, or which has been altered or repaired in any way that affects the reliability or detracts from the performance, nor does it cover any product which is used commercially. Dry cell batteries are also excluded from coverage under this warranty.

This warranty is extended to the original end user purchaser only. A purchase receipt or other proof of date of original purchase is required before warranty service is performed.

THIS EXPRESS, LIMITED WARRANTY IS IN LIEU OF ALL OTHER WARRANTIES, EXPRESS OR IMPLIED, INCLUDING ANY IMPLIED WARRANTIES OF MERCHANTABILITY AND FITNESS FOR A PARTICULAR PURPOSE.

IN NO EVENT WILL PANASONIC CANADA INC. BE LIABLE FOR ANY SPECIAL, INDIRECT OR CONSEQUENTIAL DAMAGES.

In certain instances, some jurisdictions do not allow the exclusion or limitation of incidental or consequential damages, or the exclusion of implied warranties, so the above limitations and exclusions may not be applicable.

WARRANTY SERVICE

For product operation and information assistance, please contact your Dealer or our Customer Care Centre at:

Telephone #: (905) 624-5505

Fax #: (905) 238-2360

Web: www.panasonic.ca

For product repairs, please contact one of the following:

- Your Dealer who will inform you of an authorized Servicentre nearest you.
- Our Customer Care Centre at (905) 624-5505 or www.panasonic.ca
- A Panasonic Factory Servicentre listed below:

Richmond, British Columbia

Panasonic Canada Inc.

12111 Riverside Way

Richmond, BC V6W 1K8

Tel: (604) 278-4211

Fax: (604) 278-5627

Mississauga, Ontario

Panasonic Canada Inc.

5770 Ambler Dr.

Mississauga, ON L4W 2T3

Tel: (905) 624-8447

Fax: (905) 238-2418

IF YOU SHIP THE PRODUCT TO A SERVICENTRE

Carefully pack and send prepaid, adequately insured and preferably in the original carton. Include details of the defect claimed, and proof of date of original purchase.





Precauciones para su seguridad

ADVERTENCIA:

Para evitar incendios y descargas eléctricas, no exponga este equipo a la lluvia ni a la humedad.

Su ^{Mini}IX Camcorder está diseñada para grabar y reproducir en el modo de Reproducción Estándar (SP) y modo Largo (LP).

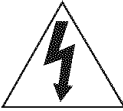
Se recomienda el uso sólo de cintas de cassette que hayan sido probadas e inspeccionadas para su uso en aparatos VCR con la marca ^{Mini}IX.

	PRECAUCIÓN RIESGO DE DESCARGA ELÉCTRICA NO ABRIR			Este símbolo tiene por finalidad alertar al usuario acerca de la presencia de tensión sin aislación en el interior del producto, que puede tener la intensidad suficiente como para causar descargas eléctricas. Por lo tanto, hacer contacto con cualquier pieza en el interior de la unidad es peligroso.
<p>PRECAUCIÓN: PARA REDUCIR EL RIESGO DE DESCARGA ELÉCTRICA, NO quite LA CUBIERTA (O PARTE POSTERIOR). EL APARATO NO TIENE EN SU INTERIOR PIEZAS QUE PUEDAN SER REPARADAS POR EL USUARIO. SOLICITE TODA REPARACIÓN A PERSONAL DE SERVICIO CUALIFICADO.</p>				Este símbolo tiene por finalidad alertar al usuario de la presencia de importantes instrucciones de operación y mantenimiento en la literatura incluida con la unidad. Por lo tanto, lea detenidamente la literatura incluida para evitar problemas.

La etiqueta de régimen está pegada en la base de la cubierta del cargador.

Este dispositivo cumple con la parte 15 de las Reglas del FCC. El funcionamiento está sujeto a las dos siguientes condiciones: (1) Este dispositivo puede no causar interferencias perjudiciales, y (2) este dispositivo debe aceptar cualquier interferencia recibida, incluyendo interferencias que pueden causar un funcionamiento no deseado.

Nota:

Este equipo ha sido puesto a prueba y se encontró que cumple con la Parte 15 de las reglas del FCC. Estos límites están diseñados para proveer una protección razonable contra interferencias cuando se opera en un ambiente residencial.

Si este equipo causa interferencias en la recepción de radio o televisión, lo cual se puede comprobar al apagar y encender el equipo, utilice el equipo en otra ubicación y/o utilice un tomacorriente diferente al que está utilizando el receptor.

Si es necesario, consulte con el distribuidor o un técnico experto de radio/TV para solicitar ayuda.

Puede encontrar útil el folleto 'Información sobre las interferencias' disponible en las oficinas regionales del FCC local.

Advertencia del FCC:

Para asegurar la conformidad continua del FCC, utilice solamente el cable de interfaz blindado cuando conecte una cámara de video digital a una computadora de acuerdo con las instrucciones incluidas aquí. También, cualquier cambio sin autorización o modificaciones a este equipo anularían la autoridad del usuario para operarlo.

Guía rápida

Cómo utilizar la batería

- 1 Coloque la batería en el adaptador de ca y cárguela.

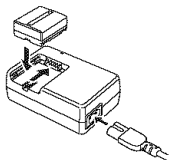

- Antes de usar, cargue completamente la batería.
- Debido a que la batería no se cargará cuando el cable de entrada de ca esté conectado al adaptador de ca desconéctelo del adaptador de ca
- El indicador [CHARGE] se encienden y la carga comienza.
- Cuando el indicador [CHARGE] se apaga, se ha terminado la carga.

- 2 Coloque la batería cargada en el Camcorder.

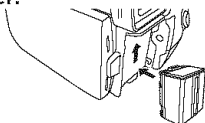

Inserción de un cassette

- 1 Deslice el botón [OPEN/EJECT] ① hacia el frente y levante para abrir completamente la cubierta del compartimento del cassette.

- Para proteger la cinta, el soporte del cassette no podrá expulsarse, si la tapa no está completamente abierta.

- 2 Después de abrir el soporte del cassette, inserte un cassette.

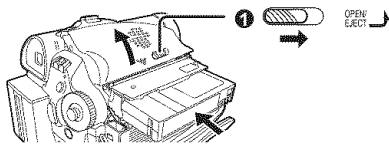

- 3 Cierre el soporte del cassette presionando la marca [PUSH] ②.

- 4 Sólo después de que el soporte de cassette esté completamente guardado, cierre la cubierta del compartimento del cassette presionando la marca ③.

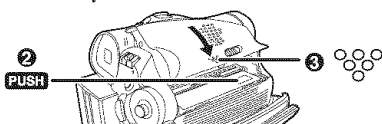

Inserción de una tarjeta de memoria

- 1 Usando su pulgar presione la perilla [OPEN] ① y saque la pantalla LCD ② en la dirección de la flecha.

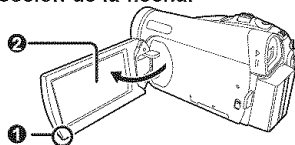

- 2 Abrir la cubierta de la ranura de tarjeta ③.
- 3 Mientras sostiene la tarjeta de memoria con su esquina cortada hacia la derecha ④ insértela en la ranura de tarjeta ⑤.
- 4 Cierre bien la cubierta de ranura de tarjeta ⑥.

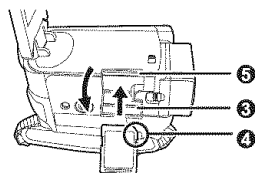

Encendido del Camcorder

- Antes de encender el Camcorder abra la pantalla LCD o Viewfinder.

■ Cómo encender el Camcorder

- 1 Establezca el interruptor [OFF/ON] en [ON] mientras presiona el botón ①.

- El indicador [STATUS] se ilumina de color rojo.

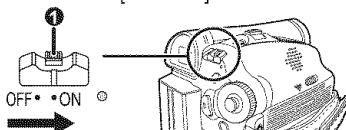

■ Cómo apagar el Camcorder

- 2 Establezca el interruptor [OFF/ON] en [OFF] mientras presiona el botón ①.

- El indicador [STATUS] se apaga.

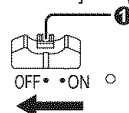

Cómo utilizar el visor

- Antes de utilizar el visor, ajuste el campo visual para que las visualizaciones dentro del visor sean claras y fáciles de leer.

- 1 Extienda el visor.



2 Ajuste rotando la perilla ocular correctora

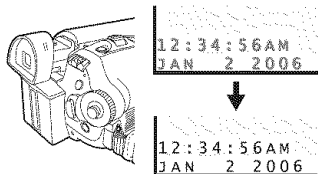

Grabación de una cinta

1 Ajuste el selector de modo en modo de grabación de cinta.

- Se visualiza la indicación [REPRODUCCIÓN DE LA CINTA] en la pantalla.

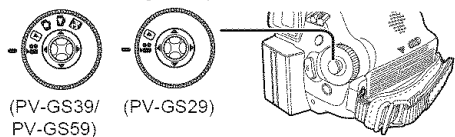

2 Presione el botón de inicio/parada de grabación.

- Comienza la grabación.

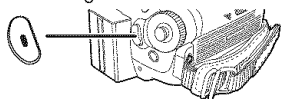

3 Presione el botón de inicio/parada de grabación nuevamente para detener la grabación.

Grabación de una imagen fija en tarjeta (Photoshot)

(Para PV-GS39/PV-GS59)

1 Ajuste el selector de modo en modo de grabación de tarjeta.

- Se visualiza la indicación [GRABACIÓN EN TARJETA] en la pantalla.

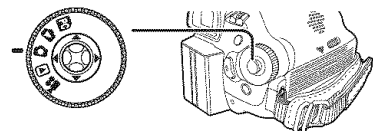

2 Presione el botón [PHOTO SHOT].



Reproducción de una cinta

1 Ajuste el selector de modo en modo de reproducción de cinta.

- Se visualiza la indicación [REPRODUCCIÓN DE LA CINTA] en la pantalla.
- El icono del sistema de navegación de un toque aparece en la parte inferior derecha de la pantalla.

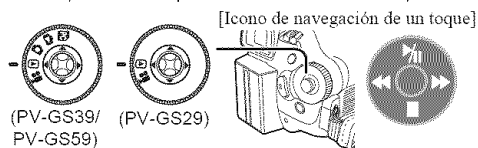

2 Mueva el joystick [◀] ① para rebobinar el cassette.

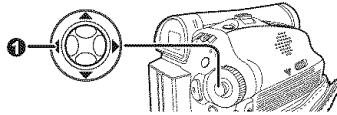

3 Mueva el joystick [▲] ② para iniciar la reproducción.

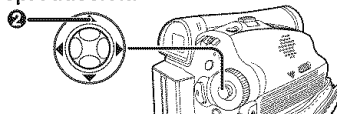

4 Mueva el joystick [▼] ③ para detener la reproducción.

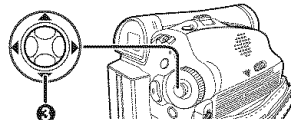

Reproducción de una tarjeta de memoria (Para PV-GS39/PV-GS59)

1 Ajuste el selector de modo en modo de reproducción de foto.

- Se visualiza la indicación [REPRODUCCIÓN DE TARJETA] en la pantalla.
- El icono del sistema de navegación de un toque aparece en la parte inferior derecha de la pantalla.

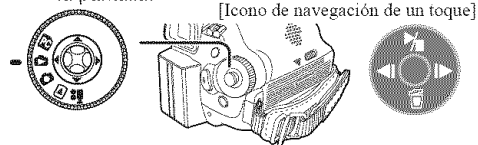

2 Comience la reproducción.

Joystick [▲] : Comienzo de una presentación
Parada de la presentación

Joystick [▼] : Borra las imágenes

Joystick [◀] : Reproducción de la foto anterior

Joystick [▶] : Reproducción de la foto siguiente

A

AC Adaptor 15, 73
 Audio Dubbing 53
 Auto Focus 79

B

Backlight 37
 Blank Search 31
 Built-in LED Video Light 33

C

Camcorder Accessory Order Form 82
 Camcorder Accessory System 81
 Charging the Battery 15
 Cinema Mode 39
 Condensation 73
 Cue Playback 46
 Customer Services Directory 85

D

Date/Time Setting 21
 Digital Zoom 36
 DPOF Setting 50
 Dubbing 54

E

Erasure Prevention Slider 19

F

Fade 37
 Formatting a Card 51
 F Number 43

I

Iris 43

J

Joystick Control 23

L

LCD Monitor 21, 75
 Limited Warranty 84
 List of Menus 26~28
 Lock Setting 50
 Low Light Mode 40

M

MagicPix Function 38
 Manual Focus 44
 Mode Dial 23
 MotionDV STUDIO 64

O

One-Touch Navigation icon 23

P

Photoshot 32
 Playback with Zoom Lever 47
 Portrait Mode 40

Q

Quick Movie Magic 64
 Quick Start 34

R

RapidFire Consecutive Photoshot 33
 Recording Check 31
 Remote Control 13
 Request for Service Notice 83
 Review Playback 46

S	
Scene Mode	40
SD Memory Card	69
Self-timer Recording	35
Self Recording	33
Sensor tag	17
Shutter Speed	42
Slide Show	48
Slow Motion Playback	46
Sound Volume	45
SP/LP Mode	29
Spanish Quick Use Guide	87
Sports Mode	40
Spotlight Mode	40
Still Advance Playback	47
Surf & Snow Mode	40

T	
Time Code	79

V	
Variable Speed Search	46
Video Head Clogging	73
Viewfinder	21, 75

W	
Warranty	86
Web Camera	60
White Balance	41
Wide/4:3 Function	39

Z	
Zoom	35
Zoom Microphone	35



Panasonic Consumer Electronics Company,
Division of Panasonic Corporation of North America
One Panasonic Way Secaucus, New Jersey 07094

Panasonic Sales Company ("PSC"),
Division of Panasonic Puerto Rico, Inc.
Ave. 65 de Infantería, Km. 9.5 San Gabriel Industrial Park Carolina,
Puerto Rico 00985

Panasonic Canada Inc.
5770 Ambler Drive,
Mississauga, Ontario L4W 2T3
(905) 624-5010
www.panasonic.ca



Printed in Indonesia
LSQT1000 B
S1105A2016

Free Manuals Download Website

<http://myh66.com>

<http://usermanuals.us>

<http://www.somanuals.com>

<http://www.4manuals.cc>

<http://www.manual-lib.com>

<http://www.404manual.com>

<http://www.luxmanual.com>

<http://aubethermostatmanual.com>

Golf course search by state

<http://golfingnear.com>

Email search by domain

<http://emailbydomain.com>

Auto manuals search

<http://auto.somanuals.com>

TV manuals search

<http://tv.somanuals.com>