

The Network of Networks.

3M™ One Pass Mini Fiber Pathway

Installation Instructions

December 2012
78-0013-4441-1-D

3M

Contents

1.0 System Overview	3
2.0 Components and Accessories	3
3.0 Installation Tools.....	3
4.0 Wall Surface Compatibility.....	4
5.0 Routing Duct.....	5
6.0 Exposing Fiber for Termination.....	6
7.0 Wall Outlet Installation	6
8.0 Duct Installation.....	7
9.0 Exterior and Interior Corners Installation	7
10.0 Planar Corner Installation	8
11.0 Mechanical Anchor Installation	9
12.0 Bridge Strip Installation.....	9
13.0 Wall Cover Installation	9
14.0 Connector Termination and Final Steps.....	10
15.0 Fiber Repair	11

1.0 System Overview

The One Pass Mini Fiber Pathway is designed for use in FTTP (Fiber-to-the-Premise) networks within brownfield or greenfield Multi Dwelling Units (MDUs). The One Pass Mini Fiber Pathway is a surface-mount, adhesive-backed drop cable and pathway solution designed for indoor use only. It is installed simultaneously in just one pass around the perimeter of the living unit. Delivery of voice, data, and video services to tenants using the One Pass Mini Fiber Pathway is a quick, reliable, and aesthetically pleasing cable pathway intallation method.

3M warranty for the One Pass system is contingent on:

- Installation is completed by an appropriately trained installer
- Strict adherence to the instructions provided in this manual
- Product installation within 24 months of date of manufacture when stored between 40°F to 100°F (4°C to 38°C) and 0–95% relative humidity. The optimum storage conditions are 72°F (22°C) and 50% relative humidity.

3M's warranty does not extend to products that have been subjected to misuse, neglect, accident or improper installation/alteration.

2.0 Components and Accessories



Duct (optional configurations available)



Wall Outlet
(SCA) 80-6113-8213-8
(SCU) 80-6113-8488-6



Point-of-Entry Wall Cover
80-6113-8214-6



Planar Corners
80-6113-8125-3

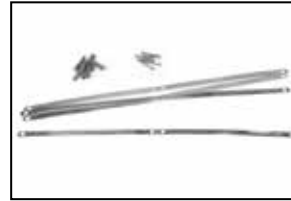

Bridge Strips



Wall Surface Compatibility
Test Kit 80-6113-9528-8



Mechanical Anchors
80-6113-8216-1



Fiber Repair Kit
80-6113-8220-3

3.0 Installation Tools

3.1 Installation Tool Kit 80-6113-8222-9



- Pouch 80-6108-4417-9
- Metal Snips
- Wall Surface Test Weight
- Duct Flange Removal Tool 80-6113-8221-1
- Duct Installation Tool 80-6113-8219-5
- Window Cut Tool for Fiber Repair
- Fiber Pick

3.2 ILU installation tools are wear items, and should be replaced on a bi-annual basis, or approximately every 500 installed units. Sooner as required.

3.3 Additional Recommended Tools (Not Included)

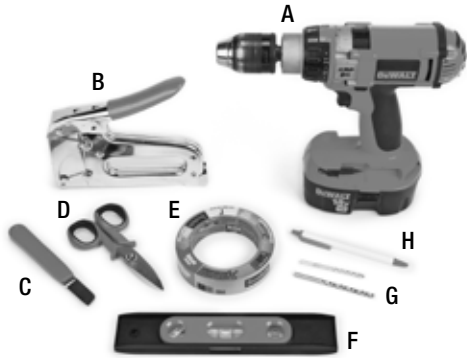

- a) Drill
- b) Stapler
- c) Splicer's Knife
- d) Fiber Snips
- e) ScotchBlue™ Painter's Tape
- f) Level
- g) Drill Bits - 5/16" (5 mm)
- h) Pen

4.0 Wall Surface Compatibility

The wall surface **MUST** be checked for compatibility with the adhesive backed One-Pass Mini Fiber Pathway prior to installation.

This test must be conducted on the most challenging surface of the installation path (greasy, soiled, textured etc). Or if installing on multiple wall surfaces, all surfaces must be tested and all must pass.

Incompatible surfaces include:

- Highly textured walls
- Porous or unfinished/unpainted brick or concrete
- Fabric wall surfaces
- Surfaces with flaking/delaminating paint or wallpaper

NOTE: The One Pass Mini Fiber Pathway should not be installed on the incompatible surface types listed above.

Wall Surface Compatibility Test Procedure

4.1 Peel liner.

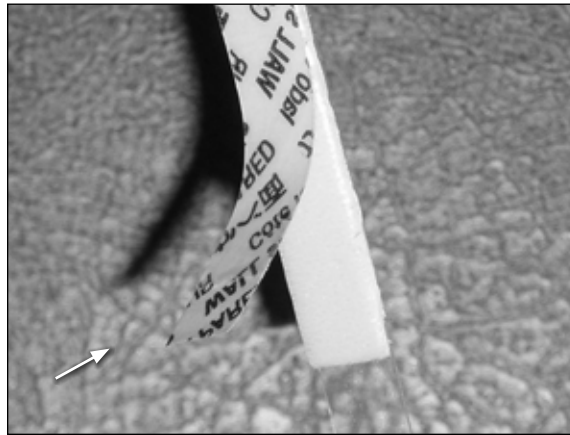

4.2 Press firmly onto wall. Pressing with fingers in tight spaces is also OK.

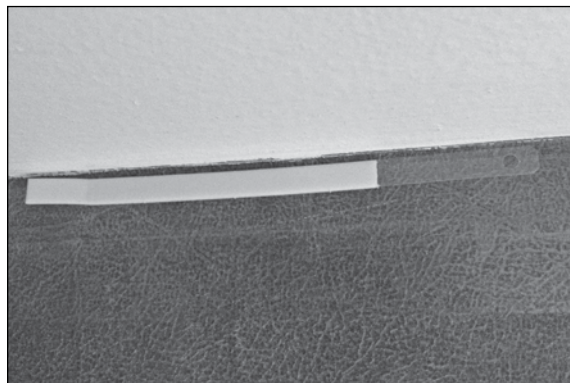
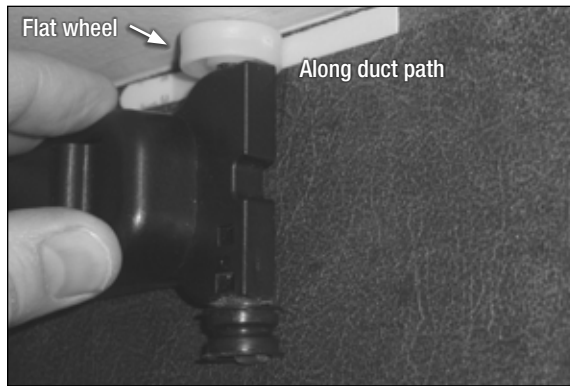

4.3 Hang weight from strip.

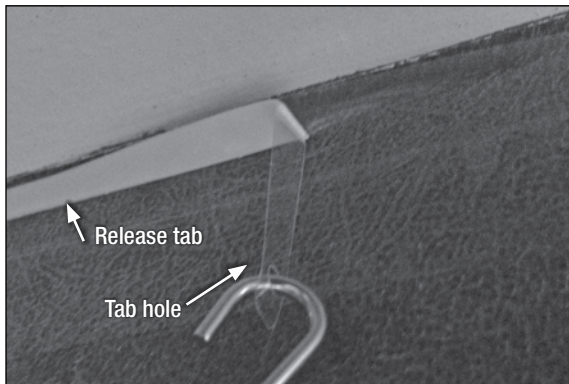

4.4 Remove successful test strips by pulling on release tab



Test Weight Hang Time	Result
> 60 seconds	PASS – Install
< 60 second	FAIL – Do not install

The path the duct will follow MUST be clean and dry.

- Clean all surfaces along the duct installation path with 3M™ Easy Trap Duster or equivalent prior to installation.
- Greasy, slick, or soiled surfaces must be cleaned with isopropyl alcohol or equivalent along the installation path prior to installation.

Recommended air and duct temperature for installation is 60°F–100°F (16°C–38°C).

Note: Carefully follow safety, health and environmental information given on the container label or the Material Safety Data Sheet for the isopropyl alcohol.

Avoid installing on or immediately above direct heat sources such as radiant heaters, steam pipes, stoves, etc. If unavoidable, install mechanical anchors on both sides of heat source as necessary.

Avoid installing in high humidity or water born environments such as shower stalls, sinks, etc. If unavoidable, install mechanical anchors on both sides of area as necessary. Area must be clean and dry at time of installation and minimum 72 hours following.

For best results, 3M recommends a curing time of 72 hours after installation of the OnePass Mini Fiber Pathway before subjecting it to temperature extremes below 60°F (16°C) or above 100°F (38°C).

5.0 Routing the Duct

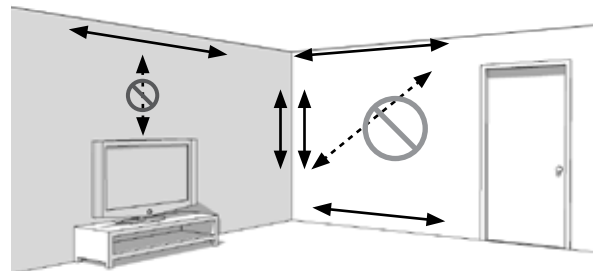

- **The adhesive is permanent. Removing the duct after installation may damage the installation surface.**
- Do not move or reposition the duct once installed. If for some reason the duct needs to be moved, a mechanical anchor is required to secure the duct to the wall on both sides of the section that has been removed.
- In the event repair is necessary, the materials needed for repairing the One Pass Mini Fiber Pathway are included in the repair kit, PN 80-6113-8220-3. (See Fiber Repair section for instructions).
- The best location is near the ceiling, baseboard and interior corners. Avoid running duct across open areas or diagonally across walls.
- Do not remove liner from duct until applying to installation surface including when handling it while applying to wall surface.
- Do not contaminate adhesive with dirt or oils. Do not allow the adhesive to come into contact with anything except the installation surface as you remove the liner.

- Do not remove duct from box. Route end through handle as shown and pay off duct.

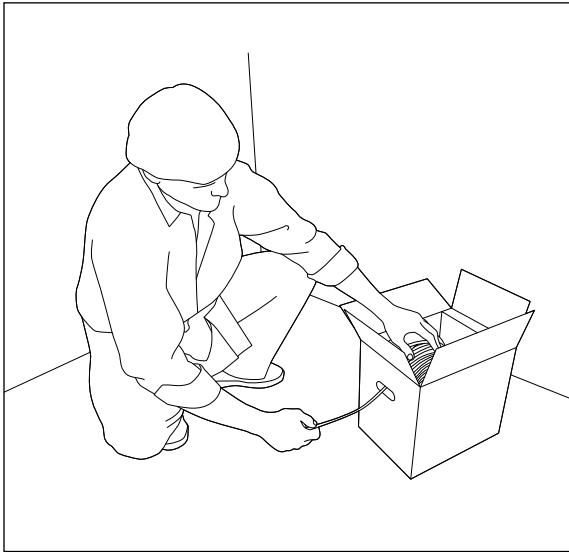

6.0 Exposing Fiber For Termination

Expose 2-4' (610-1220 mm) of fiber from the end of the duct before terminating using the following method:

- 6.1 Snip the flange on either side of the duct, being careful not to cut the fiber in the duct.

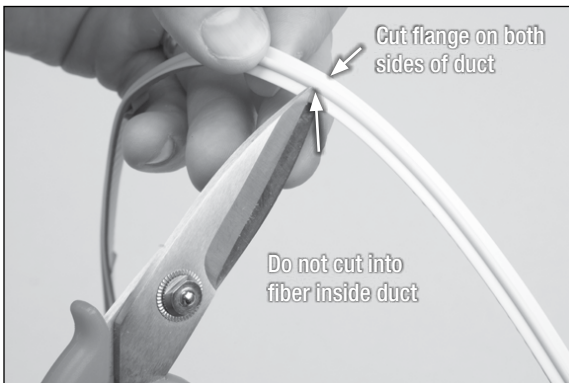

- 6.2 Twist the section to be removed 180°.

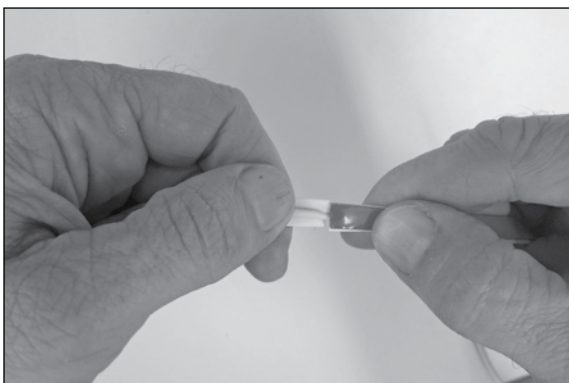

- 6.3 Pull the two sections of duct apart to expose the fiber.

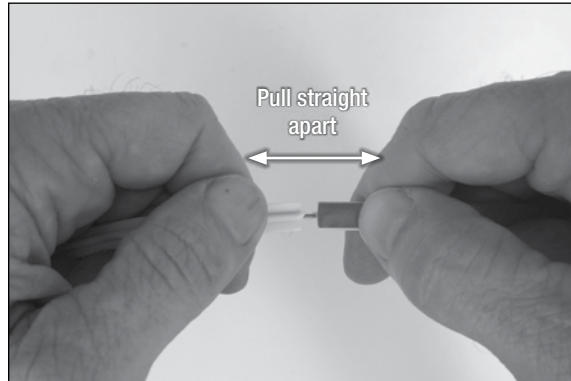

7.0 Wall Outlet Installation

The beginning and the end of the One Pass Mini Fiber Pathway must be held down mechanically. This is accomplished with the cover of the wall outlet box and the Point-Of-Entry Wall Cover base. If for any reason these accessories are not used at the beginning and end of the duct run, use of the adhesive backed mechanical anchor or equivalent is required.

- 7.1 Attach the wall outlet base to the wall using two screws (and anchors if necessary).
- 7.2 There are 12 ways to route the One Pass Mini Pathway Duct into the Wall Outlet. Select one and remove the break-away tab.

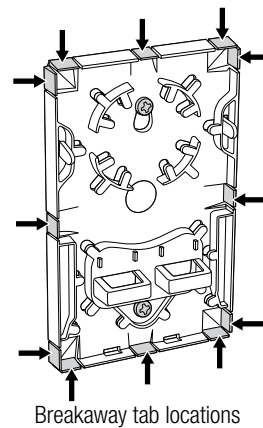

- 7.3 After exposing appropriate length of fiber for termination, attach duct by aligning the end of the duct with the recessed area in the base. Remove the liner and press firmly into place.

DO NOT ROUTE the 900 μm fiber into the outlet box until installation of the duct and termination of the connector is complete.

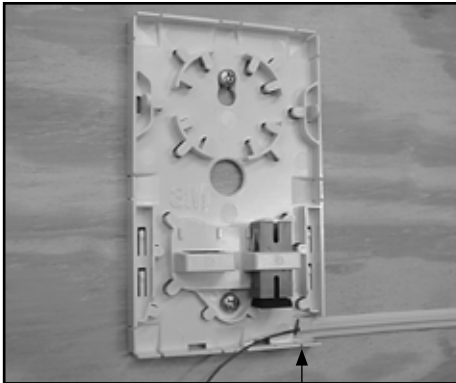

Align end of duct in recess

8.0 Duct Installation

8.1 Installation Tool

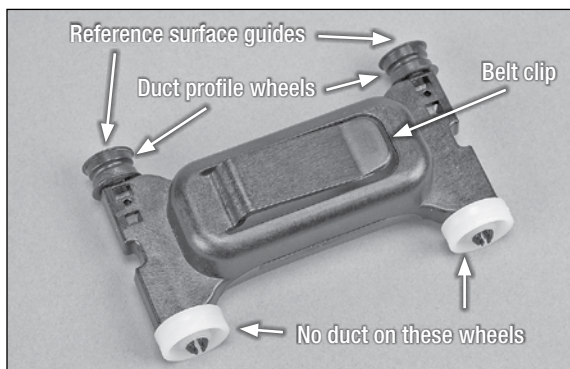

8.2 Installing the duct

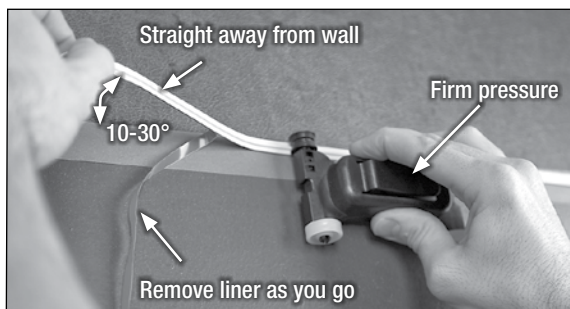

- The reference surface guides should maintain contact with reference surface during installation
- Hold duct at same height as duct installation path
- Hold duct out approximately 10-30° from wall
- Do not overstretch duct during installation
- Use firm pressure to securely attach duct to installation surface

9.0 Exterior and Interior Corner Installation

- 9.1 **Exterior Corner:** Install duct around corner using firm pressure.

Note: Do not overstretch duct.

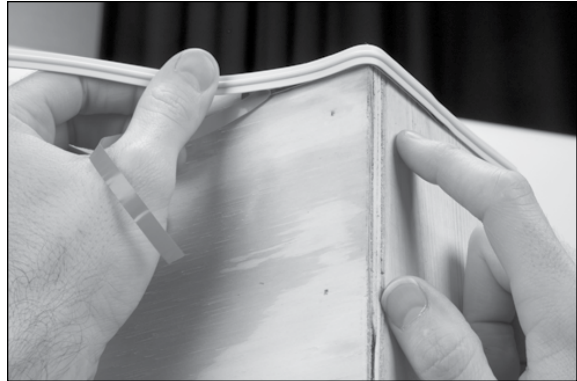

- 9.2 a) **Interior corner:** Use wheel of installation tool to ensure proper bend radius.

Note: Do not overstretch duct or allow adhesive to make contact with the next wall until the corner is complete!

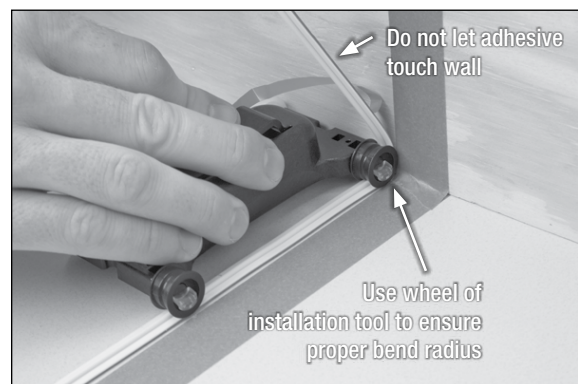

- b) Traverse corner with tool and continue duct application.



10.0 Planar Corner Installation

10.1 Peel adhesive liners and attach support in duct path.

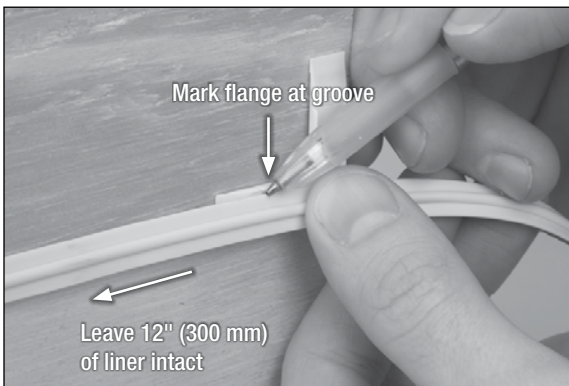
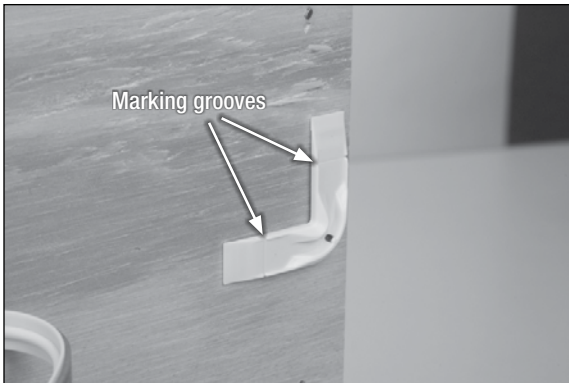

10.2 Trim the duct flange using the 3M™ One Pass Mini Duct Flange Removal Tool.

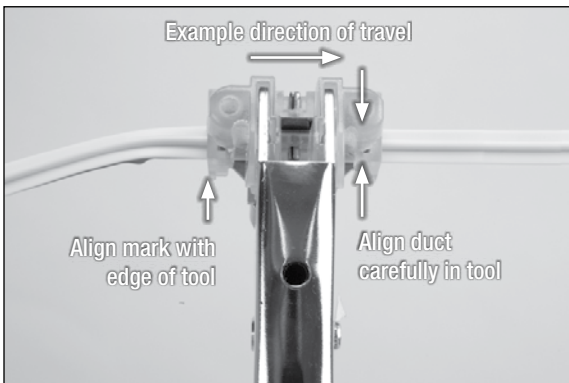

- Align flange against posts at back of tool. Align duct carefully; misalignment will damage the fiber.
- Align mark to left or right edge of tool, depending on direction of travel.

- Proceed SLOWLY and with CAUTION to cut flanges.

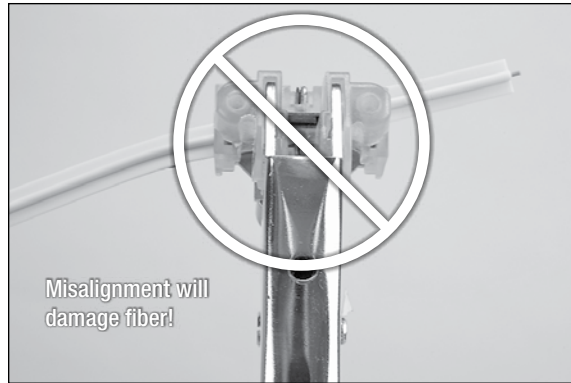

10.3 Remove liner, press firmly into place around corner.



Note: No support piece is used in instances where the 90° planar corner is not on the same wall surface, or when an angle other than 90° is used.



11.0 Mechanical Anchor Installation

- 11.1 Remove liner, align groove with duct and press firmly into place. The anchor may be secured with a T-25 staple if desired.

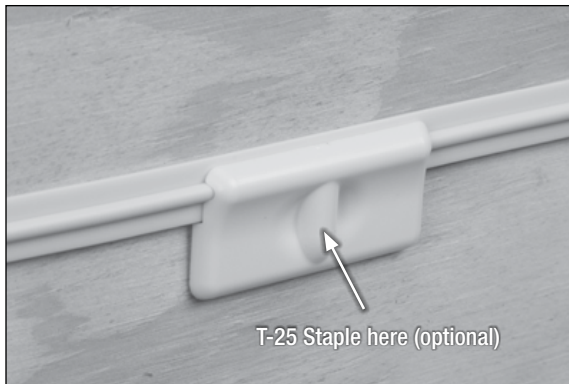

- Use the adhesive-backed anchor wherever additional adhesion is required, such as: high stress areas, low adhesion areas, or areas where duct has been pulled off the wall and has taken the surface with it.

12.0 Bridge Strip Installation

Bridges are used to span disruptions in the installation surface and to ensure a continuous, uninterrupted installation path for the duct. They can also be used to provide additional anchoring in locations where the wall surface is poor. This is critical to the performance of the duct. The duct adhesive must never encounter a disruption in the installation path. If it does, a mechanical anchor must be used before and after the disruption

- 12.1 Select a length of bridge strip according to the chart.

Height From Wall	Bridge Strip Length
less than 1" (25 mm)	6" (150 mm)
Up to 2" (51 mm)	12" (305 mm)

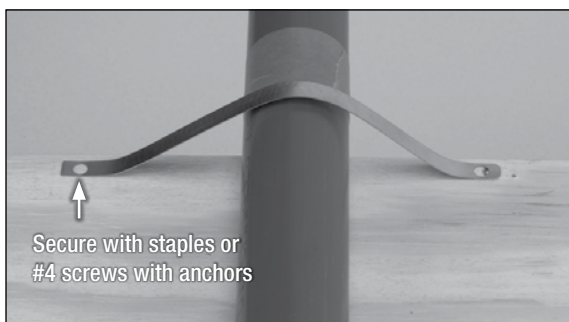

- Use the bridge strip when surface quality is poor for adhesion, or to span gaps/holes/obstructions on the installation surface.

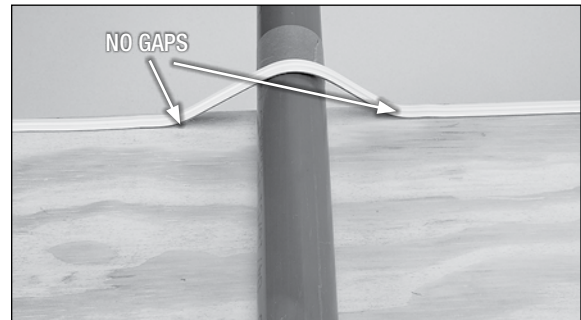

13.0 Wall Cover Installation

- 13.1 Remove the tab at the duct entry point as needed.

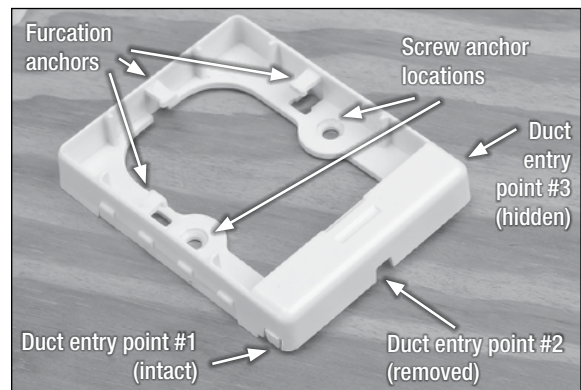

- 13.2 Fasten the cover to the wall after the duct is installed. The cover helps secure the end of the duct to the wall and covers the drilled living unit access hole.

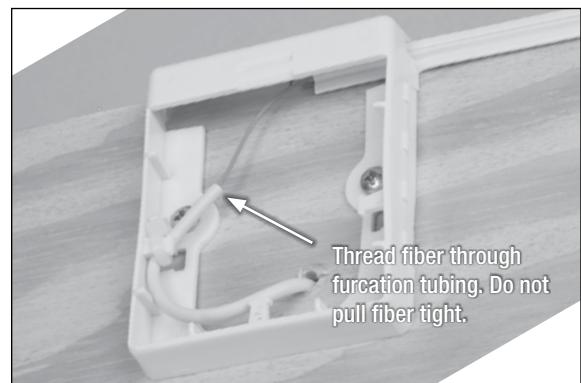

14.0 Connector Termination and Final Steps

14.1 Terminate the fiber using a 3M™ No Polish Connector or 3M™ Crimplok+ Connector.

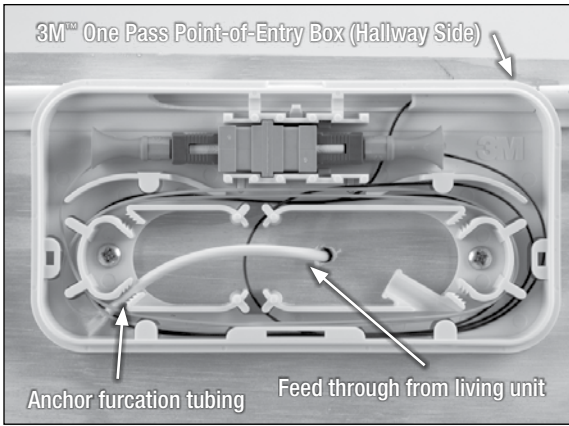

14.2 In buildings where the One Pass Fiber Pathway is not the horizontal cable pathway solution, terminate the hallway distribution cable (once a penetration hole is drilled) inside the living unit in a Point-of-Entry Box. Both the One Pass Mini Fiber Pathway and horizontal distribution cable will terminate here.

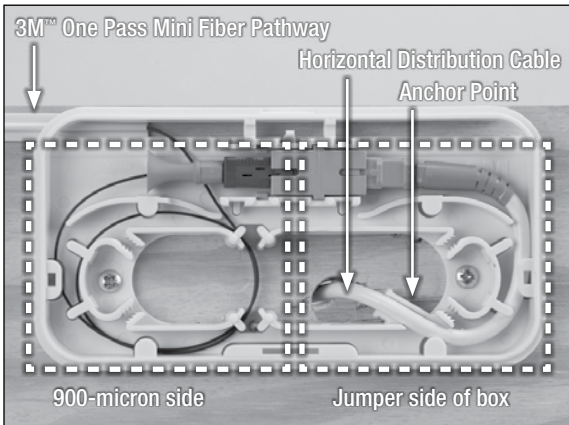

14.3 After completing installation of the entire run of duct and terminating the connector, route the 900 μm fiber and install the connector in the adapter as shown.

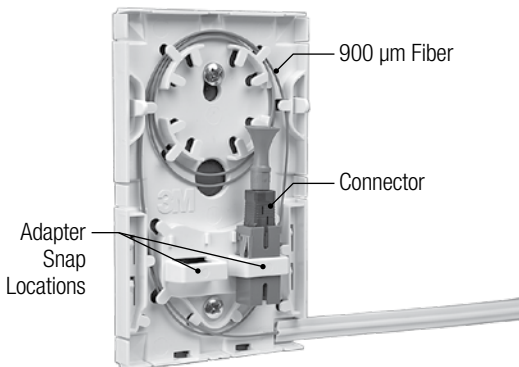

14.4 Attach the cover by aligning the bottom tabs to slots in the base of the box, and then snap the cover in place.



14.5 The tabs on the cover will hold the duct in place.



14.6 Align the connector to the adapter and plug. Slide the door closed.

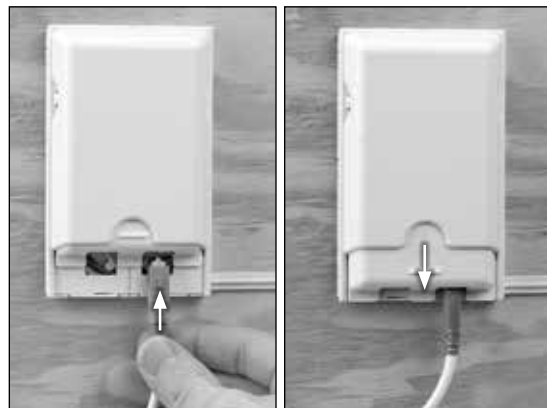

15.0 Fiber Repair

- 15.1 Ensure that the root cause for service interruption is damaged 900 μm .
- 15.2 Working away from the Wall Outlet, make small window cuts using the Window Cut Tool at every other corner or turn.

Note: *Additional window cuts at other corners may be made if needed.*

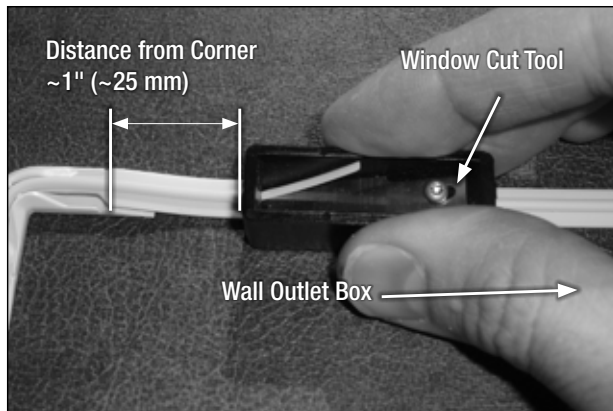

- 15.3 Cut connectors/fusion splice sleeves from the ends of the fiber stored inside the Wall Outlet and Point-of-Entry (POE) Cover of the damaged 900 μm fiber. Pull existing (gray) 900 μm fiber from installed duct and discard per company practice.

Note: *If pulling 900 μm is difficult the window cuts made in step 2 may be used as intermediate pull back locations.*

- 15.4 Wrap 2'-4' (600-1200 mm) of the new white 900 μm fiber into the Wall Outlet to create enough slack for connector termination and begin pushing it into the duct.

Note: *Keep new 900 μm off of the floor and clean as it is pushed into the duct to reduce floor debris from being carried into the duct.*

- 15.5 When the new white 900 μm fiber comes through each window cut, pull gently at that point to remove slack.

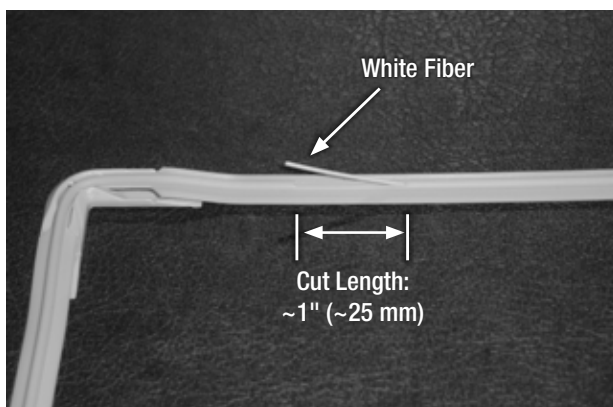

- 15.6 Begin pushing 900 μm out the other end of the window cut until the next window cut is reached.

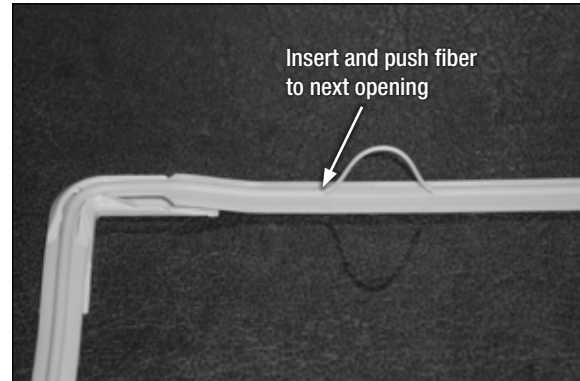

- 15.7 Repeat steps 5 and 6 until the new fiber is fully inserted into the duct, through provided furcation tubing, and into the Point-of-Entry (POE) Box. The fiber should be flush with each window cut.

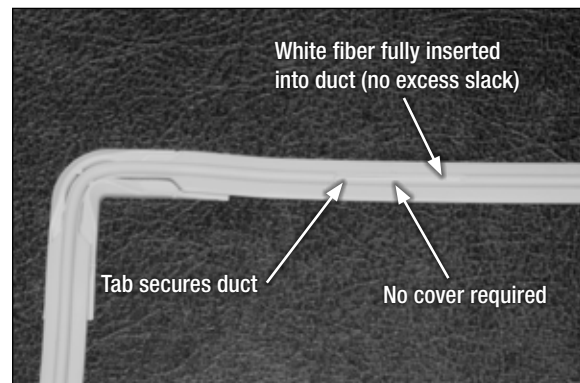

- 15.8 Terminate new 900 μm fiber per company practice.

3M and ScotchBlue are trademarks of 3M Company.

Important Notice

All statements, technical information, and recommendations related to 3M's products are based on information believed to be reliable, but the accuracy or completeness is not guaranteed. Before using this product, you must evaluate it and determine if it is suitable for your intended application. You assume all risks and liability associated with such use. Any statements related to the product which are not contained in 3M's current publications, or any contrary statements contained on your purchase order shall have no force or effect unless expressly agreed upon, in writing, by an authorized officer of 3M.

Warranty; Limited Remedy; Limited Liability.

This product will be free from defects in material and manufacture for a period of one (1) year from the time of purchase. **3M MAKES NO OTHER WARRANTIES INCLUDING, BUT NOT LIMITED TO, ANY IMPLIED WARRANTY OF MERCHANTABILITY OR FITNESS FOR A PARTICULAR PURPOSE.** If this product is defective within the warranty period stated above, your exclusive remedy shall be, at 3M's option, to replace or repair the 3M product or refund the purchase price of the 3M product. **Except where prohibited by law, 3M will not be liable for any indirect, special, incidental or consequential loss or damage arising from this 3M product, regardless of the legal theory asserted.**



Communication Markets Division

6801 River Place Blvd.
Austin, TX 78726-9000
1-800-426-8688
www.3M.com/Telecom

Please Recycle. Printed in USA.
© 3M 2012. All Rights Reserved.
78-0013-4441-1-D

Free Manuals Download Website

<http://myh66.com>

<http://usermanuals.us>

<http://www.somanuals.com>

<http://www.4manuals.cc>

<http://www.manual-lib.com>

<http://www.404manual.com>

<http://www.luxmanual.com>

<http://aubethermostatmanual.com>

Golf course search by state

<http://golfingnear.com>

Email search by domain

<http://emailbydomain.com>

Auto manuals search

<http://auto.somanuals.com>

TV manuals search

<http://tv.somanuals.com>