

# ASUS<sup>®</sup>

## V-Series P5V900

*ASUS PC (Desktop Barebone)*

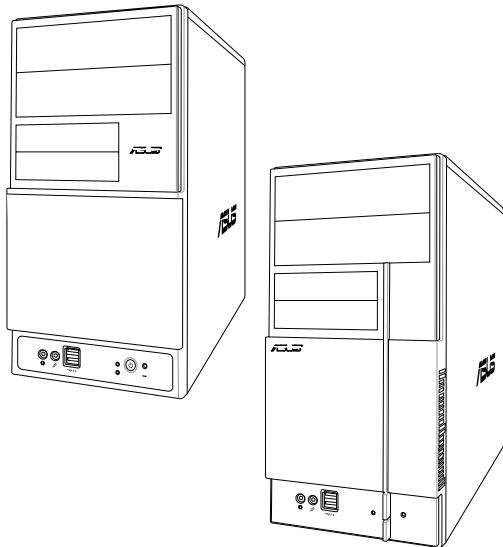

**E3071**

**First Edition  
December 2006**

**Copyright © 2006 ASUSTeK COMPUTER INC. All Rights Reserved.**

No part of this manual, including the products and software described in it, may be reproduced, transmitted, transcribed, stored in a retrieval system, or translated into any language in any form or by any means, except documentation kept by the purchaser for backup purposes, without the express written permission of ASUSTeK COMPUTER INC. ("ASUS").

Product warranty or service will not be extended if: (1) the product is repaired, modified or altered, unless such repair, modification or alteration is authorized in writing by ASUS; or (2) the serial number of the product is defaced or missing.

ASUS PROVIDES THIS MANUAL "AS IS" WITHOUT WARRANTY OF ANY KIND, EITHER EXPRESS OR IMPLIED, INCLUDING BUT NOT LIMITED TO THE IMPLIED WARRANTIES OR CONDITIONS OF MERCHANTABILITY OR FITNESS FOR A PARTICULAR PURPOSE. IN NO EVENT SHALL ASUS, ITS DIRECTORS, OFFICERS, EMPLOYEES OR AGENTS BE LIABLE FOR ANY INDIRECT, SPECIAL, INCIDENTAL, OR CONSEQUENTIAL DAMAGES (INCLUDING DAMAGES FOR LOSS OF PROFITS, LOSS OF BUSINESS, LOSS OF USE OR DATA, INTERRUPTION OF BUSINESS AND THE LIKE), EVEN IF ASUS HAS BEEN ADVISED OF THE POSSIBILITY OF SUCH DAMAGES ARISING FROM ANY DEFECT OR ERROR IN THIS MANUAL OR PRODUCT.

SPECIFICATIONS AND INFORMATION CONTAINED IN THIS MANUAL ARE FURNISHED FOR INFORMATIONAL USE ONLY, AND ARE SUBJECT TO CHANGE AT ANY TIME WITHOUT NOTICE, AND SHOULD NOT BE CONSTRUED AS A COMMITMENT BY ASUS. ASUS ASSUMES NO RESPONSIBILITY OR LIABILITY FOR ANY ERRORS OR INACCURACIES THAT MAY APPEAR IN THIS MANUAL, INCLUDING THE PRODUCTS AND SOFTWARE DESCRIBED IN IT.

Products and corporate names appearing in this manual may or may not be registered trademarks or copyrights of their respective companies, and are used only for identification or explanation and to the owners' benefit, without intent to infringe.

# Table of contents

|                              |      |
|------------------------------|------|
| Notices .....                | vi   |
| Safety information .....     | vii  |
| About this guide.....        | viii |
| System package contents..... | x    |

## Chapter 1: System Introduction

|                                 |     |
|---------------------------------|-----|
| 1.1 Welcome! .....              | 1-2 |
| 1.2 Front panel (external)..... | 1-2 |
| 1.3 Rear panel.....             | 1-4 |
| 1.4 Internal components.....    | 1-7 |

## Chapter 2: Basic Installation

|  |      |
|--|------|
| 2.1 Preparation .....                                      | 2-2  |
| 2.2 Before you proceed .....                               | 2-2  |
| 2.3 Removing the side cover and front panel assembly ..... | 2-3  |
| 2.4 Central Processing Unit (CPU) .....                    | 2-4  |
| 2.4.1 Overview .....                                       | 2-4  |
| 2.4.2 Installing the CPU.....                              | 2-4  |
| 2.4.3 Installing the CPU fan and heatsink assembly.....    | 2-6  |
| 2.5 Installing a DIMM .....                                | 2-8  |
| 2.5.1 Memory configurations .....                          | 2-8  |
| 2.5.2 Installing a DDR2 DIMM .....                         | 2-11 |
| 2.5.3 Removing a DDR2 DIMM.....                            | 2-11 |
| 2.6 Expansion slots .....                                  | 2-12 |
| 2.6.1 Installing an expansion card .....                   | 2-12 |
| 2.6.2 Configuring an expansion card.....                   | 2-12 |
| 2.6.3 PCI Express x1 slot .....                            | 2-14 |
| 2.6.4 PCI slots .....                                      | 2-14 |
| 2.6.5 PCI Express x16 slot .....                           | 2-14 |
| 2.7 Installing an optical drive .....                      | 2-15 |
| 2.8 Installing a hard disk drive .....                     | 2-17 |
| 2.9 Installing a floppy disk drive.....                    | 2-20 |
| 2.10 Re-connecting cables.....                             | 2-21 |
| 2.11 Reinstalling the cover .....                          | 2-22 |

# Table of contents

## Chapter 3: Starting up

|       |                                     |     |
|-------|-------------------------------------|-----|
| 3.1   | Installing an operating system..... | 3-2 |
| 3.2   | Powering up .....                   | 3-2 |
| 3.3   | Support CD information .....        | 3-2 |
| 3.3.1 | Running the support CD.....         | 3-3 |
| 3.3.2 | Utilities menu .....                | 3-4 |
| 3.3.3 | Make disk .....                     | 3-5 |
| 3.3.4 | Manual.....                         | 3-5 |
| 3.3.5 | ASUS Contact information .....      | 3-6 |
| 3.4   | Software information.....           | 3-7 |

## Chapter 4: Motherboard Info

|     |                          |     |
|-----|--------------------------|-----|
| 4.1 | Introduction .....       | 4-2 |
| 4.2 | Motherboard layout ..... | 4-2 |
| 4.3 | Jumpers .....            | 4-3 |
| 4.4 | Connectors .....         | 4-6 |

Cha



# Table of contents

|       |                                    |      |
|-------|------------------------------------|------|
| 5.2.4 | Menu items .....                   | 5-13 |
| 5.2.5 | Sub-menu items .....               | 5-13 |
| 5.2.6 | Configuration fields .....         | 5-13 |
| 5.2.7 | Pop-up window .....                | 5-14 |
| 5.2.8 | General help .....                 | 5-14 |
| 5.3   | Main menu .....                    | 5-15 |
| 5.3.1 | System Time .....                  | 5-15 |
| 5.3.2 | System Date .....                  | 5-15 |
| 5.3.3 | Primary IDE Master/Slave .....     | 5-16 |
| 5.3.4 | SATA 1/2 .....                     | 5-18 |
| 5.3.5 | HDD SMART Monitoring .....         | 5-19 |
| 5.3.6 | Installed Memory .....             | 5-19 |
| 5.3.7 | Usable Memory .....                | 5-19 |
| 5.4   | Advanced menu .....                | 5-19 |
| 5.4.1 | CPU Configuration .....            | 5-20 |
| 5.4.2 | Chipset .....                      | 5-21 |
| 5.4.3 | PCI/PnP .....                      | 5-22 |
| 5.4.4 | Onboard Device Configuration ..... | 5-23 |
| 5.4.5 | USB Configuration .....            | 5-24 |
| 5.5   | Power menu .....                   | 5-25 |
| 5.5.1 | ACPI Suspend Type .....            | 5-25 |
| 5.5.2 | ACPI APIC Support .....            | 5-25 |
| 5.5.3 | APM Configuration .....            | 5-26 |
| 5.5.4 | Hardware Monitor .....             | 5-28 |
| 5.6   | Boot menu .....                    | 5-30 |
| 5.6.1 | Boot Device Priority .....         | 5-30 |
| 5.6.2 | Boot Settings Configuration .....  | 5-31 |
| 5.6.3 | Security .....                     | 5-32 |
| 5.7   | Tool menu .....                    | 5-33 |
| 5.8   | Exit menu .....                    | 5-33 |

# Notices

## Federal Communications Commission

When the user is required to connect the monitor to the ground, it is required to assure compliance with FCC regulations. Changes or modifications to this unit not expressly approved by the party responsible for compliance could void the user's authority to operate this equipment.

This page is blank.

# Safety information

## Electrical safety

- To prevent electrical shock hazard, disconnect the power cable from the electrical outlet before relocating the system.
- When adding or removing devices to or from the system, ensure that the power cables for the devices are unplugged before the signal cables are connected.
- If the power supply is broken, do not try to fix it by yourself. Contact a qualified service technician or your retailer.

## Operation safety

- Before installing devices into the system, carefully read all the documentation that came with the package.
- Before using the product, make sure all cables are correctly connected and the power cables are not damaged. If you detect any damage, contact your dealer immediately.
- To avoid short circuits, keep paper clips, screws, and staples away from connectors, slots, sockets and circuitry.
- Avoid dust, humidity, and temperature extremes. Do not place the product in any area where it may become wet. Place the product on a stable surface.
- If you encounter technical problems with the product, contact a qualified service technician or your retailer.

### *Lithium-Ion Battery Warning*

**CAUTION:** Danger of explosion if battery is incorrectly replaced. Replace only with the same or equivalent type recommended by the manufacturer. Dispose of used batteries according to the manufacturer's instructions.

**VORSICHT:** Explosionsgefahr bei unsachgemäßen Austausch der Batterie. Ersatz nur durch denselben oder einem vom Hersteller empfohlenem ähnlichen Typ. Entsorgung gebrauchter Batterien nach Angaben des Herstellers.

### *LASER PRODUCT WARNING*

**CLASS 1 LASER PRODUCT**

# About this guide

## Audience

This guide provides general information and installation instructions about the ASUS V-Series P5V900 barebone system. This guide is intended for experienced users and integrators with hardware knowledge of personal computers.

## How this guide is organized

This guide contains the following parts:

### 1. Chapter 1: System introduction

This chapter gives a general description of the ASUS V-Series P5V900. The chapter lists the system features, including introduction on the front and rear panel, and internal components.

### 2. Chapter 2: Basic installation

This chapter provides step-by-step instructions on how to install components in the system.

### 3. Chapter 3: Starting up

This chapter helps you power up the system and install drivers and utilities from the support CD.

### 4. Chapter 4: Motherboard information

This chapter gives information about the motherboard that comes with the system. This chapter includes the motherboard layout, jumper settings, and connector locations.

### 5. Chapter 5: BIOS information

This chapter tells how to change system settings through the BIOS Setup menus and describes the BIOS parameters.



## Conventions used in this guide



**WARNING:** Information to prevent injury to yourself when trying to complete a task.



**CAUTION:** Information to prevent damage to the components when trying to complete a task.



**IMPORTANT:** Instructions that you **MUST** follow to complete a task.



**NOTE:** Tips and additional information to aid in completing a task.

## Where to find more information

Refer to the following sources for additional information and for product and software updates.

### 1. ASUS Websites

The ASUS websites worldwide provide updated information on ASUS hardware and software products. Refer to the ASUS contact information.

### 2. Optional Documentation

Your product package may include optional documentation, such as warranty flyers, that may have been added by your dealer. These documents are not part of the standard package.

# System package contents

Check your V-Series P5V900 system package for the following items.



If any of the items is damaged or missing, contact your retailer immediately.

| Item description                                    |
|---|
| <b>1. ASUS V-Series P5V900 barebone system</b> with |
| • ASUS motherboard                                  |
| • 300 W (peak) PFC power supply unit                |
| • ASUS chassis                                      |
| <b>2. Cable</b>                                     |
| • AC power cable                                    |
| <b>3. Support CD</b>                                |
| <b>4. User guide</b>                                |

# Chapter 1

This chapter gives a general description of the ASUS V-Series P5V900. The chapter lists the system features including introduction on the front and rear panel, and internal components.

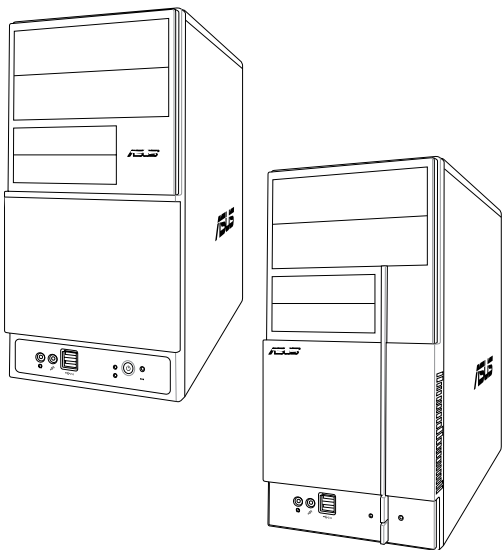

# System introduction

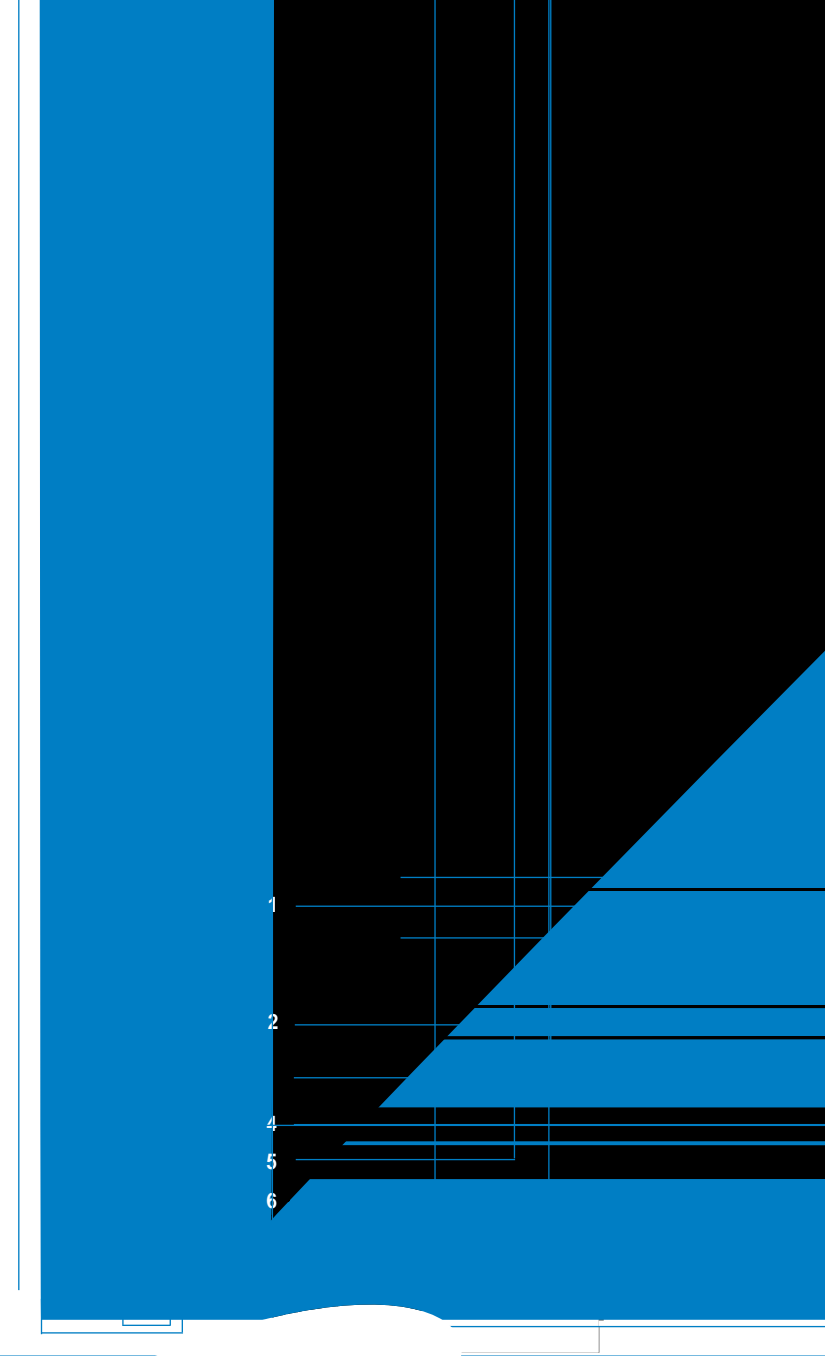

1. **Two empty 5.25-inch bays.** These bays are for IDE optical drives.
2. **3.5-inch drive bays.** These slots are for 3.5-inch floppy or hard disk drives.
3. **Power button.** Press this button to turn the system on.
4. **Reset button.** Press this button to reboot the system without turning off the power.
5. **HDD LED.** This LED lights up when data is read from or written to the hard disk drive.
6. **USB 2.0 ports.** These Universal Serial Bus 2.0 (USB 2.0) ports are available for connecting USB 2.0 devices such as a mouse, printer, scanner, camera, PDA, and others.
7. **Headphone port.** This Line In (green) port connects a headphone with a stereo mini-plug.
8. **Microphone port.** This Mic (pink) port connects a microphone.

# 13 Rear panel

The server rear panel includes a power connector and several I/O ports for peripheral connection devices.

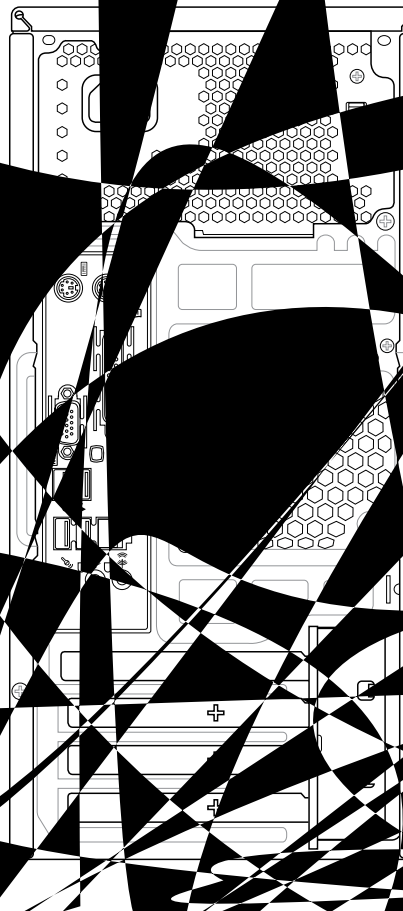

1 Power ports

6. **Parallel port.** This 25-pin port connects a printer, scanner, or other devices.
7. **VGA port.** This port connects a VGA monitor.
8. **USB 2.0 ports 1, 2, 3 and 4.** These 4-pin Universal Serial Bus (USB) ports are available for connecting USB 2.0 devices.
9. **Microphone port (pink).** This port connects a microphone.
10. **Line Out port (lime).** This port connects a headphone or a speaker. In 4-channel and 6-channel configuration, the function of this port becomes Front Speaker Out.
11. **Line In port (light blue).** This port connects the tape, CD, DVD player, or other audio sources.
12. **Power supply unit fan vent.** This vent is for the PSU fan that provides ventilation inside the power supply unit.
13. **Chassis fan vent.** This vent is for the fan that provides ventilation inside the system chassis.
14. **LAN (RJ-45) port.** This port allows Gigabit connection to a Local Area Network (LAN) through a network hub.
15. **Expansion slot covers.** Remove these covers when installing expansion cards.



Refer to the audio configuration table below for the function of the audio ports in 2, 4, or 6-channel configuration.

### Audio 2, 4, or 6-channel configuration

| Port       | Headset<br>2-speaker | 4-speaker         | 6-speaker         |
|------------|----------------------|-------------------|-------------------|
| Light Blue | Line In              | Surround Out      | Surround Out      |
| Lime       | Line Out             | Front Speaker Out | Front Speaker Out |
| Pink       | Mic In               | Mic In            | Center/Bass       |

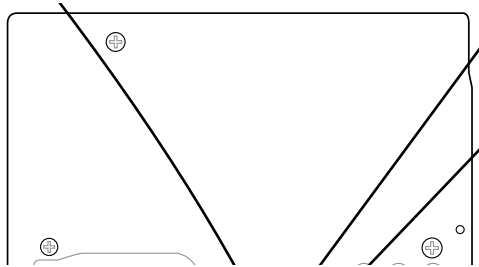



## 1.4 Internal components

The illustration below is the internal view of the system when you remove the top cover and the power supply unit. The installed components are labeled for your reference. Proceed to Chapter 2 for instructions on installing additional system components.

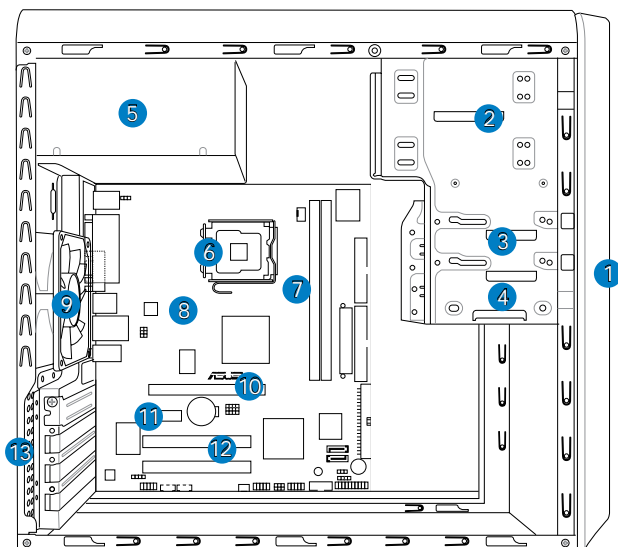

- |                                 |                          |
|---------------------------------|--------------------------|
| 1. Front panel cover            | 8. ASUS motherboard      |
| 2. 5.25-inch optical drive bays | 9. Chassis fan           |
| 3. Hard disk drive bay          | 10. PCI Express x16 slot |
| 4. Floppy disk drive bay        | 11. PCI Express x1 slot  |
| 5. Power supply unit            | 12. PCI slots            |
| 6. CPU socket                   | 13. Metal bracket lock   |
| 7. DIMM sockets                 |                          |



# Chapter 2

This chapter provides step-by-step instructions on how to install components in the system.

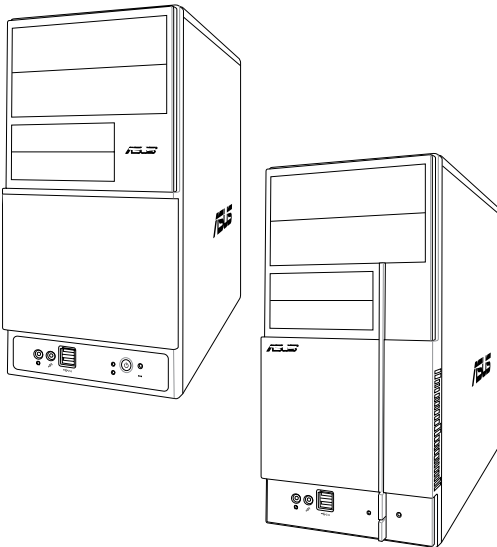

# Basic installation

## 2.1 Preparation

Before you proceed, make sure that you have all the components you plan to install in the system. Basic components to install

Bas

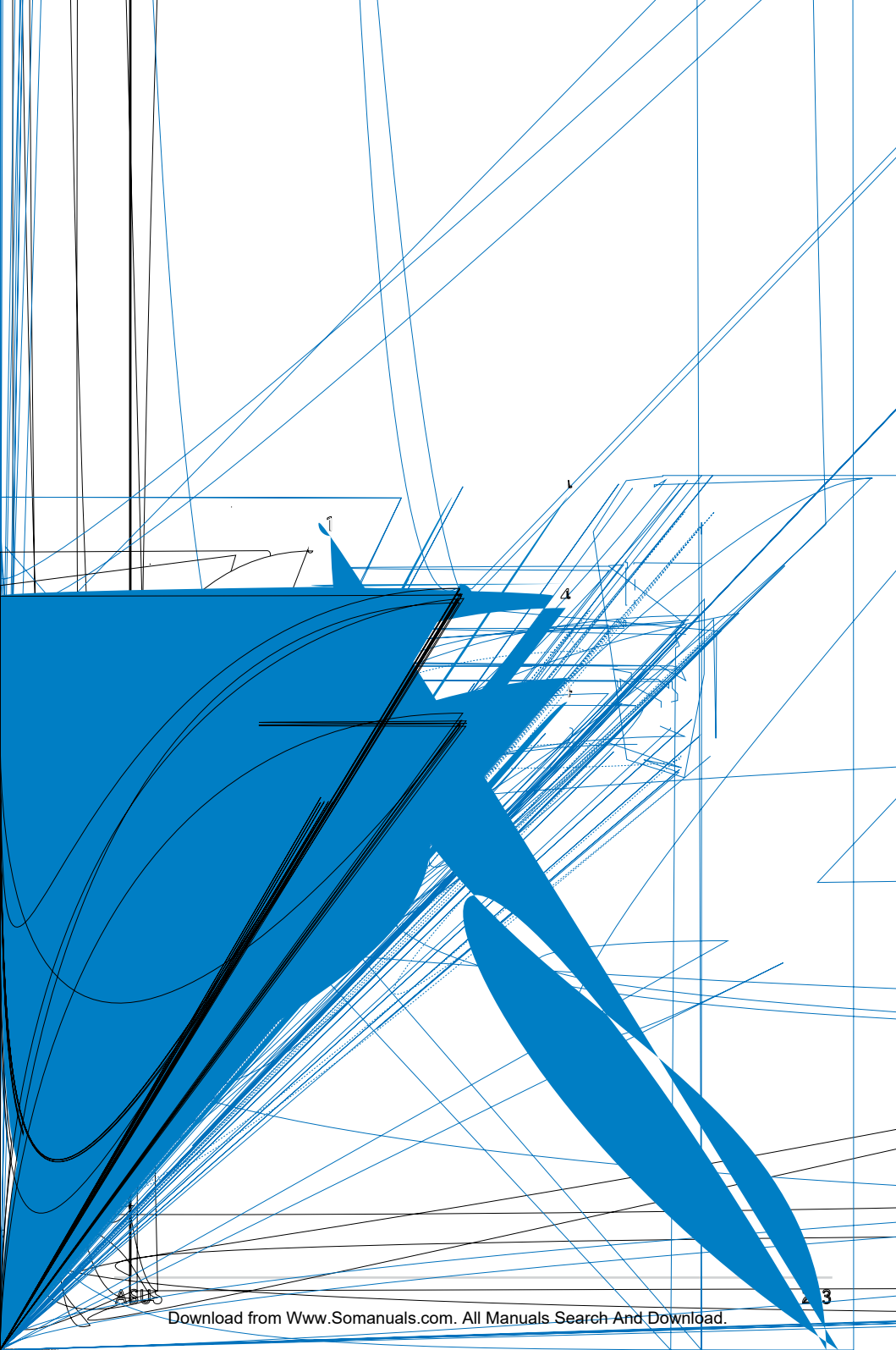

## 2.4 Central Processing Unit (CPU) 2.4.1

### 2.4.1 Overview

---

3. Lift the load lever in the direction of the arrow to a 135° angle.
4. Lift the load plate with your thumb and forefinger to a 100° angle (4A), then push the PnP cap from the load plate window to remove (4B).

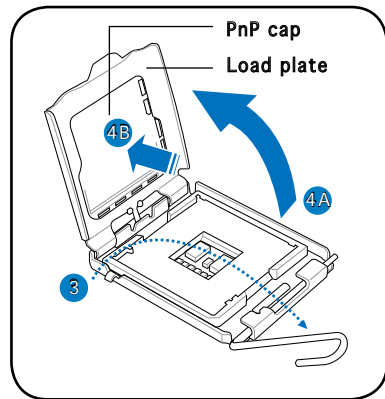

5. Position the CPU over the socket, making sure that the gold triangle is on the bottom-left corner of the socket then fit the socket alignment key into the CPU notch.

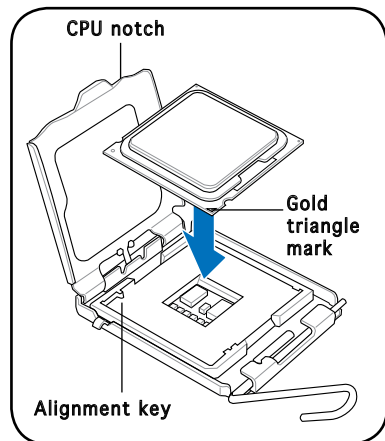

6. Apply Thermal Interface Material on the CPU before closing the load plate.



**DO NOT** eat the Thermal Interface Material. If it gets into your eyes or touches your skin, make sure to wash it off immediately, and seek professional medical help.

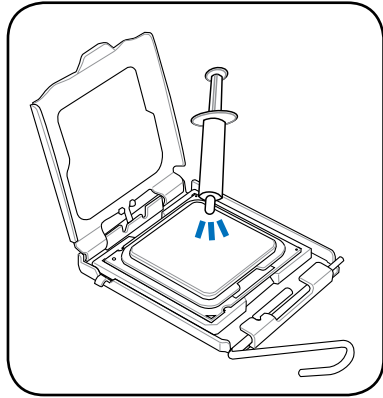

7. Close the load plate (A), then push the load lever (B) until it snaps into the retention tab.

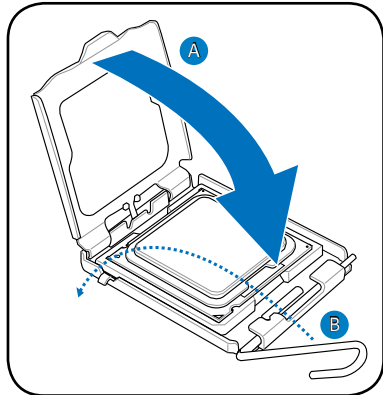

### 2.4.3 Installing the CPU fan and heatsink assembly

The Intel® Pentium® 4 LGA775 processor requires a specially designed heatsink and fan assembly to ensure optimum thermal condition and performance.



- When you buy a boxed Intel® Pentium® 4 processor, the package includes the CPU fan and heatsink assembly. If you buy a CPU separately, make sure that you use only Intel®-certified multi-directional heatsink and fan.
- Your Intel® Pentium® 4 LGA775 heatsink and fan assembly comes in a push-pin design and requires no tool to install.





If you purchased a separate CPU heatsink and fan assembly, make sure that the Thermal Interface Material is properly applied to the CPU heatsink or CPU before you install the heatsink and fan assembly.

To install the CPU heatsink and fan:

1. Place the heatsink on top of the installed CPU, making sure that the four fasteners match the holes on the motherboard.
2. Push down two fasteners at a time in a diagonal sequence to secure the heatsink and fan assembly in place.

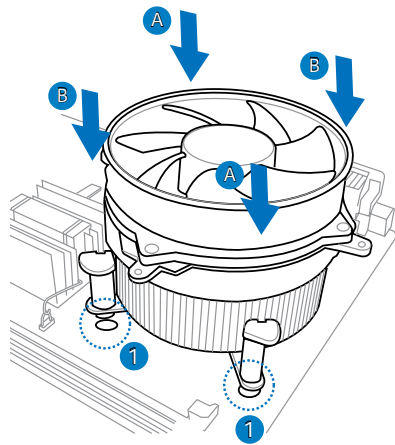
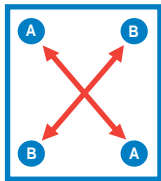

3. When the fan and heatsink assembly is in place, connect the CPU fan cable to the connector on the motherboard.

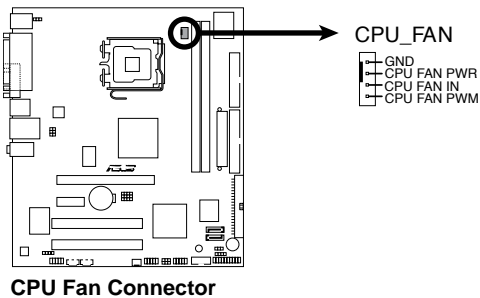

Do not forget to connect the CPU fan connector! Hardware monitoring errors can occur if you fail to plug this connector.

## 2.5 Installing a DIMM

The system motherboard comes with two Double Data Rate 2 (DDR2) Dual Inline Memory Module (DIMM) sockets.

The following figure illustrates the location of the sockets:

Memory configurations You may install up to 4 GB system memory using 2371M



- 
- Install only **identical** (the same type and size) DDR2 memory modules.
  - Install only ASUS-certified memory modules. Refer to the DDR2 Qualified Vendors List on the next page for details.
  - Always install DIMMs with the same CAS latency. For optimum compatibility, we recommend that you obtain memory modules from the same vendor.
-

## Qualified Vendors Lists (QVL)

| Size | Vendor | Model |  |
|------|--------|-------|--|
|------|--------|-------|--|

DDR2-0

| Size | Vendor | Model | Side(s) | Component | A | B |
|------|--------|-------|---------|-----------|---|---|
|------|--------|-------|---------|-----------|---|---|

## 2.5.2 Installing a DDR2 DIMM



Make sure to unplug the power supply before adding or removing DIMMs or other system components. Failure to do so may cause severe damage to both the motherboard and the components.

1. Unlock a DDR2 DIMM socket by pressing the retaining clips outward.
2. Align a DIMM on the socket such that the notch on the DIMM matches the break on the socket.

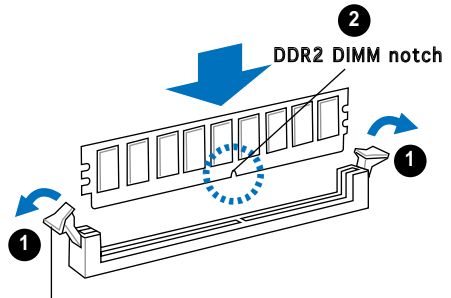

Unlocked retaining clip



A DDR2 DIMM is keyed with a notch so that it fits in only one direction. DO NOT force a DIMM into a socket to avoid damaging the DIMM.

3. Firmly insert the DIMM into the socket until the retaining clips snap back in place and the DIMM is properly seated.

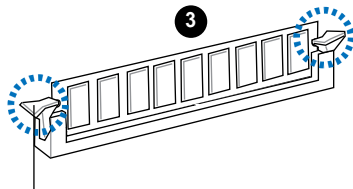

Locked Retaining Clip

## 2.5.3 Removing a DDR2 DIMM

Follow these steps to remove a DIMM.

1. Simultaneously press the retaining clips outward to unlock the DIMM.

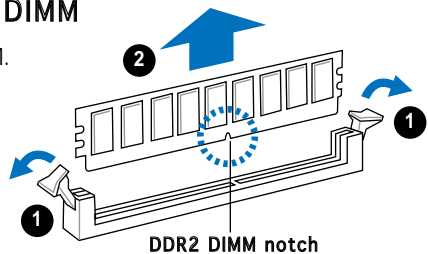

Support the DIMM lightly with your fingers when pressing the retaining clips. The DIMM might get damaged when it flips out with extra force.

2. Remove the DIMM from the socket.

## 2.6 Expansion slots

In the future, you may need to install expansion cards. The following sub-sections describe the slots and the expansion cards that they support.



---

Make sure to unplug the power cord before adding or removing expansion cards. Failure to do so may cause you physical injury and damage motherboard components.

---

### 2.6.1 Installing an expansion card

To install an expansion card:

1. Before installing the expansion card, read the documentation that came with it and make the necessary hardware settings for the card.
2. Remove the system unit cover (if your motherboard is already installed in a chassis).
3. Remove the bracket opposite the slot that you intend to use. Keep the screw for later use.
4. Align the card connector with the slot and press firmly until the card is completely seated on the slot.
5. Secure the card to the chassis with the screw you removed earlier.
6. Replace the system cover.

### 2.6.2 Configuring an expansion card

After installing the expansion card, configure it by adjusting the software settings.

1. Turn on the system and change the necessary BIOS settings, if any. See Chapter 5 for information on BIOS setup.
2. Assign an IRQ to the card. Refer to the tables on the next page.
3. Install the software drivers for the expansion card.

## Standard interrupt assignments

| IRQ | Standard Function            |
|-----|------------------------------|
| 0   | System Timer                 |
| 1   | Keyboard Controller          |
| 2   | Re-direct to IRQ#9           |
| 4   | Communications Port (COM1)*  |
| 5   | IRQ holder for PCI steering* |
| 6   | Floppy Disk Controller       |
| 7   | Printer Port (LPT1)*         |
| 8   | System CMOS/Real Time Clock  |
| 9   | IRQ holder for PCI steering* |
| 10  | IRQ holder for PCI steering* |
| 11  | IRQ holder for PCI steering* |
| 12  | PS/2 Compatible Mouse Port*  |
| 13  | Numeric Data Processor       |
| 14  | Primary IDE Channel          |
| 15  | Secondary IDE Channel        |

\* These IRQs are usually available for ISA or PCI devices.

## IRQ assignments for this motherboard

|                            | A      | B      | C      | D      | E | F | G | H      |
|----------------------------|--------|--------|--------|--------|---|---|---|--------|
| PCI slot 1                 | shared | —      | —      | —      | — | — | — | —      |
| PCI slot 2                 | —      | shared | —      | —      | — | — | — | —      |
| PCI Express x16 slot       | shared | —      | —      | —      | — | — | — | —      |
| PCI Express x1 slot        | —      | shared | —      | —      | — | — | — | —      |
| Onboard USB controller 1   | —      | —      | —      | —      | — | — | — | shared |
| Onboard USB controller 2   | —      | —      | —      | shared | — | — | — | —      |
| Onboard USB controller 3   | —      | —      | shared | —      | — | — | — | —      |
| Onboard USB controller 4   | —      | —      | —      | shared | — | — | — | —      |
| Onboard USB 2.0 controller | —      | —      | —      | —      | — | — | — | shared |
| Onboard IDE port           | —      | —      | —      | shared | — | — | — | —      |
| Onboard HD audio           | shared | —      | —      | —      | — | — | — | —      |
| Onboard LAN                | —      | shared | —      | —      | — | — | — | —      |



When using PCI cards on shared slots, ensure that the drivers support “Share IRQ” or that the cards do not need IRQ assignments. Otherwise, conflicts will arise between the two PCI groups, making the system unstable and the card inoperable.





## 2.7 Installing an optical drive

Refer to the instructions in this section if you wish to install a new optical drive.

Follow these steps to install an optical drive:

1. Place the chassis upright.
2. Remove the drive slot metal plate cover.
3. Insert the optical drive into the upper 5.25-inch drive bay and carefully push the optical drive into the bay until its screw holes align with the holes on the bay as shown.
4. Secure the optical drive with two screws on both sides of the bay.

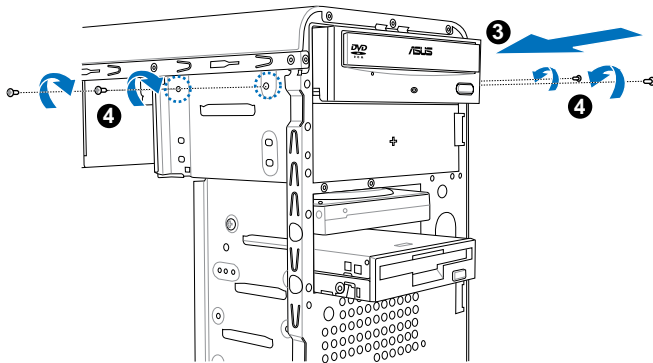

5. Connect a power cable from the power supply to the power connector at the back of the optical drive.
6. Connect one end of the IDE ribbon cable to the IDE interface at the back of the optical drive, matching the red stripe on the cable with Pin 1 on the IDE interface.

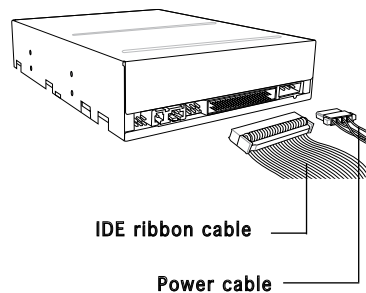

7. Connect the other end of the IDE ribbon cable to the secondary IDE connector (labeled SEC\_IDE) on the motherboard. See page 4-7 for the location of this connector.
8. Remove the dummy drive slot cover from the front panel.
9. Replace the front panel.

## 2.8 Installing a hard disk drive

The system may have one pre-installed 3.5-inch Serial ATA or IDE hard disk drive. Refer to this section to install additional Serial ATA or IDE hard disk drive(s).

To install a Serial ATA hard disk drive:

1. Place the chassis upright.
2. Use a screw driver to remove the HDD drive slot metal plate cover.

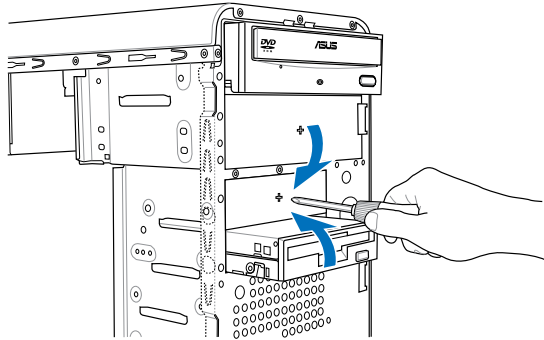

3. With the HDD label side up, carefully insert the drive into the 3.5-inch bay and push the drive into the bay until its screw holes align with the holes on the drive bay.

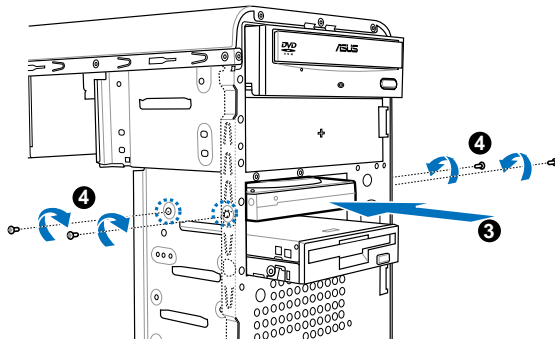

4. Secure the drive with two screws on both sides.

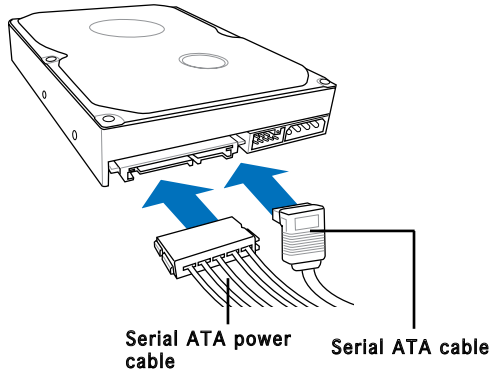

5. Connect one end of the Serial ATA cable to the SATA connector at the back of the drive, then connect the other end to a Serial ATA connector on the motherboard. See page 4-6 for the location of the Serial ATA connectors.
6. Connect a 15-pin Serial ATA power plug from the power supply unit to the 15-pin power connector at the back of the drive.

- OR -

Connect a 4-pin (female) power plug from the power supply unit to the 4-pin (male) power connector at the back of the drive.



---

If your Serial ATA HDD has both 4-pin and 15-pin connectors at the back, use either the 15-pin SATA power adapter plug **OR** the legacy 4-pin power connector. **DO NOT** use both to prevent damage to components and to keep the system from becoming unstable.

---

To install an IDE hard disk drive:

1. Follow steps 1-4 of the previous section.
2. Connect the blue interface of the IDE ribbon cable to the primary IDE connector (blue connector labeled PRI\_IDE) on the motherboard. See page 4-7 for the location of the connector.

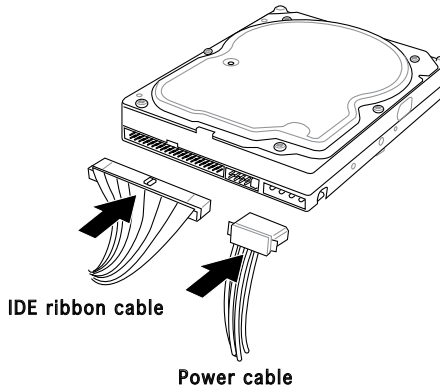

- If you will install only one hard disk drive, make sure to configure your hard disk drive as Master device before connecting the IDE cable and power plug. Refer to the HDD documentation on how to set the drive as a Master device.
- If you will install two IDE hard disk drives, configure the other device as Slave.

3. Connect the gray interface of the IDE ribbon cable to the IDE connector on the drive.
4. If you install two IDE hard disk drives, connect the black interface of the IDE ribbon cable to the IDE connector on the second (Slave) IDE hard disk drive.
5. Connect a 4-pin power plug from the power supply unit to the power connector at the back of the drive(s).

## 2.9 Installing a floppy disk drive

The V-Series P5V900 system comes with one 3.25-inch drive bay for a floppy disk drive.

To install a floppy disk drive:

1. Remove the front panel cover.
2. Carefully insert the floppy disk drive into the floppy drive bay until the screw holes align with the holes on the bay.
3. Secure the floppy disk drive with two screws on both sides.

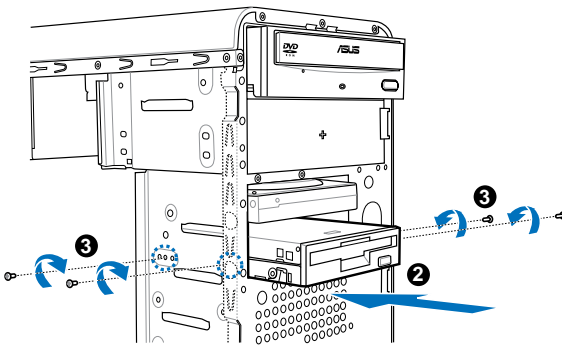

4. Connect the floppy disk drive signal cable to the signal connector at the back of the drive.

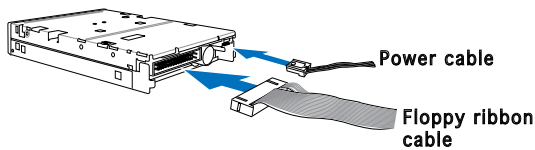

5. Connect the other end of the signal cable to the floppy disk drive connector on the motherboard. See page 4-6 for the location of the floppy disk drive connector.
6. Connect a 4-pin power cable from the power supply unit to the power connector at the back of the floppy disk drive.

## 2.10 Re-connecting cables

You may have disconnected some cables when you were installing components. You must re-connect these cables before you replace the chassis cover.

### LED cables

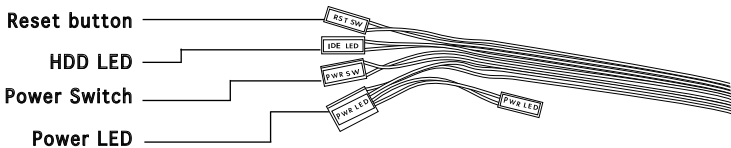

Connect the **reset button**, **power switch**, **power LED**, and **HDD LED** cables to their respective leads in the system panel connector on the motherboard.

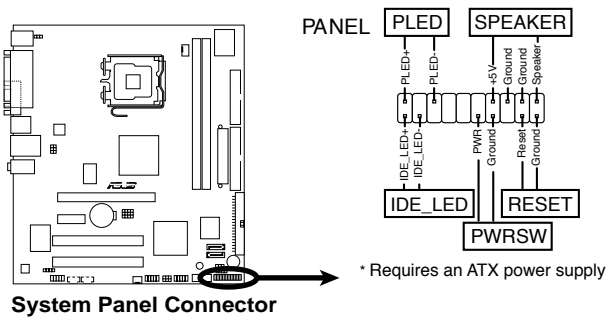

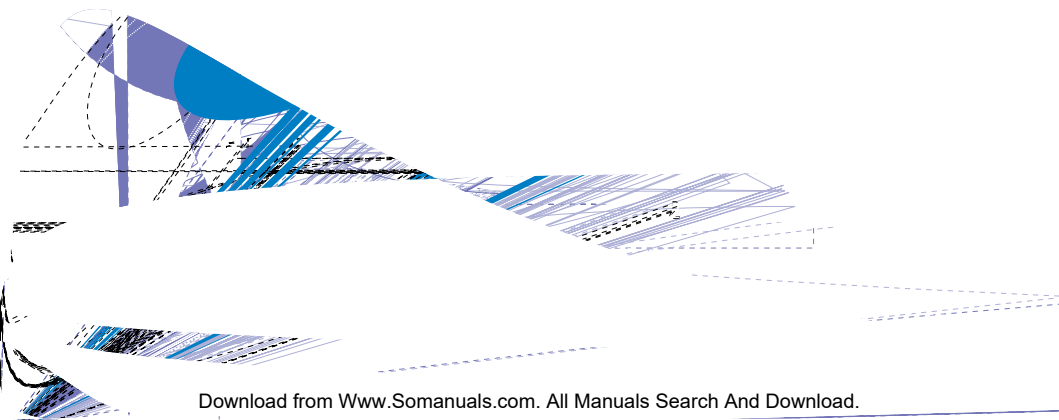



# Chapter 3

This chapter helps you power up the system and install drivers and utilities from the support CD.

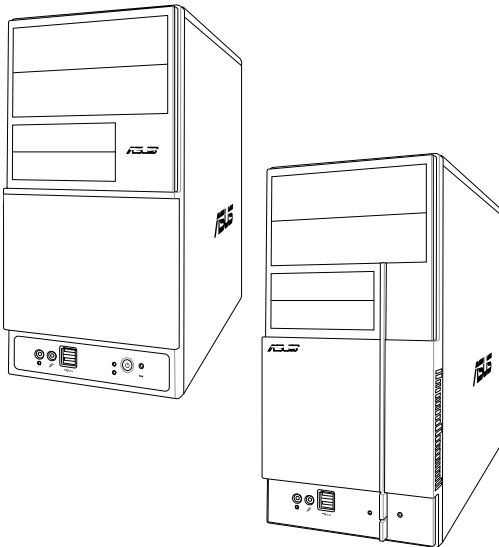

# Starting up

## 3.1 Installing an operating system

The barebone system supports Windows® 2000/XP operating systems (OS). Always install the latest OS version and corresponding updates so you can maximize the features of your hardware.



Because motherboard settings and hardware options vary, use the setup procedures presented in this chapter for general reference only. Refer to your OS documentation for more information.



- Windows XP OS setup cannot recognize Serial ATA hard drives without the necessary drivers. Use the bundled floppy disk when installing Windows XP OS to a Serial ATA hard drive.
- From the Windows XP setup screen, press F6 when prompted then follow succeeding screen instructions to install the SATA drivers.

## 3.2 Powering up

Press the system power button to enter the OS.

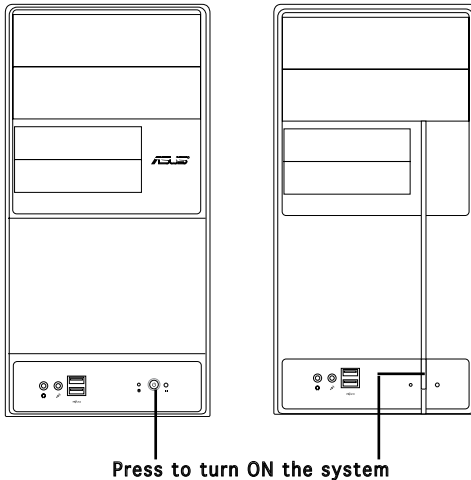

## 3.3 Support CD information

The support CD that came with the system contains useful software and several utility drivers that enhance the system features.



- Screen display and driver options may not be the same for different operating system versions.
- The contents of the support CD are subject to change at any time without notice. Visit the ASUS website for updates.



### 3.3.2 Utilities menu

The Utilities menu shows the applications and other software that the motherboard supports.

#### **ASUS InstAll-Installation Wizard for Utilities**

Installs the ASUS InstAll-Installation Wizard Utilities.

**ASUS PC Probe II** This smart utility monitors the fan speed, CPU temperature, and

### **3.3.3 Make Disk**

#### **Make VIA VT8237 RAID Driver Disk**

Make the VIA VT8237 RAID Driver Disk.

### **3.3.4 Manual**

#### **Intel LGA775 CPU install User's Manual**

Install the Intel LGA775 CPU install user manual.

#### **VIA VT8237 RAID User's Manual**

Install the VIA VT8237 RAID user manual.

### 3.3.5 ASUS Contact information

Click the **Contact** tab to display the ASUS contact information. You can also find this information on the inside front cover of this user guide.

## 3.4 Software information

Most of the applications in the support CD have wizards that will conveniently guide you through the installation. View the online help or readme file that came with the software for more information.

### ASUS PC Probe II

PC Probe II is a utility that monitors the computer's vital components and alerts you of any problem with these components. PC Probe II senses fan rotations, CPU temperature, and system voltages, among others. PC Probe II is software-based, allowing you to start monitoring your computer the moment you turn it on. With this utility, you are assured that your computer is always at a healthy operating condition.

#### Installing PC Probe II

To install PC Probe II on your computer:

1. Place the support CD to the optical drive. The **Drivers** installation tab appears if your computer has an enabled Autorun feature.



---

If Autorun is not enabled in your computer, browse the contents of the support CD to locate the setup.exe file from the ASUS PC Probe II folder. Double-click the setup.exe file to start installation.

---

2. Click the **Utilities** tab, then click **ASUS PC Probe II**.
3. Follow the screen instructions to complete installation.

#### Launching PC Probe II

You can launch the PC Probe II right after installation or anytime from the Windows® desktop.

To launch the PC Probe II from the Windows® desktop, click **Start > All Programs > ASUS > PC Probe II**. The PC Probe II main window appears.



After launching the application, the PC Probe II icon appears in the Windows® taskbar. Click this icon to close or restore the application.

#### Using PC Probe II

##### Main window

The PC Probe II main window allows you to view the current status of your system and change the utility configuration. By default, the main window displays the **Preference** section. You can close or restore the **Preference** section by clicking on the triangle on the main window right handle.

Click to close the Preference panel

| Button  | Function   |
|---|--|
|  | Opens the <b>Configuration</b> window                      |
|   | Opens the <b>Report</b> window                             |
|   | Opens the <b>Desktop Management Interface</b> window       |
|  | Opens the <b>Peripheral Component Interconnect</b> window  |
|  | Opens the <b>Windows Management Instrumentation</b> window |
|   | Opens the hard disk drive, memory, CPU usage window        |
|   | Shows/Hides the <b>Preference</b> section                  |
|   | Minimizes the application                                  |
|   | Closes the application                                     |

### Sensor alert

When a system sensor detects a problem, the main window right handle turns red, as the illustrations below show.

When displayed, the monitor panel for that sensor also turns red. Refer to the **Monitor panels** section for details.

### Preferences

You can customize the application using the Preference section in the main window. Click the box before each preference to activate or deactivate.

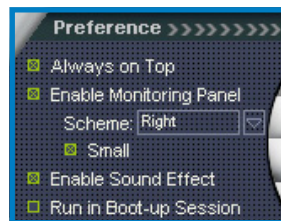



## Hardware monitor panels

The hardware monitor panels display the current value of a system sensor such as fan rotation, CPU temperature, and voltages.

The hardware monitor panels come in two display modes: hexagonal (large) and rectangular (small). When you check the **Enable Monitoring Panel** option from the **Preference** section, the monitor panels appear on your computer's desktop.



Small display

Large display

### Changing the monitor panels position

To change the position of the monitor panels on the desktop, click the arrow down button of the **Scheme** options, then select another position from the list box. Click **OK** when finished.

### Moving the monitor panels

All monitor panels move together using a magnetic effect. If you want to detach a monitor panel from the group, click the horseshoe magnet icon. You can now move or reposition the panel independently.

### Adjusting the sensor threshold value

You can adjust the sensor threshold value in the monitor panel by clicking the arrow buttons. You can also adjust the threshold values using the **Config** window.

You cannot adjust the sensor threshold values in a small monitoring panel.

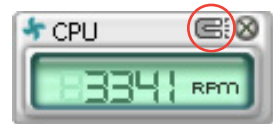

Click to  
increase  
value

Click to  
decrease  
value

### Monitoring sensor alert

The monitor panel turns red when a component value exceeds or is lower than the threshold value. Refer to the illustrations below.



**Small display**

**Large display**

## **WMI browser**

Click **WMI** to display the WMI (Windows Management Instrumentation) browser. This browser displays various Windows® management information. Click an item from the left panel to display on the right panel. Click the plus sign (+) before **WMI Information** to display the available information.



---

You can enlarge or reduce the browser size by dragging the bottom right corner of the browser.

---

## **DMI browser**

Click to display the DMI (Desktop Management Interface) browser. This browser displays various desktop and system information. Click the plus sign (+) before **DMI Information** to display the available information.

## PCI browser

Click **PCI** to display the PCI (Peripheral Component Interconnect) browser. This browser provides information on the PCI devices installed on your system. Click the plus sign (+) before the **PCI Information** item to display available information.

## Usage

The **Usage** browser displays real-time information on the CPU, hard disk drive space, and memory usage. Click  to display the Usage browser.

### CPU usage

The **CPU** tab displays real-time CPU usage in line graph representation. If the CPU has an enabled Hyper-Threading, two separate line graphs display the operation of the two logical processors.

### Hard disk drive space usage

The **Hard Disk** tab displays the used and available hard disk drive space. The left panel of the tab lists all logical drives. Click a hard disk drive to display the information on the right panel. The pie chart at the bottom of the window represents the used (blue) and the available HDD space.

### Memory usage

The **Memory** tab shows both used and available physical memory. The pie chart at the bottom of the window represents the used (blue) and the available physical memory.

## Configuring PC Probe II

Click  to view and adjust the sensor threshold values.

The **Config** window has two tabs: **Sensor/Threshold** and **Preference**. The **Sensor/Threshold** tab enables you to activate the sensors or to adjust the sensor threshold values. The **Preference** tab allows you to customize sensor alerts, change temperature scale, or enable the Q-Fan feature.

Loads the default  
threshold values  
for each sensor

AVT

# Chapter 4

This chapter gives information about the motherboard that comes with the system. This chapter includes the motherboard layout, jumper settings, and connector locations.

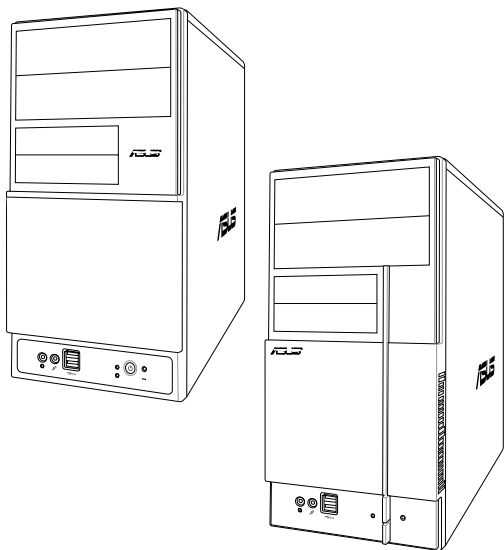

# Motherboard introduction

## 4.1 Introduction

The V-Series P5V900 barebone system comes with an ASUS motherboard. This chapter provides technical information about the motherboard for future upgrades or system reconfiguration.

## 4.2 Motherboard layout

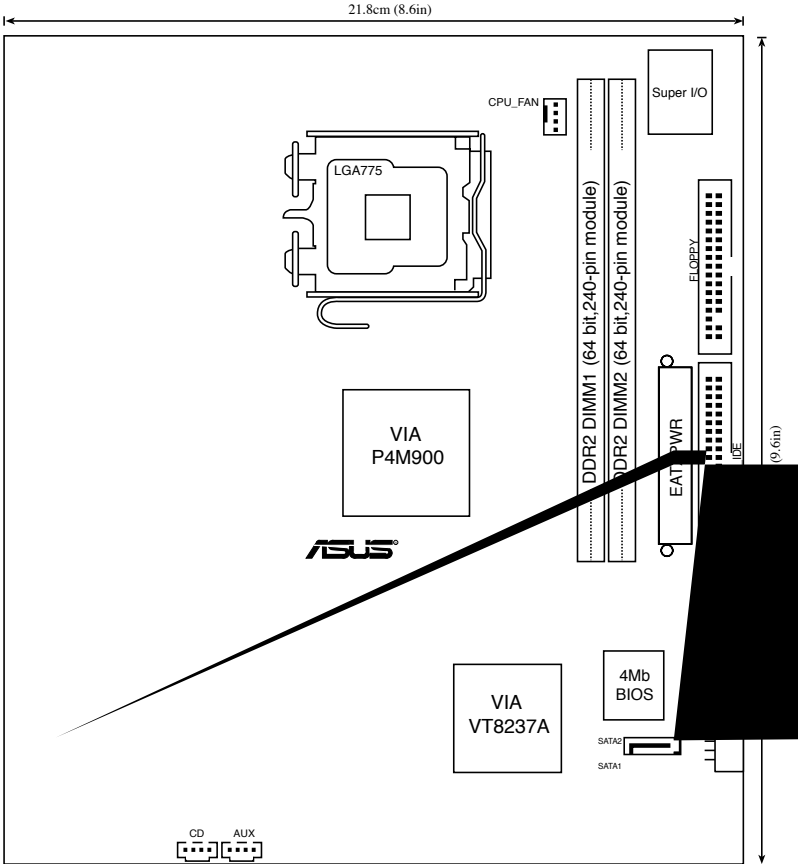

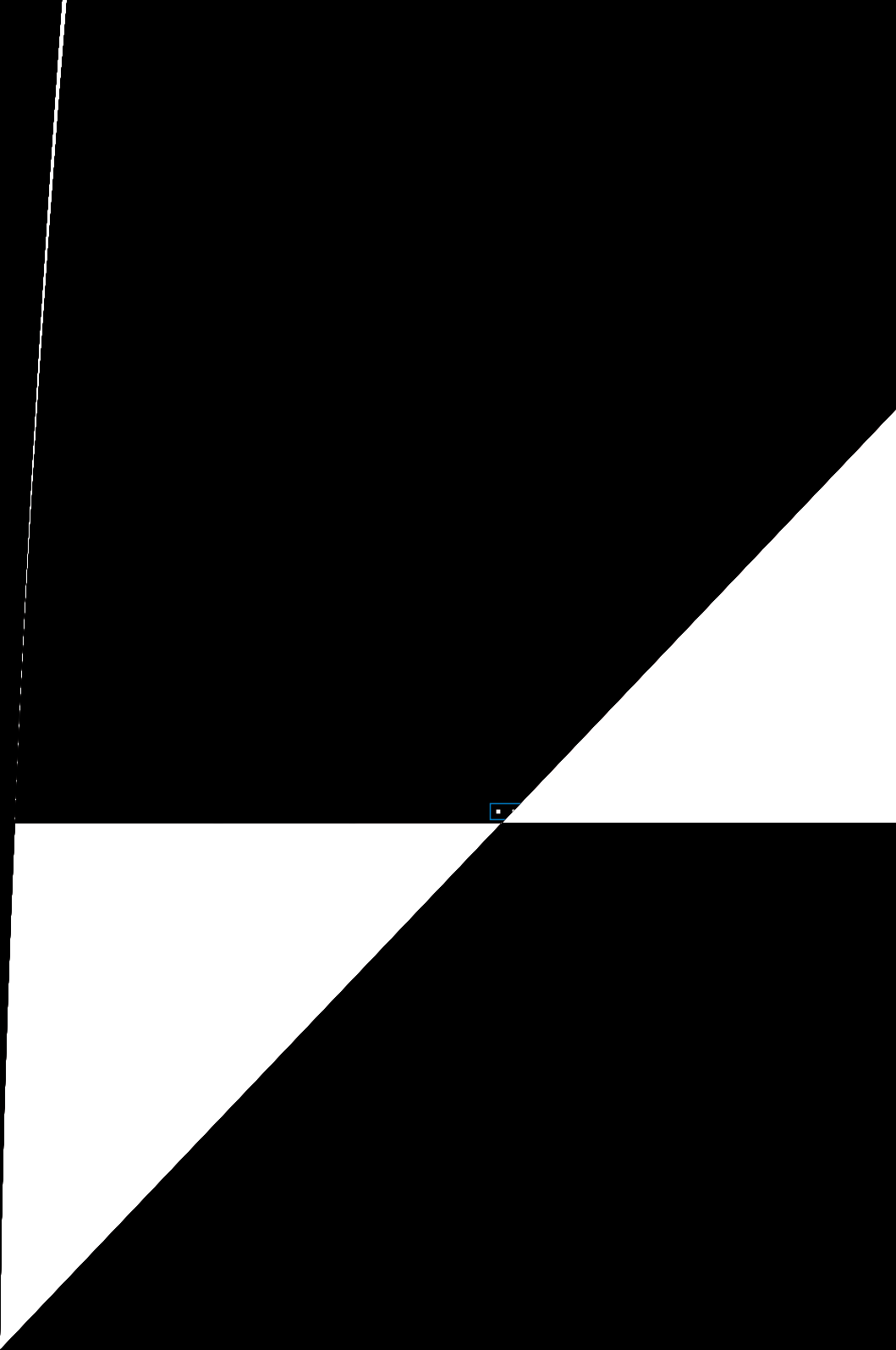

## 2. USB device wake-up (3-pin USBPW12, USBPW34, USBPW56, USBPW78)

Set these jumpers to +5V to wake up the computer from S1 sleep mode (CPU stopped, DRAM refreshed, system running in low power mode) using the connected USB devices. Set to +5VSB to wake up from S3 and S4 sleep modes (no power to CPU, DRAM in slow refresh, power supply in reduced power mode).

The USBPW12 and USBPW34 jumpers are for the rear USB ports. The USBPW56 and USBPW78 jumper is for the internal USB connectors that you can connect to additional USB ports.

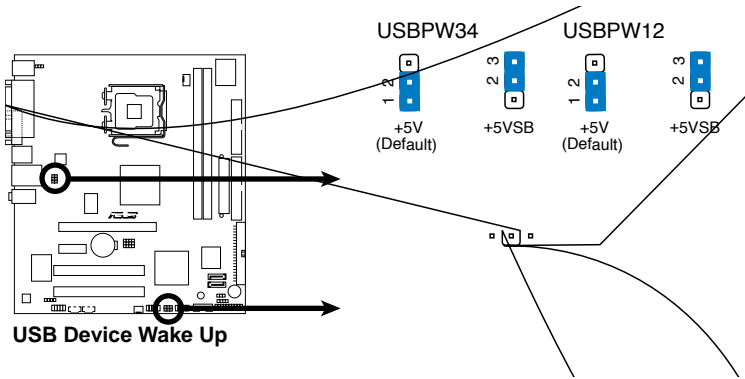

- The USB device wake-up feature requires a power supply that can provide 500mA on the +5VSB lead for each USB port; otherwise, the system would not power up.
- The total current consumed must NOT exceed the power supply capability (+5VSB) whether under normal condition or in sleep mode.



### 3. Keyboard power (3-pin KBPWR)

This jumper allows you to enable or disable the keyboard wake-up feature. Set this jumper to pins 2-3 (+5VSB) if you wish to wake up the computer when you press a key on the keyboard (the default is the Space Bar). This feature requires an ATX power supply that can supply at least 1A on the +5VSB lead, and a corresponding setting in the BIOS.

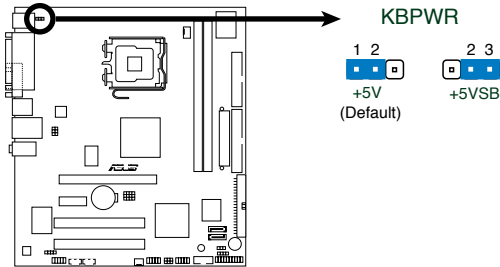

**Keyboard Power Setting**

### 4. XSW (3-pin XSW1,2,3,4)

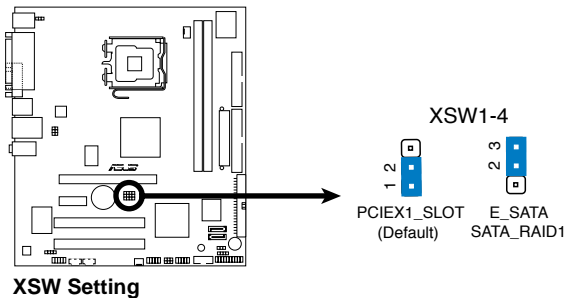

**XSW Setting**

## 4.4 Connectors

### 1. Floppy disk drive connector (34-1 pin FLOPPY)

This connector is for the provided floppy disk drive (FDD) signal cable. Insert one end of the cable to this connector, then connect the other end to the signal connector at the back of the floppy disk drive.



Pin 5 on the connector is removed to prevent incorrect cable connection when using a FDD cable with a covered Pin 5.

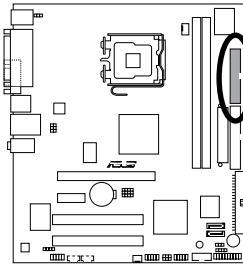

Floppy Disk Drive Connector

FLOPPY

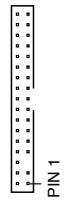

**NOTE:** Orient the red markings on the floppy ribbon cable to PIN 1.

### 2. Serial ATA connectors (7-pin SATA1, SATA2)

These connectors are for the Serial ATA signal cables for Serial ATA hard disk drives.

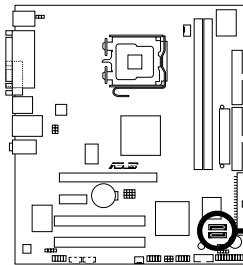

SATA Connectors

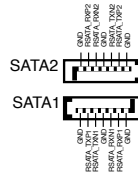

#### Important notes on Serial ATA:

- You must install Windows® 2000 Service Pack 4 or the Windows® XP Service Pack 1 before using Serial ATA hard disk drives.
- When using the connectors in **Standard IDE** mode, connect the primary (boot) hard disk drive to the SATA1 or SATA2 connector.

### 3 IDE connectors (40-1 pin PRI\_IDE, SEC\_IDE)

The onboard IDE connectors are for Ultra DMA 133/100/66 signal cable(s). There are three connectors on each Ultra DMA 133/100/66 signal cable: blue, black, and gray. Connect the blue connector to the motherboard's IDE connector, then select one of the following modes to configure your device(s).

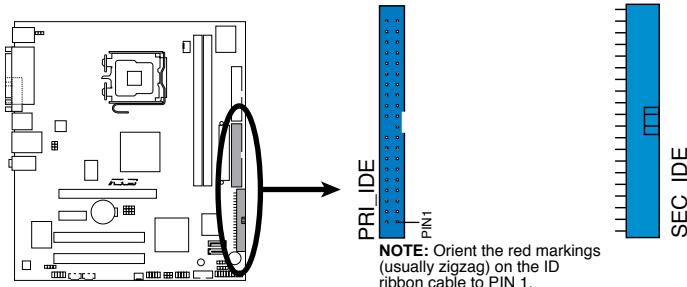

**IDE Connectors**

|               | Drive jumper setting   | Mode Cable of device(s) | Cable connector |
|---------------|------------------------|-------------------------|-----------------|
| Single device | Cable-Select or Master | -                       | Black           |
| Two devices   | Cable-Select           | Master Slave            | Black Gray      |
|               | Master Slave           | Master Slave            | Black or gray   |



- Pin 20 on the IDE connector is removed to match the covered hole on the Ultra DMA cable connector. This prevents incorrect insertion when you connect the IDE cable.
- Use the 80-conductor IDE cable for Ultra DMA 133/100/66 IDE devices.



If any device jumper is set as "Cable-Select", make sure all other device jumpers have the same setting.

## 5. US



---

Never connect a **1394 cable** to the USB connectors. Doing so will damage the motherboard!

---

## 6. ATX power connectors (24-pin EATXPWR, 4-pin ATX12V)

These connectors are for ATX power supply plugs. The plugs from the power supply are designed to fit these connectors in only one orientation. Find the proper orientation and push down firmly until the connectors completely fit.

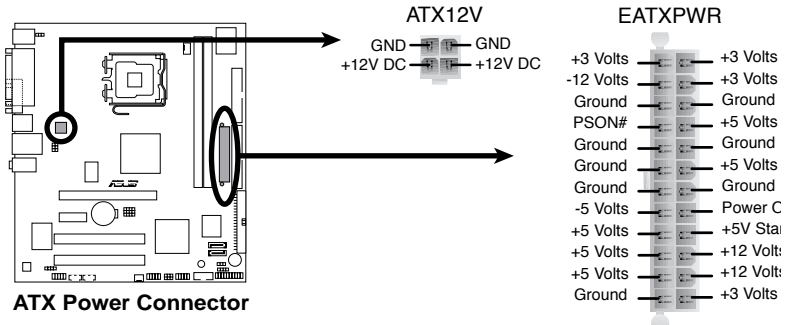

**ATX Power Connector**



- Do not forget to connect the 4-pin ATX +12 V power plug; otherwise, the system will not boot.
- Use of a PSU with a higher power output is recommended when configuring a system with more power-consuming devices. The system may become unstable or may not boot up if the power is inadequate.
- Make sure that your power supply unit (PSU) can provide at least the minimum power required by your system.

## 7. Internal audio connectors (4-pin AUX)

This connector allows you to receive stereo audio input from sound sources such as a CD-ROM, TV tuner, or MPEG card.

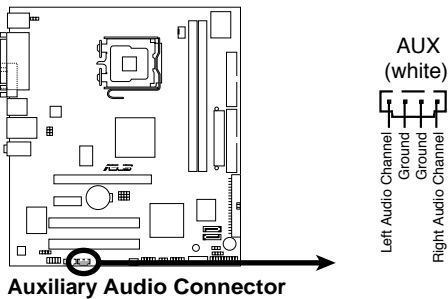

**Auxiliary Audio Connector**



Enable the CD-IN function in the audio utility when using this connector.

## 8. Front panel audio connector (10-1 pin AAFP)

This connector is for a chassis-mounted front panel audio I/O module that supports either HD Audio or legacy AC'97 audio standard.

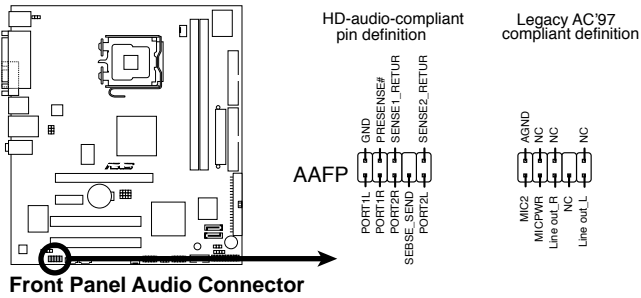

We recommend that you connect a high-definition front panel audio module to this connector to avail of the motherboard's high-definition audio capability.

## 9. Digital audio connector (4-1 pin SPDIF\_OUT)

This connector is for an additional Sony/Philips Digital Interface (S/PDIF) port(s). Connect the S/PDIF module cable to this connector, then install the module to a slot opening at the back of the system chassis.

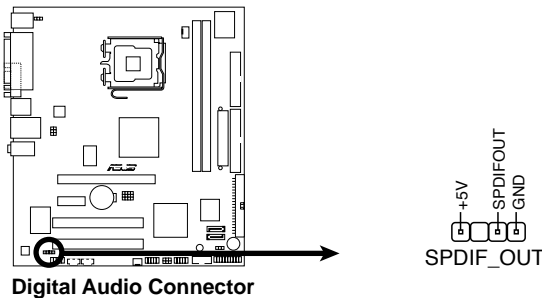

The S/PDIF module is purchased separately.

h Connector



ple  
ning at th

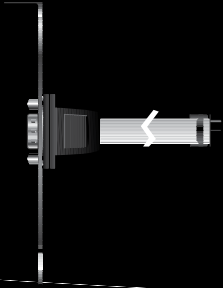
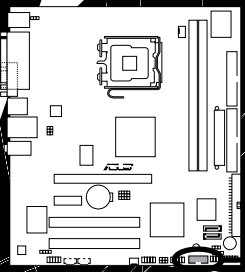

12. S

on (2-pin RES.

boot without turning



# Chapter 5

This chapter tells how to change system settings through the BIOS Setup menus and describes the BIOS parameters.

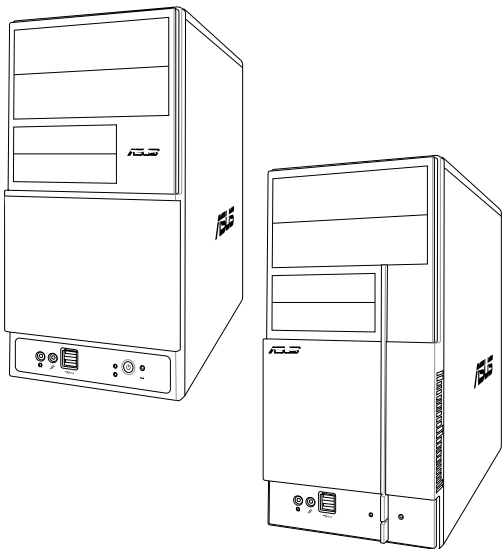

# BIOS setup

## 5.1 Managing and updating your BIOS

The following utilities allow you to manage and update the motherboard Basic Input/Output System (BIOS) setup.

1. ASUS Update (Updates the BIOS in Windows® environment)
2. ASUS EZ Flash (Updates the BIOS during the Power-On Self Test)
3. Award BIOS Flash Utility (Updates the BIOS in DOS mode)
4. ASUS CrashFree BIOS 2 (Updates the BIOS when the BIOS file fails or gets corrupted.)

Refer to the corresponding sections for details on these utilities.



---

Save a copy of the original motherboard BIOS file to a bootable floppy disk in case you need to restore the BIOS in the future. Copy the original motherboard BIOS using the ASUS Update or Award BIOS Flash utilities.

---

### 5.1.1 ASUS Update utility

The ASUS Update is a utility that allows you to manage, save, and update the motherboard BIOS in Windows® environment. The ASUS Update utility allows you to:

- Save the current BIOS file
- Download the latest BIOS file from the Internet
- Update the BIOS from an updated BIOS file
- Update the BIOS directly from the Internet, and
- View the BIOS version information.

This utility is available in the support CD that comes with the motherboard package.



---

ASUS Update requires an Internet connection either through a network or an Internet Service Provider (ISP).

---

### Installing ASUS Update

To install ASUS Update:

1. Place the support CD in the optical drive. The Drivers menu appears.
2. Click the Utilities tab, then click Install ASUS Update VX.XX.XX.
3. The ASUS Update utility is copied to your system.



---

Quit all Windows® applications before you update the BIOS using this utility.

---

## Updating the BIOS through the Internet

To update the BIOS through the Internet:

1. Launch the ASUS Update utility from the Windows® desktop by clicking Start > Programs > ASUS > ASUSUpdate > ASUSUpdate. The ASUS Update main window appears.

2. Select **Update BIOS** from the Internet option from the drop-down menu, then click **N**.
3. Select the ASUS FTP site nearest you to avoid network traffic, or click Auto Select. Click **Next**.

4. From the FTP site, select the BIOS version that you wish to download. Click **Next**.
5. Follow the screen instructions to complete the update process.



---

The ASUS Update utility is capable of updating itself through the Internet. Always update the utility to avail all its features.

---

## Updating the BIOS through a BIOS file

To update the BIOS through a BIOS file:

1. Launch the ASUS Update utility from the Windows® desktop by clicking Start > Programs > ASUS > ASUSUpdate > ASUSUpdate. The ASUS Update main window appears.
2. Select Update BIOS from a file option from the drop-down menu, then click Next.
3. Locate the BIOS file from the Open window, then click Open.
4. Follow the screen instructions to complete the update process.

## 5.1.2 Creating a bootable floppy disk

1. Do either one of the following to create a bootable floppy disk.

### DOS environment

- a. Insert a 1.44MB floppy disk into the drive.
- b. At the DOS prompt, type *format A:/s* then press <Enter>.

### Windows® XP environment

- a. Insert a 1.44 MB floppy disk to the floppy disk drive.
- b. Click Start from the Windows® desktop, then select My Computer.
- c. Select the 3 1/2 Floppy Drive icon.
- d. Click File from the menu, then select Format. A Format 3 1/2 Floppy Disk window appears.
- e. Select Create an MS-DOS startup disk from the format options field, then click Start.

### Windows® 2000 environment

To create a set of boot disks for Windows® 2000:

- a. Insert a formatted, high density 1.44 MB floppy disk into the drive.
- b. Insert the Windows® 2000 CD to the optical drive.
- c. Click Start, then select Run.
- d. From the Open field, type  
**D:\bootdisk\makeboot a:**  
assuming that D: is your optical drive.
- e. Press <Enter>, then follow screen instructions to continue.

2. Copy the original or the latest motherboard BIOS file to the bootable floppy disk.

### 5.1.3 ASUS EZ Flash 2 utility

The ASUS EZ Flash 2 feature allows you to update the BIOS without having to go through the long process of booting from a floppy disk and using a DOS-based utility. The EZ Flash 2 utility is built-in the BIOS chip so it is accessible by pressing <Alt> + <F2> during the Power-On Self-Test (POST).

To update the BIOS using EZ Flash 2:

1. Visit the ASUS website ([www.asus.com](http://www.asus.com)) to download the latest BIOS file for the motherboard.
2. Save the BIOS file to a floppy disk or a USB flash disk, then restart the system.
3. You can launch the EZ Flash 2 by two methods.
  - (1) Insert the floppy disk / USB flash disk that contains the BIOS file to the floppy disk drive or the USB port.

Press <Alt> + <F2> during POST to display the following.

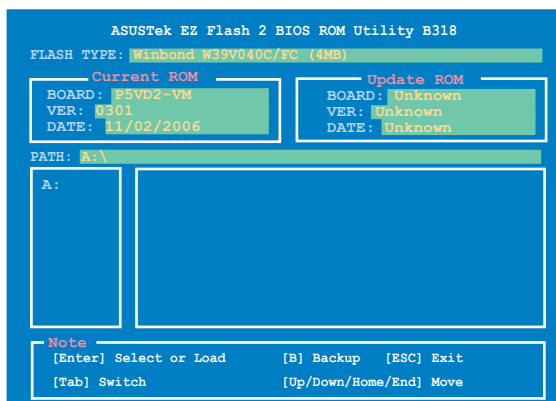

- (2) Enter BIOS setup program. Go to the **Tools** menu to select **EZ Flash 2** and press <Enter> to enable it.

You can switch between drives by pressing <Tab> before the correct file is found. Then press <Enter>.

4. When the correct BIOS file is found, EZ Flash 2 performs the BIOS update process and automatically reboots the system when done.



- This function can support devices such as USB flash disk, or floppy disk with **FAT 32/16/12** format only.
- Do not shut down or reset the system while updating the BIOS to prevent system boot failure!

## 5.1.4 AwardBIOS Flash Utility

The Basic Input/Output System (BIOS) can be updated using the AwardBIOS Flash Utility. Follow these instructions to update the BIOS using this utility.

1. Download the latest BIOS file from the ASUS web site. Rename the file to V-P5V900.BIN and save it to a floppy disk.



Save only the updated BIOS file in the floppy disk to avoid loading the wrong BIOS file.

2. Copy the AwardBIOS Flash Utility (awdfash.exe) from the Software folder of the support CD to the floppy disk with the latest BIOS file.
3. Boot the system in DOS mode using the bootable floppy disk you created earlier.
4. When the A:> appears, replace the bootable floppy disk with the floppy disk containing the new BIOS file and the Award BIOS Flash Utility.
5. At the prompt, type awdfash then press <Enter>. The Award BIOS Flash Utility screen appears.

```
AwardBIOS Flash Utility for ASUS V1.17
(C) Phoenix Technologies Ltd. All Rights Reserved

For P4M900-8237A-P5VD2-VM    DATE:11/12/2006
Flash Type - Winbond W39V040C/FC (4MB)

File Name to Program: V-P5V900.bin

Message: Please input File Name!
```

6. Type the BIOS file name in the File Name to Program field, then press <Enter>.

```
AwardBIOS Flash Utility for ASUS V1.17
(C) Phoenix Technologies Ltd. All Rights Reserved

For P4M900-8237A-P5VD2-VM    DATE:11/12/2006
Flash Type - Winbond W39V040C/FC (4MB)

File Name to Program: V-P5V900.bin

Message: Do You Want To Save Bios (Y/N)
```

- Press <N> when the utility prompts you to save the current BIOS file. The following screen appears.
- The utility verifies the BIOS file in the floppy disk and starts flashing the BIOS file.

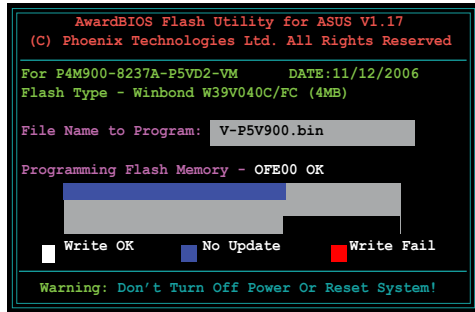

Do not turn off or reset the system during the flashing process!

- The utility displays a Flashing Complete message indicating that you have successfully flashed the BIOS file. Remove the floppy disk then press <F1> to restart the system.

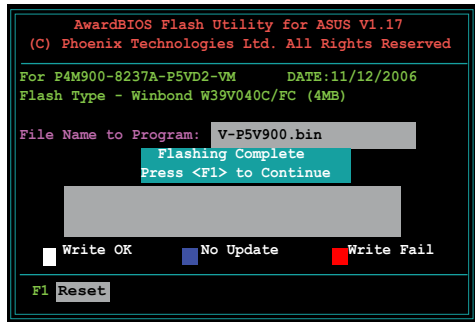



## 5.1.5 Saving the current BIOS file

You can use the AwardBIOS Flash Utility to save the current BIOS file. You can load the current BIOS file when the BIOS file gets corrupted during the flashing process.

To save the current BIOS file using the AwardBIOS Flash Utility:

1. Follow steps 1 to 6 of the previous section.
2. Press <Y> when the utility prompts you to save the current BIOS file. The following screen appears.

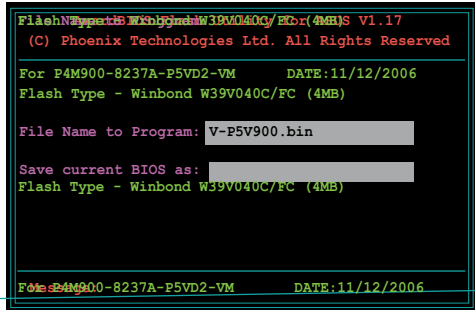

```
Flash Utility V1.17  
(C) Phoenix Technologies Ltd. All Rights Reserved  
For P4M900-8237A-P5VD2-VM DATE:11/12/2006  
Flash Type - Winbond W39V040C/FC (4MB)  
File Name to Program: V-P5V900.bin  
Save current BIOS as:  
Flash Type - Winbond W39V040C/FC (4MB)  
P4M900-8237A-P5VD2-VM DATE:11/12/2006
```

3. Type a filename for the current BIOS file in the Save current BIOS as field, then press <Enter>.
4. The utility saves the current BIOS file to the floppy disk, then returns to the BIOS flashing process.

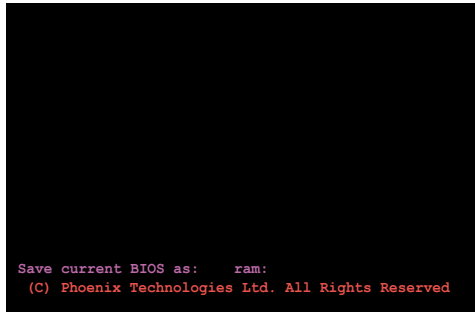

```
Save current BIOS as: ram:  
(C) Phoenix Technologies Ltd. All Rights Reserved
```



## 5.2 BIOS setup program

This motherboard supports a programmable Low-Pin Count (LPC) chip that you can update using the provided utility described in section “4.1 Managing and updating your BIOS.”

Use the BIOS Setup program when you are installing a motherboard, reconfiguring your system, or prompted to “Run Setup.” This section explains how to configure your system using this utility.

Even if you are not prompted to use the Setup program, you can change the configuration of your computer in the future. For example, you can enable the security password feature or change the power management settings. This requires you to reconfigure your system using the BIOS Setup program so that the computer can recognize these changes and record them in the CMOS RAM of the LPC chip.

The LPC chip on the motherboard stores the Setup utility. When you start up the computer, the system provides you with the opportunity to run this program. Press <Del> during the Power-On Self-Test (POST) to enter the Setup utility; otherwise, POST continues with its test routines.

If you wish to enter Setup after POST, reboot the system by doing any of the following procedures:

- Restart using the OS standard shut-down procedure.
- Press <Ctrl>+<Alt>+<Del> simultaneously.
- Press the reset button on the system chassis.
- Press the power button to turn the system off then back on.



---

Using the power button, reset button, or the <Ctrl>+<Alt>+<Del> keys to force reset from a running operating system can cause damage to the data or system. We recommend to always shut-down the system properly from the operating system.

---

The Setup program is designed to make it as easy to use as possible. Being a menu-driven program, it lets you scroll through the various sub-menus and make your selections from the available options using the navigation keys.



- 
- The default BIOS settings for this motherboard apply for most conditions to ensure optimum performance. If the system becomes unstable after changing any BIOS settings, load the default settings to ensure system compatibility and stability. Select the Load Default Settings item under the Exit Menu.
  - The BIOS setup screens shown in this section are for reference purposes only, and may not exactly match what you see on your screen.
  - Visit the ASUS website ([www.asus.com](http://www.asus.com)) to download the latest BIOS file for this motherboard.
-





## 5.2.7 Pop-up window

Select a menu item then press <Enter> to display a pop-up window with the configuration options for that item.

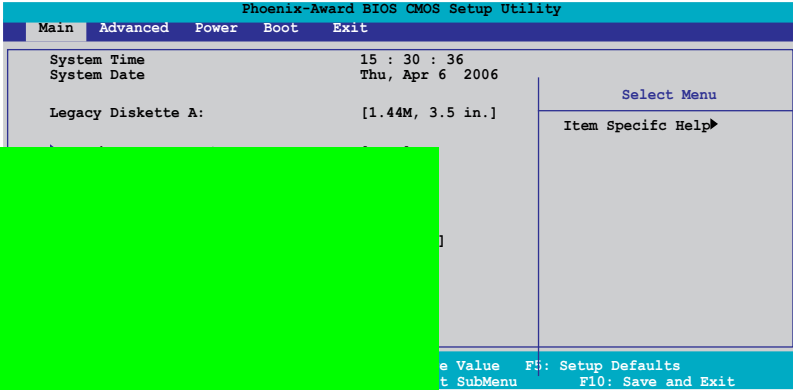

## 5.3 Main menu

When you enter the BIOS Setup program, the Main menu screen appears, giving you an overview of the basic system information.



Refer to section “4.2.1 BIOS menu screen” for information on the menu screen items and how to navigate through them.

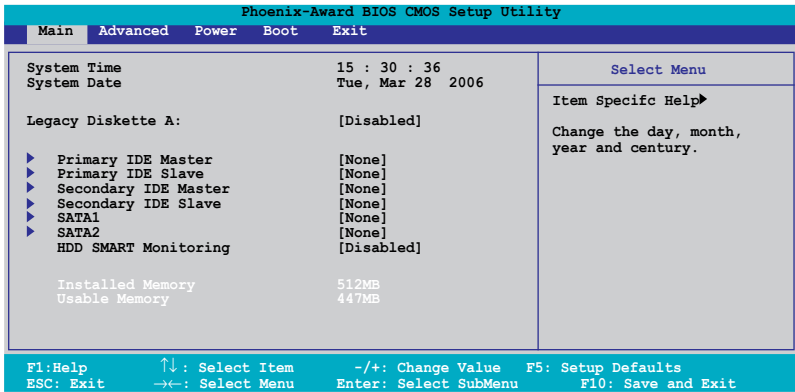

### 5.3.1 System Time [xx:xx:xx]

Allows you to set the system time.

### 5.3.2 System Date [Day xx/xx/xxxx]

Allows you to set the system date.

### 5.3.3 Primary IDE Master/Slave

While entering Setup, the BIOS automatically detects the presence of IDE devices. There is a separate sub-menu for each IDE device. Select a device item then press <Enter> to display the IDE device information.

| Phoenix-Award BIOS CMOS Setup Utility  |        |  |
|--|--------|--|
| Main   |        |  |
| Primary IDE Master   |        | Select Menu                                      |
| Primary IDE Master   | [Auto] | Item Specific Help▶▶<br>Press [Enter] to select. |
| Access Mode  | [Auto] |  |
| Capacity   | 0 MB   |  |
| Cylinder   | 0      |  |
| Head   | 0      |  |
| Sector   | 0      |  |
| PIO Mode   | [Auto] |  |
| UDMA Mode  | [Auto] |  |
| Transfer Mode  | None   |  |
| F1: Help      ↑↓: Select Item      -/+ : Change Value      F5: Setup Defaults<br>ESC: Exit    →←: Select Menu      Enter: Select SubMenu      F10: Save and Exit |        |  |

The BIOS automatically detects the values opposite the dimmed items (Capacity, Cylinder, Head, Sector and Transfer Mode). These values are not user-configurable. These items show N/A if no IDE device is installed in the system.

#### PIO Mode [Auto]

Sets the PIO mode for the IDE device.

Configuration options: [Auto] [Mode 0] [Mode 1] [Mode 2] [Mode 3] [Mode 4]

#### UDMA Mode [Auto]

Disables or sets the UDMA mode. Configuration options: [Disabled] [Auto]

#### Primary IDE Master/Slave [Auto]

Select [Auto] to automatically detect an IDE hard disk drive. If automatic detection is successful, the BIOS automatically fills in the correct values for the remaining fields on this sub-menu. If the hard disk was already formatted on a previous system, the setup BIOS may detect incorrect parameters. Select [Manual] to manually enter the IDE hard disk drive parameters. If no drive is installed select [None]. Configuration options: [None] [Auto] [Manual]



## Access Mode [Auto]

The default [Auto] allows automatic detection of an IDE hard disk drive. Select [CHS] for this item if you set the IDE Primary Master/Slave to [Manual]. Configuration options: [CHS] [LBA] [Large] [Auto]



---

Before attempting to configure a hard disk drive, make sure you have the correct configuration information supplied by the drive manufacturer. Incorrect settings may cause the system to fail to recognize the installed hard disk.

---

## Capacity

Displays the auto-detected hard disk capacity. This item is not configurable.

## Cylinder

Shows the number of the hard disk cylinders. This item is not configurable.

## Head

Shows the number of the hard disk read/write heads. This item is not configurable.

## Sector

Shows the number of sectors per track. This item is not configurable.

## Transfer Mode

Shows the Transfer mode. This item is not configurable.



---

After entering the IDE hard disk drive information into BIOS, use a disk utility, such as FDISK, to partition and format new IDE hard disk drives. This is necessary so that you can write or read data from the hard disk. Make sure to set the partition of the Primary IDE hard disk drives to active.

---

### 5.3.4 SATA 1/2

While entering Setup, the BIOS automatically detects the presence of Serial ATA devices. There is a separate sub-menu for each SATA device. Select a device item then press <Enter> to display the SATA device information.

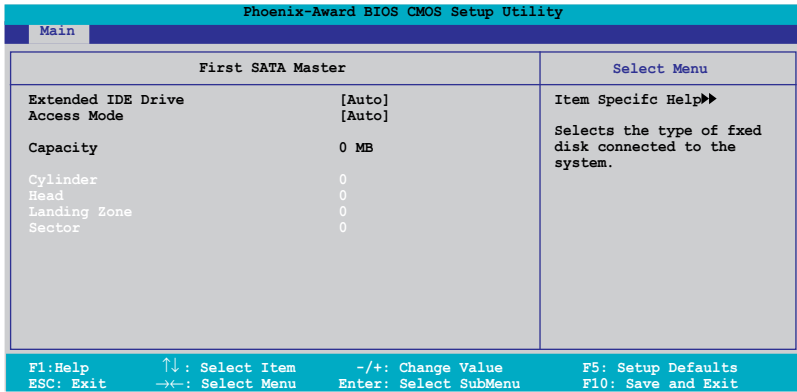

The BIOS automatically detects the values opposite the dimmed items (Capacity, Cylinder, Head, Landing Zone and Sector). These values are not user-configurable. These items show 0 if no SATA device is installed in the system.

#### Extended IDE Drive [Auto]

Selects the type of fixed disk connected to the system.

Configuration options: [None] [Auto]

#### Access Mode [Auto]

Sets the sector addressing mode. Configuration options: [Large] [Auto]



Before attempting to configure a hard disk drive, make sure you have the correct configuration information supplied by the drive manufacturer. Incorrect settings may cause the system to fail to recognize the installed hard disk.

#### Capacity

Displays the auto-detected hard disk capacity. This item is not configurable.

#### Cylinder

Shows the number of the hard disk cylinders. This item is not configurable.

## Head

Shows the number of the hard disk read/write heads. This item is not configurable.

## Landing Zone

Shows the number of landing zone per track. This item is not configurable.

## Sector

Shows the number of sectors per track. This item is not configurable.



After entering the IDE hard disk drive information into BIOS, use a disk utility, such as FDISK, to partition and format new IDE hard disk drives. This is necessary so that you can write or read data from the hard disk. Make sure to set the partition of the Primary IDE hard disk drives to active.

### 5.3.5 HDD SMART Monitoring [Enabled]

Allows you to enable or disable the HDD Self-Monitoring Analysis and Reporting Technology (SMART) feature. Configuration options: [Disabled] [Enabled]

### 5.3.6 Installed Memory [xxx MB]

Shows the size of installed memory.

### 5.3.7 Usable Memory [XXX MB]

Shows the size of usable memory.

## 5.4 Advanced menu

The Advanced menu items allow you to change the settings for the CPU and other system devices.



Take caution when changing the settings of the Advanced menu items. Incorrect field values can cause the system to malfunction.

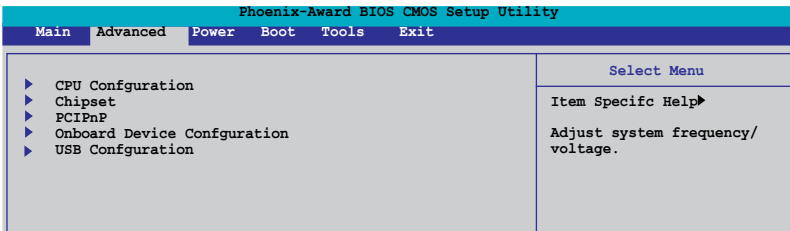

## 5.4.1 CPU Configuration

| Phoenix-Award BIOS CMOS Setup Utility |                         |                          |
|---------------------------------------|-------------------------|--------------------------|
| Advanced                              |                         |                          |
| CPU Configuration                     |                         | Select Menu              |
| CPU Type                              | Intel Genuine Processor | Item Specific Help▶▶     |
| CPU Speed                             | 3.80GHz                 |                          |
| Cache RAM                             | 2048K                   |                          |
| Current FSB Frequency                 | 200MHz                  |                          |
| Delay Prior to Thermal                | [4 Min]                 |                          |
| <b>Thermal Management</b>             | <b>[TM 1]</b>           |                          |
| TM2 Bus Ratio                         | 14 X                    | DRAM timing and control. |
| TM2 Bus VID                           | 0.8375V                 |                          |
| Limit CPUID MaxVal                    | [Disabled]              |                          |
| Enhanced C1 (C1E)                     | [Enabled]               |                          |
| Excute Disable Bit                    | [Enabled]               |                          |
| Enhanced Intel SpeedStep(tm) Tech.    | [Disabled]              |                          |
| CPU L1 & L2 Cache                     | [Enabled]               |                          |
| Hyper-Threading TEchnology            | [Enabled]               |                          |

### Thermal Management [ TM 1 ]

Configuration options: [TM 1] [TM 2]. Thermal Monitor 1: On die throting;  
Thermal Monitor 2: Ratio & VID transition

### Limit CPUID MaxVal [Disabled]

Configuration options: [Disabled] [Enabled].

### Enhanced C1 (C1E) [Enabled]

The process will lower the core to bus ratio and VID when physical pprocess enter an enhance C1 state. Configuration options: [Disabled] [Enabled].

### Execute Disable Bit [Enabled]

When disabled, forces the XD feature flag to always return 0. Configuration options: [Disabled] [Enabled].

### Enhanced Intel SpeedStep(tm) Tech. [Disabled]

Enable this function for adjusting CPU speed according to CPU workload. Configuration options: [Disabled] [Enabled].

CPU L1&L2

## 5.4.2 Chipset

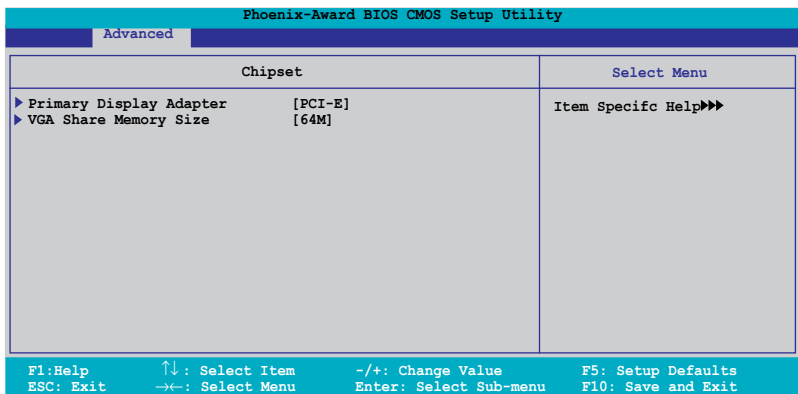

### Primary Display Adapter [PCI-E]

Select which graphics controller to use as the primary boot device.

Configuration options: [PCI] [PCI-E]

### VGA Share Memory Size [64M]

Sets the VGA Share Memory Size. Configuration options: [Disabled] [16M]

[32M] [64M]

## 5.4.3 PCIPnP

| Phoenix-Award BIOS CMOS Setup Utility |           |                      |
|---------------------------------------|-----------|----------------------|
| Advanced                              |           |                      |
|                                       | PCIPnP    | Select Menu          |
| Plug & Play O/S                       | [No]      | Item Specific Help▶▶ |
| Resources Controlled By               | [Auto]    |                      |
| x IRQ Resources                       |           |                      |
| Assign IRQ For VGA                    | [Enabled] |                      |
| ** PCI Express relative items **      |           |                      |
| Maximum Payload Size                  | [4096]    |                      |

### Plug & Play O/S [No]

When set to [No], the BIOS configures all the devices in the system. When set to [Yes] and if you install a Plug and Play operating system, the operating system configures the Plug and Play devices not required for boot. Configuration options: [No] [Yes]

### Resources C



### **SATA Controller [Enabled]**

Enable/Disable Onchip SATA. Configuration options: [Disabled] [Enabled]

### **SATA Controller Mode [IDE]**

Select SATA mode. Configuration options: [IDE] [RAID]

### **HDA Controller [Auto]**

Enable/Disable High Definition Audio controller. Configuration options:  
[Auto] [Disabled]

Onboard LA \_\_\_\_\_

## Parallel Port Address [378/IRQ7]

Select parallel port address. Configuration options: [Disabled] [378/IRQ7] [278/IRQ5] [3BC/IRQ7]

## Parallel Port Mode [Bi-Directional]

Select parallel port mode. Configuration options: [Normal] [EPP] [ECP] [Bi-Directional]

## ECP Mode Use DMA [3]

Select ECP Mode use DMA. Configuration options: [1] [3]

## 5.4.5 USB Configuration

The items in this menu allows you to change the USB-related features. Select an item then press <Enter> to display the configuration options.

| Phoenix-Award BIOS CMOS Setup Utility |           |   |
|---------------------------------------|-----------|---|
| Advanced                              |           |   |
| USB Configuration                     |           | Select Menu   |
| USB Controller                        | [Enabled] | Item Specific Help▶▶<br>Enable or Disable the USB Controller. |
| USB2.0 Controller                     | [Enabled] |   |
| USB Legacy support                    | [Auto]    |   |

### USB Controller [Enabled]

Enable or disable USB 1.1 and 2.0 controller. Configuration options: [Disabled] [Enabled]

### USB 2.0 Controller [Enabled]

Enables or disables the USB 2.0 controller. Configuration options: [Disabled] [Enabled]

### USB Legacy support [Auto]

Enable/Disable USB legacy device (USB keyboard and USB mouse) support. Configuration options: [Auto] [Enabled] [Disabled]



## 5.5 Power menu

The Power menu items allow you to change the settings for the Advanced Configuration and Power Interface (ACPI) and the Advanced Power Management (APM). Select an item then press <Enter> to display the configuration options.

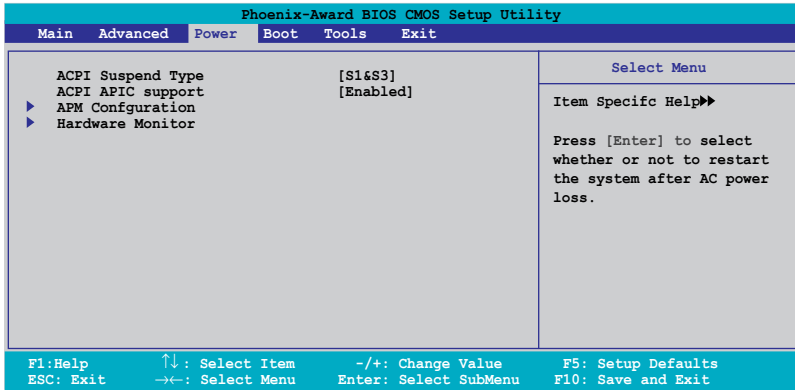

### 5.5.1 ACPI Suspend Type [S1&S3]

Allows you to select the Advanced Configuration and Power Interface (ACPI) state to be used for system suspend. Configuration options: [S1 (POS)] [S3 (STR)] [S1&S3]

### 5.5.2 ACPI APIC Support [Enabled]

Allows you to enable or disable the Advanced Configuration and Power Interface (ACPI) support in the Application-Specific Integrated Circuit (ASIC). When set to Enabled, the ACPI APIC table pointer is included in the RSDT pointer list. Configuration options: [Disabled] [Enabled]

## 5.5.3 APM Configuration

| Phoenix-Award BIOS CMOS Setup Utility |               |                     |
|---------------------------------------|---------------|---------------------|
| Power                                 |               |                     |
| APM Configuration                     |               | Select Menu         |
| Power Up By PS/2 Mouse                | [Disabled]    | Item Specific Help▶ |
| Power Up By PS/2 Keyboard             | [Disabled]    |                     |
| Power on By PCI/PCIE Devices          | [Disabled]    |                     |
| Power on By External Modem            | [Disabled]    |                     |
| Power On By RTC Alarm                 | [Disabled]    |                     |
| x Date (of Month) Alarm               | 0             |                     |
| x Time (hh:mm:ss) Alarm               | 0 : 0 : 0     |                     |
| Restore on AC Power Loss              | [Power Off]   |                     |
| PWR Button < 4 secs                   | [Instant-Off] |                     |
| HPET Support                          | [Enabled]     |                     |

### Power Up By PS/2 Mouse [Disabled]

Disable or enable Power up by PS/2 Mouse function.

Configuration options: [Disabled] [Enabled] Power Up By PS/2 Keyboard [Disabled]

Power Up By PS/2 Keyboard [Disabled]

### **Restore on AC Power Loss [Power Off]**

Allows you to select to/not to restart the system after AC power loss.  
Configuration options: [Power Off] [Power On] [Last State]

### **PWR Button < 4 secs [Instant-Off]**

When sets to [Instant-Off], the system will go to Soft-off instantly when power-button pressed for less than 4 seconds. When sets to [Suspend], the system will go to Suspend when power button is pressed.  
Configuration options: [Suspend] [Instant-Off]

### **HPET Support [Enabled]**

Allows you to enable or disable HPET support.  
Configuration options: [Enabled] [Disabled]

## 5.5.4 Hardware Monitor

The items in this sub-menu displays the hardware monitor values automatically detected by the BIOS. Select an item then press <Enter> to display the configuration options.

| Phoenix-Award BIOS CMOS Setup Utility |           |                                     |
|---------------------------------------|-----------|-------------------------------------|
| Power                                 |           |                                     |
| Hardware Monitor                      |           | Select Menu                         |
| Q-Fan Controller                      | [Enabled] | Item Specific Help▶▶                |
| Vcore Voltage                         | [1.29V]   |                                     |
| 3.3V Voltage                          | [3.33V]   | Press [Enter] to enable or disable. |
| 5V Voltage                            | [4.96V]   |                                     |
| x 12V Voltage                         | [11.96V]  |                                     |
|                                       |           |                                     |
| CPU Temperature                       | 54C       |                                     |
| M/B Temperature                       | 40C       |                                     |
| CPU Fan Speed                         | 2136 RPM  |                                     |
| Chassis Fan Speed                     | 0 RPM     |                                     |
| CPU Fan Speed warning                 | [800 RPM] |                                     |

F1:Help      ↑↓: Select Item      -/+ : Change Value      F5: Setup Defaults  
ESC: Exit    →←: Select Menu      Enter: Select SubMenu    F10: Save and Exit

### Q-Fan Controller [Enabled]

Disable or Enable the Q-Fan controller. Configuration options: [Disabled] [Enabled]

### Vcore Voltage [Enabled]

Sets the Vcore Voltage. Configuration options: [1.29V] [Ignored]

### 3.3V Voltage, 5V Voltage, 12V Voltage

The onboard hardware monitor automatically detects the voltage output through the onboard voltage regulators.

### CPU Temperature, M/B Temperature

The onboard hardware monitor automatically detects and displays the motherboard and CPU temperatures. These items are not user-configurable.

### CPU/Chassis Fan Speed

The onboard hardware monitor automatically detects and displays the CPU and chassis fan speeds in rotations per minute (RPM). These items are not user-configurable.

## **CPU Fan Speed warning [ 800 RPM]**

Allows you to disable or set the CPU fan warning speed.

Configuration options: [Disabled] [800 RPM] [1200 RPM] [1600 RPM]

## 5.6 Boot menu

The Boot menu items allow you to change the system boot options. Select an item then press <Enter> to display the sub-menu.

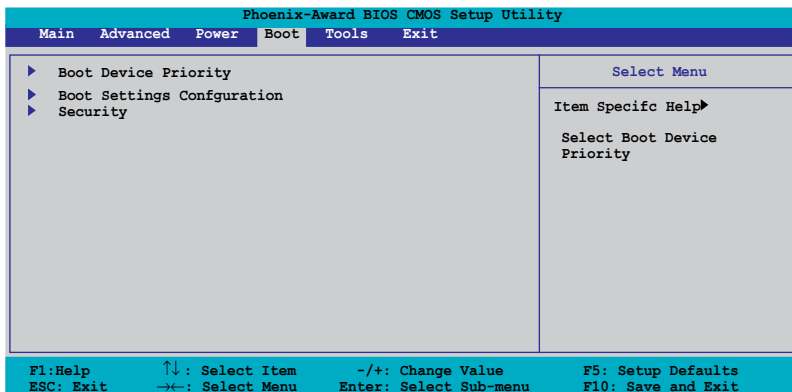

### 5.6.1 Boot Device Priority

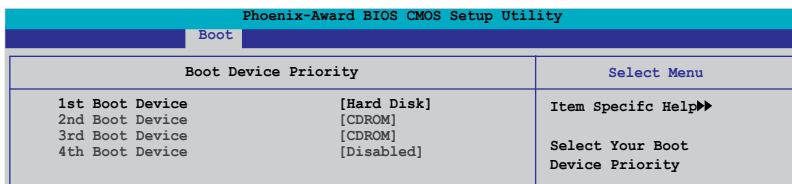

#### 1st ~ 4th Boot Device

These items specify the boot device priority sequence from the available devices. The number of device items that appears on the screen depends on the number of devices installed in the system. Configuration options: [Removable] [Hard Disk] [CDROM] [Legacy LAN] [Disabled]

## 5.6.2 Boot Settings Configuration

| Phoenix-Award BIOS CMOS Setup Utility   |                     |
|---|---------------------|
| Boot  |                     |
| Boot Settings Configuration   | Select Menu         |
| Case Open Warning   | [Enabled]           |
| Quick Boot  | [Enabled]           |
| Boot Up Floppy Seek   | [Disabled]          |
| Bootup Mun-Lock   | [On]                |
| Typematic Rate Setting  | [Disabled]          |
| x Typematic Rate (Chars/Sec)  | 6                   |
| x Typematic Delay (Msec)  | 250                 |
| OS Select For DRAM > 64MB   | [Non-OS2]           |
| Full Screen LOGO  | [Enabled]           |
| Halt On   | [All, But Keyboard] |
| F1: Help      ↑↓: Select Item      -/+ : Change Value      F5: Setup Defaults<br>ESC: Exit      →←: Select Menu      Enter: Select Sub-menu      F10: Save and Exit |                     |

### Case Open Warning [Enabled]

Allows you to enable or disable the Case Open Warning feature.  
 Configuration options: [Disabled] [Enabled]

### Quick Boot [Enabled]

Allows the system to skip certain tests while booting. This will decrease the time needed to boot the system. Configuration options: [Disabled] [Enabled]

### Boot Up Floppy Seek [Disabled]

Allows the system to test floppy drives to determine whether they have 40 or 80 tracks. Configuration options: [Disabled] [Enabled]

### Boot Up Num-Lock [On]

Selects power on state for NumLock. Configuration options: [Off] [On]

### Typematic Rate Setting [Disabled]

Keystrokes repeat at a rate determined by the keyboard controller - when enabled, the typematic rate and typematic delay can be selected. Configuration options: [Disabled] [Enabled]

## OS Select for DRAM > 64MB [Non-OS2]

Set this item to OS2 only when you are running on an OS/2 operating system with an installed RAM of greater than 64 KB. Configuration options: [Non-OS2] [OS2]

## Full Screen LOGO [Enabled]

Allows you to enable or disable the full screen logo display feature. Configuration options: [Disabled] [Enabled]

## Halt On [All, But Keyboard]

Allows you to error report type.

Configuration options: [All Errors] [No Errors] [All, But Keyboard] [All, But Diskette] [All, But Disk/Key]

## 5.6.3 Security

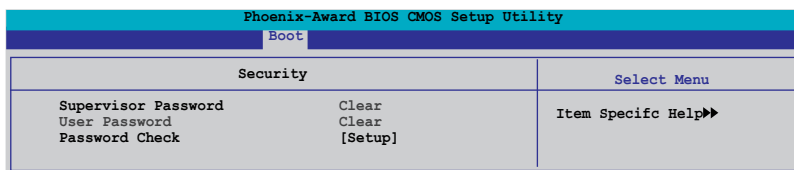

### Supervisor Password User Password

These fields allow you to set passwords:

To set a password:

1. Select an item then press <Enter>.
2. Type in a password using a combination of a maximum of eight (8) alpha-numeric characters, then press <Enter>.
3. When prompted, confirm the password by typing the exact characters again, then press <Enter>. The password field setting is changed to Set.

To clear the password:

1. Select the password field and press <Enter> twice. The following message appears:





Item Specific Help

This option save data  
to CMOS and exiting



---

Pressing <Esc> does not immediately exit this menu. Select one of the options from this menu or <F10> from the legend bar to exit.

---

## Exit & Save Changes

Once you are finished making your selections, choose this option from the Exit menu to ensure the values you selected are saved to the CMOS RAM. An onboard backup battery sustains the CMOS RAM so it stays on even when the PC is turned off. When you select this option, a confirmation window appears. Select YES to save changes and exit.



---

If you attempt to exit the Setup program without saving your changes, the program prompts you with a message asking if you want to save your changes before exiting. Press <Enter> to save the changes while exiting.

---

## Exit & Discard Changes

Select this option only if you do not want to save the changes that you made to the Setup program. If you made changes to fields other than System Date, System Time, and Password, the BIOS asks for a confirmation before exiting.

## ASUS EZ Flash 2

Press Enter to run ASUS EZ Flash 2 utility.

## Load Setup Defaults

This option allows you to load the default values for each of the parameters on the Setup menus. When you select this option or if you press <F5>, a confirmation window appears. Select YES to load default values. Select Exit & Save Changes or make other changes before saving the values to the non-volatile RAM.

## Discard Changes

This option allows you to discard the selections you made and restore the previously saved values. After selecting this option, a confirmation appears. Select YES to discard any changes and load the previously saved values.

## Free Manuals Download Website

<http://myh66.com>

<http://usermanuals.us>

<http://www.somanuals.com>

<http://www.4manuals.cc>

<http://www.manual-lib.com>

<http://www.404manual.com>

<http://www.luxmanual.com>

<http://aubethermostatmanual.com>

Golf course search by state

<http://golfingnear.com>

Email search by domain

<http://emailbydomain.com>

Auto manuals search

<http://auto.somanuals.com>

TV manuals search

<http://tv.somanuals.com>