

Errata

Title & Document Type: 8530A Microwave Receiver User's Guide

Manual Part Number: 08530-90016

Revision Date: February 1, 1994

HP References in this Manual

This manual may contain references to HP or Hewlett-Packard. Please note that Hewlett-Packard's former test and measurement, semiconductor products and chemical analysis businesses are now part of Agilent Technologies. We have made no changes to this manual copy. The HP XXXX referred to in this document is now the Agilent XXXX. For example, model number HP8648A is now model number Agilent 8648A.

About this Manual

We've added this manual to the Agilent website in an effort to help you support your product. This manual provides the best information we could find. It may be incomplete or contain dated information, and the scan quality may not be ideal. If we find a better copy in the future, we will add it to the Agilent website.

Support for Your Product

Agilent no longer sells or supports this product. You will find any other available product information on the Agilent Test & Measurement website:

www.tm.agilent.com

Search for the model number of this product, and the resulting product page will guide you to any available information. Our service centers may be able to perform calibration if no repair parts are needed, but no other support from Agilent is available.



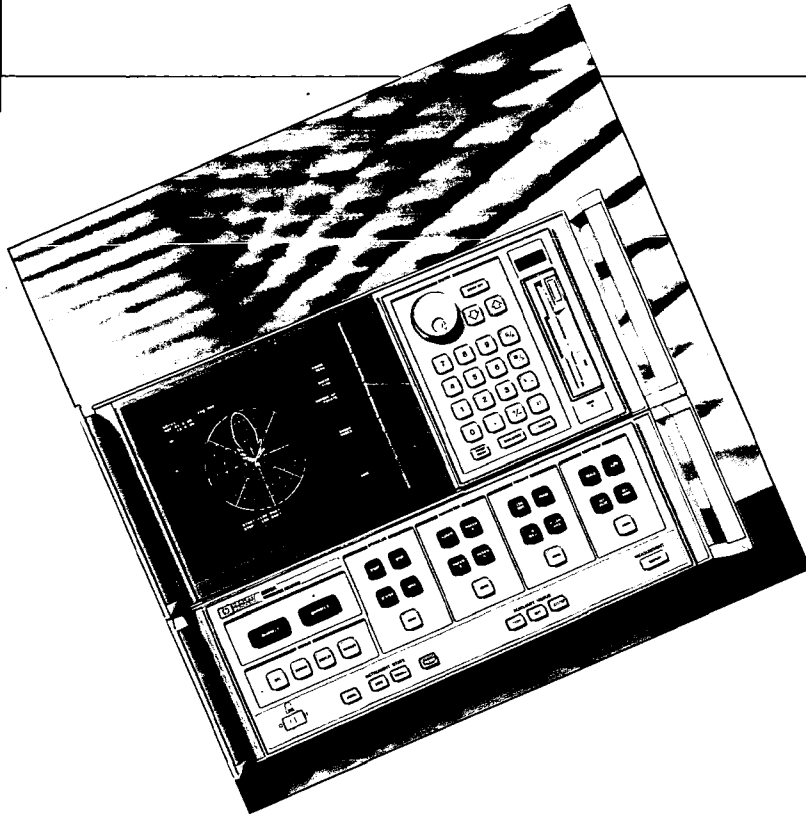

User's Guide

HP 8530A Microwave Receiver

R-4P
aajw

HP 8530A Microwave Receiver User's Guide



HP Part No. 08530-90016
Printed in U.S.A. February 1994

Edition 3

Notice

This document contains proprietary information which is protected by copyright. All rights are reserved. No part of this document may be photocopied, reproduced, or translated to another language without prior written consent of Hewlett-Packard Company.

NOTE: Figure A-1 and Figure A-3 may be photocopied for use by the operator of the HP 8530A. These figures may not be reproduced in other documents.

Hewlett-Packard Company
Santa Rosa Systems Division
1400 Fountaingrove Parkway
Santa Rosa, CA 95403, U.S.A.

Printing History

New editions of this manual will incorporate all material updated since the previous editions. The manual printing date and part number indicate its current edition. The printing date changes when a new edition is printed. (Minor corrections and updates which are incorporated at reprint do not cause the date to change.) The manual part number changes when extensive technical changes are incorporated.

Edition	Date
Edition 1	October 1991
Edition 2	May 1992
Edition 3	October 1993

Manual Applicability

This manual applies directly to HP 8530A Receivers having an HP 85102R IF detector with serial number prefix 3238A or higher, running firmware revision A.01.60

Safety, Warranty, Regulatory Information

Safety, warranty, and regulatory information is supplied in the *HP 8530A Operating and Programming Manual*.

Warning



Before this instrument is switched on, make sure it has been properly grounded through the protective conductor of the ac power cable to a socket outlet provided with protective earth contact.

Any interruption of the protective (grounding) conductor, inside or outside the instrument, or disconnection of the protective earth terminal can result in personal injury.

Caution



Before this instrument is switched on, make sure its primary power circuitry has been adapted to the voltage of the ac power source.

Failure to set the ac power input to the correct voltage could cause damage to the instrument when the ac power cable is plugged in.

Instrument Overview

For more information on instrument controls, refer to "Front Panel Overview" in Chapter 1 and "Front and Rear Panel" (Chapter 3) in the *HP 8530A Operating and Programming Manual*.

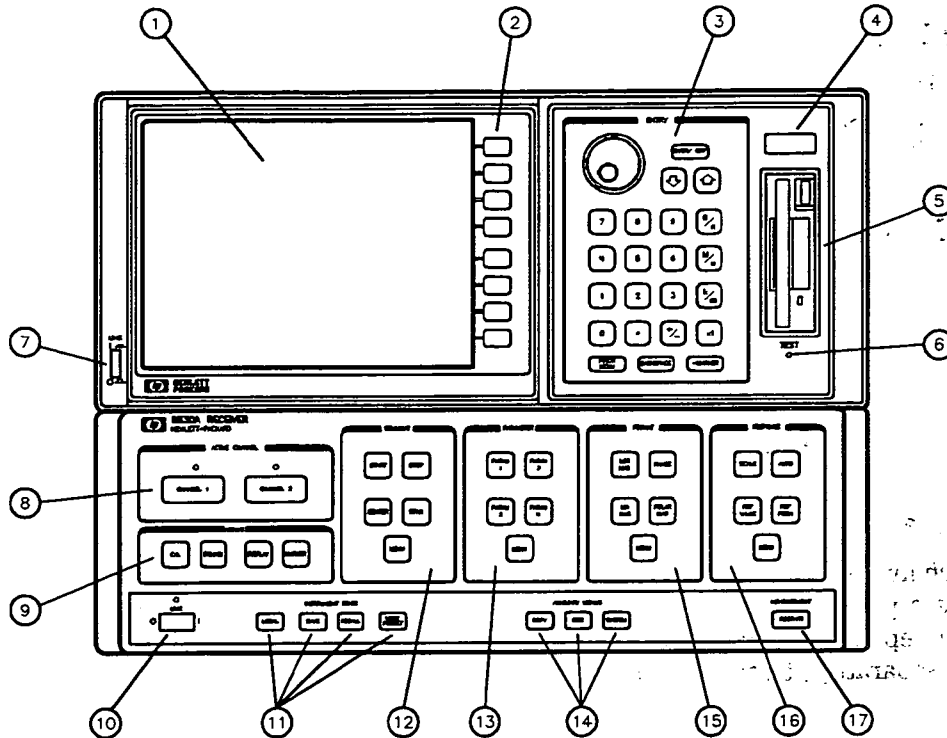

Figure 0-1. Instrument Overview

1. Display

The display shows measurement results and information messages. It also shows the names of display softkeys.

2. Softkeys

Many functions are controlled by softkeys. The title of each softkey is displayed on the display.

3. Entry Block

The entry block allows you to:

- Enter numeric values using the keypad **0** through **9**, **+/-**.
- Terminate values with appropriate units **G/n** (giga or nano), **M/u** (mega or micro), **k/m** (kilo or milli), **x1** (basic units),
- Increase or decrease values using the **▲** and **▼** keys, or using the rotary knob.
- Correct errors using the **BACKSPACE** key.
- Go up one level of softkey menus by pressing **PRIOR MENU**.
- Turn OFF the active function by pressing **ENTRY OFF**.

4. Status Display

This diagnostic/status display has the characters R L T S 8 4 2 1 in it. This display shows the HP-IB Remote (R), Listen (L), or Talk (T) status, or shows if a service request "SRQ" has been asserted (S). The numbers are self-test indicators.

5. Disc Drive

The disc drive accepts 3.5 inch DOS or Hewlett-Packard LIF format disks. Either 720 kB or 1.44 MB DOS disks can be used. The HP 8530A can show disc contents, format in DOS or LIF format, delete files, or undelete the last file deleted (undelete works on LIF format discs only).

6. TEST Button

Causes self tests to be performed on the receiver.

7. AC power switch

This switch applies AC power to the Display section (turn this ON after the power switch on the bottom box, see item 10).

8. Channel Select

The two channels make the same measurement, and then split the raw data results into two parallel data processing pathways. Each channel allows you to apply different instrument features independently of the other channel. The final results from each channel can be displayed separately, or they can be overlaid on the same graticule.

9. Menus

Contains several major functions

- **CAL** controls three different types of measurement calibration.
- **DOMAIN** selects Angle, Frequency, or Time Domain operation.
- **DISPLAY** selects how many different measurements to display on the screen at once.
- **MARKER** allows you to use the marker features of the instrument.

10. AC power switch

This switch applies AC power to the bottom section.

11. Instrument State

Contains several functions:

- **LOCAL** allows you to specify the HP-IB addresses of the receiver and “slave” instrument connected to the System Interconnect. (The System Interconnect is the HP 8530A’s “personal” HP-IB bus. Any devices connected to it (printers, plotters, RF or LO sources) are controlled exclusively by the HP 8530A.
- **SAVE** and **RECALL** allow you to save current measurement settings to one of eight save/recall registers (for later recall).
- **USER PRESET** any setup you save in save register 8 becomes the “user preset” state. Any time you turn power ON or press **USER PRESET** the settings stored in register 8 are retrieved.

12. Stimulus Block

The stimulus block controls most of the functions associated with the basic measurement setup. Stimulus controls include:

- Measurement start/stop or center/span values for angle, frequency, or time.
- Power levels for RF and LO sources.
- Sweep type (single sweep, continuous sweeps, ramp sweep, step sweep, and more).
- Number of measurement points (in Frequency Domain), or increment angle (in Angle Domain).
- Frequency List mode setup.
- Trigger mode (internal, external, or HP-IB).
- HP 85370A Position Encoder controls.

13. Parameter Block

This block selects which HP 8530A inputs to measure. the main keys **PARAM 1** through **PARAM 4** select different “ratioed” measurements. “Ratio” means that a test and reference signal are measured, and then are mathematically divided together. This method provides very accurate measurement results. Softkey menus under this block’s **MENU** key allows you to measure any of the four input lines without ratioing. (This feature allows you to check the signals on the a1, a2, b1, or b2 input lines.)

14. Auxiliary Menu

This area contains three control keys:

- **COPY** allows you to print or plot the measurement results.
- **DISC** allows you to use the disc drive to save or load files, format discs, and perform other disc-related functions.
- **SYSTEM** contains instrument configuration functions. Examples of the type of functions that are controlled are: phase lock, IF calibration, power leveling, and multiple-source setup (used when more than one source is connected to the HP 8530A). The system key also has service menus that are used when troubleshooting the instrument.

15. Format Block

This block allows you to select different display formats such as Cartesian or polar, in linear or log format.

16. Response Block

This block controls the following:

- Display scale
- Position and value of the reference line
- Automatic display scale (autoscale)
- Measurement averaging
- Trace smoothing
- Trace "normalization" (A specific point on the measurement trace is set to 0 dB, and other portions of the trace are displayed relative to that.)
- Magnitude slope and offset control
- Phase offset control
- Coaxial, waveguide, or user-definable electrical delay selection

17. **RESTART**

This key is used when you are making swept measurements. It aborts any measurement that is in progress. If you are using the single sweep mode, **RESTART** can start a new sweep.

Guide to this Manual

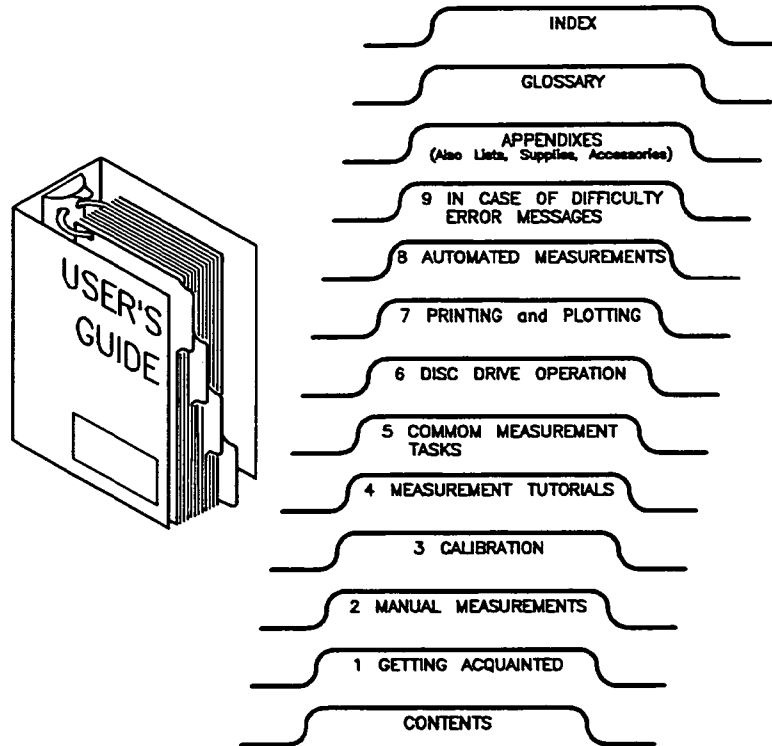

Figure 0-2. Sections in the HP 8530A User's Guide.

Chapter 1. Getting Acquainted with the HP 8530A receiver

Chapter 1 provides a quick overview of the front panel controls, display, rear panel, and HP 8530A features.

Chapter 2. Manual Measurement Examples

Chapter 2 shows very basic antenna and RCS measurement examples.

Chapter 3. Calibration

Chapter 3 describes the calibration features of the HP 8530A, and how to use them.

Chapter 4. Measurement Tutorials

This chapter gives more in-depth information on making measurements. Feature choices are explained so you can customize measurements to suit your needs. This chapter also explains how to use the HP 85370A Position Encoder.

Chapter 5. Common Measurement Tasks

Chapter 5 describes specific measurement tasks such as:

- | | |
|--------------------------------------|--------------------------------|
| Finding boresight | Using Markers |
| Determining 3 dB beamwidth | Measuring depth of a null |
| Displaying data relative to the peak | Displaying more than one trace |
| Using averaging | Using frequency list mode |

Chapter 6. Disc Drive Operation

Explains how to use the built-in disc drive to store and retrieve data, instrument state files, and other types of information.

Chapter 7. Printing and Plotting

Describes how to output screen “snapshots” or tabular data to printer or plotter. A wide range of HP printers and plotters are covered in detail.

Chapter 8. Making Automated Measurements

Chapter 8 explains how to measure up to 5,000 points per second using Fast CW mode, and how to use the Fast IF Multiplexing. (Fast IF multiplexing is similar to Fast CW, but allows the receiver to automatically switch between different input ratios at each angle or frequency point.)

Chapter 9. In Case of Difficulty

This chapter explains:

- How to solve common operation problems
- What to do when specific error messages are displayed on the screen.
- How to solve basic hardware problems.

Appendix A, Optimizing Dynamic Range

Configuring the system for optimum dynamic range entails using the highest RF power settings possible without overdriving the receiver. Appendix A explains how to configure your system so optimum dynamic range is available.

Appendix B, Compatible Instruments and Peripherals

Lists compatible RF and LO sources, frequency converters, positioner controllers, printers, plotters, and monitors.

Appendix C, Supplies, Accessories, After-Sale Options

Lists commonly-needed supplies (plotter pens, paper, discs) and after-purchase options (time domain option, rack-mount hardware, connector savers, and touch-up paint).

Appendix D, Connector Care

Explains connector care techniques and cleaning procedures.

Other Manuals that Come with the HP 8530A

The following manuals are supplied with the HP 8530A:

Operating and Programming Manual

The Operating and Programming manual serves two purposes:

- It provides in-depth reference information on front panel features, organized around the front panel functional blocks.
- It provides tutorial information on remote programming, with many HP BASIC examples.

Keyword Dictionary

The Keyword Dictionary explains:

- The function of each front panel key or display softkey, organized by key/softkey name.
- What each HP-IB programming code does, including syntax and programming sequence details.

Front panel key/softkey and programming code descriptions coexist in the same section, in alphabetical order.

On-Site Service Manual

The On-Site Service Manual contains:

- Installation
- Troubleshooting
- Performance tests and specifications

Typeface Conventions

Bold	Bold type is used for terms that are listed in the glossary.
<i>Italics</i>	Italic type is used for emphasis and for the titles of manuals and other publications. It is also used when describing a computer <i>variable</i> .
Computer	Computer type is used to depict HP-IB commands.
Display	Display type is used to show messages which are displayed on the receiver's display.
Front Panel Keys	Front panel keys are enclosed in boxes.
Soft Keys	Soft keys are the keys on the right-hand side of the display. The function of these keys changes depending on the menu you are in.

Contents

1. Getting Acquainted with the HP 8530A Receiver	
Chapter Contents	1-1
Product Description	1-2
Receiver Performance	1-3
Sensitivity	1-3
Linearity over a Wide Dynamic Range	1-4
Fast Measurement Speed	1-4
Measurement Features	1-5
Angle Domain	1-5
Frequency Domain	1-5
Time Domain	1-6
Calibration	1-6
Four Measurement Inputs	1-6
Selectable Input Ratios	1-6
Flexible Triggering	1-7
Save/Recall Registers	1-7
Measure Performance Relative to the Peak of the Main Lobe	1-7
Remote Programming	1-7
Data Presentation Features	1-7
Display Formats	1-7
Multiple Measurements Can be Shown Simultaneously	1-7
Trace Memory and Trace Math	1-8
Markers Display Precise Values for Any Point on display Traces	1-8
External Video Monitor	1-8
Optional Network Analysis	1-8
Input/Output Features	1-9
Printing and Plotting Features	1-9
Many Supported Peripherals	1-9
Built In Disc Drive	1-9
Principles of Operation	1-10
Description of the HP 8530A	1-10
Analog Signal Process Stages	1-12
Digital Data Process Stages	1-13
About the Main Microprocessor	1-13
Raw Data Stages	1-13
Other Digital Processing Stages	1-13
Front Panel Overview	1-14
Display	1-14
Channel Selection	1-15
Basic Measurement Functions	1-16
ENTRY Block	1-17
Changing Values Using the Numeric Keypad	1-17
Other Keys in the Entry Block	1-18
MENUS Block	1-19
INSTRUMENT STATE Block	1-20
AUXILIARY MENUS Block	1-21

Automatic Recall of Instrument Settings	1-22
The Added Benefit of the SAVE/RECALL feature	1-22
Typical Softkey Menu Structure	1-23
2. Manual Measurement Examples	
Chapter Contents	2-1
Definitions of Important Terms	2-2
Antenna Measurements	2-3
Angle Scan Measurements	2-4
Notes Regarding Angle Scan Measurements	2-4
What Triggers Measurements at Each Angle?	2-4
Example Measurement	2-4
Typical Test Setup	2-5
Calibrate	2-5
Make Measurement Settings	2-5
Choose Display Format	2-7
Choose Display Scale and Reference Line Settings	2-7
One step 40 dB or 60 dB patterns	2-7
Individual scale and reference controls	2-7
Measure the Antenna	2-8
Aborting a Measurement	2-9
Frequency Response Measurements (at a Fixed Angle)	2-10
Calibrate	2-10
Choose Measurement Settings	2-10
Choose Display and Reference Settings	2-11
Choose Sweep Type	2-11
Choosing the Best Sweep Mode for Your Measurements	2-11
Choosing Single or Continual Measurements	2-11
Radar Cross Section Measurements	2-12
Frequency Domain Measurements	2-13
Typical Test Setup	2-13
Calibrate	2-13
Choose Measurement Settings	2-14
Choose Display Format	2-14
Measure the Target	2-15
Choose the Best Sweep Mode for Your Measurements	2-15
Choose Single or Continual Measurements	2-16
Using Markers	2-16
Time Domain Measurements	2-16
Converting to Time Domain	2-16
Choose the Display Format	2-16
Measure the Target	2-17
Using the Markers	2-17
A Quick Display Adjustment	2-18
Improving RCS Measurement Accuracy	2-19
Using Gating	2-19
Viewing Frequency and Time Domain Gating	2-20

3. Antenna and RCS Calibration	
Chapter Contents	3-1
Information Pertaining to All Calibration Types	3-2
What is Calibration?	3-2
Calibration Requirements	3-3
Use the Same Equipment Setup in the Measurement	3-3
Settings You Can Change after Performing a Calibration	3-3
Setting Changes that Require Special Consideration	3-3
Changing Parameter	3-3
Changing Stimulus Values	3-4
Settings that should not be changed	3-4
Selecting a Different Frequency Range	3-4
Selecting a Greater Number of Points	3-4
Using Averaging	3-4
If you are using averaging	3-4
Specific Calibration Procedures	3-6
Antenna Calibration	3-7
Important Terms	3-7
Angle Domain and Frequency Domain Calibrations	3-7
Using a Frequency Domain Calibration in Angle Domain.	3-7
Standard Gain Antenna Definitions	3-9
Performing an Antenna Calibration	3-9
Frequency Domain Calibration	3-9
Angle Domain Calibration	3-13
Important Note On Antenna Measurements	3-15
Things to Try	3-15
RCS Calibration	3-16
RCS Calibration Description	3-16
Important Information about Gating During the Calibration	3-16
RCS Calibration Overview	3-17
RCS Calibration Procedure	3-18
Updating the Background	3-21
Network Analyzer Calibration	3-22
Creating a Standard Gain Antenna Definition	3-23
Introduction	3-23
Important Terms	3-23
The Supplied Cal Definition	3-23
Required Hardware	3-23
Creating an Antenna Definition	3-24
Choosing the Number of Frequency Points to Define	3-24
Covering a Wide Frequency Range	3-24
Determine Required Stimulus Values	3-24
Choosing the Number of Points	3-24
Determining the Frequency Increment	3-24
Determining Gain Values at Each Frequency Increment (Graph Format)	3-25
If Using Data in Table Format	3-26
Even Frequency Increments	3-26
Required ASCII File Format	3-27
In-Depth Description of a Cal Definition	3-28
Saving the Cal Definition File	3-29
Loading the Cal Definition into the HP 8530A	3-29
Creating a Cal Definition with Multiple Antenna Definitions	3-30
Details on the Supplied Antenna Definitions	3-31

4. Measurement Tutorials	
Chapter Contents	4-1
Angle Domain Measurement Tutorial	4-2
Step 1. Choose Internal, External, or HP-IB Triggering	4-2
Selecting HP-IB or TTL Trigger	4-2
Step 2. Choose a Measurement Frequency	4-2
Step 3. Choose a Single Angle or Swept Angle Measurement	4-2
Step 4. Choose Single or Continual Measurements	4-3
Step 5. Choose which Parameters to Measure	4-3
Step 6. Make a Swept Measurement	4-4
Making Swept Measurements Using Single Sweep Mode	4-4
Making Swept Measurements Using Continual Sweep Mode	4-4
External Triggering	4-5
Before You Use External Trigger Modes	4-5
Using External Trigger Modes	4-5
Advanced Triggering Features	4-6
How these Functions Work when One Parameter is Being Measured	4-7
How these Functions Work when Four Parameters are Being Measured	4-7
HP 85370A Position Encoder Operation	4-11
Introduction	4-11
Position Encoder Softkeys	4-11
Configuration Functions	4-12
Single and Dual Synchro	4-12
Selecting single and dual synchro mode for any axis	4-12
Angle Display Modes	4-12
Operational Functions	4-13
Axis Controls	4-13
Boresight Angle	4-13
Offset Functions	4-13
Details about Save Offset	4-13
Offsets are axis-independent	4-13
Adding incremental offsets	4-13
Using offset functions	4-14
Encoder Settings and Save/Recall Registers	4-14
Frequency Domain Measurement Tutorial	4-15
Step 1. Select Internal Triggering	4-15
Step 2. Choose a Single Point or Swept Measurement	4-15
Single Point mode	4-15
Step Sweep mode	4-15
To Increase Step Sweep and Frequency List Mode Measurement Speeds	4-15
Method 1, check RF (and LO) source versions	4-15
Use Quick Step mode, if possible =steptype>	4-15
Frequency List mode	4-16
Ramp Sweep mode	4-16
Sweep Time	4-17
Step 3. Choose Single or Continual Measurements	4-17
Step 4. Choose which Parameters to Measure	4-18

5. Common Measurement Tasks	
Chapter Contents	5-1
Saving and Recalling Instrument States (Measurement Settings)	5-2
Saving and Recalling Instrument States	5-2
User Preset	5-2
Loading Instrument States From Disc	5-2
Using Markers	5-3
Moving the Marker to the Peak	5-3
Discrete and Continuous Marker Modes	5-3
Turning On Another Marker	5-4
Marker List Mode	5-4
Using Delta Markers, Target Markers, Marker Search	5-5
Finding Depth of a Null	5-5
Delta Marker Method	5-5
Normalize Method	5-6
Determining Beamwidth or Bandwidth	5-7
Displaying Multiple Channels or Parameters	5-8
Viewing Two Channels at Once	5-8
Viewing Multiple Parameters	5-9
Important Information about Polar Format	5-9
Displaying a Single Input (Non-Ratioed Measurement)	5-10
Displaying Data Relative to the Peak (Normalizing Data)	5-12
Finding Boresight	5-13
Boresight Method 1 (Flat Line Method)	5-13
Boresight Method 2 (Pattern Display Method)	5-14
Using Averaging	5-15
Creating a Frequency List	5-16
Entering the First Segment	5-16
Add Segments	5-17
Editing the Frequency List	5-17
Changing a Segment	5-17
Deleting a Segment	5-18
Adding a Segment	5-18
Duplicate Points	5-18
Selecting All Segments or a Single Segment	5-19
Frequency List Save and Recall	5-19
Exit Frequency List	5-19
Switching Between HP 8530 and 8510 Operation	5-20
Changing between Operating Systems	5-20
How Changing Operating Systems Affects Instrument Registers	5-20
Copying the Operating System Discs	5-21
Copying the HP 8530A Operating System to Disc	5-21
Copying the HP 8510C Operating System to Disc	5-21
6. Disc Drive Operation	
Chapter Contents	6-1
Features	6-1
Compatible Disc Types, Disc Storage Capacity	6-2
DOS Subdirectories	6-2
Disc Menu	6-2
ASCII and Binary File Types	6-3
Changing between DOS and LIF Discs	6-3
Initializing Discs	6-3
Storing Disc Files	6-4
Loading Disc Files	6-6

Loading a File	6-7
Viewing a Directory of Files	6-7
Deleting Disc Files	6-8
Un-deleting Disc Files	6-8
Using an External Disc Drive	6-8
Compatible Disc Drives	6-8
Disc Unit Number and Disc Volume	6-8
Connections and Configuration Settings	6-8
Initializing a Hard Disc	6-9
Guide to Saving Data	6-10
Sharing a System	6-11
Saving Everything	6-11
Viewing or Plotting Old Data	6-12
7. Printing and Plotting	
Chapter Contents	7-1
Compatible Printers and Plotters	7-1
Installation Considerations	7-2
Supported Interfaces	7-2
Connecting an HP-IB Printer or Plotter	7-2
Connecting an RS-232 Printer or Plotter	7-2
Selecting the HP-IB (System Bus) or RS-232 Ports	7-2
RS-232 Print/Plot Buffers	7-2
Adding Your Own Annotations to the Screen	7-3
Using a Printer	7-4
Printing Features	7-4
What is Printed	7-4
Installing a Printer	7-4
Selecting the Output Port	7-4
Printer and HP 8530A Configuration	7-5
Using a Laser Printer	7-6
Configuring the Laser Printer	7-6
Standard Configuration	7-6
Other Laser Printer Settings	7-6
Configuring the Receiver	7-6
Selecting Printer Resolution	7-6
High Speed Configuration	7-7
Why it is Faster?	7-7
My printer has Built-In HP-GL, Do I still Need the Cartridge?	7-7
Ordering the Cartridge	7-7
Printer memory required	7-8
Setting up the Printer	7-8
Other Laser Printer Settings	7-8
Configuring the Receiver	7-8
Switching Between a Real Plotter and an HP-GL-emulating Laser Printer	7-9
Using an HP DeskJet, DeskJet Plus, or DeskJet 500 Printer	7-10
Serial Setup	7-10
Serial DIP switch settings	7-10
Prepare the Printer for Use	7-10
Configuring the Receiver	7-10
Selecting Printer Resolution	7-10
Additional Steps Required for the HP DeskJet 500C	7-10
Using an HP QuietJet, QuietJet Plus, PaintJet, or PaintJet XL Printer	7-11
Serial Setup	7-11
Serial DIP switch settings	7-11

HP-IB Setup	7-11
HP-IB address DIP switch settings	7-11
Prepare the Printer for Use	7-12
Configuring the Receiver	7-12
Selecting Printer Resolution (HP QuietJet and QuietJet Plus printers)	7-12
Selecting Printer Resolution (HP PaintJet and PaintJet XL printers)	7-12
Printing In Color	7-12
Using an HP ThinkJet Printer	7-13
Serial Setup	7-13
Serial DIP switch settings	7-13
HP-IB Setup	7-13
HP-IB address DIP switch settings	7-13
Prepare the Printer for Use	7-13
Configuring the Receiver	7-13
Selecting Printer Resolution	7-13
Using Non-HP Printers	7-14
Serial Setup	7-14
Serial DIP switch settings	7-14
HP-IB Setup	7-14
HP-IB address DIP switch settings	7-14
Before Printing	7-14
Printing	7-15
Landscape and Portrait Printing	7-15
Printing One Snapshot per Page (Portrait or Landscape)	7-16
Printing Two Snapshots per Page	7-16
Printing Tabular Measurement Data	7-17
Changing the format of the tabular data	7-17
Printing Instrument Settings and System Configuration	7-19
Using a Plotter	7-22
Plotting Features	7-22
What is Plotted	7-22
Installing a Plotter	7-22
Selecting the Output Port	7-22
Special instructions for connecting the HP 7550	7-22
HP 7550B and 7550 Plus Plotters	7-23
Plotting Options	7-23
Plotting Options	7-23
Selecting Pen Color	7-23
Plotting	7-25
Plotting One Snapshot per Page	7-25
Plotting Individual Display Components	7-25
Plotting a Selected Quadrant (four snapshots per page)	7-26
8. Making Automated Measurements	
Chapter Contents	8-1
Remote Programming	8-2
What is Remote Programming?	8-2
What this Section Explains	8-2
Transferable Data	8-2
Available Data Transfer Formats	8-4
Summary	8-4
High Speed Automated Operation	8-5
What is Fast CW Mode?	8-5
The Three Fast CW Modes	8-5
Which Parameter is Measured in Fast CW Mode?	8-6

How to Transfer Fast CW Data	8-6
Limitations	8-6
How Averaging Works with the Buffer	8-7
Fast IF Multiplexing	8-8
Using Fast IF Multiplexing Mode	8-8
Timing Considerations	8-10
Standard Fast CW Mode Timing (HP-IB Command FASC)	8-11
Fast Data Collection Mode (HP-IB Command FASD)	8-12
Autoranged Data Collection Mode (HP-IB Command FASAD)	8-13
Fast IF Multiplexing Mode (HP-IB Command FASMD)	8-14
Changing Minimum Re-Trigger Time	8-14
HP BASIC Fast CW Programming Examples	8-15
Fast CW Using the ENTER Command	8-15
Fast CW Using the TRANSFER Command	8-17
HP BASIC Fast IF Multiplexing Mode Programming Example	8-19
9. In Case of Difficulty	
Chapter Contents	9-1
Common Operation Problems	9-2
Receiver will not Sweep	9-2
Check the Selected Sweep Mode	9-2
Check the System Phase Lock Setting	9-2
IF Signal Level Problems	9-3
On Systems Using the HP 85309A Frequency Converter	9-3
On Systems Using the HP 8511A/B Frequency Converter	9-3
Possible Solutions	9-3
LO Signal Level Problems (applies to the HP 85309A only)	9-4
LO Signal Is Too Low	9-4
HP 85309A "LO POWER OUT OF RANGE" light is ON During Measurement	9-4
Rotary Joint Problems	9-5
Common Error Messages	9-6
A	9-6
"ABORTED ENCODER TRIGGERED SWEEP"	9-6
"ADDITIONAL STANDARDS NEEDED"	9-6
In Antenna Calibration	9-6
In Network Analyzer Calibration	9-6
C	9-6
"CALIBRATION RESET"	9-6
"CORRECTION MAY BE INVALID"	9-6
E	9-7
"ENCODER NOT FOUND"	9-7
"ENCODER OFFSET ANGLE ALREADY SAVED"	9-7
F	9-7
"FREQUENCY CONVERTER IS TOO HOT!"	9-7
I	9-7
"IF OVERLOAD"	9-7
N	9-8
"NO IF FOUND"	9-8
O	9-8
"OPTION #005 NOT INSTALLED"	9-8
"OVERSPEED ERROR - BACKUP"	9-8
P	9-9
"PHASE-LOCK LOST"	9-9
Phase Lock Problems when using Hardware Gating	9-9
S	9-9

“SOURCE (1 or 2) FAILURE - RF UNLOCKED”	9-9
“SWEEP SYNC ERROR”	9-9
“SYSTEM BUS ADDRESS ERROR”	9-9
T	9-11
“TEST SET IS TOO HOT!”	9-11
U	9-11
“UNABLE TO RAMP THIS DUAL SOURCE SETUP”	9-11
V	9-11
“VTO FAILURE”	9-11
If Using the HP 8511A/B	9-11
If Using the HP 85309A	9-11
Hardware Problems	9-12
HP 8530A Locks Up	9-12
If Your System Uses the HP 8511A/B	9-12
If Your System Uses the HP 85309A	9-12
An Instrument will not Respond to Computer Control	9-12
If the instrument operates manually	9-12
If the instrument does not operate manually	9-13
A System Bus Instrument will not Respond	9-13
If the instrument operates manually	9-13
If the instrument does not operate manually	9-14
HP 85309A (LO/IF Unit) Problems	9-14
LO/IF Unit Does Not Turn ON	9-14
The LO POWER OUT OF RANGE Light is ON	9-14

A. Optimizing Dynamic Range

List of Appendixes	A-1
Introduction to Appendix A	A-1
Optimizing Dynamic Range for HP 85310A Frequency Converter	A-2
Simple Method for Improving Dynamic Range	A-2
Calculating Maximum Dynamic Range	A-2
Set RF Source Power Level	A-2
Enter Known Measurement System Gain/Loss Values	A-2
Calculate Unknown Measurement System Gain/Loss Values	A-4
Increase RF Source Power if Possible	A-6
Optimizing when the Mixers Receive Different Power Levels	A-6
Check Actual IF Power Levels	A-6
Optimum Dynamic Range for HP 8511A/B Frequency Converter	A-7
Simple Method for Improving Dynamic Range	A-7
Calculating Maximum Dynamic Range	A-7
Set RF Source Power Level	A-7
Enter Known Measurement System Gain/Loss Values	A-7
Calculate Unknown Measurement System Gain/Loss Values	A-9
Increase RF Source Power if Possible	A-10
Optimizing when a1 and b2 Receive Different Power Levels	A-10
Check Actual IF Power Levels	A-10

B. Compatible Instruments and Peripherals	
Compatible LO Sources	B-1
HP 8350 Plug-Ins	B-1
HP 8360 Family Sources	B-1
Fast measurement speed and Quick Step mode	B-2
Compatible RF Sources	B-2
Fast Measurement Speeds and Quick Step Mode	B-3
Compatible Frequency Converters	B-3
HP 85310A Distributed Frequency Converter	B-3
HP x85325A Millimeter Wave Subsystem	B-3
HP 8511A/B Frequency Converter (Test Set)	B-3
Compatible Printers	B-4
Compatible Plotters	B-4
Compatible External Monitors	B-4
C. Supplies, Accessories, After-Sale Options	
Supplies and Accessories	C-1
Diskettes	C-1
HP DeskJet Printer Supplies	C-1
HP PaintJet Printer Supplies	C-2
HP ThinkJet and QuietJet Printer Supplies	C-2
Plotter Supplies	C-2
HP-IB Cables	C-3
Connector Savers	C-3
Touch Up Paint	C-4
After-Sale Options	C-4
D. Connector Care	
Introduction	D-1
Recommended Practices	D-1
How to Inspect Connectors for Wear	D-2
How to Clean Connectors	D-2
Cleaning Supplies	D-2

Glossary

Index

Figures

0-1. Instrument Overview	iv
0-2. Sections in the HP 8530A User's Guide.	viii
1-1. Basic Antenna Measurement Block Diagram	1-3
1-2. Angle Domain	1-5
1-3. Frequency Domain	1-5
1-4. Time Domain	1-6
1-5. HP 8530A Measurement Data Flow Diagram	1-11
1-6. Phase Lock Reference	1-12
1-7.	1-14
2-1. Typical Antenna Measurement Setup	2-5
2-2. Example Antenna Measurement Results	2-8
2-3. Typical RCS Measurement Setup	2-13
2-4. Typical RCS Frequency Domain Measurement	2-15
2-5. Typical RCS Time Domain Measurement	2-17
2-6. Time Domain Measurement Showing Aliasing	2-18
2-7. A Measurement Showing the Gate Placed Around the Response	2-19
2-8. The Gate Turned ON	2-20
2-9. Dual Display with Time Domain	2-21
2-10. Dual Display with Time Domain	2-22
3-1. Cal and Cal Type Menus	3-5
3-2. Menus Associated with RCS Calibration	3-17
3-3. Dimensions Required by Different Target Types	3-20
3-4. Typical Standard Gain Antenna Performance Graph	3-25
3-5. Typical Standard Gain Antenna Performance Graph	3-27
4-1. Default External Triggering Flowchart (single parameter)	4-6
4-2. Default External Triggering Flowchart (four parameters)	4-6
4-3. Custom External Triggering Flowchart (one parameter)	4-7
4-4. Custom External Triggering Flowchart (four parameters)	4-10
4-5. Position Encoder (option 005) Softkeys	4-11
4-6. BNC Connection Required when Using Ramp Sweep or Quick Step Modes	4-16
5-1. Typical Measurement with One Marker	5-3
5-2. Typical Measurement with Two Markers	5-4
5-3. Finding Depth of Null Using Delta Markers	5-6
5-4. Typical Beamwidth Measurement (Angle Domain)	5-7
5-5. Dual Channel Display Options	5-8
5-6. Four Parameter Split Display	5-9
5-7. Differences in Angle and Frequency Domain Polar Formats	5-10
5-8. Typical Non-Ratioed Measurement of the a1 Receiver Input	5-11
5-9. Single Angle Boresight (at left) and Swept Boresight (at right)	5-14
5-10. Frequency List Menu Structure	5-16
5-11. Enter the First Segment	5-17
5-12. Frequency List, Display of Single Segment	5-19
6-1. Disc Menu, Data Type Select Menu, Setup Disc Menu, and Initialize Disc Menu	6-2
7-1. Define Print Menu	7-5
7-2. HP QuietJet and PaintJet (Family) Printer Serial Switch Settings	7-11
7-3. HP QuietJet and PaintJet (Family) Printer HP-IB Switch Settings	7-12

7-4. HP ThinkJet printer HP-IB Switch Settings	7-13
7-5. Landscape Printer Orientation	7-15
7-6. Portrait Printer Orientation	7-16
7-7. Define List Menu	7-18
7-8. System/Operating Parameters Menu	7-19
7-9. Define Plot and Plot to Plotter Menu Structure	7-26
8-1. Data Processing Stages in the Receiver	8-2
8-2. Negative Trigger Pulse	8-10
8-3. Positive Trigger Pulse	8-10
8-4. Standard Fast CW Mode Timing	8-11
8-5. Fast Data Collection Mode Timing	8-12
8-6. Autoranged Data Collection Mode Timing	8-13
8-7. Fast MUX Mode Timing	8-14
A-1. Known System Gain and Loss Values (with HP 85310A Frequency	A-3
A-2. HP 85381A/C/D Typical Insertion Loss at 25° C	A-4
A-3. Known System Gain and Loss Values (with HP 8511A/B Frequency	A-8

Tables

1-1. Numeric Value Terminator Key Usage	1-18
3-1. Proper Connector Torque	3-12
3-2. Proper Connector Torque	3-14
3-3. Example Standard Gain Antenna Performance Table	3-26
3-4. Antenna Definitions in the Supplied Cal Definition	3-31
5-1. Averaging Factor versus Theoretical Sensitivity Improvement	5-15
6-1. Disc Storage Capacities	6-2
6-2. Information You Can Store To Disc, and How it is Saved	6-3
6-3. File Types and Prefixes	6-7
7-1. Serial Printer Settings for Other Printers	7-14
7-2. Typical Initialized System Parameters Listing	7-20
7-3. Typical Operating Parameters Displays (first page)	7-21
7-4. Typical Operating Parameters Displays (second page)	7-21
7-5. Default Pen Numbers	7-24
8-1. Fast Multiplexing Mode Select Numbers	8-9
B-1. Required options for HP 85360 LO sources	B-1
B-2. Compatible Sources for Fast Measurement Speeds	B-2
B-3. External Monitors	B-5
C-1. Touch Up Paint	C-4



Getting Acquainted with the HP 8530A Receiver

Chapter Contents

- Product Description
- Receiver Performance
- Measurement Features
- Input/Output Features
- Principles of Operation
- Front Panel Overview

Product Description

The HP 8530A is a high-performance receiver that has been designed specifically for antenna and radar cross section (RCS) measurements.

The HP 8530A allows you to make angle-scan and frequency-scan measurements of antennas, or make RCS measurements using the time domain feature.

Very fast measurement speeds are possible with the HP 8530A. By using a computer controller, the receiver can measure up to 5,000 data points per second.

The receiver has very high sensitivity and dynamic range. The HP 8530A provides a large amount of measurement flexibility, providing the features you need for many different types of measurements.

The HP 8530A must be used with a frequency down converter. The following HP down converters are supported:

- HP 8511A/B frequency converter
- HP 85310A distributed frequency converter
- HP 85325 millimeter wave subsystems (the HP 85325A and HP 85309A, used together, make a complete frequency converter system).

These products down-convert microwave (or millimeter) signals to 20 MHz test and reference signals that are measured by the HP 8530A. Figure 1-1 shows the basic block diagram of an antenna measurement system.

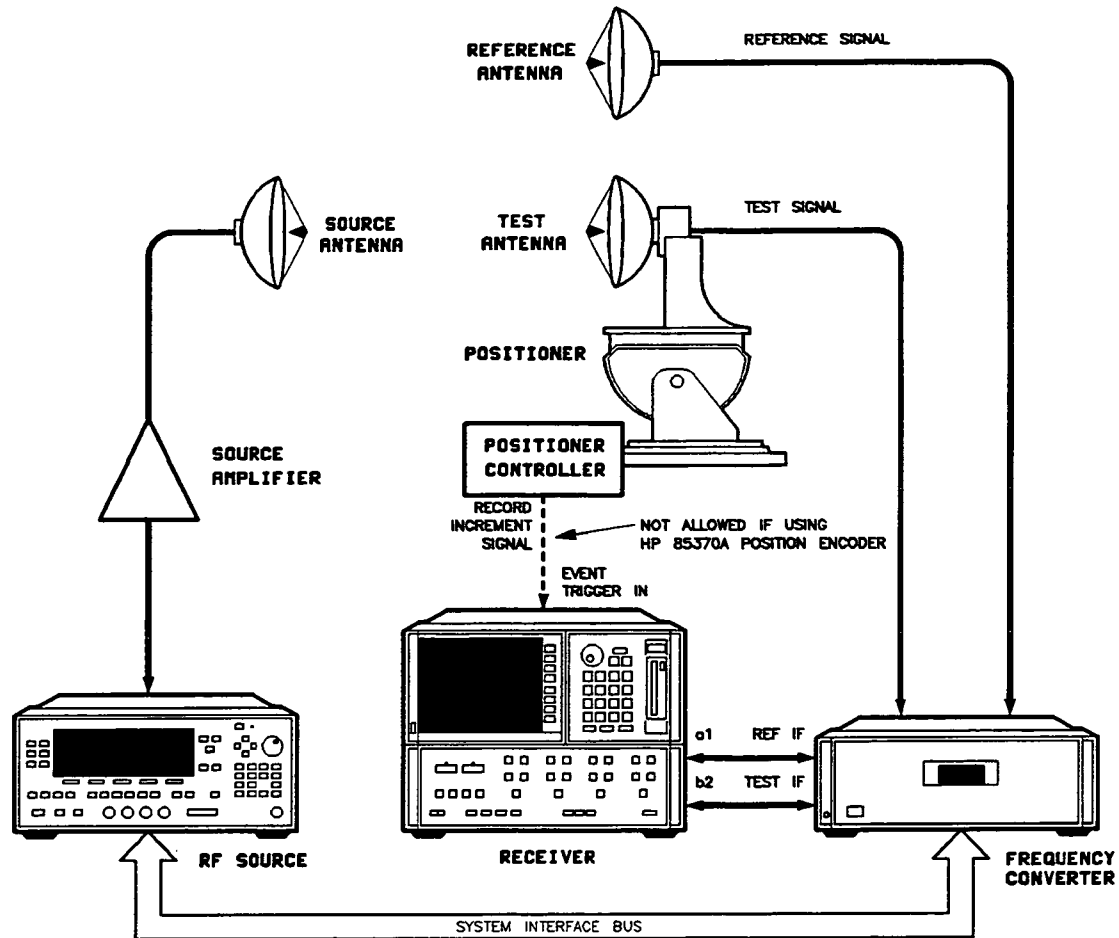

Figure 1-1. Basic Antenna Measurement Block Diagram

Receiver Performance

The most important feature of the HP 8530A is the accuracy and speed with which it makes measurements. The important performance features are:

- Excellent sensitivity.
- Excellent linearity over a wide dynamic range.
- High speed data acquisition capability.

Sensitivity

The foundation of good system performance and high speed is sensitivity—the ability to measure very small signals. Excellent sensitivity is only possible in systems that have very low noise. When used with the HP 85310A frequency converter, the HP 8530 can measure signals of -113 dBm from 3 to 18 GHz, and -96 dBm from 18 to 26.5 GHz. Excellent sensitivity improves the signal-to-noise ratio of your system, allowing you to measure smaller signals more quickly, and with greater accuracy.

Linearity over a Wide Dynamic Range

Accuracy errors can occur when the power from the test antenna varies in signal level. For example, assume that a test antenna has a bore-sight measurement of 0 dBi (-20 dBm) and an off-axis null of -50 dBi (-70 dBm). This is a difference of 50 dB. The HP 8530A receiver has 0.03 dB of error in this case. Even with a 60 dB difference the HP 8530A has less than 0.04 dB of error due to linearity. This specification is called "dynamic accuracy."

Fast Measurement Speed

The HP 8530 can measure 5000 points per second. As mentioned earlier, averaging slows measurement speed. Because of the HP 8530A's excellent performance, you will need less averaging, and can make faster measurements, than you would when using a receiver with less performance.

High speed measurements are performed using the "Fast CW" mode, and must be done through computer control.

Measurement Features

The major *operational* features of the HP 8530A are listed below:

Angle Domain

Allows you to make angle scan measurements at a single frequency. In Angle Domain mode, the x-axis of the display is angular degrees. You can measure a single angle, or a range of angles. If you DO NOT have an HP 85370A Position Encoder, use external triggering (HP-IB or TTL) in this mode. If you use the HP 85370A Position Encoder, use internal triggering mode.

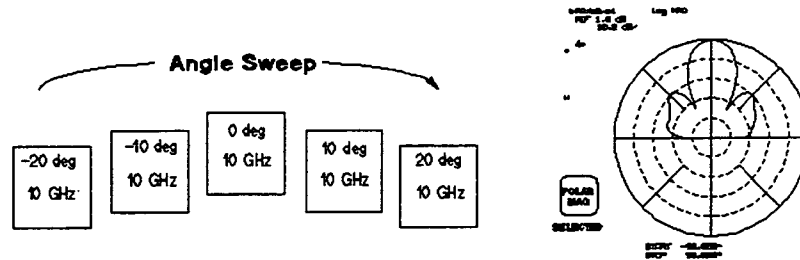

Figure 1-2. Angle Domain

Frequency Domain

Allows you to measure antenna magnitude and phase performance across one or more frequencies. Frequency Domain measurements must be made at a single *angle*. In Frequency Domain mode, the x-axis of the display is frequency. Internal triggering is commonly used when measuring frequency, but external triggering can be used as well. You can measure a single frequency, or choose from Ramp, Step or Frequency List sweep modes.

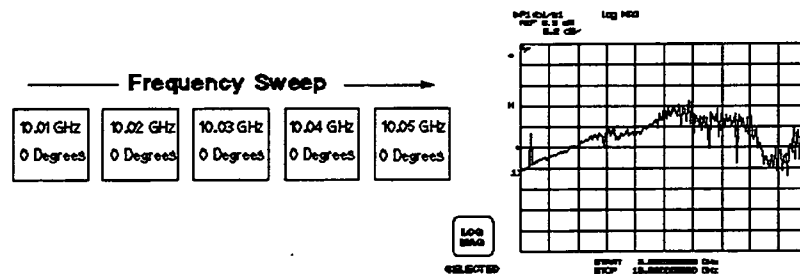

Figure 1-3. Frequency Domain

Time Domain

This optional feature allows you to make RCS measurements or see the time response of an antenna (time is shown on the displays x-axis). One use of time domain is when measuring multi-path range reflections. Internal triggering is usually used in this mode.

Time domain data is mathematically calculated from Frequency Domain data. This is done using the “chirp-Z” inverse Fourier transform. Therefore, the first step in time domain measurements is to make a measurement in the Frequency Domain.

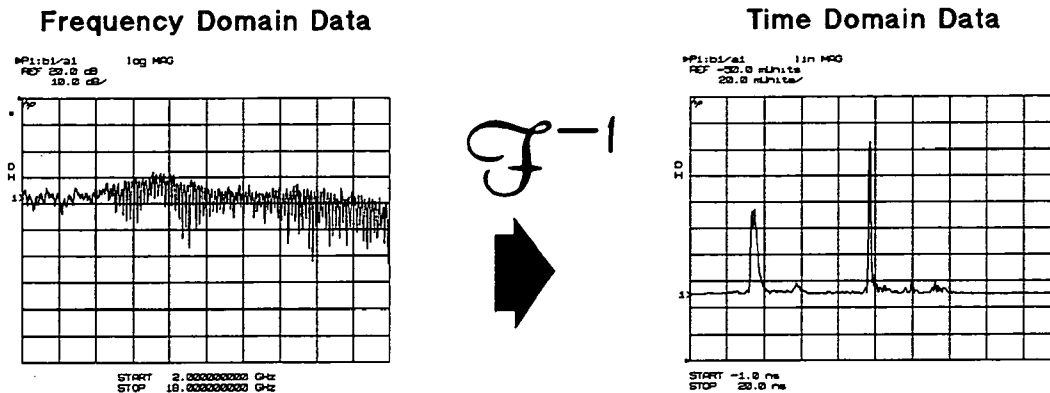

Figure 1-4. Time Domain

Calibration

Antenna calibration provides accurate gain and frequency response measurements by calibrating your range against a standard gain antenna. Also, the isolation calibration feature reduces measurement errors caused by signal crosstalk.

A “network analyzer” calibration is also provided. This calibration is used if you want to make network analyzer-type measurements. For example, assume you want to measure the impedance of an antenna input (or output). You would perform the network analyzer calibration so you could make very accurate measurements. In this example a directional coupler is required to measure the reflected signals.

Four Measurement Inputs

The receiver has four inputs for receiving signals (a1, a2, b1 and b2). You must input a reference signal into a1 or a2. Then, any other inputs can be used as test signal inputs. For example, assume you input the reference signal into a1. You could then use a2, b1, or b2 to carry test signals. The “PARAM” keys, described below, select which inputs to ratio together for your measurement.

Selectable Input Ratios

PARAM 1, **PARAM 2**, **PARAM 3**, and **PARAM 4**, select a specific pair of inputs to ratio and measure. (“PARAM” is short for “parameter.”) For example, **PARAM 1** mathematically divides (ratios) input b1 data by a1 data. You can redefine the PARAM keys so they ratio any two inputs you desire. You can also measure a single input without ratioing.

Flexible Triggering

The HP 8530A provides three ways of triggering measurements:

- | | |
|---------------------|--|
| Internal | When in Internal trigger mode, the receiver does not require any external or HP-IB triggering. This is useful when making frequency measurements, or when using the HP 85370A Position Encoder. |
| External Triggering | Allows you to trigger measurements using a TTL increment signal produced by a positioner controller. This allows the receiver to take data when the positioner is aligned with each measurement angle. |
| HP-IB Triggering | Allows a computer to trigger a measurement by issuing a GET command over the HP-IB bus. |

Save/Recall Registers

The receiver has eight Save/Recall registers. Each can save current measurement settings for instant recall at a later time. Register 8 is the "User Preset" register. Settings saved under register 8 become active whenever you turn the receiver ON, or when you press **USER PRESET**.

Measure Performance Relative to the Peak of the Main Lobe

The Normalize Trace function sets the peak of the main lobe (the data point of highest amplitude) to 0 dB. You can then use markers to view trace magnitude values relative to this reference point. When data is saved, printed, plotted, or output to computer, magnitude values will be relative to the peak.

Remote Programming

The HP 8530A can be controlled remotely from any computer that can communicate using HP-IB. All front panel features are supported. You can query the analyzer to determine current modes of operation and current instrument or system status.

Data Presentation Features

The HP 8530A can show measurement results right on its display. It can display:

- Antenna patterns
- Frequency response measurements
- Time domain
- Radar Cross Section (RCS) frequency and time domain measurements

The HP 8530A allows you to print or plot measurement results.

Display Formats

You can select logarithmic or linear magnitude display formats (Cartesian or polar), or phase display format (Cartesian only). You can display one, two, or four parameters simultaneously on the screen.

Multiple Measurements Can be Shown Simultaneously

The HP 8530A allows you to view up to four parameters at once, in split or overlay presentation. Alternatively, you can display one parameter from each of the independent measurement channels (more on channels is explained later).

Trace Memory and Trace Math

The trace memory feature is similar to the storage feature in a storage oscilloscope. You can store the current data trace to memory, then compare it to subsequent measurement traces. Trace math features allow you to perform vector addition, subtraction, multiplication, and division. These operations are performed using the current data trace and the memory trace. Each parameter has independent trace memory/math operation. In addition, trace math in Channel 1 is independent from trace math in Channel 2.

Markers Display Precise Values for Any Point on display Traces

Five measurement markers give detailed information about any point on the measurement trace. Delta markers allow you to show the difference in amplitude, phase, angle, or time between any two points on the screen.

External Video Monitor

The HP 8530A can display results on an external multisync monitor. Refer to Appendix B for details.

Optional Network Analysis

Option 011 adds high-performance vector network analysis features (HP 8510C operation). This allows you to measure the transmission and reflection properties of microwave devices in frequency or optional time domains. These advanced calibration features provide optimum accuracy in S-Parameter network measurements.

Input/Output Features

The HP 8530A can control other instruments, and has many input/output capabilities using HP-IB, System Bus, RS-232, external monitor interface, and TTL BNCs.

Printing and Plotting Features

The HP 8530A can output data to a wide range of HP-IB or RS-232 printers or plotters. Laser printers are also supported.

Many Supported Peripherals

The HP 8530A can control RF and LO signal sources, frequency converters, and large external display monitors. Refer to Appendix B for details.

Built In Disc Drive

The built in disc drive allows you to save measurement data, data from memory, instrument configuration setups, save/recall registers, calibration data, or user-created graphics. Both DOS and LIF disc formats are supported, and both disc types are automatically recognized. DOS format is compatible with MS-DOS® based computers, such as IBM PCs and compatibles. LIF format is compatible with Hewlett-Packard computers, such as the HP 9000 Series 300 workstation family.

Principles of Operation

This information is provided so you can have a better understanding of how the HP 8530A makes measurements. If desired, you can skip this section and come back to it when convenient.

Description of the HP 8530A

A simplified block diagram of the HP 8530A receiver is shown in Figure 1-5. It is a high performance vector receiver with four inputs, two independent digital processing channels, and an internal microcomputer that controls measurement, digital processing, and input/output operations. Examples of "digital processing" are features such as averaging, time domain, calibration, and so on. A special System Bus gives the receiver complete control over the RF source and, if required, LO source. This interface allows the receiver to make hard copy outputs to HP-IB compatible printers or plotters. Two RS-232 ports are also supplied for printing or plotting.

The system must contain a frequency converter, which down converts the RF measurement frequencies to a 20 MHz IF. The HP 8530A requires this frequency for its inputs. To create the IF frequency, the HP 8511A/B frequency converter uses a built-in local oscillator. The built-in LO is digitally tuned by the HP 8530A. This digital tuning data is sent over the "Test Set Interconnect" that links the HP 8530A and the HP 8511A/B. The local oscillator mixes the measurement signals with a similar frequency that is offset by 20 MHz. The result is the 20 MHz IF signal. Other down converters, such as the HP 85310A, require another source to supply an LO signal. The HP 8530A tunes external LO sources with HP-IB commands sent over the System Bus.

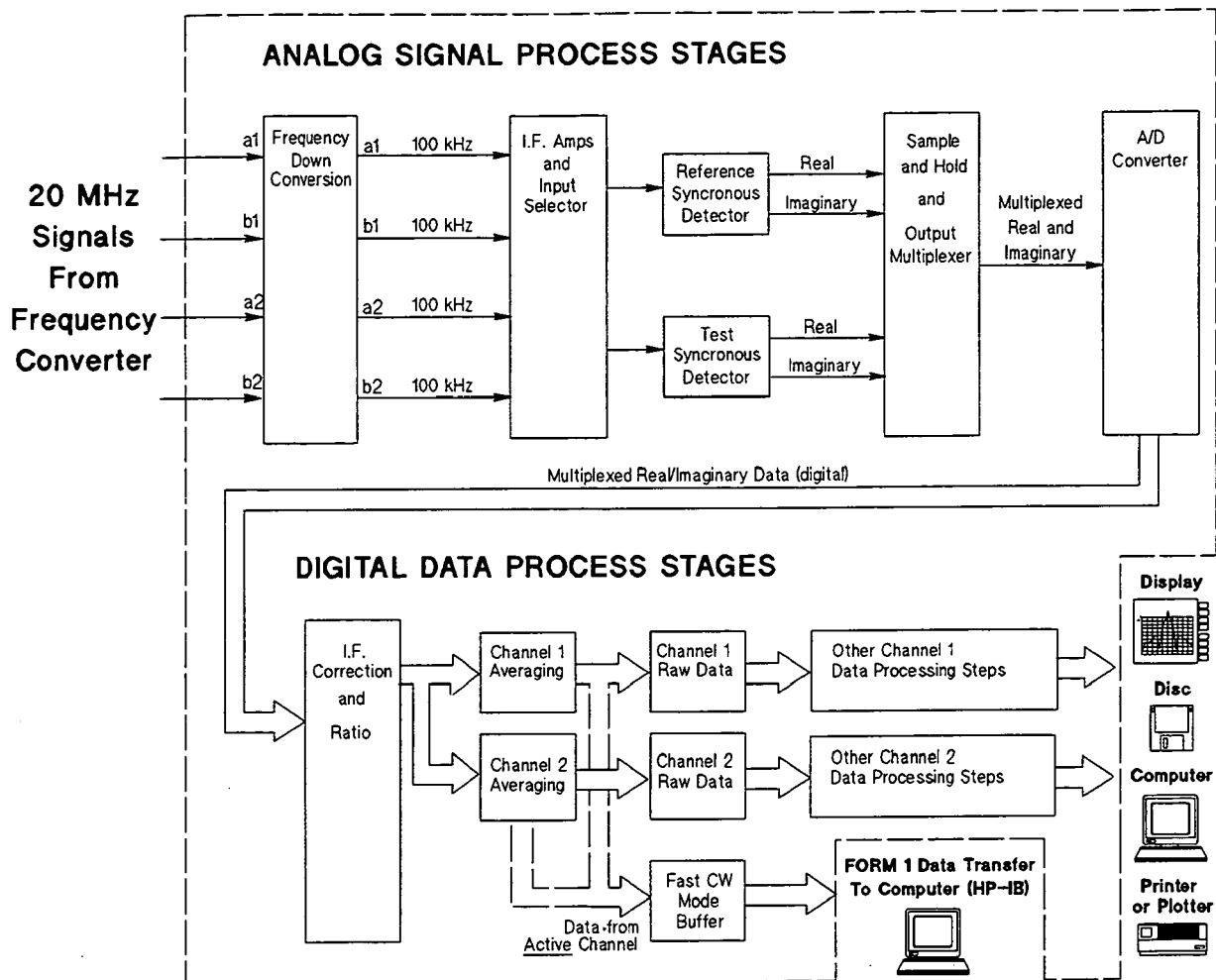

Figure 1-5. HP 8530A Measurement Data Flow Diagram

Analog: In the first main section, analog circuitry detects the real (x) and imaginary (y) values of the input signals. The real, imaginary values are then converted into digital values.

Digital: In the second main section, the microprocessor takes the digital data and performs any desired data processing (averaging, calibration, time domain, and so on). The instrument then displays the results in any format you choose. You can then output the results to printer, plotter, disc, or external computer. There are two identical digital processing paths, called Channel 1 and Channel 2. You can have different features turned ON in the two channels, and view the different results. You can show the results of both channels on the screen at the same time.

Analog Signal Process Stages

During a typical Frequency Domain measurement, the test signal source is swept from a lower to a higher frequency.

During a typical Angle Domain measurement, a single frequency can be measured while the antenna-under-test is moved around one axis.

Initially, the HP 8530A receives up to four 20 MHz signals from the external frequency converter. The receiver separately down converts each signal to a 100 kHz IF carrier frequency that can be used by the detection circuitry. Because frequency conversions are phase coherent, and the IF signal paths are carefully matched, magnitude and phase relationships between the input signals are maintained throughout the frequency conversion and detection stages. Automatic, fully-calibrated autoranging IF gain stages maintain the IF signal at optimum levels for detection over a wide dynamic range.

Each measurement channel can use input a1 or a2 as the reference signal. The selected input is also used as the phase-lock reference.

Note



In hardware gating applications, the pulsed reference signal may not be suitable for phase locking. In this case, you can use the other reference input for phase locking. For example, assume your pulsed reference is on input a1, you can use a2 as the phase lock reference. To accomplish this, press RESPONSE **(MENU)** **REDEFINE PARAMETERS** **PHASE LOCK** **a2**.

Any of the three remaining inputs can be used as test inputs.

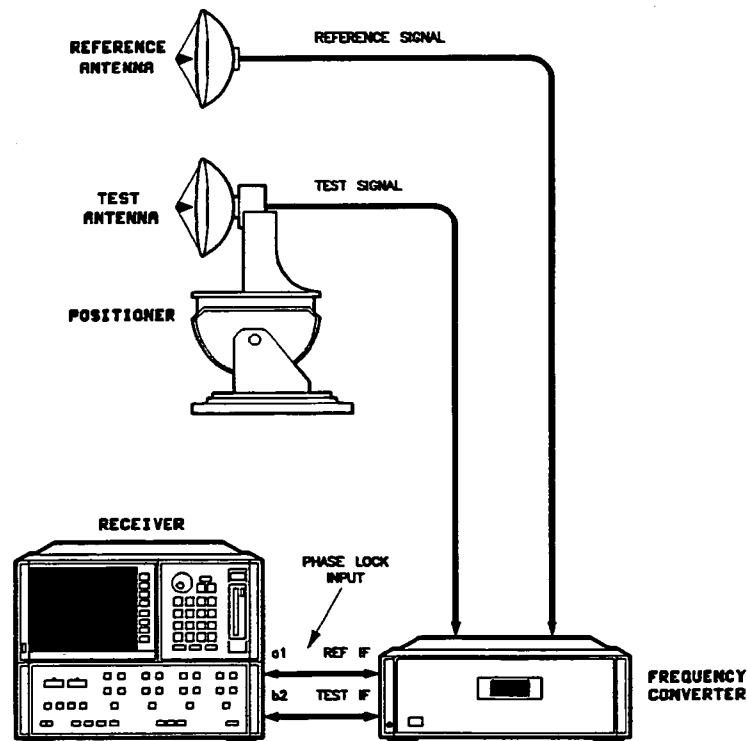

Figure 1-6. Phase Lock Reference

The input selector sends one test signal and one reference signal to the synchronous detectors. When these are measured the input selector sends the other test/reference signals.

The synchronous detectors develop the real (x) and imaginary (y) parts of the test or reference signal by comparing the input to an internally-generated 100 kHz sine wave. This method practically eliminates drift, offsets, and circularity errors as sources of measurement uncertainty. Each x,y pair is sequentially converted to digital values which are sent to the main microprocessor.

Digital Data Process Stages

Digital signal processing proceeds under the control of the receiver's firmware operating system executed by the main microprocessor.

About the Main Microprocessor

The main microprocessor is a 32-bit Motorola 68020 microprocessor running at a clock speed of 16 MHz. The firmware operating system takes advantage of multi-tasking software architecture and several distributed processors to provide very fast data acquisition and display update speed.

Raw Data Stages

The microprocessor accepts the digitized real and imaginary data, and corrects IF gain and quadrature errors before any other data processing is done. The calibration coefficients used in the IF correction stage are calculated periodically with an automatic self-calibration. This automatic feature is different from the user calibration features, and cannot be controlled in any way by the user.

Next, the inputs are ratioed together and identical copies of the data are sent to independent Channel 1 and Channel 2 data processing paths.

Now, any selected averaging is performed on Channel 1 or Channel 2. If the Fast CW mode is in use, data is sent to the Fast CW buffer from the *active channel*. If Fast CW mode is not being used, Channel 1 averaged data is stored in the Channel 1 raw data array. Similarly, Channel 2 averaged data is stored in the Channel 2 raw data array.

Data "arrays" are data holding locations. A data array holds one X,Y data pair in a special compressed data format called "Form 1." This format is described in the *HP 8530A Keyword Dictionary*. The Fast CW buffer can send data to computer if you are using the Fast CW mode. The buffer contains up to 100,000 X,Y data pairs in Form 1 format.

Other Digital Processing Stages

Channel 1 and 2 data processing proceeds independently through subsequent data processing steps. Different measurement features can be used in each channel, causing the measurement results to be processed and shown in different ways. These features are the "Other Data Processing" steps shown in Figure 1-5, and include calibration, Time Domain, display format, and so on. For example, you can select Time Domain in Channel 2, and select Frequency Domain in Channel 1. This allows you to make two different types of measurements on the same device, and display the results simultaneously.

More information on the "other" data processing steps is provided in "Standard Automated Operation," later in this guide.

Front Panel Overview

Front Panel Overview

This section describes the receiver's display and the purpose of the major control blocks. Note that you can press any key, at any time, and in any sequence without fear of damaging the system.

Display

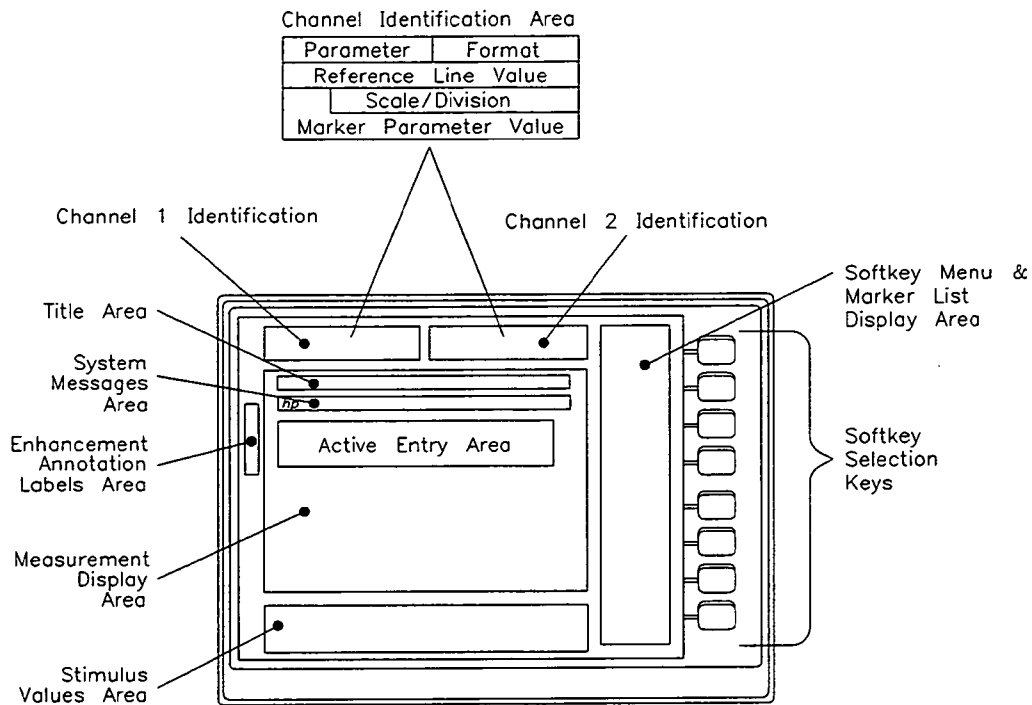
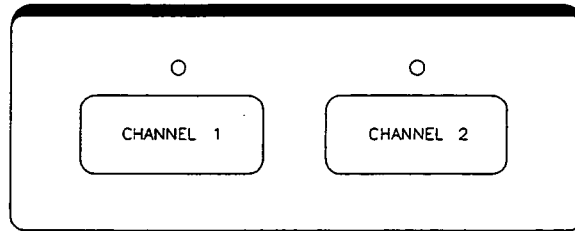

Figure 1-7.

The display shows measurement results and softkey menus. It also shows you the current measurement settings. Various types of screen messages always show up in the same areas on the display. Figure 1-7 shows the areas in which specific types of messages appear.

As you read this section press the described keys on the HP 8530A.

Channel Selection



The receiver has two separate, identical measurement channels. The channel feature is much like having two HP 8530 receivers setting next to one another.

Channel 1 and 2 can have different PARAMETER, FORMAT, or RESPONSE settings, in addition, you can select Time Domain on one channel, and Frequency Domain on the other: *For example, you could set Channel 1 to Frequency Domain, PARAM 1. Then you could set Channel 2 to Time Domain, PARAM 2.* The receiver will measure each channel and display the data. You can view the data separately (by changing channel), or you can display both sets of data side-by-side (dual channel split) or superimposed (dual channel overlay).

Many “stimulus” settings (such as RF power; start, stop, increment angle; start, stop, or CW frequency, number of points, and so on) are “coupled.” If a stimulus feature is “coupled,” you cannot choose different settings for Channel 1 versus Channel 2. If a stimulus feature is “uncoupled,” you can choose different settings in the two channels. If you want to know whether a specific feature is coupled or uncoupled, look it up in the keyword dictionary.

Basic Measurement Functions

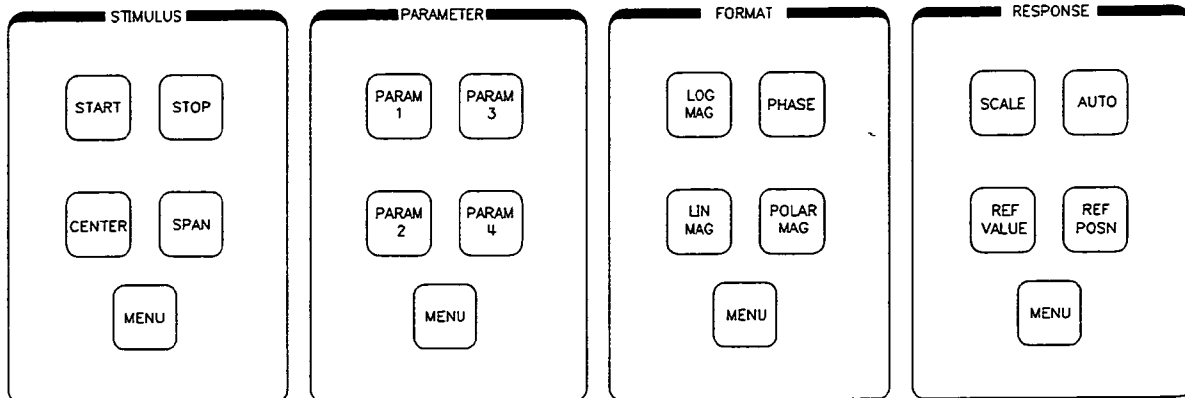

Four of the main control blocks on the front panel are STIMULUS, PARAMETER, FORMAT, and RESPONSE. These are described below:

STIMULUS This block lets you select RF power levels, and desired frequency and angle settings. It also controls how you can trigger the instrument to take each point of data. For example, you can trigger off the Record Increment pulses (coming into the receiver's EVENT TRIGGER jack from the positioner controller) by selecting EXTERNAL trigger. Alternatively, you can trigger over HP-IB using the GET command.

PARAMETER The PARAMETER block contains the predefined input ratio keys **PARAM 1** (b1/a1), **PARAM 2** (b1/a2), **PARAM 3** (b2/a1), and **PARAM 4** (b1/a1). The normal measurement mode for the receiver is to mathematically ratio (divide) the data from the test and reference antennas. Ratioed measurements reduce most errors caused by the range, and shows the actual performance of the Antenna Under Test. You can redefine any of the parameter keys to ratio any two inputs you desire. You can also look at any single input using the **SERVICE 1 a1** through **SERVICE 4 b1** softkeys.

FORMAT Format keys let you choose how the data is displayed on the screen. You can select logarithmic magnitude (**LOG MAG**), linear magnitude (**LIN MAG**), phase (**PHASE**), polar logarithmic magnitude (**POLAR MAG**), and polar linear magnitude (**LINEAR ON POLAR**), located under the **FORMAT MENU** key)

RESPONSE The response block keys let you to set the display scale and reference line. Functions under the **MENU** key let you turn on averaging and normalization. (Normalization allows you to set the peak of the main lobe to 0 dBi and measure other parts of the trace relative to the peak.)

Each major control block has functions that are not mentioned here. Refer to Chapter 6, 7, 8, and 9 in the *HP 8530A Operating and Programming Manual* for descriptions of these features. Many features are described in this User's Guide.

ENTRY Block

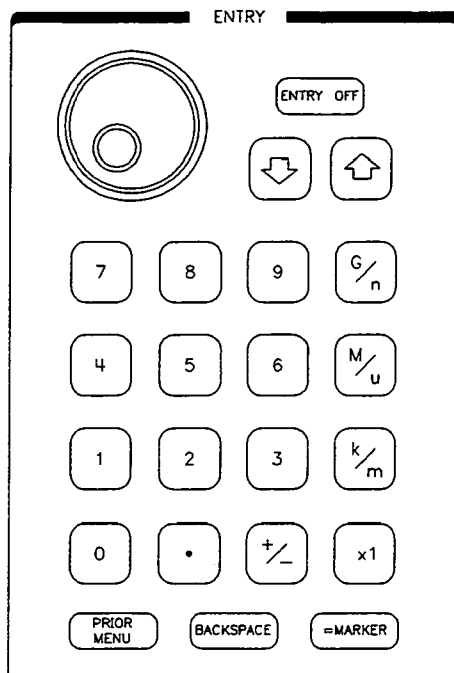

In some cases it is necessary to supply numeric values for a specific function, such as angle or frequency. The 10 digit keypad is used to supply these values. The keys to the right of the digits terminate the value with the appropriate units. Use G/n (Giga/nano), M/u (Mega/micro), k/m (kilo/milli) and x1 (basic units: dB, dBm, degrees, seconds, Hz) as applicable. In addition to entering data with the keypad, the knob can be used to make continuous adjustments, while the \blacktriangle and \blacktriangledown keys allow values to be changed in steps.

Changing Values Using the Numeric Keypad

To change a value using the numeric keypad:

1. Select the function (start angle, frequency, or any other function that requires a value). This function becomes the "active function."
2. Enter the new value using numeric, decimal, and the +/- toggle. +/- changes the sign of the number. If you make a mistake, press the BACKSPACE key. (If you have already pressed a terminator key, you must re-enter the entire value).
3. Terminate the entry with the appropriate units.

Front Panel Overview

Table 1-1. Numeric Value Terminator Key Usage

Key Name	Angle	Frequency	Power	Power Slope	Time
G/n	-	GHz	-	-	ns
M/ μ	-	MHz	-	-	μ s
k/m	milli degrees	kHz	-	-	ms
x1 ¹	degrees	Hz	dBm	dB/GHz	s

1 (x1) always represents single units.

Other Keys in the Entry Block

(PRIOR MENU) takes you to the previous softkey menu.

(=MARKER) can be useful when you are using markers. The easiest way to explain what (=MARKER) does is by example. Assume you are making a frequency response measurement, and the last marker you moved (the active marker) is sitting at 11 GHz. Now assume you want to change the start frequency to 11 GHz. All you need to do is press (START) (=MARKER). The marker position (11 GHz) will become the start frequency.

You could have set the stop frequency to 11 GHz by pressing (STOP) (=MARKER).

Another way to use (=MARKER) is to transfer the marker *value* to another function. As an example, assume you want to set the display reference line to the value of the active marker (for example, assume the marker value is -13.2 dB). Press (REF VALUE) (=MARKER), and the display reference line will change to the value of the active marker.

(ENTRY OFF) removes old error messages or active function text from the screen. "Active function text" are messages like START -90° that appear when you changed the value of a function.

MENUS Block

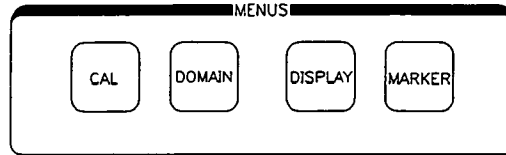

The four keys under MENUS are **CAL**, **DOMAIN**, **DISPLAY**, and **MARKER**:

CAL Softkeys under **CAL** allow you to perform an antenna, radar cross section (RCS) or limited network analyzer calibration.

DOMAIN The HP 8530 has three modes of operation, called domains. These are the Frequency, Angle, and optional Time Domain.

DISPLAY Softkeys under **DISPLAY**:

- Place one, two, or four parameter measurements on the screen at once.
- Saves the data trace to temporary storage memory.
- Displays memory traces.
- Performs trace math functions on memory traces.
- Allows you to change display intensity or colors.
- Allows you to choose video settings for an external monitor.

MARKER Softkeys under **MARKER** allow you to activate up to five markers. Each marker shows amplitude or phase values for a desired point on the measurement trace. Marker Functions are:

- Simple markers on the display trace.
- Δ marker mode.
- Marker search modes.
- Marker list modes.

INSTRUMENT STATE Block

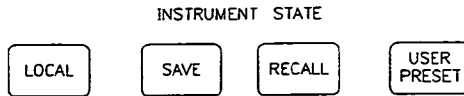

The four keys in the INSTRUMENT STATE block are **LOCAL**, **SAVE**, **RECALL**, and **USER PRESET**.

The **LOCAL** key has two uses:

- If you are controlling the receiver with a computer, the front panel keys will not respond to touch. Pressing **LOCAL** returns control to you.
- **LOCAL** also allows you to examine or change HP-IB addresses the receiver uses to control peripherals and other instruments.

SAVE and **RECALL** allow you to save and recall up to eight different measurement setups ("instrument states"). You can also save your current setup as the "USER PRESET" state by saving it to register 8. The receiver will return to that state whenever the instrument is turned on, or if you press **USER PRESET**.

A **state** is defined as the condition of all current measurement settings, including all domain, stimulus, parameter, format, and response settings.

AUXILIARY MENUS Block

AUXILIARY MENUS

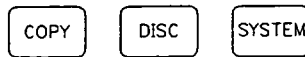

The "AUXILIARY MENUS" contain the **COPY**, **DISC**, and **SYSTEM** keys.

COPY controls hardcopy output, either printing or plotting.

DISC controls saving, loading, viewing, or deleting disc files. You can also format floppy discs, or select an external disc drive.

SYSTEM menus control internal functions of the HP 8530. For example, you can select normal or wide IF bandwidth, or control phase locking.

If using remote mixers, you can control the RF-to-LO frequency ratio (to select the desired harmonic mode) using the Multiple-Source menu.

Automatic Recall of Instrument Settings

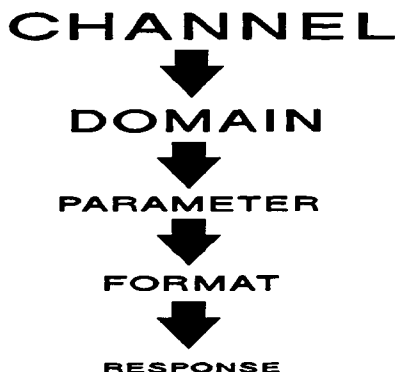

The receiver *automatically* remembers most measurement settings. When you switch back and forth between channels, domains, parameters, or display formats, the receiver automatically remembers all the lower-level settings you used last. (This feature remembers all measurement settings *except* stimulus settings.) This feature is automatic, and does not require you to use the Save or Recall functions. This ability to remember previous settings is called “limited instrument state memory.”

This feature works by assigning a hierarchy to the instrument settings. Here is the hierarchy:

- Channel (1 or 2)
- Domain (Frequency, Angle, or Time)
- Parameter (1, 2, 3, or 4)
- Format (any display format)
- Response (scale and reference line)

Every mode in the above list *remembers* all settings you make that are lower in the hierarchy. For example, assume you choose the following measurement settings.

Channel 1
Angle Domain
Parameter 3
Log mag (format)
Reference -10 dB
Scale 5 dB/div

Now you go to Channel 2 and make completely different settings.

When you reactivate Channel 1, the settings shown above will automatically resume. This hierarchical memory applies to all the controls in the above list.

The Added Benefit of the SAVE/RECALL feature

Stimulus settings are not part of the hierarchical memory explained above. To save stimulus settings along with all the other settings, you must use the SAVE/RECALL feature. Another advantage is that saved instrument states can be stored to disc.

Typical Softkey Menu Structure

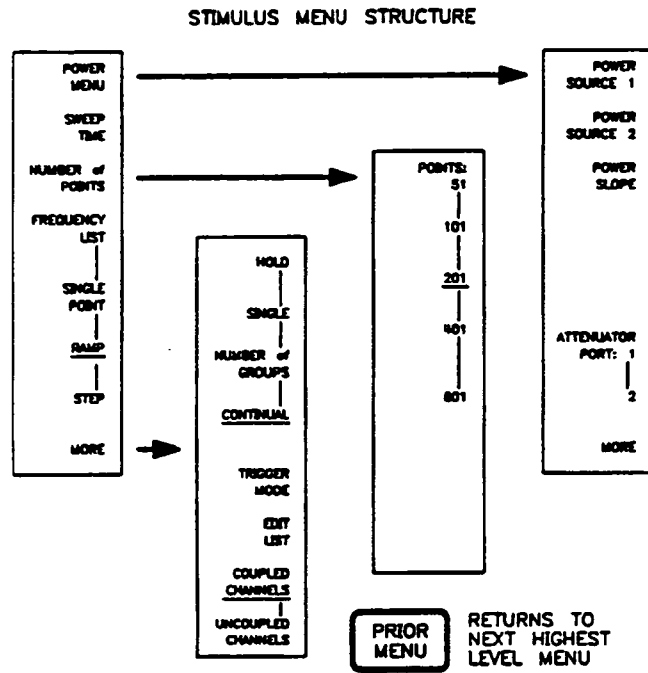

Each of the function blocks contain a **MENU** key that presents softkey menus on the screen. Each menu contains up to eight selections, each corresponding to one of the unlabeled keys on the side of the display. Press the softkey to the right of the function you want to select. Every softkey, when pressed, either activates the function, or presents the next level of menu choices.

Manual Measurement Examples

This chapter gives basic examples of antenna and RCS measurements. The intent is to show you the overall steps involved in making a measurement, but not to go into great depth on measurement choices. This chapter also explains simple (but very useful) tasks such as using markers, finding depth of a null, determining beam width, and displaying more than one parameter.

After you become familiar with the concepts presented in this chapter, you can read Chapter 4 to learn more advanced measurement skills.

Chapter Contents

- Definitions of Important Terms
- Antenna Measurements
 - Angle scan measurements
 - Frequency response measurements
- RCS Measurements
 - Frequency response measurements
 - Time domain measurements
 - CW Angle Scan

Definitions of Important Terms

It is important that you understand the definition of the following terms *as they relate to the HP 8530A*.

- Channel** The receiver has two separate, identical measurement **channels**. The channel feature is like having two HP 8530 receivers setting next to one another. When the receiver measures raw data, it makes two identical copies. Each copy is sent through parallel (identical) data processing paths. Such features as calibration, Time Domain, display formatting, and trace math can be performed on one or both paths. Each of the two channels correspond to one of the data processing paths (refer to Figure 1-5). When you press the **CHANNEL 1** or **CHANNEL 2** key, you make that channel the "active channel." Any subsequent changes you make to measurement settings will affect that channel.
- Input** Refers to the four HP 8530A signal inputs (a1, a2, b1, and b2). The term "input" is also used when referring to the signal inputs of the frequency converter (HP 8511A/B, 85310A, or other.)
- Ratio** Most often, users want to divide the measured signal of the *test* input by the signal of the *reference* input. This is called a **ratio**, or ratioed, measurement. (For example, selecting b1/a1 would divide the test signal at b1 by the reference signal at a1.) A ratioed measurement provides common-mode rejection of errors caused by the transmitter, transmit antenna, or drift.
- Parameter** The parameter is the input, or input ratio, that you have selected for a measurement. The front panel keys **PARAM 1**, **PARAM 2**, **PARAM 3**, and **PARAM 4** are set at the factory to select different input ratios (b1/a1, b2/a1, and so on). For example, **PARAM 1** divides (ratios) input b1 by a1. You can redefine the PARAM keys so they ratio any two inputs you desire. To view a single input, use the **SERVICE 1 a1**, **SERVICE 2 b2**, **SERVICE 3 a2**, **SERVICE 4 b1** softkeys, located under PARAMETER **MENU** **SERVICE PARAMETERS**.

Antenna Measurements

The first part of this chapter describes the two supported types of antenna measurements:

- Angle Scan** The HP 8530A can make single-axis angle scan measurements at a single frequency. You can measure a single angle, or an angle sweep.
- Frequency Response** This is a measurement at a single angle over a range of frequencies. When selecting frequencies, you can:
- Specify a list of specific frequencies.
 - Select the start and stop frequencies, and the number of points. The receiver will pick the individual frequency points in-between.
 - Select a frequency center point, a frequency *span*, and the number of points. The receiver will pick the individual frequency points throughout the span. This method is useful when you want to look closely at a smaller portion of the frequency band.
- In frequency measurements, triggering should usually be set to internal triggering.

Note



When this manual instructs you to press one of the four **(MENU)** keys, it will give the name of the functional block first. For example, **STIMULUS (MENU)** refers to the **(MENU)** key located in the **STIMULUS** functional block.

Softkeys are shown **LIKE THIS**.

Angle Scan Measurements

This tutorial will show you how to make a typical angle scan (pattern) measurement.

Notes Regarding Angle Scan Measurements

The HP 8530 does not send commands to the positioner controller. You must set the start, stop, and increment angles on the positioner controller directly. The only exception to this is if your positioner controller is completely manual. To make the measurement, use the positioner controls to rotate the antenna.

What Triggers Measurements at Each Angle?

On systems NOT equipped with the HP 85370A Position Encoder: The receiver, using External Trigger, measures one data point every time a Record Increment trigger is sent by the positioner controller. The receiver uses the Record Increment trigger to:

- Know when the antenna is at an angle where a data point is to be taken.
- Keep track of how many angular data points have been measured, and thus, when the measurement is finished.

On systems that ARE equipped with the HP 85370A Position Encoder: The HP 85370A Position Encoder automatically knows the selected increment angle. It causes the receiver to trigger each time the positioner reaches an increment angle (an angle where a data point is to be taken). Receivers that use the position encoder use internal triggering. More on this subject is explained in "External Triggering" in Chapter 4.

Example Measurement

The example measurement will use the following settings:

Display:	Single
Measured Parameter:	Param 1 (b1/a1)
Start Angle:	-90°
Stop Angle:	+90°
Increment Angle:	1°
Frequency:	10 GHz (X-band)

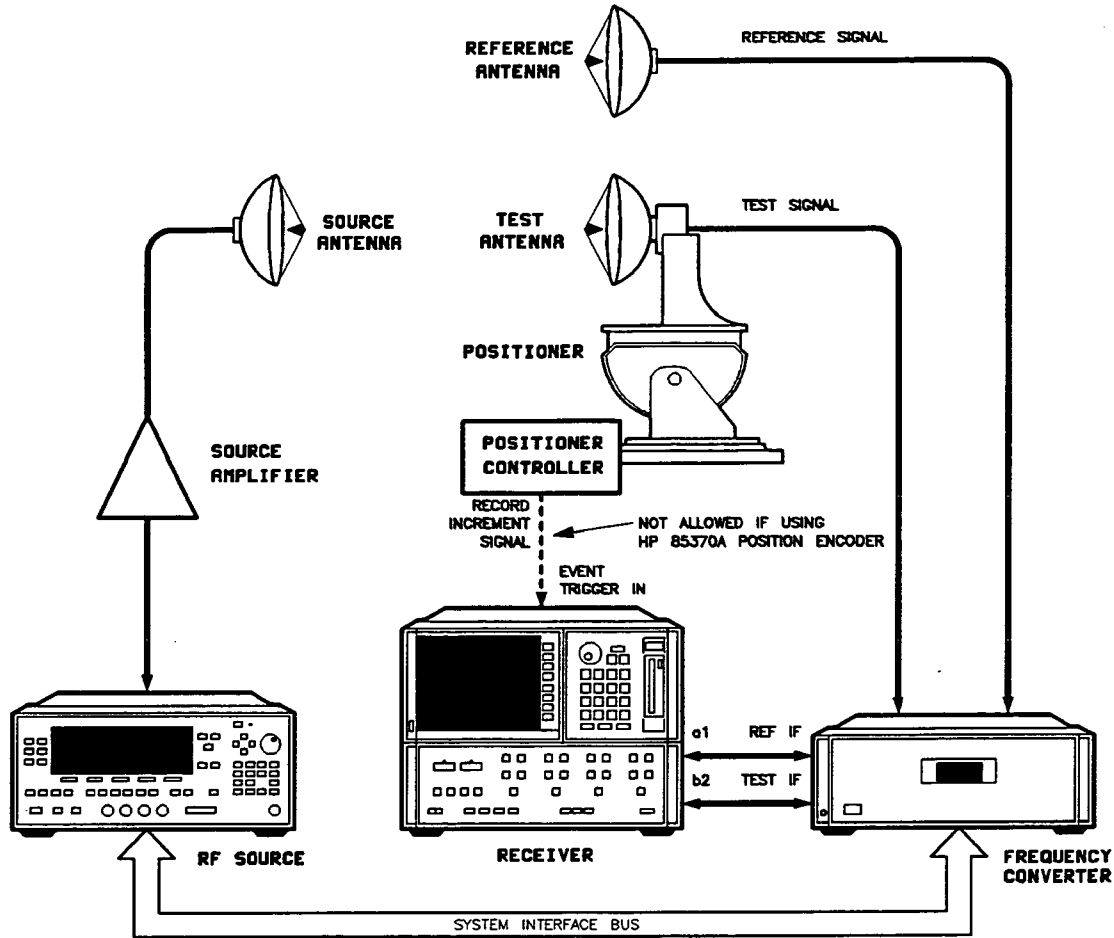

Figure 2-1. Typical Antenna Measurement Setup

Typical Test Setup

Figure 2-1 shows a typical antenna measurement setup.

You must not connect a signal to the Event Trigger BNC if your system uses the HP 85370A Position Encoder. Connections to Event Trigger could cause false triggers to the Position Encoder.

Calibrate

If you want to make calibrated gain measurements, or reduce crosstalk errors, refer to Chapter 3.

Make Measurement Settings

1. Press **RECALL** **MORE** **FACTORY PRESET**.
2. Select angle measurements by pressing **DOMAIN** **ANGLE**.
3. Determine an appropriate RF power level for your setup. Change RF power by pressing **STIMULUS** **MENU** **POWER MENU**, **POWER SOURCE 1**. Then enter the desired value using the entry keys, for example **[-]** **[1]** **[0]** **[x1]** would select -10 dBm.

Angle Scan Measurements

4. Select angle and frequency settings by pressing the following keys:

START -90 **x1**

STOP 90 **x1**

STIMULUS **MENU**, **INCREMENT ANGLE** 1 **x1**

FREQUENCY of MEAS. 10 **G/n**

PARAM 1

5. Set the receiver for the correct triggering mode:

Press: **MORE TRIGGER MODE**

a. If your system *is* equipped with the HP 85370A Position Encoder, press **TRIG SRC: INTERNAL**.

b. If your system *is not* equipped with the HP 85370A Position Encoder, and gets its record increment triggering directly front the positioner controller, press **EXTERNAL**.

6. Press **PRIOR MENU** **CONTINUAL**.

7. Perform the following sub-steps *only* if you have the HP 85370A Position Encoder:

a. Press **PRIOR MENU** **ENCODER FUNCTIONS** **AXIS A** **MORE**.

b. If Axis A on your positioner uses a single synchro, press: **SYNCHRO SINGLE**

c. If Axis A on your positioner uses a dual synchro, press: **DUAL**

d. If you prefer $\pm 180^\circ$ display, press: **+/-180**

e. If you prefer 0 to 360° display, press: **ANG POL 0 to 360**

8. On the positioner controller:

a. Select manual (local) operation.

b. Some positioner controllers can be "manually programmed" from the front panel for a semi-automatic measurement. Such units may require you to enter a start, stop, and increment angle. If you have a controller of this type, enter start, stop, and increment angle values now. Use the same values you entered into the receiver. Refer to the instruction manual for the positioner controller if necessary. If you use a completely-manual positioner controller skip this step.

c. Set the positioner controller to Axis A.

Note



Some positioner controllers express angles from 0 to 360 degrees, rather than -180 to $+180$ degrees. If you have a 0 to 360 degree controller, set the positioner to the *equivalent* start angle. For example, to get -90° you would set the positioner to 270° . This is not a problem if you have the HP 85370A Position Encoder.

Choose Display Format

The next step is to choose the way you want data to be displayed. The keys and softkeys in the FORMAT block control the display format. Choose one of the following:

LOG MAG	displays logarithmic magnitude in Cartesian format.
LIN MAG	displays linear magnitude in Cartesian format.
PHASE	displays phase in Cartesian format.
POLAR MAG	displays logarithmic magnitude versus angle.
FORMAT MENU LINEAR on POLAR	displays linear magnitude versus angle.

Note that in Angle Domain, 0 degrees is at the top of the display in polar formats. Refer to **POLAR MAG** and **LINEAR** on **POLAR** in the *HP 8530A Keyword Dictionary* for details.

Choose Display Scale and Reference Line Settings

One step 40 dB or 60 dB patterns

You can set the display up for 40 dB or 60 dB patterns in one step:

Press **RESPONSE** **MENU** **40 dB PATTERN** or **60 dB PATTERN**.

Individual scale and reference controls

SCALE sets the vertical graticule scale in dB/division. When making a measurement for the first time, you should estimate (roughly) the maximum and minimum power levels. Then you can choose values for display scale. After the measurement is done you can readjust display scale to suit the actual data.

Press **SCALE** **4** **x1**. This selects 4 dB/division, which provides 40 dB from the top of the display to the bottom.

The display has a reference line. This line represents a specific power level, which you can specify. Change the value of the reference line to -10 dB as follows:

Press **REF VALUE** **-10** **x1**.

If you had pressed **40 dB PATTERN** or **60 dB PATTERN**, the reference line is now at the top of the display. You can place the reference line anywhere you wish by pressing:

REF POSN n **x1**, where n is a number from 0 (bottom of the display) to 10 (top).

Angle Scan Measurements

Measure the Antenna

To measure the antenna under test:

1. Press MEASUREMENT **RESTART**. This step ensures that the measurement starts at the beginning of the angle scan. Press this key before making every angle scan measurement.

Hint



This note applies to systems that are NOT equipped with the HP 85370A Position Encoder.

Sometimes positioner controllers “skip” a trigger pulse during the measurement. If this happens, the measurement will stop near the end of the scan, waiting for the final trigger pulse (or pulses). If you try to make another angle scan, the receiver will measure the “missing” points and then stop taking data. MEASUREMENT **RESTART** forces the receiver to abandon the previous measurement, and starts the next scan properly (at the start angle). This is never a problem if you are using the HP 85370A Position Encoder.

2. Using the positioner controller front panel controls, move the antenna to the start angle. *You should always move the positioner about 3° in front of the start angle. When the receiver displays MOVE POSITIONER ANGLE FORWARD you have gone far enough.* In this example the start angle is -90° , so move the positioner to about -93° .
3. Move the antenna from -90° to $+90^\circ$. The receiver will measure the antenna pattern as the positioner turns.

Results for an example antenna are shown below:

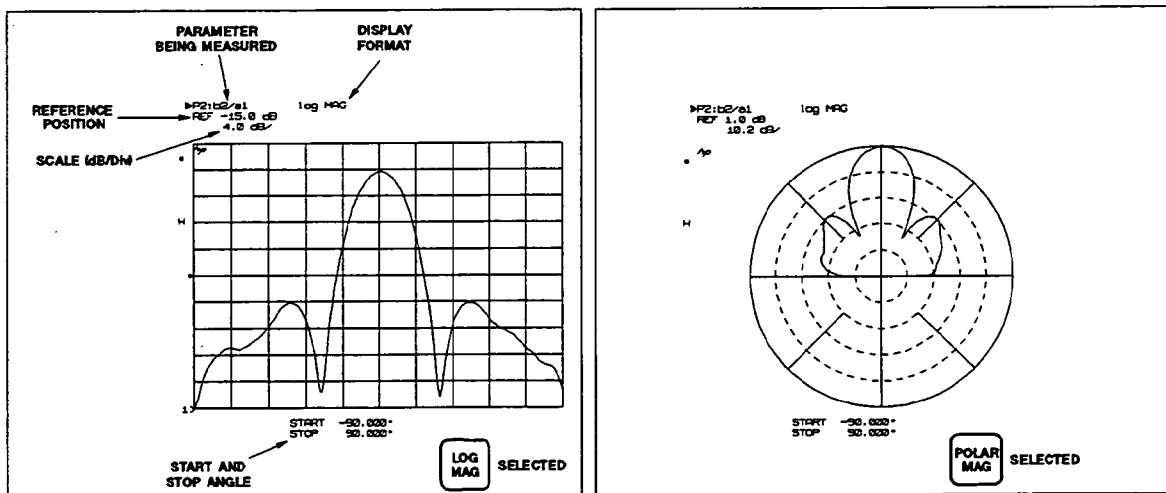

Figure 2-2. Example Antenna Measurement Results

Aborting a Measurement

The MEASUREMENT **RESTART** key tells the receiver to abort the current measurement and start over. When you are in Frequency Domain you can press this key whenever you want. However, you should be careful when pressing this key in the ANGLE domain. Always follow this procedure:

1. Stop the positioner controller and prepare it for a new scan. *Move it back to the start angle.*
2. Press **RESTART**. This will abort the current measurement and return the HP 8530A to the start of the next scan.

Frequency Response Measurements

Frequency Response Measurements (at a Fixed Angle)

This tutorial will show you how to make a typical frequency response measurement. The example measurement will use the following settings:

Measured Parameter:	Param 1 (b1/a1)
Start Frequency:	8.2 GHz
Stop Frequency:	12.4 GHz
Number of Frequency Points:	201
Angle:	0°

Calibrate

If you want to make calibrated gain measurements, or reduce crosstalk errors, refer to Chapter 3.

Choose Measurement Settings

1. Select Frequency Domain measurements: Press **DOMAIN** **FREQUENCY**.
2. Set the frequency sweep to Step mode: Press **STIMULUS** **MENU** **STEP**.
NOTE: Ramp mode is faster than step, but requires two BNC cable interconnections between the RF source and receiver. This is not possible in many ranges. Step mode has better frequency-accuracy than Ramp mode, because Step mode phase locks at each frequency point. Refer to the Ramp Sweep description in Chapter 4 for more information.
3. Press **MORE** **CONTINUAL**.
4. If your system has an HP 8511 and a compatible HP 836xx source, you can use Quick Step phase locking mode to speed up Step measurements. Refer to the list of compatible HP 836xx sources in "Fast measurement speed and Quick Step mode" in Appendix B.

If your RF source is compatible, turn Quick Step mode ON by pressing:

SYSTEM **MORE** **SYSTEM PHASELOCK** **STEP TYPE: QUICK**

5. Make sure triggering is set to internal by pressing:
STIMULUS **MENU** **MORE** **TRIGGER MODE** **TRIG SRC INTERNAL**
With internal triggering turned ON, the receiver will not wait for outside trigger pulses before measuring data points. Instead, it will measure each point at the fastest possible speed.
6. Select number of points and frequency settings by pressing the following keys:

START 8.2 **G/n**

STOP 12.4 **G/n**

STIMULUS **MENU** **NUMBER of POINTS** **201**

Note



When you select different frequency values for your measurement, HP 836xx RF sources use the first sweep to accurately phase lock the RF frequencies. If your application demands high measurement speed, use subsequent sweeps for the actual measurement.

7. Select the parameter you want to view, for example, press **PARAM 1**.

2-10 Manual Measurement Examples

- Determine an appropriate RF power level for your setup.

To change RF power, press:

STIMULUS **MENU** **POWER MENU**, **POWER SOURCE 1**. Then enter the desired value.

- Set the positioner controller so the antenna is at the desired angle.

Choose Display and Reference Settings

Choose a data presentation format, scale, and reference value/position as explained in “Angle Scan Measurements”. The two polar display keys, **POLAR MAG** and **LINEAR on POLAR**, operate differently in Frequency Domain than they do in Angle Domain. Refer to **POLAR MAG** and **LINEAR on POLAR** in the *HP 8530A Keyword Dictionary* for details.

Choose Sweep Type

The receiver will already be measuring data. By default, the receiver will measure the frequency band repeatedly. You can save data to a disc at any time, refer to Chapter 6 for instructions.

If you want to measure one sweep at a time:

Press STIMULUS **MENU** **MORE** **SINGLE**. The receiver will take one sweep, then stop. The receiver will underline the **HOLD** softkey when the measurement is finished. This means the receiver is in Hold mode, and is not making measurements. The letter H will appear on the left-hand side of the display when the receiver is in Hold mode.

Choosing the Best Sweep Mode for Your Measurements

The different sweep modes under STIMULUS **MENU** are:

- Single Point mode
- Ramp Sweep mode
- Step Sweep mode
- Frequency List mode

These modes are explained in “Frequency Domain Measurement Tutorial” in Chapter 4.

Choosing Single or Continual Measurements

You can also choose between single or continual measurements, using STIMULUS **MENU** **MORE**: **SINGLE** or **CONTINUAL**.

SINGLE makes a single measurement. When the measurement is done the receiver switches to Hold mode, and the letter H appears on the display.

CONTINUAL repeats the measurement continuously.

Radar Cross Section Measurements

This section describes how to make manual Radar Cross Section (RCS) measurements. The HP 8530A can be used to perform these basic RCS measurements directly, using only the front panel controls:

- | | |
|-------------------------|--|
| Frequency Domain | This measurement domain will determine the reflection from a stationary target versus frequency. You can measure the reflection over a frequency sweep, at a CW frequency, or a specific list of frequencies. |
| Time Domain | Time domain (optional) can be used to measure the reflections of the target over time, giving the down range RCS response. The HP 8530A will first measure in the Frequency Domain and then compute the Time Domain response using an inverse Fourier Transform. |
| Software Gating | Time domain gating can be used to remove unwanted RCS responses in both time and Frequency Domain RCS measurements. The gating function can "filter out" various RCS error signals such as feed coupling, monostatic antenna return loss, chamber reflections and range clutter. |
| Angular CW Measurements | An angle domain measurement can be made showing RCS of a target versus rotation angle at a CW frequency. This is done by using a positioner system to move the target and trigger the receiver at each measurement angle. This measurement is similar in concept, and hardware set up, to an angle domain measurement of an antenna radiation pattern except the positioner moves the target, rather than the receive antenna. |

Since the Time Domain response is calculated from the Frequency Domain measurement, the following tutorial starts with a Frequency Domain RCS measurement. Each of the following tutorials builds upon the previous example.

The following procedures also assume that you have read and become familiar with the antenna measurement section earlier in this chapter.

In this section we will use some of the skills and procedures discussed earlier.

Frequency Domain Measurements

The following tutorial will show you how to make a typical Frequency Domain RCS measurement. The example measurement will use the following settings:

Measurement Parameter: Param 1 (b1/a1)
 Start Frequency: 8.2 GHz
 Stop Frequency: 12.4 GHz
 Number of Frequency Points: 801
 Target Angle: 0°

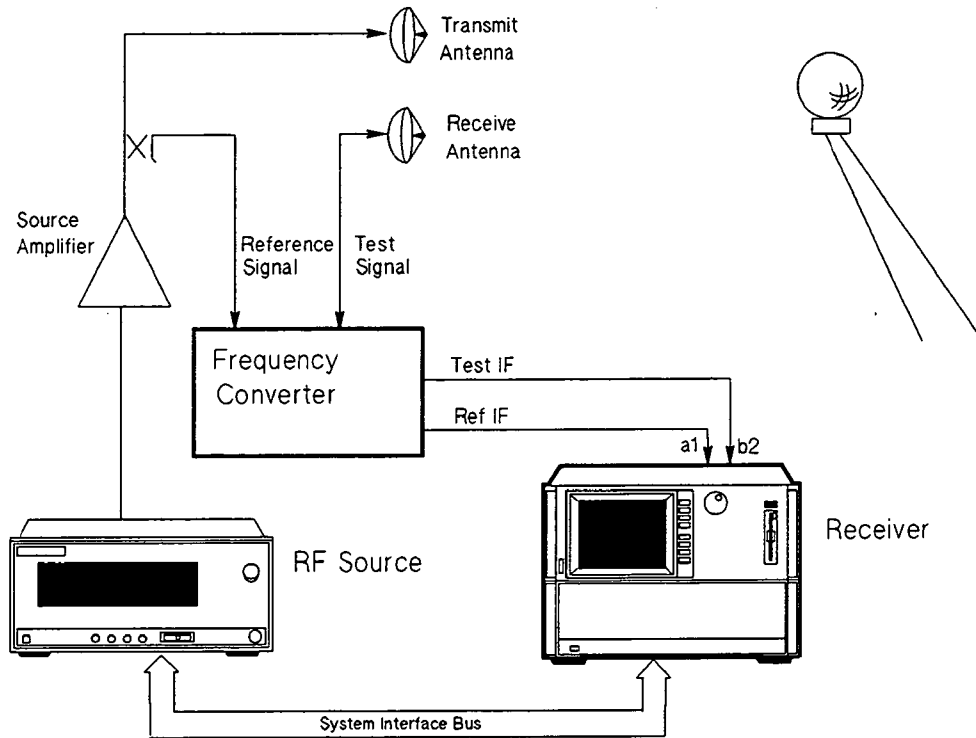

Figure 2-3. Typical RCS Measurement Setup

Typical Test Setup

Figure 2-3 shows a typical RCS setup. Notice that the reference signal is coupled from the RF source rather than using a reference antenna as in an antenna measurement. This is a normal configuration for a quasi-monostatic and bistatic antenna range. A dual directional coupler is used for a monostatic range.

Calibrate

Calibrate using the instructions provided in "RCS Calibration" in Chapter 3.

Manual RCS Measurements

Choose Measurement Settings

1. Select Frequency Domain measurements: Press **DOMAIN** **FREQUENCY**.
2. Set the frequency sweep to Step mode: Press **STIMULUS** **MENU** **STEP**.

The **RAMP** sweep mode may be used with some frequency converters such as the HP 8511A/B if the proper rear panel connects are made. Refer to the Ramp Sweep mode description in Chapter 4 for more information.

3. Press **MORE** **CONTINUAL**.
4. Make sure the triggering is set to internal by pressing:

STIMULUS **MENU** **MORE** **TRIGGER MODE** **TRIG SRC** **INTERNAL**

With the trigger set to internal the receiver will not wait for an external trigger signal before taking any data points. Instead, it will measure each point at the fastest possible speed.

Also make sure that the **STIMULUS** key is underlined, but the **PARAM 1**, **PARAM 2**, **PARAM 3**, and **PARAM 4** are not.

5. Select the measurement frequency range and the number of points by pressing the following keys:

START 8.2 **G/n**

STOP 12.4 **G/n**

STIMULUS **MENU** **NUMBER OF POINTS** **801**

Note



When using an HP 8360 family RF source, the first sweep after any frequency change is used to accurately phase lock the RF frequencies. If high measurement accuracy is required, use the second sweep for your measurement.

6. Select the parameter you wish to measure, press:

PARAM 1

7. Determine an appropriate RF power level for your range. Most RCS setups use the maximum available power. To change RF power: Press **STIMULUS** **MENU** **POWER MENU**, **POWER SOURCE: 1**. Then enter the desired value, or use the knob.
8. Set the target in place, at the desired positioner angle.

Choose Display Format

Choose a data presentation format, scale, and reference value/position as explained in "Angle Scan Measurements".

Measure the Target

The receiver will already be measuring RCS data. By default, the receiver will measure the frequency band repeatedly. After the target has been measured, you can stop taking data by pressing:

STIMULUS **MENU** **MORE** **HOLD**

or

You can make a single sweep measurement by pressing:

STIMULUS **MENU** **MORE** **SINGLE**

You can now remove the target or make other changes while performing other functions and data processing on the RCS measurement. An example of a Frequency Domain RCS measurement is shown in Figure 2-4.

After the measurement is finished you can save the data to disc, refer to Chapter 6 for instructions.

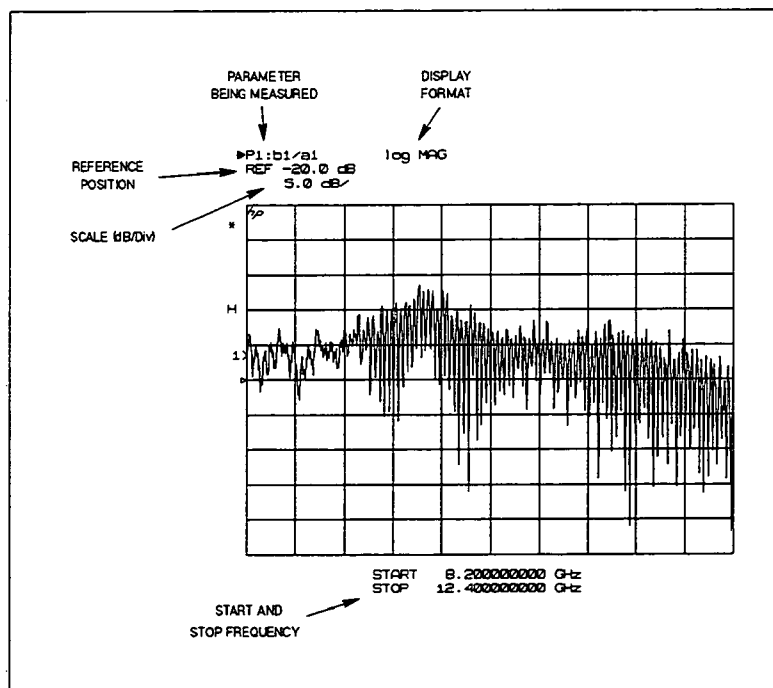

Figure 2-4. Typical RCS Frequency Domain Measurement

If you want to measure one sweep at a time:

Press STIMULUS **MENU** **MORE** **SINGLE**. The receiver will take one sweep, then stop. The receiver will underline the **HOLD** softkey when the measurement is finished. This means the receiver is in Hold mode, and is not making measurements. The letter H will appear on the left-hand side of the display when the receiver is in Hold mode.

Choose the Best Sweep Mode for Your Measurements

The different sweep modes under STIMULUS **MENU** are:

- Single Point mode
- Ramp Sweep mode

Manual RCS Measurements

- Step Sweep mode
- Frequency List mode

Refer to "Frequency Domain Measurement Tutorial" in Chapter 4 for information on these modes.

Choose Single or Continual Measurements

You can also choose between single or continual measurements, using STIMULUS **MENU** **MORE**:
SINGLE or **CONTINUAL**.

SINGLE makes a single measurement. When the measurement is done the instrument switches to Hold mode.

CONTINUAL repeats the measurement continuously.

Using Markers

Markers can be used to give detail of specific points on the trace. For example, to show the largest RCS response, press:

MARKER **MARKER 1** **MORE** **MARKER** to **MAXIMUM**

Time Domain Measurements

The previous Frequency Domain measurement can now be converted into Time Domain. Thus, the down range RCS response can be seen.

Converting to Time Domain

To convert to the Time Domain, press:

DOMAIN **TIME BAND PASS**

For detailed information on Time Domain, see the *HP 8530 Operating and Programming Manual*. This manual discusses important factors that affect a Time Domain measurement, such as: *Alias-Free Range*, *Range Resolution*, *Response Resolution*, and *Impulse Waveforms*.

Choose the Display Format

You may wish to set the display format. The most common formats for Time Domain are:

LIN MAG, **LOG MAG** or **FORMAT** **MENU** **REAL**.

Since you are now in the Time Domain, the X-axis of the data display is now showing time, rather than frequency. This means that the following keys now affect the Time Domain, and adjust or measure in time:

START
STOP
CENTER
SPAN
MARKER

As an example of an RCS measurement, the Figure 2-4 Frequency Domain measurement has been converted into a Time Domain measurement and shown in Figure 2-5.

Measure the Target

The display is now showing the measured Time Domain response. Markers can be used to find the magnitude and the location of each reflection.

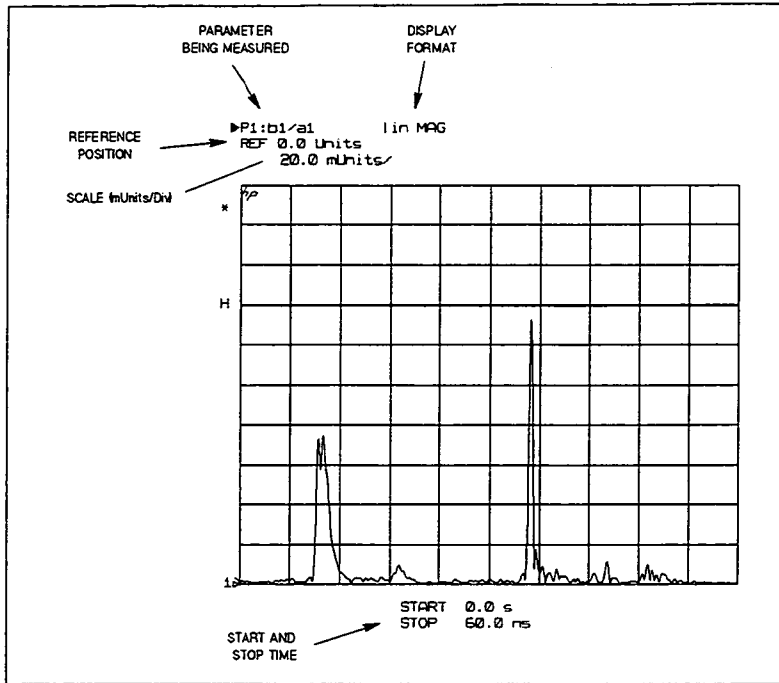

Figure 2-5. Typical RCS Time Domain Measurement

Using the Markers

Markers can now be used to measure each of the responses. See "Using Markers" in Chapter 5 earlier in this chapter to learn how to use this markers. The markers work the same if the display is in the Angle, Frequency, or Time domain.

Manual RCS Measurements

A Quick Display Adjustment

If the Time Domain display has not already been adjusted in an earlier measurement, the following is a quick method to get a good data display.

To adjust the magnitude response so that you can see the data, press:

AUTO

To make sure that you are getting all of the data on the time axis, set the STOP time well beyond the last time response. A good example is:

STOP 300 **G/n** for a 150 foot range.

Press **AUTO** again to make sure all of the response data can be seen on the display.

Look for the first point at which the response starts repeating itself (this is due to aliasing). Figure 2-6 shows an example of this. Adjust the stop time to this point by:

MARKER

Use the knob to move the marker to just before the start of the repeating response, or to the last point that there is an RCS response.

Press: **STOP** **=MARKER**.

The Display will now be showing the full RCS response. You can now adjust the **START**, **STOP**, **SCALE**, **REF VALUE**, and others as desired.

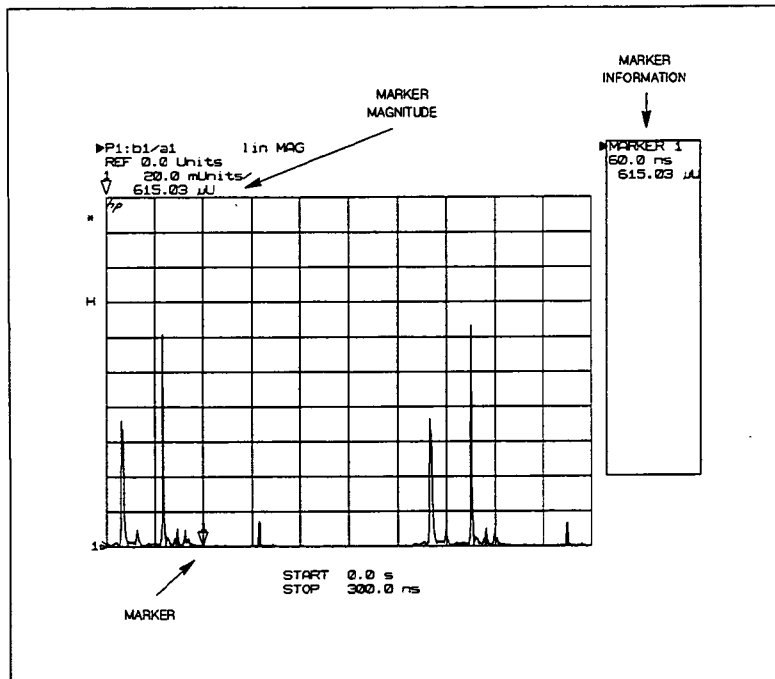

Figure 2-6. Time Domain Measurement Showing Aliasing

Improving RCS Measurement Accuracy

Many of the RCS responses are due to error signals and not due to the target response. Some of the error signals are; coupling, monostatic antenna return loss, chamber reflections and feed clutter. An RCS calibration can remove or reduce some of these errors. Time domain *Gating* can also be used to reduce some of the errors, such as bistatic coupling, antenna return loss, and chamber reflections.

Gating works like a Time Domain “band pass” filter. The gate is placed around the response that you wish to keep, the gate is turned “ON”, and the responses outside of the gate are filtered out. Just like a frequency band pass filter, gating has time response sidelobes, filter skirt, and in-band ripple. For detailed information on gating, see the Time Domain section in the *HP 8530 Operating and Programming Manual*.

Using Gating

To show how to use the gate, we will use the earlier RCS Time Domain example. To get to the gating softkeys, press:

DOMAIN **TIME BANDPASS** **SPECIFY GATE**

Use the **GATE: START** and **STOP** keys or the **CENTER** and **SPAN** keys to center the gate flags around the response that you wish to keep (normally the target response).

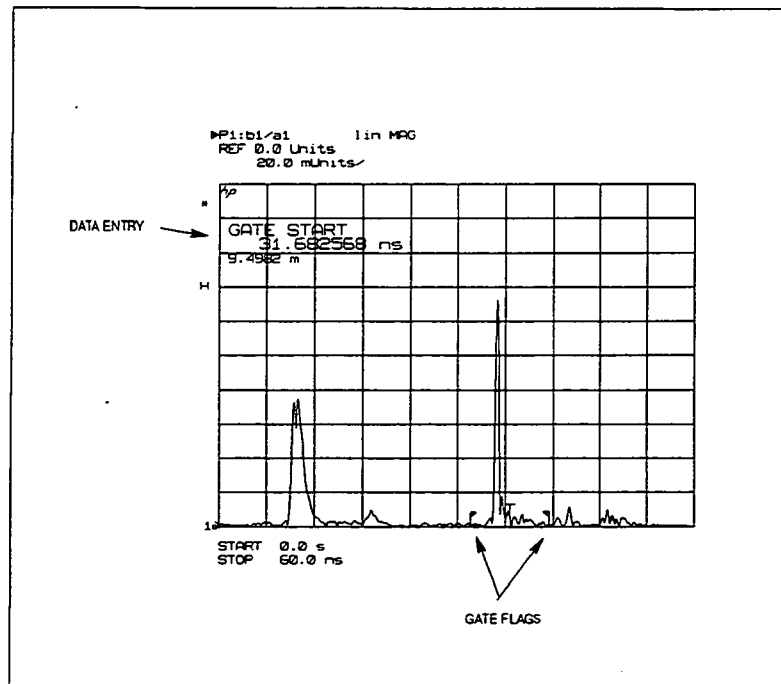

Figure 2-7.
A Measurement Showing the Gate Placed Around the Response

Now turn the gate “ON” by pressing:

GATE ON

Manual RCS Measurements

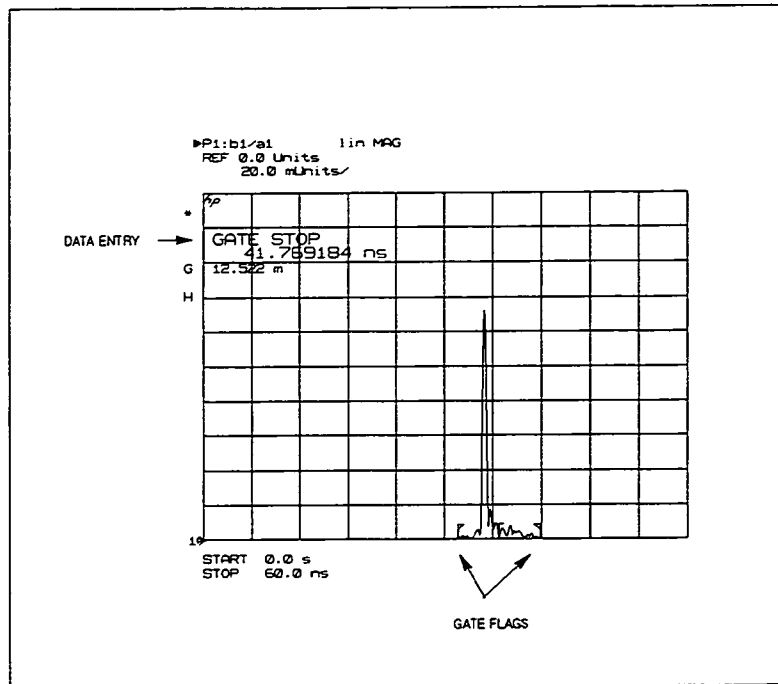

Figure 2-8. The Gate Turned ON

Notice that the responses outside of the gate have been removed.

Gating will also work in the Frequency Domain to reduce response errors too. The next section shows how use both receiver channels to show the differences made by using the gate.

Viewing Frequency and Time Domain Gating

To show the differences between a gated signal and an un-gated signal we are going to use both measurement channels of the receiver. The two measurement channels allow independent adjustment of the various display parameters, such as; scale, format, domain (except angle), parameter, and more.

To set up for this example, return to the basic RCS measurement by turning gating off, markers off, and selecting Frequency Domain.

Press:

DOMAIN **SPECIFY GATE** **GATE OFF**

PRIOR MENU **FREQUENCY**

MARKER **all OFF**

To display both measurement channels, press:

DISPLAY **DISPLAY MODE** **DUAL CHANNEL**

You can also press **GRATICULE OVERLAY** or **SPLIT**, to view the two traces superimposed, or side by side.

Currently channel 1 is the active channel (notice the lit LED above the **CHANNEL 1** key), and any changes you make will affect that channel. To make channel 2 the active channel press:

CHANNEL 2.

Now make the channel 2 display just like the channel 1 display. To do this use the **PARAM**, **SCALE**, **REF VALUE**, **REF POSN**, and **FORMAT** keys. If you press the **GRATICULE OVERLAY** key you will notice that both channels display the same information.

Now change both channels to the Time Domain. Notice that you can change the domain in both channels separately. This allows you to display the frequency response on one channel and the time response on the other.

Press:

CHANNEL 1 **DOMAIN** **TIME BANDPASS**
CHANNEL 2 **DOMAIN** **TIME BANDPASS**

Also notice that channel 1's Time Domain display is set for the same settings that were made earlier. Now make channel 2's Time Domain response display the same as channel 1.

Now turn on the gating around the target response in channel 2. Again notice that the gate is still in the same place we left it earlier in this example.

Press:

SPECIFY GATE **GATE ON**

You can now compare the difference between the gated and ungated responses. Figure 2-9 shows an example of this.

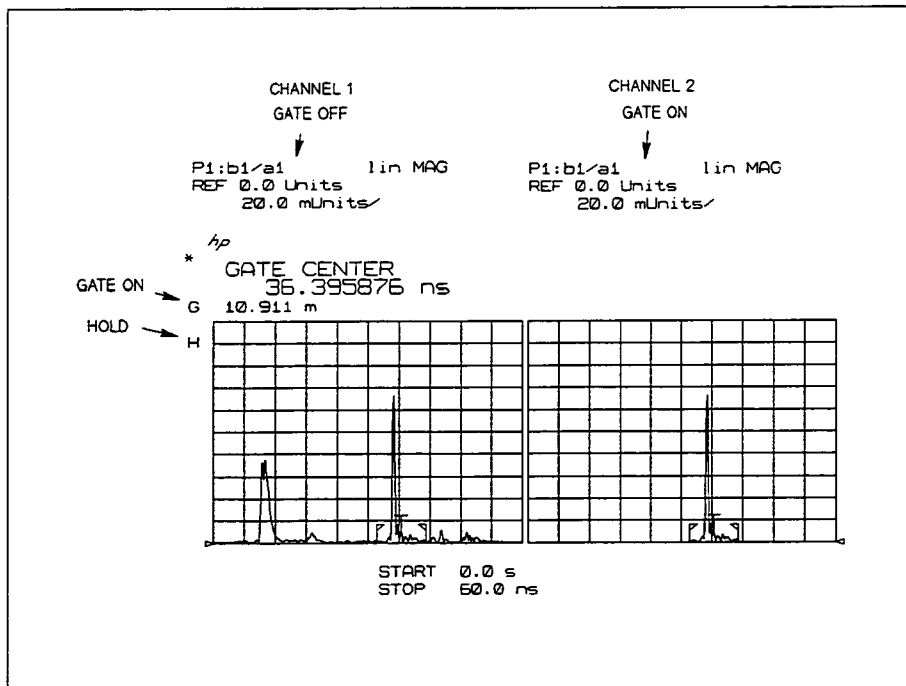

Figure 2-9. Dual Display with Time Domain

Now change both channels back to the Frequency Domain, leaving the gate ON in channel 2, press:

CHANNEL 2 **DOMAIN** **FREQUENCY**
CHANNEL 1 **FREQUENCY**

Manual RCS Measurements

Notice the changes in channel 2 as compared with channel 1. Channel 2 has many of the RCS responses reduced by using the gating capability of the receiver. An example of this is in Figure 2-10.

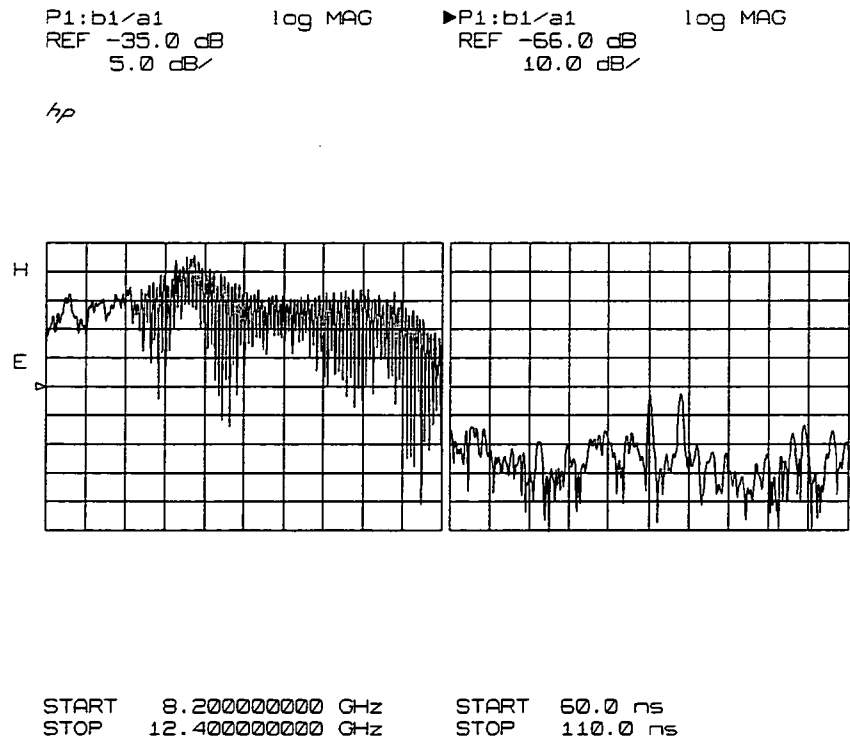

Figure 2-10. Dual Display with Time Domain

You don't have to go into Time Domain to turn ON the gate if you are only measuring in the Frequency Domain. Set the gate at the proper location, either by adjusting the gate in Time Domain, or by a prior knowledge of where the start and stop point would be for the gate. Then, whenever you wish to turn on the gate, press:

DOMAIN **SPECIFY GATE** **GATE ON**

without ever going into the Time Domain.

Antenna and RCS Calibration

This chapter explains antenna and RCS calibration features of the HP 8530A. Network analyzer calibration features are documented in the *HP 8530A Operating and Programming Manual*.

Chapter Contents

- What is Calibration?
- Calibration Requirements
- Calibration Menu Map
- Antenna Calibration
- Standard Gain Antenna Definitions (files)
- Performing an Antenna Calibration
- RCS Calibration

Information Pertaining to All Calibration Types

What is Calibration?

Calibration, regardless of the exact type, reduces repeatable systematic errors caused by the system, the chamber, or the antenna range. To achieve this, the receiver measures one or more standards of known characteristics. During calibration, the receiver:

1. Measures the standard.
2. Compares the results to the known characteristics of that standard.
3. Calculates the exact amount of inaccuracy, and how much the measurement data must be adjusted to compensate for it. The adjustment values are called "error coefficients."
4. Stores the error coefficients in memory.

When actual measurements are made, the calibration feature subtracts the error coefficient values, making the measurement much more accurate.

The HP 8530A can perform three types of calibration:

Antenna Calibration

Antenna calibration allows measured data to be expressed in dBi (dB relative to an isotropic radiator). A standard gain antenna with known or defined gain values at specific frequencies is used as a transfer standard to calibrate the system.

RCS Calibration

Response and Background calibration reduces range errors using a calibration target of known radar cross section. The Response portion of the calibration measures the reflections of the calibration target. The Background portion measures the empty antenna chamber to characterize and compensate for clutter. After performing an RCS calibration, measurements are expressed in dBsm (decibels per square meter).

Network Analyzer Calibration

Network analyzer calibration greatly reduces repeatable systematic errors during network analysis measurements. A network analyzer calibration transfers the accuracy of your calibration standards to the measurement of your device. Network analyzer calibration standards are supplied in a "calibration kit" which must be purchased separately. Calibration kits are made for specific frequency ranges and connector types.

Calibration Requirements

Calibration issues become much simpler if you calibrate using the same equipment and instrument settings that you plan to use during the measurement.

Use the Same Equipment Setup in the Measurement

You *must* calibrate using the same adapters and cables that will be used for the measurement. If the adapters or cables are changed between calibration and measurement, unpredictable errors will result due to the fact that the error coefficients determined during calibration are incorrect for the altered setup. Even disconnecting and reconnecting the same adapter can cause inaccuracy. If you change the setup, you must perform the measurement calibration procedure again to calculate appropriate error terms for the new setup.

Settings You Can Change after Performing a Calibration

1. You can perform a network analyzer calibration in the frequency Domain, then change to time domain, and the calibration will remain valid.
2. You can calibrate using a specific number of points, then make a measurement using a *smaller* number of points.
3. You can perform an antenna calibration in the frequency domain, then change to the Angle or Time Domain, and the calibration will still be valid. (If you change to the Angle Domain, some HP 8530 receivers turn the calibration OFF. You must manually turn the calibration ON again.)
4. You can perform a swept frequency calibration (in Ramp or Step sweep mode), then select a Single frequency measurement. (Some HP 8530 receivers require you to turn the calibration ON again.)
5. You can change start and stop angle while in Angle Domain.

Setting Changes that Require Special Consideration

Other settings can be changed, but require special consideration.

Changing Parameter

The HP 8530A automatically turns calibration OFF if you change parameter. However, it allows you to turn the calibration ON again for the new parameter. If you are not careful, this can result in invalid data. There are situations (explained below) where you can change parameter and get valid measurement results. The important thing to remember is that you must know when the results are valid, and avoid situations where invalid data would result. The instrument will not warn you.

To understand the considerations involved, remember that *a calibration applies to a specific hardware setup (a specific collection of cables, adapters, and so forth, connected in one specific way)*. As long as the parameter you select will measure that equipment as it was originally set up, the calibration will be valid.

For example, assume you originally connected the equipment to inputs b1 and a1, and performed the calibration using b1/a1 ratio. You can select any parameter key that is currently defined as b1/a1 and the calibration will be valid. (You can redefine any parameter key to be b1/a1.)

Calibration Fundamentals

Changing Stimulus Values

Changing any of the following settings will cause the message **CAUTION: CORRECTION MAY BE INVALID** to be displayed. Calibration remains ON.

- Source Power
- Power Slope
- Dwell Time
- Sweep Time
- Sweep Modes
- Trim Sweep Value

Settings that should not be changed

Selecting a Different Frequency Range

If you have performed any type of calibration across a frequency range, and then change frequencies, calibration is automatically turned Off, and **CORRECTION RESET** is displayed.

Selecting a Greater Number of Points

If you calibrate using a certain number of points, you cannot perform a measurement using a greater number of points. If you attempt to select a greater number of points, calibration is automatically turned Off, and **CORRECTION RESET** is displayed.

Using Averaging

For all calibrations, use the same or greater averaging factor than will be used for the device measurement. In general, use an averaging factor of 8 or 16 for most measurements. Hewlett-Packard recommends that you increase the averaging factor for the isolation portion of the calibration (in RCS calibration this is the background calibration). This can be easily accomplished by turning Averaging ON before beginning the calibration, then leaving averaging factor as the active function during the calibration.

If you are using averaging

If averaging is ON during calibration, then the correct number of measurements needed to provide fully averaged data are automatically taken. For Ramp sweeps this means that $n+1$ sweeps, where n is the current averaging factor, are taken. For Step, Single Point, or Frequency List, each data point is averaged n times (where n is the selected number of averages).

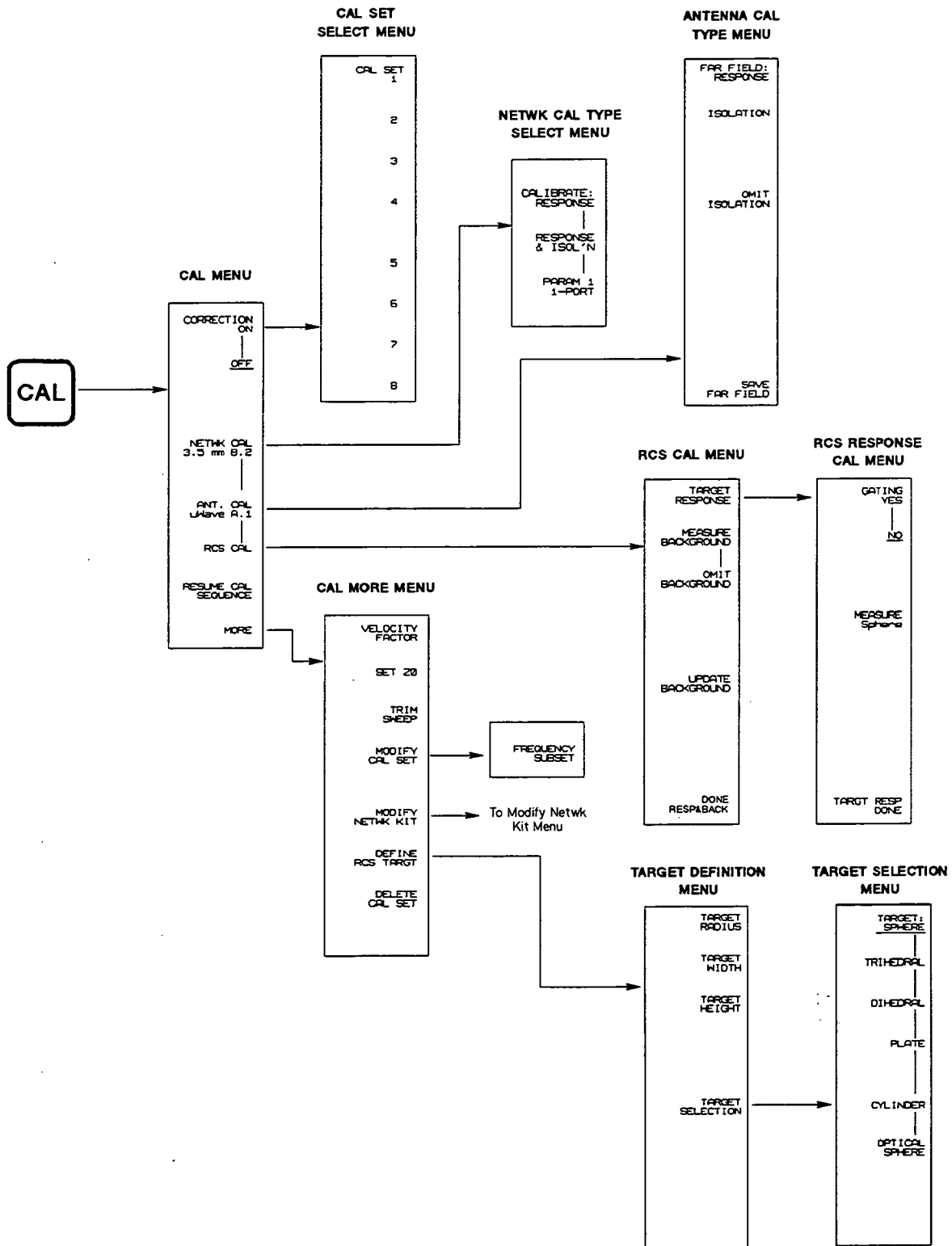

Figure 3-1. Cal and Cal Type Menus

Specific Calibration Procedures

The following pages contain information about specific types of calibration, including step-by-step procedures on performing calibrations.

The receiver provides the following calibration types:

- Antenna Calibration
- RCS Calibration
- Network Analyzer Calibration (only described in the operating and programming manual)
 - Response Calibration
 - Response and Isolation Calibration
 - 1-Port Calibration

Antenna Calibration

Antenna calibration allows measured data to be expressed in dBi (dB relative to an isotropic radiator). A standard gain antenna with known or defined gain values at specific frequencies is used as a transfer standard to calibrate the system.

Calibrating with a standard gain antenna corrects for the transmission response errors.

An optional part of antenna calibration is an "isolation calibration." This calibration reduces crosstalk errors between input channels. The isolation cal requires a high quality RF load as a calibration standard. The load you need is determined by the connector type and frequency range of your system.

Important Terms

Cal	"Cal" is an abbreviation for "Calibration."
Cal Definition	A cal definition is an ASCII file you create using a text editor. It contains theoretical or measured frequency and gain values for the standard gain antenna. You can create the file using any computer-based text editor which can save text in plain ASCII format. The file can then be loaded into the receiver from a DOS or LIF disc. A cal definition contains up to seven "antenna definitions."
Antenna Definition	The gain data for a specific standard gain antenna is called an "antenna definition."
Cal Set	A finished calibration data file. During the calibration, the standard gain antenna is measured and its performance is compared to one or more antenna definitions. Any differences are stored in an internal "cal set register." These differences are the error coefficients which, when subtracted from the measurement, result in calibrated results. In antenna calibration, the final measurement data is expressed in units of antenna gain (dBi). Cal sets can be stored in internal registers or to disc.

Angle Domain and Frequency Domain Calibrations

If you perform a calibration while in angle domain, the calibration will be at one frequency. (Angle Domain makes measurements at only one frequency.)

If you perform a calibration while in Frequency Domain, you can calibrate over a range of frequencies.

Using a Frequency Domain Calibration in Angle Domain.

HP recommends that you calibrate using Frequency Domain, which calibrates over a range of frequencies. You can then switch to Angle Domain, and pick any of the frequencies from the Frequency Domain calibration. This gives you instant access to many calibrated frequencies (one at a time) when in Angle Domain.

Only one limitation applies; the frequency you want to measure (in angle domain) must exist in the original calibration. The receiver does not interpolate between calibrated frequencies.

Here are the basic steps involved in antenna calibration:

Antenna Calibration Overview

Note Steps 1 and 2 are not necessary if you use one of the supplied standard gain antenna definitions, or if you have already created your own definition.

- 1 Create an ASCII file with Standard Gain Antenna Data (a definition). Save the file to HP 9000 Series 300 (LIF) or DOS compatible disc (filename must begin with AC_). LIF filenames can have up to seven additional characters: AC_XXXXXXX, DOS filenames can have up to five additional characters, plus an extender: AC_XXXXX.XXX

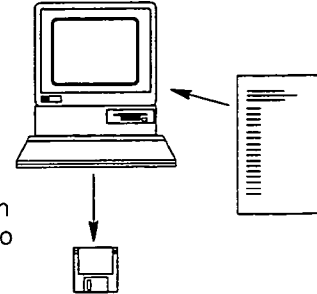

- 2 Load the Standard Antenna Definition into the HP 8530A from the disc.

- 3 Mount the standard gain antenna and find boresight.

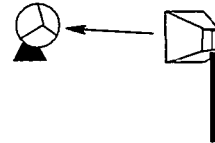

- 4 Choose Angle Domain or Frequency Domain.



- 5 If using Angle Domain, choose the calibration frequency using the **FREQUENCY of MEAS.** softkey.

If using Frequency Domain, choose calibration frequencies using start, stop, and number of points, or use frequency list mode to enter specific frequencies.

- 6 Start the calibration. The receiver creates calibration data based on the standard gain antenna.

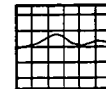

- 7 If you are making a calibration using two or more standard antennas, mount the next standard gain antenna, find boresight, and calibrate.

- 8 If desired, perform an isolation calibration to reduce channel crosstalk.

- 9 Save the calibration to a Cal Set Register.

- 10 If desired, store the calibration to disc.



Standard Gain Antenna Definitions

To perform a calibration, the receiver must know the published gain values of the standard gain antenna. HP has supplied a file containing data for seven Narda standard gain horns.

If You Are Using a Narda Standard Gain Horn that is Already Defined:

Data for Narda models 638, 639, 640, 642, 643, 644, and 645 are supplied in a single cal definition file. This file, AC_NAR1, is supplied on the Antenna/RCS Cal Disc which was shipped with the HP 8530A. If you are using one of these horns, load AC_NAR1 as explained below:

1. Insert the Antenna/RCS Cal Disc into the HP 8530A's disc drive.
2. Press **DISC** **LOAD** **CAL KITS** **ANTENNA CAL DEF**, the receiver will display a file directory showing AC_NAR1. Since it is the only cal definition on that disc, it will already be highlighted.
3. Press **LOAD FILE**.

When you perform the antenna calibration you will see the Narda horns listed in a softkey menu. Information on the Narda horns is provided at the end of the calibration section. Please note that your Narda standard gain horn calibration data may be different than the data on file AC_NAR1.

If You Are Not Using One of the Pre-Defined Narda Horns:

Create your own cal definition file as explained in "Creating a Standard Gain Antenna Definition", at the end of this chapter. You will need a personal computer and a text editor that can save text in plain ASCII format.

Note



If you calibrate over a wide frequency range, you may need to use two or more standard gain antennas. Some users have asked us: "When calibrating, what happens when two of the standard gain antennas have overlapping frequencies?" The answer is: Where the frequencies overlap, the receiver uses the calibration data for the standard gain antenna that was measured last.

Performing an Antenna Calibration

Frequency Domain Calibration

Initial Setup, Finding Boresight

1. Mount the standard gain antenna on the proper antenna mount and connect it to your system.
2. Press: **RECALL** **MORE** **FACTORY PRESET**.
3. Press: **DOMAIN** **FREQUENCY**.
4. Press: **STIMULUS** **MENU** **SINGLE POINT**.
5. Press **CENTER** and enter a frequency in the approximate center of the calibration frequency range.
6. Press **MARKER**.
7. Select the desired axis on the positioner controller.

Antenna Calibration

8. Move the positioner so the antenna is somewhere near its boresight position (a rough approximation is fine).
9. Move the positioner until the flat line reaches maximum amplitude (or minimum amplitude if your antenna has a null at boresight). It is helpful to watch the marker value readout (in the upper-left portion of the display). This digital readout of the amplitude makes it easy to observe small (0.1 dB) changes.
10. Boresighting is usually interactive between axes, so repeat steps 5, 6, and 7 for each axis until true boresight is found.

Choosing Calibration Stimulus Settings

1. Perform step a or b below, depending on if you want to calibrate at one or more frequency points.
 - a. If you only want to calibrate at a single frequency press **STIMULUS** **(MENU)** **SINGLE POINT**. Press **(CENTER)** followed by the desired frequency, proceed to *Antenna Calibration Steps*, below.
 - b. To calibrate over a range of frequencies, you must choose a sweep mode. Any mode will work *but the Frequency List mode is strongly recommended*. The Frequency List **STEP SIZE** function allows you to enter a *known increment frequency*. This is why the Frequency List mode is better when performing a calibration. Ramp and step sweep modes only allow you to choose a **NUMBER of POINTS**, and *the receiver* chooses the increment frequency. This limits flexibility in the calibration and often results in inconvenient increment values (like 17.67 MHz). **STEP SIZE** allows *you* to choose a step size that is *convenient*.

Note



Ramp Sweep mode is not always usable, depending on how your system is configured. Ramp Sweep mode will not function in systems that use an LO source. In addition, Ramp Sweep requires two BNC connections between the receiver and the RF source.

Sometimes wide frequency ranges require you to use two or more standard gain antennas to cover the whole frequency range. If this is the case, enter the entire frequency range during the procedure below.

To use Frequency List mode, as recommended, perform the following sub steps:

- i. Press **STIMULUS** **(MENU)** **MORE** **EDIT LIST**.
- ii. Press **EDIT** **SEGMENT: START** and enter the desired start frequency (for example, 8.2 GHz).
- iii. Press **STOP** and enter the desired stop frequency (for example, 12.4 GHz).
- iv. Press **STEP SIZE** and enter the desired frequency increment value. Assume for a moment that your standard gain antenna has documented gain values every 50 MHz. You can choose smaller increments (for example, 25 MHz), and the receiver will interpolate between known gain points. (Straight-line interpolation is performed.)
- v. Press **DONE**. The receiver will display the number of points it will use in the measurement, based on the selected step size.
- vi. Press **DONE** again.
- vii. Press **FREQUENCY LIST** to select Frequency List mode.

Antenna Calibration Steps

2. Press the **CAL** key (located in the MENUS block), then press:

ANT. CAL uWave A.1 FAR FIELD:RESPONSE

A menu will appear with seven standard gain antenna definitions to choose from.

3. Select the definition for your standard gain antenna. If you must create a definition for your standard gain antenna, refer to “Creating a Standard Gain Antenna Definition”, at the end of this chapter.

The receiver will now measure the standard gain antenna, and create a list of offsets called a “Cal Set.”

If you only want to measure one standard gain antenna, press **DONE RESPONSE** and proceed to “Finishing the Gain Calibration,” below.

Note

If you see the error message: CAUTION: ADDITIONAL STANDARDS NEEDED, the standard gain antenna does not cover the entire frequency range of the calibration. You should do one of the following things:

- a. Measure an additional standard gain antenna to cover the additional frequencies.
- b. Use a standard gain antenna that covers the entire frequency range. *If your antenna is specified to cover the selected frequency range: Make sure the standard gain antenna definition really has entries for the entire frequency range of that antenna. The person who created the “definition” file for that antenna may not have entered values for its entire range. Refer to the section on creating standard gain antenna definitions, in this chapter.*
- c. Select a calibration frequency span that is within the frequency range of the standard gain antenna and do the calibration over again.

4. If you are calibrating for a wide frequency range, requiring more than one standard gain antenna:
- a. Mount the next standard gain antenna.
 - b. If necessary, boresight the antenna. You must stay in the current Domain and Sweep Mode. For example, if you are currently in Frequency List mode, the receiver must remain in this mode during boresighting or the calibration will be ruined. With a marker still ON, turn the antenna until boresight (for that axis) is found. Turn the antenna in small steps because of the delay between completed sweeps. Do this for each axis until boresight is found.
 - c. Select the appropriate standard gain antenna definition from the softkey menu.
 - d. Repeat these sub-steps for each standard gain antenna you need to measure.
 - e. Press **DONE RESPONSE** when you are done.

If the error message: CAUTION: ADDITIONAL STANDARDS NEEDED appears, then the definitions for your standard gain antennas do not cover the entire frequency range you have selected. There are either gaps between adjacent definitions, or they do not provide full coverage near the beginning or end of the frequency range.

Finishing the Gain Calibration

5. You are now done with the gain portion of the calibration. Now you should decide if you want to perform an “isolation calibration.” An isolation calibration reduces crosstalk between inputs (either reference-to-test or test-to-test), and requires a high-quality 50Ω load.

Antenna Calibration

- a. If you *do not* want to perform an Isolation Calibration, press **OMIT ISOLATION** and proceed to “Saving the Cal Set to a Cal Set Register.”
- b. If you want to perform an isolation calibration, refer to “Isolation Calibration,” below.

Isolation Calibration

6. Replace the standard gain antenna with a 50 Ω load. Make sure the load’s connector is torqued as shown in Table 3-1 to prevent RF leakage.

Table 3-1. Proper Connector Torque

Connector	Torque cm-kg	Torque N-cm	Torque in-lbs	Wrench Part Number
Type-N	52	508	45	8710-1935
3.5 mm	9.2	90	8	8720-1765
SMA	5.7	56	5	8710-1582
2.4 mm	9.2	90	8	8720-1765

7. Press **ISOLATION**. The receiver will perform the isolation calibration.

Saving the Cal Set to a Cal Set Register

8. Press **SAVE FAR FIELD**. A menu of eight cal set registers will appear. Press any of the eight register softkeys and the cal set will be saved to that register.

The receiver will now turn calibration ON, so any measurement you make will be calibrated.

Angle Domain Calibration

Initial Setup, Finding Boresight

1. Mount the standard gain antenna on the proper antenna mount and connect it to your system.
2. Press **RECALL** **MORE** **FACTORY PRESET**.
3. Press **DOMAIN** **ANGLE**.
4. Press **STIMULUS** **MENU** **SINGLE ANGLE**.
5. Press **FREQUENCY OF MEAS**, then enter the desired calibration frequency.
6. Press **MORE** **CONTINUAL**.
7. Press **TRIGGER MODE** **TRIG SRC FREE RUN**.
8. Select the desired parameter, **PARAM 1**, **PARAM 2**, **PARAM 3**, or **PARAM 4**.
9. Turn on Marker 1 by pressing **MARKER** **MARKER 1**.
10. Now use the positioner controls to move the antenna. Watch the data readout for Marker 1. When the marker reaches peak value you have found the boresight for that particular axis.
11. Repeat for each axis, if necessary. Boresighting is iterative so you may have to measure back and forth between axes until the true boresight is found.

Antenna Calibration Steps

1. Press the **CAL** key (located in the MENUS block), then press:

ANT. CAL uWave A.1 **FAR FIELD RESPONSE**

A menu will appear with seven standard gain antenna definitions to choose from.

2. Select the definition for your standard gain antenna. If you must create a definition for your standard gain antenna, refer to "Creating a Standard Gain Antenna Definition", at the end of this chapter.

The receiver will now measure the standard gain antenna, and create a list of offsets called a "Cal Set."

Press **DONE RESPONSE** and proceed to "Finishing the Gain Calibration," below.

Finishing the Gain Calibration

3. You are now done with the gain portion of the calibration. Now you should decide if you want to perform an "isolation calibration." An isolation calibration reduces crosstalk between inputs (either reference-to-test or test-to-test), and requires a high-quality 50Ω load.
 - a. If you *do not* want to perform an Isolation Calibration, press **OMIT ISOLATION** and proceed to "Saving the Cal Set to a Cal Set Register."
 - b. If you want to perform an isolation calibration, refer to "Isolation Calibration," below.

Isolation Calibration

4. Replace the standard gain antenna with a 50 Ω load. Make sure the load's connector is torqued as shown in Table 3-2 to prevent RF leakage.

Antenna Calibration

Table 3-2. Proper Connector Torque

Connector	Torque cm-kg	Torque N-cm	Torque in-lbs	Wrench Part Number
Type-N	52	508	45	8710-1935
3.5 mm	9.2	90	8	8720-1765
SMA	5.7	56	5	8710-1582
2.4 mm	9.2	90	8	8720-1765

5. Press **ISOLATION**. The receiver will perform the isolation calibration.

Saving the Cal Set to a Cal Set Register

6. Press **SAVE FAR FIELD**. A menu of eight cal set registers will appear. Press any of the eight register softkeys and the cal set will be saved to that register.

The receiver will now turn calibration ON, so any measurement you make will be calibrated.

Important Note On Antenna Measurements

Before you make actual measurements (with calibration ON), IT IS VITAL THAT YOU READ THE FOLLOWING:

The frequencies you measure must exactly match the frequencies in the cal set file.

For example, assume you have calibrated from 10 GHz to 11 GHz with a step size of 100 MHz. The calibrated frequencies in the cal set are:

10.0 GHz	10.6 GHz
10.1 GHz	10.7 GHz
10.2 GHz	10.8 GHz
10.3 GHz	10.9 GHz
10.4 GHz	11.0 GHz
10.5 GHz	

You can measure any of these frequencies during the actual measurement. You cannot, however, measure *any other* frequencies. For example, you cannot measure 10.55 GHz. *The receiver does not interpolate between frequencies in the cal set.*

This is another reason why Frequency List mode is so useful when performing calibrations. *Entering a known, convenient step size makes it easy to know what frequencies are in the cal set. Thus, you know precisely which frequencies you can measure with that calibration.*

Things to Try

Assume you created a calibration in the Frequency Domain, using the Frequency List mode, and you save the cal set to Cal Set Register 1. Now go to the Angle Domain. Some HP 8530A receivers will now display the message CAUTION: CORRECTION RESET. Simply press **CAL** **CORRECTION ON CAL SET 1** to turn the calibration ON again. The Frequency Domain calibration is still valid, even though you are now in the Angle Domain. You can select any of the frequencies in the original Frequency Domain calibration, and the calibration will remain valid.

Now change the start and stop angle, notice that the calibration remains valid.

RCS Calibration

RCS Calibration Description

This section explains how to perform an RCS calibration. RCS Response and Background calibration reduce range errors using a calibration target of known radar cross section. The Response portion of the calibration reduces phase and amplitude discrepancies between the test and reference channels (tracking errors). The Background portion measures the empty antenna chamber to reduce undesired reflections (clutter). After performing an RCS calibration, log magnitude measurements are expressed in decibels per square meter (dBsm).

You should become familiar with concepts presented in the Time Domain chapter before performing an RCS calibration.

Important Information about Gating During the Calibration

Keep the following in mind if using gating during RCS calibration:

- After the RCS calibration is completed, the calibrated response of the Calibration Target will move, and the gate will no longer be centered around it. To make sure that you do not accidentally leave the gate around the old (now incorrect) position, the receiver turns gating OFF once calibration is done. When you perform actual RCS measurements, turn gating back ON and center it around the response of your measurement target. Usually the target will be at 0.00 seconds.
- Remember, gating has limitations. Do not use gating if:
 - You are measuring a limited frequency span or number of points.
 - If using a frequency list where the points are not evenly spaced.

RCS Calibration Overview

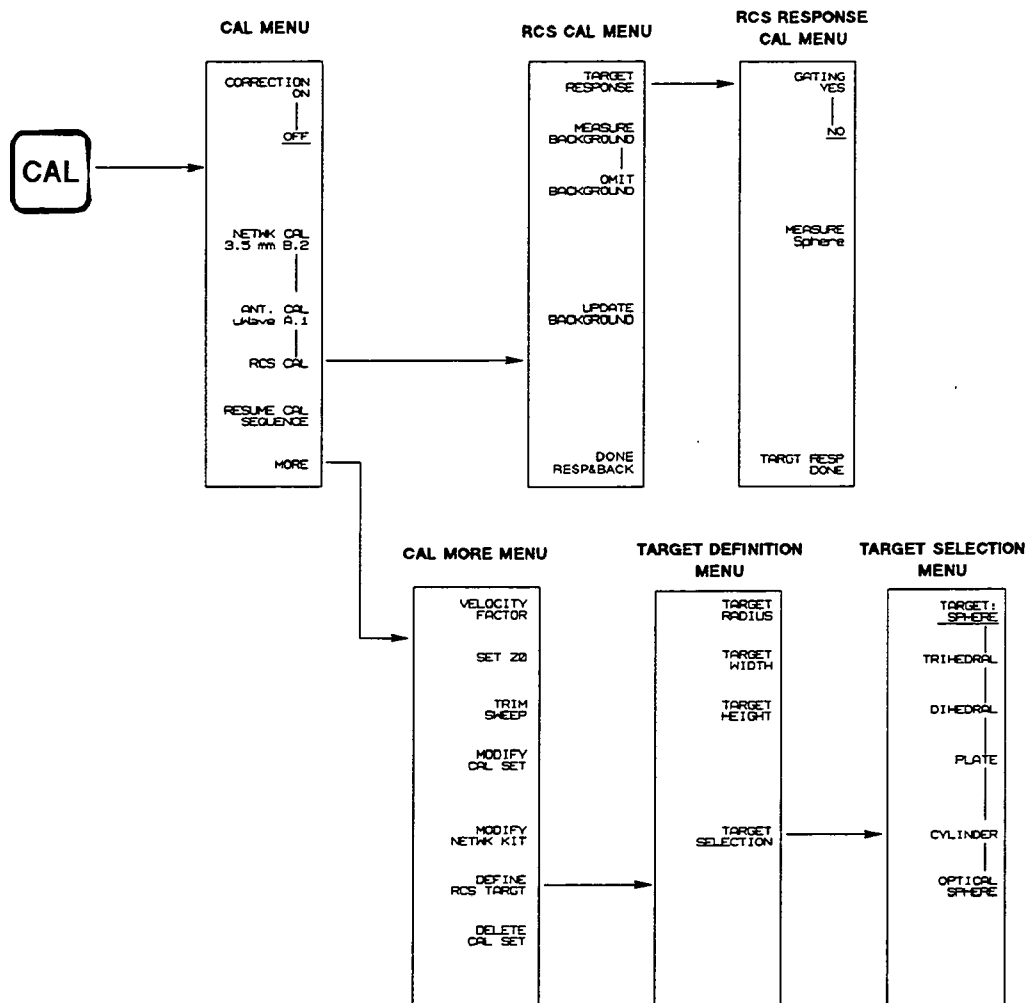

Figure 3-2. Menus Associated with RCS Calibration

1. Determine the requirements of your measurement, including:

- Stimulus Settings
- Range Resolution
- Alias Free Range
- Gating Requirements

These requirements will determine the stimulus, window, and gate settings you should use.

2. Select Frequency Domain

3. Select stimulus settings, using one of the following methods:

- Set start and stop frequency and number of points. This method is acceptable if you are performing RCS calibrations for use in the Time Domain.
- Use Frequency List mode with a start frequency, stop frequency, and a specific frequency step value. This method allows you to know the exact frequencies represented in the calibration. This method is preferable if you are going to make RCS measurements in the Angle Domain. Why? Because you can then make calibrated measurements at any

RCS Calibration

frequency that exists in the calibration. (Remember, when making actual measurements, the receiver cannot interpolate between calibrated frequencies.)

4. If desired, turn ON gating.
5. If desired, turn ON Averaging.
6. Specify RCS target type and its physical dimensions.
7. Perform the actual RCS calibration.
8. After the calibration, use **UPDATE BACKGROUND** if you change target mounts or if other changes occur to the background. This updates the calibration so it is accurate given the new background conditions.

RCS Calibration Procedure

As mentioned above, first determine the needs of your measurement, then use the information in Chapter 13, Time Domain Measurements, to calculate required start frequency, stop frequency, and number of points, or the Frequency List mode settings required.

Select Stimulus Values

1. Enter the required frequency values using Start, Stop, and Number of Points, or by using the Frequency List mode.

Select Gating (if Desired)

Gating is explained in the Time Domain chapter.

2. Use Gating as explained below:
 - a. If you are going to perform a gated calibration, make sure any previous calibrations are OFF. THIS IS VERY IMPORTANT.

Press **CAL** **CORRECTION OFF**

- b. Next, determine the location and width of the target response. An easy way to do this is to use display math:
 - i. Remove the RCS target and allow the receiver to measure one full frequency sweep.
 - ii. Save the measurement to memory by pressing:

DISPLAY **DATA -> MEMORY**

- iii. Select math subtraction mode by pressing:

SELECT DEFAULTS **MATH OPERATIONS** **MINUS (-)**

- iv. Place the target on the mount, and allow another full measurement sweep.

- v. Select Data minus Memory mode by pressing:

DISPLAY **MATH (-)**

- vi. Only the target response will appear on the screen.

- c. Press **DOMAIN** **TIME BAND PASS** **SPECIFY GATE**.

- d. Choose the gate position and size using the gate **START** and **STOP**, or **CENTER** and **SPAN** softkeys.

- e. Select gate shape by pressing **GATE SHAPE**, then either **MAXIMUM**, **WIDE**, **NORMAL**, or **MINIMUM**. In most circumstances, the factory default (Normal) is the best choice.

- f. Turn Gating ON by pressing **PRIOR MENU** **GATE ON**.
- g. Position the gate around the target response.

If your target is a sphere, the placement of the gate is critical. Spheres produce a secondary reflection caused by RF energy propagating around the back of the sphere, which ultimately arrives back at the receive antenna. This produces the secondary reflection, known as a "creeping wave."

- If the creeping clearly separate from the main target response, place the gate around just the main response. In this case make sure you select the **OPTICAL SPHERE** model when you define the RCS target (the next step).
- If the main target response and the creeping wave are not clearly distinct and separate, position the gate around both of them. In this case make sure you select the **TARGET: SPHERE** model when you define the RCS target (the next step).

Do not attempt to gate out very large background reflections, or subsequent measurements will not be accurate.

Define the RCS Target

The next step is to select the type of RCS target you use during calibration, and enter its physical dimensions.

3. Press **CAL** **MORE** **DEFINE RCS TARGET** **TARGET SELECTION**.
4. Select the type of calibration target by pressing one of the following:

TARGET: SPHERE

PLATE

TRIHEDRAL

CYLINDER

DIHEDRAL

OPTICAL SPHERE

If You are Using a Sphere:

If you are NOT using gating during the calibration, *always* select **TARGET: SPHERE**.

The Difference between Sphere and Optical Sphere

The top selection, **SPHERE**, computes the exact solution for the radar cross section of a perfectly conducting sphere.

The **OPTICAL SPHERE** selection computes the radar cross section of the sphere based on geometric optics - in which the RF signal is treated as "optical rays" according to physical principles of reflection and refraction. The optical sphere selection is best used when the wavelength of the RF energy is large enough that it approximates the behavior of light. This is called the "optical region" of the sphere. The RF energy is in the sphere's "optical region" when the following relationship between wavelength and sphere radius is true:

$$(2\pi r \div \lambda) > 10$$

Where λ is wavelength and r is the radius of the sphere.

NOTE: Radar Cross Section data for all target types except **SPHERE** are based on geometric optics.

5. Press **PRIOR MENU**.
6. Enter the required (metric) dimensions of the target using the appropriate dimension softkeys for each type of target:

RCS Calibration

TARGET RADIUS

TARGET HEIGHT

TARGET WIDTH

Figure 3-3 shows the dimensions required for each type of target.

To specify dimensions in meters, terminate the value with **[x1]**. To specify dimensions in millimeters, use **[k/m]**.

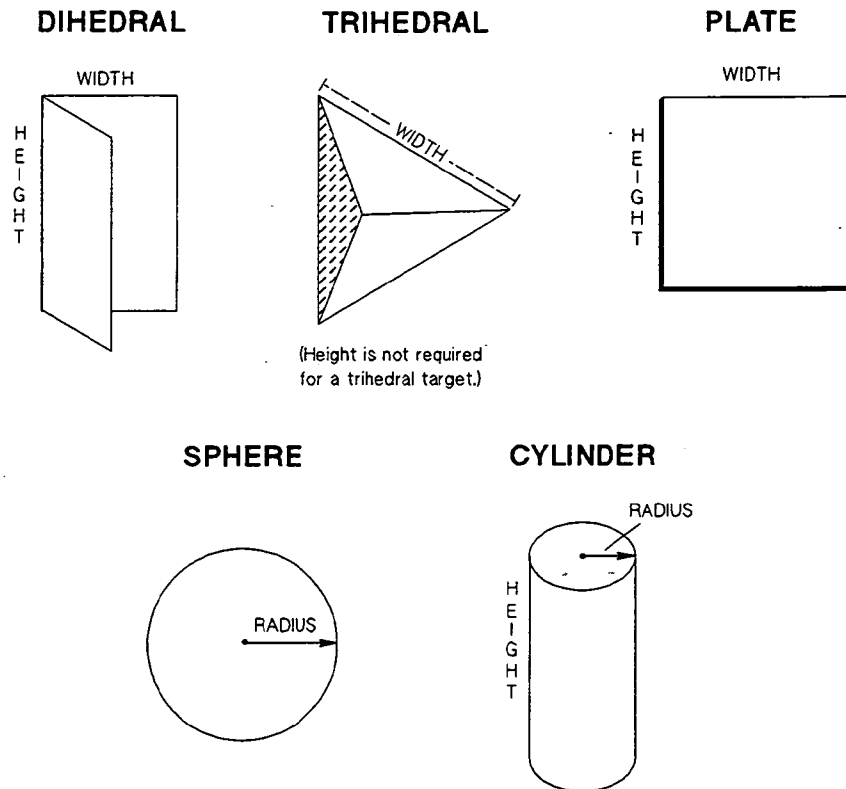

Figure 3-3. Dimensions Required by Different Target Types

Note



On Dihedral and Plate targets, height and width are interchangeable. Trihedral and sphere targets only require one dimension to be specified.

Select Averaging (if Desired)

7. If desired, turn Averaging ON and set it to the required value. For example, press:

RESPONSE [MENU] AVERAGING ON/restart n [x1]. Where n is the desired averaging factor.

Perform the Calibration

8. Make sure the RCS target is on the mount.

9. Press **[CAL] RCS CAL TARGET RESPONSE**.

10. If gating is ON, you can select whether it will affect the calibration. To make current gating settings affect the calibration, press **GATING YES**. If **GATING NO** is selected, current gating settings will not affect the calibration.
11. Measure the calibration target by pressing **MEASURE target name**. (This softkey displays the name of the currently-selected target.)
 At this time the receiver performs a response calibration on the target. This part of the calibration reduces magnitude and phase discrepancies between the test and reference channels (tracking errors).
12. Press **TARGT RESP DONE**.

Optional Background Calibration

The next step is to measure the background. The background consists of the chamber and mount without the RCS calibration target. This part of the calibration is an isolation calibration. It reduces the effects of undesired chamber reflections (clutter).

If you do not want to perform the background portion of the calibration, press **OMIT BACKGROUND DONE RESP&BACK**. Now select one the of eight cal set registers to hold the calibration data.

To perform the background calibration:

13. Remove the RCS target.
14. Press **MEASURE BACKGROUND**.
15. Press **DONE RESP&BACK**. Now select one the of eight cal set registers to hold the calibration data.
16. Now proceed with normal RCS measurements.

If you used single sweep mode to find the target response (earlier in this procedure), remember to change sweep mode back to the type needed for actual measurements. Most often this is the Continual mode.

Updating the Background

Once calibration is done, if you change the RCS mount, or the background changes, you should update the background. To do this:

1. Make sure the appropriate RCS calibration is ON.
2. Press: **CAL RCS CAL UPDATE BACKGROUND**
3. Press **DONE RESP&BACK**. Now select one the of eight cal set registers to hold the calibration data:
 - a. You can store the updated calibration to the register which holds the original version, or:
 - b. If you change mounts regularly, you can store the updated calibration to a different cal set register. Then you can recall the register appropriate for each RCS mount.

Network Analyzer Calibration

Network analyzer calibration features are documented in the *HP 8530A Operating and Programming Manual*.

Creating a Standard Gain Antenna Definition

Introduction

If you use different standard gain antennas than those already defined, you must create a "cal definition." To do this, you must:

- Create an ASCII text file on a computer.
- Save the file to disc
- Load the file into the HP 8530A.

This section explains how to create your own definitions.

Important Terms

Cal Definition

A cal definition is an ASCII file you create using a text editor. It contains theoretical or measured frequency and gain values for one or more standard gain antennas. You can create the file using any computer-based text editor which can save text in plain ASCII format (which can save the file to an MS DOS® or HP LIF disc). The file can then be loaded into the receiver from the disc. The cal definition file can contain up to seven "antenna definitions."

Antenna Definition

The gain data for a specific standard gain antenna is called an "antenna definition." As mentioned above, a *cal definition* contains up to seven antenna definitions.

The Supplied Cal Definition

The HP 8530A is *not* shipped with a cal definition in memory. However, a pre-defined cal definition (AC_NAR1) is supplied on the Antenna RCS/Cal Disc, which was shipped with the receiver. You can load AC_NAR1, or a cal definition you create, by following the instructions in "Loading the Cal Definition into the HP 8530A". Details on AC_NAR1 are provided at the end of this section.

Required Hardware

A cal definition is a simple ASCII text file. You can create a cal definition using:

- Any computer that can save ASCII files to MS-DOS compatible discs.
- Any computer that can save ASCII files to discs formatted in Hewlett-Packard Logical Interchange Format (LIF).

You **MUST** use a text editor that can save plain ASCII files!

Creating an Antenna Definition

A cal definition is composed of up to seven individual antenna definitions. Each antenna definition applies to a specific standard gain antenna. Use the following instructions to create an antenna definition.

Choosing the Number of Frequency Points to Define

If the performance of the standard gain antenna is linear, you only need to define a few frequency points across the frequency band. Most standard gain antennas are not very linear, so a greater number of frequency points are recommended. You can define up to 201 frequency points.

Covering a Wide Frequency Range

You can define antenna definitions for up to seven standard gain antennas. This provides continuous coverage over a wide frequency range. The calibration feature allows you to measure up to seven antenna definitions for a single calibration.

Determine Required Stimulus Values

Determine the exact frequencies you want to use in the antenna definition. Hewlett-Packard recommends that you choose frequencies that cover the entire range of your standard gain antenna, even if you only make measurements at single frequencies.

- Start frequency of your standard.
- Stop frequency of your standard.
- Difference between frequency points (the frequency increment).
- Number of frequency points.

The start and stop frequencies you already know from the published data.

Choosing the Number of Points

The more points you use the more accurate the calibration will be. The limiting factor is usually the published data for the standard antenna. The accuracy and resolution of the standard gain antenna graphs or tables will be the limiting factor in calibration accuracy.

Determining the Frequency Increment

To determine the frequency increment, divide the *frequency span* by the (*number of points - 1*).

For example:

- Start frequency = 2 GHz
- Stop frequency = 4 GHz

The frequency span is 2 GHz

Creating a Standard Gain Antenna Cal Definition

Assume the standard gain antenna's graph or table provides 21 decipherable data values across the 2 GHz frequency span:

Divide the frequency span by *number of points - 1*:

$$2 \times 10^9 / (21 - 1) = 100 \text{ MHz}$$

The first frequency in your antenna definition is the start frequency (2 GHz in this example). From there, 20 *additional* points exist, each spaced 100 MHz apart. The first three frequencies would be:

- 2,000,000,000 Hz
- 2,100,000,000 Hz
- 2,200,000,000 Hz

The last frequency point would be the stop frequency.

Determining Gain Values at Each Frequency Increment (Graph Format)

Next, you must determine the gain values at each frequency increment. Figure 3-4 shows a typical graph-style data sheet for a standard gain antenna.

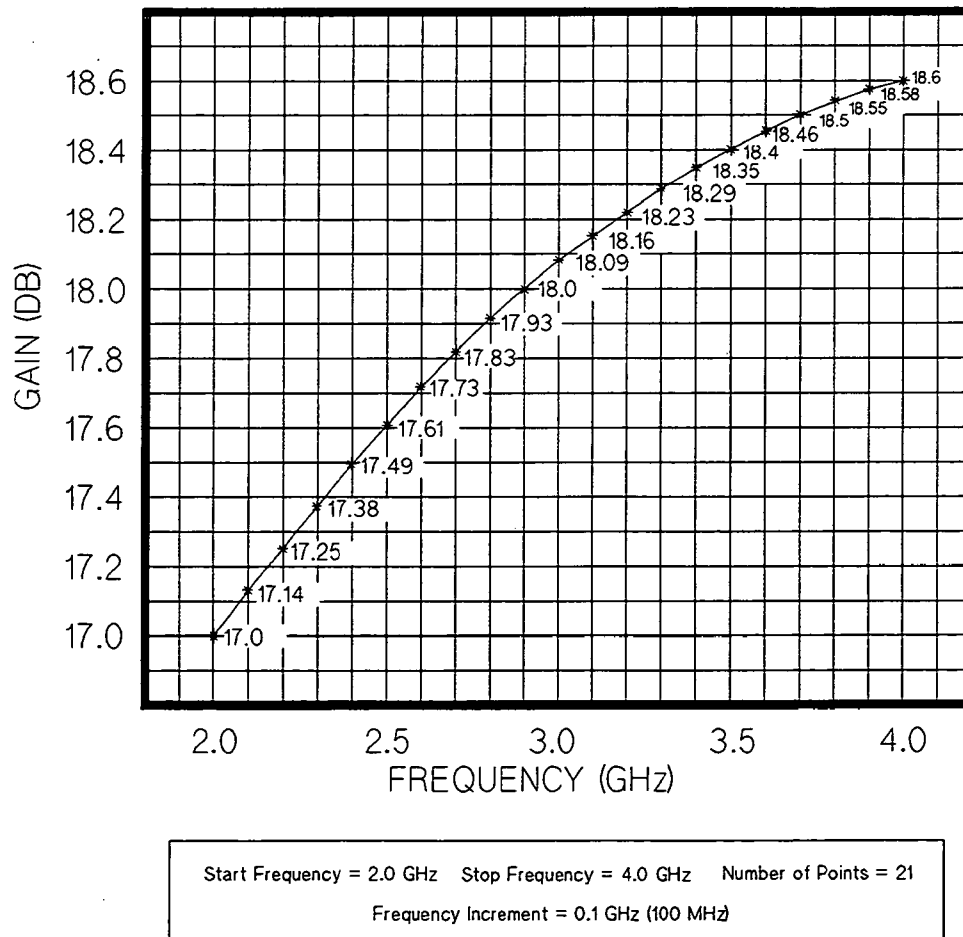

Figure 3-4. Typical Standard Gain Antenna Performance Graph

1. Choose the start and stop frequencies. Examples shown in Figure 3-4 are 2 and 4 GHz, respectively.

Creating a Standard Gain Antenna Cal Definition

2. Mark the graph at each frequency increment. In the example graph an increment frequency of 100 MHz is used. You **MUST** use evenly-spaced frequency points, "Even Frequency Increments" explains why.
3. On the graph for *your* standard antenna, determine the gain at each frequency increment. Figure 3-4 shows example gain values for 21 frequencies spaced 100 MHz apart.
4. Write down each gain value in ascending order corresponding to the frequencies they represent.

If Using Data in Table Format

Table 3-3 shows an example performance specification table:

Table 3-3. Example Standard Gain Antenna Performance Table

FREQ. (GHz)	GAIN dB	FREQ. (GHz)	GAIN dB	FREQ. (GHz)	GAIN dB
12.4	13.82	14.3	15.02	16.2	16.21
12.5	13.88	14.4	15.08	16.3	16.28
12.6	13.95	14.5	15.14	16.4	16.34
12.7	14.01	14.6	15.20	16.5	16.41
12.8	14.07	14.7	15.26	16.6	16.46
12.9	14.14	14.8	15.33	16.7	16.52
13.0	14.21	14.9	15.39	16.8	16.59
13.1	14.27	15.0	15.45	16.9	16.65
13.2	14.33	15.1	15.52	17.0	16.71
13.3	14.40	15.2	15.58	17.1	16.76
13.4	14.46	15.3	15.65	17.2	16.81
13.5	14.52	15.4	15.71	17.3	16.87
13.6	14.58	15.5	15.77	17.4	16.93
13.7	14.65	15.6	15.83	17.5	16.99
13.8	14.71	15.7	15.89	17.6	17.05
13.9	14.77	15.8	15.95	17.7	17.11
14.0	14.84	15.9	16.02	17.8	17.18
14.1	14.90	16.0	16.09	17.9	17.24
14.2	14.96	16.1	16.15	18.0	17.30

The example graph has 57 evenly spaced frequency points that are 100 MHz apart. You will simply enter these gain values into the ASCII data file. You **MUST** use evenly-spaced frequency points, "Even Frequency Increments" explains why.

Even Frequency Increments

The frequency increments in the antenna definition must be evenly spaced. If you look at the example on the next page you will see why: The lines between BEGIN and END hold the gain values. Notice that these lines do *NOT* specify the frequency of each gain value. Because of this, the calibration feature must calculate the actual frequencies given the defined start frequency, stop frequency and number of points. For this reason the antenna definition gain values must represent evenly spaced frequency values.

When you perform the actual calibration you can choose any frequency points you wish. A *calibration* can be performed at any frequencies you choose. The frequencies used in the cal do *not* have to be the same as the frequencies in the antenna definition. (When calibrating, the

Creating a Standard Gain Antenna Cal Definition

receiver will interpolate between frequency points in the definition.) Remember, however, that a *calibration* must contain *all* the frequencies required by your measurements. When *making measurements*, the receiver *does not* interpolate between *calibration points*.

Required ASCII File Format

The ASCII file must follow the CITIfile format supported by the HP 8530A. Figure 3-5 shows an example file for the data in Figure 3-4. At first the file looks complicated. However only the items pointed out in Figure 3-5 are variable. To save time, start by editing an existing calibration definition file. One is supplied on the Antenna RCS/Cal Disc, which was supplied with the receiver. The file name of the file is AC_NAR1.

The cal definition shown in Figure 3-5 contains only one antenna definition. A cal definition with *two* antenna definitions is shown in "Creating a Cal Definition with Multiple Antenna Definitions", later in this chapter.

```
CITIFILE A.01.01
#NA VERSION HP8530A.01.00
NAME ANTENNA_DEF
#NA DEF_LABEL 'uWaveA.1' ← Defines the antenna calibration softkey label.
#NA STANDARD 1 ← This is cal definition #1 (of seven possible).
#NA STANDARD_LABEL 'SASGH-1.10' ← Defines softkey label for this definition.
VAR FREQ MAG 21 ← Enter Number of Points here.
DATA GAIN[1] DB ← Enter Start stimulus value.
SEG_LIST_BEGIN ← Enter Stop stimulus value.
SEG 2000000000,4000000000,21 ← Enter Number of Points (again).
SEG_LIST_END
BEGIN
1.70E1
1.714E1
1.725E1
1.738E1
1.749E1
1.761E1
1.773E1
1.783E1
1.793E1
1.80E1
1.809E1
1.816E1
1.823E1
1.829E1
1.835E1
1.84E1
1.846E1
1.85E1
1.855E1
1.858E1
1.86E1
END
```

Enter gain values for each stimulus point.
"E1" indicates 10¹.

Figure 3-5. Typical Standard Gain Antenna Performance Graph

Creating a Standard Gain Antenna Cal Definition

In-Depth Description of a Cal Definition

The example below is of a cal definition that contains one antenna definition. The top four lines are the header for the entire file. These lines must only occur once, at the top of the file.

```
CITIFILE A.01.01
#NA VERSION HP8530A.01.00
#NAME ANTENNA_DEF
```

These three lines should be included exactly as shown. The firmware revision on line 2 "HP8530A.01.00" does *not* need to be changed if your HP 8530A has a later firmware revision. Keeping line 2 exactly as shown above is acceptable. These lines are part of the file header.

```
#NA DEF_LABEL uWaveA.1
```

This line defines the title for the antenna calibration softkey. You can change the label "uWaveA.1" to any label you want, up to the limit of ten characters. This line is part of the file header.

```
#NA STANDARD 1
```

This line starts defining the antenna definition. When creating several antenna definitions, the number "1" should be incremented (2, 3, and so on) for each successive antenna definition. "Creating a Cal Definition with Multiple Antenna Definitions" shows an example of this.

```
#NA STANDARD_LABEL SASGH-1.10
```

This defines the softkey label for this antenna definition. You can change the label "SASGH-1.10" to any label you want, up to a maximum of ten characters. It is recommended the label be changed to reflect the type and frequency range of the standard gain antenna.

```
VAR FREQ MAG 21
```

Enter the number of frequency points at the end of this line (where the number 21 is located in this example). The rest of this line always stays the same.

```
DATA GAIN [1] DB
```

This line does not affect the antenna definition in any way, but we recommend you leave it in. (Future firmware revisions may require this line.)

```
SEG LIST BEGIN
SEG 2000000000 4000000000 21
SEG LIST END
```

These three lines define the start frequency, stop frequency, and the number of points (again). Frequencies must be expressed in Hertz. Never change the first or third line.

```
BEGIN
1.70E1
1.714E1
1.725E1
```

```
1.855E1  
1.858E1  
1.86E1  
END
```

The commands "BEGIN" and "END" must surround the gain values for each frequency. Enter each gain value on a separate line. Gain values must be in ascending order corresponding to the frequencies they represent.

Saving the Cal Definition File

Save the ASCII file to MS DOS or HP LIF disc.

Note

The filename must begin with the three characters: AC_



(The two letters AC followed by an underscore character.)

Loading the Cal Definition into the HP 8530A

To load a cal definition file:

1. Insert the disc into the HP 8530A's drive.
2. Press **DISC** **LOAD** **CAL KITS** **ANTENNA CAL DEF**, the receiver will display a file directory of all cal definition files on that disk.
3. Use the knob to select the desired cal definition and press **LOAD FILE**.

Press **CAL**. Notice that the key **ANT. CAL** contains the name you chose for that cal definition.

Press **ANT. CAL** **FAR FIELD: RESPONSE**. You will see your antenna definition names next to the softkeys buttons.

Creating a Standard Gain Antenna Cal Definition

Creating a Cal Definition with Multiple Antenna Definitions

You can create up to seven antenna definitions in a single cal definition file. To do this, simply add one antenna definition right after another in the file. Do not repeat lines 1 through 4. Change "STANDARD 1" to "STANDARD 2" in the second antenna definition, to "STANDARD 3" in the third, and so on.

Change the label in the "#NA STANDARD LABEL" line in each antenna definition. Use labels that are appropriate for each standard gain antenna. Do not use underscore _ characters in labels. To avoid problems use keys A through Z, numbers 0 through 9, and dashes (-).

Here is an example of two antenna definitions in one file.

```
CITIFILE A.01.01
#NA VERSION HP8530A.00.26
NAME ANTENNA_DEF
#NA DEF_LABEL uWave A.1
#NA STANDARD 1
#NA STANDARD_LABEL SASGH-1.10
VAR FREQ MAG 10
DATA GAIN[1] DB
SEG_LIST_BEGIN
SEG 1100000000 1700000000 10
SEG_LIST_END
BEGIN
1.63E1
1.64E1
1.65E1
1.66E1
1.67E1
1.68E1
1.685E1
1.69E1
1.7E1
1.71E1
END
#NA STANDARD 2
#NA STANDARD_LABEL SA12-1.70
VAR FREQ MAG 10
DATA GAIN[1] DB
SEG_LIST_BEGIN
SEG 1700000000 2600000000 10
SEG_LIST_END
BEGIN
1.61E1
1.62E1
1.64E1
1.65E1
1.67E1
1.68E1
1.69E1
1.7E1
1.71E1
1.72E1
END
```

When you load this file into the receiver, these two antenna definitions will go into top two Far-Field:Response menu positions.

Details on the Supplied Antenna Definitions

The supplied cal definition contains seven Narda antenna definitions. This cal definition is *not* loaded into receiver memory at the factory. Refer to Table 3-4. Only one cal definition file can be loaded into the receiver at one time.

The Narda cal definition file is supplied on the Antenna/RCS Cal Disc, under the file name: AC_NAR1. The Antenna/RCS Cal Disc is DOS compatible. The file AC_NAR1 has two uses:

- You can load AC_NAR1 into the HP 8530A.
- You can make copies of the file and modify them to create your own definitions.

Table 3-4. Antenna Definitions in the Supplied Cal Definition

Definition Name	Manufacturer	Model Number	Frequency Range
NAR 645	Narda	645	1.70 to 2.60 GHz
NAR 644	Narda	644	2.60 to 3.95 GHz
NAR 643	Narda	643	3.95 to 5.85 GHz
NAR 642	Narda	642	5.40 to 8.20 GHz
NAR 640	Narda	640	8.20 to 12.40 GHz
NAR 639	Narda	639	12.40 to 18.00 GHz
NAR 638	Narda	638	18.00 to 26.50 GHz

The most recently-loaded cal definition is saved in non-volatile memory, and is retained when you turn AC power OFF.

HP 8530A Automated Measurements

This document introduces you to HP 8530A automated measurements.
Automated operation consists of two major categories:

Remote Programming	This is an introduction to controlling the receiver with a computer.
High Speed Operation	(Fast CW mode) This section explains how to acquire data at up to 5,000 points per second using the 100,000 point data buffer. This material is written for programmers, and contains programming examples.

Contents

Remote Programming

- ◆ What is Remote Programming?
- ◆ What this Section Explains
- ◆ Transferable Data
- ◆ Available Data Transfer Formats

High Speed Automated Operation (Fast CW and Fast IF Switching)

- ◆ CW Configuration
- ◆ Multiple Frequency/Switch Control Configuration
- ◆ What is Fast CW Mode?
- ◆ Description of Fast CW Modes
- ◆ Which Parameter is Measured in Fast CW Mode?
- ◆ How to Transfer Fast CW Data
- ◆ Facts about Overall Measurement Speed
 - Switch Speed
 - Frequency Switching Speed
 - Receiver Raw Data Acquisition Speed
 - Data Transfer Speed
 - Is Data Acquisition Synchronous with Data Transfer?
 - Transfer Speed Reduction Caused by Computer or HP-IB Extenders
- ◆ Limitations
- ◆ How Averaging Works with the Fast CW Buffer
- ◆ Frequency Relationship Between RF and LO Source
- ◆ Timing Considerations
- ◆ Changing Minimum Re-Trigger Time
- ◆ Standard Fast CW Mode
- ◆ Fast Data Collection Mode
- ◆ Autoranged Data Collection Mode
- ◆ Fast IF Multiplexing
- ◆ Using Fast IF Multiplexing Mode
- ◆ Operating Notes and Driver Circuitry Requirements

HP BASIC Fast CW Programming Examples

HP BASIC Fast IF Multiplexing Mode Programming Example

Remote Programming

What is Remote Programming?

"Remote programming" describes computer-controlled receiver operation. The receiver can be ordered to make measurements, change settings, send data to the computer, or accept data from the computer. Data that can be sent back and forth includes measurement data, calibration coefficient sets, and so on. You can remotely use all front panel features, and more.

Remote programming is often called "HP-IB operation" or "HP-IB programming." Commands should be given in the same order as the equivalent front panel keystrokes.

What this Section Explains

This section briefly describes the main features of remote programming. "HP-IB Programming" in the *HP 8530A Operating and Programming Manual* explains remote programming in detail. The *HP 8530A Keyword Dictionary* lists all programming (HP-IB) codes, and explains each command in detail.

Transferable Data

After making a measurement, you can send **raw**, **corrected**, or **formatted** measurement data to the computer. These arrays represent different stages of data processing, illustrated Figure 1. There are two entirely different, parallel, data processing paths. One path is for Channel 1 and one is for Channel 2. Each channel has raw, corrected, and formatted data arrays. In fact, you can modify the data using the computer, and send it back into the array. The receiver will process the modified data through all following stages.

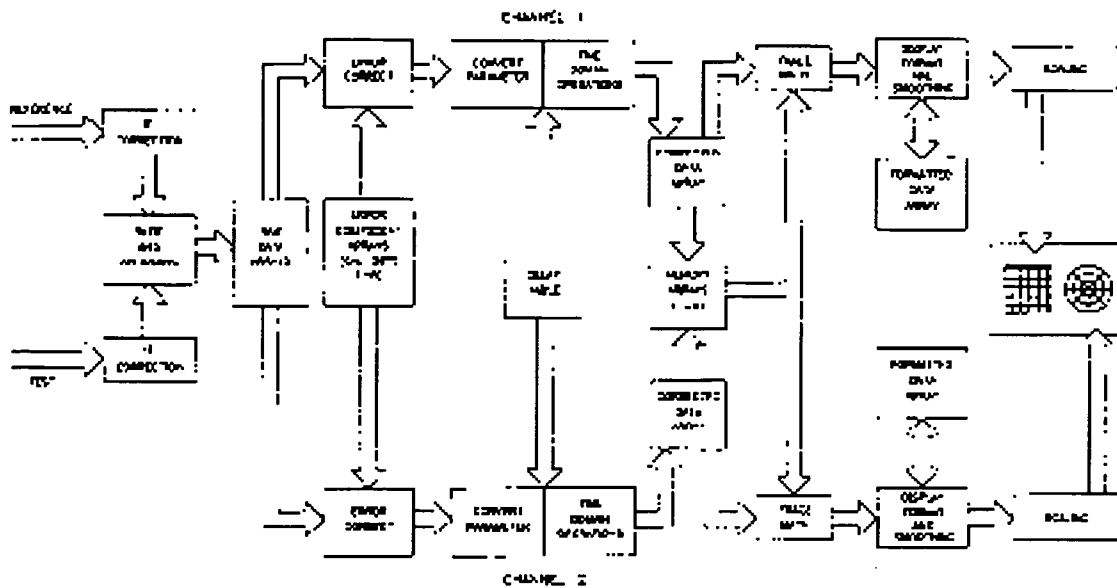

Figure 1. Data Processing Stages in the Receiver

The following data arrays can be read by an external computer:

Table 1. Data Types

Raw Data	This data array contains the ratioed and averaged measurement data results. (Note: In Fast CW mode, raw data is the only available format.) To transfer the data from this array to the computer, use the HP-IB command <code>OUTPRAWn</code> , where <i>n</i> is the desired parameter (1, 2, 3 or 4). The <code>INPURAWN</code> command sends data from the computer into the desired raw array. The raw array data is in real,imaginary pairs. Refer to <i>the HP 8530A the Keyword Dictionary</i> for syntax and other information on this command, and the commands mentioned below.
Corrected Data	In addition to ratioing and averaging, corrected data has been through time domain and calibration processing. Remember that these features must be ON to affect the data. To transfer data from this array to the computer, use the HP-IB command <code>OUTPDATAN</code> , where <i>n</i> is the desired parameter (1 to 4). The <code>INPUDATAN</code> command sends data from the computer into the desired corrected data array. The corrected data array is in real,imaginary pairs.
Formatted Data	This data is scalar (magnitude-only) and reflects display format, scaling, and trace math processing. To transfer data from this array to the computer, use the HP-IB command <code>OUTPFORMn</code> , where <i>n</i> is the desired parameter (1 to 4). The <code>INPUFORMn</code> command sends data from the computer into the desired corrected data array. Formatted data is a simple integer that represents the data units shown on the display.
Calibration Coefficients	These are the error correction coefficients created during calibration (also called a "Cal Set"). The error coefficient arrays can be read from, or sent to a computer, just like the arrays described above. Refer to the descriptions for the <code>OUTPCALC</code> and <code>INPUCALC</code> commands in the <i>HP 8530A the Keyword Dictionary</i> .
Delay Table	Each parameter has its own special array called a "delay table." The table can be retrieved by external computer, modified, then returned to the receiver. The receiver will process the modified data as if it were actual measured data. The table contains real/imaginary data pairs in the internal Form 1 compressed format. A typical use is to modify frequency domain data to synthesize a special window shape for use in time domain RCS measurements. Refer to the descriptions for the <code>OUTPDELA</code> and <code>INPUDELA</code> commands in the <i>HP 8530A the Keyword Dictionary</i> .
Memory Data	Valid data can be read from this array <i>if data has been stored to memory</i> . Refer to the descriptions for the <code>OUTPMEMO</code> command in the <i>HP 8530A the Keyword Dictionary</i> . (There is no command to send data directly into a memory from the computer. However, you can send data to the raw or corrected array, then save it to memory using <code>DATI</code>)

Available Data Transfer Formats

In remote programming you can choose among four binary data formats, or one ASCII data format. The formats are listed below:

Table 2. Available Data Transfer Formats

Form 1	This is the native internal data format of the receiver. Each point of data contains a header byte, followed by three, 16-bit words. Form 1 offers very fast transfer speeds, and Form 1 data can be converted to floating point data in the computer. If you use Fast CW mode, the only data format available is Form 1. In fast CW mode, Form 1 does not have the header information.
Form 2	32-bit IEEE 728 format. This format is not commonly used.
Form 3	This is the recommended format for use with HP 9000 Series 200/300 workstations. It consists of a header, a two-byte number indicating how many bytes follow, then the real and imaginary data pairs for each stimulus point. Form 3 follows the 64-bit IEEE 728 standard format.
Form 4	This format is ASCII.
Form 5	This is the recommended format for use with IBM PCs and compatibles. This is a 32-bit DOS-compatible floating point format.

Refer to the Keyword Dictionary under "Form1," "Form2," "Form3," "Form4," or "Form5" for more detailed information.

High Speed Automated Operation

Fast CW mode is a feature that optimizes HP 8530A data acquisition speed. There are two major system configurations that use Fast CW modes:

- ♦ Single Frequency Configuration
- ♦ Multiple Frequency Configuration

These configurations are described on the following pages.

Note about Markers

If you are making computer-controlled measurements using "normal" sweep modes (Frequency List, Single Point, Ramp, Step, Single Angle, or Swept Angle); measurement speed will increase with markers turned OFF. Markers will not slow down Fast CW measurements.

Single Frequency Configuration

This configuration uses the HP 8530A, RF and LO sources, and a controlling computer. Only CW measurements are possible.

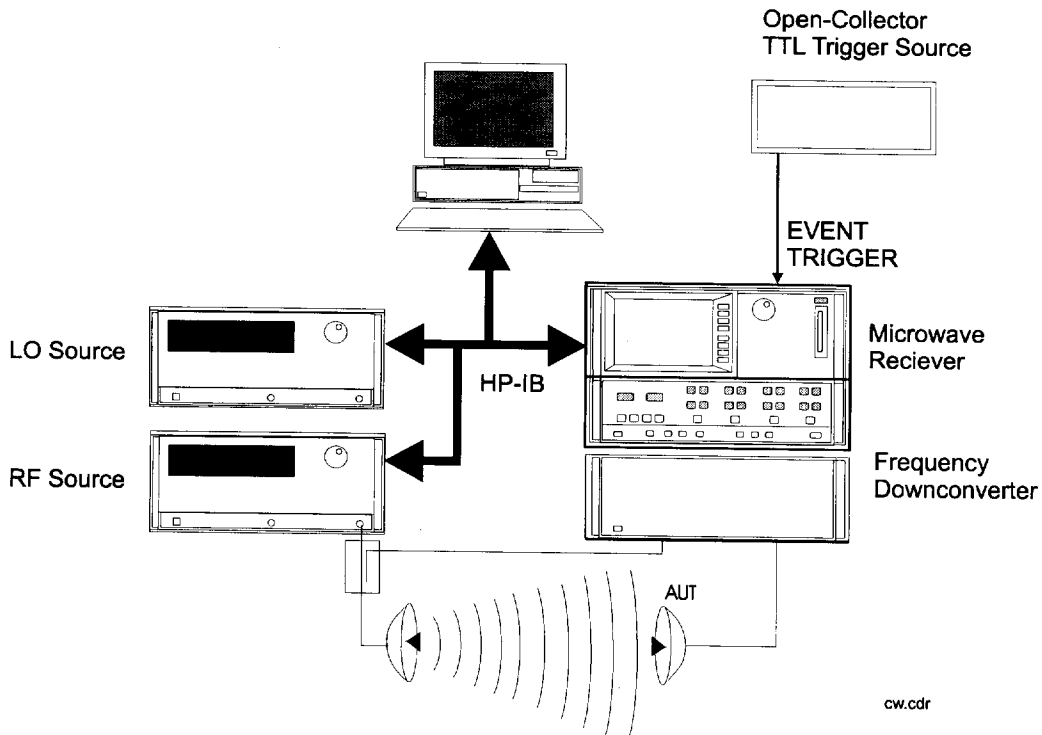

Stage	Description
1	The computer selects the frequency of measurement, RF power, and other measurement settings.
2	Open-collector TTL measurement triggers are asserted on the HP 8530A EVENT TRIGGER input. A measurement is taken for each negative-going TTL trigger. This data is stored in the HP 8530A 100,000 point FIFO buffer. The HP 8530A can acquire data at speeds between 1650 and 5000 points per second, depending on the selected fast CW <i>mode</i> , and whether data is being <i>transferred</i> at the same time. More is explained on this issue later. Data <i>acquisition</i> occurs independently of data <i>transfer</i> . There are situations where you can have very fast data acquisition, but a slow data transfer rate could be slowing the overall speed of the system. More on this topic is explained later.
3	The computer executes a command such as the HP BASIC TRANSFER command. This reads one data point out of the buffer. Again, situations can occur where the speed of transfer can be slower than the actual data acquisition.

Multiple Frequency/Switching Configuration

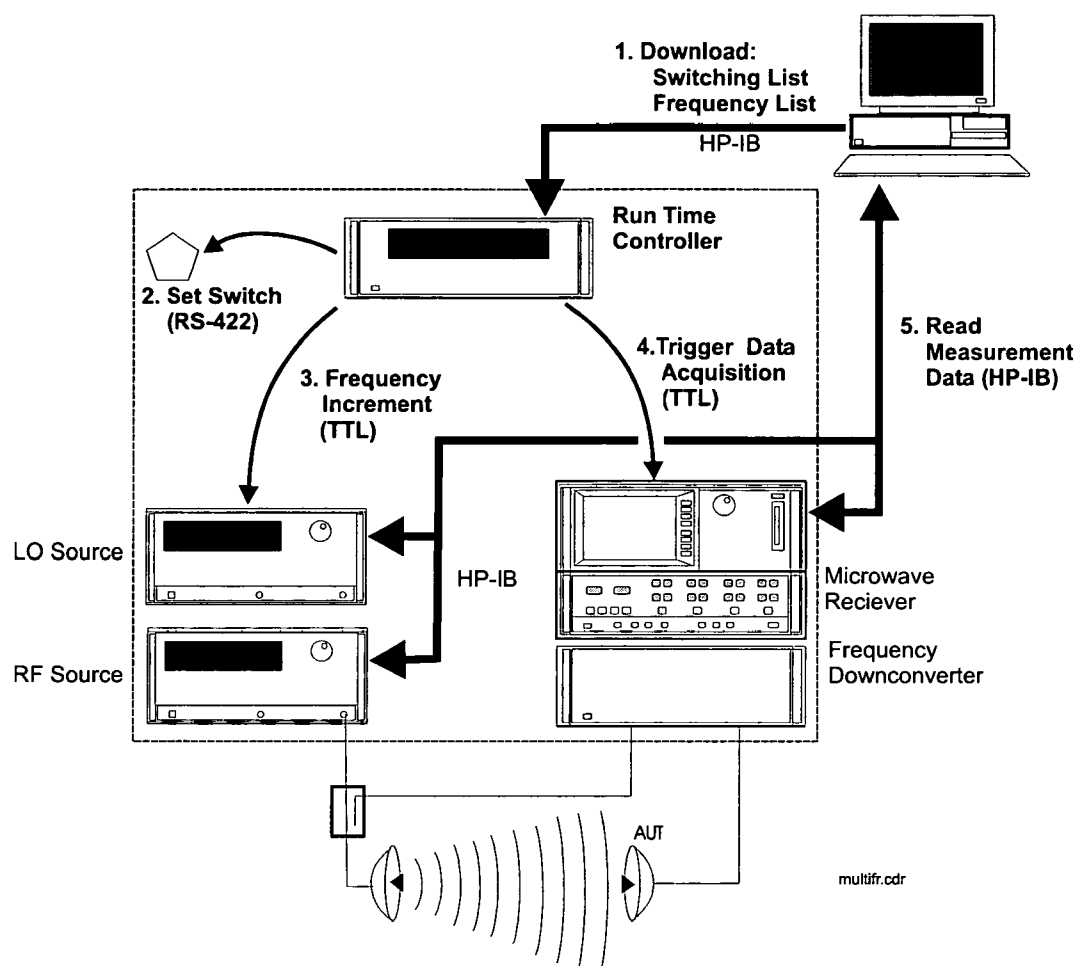

Stage	Description
1	The computer sets source power levels, and other settings to the RF/LO sources, and microwave receiver.
2	The computer downloads a frequency list and switch channel list to the HP 85330A run time controller.
3	The computer places the HP 85330 into run-time mode.
4	The HP 85330A sets the first switch position.
5	The HP 85330A increments the frequency of the RF and LO sources using high speed TTL lines. (Does not occur on the very first measurement)

6 Refer to Figure 6-2 in the HP 85330A Manual.

**If using HP 85330A TTL trigger mode
(RUNt:EVENT:TRIGger TTL):**

The HP 85330A waits for a TTL trigger on its EVENT TRIGGER input.

**If using HP 85330A IMMEDIATE trigger mode
(RUNt:EVENT:TRIGger IMM)**

No input on the HP 85330A EVENT TRIGGER line is required. Data is acquired immediately (refer to step 7).

Using Time Delays:

A time delay can be set for switch settling time using the HP 85330A command RUN:SWIT:DEL.

If you need a time delay before *any* data acquisition, use the HP 8530A FASPARMTIME command.

7 At this time the HP 85330A sends a trigger to the HP 8530A EVENT TRIGGER input. The data is acquired and stored in the HP 8530A 100,000 point FIFO buffer. The HP 8530A can acquire data at speeds between 1650 and 5000 points per second, depending on the selected fast CW *mode*, and whether data is being *transferred* at the same time. More is explained on this issue later. Data *acquisition* occurs independently of data *transfer*. **There are situations where you can have very fast data acquisition, but a slow data transfer rate could be slowing the overall speed of the system.** More on this topic is explained later.

8 The computer executes a command such as the HP BASIC TRANSFER command. This reads one data point out of the buffer. Again, situations can occur where the speed of transfer can be slower than the actual data acquisition.

What is Fast CW Mode?

The HP 8530A provides two primary methods allowing extremely fast antenna, RCS, or CW frequency measurements:

- ♦ Fast CW mode (there are four types of Fast CW mode to choose from.
- ♦ An optional fast pulse mode is available in HP 8530A H02

Fast CW modes are explained in this section. Fast Pulse is described in the HP 8530A H02 manual.

There are actually four standard "Fast CW" modes:

- ♦ Standard Fast CW
- ♦ Fast Data Collection
- ♦ Autoranged Data Collection (most commonly used)
- ♦ Fast IF Multiplexing

Fast CW modes are only available when you are controlling the receiver with a computer. These modes buffers measurement data in a 100,000 point (First-In First-Out) data buffer. Each of these modes is explained below.

Description of the Fast CW Modes

All the Fast CW modes can be externally triggered, using the (TTL) EVENT TRIGGER input - or over HP-IB.

Table 3. Description of Fast CW Modes

Standard Fast CW	<p>Measures at rates of up to 5,000 data points per second. This speed is not sustainable continuously. The reason: at this speed, data is not being transferred out of the instrument. Once the 100,000 point FIFO buffer is full the data must be transferred out. Fast CW can sustain a continuous transfer speed of 3,333 points per second.</p> <p>Burst data acquisition speed: 5,000 points per second Sustained data acquisition speed: 3,333 points per second Handshaking: NO</p> <p>The allowable point-to-point amplitude variation of the measured signal is ± 12 dB. If you have point-to-point variations greater than ± 12 dB, use the Autoranged Data Collection feature, described below.</p>
Fast Data Collection	<p>This mode is similar to the Fast CW mode, but has one more feature: It pulls the rear panel STOP SWEEP and RECEIVER READY lines LOW during data acquisition. These lines go HIGH when the receiver is ready to take more data. Trigger pulses are ignored when STOP SWEEP is LOW. This "handshake" allows external hardware to coordinate measurements.</p> <p>Burst data acquisition speed: 4,000 points per second Sustained data acquisition speed: 3,333 points per second Handshaking: STOP SWEEP and RECEIVER READY Adjacent Point to Point Power Variation: ± 12 dB</p> <p>This mode is recommended when measuring signals that make sudden changes in amplitude, with an upper limit of ± 12 dB between two adjacent measurement data points. (A typical application for this mode is when a multiplexer is used to switch between antennas.)</p>

**Autoranged
Data
Collection**

Use this mode if signal levels vary by more than ± 12 dB between **adjacent** points. This mode allows you to accurately measure signals across the full dynamic range of the receiver. This is the mode used when in TURBO MODE in the ORBIT/FR 959 software, and all near-field measurement software produced by Nearfield Systems Inc.

Burst data acquisition speed: 2,500 points per second
Sustained data acquisition speed: 2,500 points per second
Handshaking: STOP SWEEP and RECEIVER READY
Adjacent Point to Point Power Variation: Full dynamic range of receiver

This mode is recommended when measuring signals that make sudden changes in amplitude between adjacent measurement points. The signal can change any amount, up to the maximum dynamic range of the receiver. (A typical application for this mode is when an external PIN multiplexer is used to switch between antennas. Or when measuring multiple inputs from a co-polarized and cross-polarized antenna.)

**Fast IF
Multiplexing
Mode**

This mode switches between up to four measurement *ratios* internally to the receiver. This can eliminate the need for pin switches (and the required VXI controller) in systems measuring up to three *test signals*.

Burst data acquisition speed: 4,000 points per second
Sustained data acquisition speed: 3,333 points per second
Handshaking: STOP SWEEP and RECEIVER READY

The ratios available are: $b1/a1$, $b2/a1$, $b1/a2$, $b2/a2$. Up to four ratios can be measured in a predetermined automated sequence.

You can choose to trigger once for all ratios, or require a trigger for each ratio measured.

**Fast Pulse
Mode
(Optional)**

This mode only exists in the pulse compatible HP 8530A H02. Turbo mode systems also require an H02 or H03 version of the HP 85330A. This mode allows pulsed measurements at rates that are faster than non-turbo measurements.

Burst data acquisition speed: 1,650 points per second
Sustained data acquisition speed: 1,650 points per second
Handshaking: STOP SWEEP and RECEIVER READY

This mode is discussed in detail in the HP 85330A H02 manual.

Special Note on Averaging

To make averaging work in wideband mode, you have to set the multiple source offset value to 20.000017 MHz instead of 20 MHz. This setting will work for normal bandwidth measurements as well.

Perform the following steps:

Press:

[SYSTEM] {MORE} {EDIT MULT. SRC.}
{RECEIVER} {OFFSET FREQUENCY} 20.000017 [MHz]
{MULT. SRC. ON / SAVE}

Averaging only functions in ratioed measurements, not when viewing individual service channels.

To use high speed operation you must have a basic understanding of instrument HP-IB programming.

Which Parameter is Measured in Fast CW Mode?

If you have HP 8530A firmware revision 1.40 or above, you can measure 1 to 4 different input ratios in Fast CW Mode.

How to Transfer Fast CW Data

There are two ways to transfer data when using Fast CW mode:

Table 4. Data Transfer Methods

Burst Transfer	<p>You can fill the buffer, partially or completely, then transfer it using the HP BASIC <code>ENTER</code> command. The receiver can measure up to 5,000 points per second while the buffer is being filled. Data can then be transferred out of the receiver at an HP-IB rate of approximately 5,000 points per second. This mode usually does not save time because you have to stop making measurements while the buffer's contents are transferred. This mode can save time if:</p> <ul style="list-style-type: none">·The scan you are making has fewer than 100,000 data points, AND·There is a dead time during which you're positioner must move before more measurements are taken. Data is transferred out at around 5,000 points per second in all modes. <p>Example 1. Assume you took 10 seconds of data in the FASC mode (5,000 points per second), it would take at least 10 seconds to transfer the data.</p> <p>Example 2. Assume you used FASAD (most commonly used mode) and took data for 30 seconds (2,500 points per second). You could have the data transferred out in about 15 seconds).</p> <p>If using another programming language, simply wait until the measurement is finished, then transfer the data. For example, at the end of the positioner's sweep, or at the end of a near field scan line.</p>
Continuous Transfer	<p>You can transfer data to your computer continuously using the HP BASIC <code>TRANSFER</code> command. Using this method, data can be taken for as long as desired with out ever filling up the data buffer.</p> <p>If using a another programming language, use the appropriate command to transfer after each data point is measured.</p>

Facts about Overall Measurement Speed

When determining the speed of a system, people often look at the raw performance of the microwave receiver, and stop there. It is important to know that the raw measuring speed of the receiver is not the only factor involved! Other factors include:

- ♦ **The speed of any switches in the system.**
- ♦ **The frequency switching speed.** Note that sources take longer to cross band switching boundaries. Also, HP 8360 series sources execute a "learn sweep" on the first sweep (or after any source frequency settings are changed). This first sweep takes much longer than subsequent sweeps.
- ♦ **Computer, HP-IB extenders, or HP-IB cards.** For example, HP-IB extenders set to slow mode *anywhere in the system* can slow measurement speeds.
- ♦ **Measurement Software** can affect measurement speed as well. This is usually out of the control of Hewlett-Packard.

You can see that there are other important considerations when estimating the speed at which a system can make measurements.

Switch Speed

PIN switches are solid-state, and switch so fast that they have little impact on measurement speed. You should also calculate any delays needed by your device under test.

If you are using third party software to control the system, it will usually have a switch delay command. If you are writing your own code, you would use the HP 85330A's RUNTime:SWITch:DELAy command. This is described in the HP 85330A manual. For Fast CW modes, 2 us delay is recommended.

For example, Line 1090 in Programming Example 1 uses two microseconds as the switch delay:

```
1090 OUTPUT @HP 85330;"RUNT:SWIT:DEL 2;"
```

Mechanical switches require between 15 to 50 ms to switch. Find out the switching speed of the switch you are using, and set switch delay as explained above.

Frequency Switching Speed

The first sweep using HP 8360 sources is slower than usual: In step or list mode, the first sweep through the frequency list is *much* slower than subsequent sweeps. During the first sweep, the source is in learn mode, where it stores a lookup table of pretune settings.

The learn sweep is repeated if any frequency settings are changed.

Recommendation: If developing your own software, run through the frequency list once before initiating measurements

Source settling time affects phase and amplitude accuracy: Sources require a certain amount of settling time. Sources have frequency bands, and it takes longer when a bandcrossing is encountered.

When the Frequency Change is:	The Change Takes this Long:
CW manual mode, Inside a band	15ms + 5ms / GHz
All modes, at a bandcrossing	<i>approximately 50 ms</i>
Step or List mode, in band	5 ms +5ms / GHz

The exact magnitude and phase accuracy after this minimum settling time is not specified or documented.

Receiver Raw Data Acquisition Speed

The data acquisition speed of the HP 8530A microwave receiver is of significance in the overall measurement speed of the system. However, this is *not* the *only* consideration when determining the overall measurement speed of your system. *Do not assume your system will perform at these raw data acquisition speeds.*

Burst transfer: only stores data in the HP 8530A 100,000 FIFO buffer. This speed is only possible when data is not being transferred to the computer.

Continuous transfer: is the maximum data acquisition speed when data is being transferred to the computer concurrently with data acquisition.

Fast CW mode Speeds

Mode	Burst Transfer Data Acquisition Speed	Continuous Transfer Data Acquisition Speed
Fast CW	0.2 ms/data point 5,000 points/second	0.3 ms/data point 3,333 points/second
Fast Data Acquisition	0.25 ms/data point 4,000 points/second	0.3 ms/data point 3,333 points/second
Autoranging Fast Data Acquisition	0.4 ms/data point 2,500 points/second	0.4 ms/data point 2,500 points/second
Fast Multiplexing Mode	0.25 ms/data point 4,000 points/second	0.3 ms/data point 3,333 points/second
Fast Pulse Mode (optional)	0.6 ms/data point 1,666 points/second	0.6 ms/data point 1,666 points/second

Data Transfer Speed

As mentioned before, data acquisition speed is only one factor in overall measurement speed. Another important factor is the actual transfer speed of the data to the computer controller. The following can affect transfer speed:

HP-IB Extenders	Speed decreases : 1. As range Length increases. 2. If more than two extenders are in the same chain. 3. If extenders on the main HP-IB bus are set to slow mode. Much more detail is provided on the following pages.
Computer Speed	A slow computer, or one that is multi-tasking with other processes, could slow transfer speed.
HP-IB Card Speed	Potentially, an old HP-IB card could affect transfer speed.

Is Data Acquisition Synchronous with Data Transfer?

This depends on the software in use. HP examples assume that the HP equipment is being triggered by a hardware pulse (from a positioner system for example). In this case the data acquisition process is asynchronous with data transfer. If you are writing your own software, be sure that you do not let the 100,000 point buffer overflow. This could happen if acquisition speed is greater than transfer speed.

Third party software often keeps track of the entire measurement process, and usually triggers the HP hardware over HP-IB. This makes the two processes synchronous.

Measurement Software

Third party measurement software can also have a significant affect on measurement speed. Discuss measurement speed with the software supplier.

Speed Reductions Due to Computer Controller or HP-IB Extenders

The computer controller or HP-IB bus can limit data transfer speed.

Computer-Caused Speed Reductions

The computer's data transfer rate may be slower than the receiver. If you plan to use continuous transfer, do some tests to see if your computer slows down the transfer process. (If fewer than 3,333 points/second are transferred, your computer or the HP-IB bus is the limiting factor.)

HP-IB Extender-Caused Speed Reductions

HP-IB extenders can slow down measurements significantly in Fast CW modes. You will see speed reduction in the following situations:

HP-IB Speed Degrades If:	Recommendations
There are more than two extenders on a single chain.	Use separate chains of 2 each. This applies to all extender types, Fiber Optical or Coax.
If HP-IB extenders are set to SLOW mode.	Many users know that HP-IB extenders must be in slow mode if they are placed on the HP 8510/30 Local bus. In fast CW modes, sources are not on the local bus - they are on the main HP-IB bus. The slow mode restriction does not apply in this case! Use the extenders in FAST mode unless extenders are >250 meters apart. (This limitation does not apply to fiber optical extenders.) Use optical extenders if range length is greater than 250 meters.

Always Use Slow Mode when Using HP-IB Extenders are on the HP 8530 Local Bus

In manual measurement configurations, sources are controlled over the 8530 Local Bus. If you put HP-IB extenders on the local bus, they *must* be set to SLOW mode. This will not affect manual measurement performance.

How Bus Extenders Slow Down Measurements

When you connect a slow HP-IB device to the bus **all activity** on the bus slows to match the speed of the slowest device. SLOW mode drastically cuts the speed of the entire HP-IB bus. This slows the data transfer from the HP 8530A to the computer. This in turn slows down the overall measurement speed of the system.

HP-IB Extender Performance

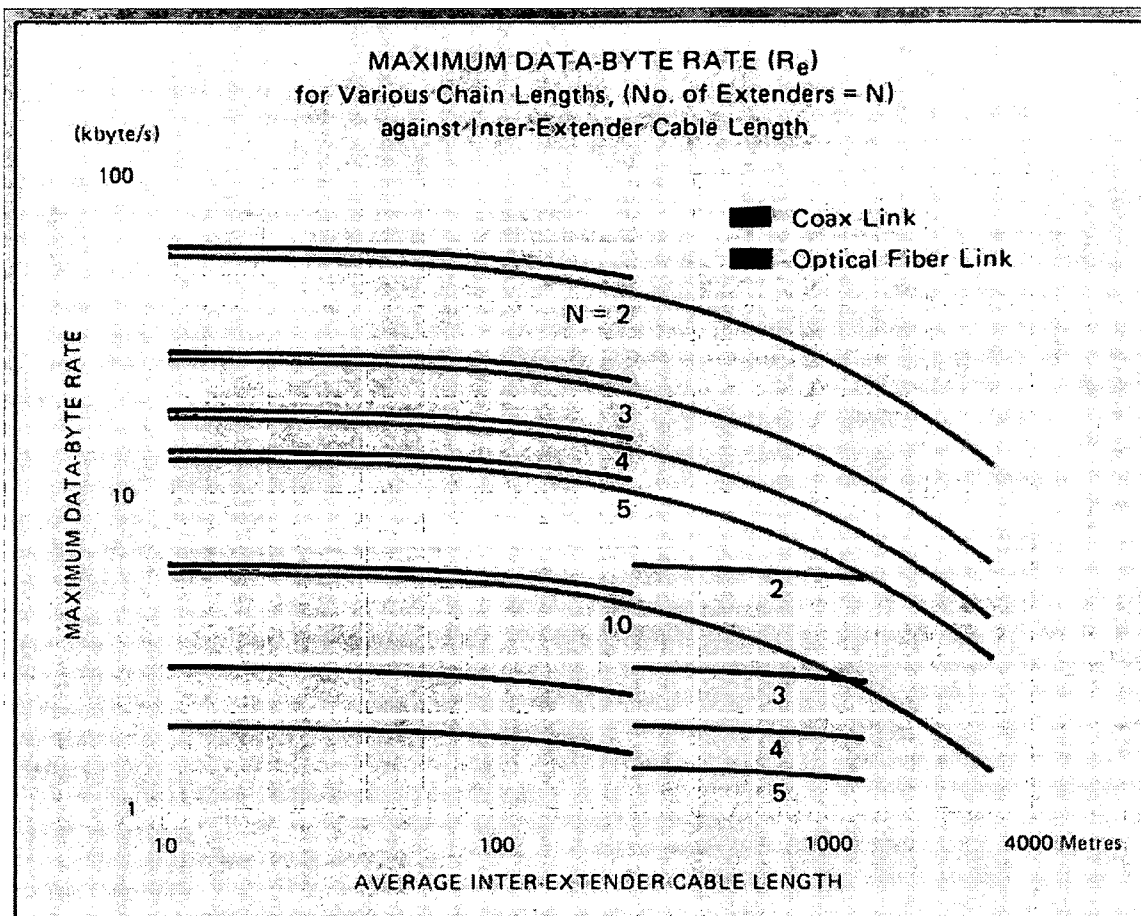

Limitations

Fast CW operation allows you to measure data at very fast rates. The following measurement limitations apply when measuring 5,000 points per second:

If you have firmware revisions below 1.40, only one parameter in the receiver may be measured (the active parameter). For multiple parameters, an external PIN multiplexer must be used, or you must upgrade the firmware. Firmware upgrades are easy to arrange, simply contact your local HP representative.

- ◆ Only raw data is available (raw data includes averaging) in Form 1 data format.
- ◆ To take advantage of 5,000 points/second, data must be stored in the 100,000 point buffer.
- ◆ The allowable point-to-point magnitude variation is ± 12 dB, otherwise you must use Autoranged Data Collection mode (2,500 points/second). Autoranged Data Collection is often needed if you externally multiplex between different antennas or antenna outputs. This is due to the sudden amplitude changes that often occur in such systems.

How Averaging Works with the Buffer

Averaging occurs before data is stored in the buffer. Only the final, averaged, values are stored. Therefore, using averaging does not increase the amount of data stored in the buffer, nor does it increase required transfer time.

Example: Assume you are measuring a ± 90 degree angle scan with an increment angle of 0.5 degrees (a total of 361 angles measured). Averaging is set to 16.

Because averaging is set to 16, the receiver must measure each angle 16 times. This means 5,776 individual measurements must be made (16 x 361). However, the data buffer does *not* store each averaging measurement, *it only stores the final averaged value for each angle*. Therefore, only 361 buffer points are used in the measurement.

In buffer mode, 5,776 points of measured data require 1.16 seconds to take. This data is averaged, and the 361 resultant data points are stored in the buffer. It will take 0.08 seconds to transfer 361 data points (remember, this time estimate can be affected by the speed of your computer).

Frequency Relationship between RF and LO Source

If you are writing your own software, **be sure LO frequency is always 20 MHz above the RF frequency**. If LO frequency is below the RF, the phase of your measurements will be reversed from normal. For example, lengthening electrical length will cause a clockwise phase rotation.

Timing Considerations

If you are using External triggering, a trigger pulse at least 1 us wide must be sent to the rear panel EVENT TRIGGER input.

The pulse width must be 1 us to 100 us. A 1 us pulse is recommended.

The receiver triggers on the falling edge of the trigger pulse. The trigger pulse should be a negative pulse that is normally high. Refer to the “Negative Trigger Pulse” figure below. If a positive pulse is used the receiver will not trigger until the falling edge of the trigger is detected. This will cause a delay in the trigger as shown in the “Positive Trigger Pulse” figure below:

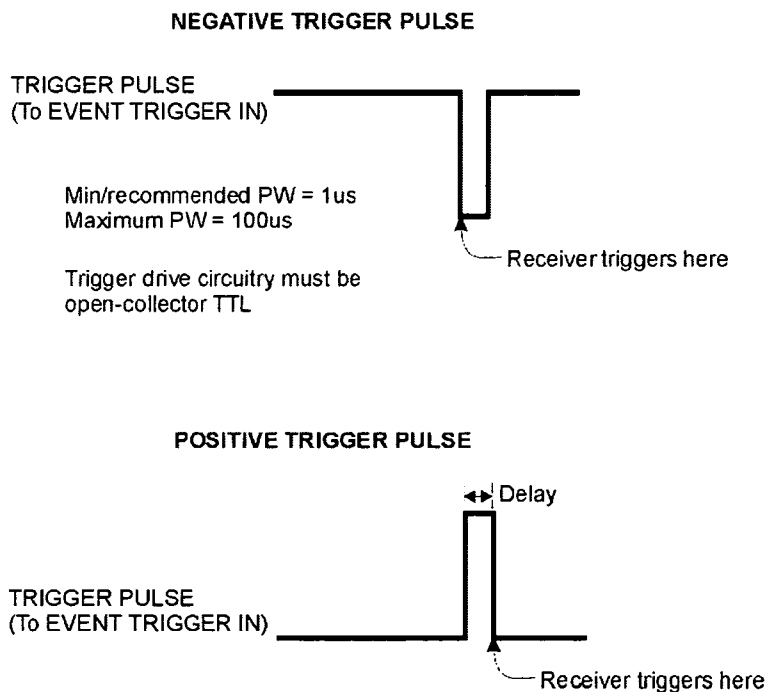

When the STOP SWEEP is low in the FASD, FASAD and FASMD modes the signal level being measured must remain at a constant level after the trigger is sent to the receiver. The FASC mode requires the signal level remain constant for 200 us after the trigger is received.

If averaging is turned ON the measurement time will be increased by 200 us for each average. For example, in FASD mode with eight averages, the total measurement time will be 1600 us. The STOP SWEEP will remain low for the entire measurement time.

Changing Minimum Re-Trigger Time

To change the default re-trigger time for Fast CW modes FASD, FASMD, and FASAD, send the HP-IB command `FASPARMTIME n` , where n is the desired time interval (in microseconds) before STOP SWEEP goes HIGH. The minimum time allowed in this command is 200 us, maximum time is 1360 us.

Standard Fast CW Mode

HP-IB Command: FASC

Standard Fast CW will measure data at rates up to 5,000 points per second. The amplitude variation between any two adjacent measured points must be within ± 12 dB.

Refer to the figure below. When the trigger is received, the receiver waits 70 μ s, which is equal to the IF delay of the receiver, and then latches (measures) the data. The receiver is ready to take another data point after 200 μ s. There is no handshaking performed on the STOP SWEEP or RECEIVER READY outputs. Any trigger received before the HP 8530A is ready will be ignored.

The HP-IB Command `FASTPARMTIME` can be used to delay the data acquisition longer than 200 μ s.

Timing

Standard Fast CW Mode (FASC)

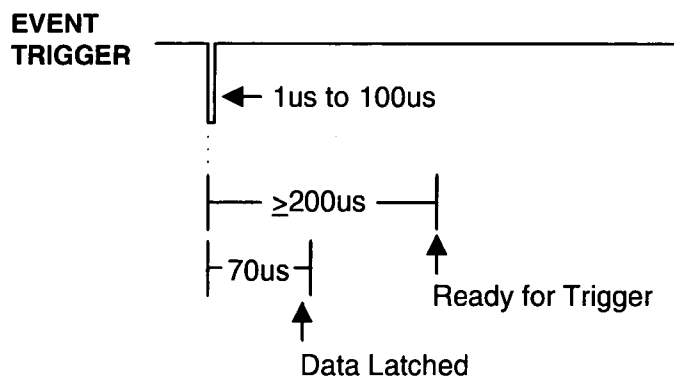

fasc.vsd

Fast Data Collection Mode

HP-IB Command: FASD

Note: All references to STOP SWEEP in this section also apply to the RECEIVER READY line, which could be used instead.

Handshaking

This mode is similar to the Fast CW mode, but has one more feature: It pulls the STOP SWEEP line (rear panel BNC) LOW during data acquisition. (The figure only shows STOP SWEEP). These lines go HIGH when the receiver is ready to take more data. Any trigger pulses received when STOP SWEEP is LOW causes a "TRIGGER TOO FAST" error message. This "handshake" allows external hardware to coordinate measurements. The STOP SWEEP handshake allows external multiplexers to switch measurement inputs. Do not pull the STOP SWEEP "LOW" during the measurement.

Timing

The figure (see next page) shows the timing relationships in this mode. STOP SWEEP starts HIGH, indicating that the receiver is reading to measure data. When the trigger arrives, STOP SWEEP goes LOW.

The receiver latches (measures) the data 60 us before the STOP SWEEP goes high. After 200 us STOP SWEEP goes HIGH, indicating the receiver is ready to measure another data point. The STOP SWEEP delay may be changed by using the FASPARMTIME command.

The HP-IB Command FASPARMTIME can be used to delay the data acquisition longer than 250 us.

Note: The timing values in the following example are typical and do not represent specifications.

Fast Data Collection Mode (FASD) No Averaging

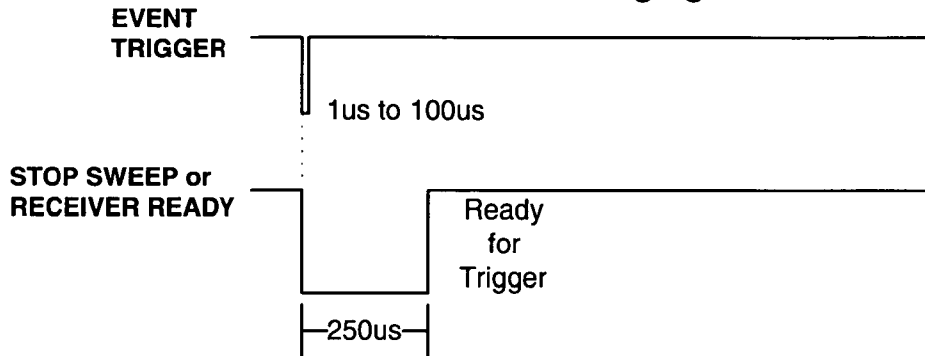

When STOP SWEEP or RECEIVER READY are HIGH, the receiver is READY to take data

When STOP SWEEP or RECEIVER READY are LOW, the receiver IGNORES trigger pulses, and gives TRIGGER TOO FAST error.

The 250us minimum wait time can be set to a longer duration using FASTPARMTIME command.

With Averaging

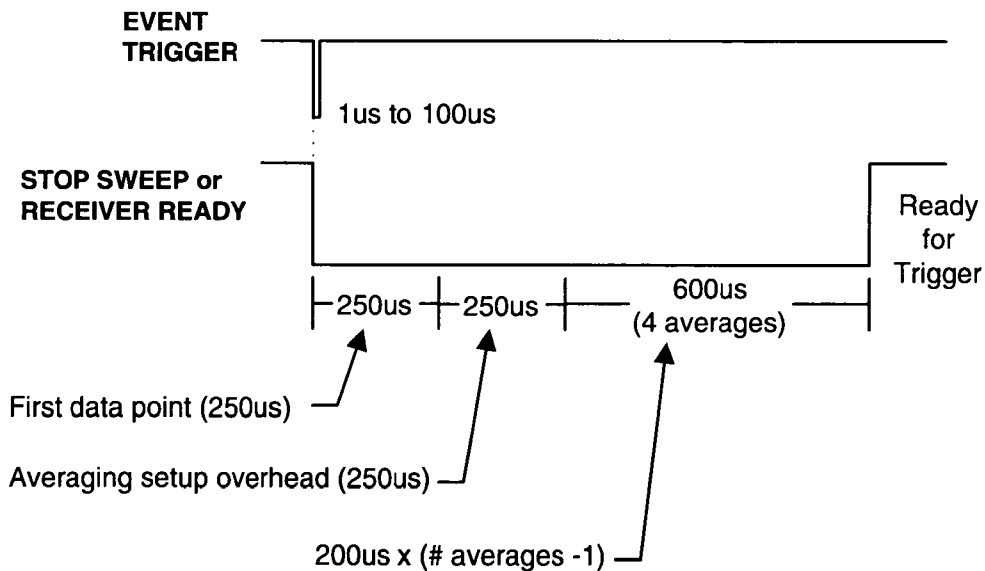

Total time with 4 averages: 1,100us

fasd.vsd

Autoranged Data Collection Mode

HP-IB Command: FASAD

Use this mode if signal levels vary by *more than ± 12 dB between two immediately adjacent data points*. Wide swings in amplitude often occur when measuring signals from an external multiplexer or pin switches. This mode allows you to measure adjacent data points with huge amplitude differences, up to the full dynamic range of the receiver.

This is the mode used when in TURBO MODE in the ORBIT/FR 959 software, and all near-field measurement software produced by Nearfield Systems Inc.

Note: All references to STOP SWEEP in this section also apply to the RECEIVER READY line, which could be used instead.

Similarities Compared to FASD mode

This mode is similar to the FASD mode:

- ♦ It pulls the STOP SWEEP line (rear panel BNC) LOW during data acquisition.
- ♦ STOP SWEEP goes HIGH when the receiver is ready to take more data.
- ♦ Any trigger pulses received when STOP SWEEP is LOW causes a "TRIGGER TOO FAST" error message. This "handshake" allows external hardware to coordinate measurements. The STOP SWEEP handshake allows external multiplexers to switch measurement inputs. Do not pull the STOP SWEEP "LOW" during the measurement.

The figure (next page) shows the timing relationships in this mode. STOP SWEEP starts HIGH, indicating the receiver is ready to measure data. When the trigger arrives, STOP SWEEP goes LOW.

Timing

The receiver latches (measures) the data 60 us before the STOP SWEEP goes HIGH. After 400us STOP SWEEP goes HIGH, indicating the receiver is ready to measure another data point. The STOP SWEEP delay may be changed by using the FASPARMTIME command. If the signal levels vary more than ± 12 dB reducing the FASPARMTIME time to less than 400 us is possible, but will reduce the measurement accuracy.

Note: The timing values in the following example are typical and do not represent specifications.

Autoranged Data Collection Mode (FASAD) No Averaging

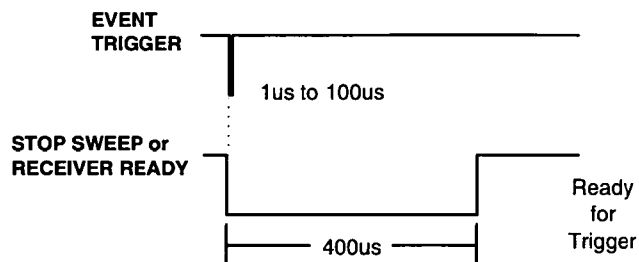

When STOP SWEEP or RECEIVER READY are HIGH, the receiver is READY to take data

When STOP SWEEP or RECEIVER READY are LOW, the receiver IGNORES trigger pulses, and gives TRIGGER TOO FAST error.

The 400us minimum wait time can be set to a longer duration using FASTPARMTIME command.

With Averaging

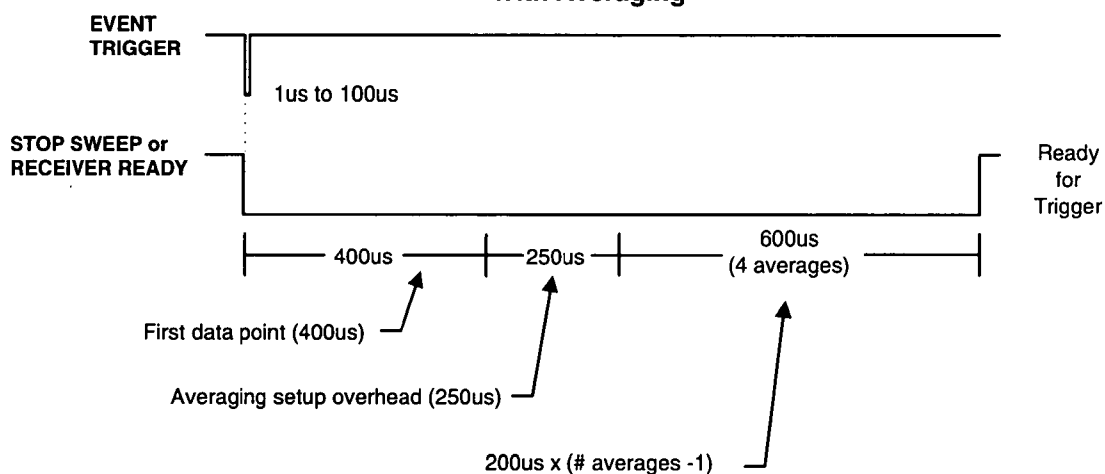

Total time with 4 averages: 1,250us

fasad.vsd

Fast IF Multiplexing

HP-IB Command: FASMD

Fast IF multiplexing mode can measure up to four different input ratios at each stimulus point. Signal switching is performed inside the receiver. This mode is similar to the fully autoranged Fast CW mode (FASAD), but:

- ♦ Fast IF Multiplexing is faster, measuring up to 4,000 points per second.
- ♦ Fast IF Multiplexing adds the capability of IF multiplexing. This can eliminate the need for external PIN switches, and the VXI controller that drive them.

This mode is also useful in millimeter wave systems, where good external PIN switches are difficult to obtain. Fast IF multiplexing switches the signals at IF frequencies, rather than at millimeter frequencies.

Trigger Requirements

Use a negative trigger pulse that is normally high. A trigger signal that is normally low will prevent further triggering. If you are driving EVENT TRIGGER with your custom circuitry, make sure it uses open-collector TTL. Using other types of circuitry can cause strange problems. A pulse generator with burst output mode works well with Fast IF Multiplexing, or other fast CW modes. The trigger must be 1us to 100us wide.

Note: All references to STOP SWEEP in this section also apply to the RECEIVER READY line, which could be used instead.

Timing

The figure below shows the timing relationships in this mode. STOP SWEEP starts HIGH, indicating the receiver is ready to measure data. When the trigger arrives, STOP SWEEP goes LOW.

After 250 us the receiver latches (measures) the data. After 400 us STOP SWEEP goes HIGH, indicating the receiver is ready to measure another data point. The STOP SWEEP delay may be changed by using the FASPARMTIME command. If the signal levels vary more than ± 12 dB reducing the FASPARMTIME time to less than 250 us will reduce the measurement accuracy.

Note that in mode 2, 4, 8, 10, 12, and 14 the STOP SWEEP or RECEIVER READY will go high for 100ns between each parameter. Ignore this high and do not send a trigger during this time. Do not pull STOP SWEEP low while in the FASMD mode.

Note: The timing values in the following examples are typical and do not represent specifications.

Timing Diagram for Fast Mux Modes 1, 3, 5, 7, 9, 11, 13
(A trigger is required for each ratio measured)
No Averaging

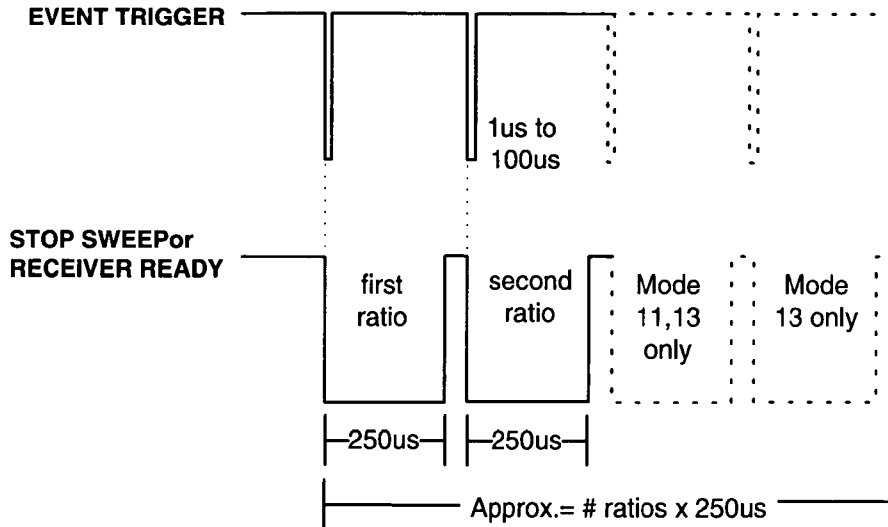

With Averaging (only one ratio shown)
The following example applies to all modes

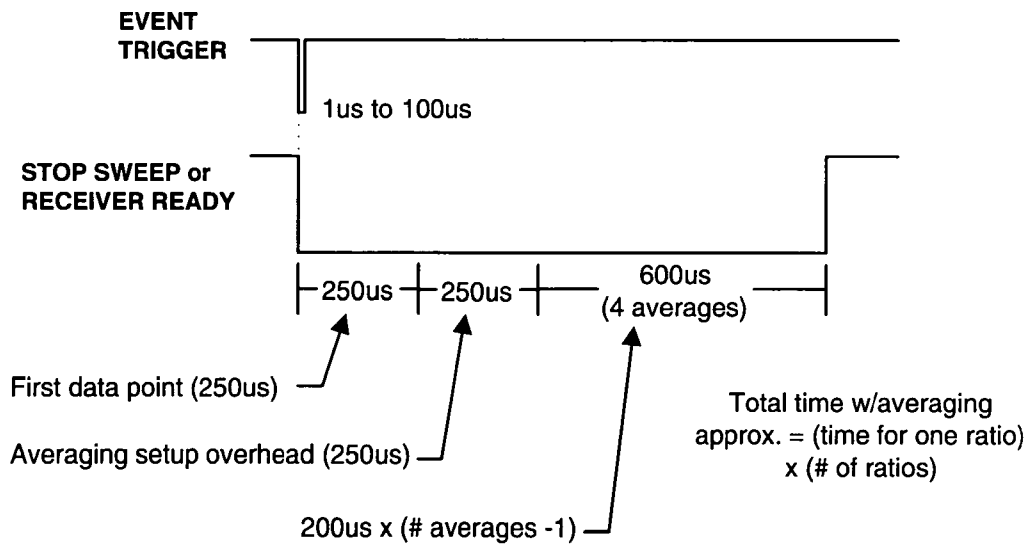

Total time with 4 averages: 1,100us per ratio

fastmux1.vsd

Timing Diagram for Fast Mux Modes 2, 4, 6, 8, 10, 12, 14
(One trigger measures all ratios)
No Averaging

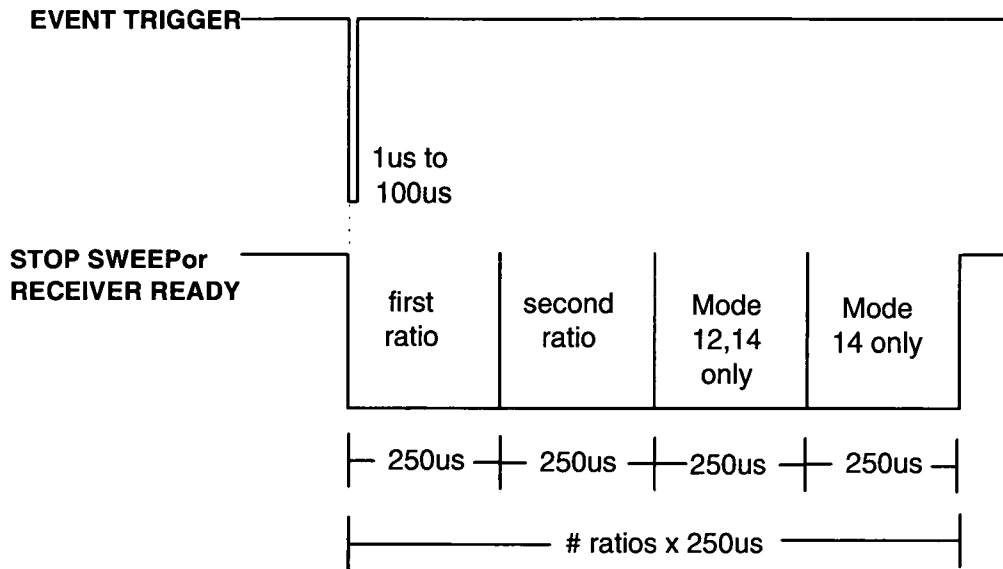

fastmux2.vsd

Using Fast IF Multiplexing Mode

When using this mode the first step is to set up the receiver to make a measurement. Set up the instrument as follows:

Step 1. Enter Manual Settings

[key] denotes an instrument key
{softkey} denotes an instrument softkey

[PARAM 1]
{TRIGGER INTERNAL}
{SINGLE POINT}
{CENTER FREQUENCY} nn [x1]
{xx GAIN:AUTO}
{AVERAGING} nn [x1]

Where nn is the desired value.

The receiver should be properly making a measurement before continuing.

Step 2. Issue the Fast IF Multiplexing Command over HP-IB

The next step is to select the type of Fast IF Multiplexing measurement you want to make. The HP-IB command is FASMUXMODE n . The number n selects a specific configuration of the Fast Multiplexing measurement, described in the table below. The different configuration numbers select:

- ◆ The number of ratioed measurements that will be made (two, three, or four).
- ◆ The specific ratios ($b1/a1$, $b2/a1$, and so on).
- ◆ The number of triggers required to complete the measurement (a single trigger measures all ratios, or one trigger is required for each ratio).

Table 4. Fast Multiplexing Mode Select Numbers

FASMUXMODE _n	Parameters Measured	Trigger Pulses Required	
0	No Multiplexing	Not Applicable	
1	b1/a1, b2/a1	One trigger is required to measure each ratio.	
3	b1/a2, b2/a2		
5	b1/a1, b1/a2		
6	b2/a1, b2/a2		
7	b1/a1, b2/a2		
9	b1/a2, b2/a1		
11	b1/a1, b2/a1, a2/a1		
13	b1/a1, b2/a1, b1/a2, b2/a2		
2	b1/a1, b2/a1		One trigger measures all ratios.
4	b1/a2, b2/a2		
8	b1/a1, b2/a2		
10	b1/a2, b2/a1		
12	b1/a1, b2/a1, a2/a1		
14	b1/a1, b2/a1, b1/a2, b2/a2		
		Two triggers are required to measure all of the ratios. The first trigger measures the first two parameters. The second trigger measures the next two parameters.	

Note: The ratios are measured in the order shown in the table. Data points in the Fast CW buffer are stored in the same order as the data was measured. Remember, the buffer is the First In First Out (FIFO) type.

Step 3. Set Extra Measurement Delay if Necessary

Use the FASPARMTIME command if necessary. Refer to the keyword dictionary for details.

Step 4. Initiate Actual Measurements

Now, activate the Fast IF Multiplexing mode by sending the FASMD command.

Example: FASMUXMODE 10 ; FASMD

A complete programming example for Fast IF Multiplexing mode is shown at the end this document.

Operating Notes and Driver Circuitry Requirements

You should be aware of the following:

Table 4. Operating Notes

Required Circuitry	Make sure you drive the Event Trigger input with open-collector TTL circuitry. Other types of driver circuitry (for example, dual-differential) will cause bizarre timing problems.
Data Form	When you are using FASMD mode, FORM1 data transfers do not have the normal "#A bytea byteb" header. Refer to "FORM1" in the <i>HP 8530A Keyword Dictionary</i> .
Trigger Polarity	Use a negative trigger pulse that is normally high. A positive trigger that is normally low will block further triggers. The trigger pulse must be at least 1 us and no greater than 100 us wide.
Minimum Time Delay	A specific amount of time must elapse between trigger signals. The required time delay between trigger pulses must be $>(\# \text{ of parameters}) \times \text{FASPARMTIME}$ (250us by default). For example, in <code>FASMUXMODE10</code> the time between trigger pulses must be greater than: $2 \times 250 \text{ us} = 500 \text{ us}$.
Ready Status	Monitor the STOP SWEEP or RECEIVER READY the same way as when in the FASAD mode. Do not send trigger signals when STOP SWEEP or is low.

To Turn Fast IF Multiplexing Mode OFF

To turn off the fast IF multiplexing mode, issue these commands:

```
ABORT7  
CLEAR7  
SING (or any other sweep mode command)
```

Instead of placing the receiver in a single sweep mode (SING), you could place it in any other sweep mode, or simply recall an instrument state.

How Long Does the FASMUXMODE Selection Stay Valid?

Once you select one of the FASMUXMODE codes, that selection stays valid, even if you take the receiver out of fast IF multiplexing mode. If you later turn fast IF multiplexing ON again, the previous FASMUXMODE code will still be in effect. The only exceptions to this are when:

- ◆ You perform a User or Factory Preset.
- ◆ AC Power is turned OFF.

HP BASIC Fast CW Programming

The following programming examples show how to use a computer to make Fast CW measurements. There are two HP-IB commands used to read measurement data:

ENTER Reads the entire buffer.

TRANSFER Performs continuous transfer, reading one data point at a time.

The examples use an HP Series 300 computer, running HP BASIC revision 5.0 or greater, or HP BASIC running on a PC. If you are using a different computer or operating system, then use these programming examples as a guide for your programming.

Each example is set up to run as an independent program. The programs are self-documenting. Each line's function is explained in the BASIC comment field.

Fast CW measurements output the measurement data in FORM 1. Both examples convert the output data from FORM 1 to FORM 3 in the computer. The SUB Build_table creates the exponents used in the conversion.

Fast CW Using the ENTER Command

This example uses the ENTER command to read the data from the receiver into the computer. The ENTER command reads the entire contents of the buffer. Use this command after all the measurement data has been taken. Be sure that the receiver's data buffer does not fill up.

```
10  ALLOCATE REAL Exp_tbl(0:255)
20  GOSUB Build_table
30  !
40  !           USING FAST DATA WITH AUTO-RANGING AND ENTER STATEMENTS. THIS
50  !           WILL READ ALL THE DATA FROM THE RECEIVER AND THEN CONVERT
60  !           THE DATA TO REAL AND IMAGINARY PAIRS.
70  !
80  Points=181                ! NUMBER OF DATA POINTS TO BE
TAKEN.
90  ALLOCATE INTEGER Data_f1(1:Points,0:2) ! DATA FROM RECEIVER IN FORMAT
FORM1.
100 ALLOCATE Data_f3(1:Points,1:2)        ! DATA FROM RECEIVER IN FORMAT
FORM3 (REAL
110                                     ! AND IMAGINARY PAIRS).
120 !
130 ASSIGN @Rec TO 716          ! ASSIGN RECEIVER HPIB.
140 !
150 !
160 Set_up:                    ! SET UP RECEIVER FOR FAST DATA.
170 !
180 OUTPUT @Rec;"SINP;"        ! SET RECEIVER TO SINGLE POINT.
190 !
200 ! OUTPUT @REC; commands to set FREQUENCY, AVERAGES, PARAMETER, etc.
210 !
220 OUTPUT @Rec;"FASAD;"      ! SET THE RECEIVER TO FAST DATA w/
AUTO-RANGE,
230                               ! OR "FASD;" OR "FASC;".
240 !
250 REPEAT                      ! WAIT UNTIL THE RECEIVER IS READY TO
260   WAIT .001                  ! TO TAKE DATA.
270 UNTIL BIT(SPOLL(@Rec),2)    !
280 TRIGGER @Rec                ! ISSUE HPIB TRIGGER TO BEGIN FAST DATA MODE.
290 !
300 ASSIGN @Rec;FORMAT OFF      ! ASSIGN COMPUTER HPIB FOR FORM1 DATA.
310 !
320 !
330 Trigger_monitor:          ! MONITOR THE RECEIVER UNTIL READY FOR
TRIGGER.
340 !
350 ! monitor receiver STOP SWEEP
360                               ! IF "FASAD;" OR "FASD;", THEN MONITOR THE
RECEIVER'S
370                               ! STOP SWEEP. WHEN STOP SWEEP IS HIGH, THEN
OK TO
380                               ! ISSUE EXTERNAL TRIGGERS. CONTINUE TO
MONITOR STOP
390                               ! SWEEP BEFORE EACH TRIGGER IS ISSUED FOR
HIGHEST
400                               ! DATA TAKING SPEED.
410                               !
420                               ! IF "FASC;", THEN MONITOR IS NOT NEEDED.
INSTEAD
430                               ! WAIT 1 SECOND UNTIL EXTERNAL TRIGGERS ARE
ISSUED.
440 !
450 ! issue EXTERNAL TRIGGERS
460 !
470 !
480 Read_data:                !
490 !
```

```

500  ENTER @Rec;Data_f1(*)           ! READ ALL THE DATA FROM RECEIVER.
510  !
520  ASSIGN @Rec;FORMAT ON           ! ASSIGN COMPUTER HPIB FOR ASCII DATA.
530  OUTPUT @Rec;"SINP;"            ! TURN FAST DATA OFF.
540  !
550  !
560  Convert_data:                   ! CONVERTS DATA FROM FORM 1 TO FORM 3.
570  FOR N=1 TO Points
580     Exp=Exp_tbl(BINAND(Data_f1(N,2),255))
590     Data_f3(N,1)=Data_f1(N,1)*Exp ! REAL DATA
600     Data_f3(N,2)=Data_f1(N,0)*Exp ! IMAGINARY DATA
610  NEXT N
620  !
630  !
640  Print_data:                     ! PRINT MEASURED DATA. THIS IS NOT REQUIRED.
650  !
660  FOR N=1 TO Points
670     PRINT Data_f3(N,1),Data_f3(N,2)
680  NEXT N
690  !
700  !
710  STOP
720  !
730  !
740  Build_table:                   ! BUILDS TABLE FOR FORM 1 TO
FORM 3                               ! CONVERSION.
750  !
760  !
770  Exp_tbl(0)=2^(-15)
780  FOR N=0 TO 126
790     Exp_tbl(N+1)=Exp_tbl(N)+Exp_tbl(N)
800  NEXT N
810  Exp_tbl(128)=2^(-143)
820  FOR N=128 TO 254
830     Exp_tbl(N+1)=Exp_tbl(N)+Exp_tbl(N)
840  NEXT N
850  RETURN
860  !
870  END

```

Fast CW Using the TRANSFER Command

This example uses the TRANSFER command to read the data from the receiver. This performs continuous transfer of data. TRANSFER can read the data as soon as it is available at the receiver. Use this method when there will be more data points measured than the receiver's data buffer can store.

The TRANSFER command can also allow other HP BASIC tasks to be performed when data is not being transferred.

```
10  ALLOCATE REAL Exp_tbl(0:255)
20  GOSUB Build_table
30  !
40  !           USING AUTORANGED FAST CW AND TRANSFER STATEMENTS. THIS
50  !           WILL READ THE DATA FROM THE RECEIVER AND THEN CONVERT
60  !           THE DATA TO REAL AND IMAGINARY PAIRS AFTER EACH POINT
70  !           IS READ FROM THE RECEIVER.
80  !
90  Points=18000                                ! NUMBER OF DATA POINTS TO BE TAKEN.
100 INTEGER Data_f1(1:18000,0:2) BUFFER ! DATA FROM RECEIVER IN FORMAT FORM1.
110 ALLOCATE Data_f3(1:Points,1:2)           ! DATA FROM RECEIVER IN FORMAT FORM3 (REAL
120                                           ! AND IMAGINARY PAIRS).
130 !
140 ASSIGN @Rec TO 716                          ! ASSIGN RECEIVER HPIB.
150 ASSIGN @Buffer TO BUFFER Data_f1(*) ! ASSIGN INPUT BUFFER.
160 !
170 !
180 Set_up:                                     ! SET UP THE RECEIVER FOR FAST DATA.
190 !
200 OUTPUT @Rec;"SINP;"                        ! SET THE RECEIVER TO SINGLE POINT.
210 !
220 ! OUTPUT @Rec commands to set FREQUENCY, AVERAGES, PARAMETER, etc.
230 !
240 OUTPUT @Rec;"FASAD;"                      ! SET THE RECEIVER TO AUTORANGED FAST CW,
250                                           ! "FASD;" OR "FASC;" CAN BE USED.
260 !
270 REPEAT                                     ! WAIT UNTIL THE RECEIVER IS READY TO
280   WAIT .001                                ! TO TAKE DATA.
290 UNTIL BIT(SPOLL(@Rec),2)                  !
300 TRIGGER @Rec                              ! ISSUE HPIB TRIGGER TO BEGIN FAST DATA MODE.
310 !
320 !
330 Transfer_data:                             ! TRANSFER DATA FROM RECEIVER
340 !
350 TRANSFER @Rec TO @Buffer;RECORDS Points,EOR (COUNT 6)
360 !
370 N=1                                         ! N IS THE CURRENT POINT.
380 !
390 !
400 Tigger_monitor:                           ! MONITOR THE RECEIVER WHEN READY FOR TRIGGERS.
410 !
420 ! monitor receiver STOP SWEEP
430 ! IF "FASAD;" OR "FASD;", THEN MONITOR RECEIVER'S
440 ! STOP SWEEP. WHEN STOP SWEEP IS HIGH, THEN OK TO
450 ! ISSUE EXTERNAL TRIGGERS. CONTINUE TO MONITOR
460 ! STOP SWEEP BEFORE EACH TRIGGER IS ISSUED FOR
470 ! HIGHEST DATA TAKING SPEED.
480 !
490 ! IF "FASC;", THEN MONITOR IS NOT NEEDED. INSTEAD
500 ! WAIT 1 SECOND UNTIL ISSUE EXTERNAL TRIGGERS.
510 !
520 ! issue EXTERNAL TRIGGERS
530 !
540 REPEAT
550 !
```

```

560      ! do something here if you wish
570      !
580      STATUS @Buffer,4;R4          ! READ NUMBER OF BYTES IN BUFFER.
590      IF R4>=6*N THEN GOSUB Convert_data ! IF A NEW POINT EXISTS IN BUFFER THEN
600      ! CONVERT DATA TO FORM 3.
610      !
620      UNTIL N>Points
630      !
640      CONTROL @Buffer,8;0          ! TERMINATE TRANSFER.
650      OUTPUT @Rec;"SINP;"         ! TURN FAST DATA OFF.
660      !
670      !
680      Print_data:                  ! PRINT MEASURED DATA. THIS IS NOT REQUIRED.
690      !
700      FOR N=1 TO Points
710          PRINT N,Data_f3(N,1),Data_f3(N,2)
720      NEXT N
730      !
740      !
750      STOP
760      !
770      !
780      Convert_data:                ! CONVERTS FROM FORM 1 TO FORM 3.
790      !
800      Exp=Exp_tbl(BINAND(Data_f1(N,2),255))
810      Data_f3(N,1)=Data_f1(N,1)*Exp ! REAL DATA
820      Data_f3(N,2)=Data_f1(N,0)*Exp ! IMAGINARY DATA
830      N=N+1
840      RETURN
850      !
860      !
870      Build_table:                 ! BUILDS TABLE FOR FORM 1 TO FORM 3 CONVERSION.
880      !
890      Exp_tbl(0)=2^(-15)
900      FOR N=0 TO 126
910          Exp_tbl(N+1)=Exp_tbl(N)+Exp_tbl(N)
920      NEXT N
930      Exp_tbl(128)=2^(-143)
940      FOR N=128 TO 254
950          Exp_tbl(N+1)=Exp_tbl(N)+Exp_tbl(N)
960      NEXT N
970      RETURN
980      !
990      END

```

HP BASIC Fast IF Multiplexing Mode Programming Example

The following programming examples show how to use a computer to make a Fast IF multiplexing measurement.

```

1 CALL Fast_mux
2 END
10 SUB Fast_mux
20 Fast_mux: ! This is a stand alone sub-program which demonstrates
30 ! 8530 fast mux operation
40 !
50 INTEGER Data_buffer(1:30000) BUFFER
60 INTEGER Setup
70 REAL Set_pointer,Param_pt,Data_pt,Reps,I,Old_pointer
80 REAL Log_mag(1:2),Phase(1:2)
90 REAL Exp_tbl(0:255),Exp,Data_16bit(0:800,0:1)
100 DIM Display$(80),Report$(200)
110 COMPLEX Data_set(1:2)
120 ASSIGN @A8530_data TO 716;FORMAT OFF
130 ASSIGN @A8530_control TO 716;FORMAT ON
140 Setup=0
150 Dwell_time=250 !FAST PARAMETER PER POINT MEASUREMENT TIME IN MICROSECONDS (NO AVERAGING)
160 !!!!!!!!!!!!!!!!!!!!!!!!!!!!!!!!!!!!!!!!!!!!!!!!!!!!!!!!!!!!!!!
170 ! DISPLAY INITIALIZATION AND INSTRUCTIONS
180 !!!!!!!!!!!!!!!!!!!!!!!!!!!!!!!!!!!!!!!!!!!!!!!!!!!!!!!!!!!!!!!
190 PRINTER IS CRT
200 DEG
210 GRAPHICS OFF
220 PRINT USING "@"
230 PRINT "This example demonstrates the FAST IF MULTIPLEXING feature of "
240 PRINT "the HP 8530A. It requires firmware rev 1.2 or higher. An external"
250 PRINT "trigger source should be connected to the 8530A Event Trigger input"
260 PRINT "on the rear panel. The STOP SWEEP input should be disconnected for"
270 PRINT "this test. During the test, the 8530A will be in MUX MODE 2 in which"
280 PRINT "both b1/a1 and b2/a1 measurements are taken upon the receipt of each"
290 PRINT "event trigger. The trigger should be a negative going TTL pulse with"
300 PRINT "a pulse width between 1uS and 100uS. For this example, the minimum "
310 PRINT "period between two triggers is 500 us (ASSUMES NO AVERAGING)."

```

```

690 PRINT " | _____ | _____ | | _____ | _____ | "
700 DISP "TRIGGER MEASUREMENTS, PRESS SOFTKEY LABELED 'EXIT' WHEN FINISHED"
710 !
720 !!!!!!!!!!!!!!!!!!!!!!!!!!!!!!!!!!!!!!!!!!!!!!!!!!!!!!!!!!!!!!!!!!!!!!!!!!!!!!!
730 ! CONTINUOUS TRANSFER DATA LOOP. USING TRANSFER ALLOWS FOR RAPID INPUT OF DATA
740 ! FROM THE 8530A. DATA IS DISPLAYED DURING COMPUTERS "SPARE TIME"
750 !!!!!!!!!!!!!!!!!!!!!!!!!!!!!!!!!!!!!!!!!!!!!!!!!!!!!!!!!!!!!!!!!!!!!!!!!!!!!!!
760 LOOP
770 ASSIGN @Buffer TO BUFFER Data_buffer(*)          ! INITIALIZE TRANSFER BUFFER
780 Old_pointer=0
790 Set_pointer=1
800 !
810 !! TRANSFER STATEMENT: EACH MEASUREMENT IS TRANSFERRED IN THREE INTEGERS, OR 6 BYTES
820 !! SO COUNT 6 ALLOWS TRACKING OF THE BUFFER AS IT COLLECTS DATA FROM THE INSTRUMENT.
830 TRANSFER @A8530_data TO @Buffer;RECORDS 10000,EOR (COUNT 6)
840 FOR N=0 TO 10
850 ON KEY N LABEL " EXIT ",15 GOTO Finished
860 NEXT N
870 LOOP
880 STATUS @Buffer,4;Data_pt
890 !! SINCE WE ARE MAKING TWO MEASUREMENTS AT A TIME, THE DISPLAY IS ONLY UPDATED WHEN
900 !! THE DATA POINTER IS POINTING TO THE END OF A NEW PAIR OF MEASUREMENTS. THIS
910 !! TECHNIQUE SKIPS A LOT OF DATA DURING FAST MEASUREMENTS, BUT ALLOWS THE DISPLAY
920 !! TO KEEP UP WITH THE DATA FLOW.
930 IF Data_pt MOD 12=0 THEN
940 IF Data_pt>Old_pointer THEN
950 Old_pointer=Data_pt
960 !!
970 !!! THE FOLLOWING LOOP CONVERTS TWO MEASUREMENTS FROM THE 8530 COMPRESSED FORMAT
980 !!! TO BASIC COMPLEX VALUES. IT THEN CALCULATES THE MAGNITUDE AND PHASE OF EACH
990 !!! MEASUREMENT AND UPDATES THE DISPLAY
1000 !!
1010 FOR Param_pt=1 TO 2
1020 Data_pt=Old_pointer-6*(2-Param_pt)
1030 Exp=Exp_tbl(BINAND(Data_buffer(Data_pt/2),255))
1040
Data_set(Param_pt)=CMPLX(Data_buffer(Data_pt/2-1)*Exp,Data_buffer(Data_pt/2-2)*Exp)
1050 Log_mag(Param_pt)=20*LGT(ABS(Data_set(Param_pt)))
1060 Phase(Param_pt)=ARG(Data_set(Param_pt))
1070 OUTPUT Display$ USING
""|" ",2(2X,S3D.2D,2X,""|" "),"#";Log_mag(Param_pt),Phase(Param_pt)
1080 PRINT TABXY(1+25*(Param_pt-1),20),Display$
1090 NEXT Param_pt
1100 Data_pt=Old_pointer
1110 !!
1120 !! NOW PRINT THE CURRENT MEASUREMENT COUNT
1130 !!
1140 PRINT TABXY(5+25*(Param_pt-1),20);Data_pt/12+5000*Reps
1150 END IF
1160 END IF
1170 EXIT IF Data_pt/12=5000          ! THE BUFFER IS RE-INITIALIZED TO PREVENT OVERFLOW
1180 END LOOP
1190 Reps=Reps+1
1200 ASSIGN @Buffer TO *
1210 END LOOP
1220 Finished: !
1230 DISP "CLEARING I/O CHANNEL AND RE-SETTING 8530A"
1240 ABORTIO @A8530_data              ! TURN OFF THE TRANSFER
1250 ASSIGN @Buffer TO *
1260 OUTPUT @A8530_control;"SING"    ! TURN OFF FAST MUX MODE
1270 OUTPUT @A8530_control;"RECA8"  ! PUT 8530A IN STANDARD STATE
1280 FOR N=0 TO 9
1290 OFF KEY N
1300 NEXT N
1310 WAIT 1
1320 ABORT 7
1330 CLEAR 7
1340 LOCAL @A8530_control            ! PUT 8530A IN LOCAL
1350 PRINT USING "@@"
1360 DISP ""
1370 SUBEXIT
1380 Build_table: ! USED FOR DATA CONVERSION
1390 !
1400 Exp_tbl(0)=2^(-15)
1410 FOR I=0 TO 126
1420 Exp_tbl(I+1)=Exp_tbl(I)+Exp_tbl(I)
1430 NEXT I
1440 Exp_tbl(128)=2^(-143)
1450 FOR I=128 TO 254
1460 Exp_tbl(I+1)=Exp_tbl(I)+Exp_tbl(I)

```

```

1470 NEXT I
1480 RETURN
1490 Setup_fastmux: !
1500 Setup=0
1510 ABORT 7
1520 CLEAR 7
1530 PRINT TABXY(1,30), " "
1540 PRINT " "
1550 PRINT " "
1560 OUTPUT @A8530_control;"RECA8" ! START IN KNOWN WORKING STATE
1570 WAIT 3
1580 OUTPUT @A8530_control;"HOLD;SINP" ! GO TO HOLD MODE, SINGLE POINT
1590 INPUT "ENTER FREQUENCY OF MEASUREMENT (IN GHz)",Freq
1600 OUTPUT @A8530_control;"OUTPERRO" ! CLEAR THE MESSAGE LINE
1610 ENTER @A8530_control;Report$
1620 OUTPUT @A8530_control;"CENT"&VAL$(Freq)&"GHz;SING" ! SET TO SELECTED FREQ, MAKE A CW
MEASUREMENT
1630 OUTPUT @A8530_control;"FASPARMTIME "&VAL$(Dwell_time) ! SET FAST MUX DELAY TIME (250 uS)
1640 OUTPUT @A8530_control;"FASMUXMODE 2;FASMD" ! SET UP FAST MUX MODE 2 (SEE O&P MANUAL FOR
OTHERS)
1650 OUTPUT @A8530_control;"OUTPERRO" ! CHECK FOR ERRORS DURING SET UP
1660 ENTER @A8530_control;Report$
1670 IF VAL(Report$)<>0 THEN
1680 PRINT TABXY(1,30),"THE FOLLOWING PROBLEM OCCURED DURING 8530A SETUP:"
1690 PRINT " "
1700 PRINT Report$
1710 DISP "RESOLVE PROBLEM AND CONTINUE ( OR EXIT )"
1720 FOR N=0 TO 4
1730 ON KEY N LABEL "CONTINUE" GOTO Setup_fastmux
1740 ON KEY N+5 LABEL "EXIT" GOTO Setup_failed
1750 NEXT N
1760 Wait_for_key:GOTO Wait_for_key
1770 END IF
1780 REPEAT ! WAIT FOR 8530A SRQ MASK BIT
1790 WAIT .01
1800 UNTIL BIT(SPOLL(716),2)
1810 TRIGGER @A8530_control ! DROPS 8530A INTO THE SELECTED FAST DATA MODE
1820 Setup=1 ! (FAST MUX MODE 2)
1830 Setup_failed: !
1840 PRINT TABXY(1,30), " "
1850 PRINT " "
1860 PRINT " "
1870 RETURN
1880 SUBEND

```

Measurement Tutorials

This chapter gives more in depth information on making measurements. Feature choices are explained so you can customize measurements to suit your needs. The following subjects are covered:

Chapter Contents

- Angle Domain Measurement Tutorial
 - Step 1. Choose Internal, External, or HP-IB Triggering
 - Step 2. Choose a Measurement Frequency
 - Step 3. Choose a Single Angle or Swept Angle Measurement
 - Step 4. Choose Single or Continual Measurements
 - Step 5. Choose which Parameters to Measure
 - Step 6. Make a Swept Measurement
- External Triggering
- HP 85370A Position Encoder Operation
- Frequency Domain Tutorial
 - Step 1. Select Internal Triggering
 - Step 2. Choose a Single Point or Swept Measurement
 - Single Point mode
 - Step Sweep mode (and how to increase Step Sweep measurements by a factor of six)
 - Frequency List mode
 - Ramp Sweep mode
 - Step 3. Choose Single or Continual Measurements
 - Step 4. Choose which Parameters to Measure
- Making Faster Frequency Domain Measurements

For information on common measurement tasks such as boresighting, averaging, finding depth of null, and so on, refer to Chapter 5.

measured signal. Continual measurement mode (described below) and internal triggering are suggested when using the Single Angle mode.

Swept Angle Pressing **SWEPT ANGLE** measures a range of angles. Use the **(START)** and **(STOP)** keys to enter the desired start and stop angles. Use **INCREMENT ANGLE** to choose the desired angular increment.

Note



Remember that the HP 8530A does not control the positioner, and it does not send commands to the positioner controller. If your positioner system allows you to “program” a manual measurement from its front panel, set it for the desired start, stop, and increment angle. Now enter these values into the HP 8530A.

If your positioner system is completely manual, just enter start, stop, and increment angles into the HP 8530A.

Step 4. Choose Single or Continual Measurements

While in the Stimulus Menu, press **MORE** and choose one of the following:

SINGLE In this mode, the receiver measures a single pattern measurement. When the measurement is done, the receiver goes into Hold mode (it stops making measurements). The receiver will wait in hold mode until **SINGLE** is pressed again, or until you press **MEASUREMENT (RESTART)**.

Single mode is recommended whenever your system is in external trigger mode. The advantage of using single mode is that, when the measurement is done, the receiver goes into “hold mode” and ignores any subsequent trigger pulses. This keeps the system from responding to false triggers. (This also ensures that the receiver will not start a measurement accidentally when you are just moving the antenna positioner around.) Pressing **SINGLE** or **(RESTART)** prepares the receiver to make another single sweep measurement.

CONTINUAL is recommended when making **SINGLE ANGLE** measurements, or if you are using the HP 85370A Position Encoder. In Angle Domain, **CONTINUAL** allows the receiver to make a measurement any time you move the positioner forward past the selected starting angle.

Note



If you are using Continual measurements with external triggering, HP recommends that you set “automatic IF correction” to manual mode. Refer to “External Triggering”, later in this chapter, for more information.

Step 5. Choose which Parameters to Measure

The receiver measures parameter that are displayed on the screen. The receiver *does not* measure parameters that *are not* displayed on the screen.

The number of parameters to be measured is selected by pressing **(DISPLAY) DISPLAY MODE**, then one of the following softkeys:

SINGLE PARAMETER causes the receiver to measure and display one parameter. Choose the desired parameter by pressing **(PARAM 1)**, **(PARAM 2)**, **(PARAM 3)**, or **(PARAM 4)**.

Angle Domain Measurement Tutorial

TWO PARAMETER

causes the receiver to measure and display PARAM 1 and PARAM 2 for the active channel.

THREE PARAMETER

causes the receiver to measure and display PARAM 1, PARAM 2, and PARAM 3 for the active channel.

FOUR PARAMETER

causes the receiver to measure and display all four parameters for the active channel.

DUAL CHANNEL

causes the receiver to measure and display one parameter (of your choice) in each channel. For each channel, choose the desired parameter by pressing **PARAM 1**, **PARAM 2**, **PARAM 3**, or **PARAM 4** keys.

Step 6. Make a Swept Measurement

Making Swept Measurements Using Single Sweep Mode

1. If your positioner controller requires it, enter the start, stop, and increment angle using its front panel controls. If you can move the antenna using a simple knob, skip this step.
2. Enter start, stop, and increment angles into the receiver.
3. Press: STIMULUS **MENU** **MORE SINGLE** or simply press MEASUREMENT **RESTART**.
4. Move the positioner about 3° *in front of* the start angle. When the receiver displays MOVE POSITIONER ANGLE FORWARD it is ready to make the measurement.
5. Move the antenna to the stop angle.

To measure another sweep

6. Press **SINGLE** or MEASUREMENT **RESTART** again.
7. Move the positioner about 3° in front of the start angle.
8. Move the antenna to the stop angle.

Making Swept Measurements Using Continual Sweep Mode

1. If your positioner controller requires it, enter the start, stop, and increment angle using its front panel controls. If you can move the antenna using a simple knob, skip this step.
2. Enter start, stop, and increment angles into the receiver.
3. Move the positioner about 3° *in front of* the start angle. When the receiver displays MOVE POSITIONER ANGLE FORWARD it is ready to make the measurement.
4. Move the antenna to the stop angle.

To measure another sweep

5. Move the positioner about 3° in front of the start angle.
6. Move the antenna to the stop angle.

External Triggering

Before You Use External Trigger Modes

Read this if you are using Continual or Number of Groups mode, and the receiver is externally triggered:

Before you select an external trigger mode, you should disable the automatic IF Correction feature of the HP 8530A. (Remember do this *only* if you are using Continual or Number of Groups mode, and the receiver is externally triggered). IF Correction is a feature that periodically calibrates the IF stages of the receiver. When this "invisible" calibration occurs, there is a small interruption in the measurement. In internal triggering, this delay is not a problem. However, in external triggering applications (such as angle scan antenna measurements), this delay can disrupt the measurement. You can avoid this problem in either of the following ways:

- You can use single mode by pressing: STIMULUS **MENU** **MORE** **SINGLE**.
- or
- You can turn automatic IF correction OFF by pressing: **SYSTEM** **IF CORRECTION** **IF CORRECT MANUAL**.

If you select **IF CORRECT MANUAL**, you will get greatest IF gain accuracy if you perform a **RESET IF CORRECTION** command before starting each measurement. **RESET IF CORRECTION** causes the receiver to perform an IF correction.

Note



If sweep mode is set to Single (STIMULUS **MENU** **MORE** **SINGLE**), you can leave the IF Correction feature set to AUTO.

After making Continual measurements, if you go back to single sweep mode, or leave external trigger mode, remember to turn IF correction back to AUTO.

Using External Trigger Modes

TTL or HP-IB triggering can be modified to suit your needs. By default triggering works as follows:

- If you are displaying a single parameter, each trigger causes the receiver to:
 1. Measure the selected parameter at the current angle or frequency.
 2. If in Frequency Domain, the receiver advances to the next frequency. If in Angle Domain, the analyzer advances its internal increment angle counter. The positioner must be moved by the operator or computer controller.
 3. Wait for another trigger (see Figure 4-1).

External Triggering

Default External Triggering: 1 Parameter Displayed

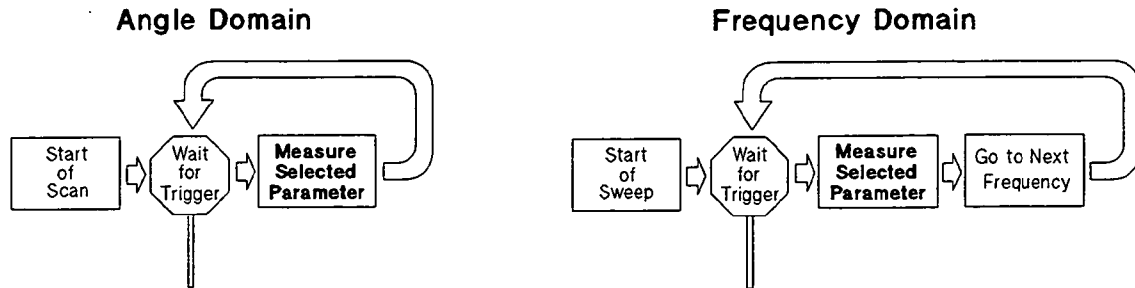

Figure 4-1. Default External Triggering Flowchart (single parameter)

- If you are displaying four parameters, each trigger causes the receiver to:
 1. Measure all four parameters at the current angle or frequency.
 2. If in Frequency Domain, the receiver advances to the next frequency. If in Angle Domain, the analyzer advances its internal increment angle counter. The positioner must be moved by the operator or computer controller.
 3. Wait for another trigger (see Figure 4-1).

Default External Triggering: 4 Parameters Displayed

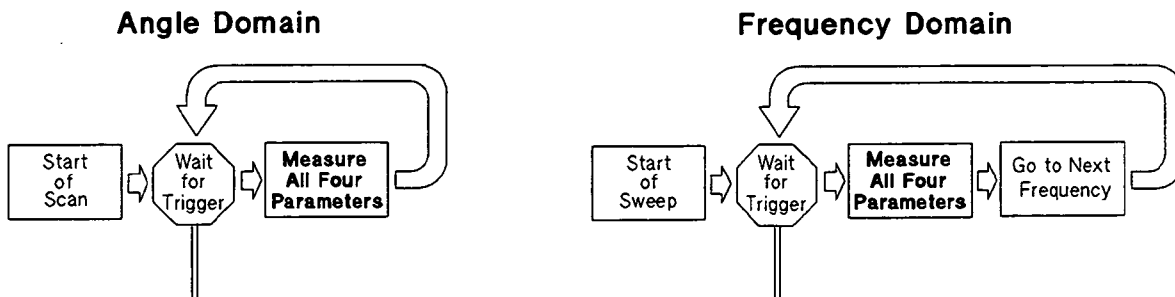

Figure 4-2. Default External Triggering Flowchart (four parameters)

Advanced Triggering Features

The Trigger menu softkeys (under **STIMULUS** MENU MORE TRIGGER MODE) provide greater triggering flexibility. They instruct the receiver to wait for a trigger before measuring specific parameters or before it advances to the next stimulus point. (This is the next angle in Angle Domain, or the next frequency in Frequency Domain.)

Here is a description of each custom triggering softkey:

TRIGGER: STIMULUS

When turned ON (underlined), TRIGGER: STIMULUS forces the receiver to wait for a trigger before moving to the next stimulus

point. **TRIGGER: STIMULUS** allows you to use RF sources that are not compatible with the HP 8530A System Bus.

TRIGGER: PARAM 1

When turned ON, the receiver waits for a trigger pulse before measuring parameter 1.

TRIGGER: PARAM 2

When turned ON, the receiver waits for a trigger pulse before measuring parameter 2.

TRIGGER: PARAM 3

When turned ON, the receiver waits for a trigger pulse before measuring parameter 3.

TRIGGER: PARAM 4

When turned ON, the receiver waits for a trigger pulse before measuring parameter 4.

Each of these softkeys is an ON/OFF toggle, and you can turn them on or off in any combination. When a softkey title is underlined, that function is ON. When the title is not underlined, the function is OFF.

How these Functions Work when One Parameter is Being Measured

The **TRIGGER: STIMULUS** function can always be used. However, the **TRIGGER: PARAM** functions work differently. If you are only displaying (measuring) one parameter, only the **TRIGGER: PARAM** softkey for *that* parameter will have an effect on triggering.

For example, if you are viewing parameter 2, as shown in Figure 4-3, only the **TRIGGER: PARAM 2** softkey will work. The other parameter-related softkeys **TRIGGER: PARAM 1**, **TRIGGER: PARAM 3**, and **TRIGGER: PARAM 4** will be ignored, because these parameters are not being measured.

**Custom External Triggering:
1 Parameter Displayed
(Parameter #2)**

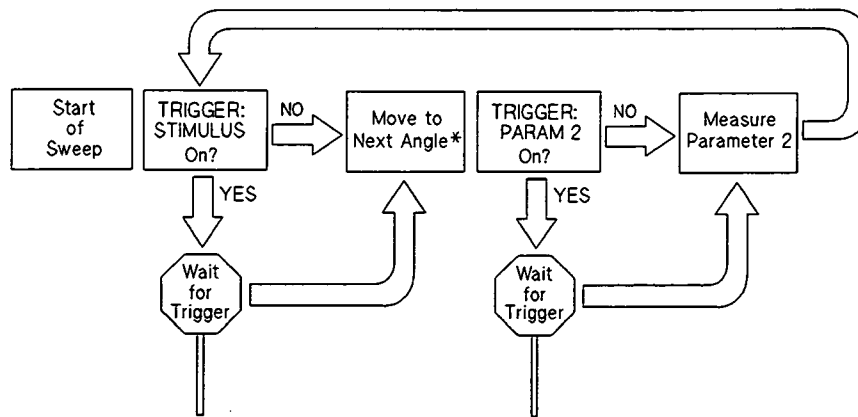

* At the beginning of the sweep this is the start angle

Figure 4-3. Custom External Triggering Flowchart (one parameter)

How these Functions Work when Four Parameters are Being Measured

If four parameters are being measured, the receiver will check the ON/OFF condition of each softkey (**TRIGGER: PARAM 1**, **TRIGGER: PARAM 2**, **TRIGGER: PARAM 3**, and **TRIGGER: PARAM 4**) before it measures them. Refer to Figure 4-4. If **TRIGGER: PARAM 1**

External Triggering

is on, for example, the receiver will wait for a trigger before it measures parameter 1. This process repeats for each parameter.

EXAMPLE 1

TRIGGER: STIMULUS ON
TRIGGER: PARAM 1 OFF
TRIGGER: PARAM 2 OFF
TRIGGER: PARAM 3 OFF
TRIGGER: PARAM 4 OFF

In this example, the receiver will:

1. In Angle Domain: Wait for one trigger before *internally* selecting the start angle (or the next angle in the measurement). This only affects internal receiver circuitry, it does not move the positioner!

In Frequency Domain: Wait for one trigger before it commands the RF source (and LO source, if used) to switch to the start frequency (or the next frequency in the measurement).

2. When the trigger arrives:

In Angle Domain: The receiver internally selects the start angle, or the next angle in the measurement.

In Frequency Domain: The receiver commands the RF source (and LO source, if used) to switch to the start frequency, or the next frequency in the measurement.

3. The receiver measures *all four* parameters.
4. This process repeats for each successive trigger.

Note that only one trigger is required per stimulus point. Thus, the receiver can trigger off the Record Increment output from a positioner controller.

The most common use for TRIGGER: STIMULUS is when using an RF source that is not controlled by the HP 8530. TRIGGER: STIMULUS allows you to move the source to the next stimulus point, then have the receiver make the measurement.

EXAMPLE 2

TRIGGER: STIMULUS OFF
TRIGGER: PARAM 1 ON
TRIGGER: PARAM 2 OFF
TRIGGER: PARAM 3 OFF
TRIGGER: PARAM 4 OFF

In this example, the receiver will:

1. In Angle Domain: Internally select the start angle (or the next angle in the measurement). This only affects internal receiver circuitry, it does not move the positioner! Notice that this occurs before the trigger arrives.

In Frequency Domain: Commands the RF source (and LO source, if used) to switch to the start frequency (or the next frequency in the measurement). Notice that this occurs before the trigger arrives.

2. Wait for a trigger pulse before measuring parameter 1.
3. When the trigger arrives, the receiver will measure *all four* parameters. Why? Since the other three "wait for a trigger" softkeys are OFF, they will be measured along with parameter 1.
4. This process then repeats for each successive trigger.

This configuration is the default external trigger setup, and will work if using the Record Increment from a positioner controller.

EXAMPLE 3:

```

TRIGGER: STIMULUS    OFF
TRIGGER: PARAM 1    ON
TRIGGER: PARAM 2    OFF
TRIGGER: PARAM 3    ON
TRIGGER: PARAM 4    OFF
    
```

In this example, the receiver will:

1. In Angle Domain: Internally select the start angle (or the next angle in the measurement). This only affects internal receiver circuitry, it does not move the positioner! Notice that this occurs before the trigger arrives.

In Frequency Domain: Commands the RF source (and LO source, if used) to switch to the start frequency (or the next frequency in the measurement). Notice that this occurs before the trigger arrives.

2. Wait for a trigger pulse before measuring parameter 1.
3. When the trigger arrives, the receiver will measure parameters 1 and 2, then it will stop and wait for another trigger.
4. When the second trigger arrives, the receiver will measure parameters 3 and 4.
5. This process then repeats for each successive trigger.

This setup could be used if you need to measure two parameters, then switch inputs using external hardware before measuring the second two parameters.

Note



If you are in External Trigger mode, and you turn all five softkeys OFF, the receiver will never wait for any triggers. Instead, it will “free run” as if it were in the Internal Trigger mode. *However*, the HP 85370A Position Encoder will not work properly in this situation. The Encoder requires that you select the actual Internal Trigger mode (TRIG SRC INTERNAL) or it will not operate properly.

External Triggering

Custom External Triggering: 4 Parameters Displayed

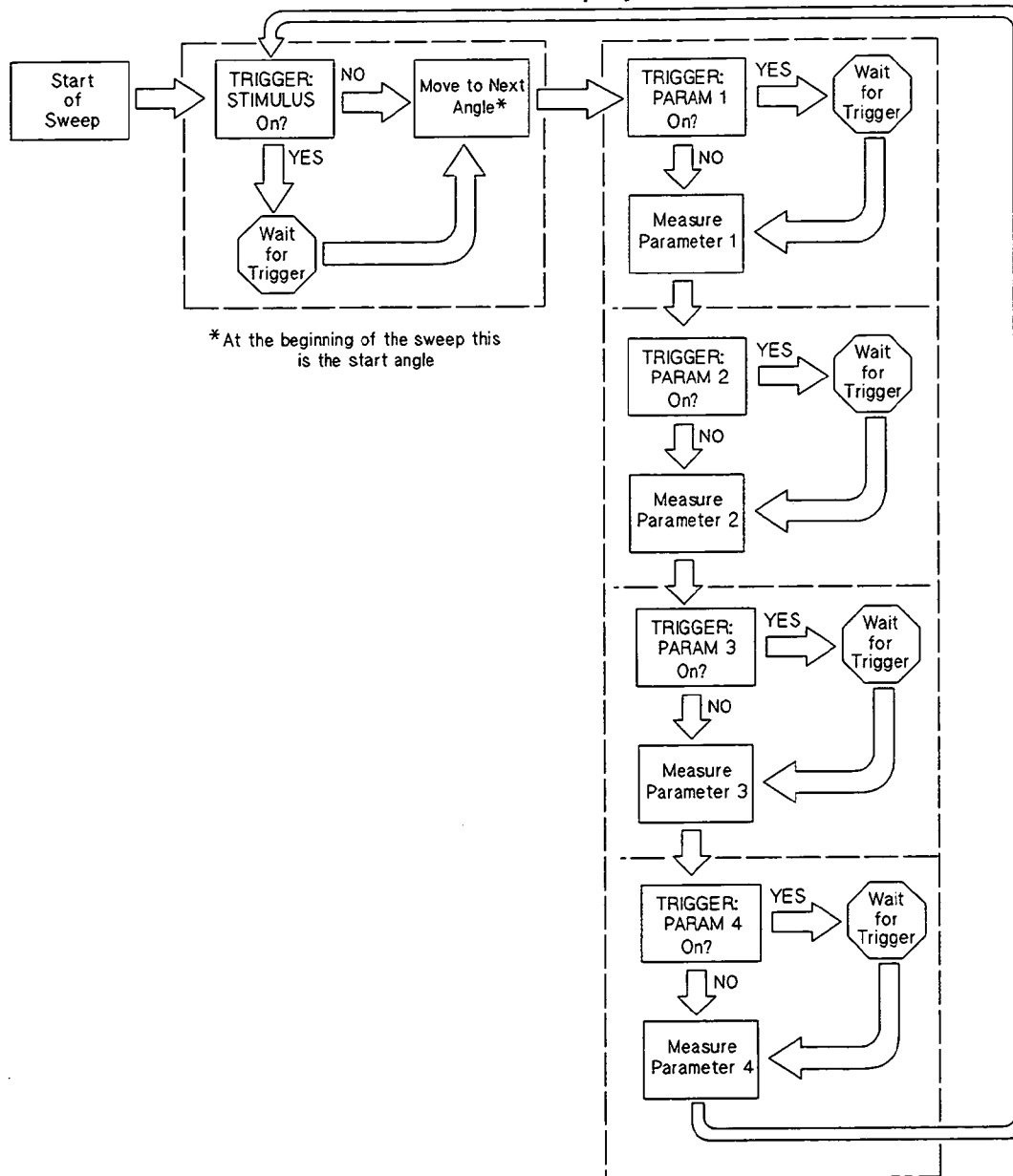

Figure 4-4. Custom External Triggering Flowchart (four parameters)

HP 85370A Position Encoder Operation

Introduction

This chapter explains how to operate the HP 8530A softkeys that control the HP 85370A Position Encoder. Remember, the HP 85370A only works when the HP 8530A is equipped with option 005, "Position Encoder Interface." This chapter assumes that the positioner encoder is installed and configured as explained in the *HP 85370A Position Encoder Installation and Service Manual*.

Position Encoder Softkeys

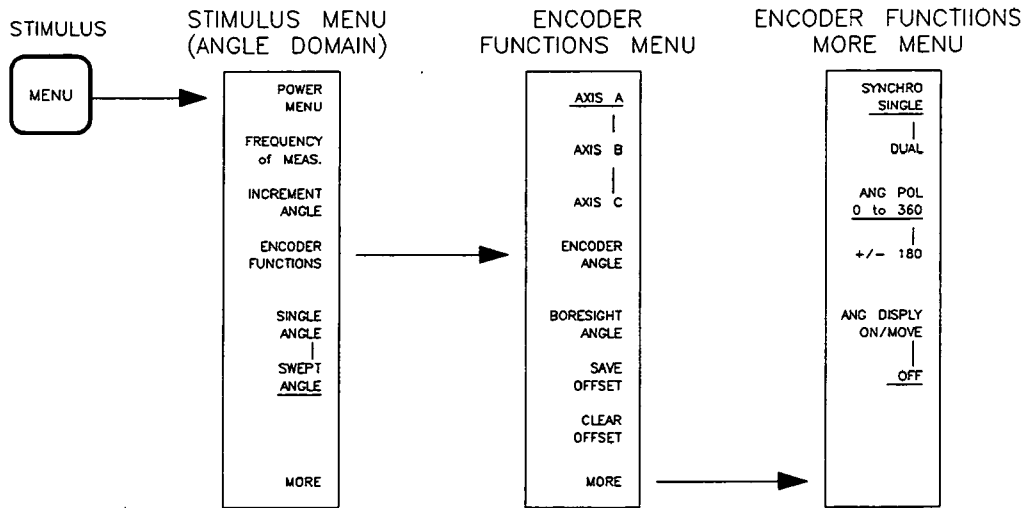

Figure 4-5. Position Encoder (option 005) Softkeys

To access the Position Encoder menus, press:

DOMAIN **ANGLE**

STIMULUS **MENU** **ENCODER FUNCTIONS**

The position encoder softkeys are listed below:

- Position encoder operation functions:

AXIS A, **AXIS B**, or **AXIS C**

BORESIGHT ANGLE

SAVE OFFSET and **CLEAR OFFSET**

- Position encoder configuration functions (press **MORE** to see these functions):

SYNCHRO SINGLE or **DUAL**

ANG POL 0 to 360 or **+/-180**

ANG DISPLY ON/MOVE or **OFF**

HP 85370A Position Encoder Operation

Configuration Functions

Single and Dual Synchro

The single and dual synchro control softkeys are:

SYNCHRO SINGLE Selects single synchro (1:1) operation. This is also referred to as coarse resolution mode. This setting is applied independently to each axis.

DUAL Selects dual synchro (1:1 and 36:1) operation. This is also referred to as fine resolution mode. This setting is applied independently to each axis.

Selecting single and dual synchro mode for any axis. Note: Select single and dual settings independently for each axis.

1. Press: **DOMAIN ANGLE**
STIMULUS (MENU) ENCODER FUNCTIONS
2. Select the desired axis by pressing: **AXIS A**, **AXIS B**, or **AXIS C**
3. Press: **MORE SYNCHRO SINGLE** or **DUAL**
4. Repeat the last two steps for each axis.

Angle Display Modes

The angle display mode softkeys are:

ANG PDL 0 to 360 Causes the HP 8530A and the position encoder to display angles in 0 to 360° format.

+/-180 Causes the HP 8530A and the position encoder to display angles in ±180° format.

ANG DISPLY ON/MOVE This softkey performs two functions:

1. If angle display is already turned ON, this softkey moves the angle readout to a different position on the display. There are five different positions.
2. It turns the angle readout ON if it was previously OFF. This affects the HP 8530A display.

From the Encoder More menu, press **ANG DISPLY ON/MOVE**. The position of the angle readout changes. There are five possible positions. One of the positions is above the Time/Date box, in the lower right-hand corner of the screen. This position cannot be seen if softkeys are being displayed. Press **(PRIOR MENU)** until the softkey menus disappear, and you will be able to see the angle readout.

OFF Turns the HP 8530A angle display OFF.

Operational Functions

Axis Controls

AXIS A, **AXIS B** and **AXIS C** select the axis that is currently in use. Angles are displayed for the selected axis on the HP 8530A and on the position encoder. When you change between axes, the receiver recalls any previously-used offset (described later), and whether single or dual synchro mode was selected.

Boresight Angle

BORESIGHT ANGLE places the active marker at the peak of the antenna pattern. This is the first step during boresighting. Once the active marker is at the peak, you can save this value as an offset. Subsequent measurements will show the peak at 0°. **BORESIGHT ANGLE** turns OFF any delta markers that are in use.

You can also use the normal marker features to place an active marker on boresight. An example of this is provided in "Finding Boresight" in Chapter 5. It is easiest to find boresight using normal marker functions if your antenna has a non-symmetrical shape. Refer to "Using Markers" in Chapter 5 for instructions.

Offset Functions

The softkeys that control angle offset are shown below:

SAVE OFFSET

For use after boresighting. **SAVE OFFSET** "zeros" the angle readout on the receiver and position encoder. *The offset does not take effect until the next angle scan of the positioner.* You would perform this step after using the **BORESIGHT ANGLE** key. (You could also move the active marker to boresight manually, then use **SAVE OFFSET**.)

For example, assume boresight for axis A is at +7 degrees. Assume you have placed the active marker at that position (using normal marker functions or **BORESIGHT ANGLE**). Pressing **SAVE OFFSET** (and taking another sweep) would cause boresight to appear at 0°. All angle readings will be displayed relative to that angle (for that axis only).

CLEAR OFFSET

Clears the offset memory completely and eliminates any offset currently in use.

Details about Save Offset

Offsets are axis-independent. Save Offset operates independently for each of the three axes. The receiver also remembers the offsets you used last for each axis.

Adding incremental offsets. If conditions cause the boresight to change, move the active marker to the new boresight (manually or with **BORESIGHT ANGLE**), and press **SAVE OFFSET** again. (NOTE: you *must* take another sweep before pressing **SAVE OFFSET** a second time.) The incremental change will be added to the offset. **SAVE OFFSET** remembers the first offset you use, and adds or subtracts subsequent **SAVE OFFSET** values incrementally to the original value. You must take a sweep between each press of the **SAVE OFFSET** softkey.

Here is an example of how Save Offset works. Assume boresight for axis A is at +7°. You move the active marker to that angle (by whatever means) and you press **SAVE OFFSET**. Now you measure another sweep. Boresight will now appear to be at 0° (angle readings are offset by 7°).

HP 85370A Position Encoder Operation

Later in the day you change antennas, and boresight moves 1° in a positive direction. If you place a marker at that point, and press **SAVE OFFSET** again, the offset will change by 1° , for a total offset of 8° . Remember, the change will not take effect until the next angle scan.

CLEAR OFFSET clears the offset memory, so you can enter a new starting offset. Offset is actually cleared on the next angle scan.

The offset value is saved with the instrument state when you use the **SAVE** and **RECALL** keys. This allows you to save different offsets in the Save/Recall registers for later use.

Using offset functions. The Offset function is shown in "Finding Boresight" in Chapter 5.

Encoder Settings and Save/Recall Registers

All the encoder configuration and operational settings are saved when you use Save/Recall registers.

Frequency Domain Measurement Tutorial

The following explains how you can customize frequency domain measurements to suit your specific needs.

Step 1. Select Internal Triggering

Press STIMULUS (MENU) MORE TRIGGER MODE TRIG SRC INTERNAL

In internal trigger mode, the receiver makes measurements without requiring any external triggering.

Step 2. Choose a Single Point or Swept Measurement

Next, select whether you want to take a single point of data or a "sweep." A sweep takes a number of data points across the frequency range. Use (START), (STOP), or (CENTER) and (SPAN) keys to enter the desired sweep range. Use NUMBER of POINTS to select the number of frequency points to measure.

The following choices are available (under STIMULUS (MENU)) when using the Frequency or Time Domain.

- Single Point mode
- Ramp sweep mode
- Step sweep mode
- Frequency List mode

Single Point mode

Single Point mode measures a single frequency. This mode is useful when boresighting an antenna or RCS target when you are in the Frequency Domain.

Step Sweep mode

Step Sweep mode measures each stimulus point separately. Step mode is slower than Ramp mode, but provides synthesized frequency accuracy (it phase locks at each frequency point). Use the (START) and (STOP), or (CENTER) and (SPAN) keys to enter the desired sweep range. NUMBER of POINTS specifies the number of frequency points measured. The receiver chooses evenly-spaced measurement points within the selected sweep. This mode is available only with synthesized sources.

To Increase Step Sweep and Frequency List Mode Measurement Speeds

Method 1, check RF (and LO) source versions. Using a newer HP 8360 source, or one that is upgraded as shown in Table B-2, will provide significant speed increases (compared to measurements made with HP 8340/41 or older HP 8360 sources). HP has observed speed increases *up to* a factor of 5 by using the newer HP 8360 sources. After being upgraded, some systems may have speed increases that are less than this, however.

Use Quick Step mode, if possible =steptype>. There is a fast phase-locking mode, called "Quick Step," which increases the speed of Step Sweep measurements *up to* a factor of six. After being upgraded, some systems may have speed increases that are less than this, however. There are two system requirements when using Quick Step mode:

Frequency Domain Measurement Tutorial

- The RF source must be an HP 836xx-family source with a firmware revision that is compatible with Quick Step Mode. A list of these sources is provided in “Fast measurement speed and Quick Step mode” in Appendix B. Specifically, refer to Table B-2.
- Two BNC connections must be made between the RF source and the Receiver. This means that far-field ranges (where the RF source is a great distance away from the receiver) will not be able to use Quick Step mode.

To use Quick Step mode:

1. Connect the receiver's TRIGGER IN BNC to the source's TRIGGER OUT BNC.
2. Connect the receiver's STOP SWP BNC to the source's STOP SWEEP BNC.
3. Press **(SYSTEM) MORE SYSTEM PHASELOCK STEP TYPE: QUICK**

The important facts about the quick-step phaselock method are:

- Each data acquisition point is fully synthesized.
- The source is “tuned” from point-to-point; it does not break phaselock.
- The receiver remains phaselocked to the source except at the source bandcross points or when the test VTO needs to reset.
- Averaging factors above 128 affects Quick Step speed.

The HP 8530A uses **STEP TYPE: NORMAL** if the source is not compatible with quick step. HP 8340/41 sources are NOT compatible with quick step.

Frequency List mode

Frequency List mode allows you to enter a list of specific frequencies that you want to measure. The receiver phase-locks to each frequency. Instructions on creating a frequency list are provided in “Creating a Frequency List” in Chapter 5.

Ramp Sweep mode

Ramp Sweep mode sweeps using an analog or digital frequency-tracking signal from the RF source. Ramp Sweep mode is much faster than Step Sweep or Frequency List mode, but it is not as frequency accurate. (Ramp mode does not phase lock at each frequency, Step and Frequency List modes do.)

To use Ramp mode, BNC cables must be connected between the RF source and the receiver (refer to Figure 4-6). This is why ramp mode is not used in some RCS ranges. In addition, systems that use an LO source cannot use Ramp mode.

Use the **(START)** and **(STOP)**, or **(CENTER)** and **(SPAN)** keys to enter the desired sweep range. Use **NUMBER of POINTS** to enter the desired number of points. The receiver chooses evenly-spaced measurement points within the selected sweep. A larger number of points provides more accuracy, but takes more time to measure.

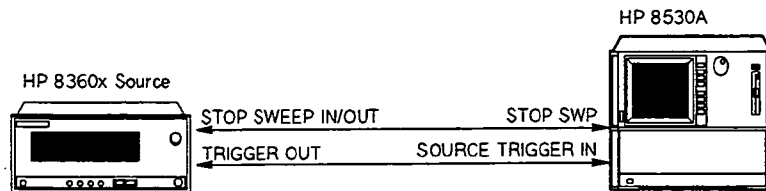

Figure 4-6.
BNC Connection Required when Using Ramp Sweep or Quick Step Modes

In Ramp mode, averaging is performed by repeating entire sweeps (a running average). When using averaging with Ramp mode, you must allow the receiver to sweep a number of times before the data is fully averaged. To determine how many sweeps must be taken, add 1 to the selected averaging factor. For example, if averaging is set to 16, the receiver must take 17 sweeps.

If you are in Continual mode, allow the receiver to sweep the required number of times before using the data. If you are controlling the receiver with a computer, you can set **NUMBER of GROUPS** to the required value. The receiver will take the specified number of sweeps and stop.

In Ramp mode, an HP 836xx-family synthesized source is much more frequency-accurate than a sweep-oscillator source.

Sweep Time

The **SWEEP TIME** softkey in the stimulus menu allows the amount of time it takes to complete a frequency sweep to be changed. If step sweep or frequency list mode is selected, sweep time changes to dwell time and the softkey label changes to **DWELL TIME**. Dwell time is the amount of time the analyzer waits after the source is settled at the frequency point in the frequency list to make a measurement.

To change the sweep time:

1. Press STIMULUS **(MENU)**, **SWEEP TIME**. The current value appears in the active entry area.
2. Use the ENTRY block controls to set the new sweep time. (The unit terminator keys **(x1)** = seconds and **(k/m)** = milliseconds.)

If the sweep/dwell time selected is faster than the response time of the DUT, a distorted measurement response is obtained. Distortion of the trace or an error message indicates the sweep is too fast. In general, the optimum sweep time can be determined using the following formula:

$$SweepTime(s) > \frac{[Span(Ghz)][GroupDelay(ns)]}{100}$$

The length of the dwell time can be determined as follows:

$$DwellTime(ms) = \frac{SweepTime(ms)}{NumberofPoints - 1}$$

Select the fastest possible sweep time or the shortest possible dwell time that does not result in a distortion of the trace. In the ramp sweep mode, the standard preset state selects a sweep time of 166.0 ms per sweep for 51, 101, 201, and 401 points, or 184.0 ms per sweep for 810 points.

Step 3. Choose Single or Continual Measurements

Press STIMULUS **(MENU)** **MORE**. The top four function keys control how many complete measurements should be taken at a time. Here is a description of each:

Single **SINGLE** instructs the receiver to measure one "group" (a complete measurement). When the measurement is done, the receiver goes into Hold mode. (Hold mode is a state where the receiver performs no measurements.) The receiver will wait in hold mode until **SINGLE** is pressed again.

In Step or Frequency List modes, with external triggering, Single measures one frequency point each time a trigger pulse is received. If two or more

Frequency Domain Measurement Tutorial

parameters are measured on each trigger, one data point *for each parameter* is measured.

If you are using internal triggering, Single measures one entire sweep.

Continual Pressing **CONTINUAL** causes the receiver to repeat the measurement continuously.

Step 4. Choose which Parameters to Measure

Press **DISPLAY** **DISPLAY MODE**, then one of the following softkeys:

- **SINGLE PARAMETER**
- **TWO PARAMETER**
- **THREE PARAMETER**
- **FOUR PARAMETER**
- **DUAL CHANNEL**

The function performed by each of these keys is explained earlier in this chapter.

GRATICULE OVERLAY is available when viewing dual channel or four parameter displays. This function superimposes the measurement traces on the same graticule.

SPLIT is also available when viewing dual channel or four parameter displays. This function places data for each channel or parameter on a separate grid.

Common Measurement Tasks

This chapter explains how to perform specific tasks with the HP 8530A. The following subjects are explained:

Chapter Contents

- To Save and Recall Instrument States
- To Use Markers
- To Find Depth of a Null
- To Determine Beamwidth or Bandwidth
- To Display Multiple Channels or Parameters
- To Display a Single Input (Non-Ratioed Measurement)
- To Display Data Relative to the Peak
- To Find Boresight
- To Use Averaging
- To Create a Frequency List
- To Switch Between HP 8530 and 8510 Operation (applies to option 011)

Saving and Recalling Instrument States (Measurement Settings)

The Instrument State contains virtually all instrument settings, including the controlled functions of the source and the frequency converter. The contents of calibration and trace memories are not saved. HP-IB address settings are not saved either. (HP-IB addresses and other configuration-related settings can be stored to a "Hardware State" file. Refer to the *HP 8530A Operating and Programming Manual* for details.

There are eight storage registers for Instrument States, numbered from 1 to 8. After saving several Instrument States, you can instantly change between measurement setups by selecting the desired register. Only one Instrument State is active at any given time.

Saving and Recalling Instrument States

The following steps explain how to store instrument settings to an Instrument State register. They also explain how to recall saved states.

1. Press **SAVE** to bring the Instrument State select menu onto the display.
2. Press the **1** **2** **3** **4** **5** **6** **7** or **8** softkey to save the Instrument State in the corresponding storage register (1 through 8).
3. Press **RECALL** **1** through **8** to recall an Instrument State that you saved earlier.

User Preset

If you save an Instrument State to register 8, that state will be recalled whenever:

- The instrument is turned ON.
- **USER PRESET** is pressed.
- You load a Machine Dump file.

Loading Instrument States From Disc

The receiver has eight Instrument State registers. When you load an Instrument State from disc, you must select the destination register.

Note Simply loading a state from disc *does not* make it the active Instrument State. You must **RECALL** the Instrument State before it will go into effect.



Refer to the next section, Chapter 6, for actual instructions on how to load Instrument States from disc.

Using Markers

Markers show quantitative stimulus and magnitude (or phase) values for a chosen spot on the displayed trace. In typical antenna measurements, markers show the magnitude and angle at the marker's current position. This information is displayed in the *marker data readout*, which is located top-center portion of the display. The most recent marker selected is the *active marker*. Only the active marker can be moved.

Press **MARKER** **MARKER 1** to activate Marker 1. You can move the marker with the knob, step keys, or by entering a specific stimulus value (a specific angle in this case).

Moving the Marker to the Peak

Move the marker to the peak of the main lobe by:

1. Turn a marker ON as explained above.
2. Press **MORE** **MAXIMUM**.

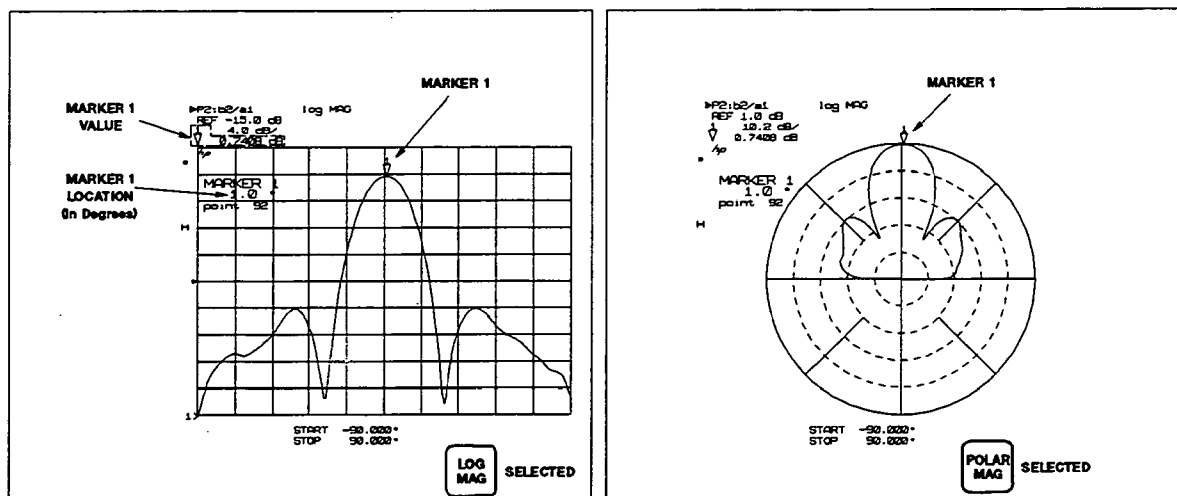

Figure 5-1. Typical Measurement with One Marker

If your receiver is equipped with the HP 85370A Position Encoder, you can find the peak from within the Encoder Functions menu (**STIMULUS** **MENU** **ENCODER FUNCTIONS**). Simply press **BORESIGHT ANGLE**.

Discrete and Continuous Marker Modes

Move marker 1 slowly using the knob. You might notice that it moves in small steps. By default, markers hop from one measurement point to another. This is called the "discrete" marker mode. In discrete mode, markers display actual measurement data for each data point (no interpolation).

You can make the markers move smoothly between points by pressing **MARKER** **MORE** **MORE** **CONTINUAL**. In the continuous mode, markers show straight-line interpolated data values between measurement points. Please set the markers to Continuous mode now.

Using Markers

Turning On Another Marker

Activate a second marker by pressing **MARKER 2**. Did you notice that the Marker 1 screen symbol (∇) changed to a different symbol (Δ)? The ∇ symbol is only used by the active marker, which is now marker 2.

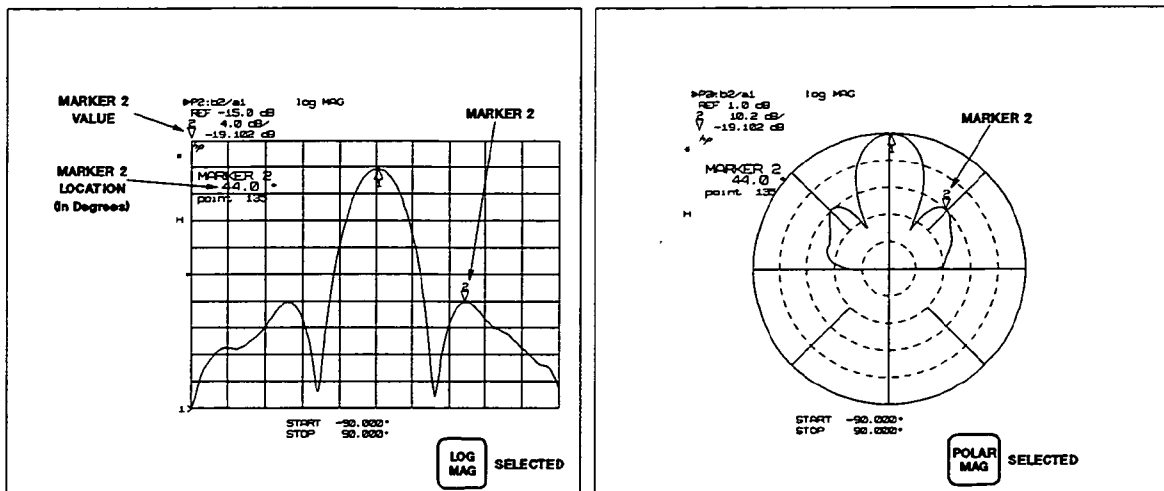

Figure 5-2. Typical Measurement with Two Markers

Marker List Mode

Marker List mode displays four or five marker data readouts simultaneously. To turn Marker List mode ON, press **MARKER MORE MORE MKR LIST ON**. Now, press the **PRIOR MENU** key until no softkey menus are on the screen. You will now see the marker list on the right-hand side of the display.

There are two softkeys that affect what is displayed in the marker list box. Press **MARKER MORE MORE** again. Note the softkeys **ALL PARAM 1 MARKER/** and **5 MARKERS**. These two functions toggle between each other.

If you are displaying one parameter:

These two softkeys do not have any affect on the marker list. The marker list will always show data for *all five* markers, for the *displayed parameter*. (Data is only displayed for markers that are turned ON.)

If you are displaying dual channels:

These two softkeys do not have any affect on the marker list. The marker list will always show data for *all five* markers, for the *active channel*. (Data is only displayed for markers that are turned ON.)

If you are displaying multiple parameters:

ALL PARAM 1 MARKER/ shows four marker values; the value of the *active marker* for each *parameter*. For example, if Marker 2 is active, the trace values for Marker 2 will be displayed for Parameter 1, 2, 3, and 4.

5 MARKERS shows the values for *all five* markers, for the *active parameter only*. (Data is only displayed for markers that are turned ON.)

Using Delta Markers, Target Markers, Marker Search

The Δ (delta) marker mode displays the difference in trace and stimulus values between the active marker and any other marker. An example of delta marker operation is provided in "Finding Depth of a Null".

Finding Depth of a Null

There are two ways to find the depth of a null. Both methods show the value of the null relative to the peak of the main lobe. However, the first method shows angles as relative to the peak, the second method shows actual angles. Here is a description of each method:

Delta Markers	The delta marker feature shows relative stimulus and magnitude values between any two markers. This feature can easily be used to find the depth of a null. This feature shows angles as relative to the reference marker. If the <i>actual</i> angle of the null is important to you, use the "normalize peak" method.
Normalize	The normalize function sets the peak of the main lobe to 0 dB. Marker readouts will show amplitude values relative to the peak, and actual angle values.

Delta Marker Method

1. Move Marker 2 to a null using the knob. (Marker 2 should still be the active marker, you should be able to move it by turning the knob.) The power level at Marker 2 is displayed in the upper-left corner of the screen.
2. Make sure Marker 1 is ON, and is at the peak of the main lobe.
3. To find the depth relative to the peak, press:

MARKER Δ **MODE MENU** Δ **REF = 1**

The command Δ **REF=1** selects marker 1 as the reference marker. The active marker (marker 2) will now show magnitude *and angle* values relative to marker 1. This is illustrated in Figure 5-3.

Using Markers

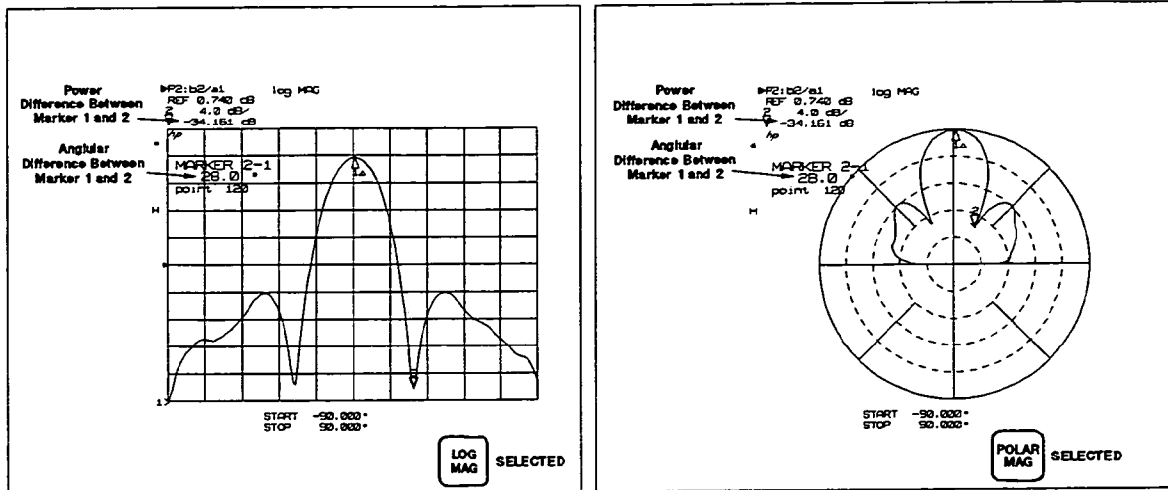

Figure 5-3. Finding Depth of Null Using Delta Markers

Now take the instrument out of delta marker mode by pressing **Δ MODE MENU Δ OFF**.

Normalize Method

1. Make sure delta marker mode is OFF. (Press **MARKER Δ MODE MENU Δ OFF**.)
2. Press **RESPONSE MENU, NORMALIZE MENU, NORMALIZE: ACT. TRACE**.
3. Turn on any marker and move it to the null. The marker data readout will show the amplitude of the null relative to the peak.

Determining Beamwidth or Bandwidth

The receiver can determine beamwidth automatically using the Beam/Band Width function. If the instrument is in Angle Domain, the **BEAM/BAND WIDTH** key determines beamwidth. If the instrument is in Frequency Domain, the **BEAM/BAND WIDTH** key determines bandwidth.

The default "target value" is for beamwidth or bandwidth at -3 dB. The "target value" specifies the dB value (below the peak) where beam width is measured. To set the target value to a different number, press **MARKER MORE TARGET VALUE +/- n (x1)**. Where n is the target value in dB. The **+/-** key is required because the target value is most likely a negative value (-6 dB, and so on).

Press **MARKER MORE BEAM/BAND WIDTH**, the value is now displayed on the screen.

This function uses markers 3, 4, and 5 and automatically turns ON delta markers.

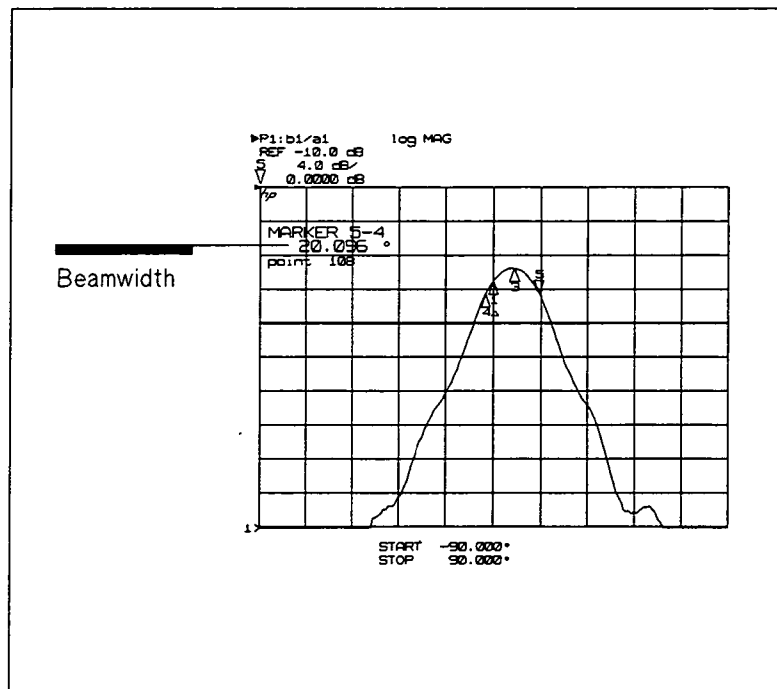

Figure 5-4. Typical Beamwidth Measurement (Angle Domain)

Displaying Multiple Channels or Parameters

The receiver can show more than one measurement on the screen at once. The following modes are provided:

- Single channel showing one, two, three, or four parameters.
- Dual channel showing a single parameter for each channel.

It is important to understand the difference between a “channel” and a “parameter.” Each channel acts like a separate receiver: While in Channel 1 you can choose one combination of measurement settings, then you can select Channel 2 and set up a different combination of settings. There are some restrictions, but this is the basic purpose of the two channels.

A Parameter is simply a choice of the input ratio you are measuring (b2/a1, and so on).

Viewing Two Channels at Once

Assume you make a frequency response measurement on Channel 1. Then you select Channel 2 and select Time Domain. You can view the results separately by pressing **CHANNEL 1** or **CHANNEL 2**.

You can also view both channels at the same time. To do this press **DISPLAY** **DISPLAY MODE** **DUAL CHANNEL**, followed by one of the following softkeys:

GRATICULE OVERLAY superimposes the two measurements on top of one another. This method provides a bigger display size, so details are easier to see.

SPLIT creates two side-by-side display gratitudes; one containing Channel 1 data, the other containing Channel 2 data.

You can change display format, scale, and reference settings independently for each channel. For example, Channel 1 could be set to log mag format with a scale of 4 dB/div, while Channel 2 could be polar format with a scale of 10 dB/div.

Figure 5-5 shows two examples of dual channel display. The example on the left shows split screen mode, the example on the right shows overlay mode. Notice that one marker is turned ON, and that it is present on both channels.

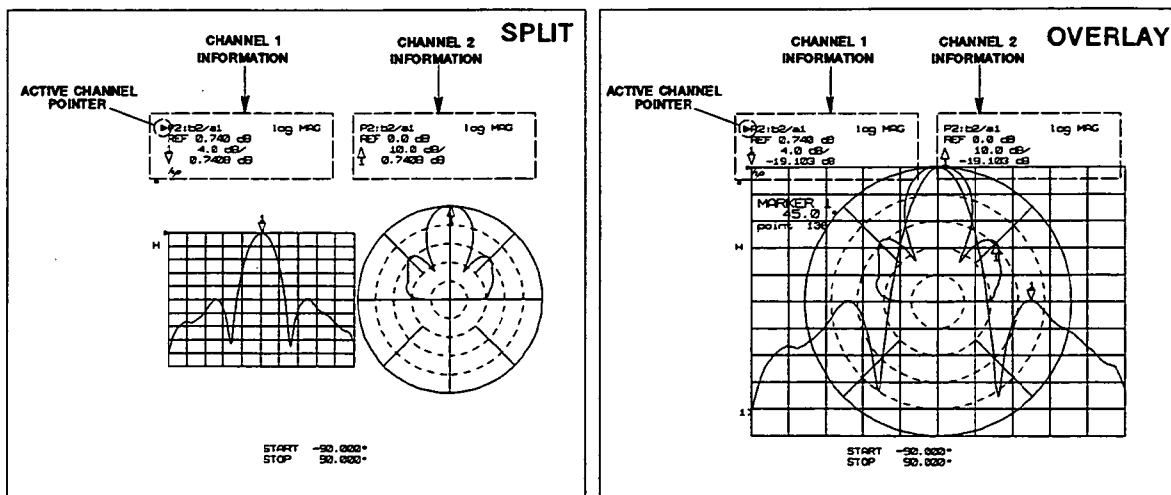

Figure 5-5. Dual Channel Display Options

Viewing Multiple Parameters

You can display two, three, or four parameters on the screen at the same time. To do this:

Press **DISPLAY** **DISPLAY MODE**, then either **TWO PARAMETER**, **THREE PARAMETER**, or **FOUR PARAMETER**.

- To select overlay format, press **GRATICULE OVERLAY**.
- To show each parameter in its own graticule box, press **SPLIT**.

The receiver does not measure a parameter unless it is displayed on the screen.

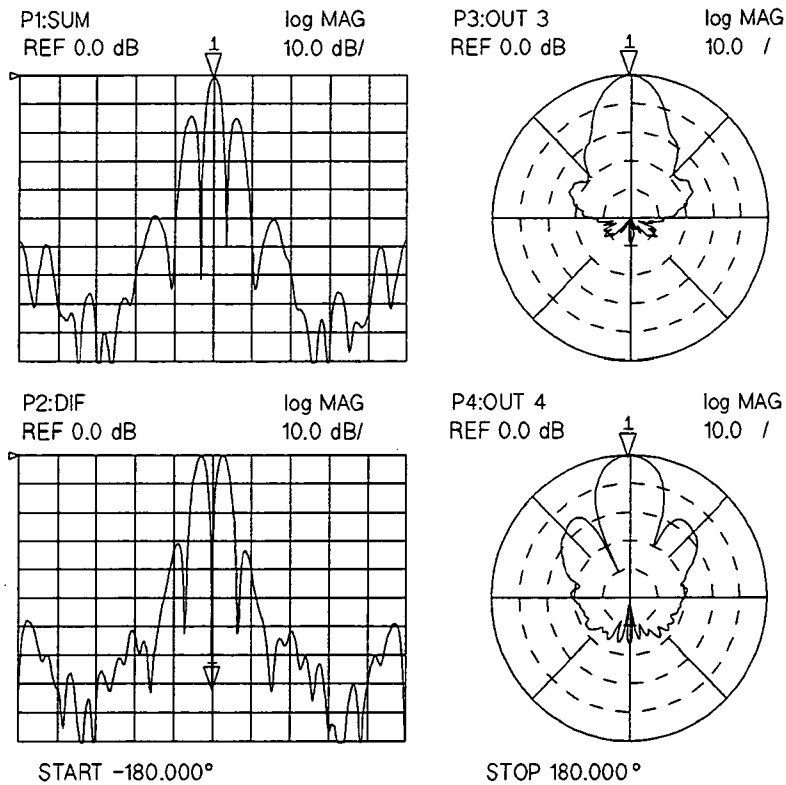

Figure 5-6. Four Parameter Split Display

You can make any parameter the active parameter by pressing **PARAM 1**, **PARAM 2**, **PARAM 3**, or **PARAM 4**.

Important Information about Polar Format

“Polar display format” in Angle Domain is completely different from polar format in Frequency Domain. Refer to Figure 5-7.

Displaying Multiple Channels or Parameters

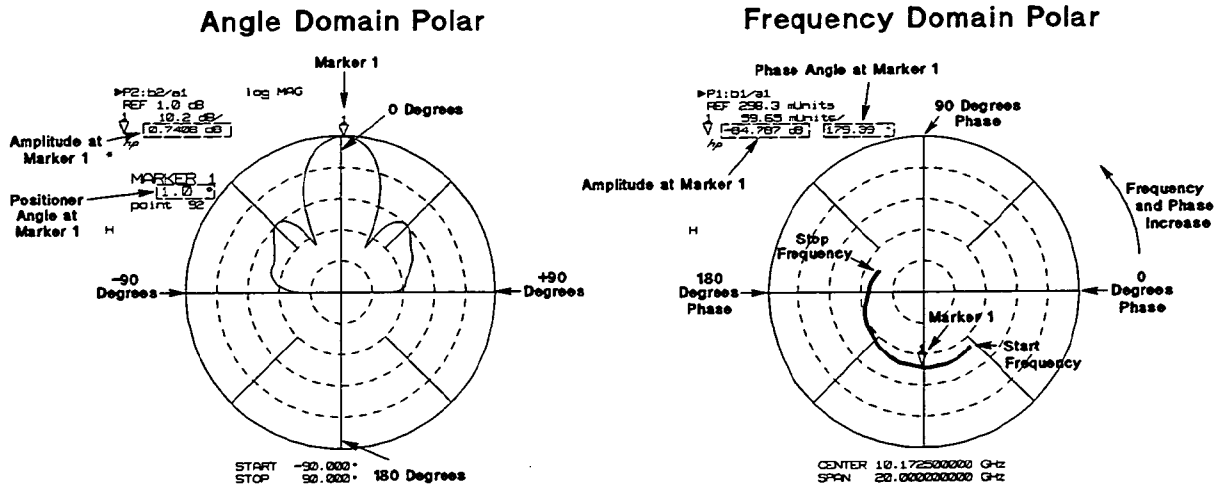

Figure 5-7. Differences in Angle and Frequency Domain Polar Formats

In the Angle Domain the Polar display shows the radiation pattern of the antenna. The magnitude of the data (in dB or dBi) is displayed versus angle. 0 degrees is located at the top-center part of the display. Increasing angle values proceed clockwise.

In Frequency Domain the display shows the magnitude and phase response of the antenna or device under test. 0° phase angle is at the right-hand side of the polar graticule, and increasing phase angles proceed counter-clockwise from zero.

Displaying a Single Input (Non-Ratioed Measurement)

Often one must view a single (non ratioed) input. This is often done when troubleshooting system connections.

Press: **DOMAIN** **FREQUENCY**

Press: **PARAMETER** **MENU** **SERVICE PARAMETERS**

Press **SERVICE 1 a1**, **SERVICE 2 b2**, **SERVICE 3 a2**, or **SERVICE 4 b1** to view the desired input.

Displaying Multiple Channels or Parameters

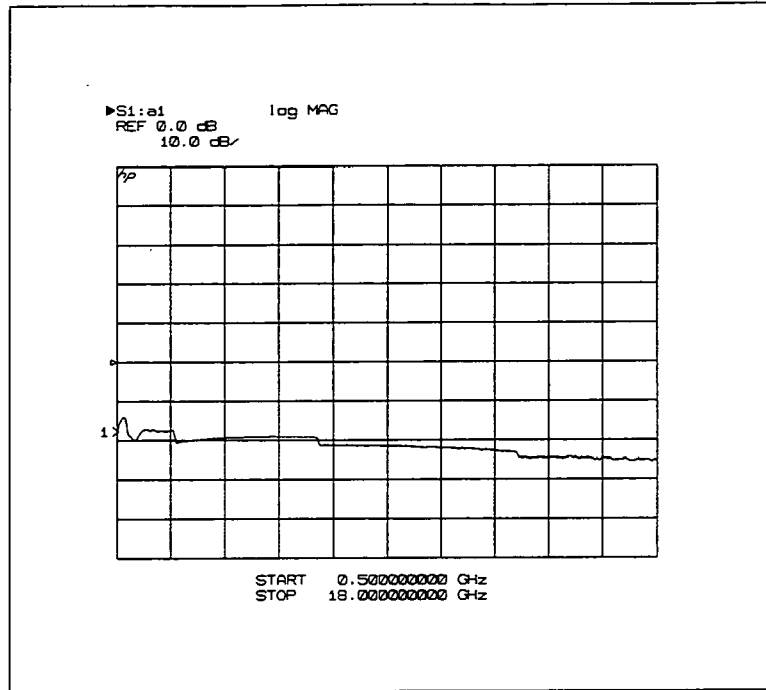

Figure 5-8. Typical Non-Ratioed Measurement of the a1 Receiver Input

Displaying Data Relative to the Peak (Normalizing Data)

Often, one must measure side-lobes relative to the peak of the main lobe. The HP 8530A calls this *normalizing*. To use this feature:

1. Press RESPONSE **MENU**.
2. If you want to see measurement results in a convenient 40 dB format, press **40 dB PATTERN**. This softkey:
 - Sets the reference line to 0 dB.
 - Moves the reference line to the top of the display.
 - Sets display scale so you can see down to -40 dB.
3. Press **NORMALIZE MENU** **NORMALIZE: ACT. TRACE**.

The peak of the active trace will be set to 0 dB, and marker readouts will be relative (in magnitude) to the peak.

If you are displaying multiple parameters, you can normalize the active parameter, and have all the *other* parameters be shown *relative to the active parameter*. To do this press **ALL TO ACT. TRACE**. The normalized peak of the active parameter becomes the reference point of all four parameters.

Finding Boresight

When you have the HP 85370A Position Encoder, you can offset the angular position so that boresight appears to be at 0°. This is done with the **SAVE OFFSET** softkey.

There are two ways to find boresight:

Method 1 This method displays a flat line across the screen. The line represents signal strength. As you move the positioner, the line moves up or down. This method works in Frequency or Angle domain.

Method 2 This method measures the antenna pattern, and allows you to:

1. Automatically find the peak, or:
2. Manually place a marker where you want the boresight to be (useful if boresight is a null).

Boresight Method 1 (Flat Line Method)

To find antenna boresight:

1. Press: **DOMAIN** **ANGLE**
2. Press: **MARKER** **MARKER 1**
3. Press: **STIMULUS** **MENU** **SINGLE ANGLE**
4. Press **FREQUENCY OF MEAS.** and enter the desired measurement frequency.
5. Press **MORE** **CONTINUAL** **PRIOR MENU**
6. If your system has the HP 85370A Position Encoder, press **ENCODER FUNCTIONS**, then press **AXIS A**, **AXIS B**, or **AXIS C**.
7. Select the desired axis on the positioner controller.
8. Move the positioner so the antenna is somewhere near its boresight position (a rough approximation is fine).
9. Move the positioner until the flat line reaches maximum amplitude (or minimum amplitude if your antenna has a null at boresight). It is helpful to watch the marker value readout (in the upper-left portion of the display). This digital readout of the amplitude makes it easy to observe small (0.1 dB) changes. Refer to Figure 5-9.
10. If your system has the HP 85370A Position Encoder, you can press **SAVE OFFSET**. Subsequent measurements will be relative to boresight. This step is not required if you are boresighting for gain calibration purposes.
11. Repeat steps 6 through 10 for each axis. Boresighting is usually interactive between axes, so repeat the boresight procedure for all axes until true boresight is found.

Displaying Multiple Channels or Parameters

Boresight Method 2 (Pattern Display Method)

1. Press: **DOMAIN** **ANGLE**
2. Press: **STIMULUS** **MENU** **SWEPT ANGLE** **MORE** **CONTINUAL**
3. Set up start, stop and increment angle on the receiver and, if necessary, the positioner controller.
4. If the system is equipped with the HP 85370A Position Encoder, press:
PRIOR MENU **ENCODER FUNCTIONS**
Then select the desired axis with **AXIS A**, **AXIS B**, or **AXIS C**.
5. Select the proper axis on the positioner controller.
6. Move the positioner to the start angle.
7. Move the positioner to the Stop Angle. The measurement trace should progress across the receiver's display.
8. Perform this step if your system *has* the HP 85370A Position Encoder:
Press **BORESIGHT ANGLE**. The active marker will be placed at the peak of the measured trace. Usually this is boresight. If this feature chooses a peak that is *not* true boresight, press **MARKER** and move the marker to true boresight. You can now press **SAVE OFFSET** to make the boresight 0°. *Notice that the offset does not take effect until the next sweep*
9. Perform this step if your system *does not* have the HP 85370A Position Encoder:
Press **MARKER** **MORE** **MAXIMUM**.
10. Repeat steps 4 through 8 or 9 for each axis. Boresighting is usually interactive between axes, so repeat the boresight procedure for all axes until true boresight is found.

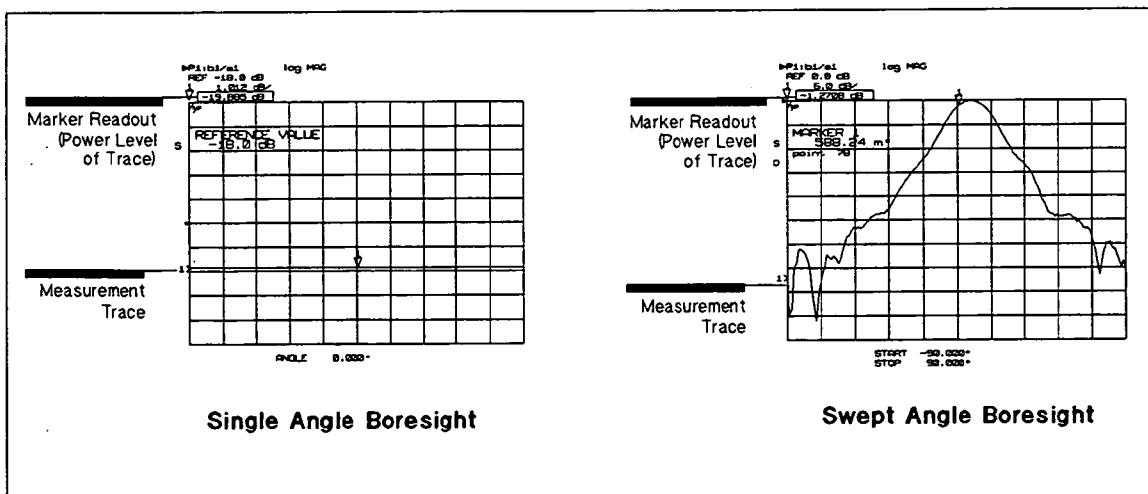

Figure 5-9. Single Angle Boresight (at left) and Swept Boresight (at right)

Using Averaging

Averaging reduces the effects of noise on your measurement. The HP 8530 only uses averaging values in factors of 2^n (2, 4, 8, 16, and so on). You can enter any value you want, but the analyzer will round the value down to the closest factor of 2^n .

For every factor of 2 increase in averaging, you lower effective noise by 3 dB. Averaging is therefore very useful, but it has disadvantages as well. Averaging works by measuring each data point multiple times. (If you select an averaging factor of 16, the instrument has to repeat the measurement at each point 16 times.

To turn averaging ON, press RESPONSE **(MENU)** **AVERAGING ON/restart**, now enter the desired averaging factor and terminate with **(x1)**.

Table 5-1 shows the theoretical sensitivity improvement caused by valid averaging factors.

Table 5-1.
Averaging Factor versus Theoretical Sensitivity Improvement

Averaging Factor	Theoretical Sensitivity Improvement
2	3 dB
4	6 dB
8	9 dB
16	12 dB
32	15 dB
64	18 dB
128	21 dB
256	24 dB
512	27 dB
1024	30 dB
2048	33 dB
4098	36 dB

Creating a Frequency List

Frequency list only applies to Frequency Domain. It provides the capability to measure specific frequencies of interest. The frequency list is made up of segments and each segment may consist of a single CW frequency or a frequency span. The span may be specified using start/stop or center/span frequencies and either a frequency step or number of points.

To use frequency list mode, first create a frequency list (as explained below), then select frequency list mode from the Stimulus softkey menu.

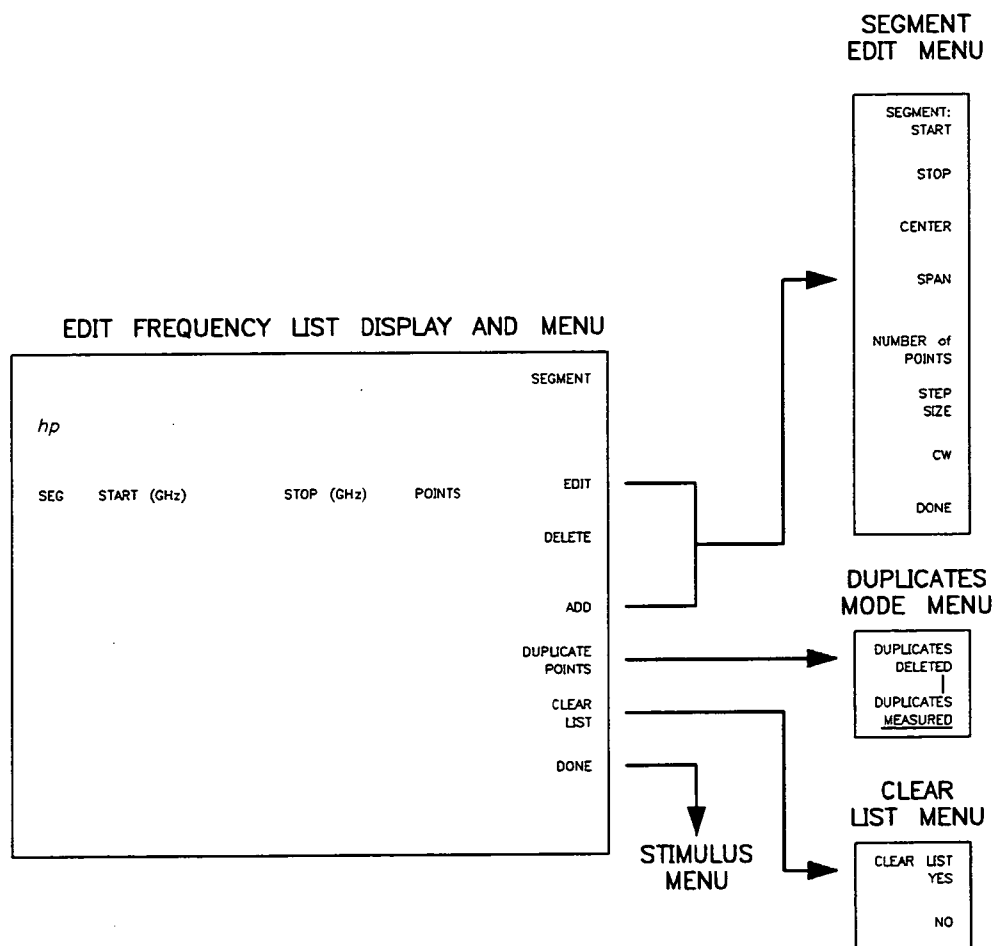

Figure 5-10. Frequency List Menu Structure

Entering the First Segment

To create a frequency list:

1. Press **DOMAIN** **FREQUENCY**.
2. Press **STIMULUS** **MENU**, **MORE**, then **EDIT LIST**. The display appears as shown in Figure 5-10.
3. Press **ADD**. The first segment appears as shown in Figure 5-11.
4. Press **SEGMENT: START** and enter the start frequency of the first segment.

5. Press **SEGMENT: STOP** and enter the stop frequency of the segment.
6. Press **SEGMENT: STEP SIZE** and enter the desired increment frequency.
7. Press **SEGMENT: DONE**. Now press **DONE** again to return to the main stimulus menu, then press **FREQUENCY LIST**. The frequency list mode is now ON. The next sweep will use the frequencies from the list.

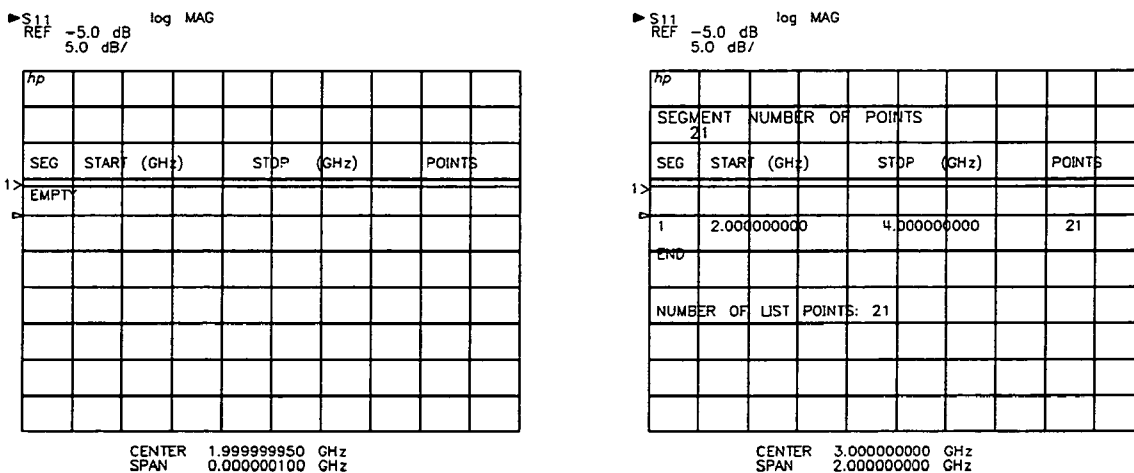

Figure 5-11. Enter the First Segment

Add Segments

To add a segment to the list:

1. Press **EDIT LIST**, then press **ADD**. Each time you press **ADD** the current segment is duplicated.
2. Enter new segment values by following the instructions given previously, then press **SEGMENT: DONE**.

The segments do not have to be entered in any particular order, they are sorted automatically by start or CW frequency each time you press **SEGMENT: DONE**. If you try to add more than the maximum allowed number of segments or frequency points, a warning message is displayed.

Editing the Frequency List

The following section explains how to change or delete an existing segment, or add new segments to an existing frequency list.

Changing a Segment

To change the contents of the list, press **EDIT LIST** to display the edit frequency list menu, press **SEGMENT** to choose a segment, then press **EDIT**.

The **SEGMENT** key determines the segment to be edited or deleted. Press **SEGMENT** then enter the number of the segment in the list or use the knob or step keys to scroll the pointer > to the

Creating a Frequency List

segment number. Press **EDIT** to edit the current segment. The segment edit menu appears, allowing you to change any of the segment characteristics.

Please note that the **START**, **STOP**, **CENTER**, and **SPAN** keys in the **STIMULUS** block are not used during the frequency list editing process.

For example, enter a frequency list as follows:

1. Press **STIMULUS** **MENU**, **MORE** **EDIT LIST**.
2. Press the following keys:
 - a. **ADD SEGMENT: START** **2** **G/n**.
 - b. **SEGMENT: STOP** **4** **G/n**.
 - c. **SEGMENT: STEP SIZE** **100** **M/μ**.
 - d. **SEGMENT: DONE** **DONE** **FREQUENCY LIST**.

The frequency list sweep starts.

In the frequency list mode, you may edit, add, and delete the segments while making a measurement. When you press **SEGMENT: DONE**, the frequency list segments are arranged in ascending order, and the measurement restarts using the new frequencies.

Deleting a Segment

When you press **DELETE** the current segment is deleted.

Adding a Segment

Now add a segment to the list as follows:

1. Make sure the receiver is in Frequency Domain.
2. Press **STIMULUS** **MENU** **MORE** **EDIT LIST**.
3. Press the following:
 - a. **ADD SEGMENT: START** **4** **G/n**
 - b. **SEGMENT: STOP** **3** **G/n**
 - c. **SEGMENT: STEP SIZE** **200** **M/μ**
 - d. **SEGMENT: DONE**

The sweep restarts and the new list is measured.

Duplicate Points

If you followed the above sequence, notice that the point at 4 GHz is brighter. This is because it is being measured and plotted twice. Later, in Chapter 7, you will see that you can print the list of measured frequencies and values in tabular format. If you performed this operation you would see that 4 GHz is listed twice. If this is an undesired duplication, press **DUPLICATE POINTS**, then **DUPLICATES DELETED**. On the next measurement, each point is measured and displayed only once (duplicates are ignored).

Selecting All Segments or a Single Segment

When you press **FREQUENCY LIST** with more than one segment defined, the menu allows selection of either **ALL SEGMENTS** or **SINGLE SEGMENT**. Pressing **SINGLE SEGMENT** causes the currently-selected segment to become the active segment. The receiver will begin to measure that segment (assuming the receiver is not in HOLD mode). Use the step keys, knob, or numeric entry to select the segment for measurement.

Figure 5-12 shows the display when the complete frequency list is swept, then after a single segment is selected. The current listing of frequency list segments is displayed with the arrow pointing to the current segment. If you do not want the frequency list displayed, press **STIMULUS (MENU)** and it disappears - but segment number remains the active function. Note that the Stimulus values at the bottom of the display show the actual frequency range being measured.

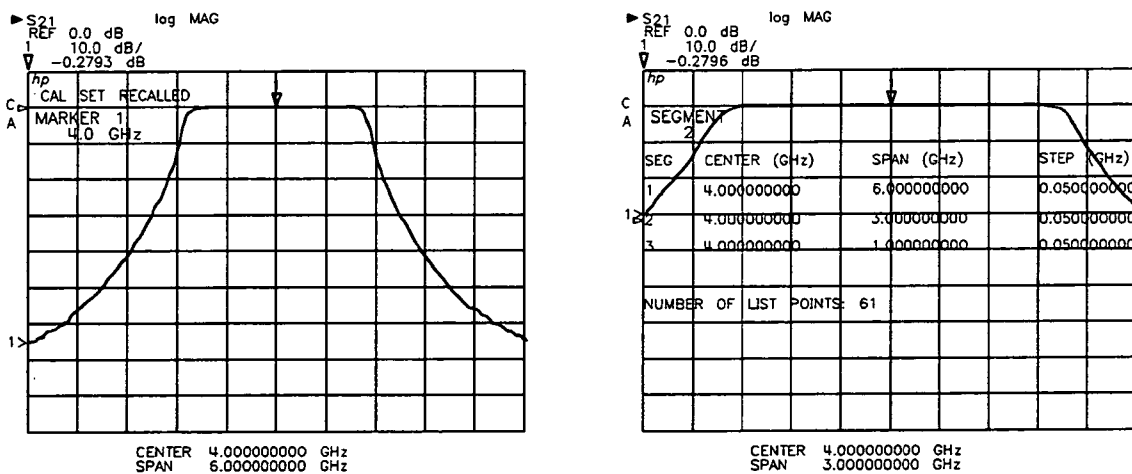

Figure 5-12. Frequency List, Display of Single Segment

Frequency List Save and Recall

You can save the current frequency list in the same way as any Instrument State is saved, by using the **(SAVE)** and **(RECALL)** keys.

Exit Frequency List

To exit the frequency list mode, press **STIMULUS (MENU)**, then press **RAMP**, **STEP**, or **SINGLE POINT**. The frequency endpoints of the frequency list are used for the ramp or step sweep.

FACTORY PRESET clears the frequency list.

Switching Between HP 8530 and 8510 Operation

HP 8530As with Option 011 can be switched back and forth between HP 8530 and HP 8510 operation. To switch "modes" you must reload the appropriate operating system from disc. Hewlett-Packard recommends that you make copies of the original operating system discs, and place the originals in a safe place. Refer to "Copying the Operating System Discs".

Changing between Operating Systems

1. Press **SYSTEM** **MORE** **SERVICE FUNCTIONS** **TEST MENU**.
2. Insert your working copy of the operating systems, press **1** **9** **=MARKER**. A disc directory will appear, listing the operating system files on the disc.
 - a. Use the **▼** key (if necessary) to select the desired operating system.
 - b. Press **LOAD FILE**.

Once the operating system loads the instrument will preset.

How Changing Operating Systems Affects Instrument Registers

When you load a different operating system, all the following registers are erased (or are filled with default values):

- Instrument State registers.
- Memory registers.
- Cal sets.
- User-Loaded cal kit definitions.
- Delay table.
- User display graphics.

Here is a helpful suggestion for those who switch between HP 8510 and 8530 operation often: You can save all of the above registers to a single disc file (called a "machine dump" file). Here is how:

1. Set up the instrument the way you want it.
2. Save the setup to Save Register 8 (this is important).
3. Save the machine dump file to disc by pressing:

DISC **STORE** **MORE** **MACHINE DUMP**, enter a title, then press **STORE FILE**.

Later, when you load the desired operating system, you can also load the appropriate machine dump file. The instrument will return to the exact state it was in before.

Note



Be sure to use different file names for the two machine dump files.

One high-capacity disc can hold two operating system files plus two machine dump files. One low-capacity disc can hold one operating system with one machine dump file.

Copying the Operating System Discs

HP recommends that you create a copy of each operating system on blank discs. When you load an operating system, use the copies. This is especially important in systems that must be switched between HP 8510 and 8530 operation often.

This procedure assumes that the HP 8530A operating system is currently loaded.

Copying the HP 8530A Operating System to Disc

This procedure assumes you are using high-capacity 1.44 Mbyte discs (Black HP discs). High-Capacity discs let you save both HP 8510 and 8530 operating systems on a single disc.

1. Press **(SYSTEM) MORE SERVICE FUNCTIONS TEST MENU**.
2. Make sure the disc is not write-protected. The write-protect window must be *fully closed*.
3. Insert the disc into the drive slot (the label-side of the disc must face left). Initialize the disc by pressing **(2) (1) (=MARKER)**.

Note



You can skip the previous step if the disc is already initialized. *However, the disc must be initialized using LIF format. The HP 8530A cannot store operating system files to DOS-format discs.*

4. Save the current operating system by pressing **(2) (0) (=MARKER)**.
5. The "label maker" menu now appears. The proper file name prefix "PG_" is already entered for you. Use the character-selector controls to add "8530" to the file name.
Press **STORE FILE**. The instrument will preset when the file is stored. Remove the disc and label it.

Copying the HP 8510C Operating System to Disc

1. Press **(SYSTEM) MORE SERVICE FUNCTIONS TEST MENU**.
2. Insert the HP 8510C operating system disc, press **(1) (9) (=MARKER)**.
3. Press **LOAD FILE** to load the default file (the operating system file). Once the operating system loads the instrument will preset.
4. Press **(SYSTEM) MORE SERVICE FUNCTIONS TEST MENU**.
5. Insert the disc you used to store the HP 8530A operating system.
6. Save the new operating system by pressing **(2) (0) (=MARKER)**.
7. Press **DEFAULT TITLE STORE FILE**. The instrument will preset when the file is stored. Remove the disc and label it.

Use this "working copy" of the operating systems whenever you have to reload.

Free Manuals Download Website

<http://myh66.com>

<http://usermanuals.us>

<http://www.somanuals.com>

<http://www.4manuals.cc>

<http://www.manual-lib.com>

<http://www.404manual.com>

<http://www.luxmanual.com>

<http://aubethermostatmanual.com>

Golf course search by state

<http://golfingnear.com>

Email search by domain

<http://emailbydomain.com>

Auto manuals search

<http://auto.somanuals.com>

TV manuals search

<http://tv.somanuals.com>