

# 2-WIRED VIDEO ENTRY SECURITY SYSTEM

Model; **MY-1AD** (Room station with video monitor)

## INSTRUCTIONS

# 1

## NAMES AND FUNCTIONS

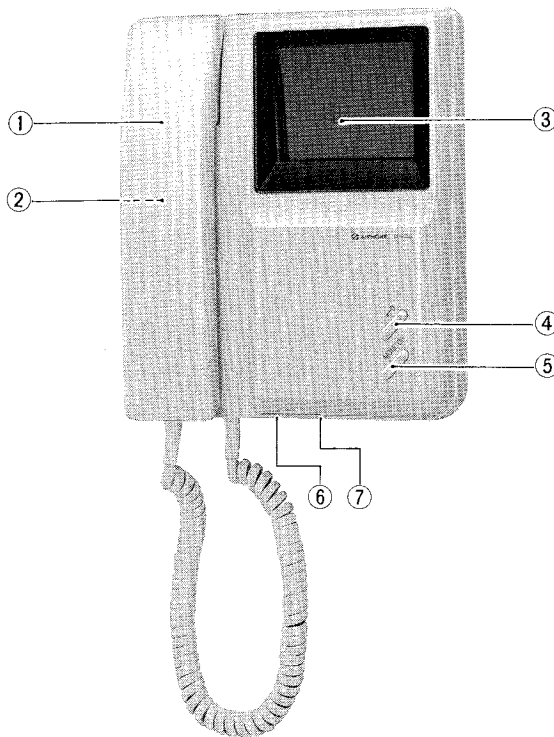

### MY-1AD

- ① Handset
- ② Chime volume control
- ③ Video monitor (4" CRT)
- ④ DOOR RELEASE button
- ⑤ Video monitor button
- ⑥ Contrast switch
- ⑦ Brightness control

### Mounting accessories;

Stand & screw (x 2)  
(for desk use)

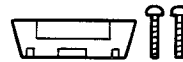

Screw (x 4)  
(for mounting  
to gang box)

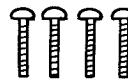

Wood screw (x 4)  
(for mounting  
to wall surface)

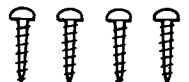

Wall-mounting  
bracket

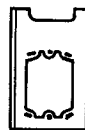

# 2

## SYSTEM FEATURES

- \*MY-1AD is a room master station with built-in video monitor for use with MY-DA video doorstation.
- \*Confirm a caller visually before you answer.  
Picture comes on at video monitor right after call button is pressed on video doorstation.
- \*Employs a 4- inch direct view and flat screen monitor.
- \*Monitor button allows you to see the outside without picking up handset.
- \*Door release button to activate electric door release.

# 3

## BEFORE YOU INSTALL AND OPERATE THE EQUIPMENT — Prohibitions and precautions —

### Operation

DO NOT HOLD HOOK SWITCH DOWN BY BALL-POINT PEN, ETC. WHILE PICKING UP HANDSET. THE CHIME TONE SOUNDS THRU THE HANDSET RECEIVER ELEMENT AND COULD CAUSE HEARING DAMAGE.

### Installation

- DO NOT CONNECT ANY TERMINAL ON ANY UNIT TO AC POWER LINES.  
When you mount MY-1AD unit in place of existing bell or chime, be sure to disconnect wires from the present transformer.
- DO NOT OPEN THE FRONT COVER OF MY-1AD UNIT, WITHOUT FIRST REMOVING PLUG OF POWER SUPPLY FROM AC OUTLET.  
The high voltage is loaded on the monitor unit inside.
- Do not drop or hit the unit. This may cause damage to the picture tube.
- Avoid running the connecting wires through doors, windows or between furniture, which may pinch and disconnect the wires.
- IMPORTANT** —  
Use a parallel 2-conductor cable. When using existing two wires, strictly observe that the two wires are of the same cable. Do not use any of the following wires, as they will seriously affect the quality of picture and communication.  
\*coaxial cable; \*two separate and individual wires; \*a pair in multi-conductor cable.
- In case noise from power supply line is induced, take terminal on MY-1AD unit to earth ground.

### Installation location

- Do not install MY-1AD unit in a place where it is exposed to;  
\*direct sunlight, \*air conditioner heat, \*frost, \*vapor, \*water, \*chemicals, \*iron dust, etc.

### Installation height

Determine MY-1AD installation height so that the center of the video monitor would be at the convenient eye level: adults' average height minus 100 mm (4").

### Maintenance

- Clean your MY-1AD equipment with a soft cloth dampened with neutral household cleanser. Never use thinner nor lacquer, benzine, etc.
- Do not splash water directly on unit.

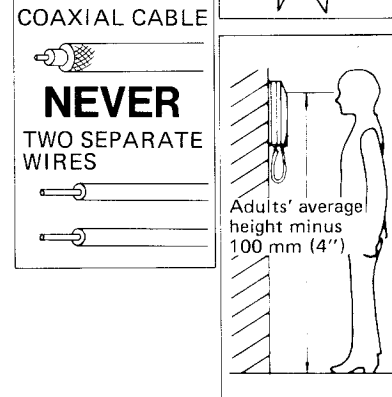
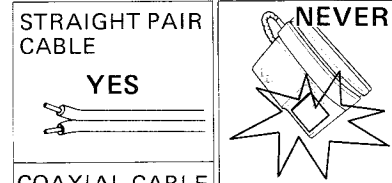
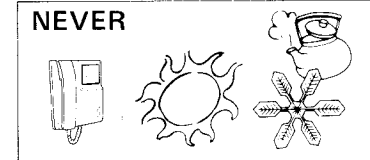
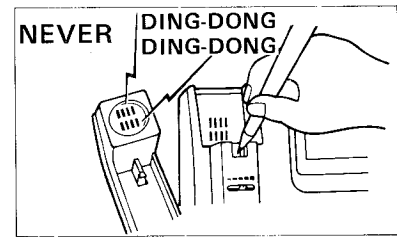

# 4

## SYSTEM COMPONENTS

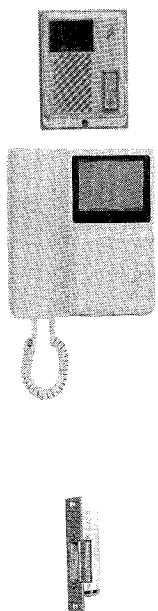

MODELS	DESCRIPTION	QTY (per system)	REMARKS
MY-DA	Video door station, with plastic cover.	1	Surface-mounts on single-gang box or wall.
MY-1AD	Room master station with video monitor.	1	Surface-mounts on single-gang box or wall (bracket included). Can be placed on desk, using a stand supplied.
PS-18YB	Power supply adaptor. Modular type, DC 18V.	1	
PS-18YC	AC 120V, 50/60 Hz.		
PS-18YD	AC 220-240V, 50/60 Hz.		
IER-2	Call extension speaker.	1	
EL-9S	Electric door release. AC 12V, 0.35A.	1	

Note: MY-DA & MY-1AD are available in a set box, together with power supply.  
Models: MYS-1ADP(B), MYS-1ADP(C) & MYS-1ADP(D), each with PS-18YB, PS-18YC & PS-18YD.

# 5

## INSTALLATION

### (1) Actual terminal location

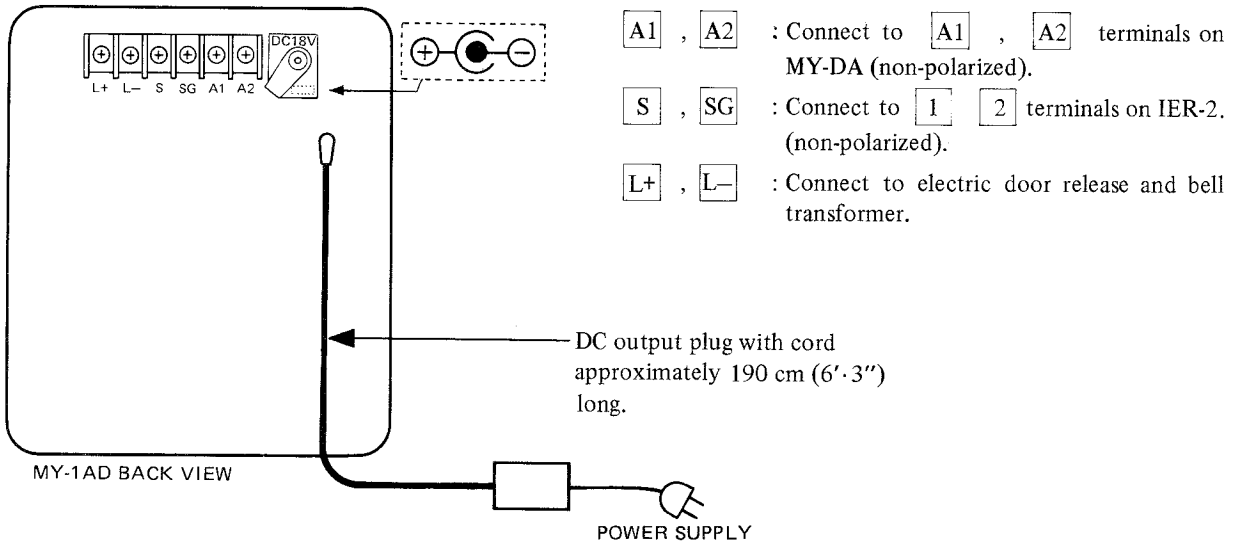

### (2) Wall mounting

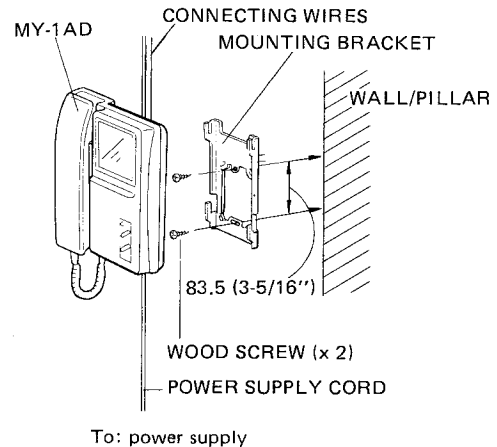
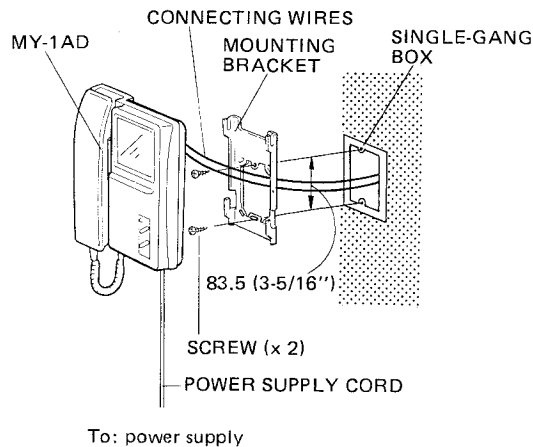

### (3) Desk-top use

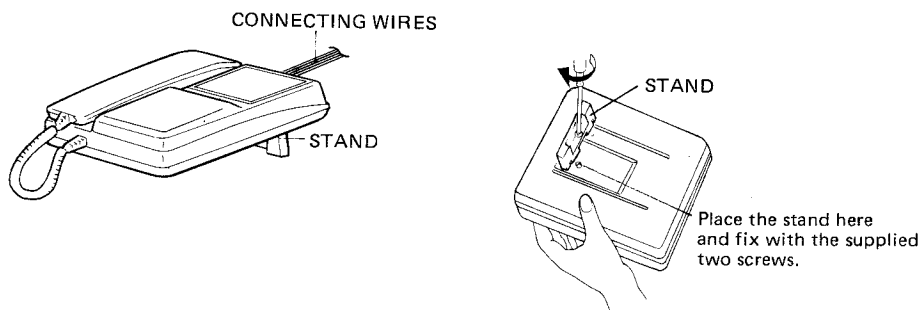

Select a location where the MY-1AD unit will not fall or where the cable may cause tripping.

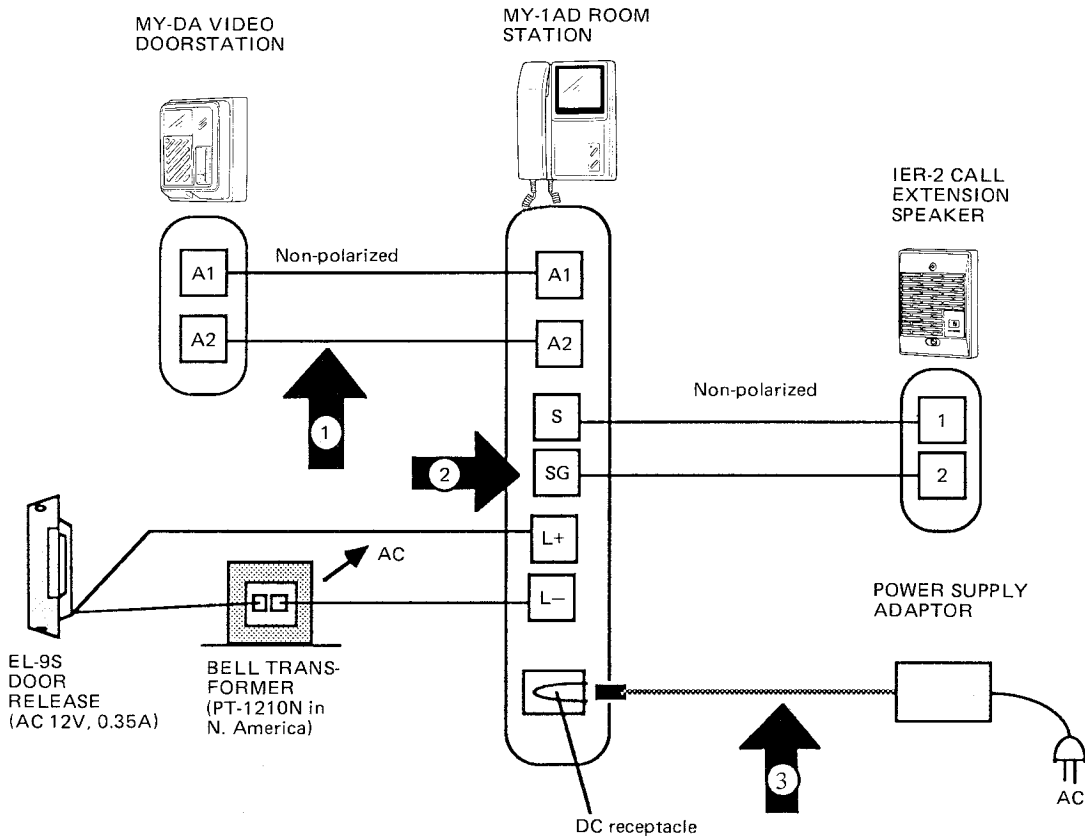

**NOTES;**

- 1** →
- 2** →
- 3** →

For connecting between video door station and MY-1AD, do not use coaxial cable, or two separate and individual wires or a pair in multi-conductor cable. Use only a straight 2-conductor cable.

In case noise from power supply line is induced, take terminal on the MY-1AD unit to earth ground.

Locate MY-1AD unit within convenient reach of AC outlet. — DC output cord length: approx. 1.9 m (6'·3"). Do not attempt to lengthen the DC output cord. It will seriously affect the quality of the picture and communication.

# 7 OPERATIONS

## • Receiving a call from doorstation;

- ① Momentarily depress CALL button.
- ② 4-stroke chime sounds and picture appears instantly.
- ③ Pick up handset to reply. When the picture shuts off, depress MONITOR button.
- ④ To activate the electric door release, depress and hold DOOR RELEASE button.  
The visitor may open while the buzzing sound is heard.

**NOTE:**  
If you do not reply, the picture shuts off approximately 45 seconds after chime tone sounds.

## • Monitoring the entrance area;

Depress MONITOR button.  
The picture appears on the monitor for approximately 2 and half minutes.  
Depress MONITOR button again to cancel.

**NOTE;**  
Inside sound will not be heard at the doorstation.

## • Adjusting contrast;

LEFT	MIDDLE	RIGHT
DAY · NIGHT	DAY · NIGHT	DAY · NIGHT
SOFT	MEDIUM	STRONG

(BOTTOM VIEW)

Can be adjusted to 3 levels as desired.  
At the entrance where it is dark even in the daytime, put the adjustment switch to the NIGHT position and turn down the brightness.

## • Adjusting brightness;

(BOTTOM VIEW)

Turn the knob counterclockwise to make the picture brighter.

## • Adjusting chime volume;

HIGHER  
LOWER

The chime call tone can be adjusted from low to high volume according to the room conditions.

# 8

## SPECIFICATIONS

- \*Power source : DC 18V. Use a power supply adaptor PS-18YB, 18YC or 18YD.
- \*Current consumption : 0.9A maximum. 0.15A in standby mode.
- \*Calling : 4-stroke electronic chime
- \*Communication : Simultaneous with handset.
- \*Wiring : Single pair, straight conductors (non-polarized) between video door station and MY-1AD.

\*Wiring distance :

Diameter	0.65 mm	1.0 mm
Distance	50 m	100 m
AWG	22 AWG	18AWG
Distance	165'	330'

- \*Video monitor : 4 inch direct view CRT.
- \*Scanning line : 525 lines.
- \*Dimensions : H: 210 mm × W: 186 mm × D: 53.5 mm (8-1/4" × 7-5/16" × 2-1/8")
- \*Weight : Approx. 1.1 kg (2.43 lbs.).

### WARRANTY

Aiphone warrants its products to be free from defects of material and workmanship under normal use and service for a period of one year after delivery to the ultimate user and will repair free of charge or replace at no charge, should it become defective upon which examination shall disclose to be defective and under warranty. Aiphone reserves unto itself the sole right to make the final decision whether there is a defect in materials and/or workmanship; and whether or not the product is within the warranty.

This warranty shall not apply to any Aiphone product which has been subject to misuse, neglect, accident, or to use in violation of instructions furnished, nor extended to units which have been repaired or altered outside of the factory.

This warranty does not cover batteries or damage caused by batteries used in connection with the product.

This warranty covers bench repairs only, and any repairs must be made at the shop or place designated in writing by Aiphone. Aiphone will not be responsible for any costs incurred involving on site service calls.

Aiphone Co., Ltd., Nagoya, Japan  
Aiphone Corporation, Bellevue, Washington, USA



INTERCOM SYSTEMS  
**AIPHONE**  
HOME, BUSINESS, INDUSTRY

MY-1AD-I(E)0890F

Printed in Japan (E)

## Free Manuals Download Website

<http://myh66.com>

<http://usermanuals.us>

<http://www.somanuals.com>

<http://www.4manuals.cc>

<http://www.manual-lib.com>

<http://www.404manual.com>

<http://www.luxmanual.com>

<http://aubethermostatmanual.com>

Golf course search by state

<http://golfingnear.com>

Email search by domain

<http://emailbydomain.com>

Auto manuals search

<http://auto.somanuals.com>

TV manuals search

<http://tv.somanuals.com>