

# **ASUS<sup>®</sup> AP130**

## **Pentium<sup>®</sup> 4 Pedestal Server**

### **User's Manual**



# Disclaimer/Copyrights

No part of this manual, including the products and software described in it, may be reproduced, transmitted, transcribed, stored in a retrieval system, or translated into any language in any form or by any means, except documentation kept by the purchaser for backup purposes, without the express written permission of ASUSTeK COMPUTER INC. ("ASUS").

ASUS PROVIDES THIS MANUAL "AS IS" WITHOUT WARRANTY OF ANY KIND, EITHER EXPRESS OR IMPLIED, INCLUDING BUT NOT LIMITED TO THE IMPLIED WARRANTIES OR CONDITIONS OF MERCHANTABILITY OR FITNESS FOR A PARTICULAR PURPOSE. IN NO EVENT SHALL ASUS, ITS DIRECTORS, OFFICERS, EMPLOYEES OR AGENTS BE LIABLE FOR ANY INDIRECT, SPECIAL, INCIDENTAL, OR CONSEQUENTIAL DAMAGES (INCLUDING DAMAGES FOR LOSS OF PROFITS, LOSS OF BUSINESS, LOSS OF USE OR DATA, INTERRUPTION OF BUSINESS AND THE LIKE), EVEN IF ASUS HAS BEEN ADVISED OF THE POSSIBILITY OF SUCH DAMAGES ARISING FROM ANY DEFECT OR ERROR IN THIS MANUAL OR PRODUCT.

Product warranty or service will not be extended if: (1) the product is repaired, modified or altered, unless such repair, modification or alteration is authorized in writing by ASUS; or (2) the serial number of the product is defaced or missing.

Products and corporate names appearing in this manual may or may not be registered trademarks or copyrights of their respective companies, and are used only for identification or explanation and to the owners' benefit, without intent to infringe.

The product name and revision number are both printed on the product itself. Manual revisions are released for each product design represented by the digit before and after the period of the manual revision number. Manual updates are represented by the third digit in the manual revision number.

For previous or updated manuals, BIOS, drivers, or product release information, contact ASUS at <http://www.asus.com.tw> or through any of the means indicated on the following page.

SPECIFICATIONS AND INFORMATION CONTAINED IN THIS MANUAL ARE FURNISHED FOR INFORMATIONAL USE ONLY, AND ARE SUBJECT TO CHANGE AT ANY TIME WITHOUT NOTICE, AND SHOULD NOT BE CONSTRUED AS A COMMITMENT BY ASUS. ASUS ASSUMES NO RESPONSIBILITY OR LIABILITY FOR ANY ERRORS OR INACCURACIES THAT MAY APPEAR IN THIS MANUAL, INCLUDING THE PRODUCTS AND SOFTWARE DESCRIBED IN IT.

**Copyright © 2002 ASUSTeK COMPUTER INC. All Rights Reserved.**

Product Name:	<b>ASUS AP130</b>
Manual Revision:	<b>1.00 E945</b>
Release Date:	<b>February 2002</b>

# Contents

Disclaimer/Copyrights .....	2
ASUS Contact Information .....	6
FCC/CDC Statements .....	7
Safety Precautions .....	8
<b>Introduction: About This Manual .....</b>	<b>9</b>
Audience .....	10
Contents .....	10
Conventions .....	11
References .....	11
System Package Contents .....	12
<b>Chapter 1: System Overview .....</b>	<b>13</b>
1.1 System Features .....	14
1.2 Front Panel Features .....	15
1.3 Rear Panel Features .....	16
1.4 Internal Features .....	17
<b>Chapter 2: Hardware Setup .....</b>	<b>19</b>
2.1 Remove the Chassis Cover .....	20
Unlock the side cover .....	20
Remove the side cover .....	20
2.2 Motherboard Placement .....	21
Placement Direction .....	21
Motherboard Screws .....	21
2.3 Install a CPU .....	22
CPU Socket Location .....	22
CPU Orientation .....	22
Unlock the CPU Socket .....	23
Insert the CPU .....	23
Secure the CPU .....	23
Install the Fan Heatsink Assembly .....	24
2.4 Install System Memory .....	26
DIMM Sockets Location .....	26
Install a DIMM .....	26

# Contents

<b>2.5</b>	<b>Install a Hard Disk Drive</b> .....	<b>27</b>
	Remove the HDD/Floppy Cage .....	27
	Install the HDD .....	28
	Connect the Cables .....	28
<b>2.6</b>	<b>Replace the Cover</b> .....	<b>29</b>
	Re-install the Cover .....	29
<b>Chapter 3: Powering Up</b> .....		<b>31</b>
<b>3.1</b>	<b>Getting Started</b> .....	<b>32</b>
	Connect a Monitor .....	32
	Connect the Power Cord .....	32
	Power On .....	32
	Check Power Status .....	32
<b>Appendix A: Power Supply</b> .....		<b>33</b>
<b>A.1</b>	<b>General Description</b> .....	<b>34</b>
<b>A.2</b>	<b>Specifications</b> .....	<b>35</b>
	Input Characteristics .....	35
	Output Characteristics .....	35
	Over-Voltage Protection (OVP) .....	35
<b>Appendix B: Troubleshooting</b> .....		<b>47</b>
<b>B.1</b>	<b>Simple Fixes</b> .....	<b>48</b>

# ASUS Contact Information

## ASUSTeK COMPUTER INC. (Asia-Pacific)

Address: 150 Li-Te Road, Peitou, Taipei, Taiwan 112  
General Tel: +886-2-2894-3447  
General Fax: +886-2-2894-3449  
General Email: info@asus.com.tw

### *Technical Support*

MB/Others (Tel): +886-2-2890-7121 (English)  
Notebook (Tel): +886-2-2890-7122 (English)  
Desktop/Server (Tel): +886-2-2890-7123 (English)  
Support Fax: +886-2-2890-7698  
Support Email: tsd@asus.com.tw  
Web Site: www.asus.com.tw  
Newsgroup: cscnews.asus.com.tw

## ASUS COMPUTER INTERNATIONAL (America)

Address: 6737 Mowry Avenue, Mowry Business Center,  
Building 2, Newark, CA 94560, USA  
General Fax: +1-510-608-4555  
General Email: tmd1@asus.com

### *Technical Support*

Support Fax: +1-510-608-4555  
Notebook (Tel): 1-877-918-ASUS (2787)  
Web Site: www.asus.com  
Support Email: tsd@asus.com

## ASUS COMPUTER GmbH (Europe)

Address: Harkortstr. 25, 40880 Ratingen, BRD, Germany  
General Fax: +49-2102-442066  
General Email: sales@asuscom.de (for marketing requests only)

### *Technical Support*

Support Hotline: MB/Others: +49-2102-9599-0  
Notebook (Tel): +49-2102-9599-10  
Support Fax: +49-2102-9599-11  
Support (Email): www.asuscom.de/de/support (for online support)  
Web Site: www.asuscom.de

# FCC/CDC Statements

## Federal Communications Commission Statement

This device complies with FCC Rules Part 15. Operation is subject to the following two conditions:

- This device may not cause harmful interference, and
- This device must accept any interference received including interference that may cause undesired operation.

This equipment has been tested and found to comply with the limits for a Class B digital device, pursuant to Part 15 of the FCC Rules. These limits are designed to provide reasonable protection against harmful interference in a residential installation. This equipment generates, uses and can radiate radio frequency energy and, if not installed and used in accordance with manufacturer's instructions, may cause harmful interference to radio communications. However, there is no guarantee that interference will not occur in a particular installation. If this equipment does cause harmful interference to radio or television reception, which can be determined by turning the equipment off and on, the user is encouraged to try to correct the interference by one or more of the following measures:

- Reorient or relocate the receiving antenna.
- Increase the separation between the equipment and receiver.
- Connect the equipment to an outlet on a circuit different from that to which the receiver is connected.
- Consult the dealer or an experienced radio/TV technician for help.

**WARNING!** The use of shielded cables for connection of the monitor to the graphics card is required to assure compliance with FCC regulations. Changes or modifications to this unit not expressly approved by the party responsible for compliance could void the user's authority to operate this equipment.

## Canadian Department of Communications Statement

This digital apparatus does not exceed the Class B limits for radio noise emissions from digital apparatus set out in the Radio Interference Regulations of the Canadian Department of Communications.

**This class B digital apparatus complies with Canadian ICES-003.**

# Safety Precautions

## Electrical Safety



### IMPORTANT

- Before installing or removing signal cables, ensure that the power cables for the system unit and all attached devices are unplugged.
- To prevent electrical shock hazard, disconnect the power cable from the electrical outlet before relocating the system.
- When adding or removing any additional devices to or from the system, ensure that the power cables for the devices are unplugged before the signal cables are connected. If possible, disconnect all power cables from the existing system before you add a device.
- If the power supply is broken, do not try to fix it by yourself. Contact a qualified service technician or your dealer.



### CAUTION

This product is equipped with a three-wire power cable and plug for the user's safety. Use the power cable with a properly grounded electrical outlet to avoid electrical shock.

## Operation Safety



### IMPORTANT

- Any mechanical operation on this server must be conducted by certified or experienced engineers.
- Before operating the server, carefully read all the manuals included with the server package.
- Before using the server, make sure all cables are correctly connected and the power cables are not damaged. If any damage is detected, contact your dealer as soon as possible.
- To avoid short circuits, keep paper clips, screws, and staples away from connectors, slots, sockets and circuitry.
- Avoid dust, humidity, and temperature extremes. Place the server on a stable surface.

Blank lined paper for writing or drawing.



# Introduction

“About This Manual” introduces the contents of this document. This part includes the target audience, chapter description, and conventions used. It also lists other sources of information that are not contained in this manual.

# About This Manual

# Audience

This manual is intended for system integrators, and experienced users with at least basic knowledge of configuring an entry-level server.

# Contents

This manual contains the following parts:

## 1. Introduction: About This Manual

This part introduces the contents of this document. It includes the target audience, chapter description, and conventions used. It also lists other sources of information that are not contained in this manual.

## 2. Chapter 1: System Overview

This chapter describes the general features of the AP130 server. It includes sections on front panel and rear panel specifications.

## 3. Chapter 2: Hardware Setup

This chapter lists the hardware setup procedures that you have to perform when installing system components.

## 4. Chapter 3: Powering Up

This chapter tells how to get started with the AP130 server after you have installed the basic components.

## 5. Appendix A: Power Supply Information

This appendix gives information on the 200-watt switching power supply that came with the AP130 server.

## 6. Appendix B: Troubleshooting

This appendix lists the common problems that you may encounter while using the AP130 server. It lists the possible causes of the problems and offers solutions. You may refer to this part and try to solve simple problems before calling customer support.

# Conventions

## Symbols

To make sure that you perform certain tasks properly, take note of the following symbols used throughout this manual.



**WARNING:** Information to prevent injury to yourself when trying to complete a task.



**CAUTION:** Information to prevent damage to the components when trying to complete a task.



**IMPORTANT:** Information that you **MUST** follow to complete a task.



**NOTE:** Tips and information to aid in completing a task.

## References

Refer to the following sources for additional information and for product and software updates.

### 1. **ASUS P4B-MX Motherboard User's Manual**

This manual contains detailed information about the P4B-MX motherboard.

### 2. **ASUS Websites**

The ASUS websites worldwide provide updated information on ASUS hardware and software products. The ASUS websites are listed in the ASUS Contact Information on page 5.

### 3. **Optional Documentation**

Your product package may include optional documentation such as a CD-ROM manual, warranty flyers, and others that may have been added by your dealer. **NOTE:** These documents are not part of the standard server package.

# System Package Contents

The following checklist enumerates the components included in the standard system package.

- 1) ASUS AS11 chassis
- 2) ASUS P4B-MX motherboard
- 3) 200W ATX power supply
- 4) 52X CD-ROM drive
- 5) 1.44MB floppy disk drive
- 6) AGP 4X card (optional)
- 7) Support CD that includes drivers, utilities, and ASUS Server Web-based Management (ASWM)
- 8) User's manuals (for system and motherboard)

If any of the above items is missing, contact your dealer.

# Chapter 1

This chapter describes the general features of the AP130 server. It includes sections on front panel, rear panel, and internal features of the server.

# System Overview

# 1.1 System Features

The ASUS AP130 Server is a stylish tower chassis that accommodates the ASUS P4B-MX motherboard. The server is powered by Intel® Pentium® 4 478/Northwood processor, and supports the latest I/O, audio, and video technologies through the chipsets embedded on the motherboard.

Following are highlights of the server's many features.

- **Processor:** Support for Intel Pentium 4 processor with 512KB L2 cache and speeds of up to over 2GHz
- **Memory:** Three DIMM sockets support up to 3GB of system memory using PC133/PC100 DIMMs
- **System Chipset:** Intel 845 (Brookdale) chipset composed of Intel Memory Controller Hub (MCH). The MCH along with the south bridge Intel I/O Controller Hub 2 (ICH2) are interconnected through the Intel proprietary Hub interface. The MCH provides the processor interface, system memory interface, AGP interface, and Hub Interface.
- **LAN Chipset:** Intel 82562ET is a highly integrated Platform LAN Connect (PLC) device that allows 10BASE-T and 100BASE-TX networking capabilities, and provides the LAN solution to perform high-speed data transfers over the PCI bus.
- **Storage:** Four external bays that support two optional 5.25-inch IDE hot-swap drives, one 52X CD-ROM, and 1.44MB floppy drive; internal 3.5-inch drive bays available for two additional IDE drives
- **Expansion:** Three PCI expansion slots, one AGP 4X slot
- **Power Supply:** 200-watt ATX power supply with a 115Vac/230Vac voltage selector switch
- **Security:** Equipped with security chassis keylock

## 1.2 Front Panel Features

The AP130 front panel is designed with a door secured by a keylock. When locked, the door prevents unauthorized access to the front panel components.

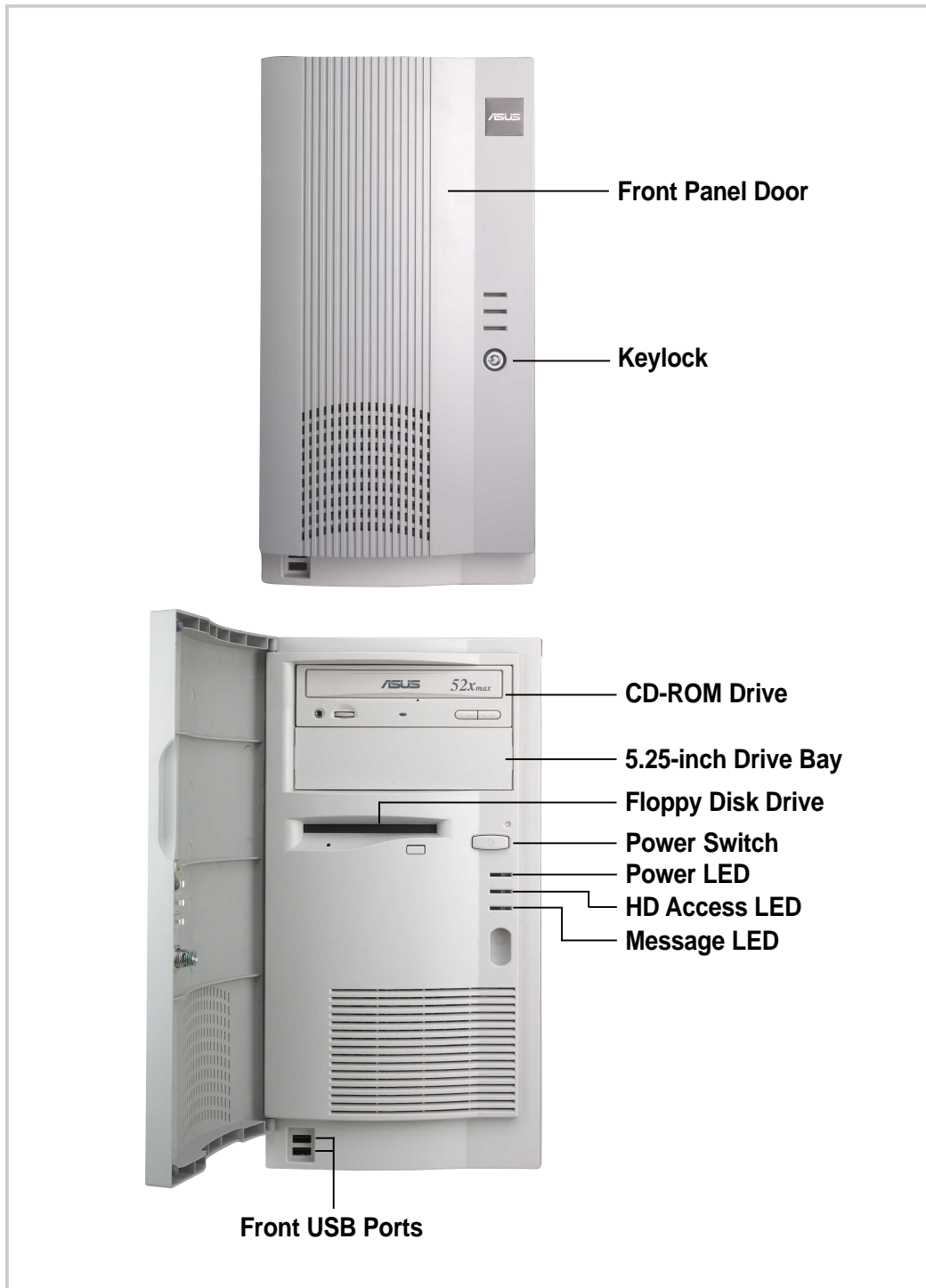

## 1.3 Rear Panel Features

The AP130 rear panel includes the external I/O ports. The following picture shows the cable connectors and the devices that you connect to the ports.

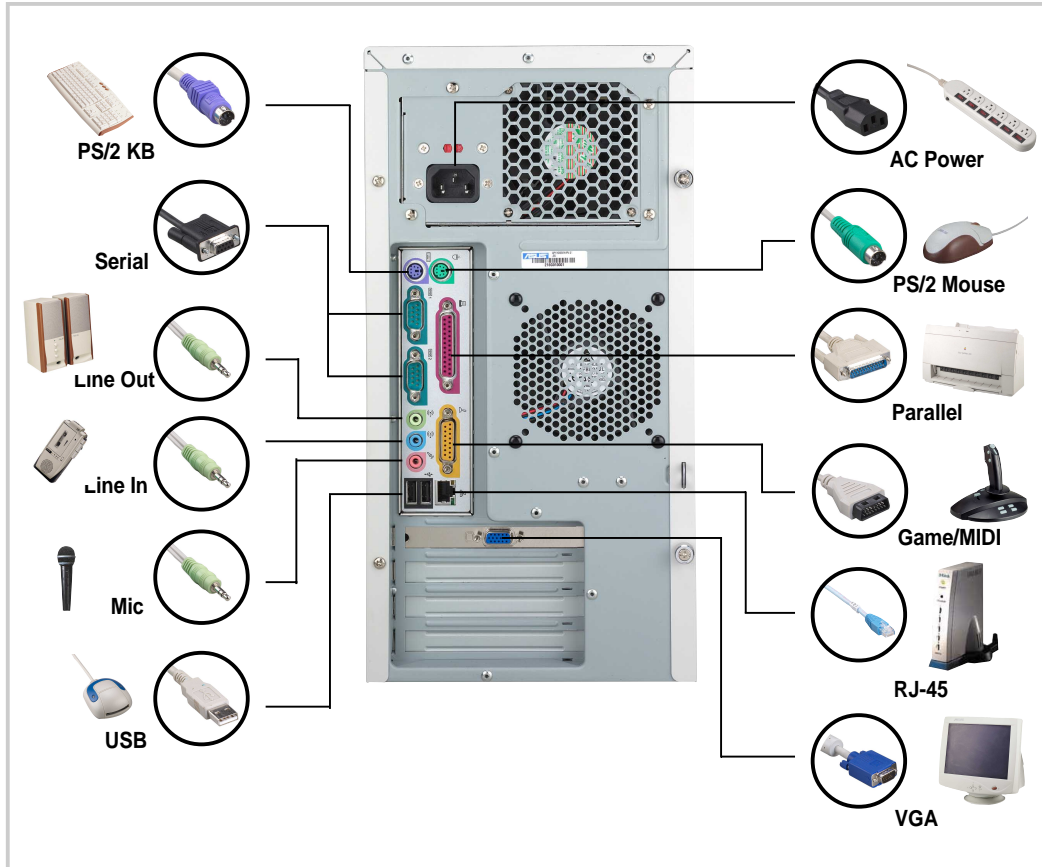

### Voltage Selector

The switching power supply that came with the server has a voltage selector switch below the power socket. Use this switch to select the appropriate voltage according to the voltage supply in your area.

If the voltage supply in your area is 100-127V, set the switch to 115V.

If the voltage supply in your area is 200-240V, set the switch to 230V.

115V/ 230V  
Voltage Selector

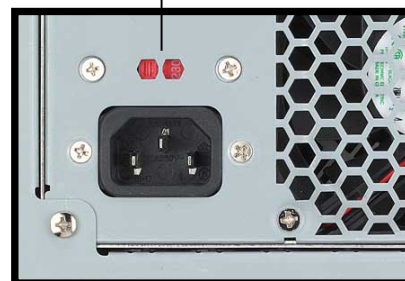

#### CAUTION

Setting the switch to 115V in a 230V environment will seriously damage the server.



## 1.4 Internal Features

The standard components inside the AP130 server include the motherboard, power supply, floppy and CD-ROM drives, and cables.

The picture below shows the standard components of the server.

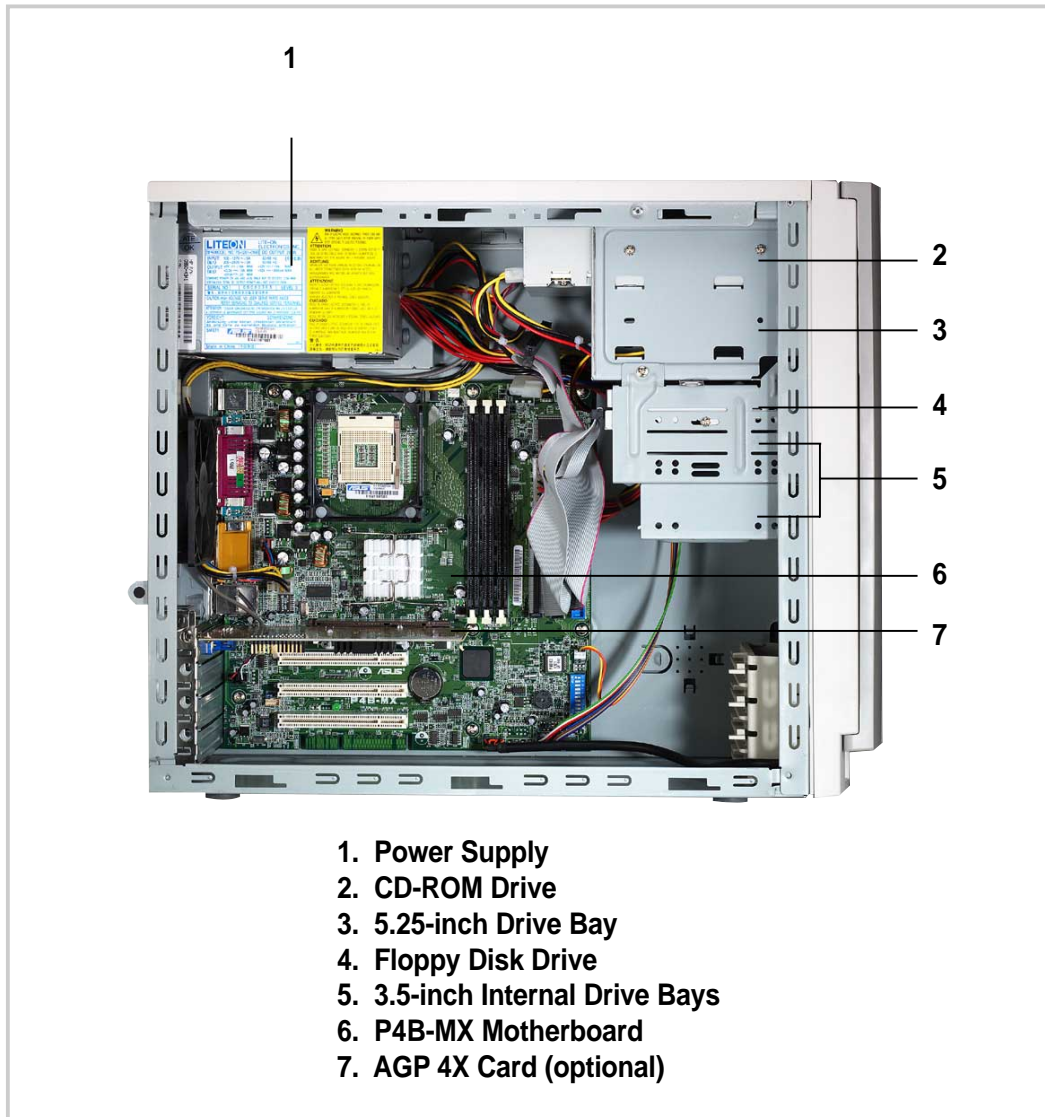



# Chapter 2

This chapter describes the hardware setup procedures that you have to perform when installing system components.

# Hardware Setup

## 2.1 Remove the Chassis Cover

### Unlock the side cover

Two thumbscrews secure the removable side panel cover. Turn these screws counter-clockwise to release the cover. The screws are attached to the cover. Do pull out the screws.



Thumbscrews

### Remove the side cover

Slide the cover for about an inch toward the rear panel then lift it out of the chassis.

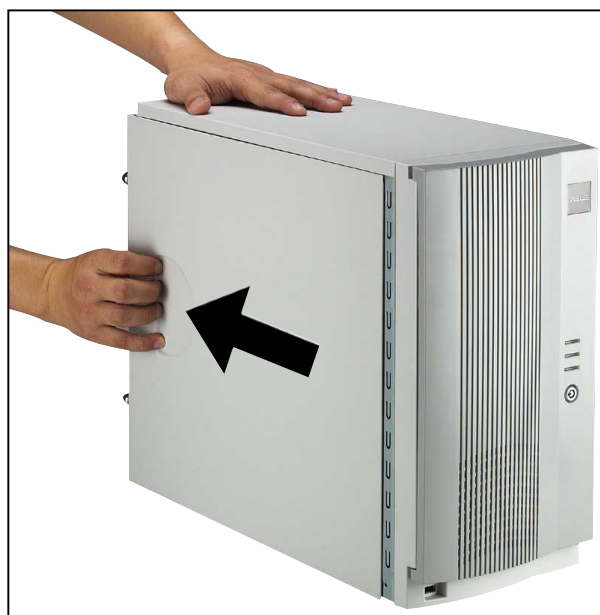

## 2.2 Motherboard Placement



### NOTE

The motherboard and other internal components of the AP130 server are already installed as indicated in section “1.4 Internal Features”. Refer to the motherboard user’s manual for detailed technical information about the motherboard.

### Placement Direction

When installing the motherboard, make sure that you place it into the chassis correctly. The edge with the external ports goes to the rear part of the chassis.

Place this side  
towards the rear  
of the chassis

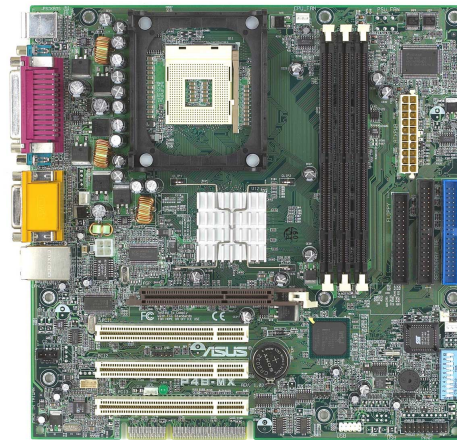

### Motherboard Screws

Place eight (8) screws in the holes indicated by circles to secure the motherboard to the chassis. Do not overtighten the screws. Doing so may damage the motherboard.

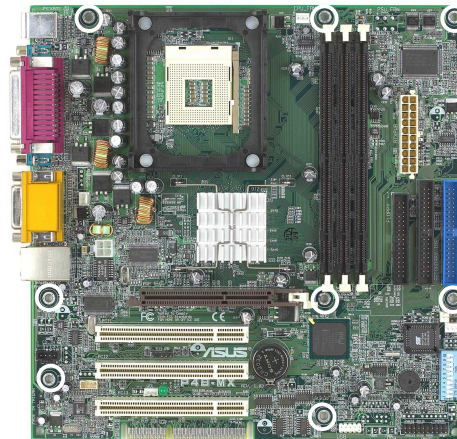

## 2.3 Install a CPU

The 478-pin Zero Insertion Force (ZIF) socket on the P4B-MX motherboard supports an Intel Pentium 4 processor. This section tells you how to install a CPU. Refer to the motherboard user guide for more information.

### CPU Socket Location

The CPU socket is located beside the rear panel connectors. Note the Pin 1 location on the socket.

Pin 1

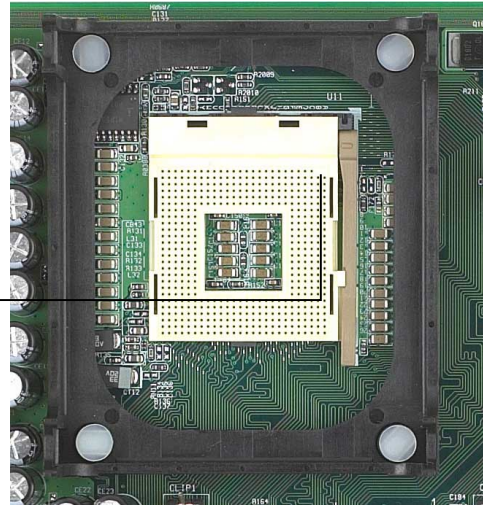

### CPU Orientation

A CPU has a mark (usually a notch or a gold mark) on one corner to help you identify the correct orientation when inserting it to the socket.

Match the marked corner of the CPU to Pin 1 on the socket.

Gold Mark

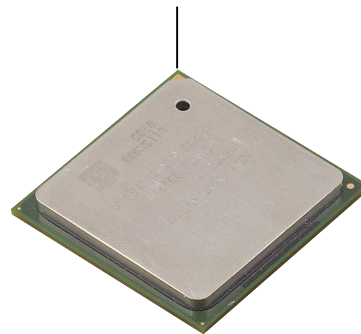

## Unlock the CPU Socket

Unlock the socket by pressing the lever sideways then lifting it up to a 90°-100° angle.

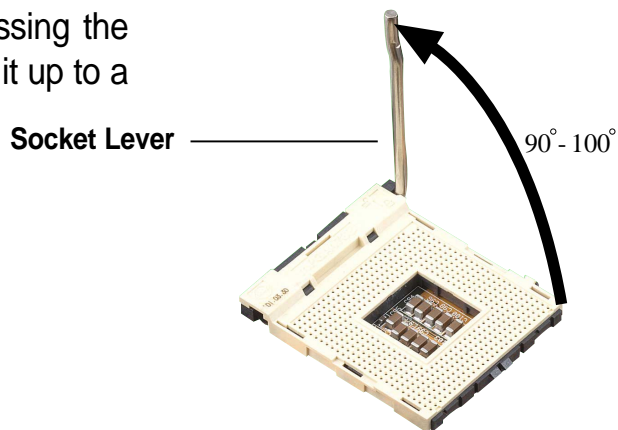

## Insert the CPU

1. Position the CPU above the socket such that its marked corner matches the base of the socket lever.
2. Carefully insert the CPU into the socket until it fits in place.

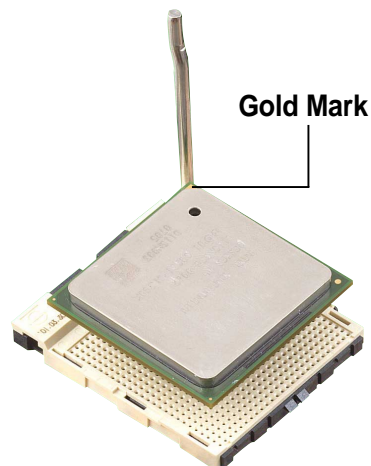

## Secure the CPU

When the CPU is in place, press it firmly on the socket while you push down the socket lever to secure the CPU. The lever clicks on the side tab to indicate that it is locked.

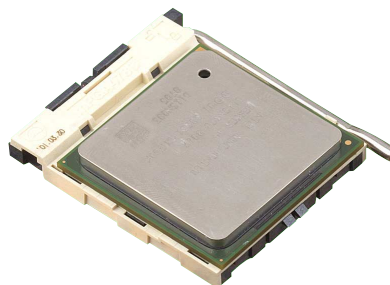

### CAUTION

Incorrect installation of the CPU into the socket may bend the pins and severely damage the CPU!



## Install the Fan Heatsink Assembly

1. Align and snap the hooks of a retention bracket into the holes of the retention module base. Make sure that the arrow on the bracket points inward.
2. Follow step 1 to install the other bracket.
3. When attached to the module base, flip the brackets sideways to allow enough room for the fan heatsink assembly. (See picture in step 4).

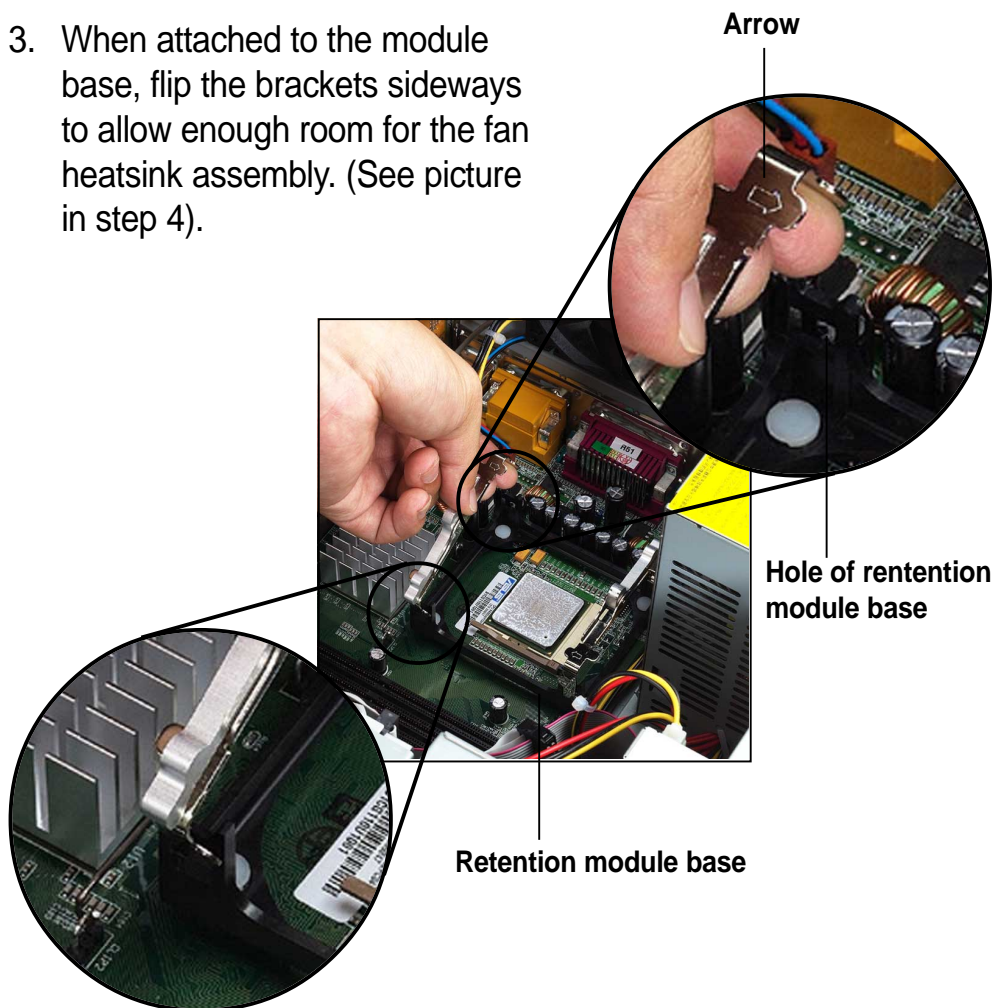

### NOTE

The retention module base is already installed on the motherboard upon purchase. Some CPU fan heatsink packages may also come with an extra module base.



4. Orient the fan heatsink assembly with the fan cable nearest the CPU fan connector on the motherboard (marked CPU\_FAN).
5. Carefully place the fan heatsink assembly on top of the CPU. Make sure that the heatsink perfectly fits the retention module base.
6. Connect the fan cable to the CPU\_FAN connector.
7. Flip back the retention brackets inward so that they fit the sides of the heatsink.
8. Simultaneously flip the bracket levers 180° towards the arrows until they click in place.

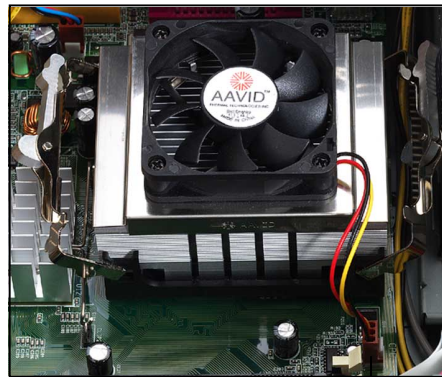

CPU fan connector  
(CPU\_FAN)



#### NOTE

The fan heatsink assembly shown above is for reference only. The fan heatsink assembly that you purchased may not look exactly the same as shown. Refer to the documentation that came with the fan heatsink assembly for more information.

## 2.4 Install System Memory

### DIMM Sockets Location

The motherboard has three Dual Inline Memory Module (DIMM) sockets that support 3.3V SDRAM modules in 32, 64, 128, 256, 512MB, or 1GB densities for up to 3GB system memory.

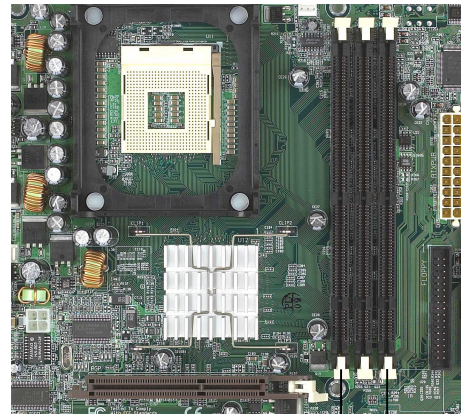

DIMM sockets

### Install a DIMM

1. Unlock a DIMM socket by pressing the retaining clips outward. Align a DIMM on the socket such that the notches on the DIMM match the breaks on the socket.
2. Firmly insert the DIMM into the socket until the retaining clips snap back in place and the DIMM is properly seated.

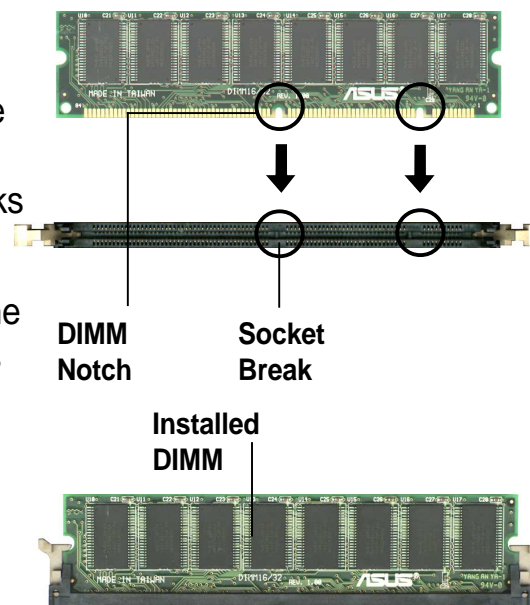

#### CAUTION

DIMMs are keyed with notches so that they fit in only one direction. DO NOT force a DIMM into a socket to avoid damaging the DIMM.

## 2.5 Install a Hard Disk Drive

### Remove the HDD/Floppy Cage

1. Remove the screw that secures the HDD/floppy cage.

Make sure to disconnect the floppy cable from the floppy disk before removing the cage out of the chassis.

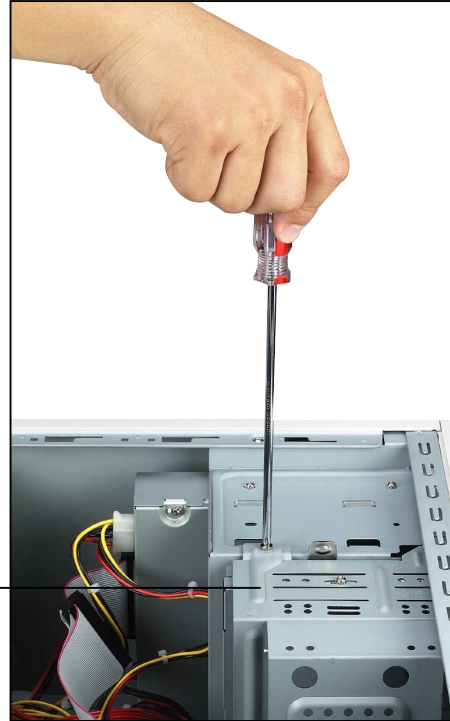

HDD Metal Cage

2. Press the retaining clip to release the cage.
3. Lift the cage out of the chassis.

Retaining clip



## Install the HDD

1. Insert the HDD into the cage (label side up) until the holes on the HDD align with the holes on the cage.
2. Secure the HDD with four screws (two on each side).
3. Replace the cage into the chassis.



## Connect the Cables

1. Connect one end of the IDE cable to the IDE connector at the back of the drive, matching the red stripe on the cable with Pin 1 on the IDE connector.
2. Connect a power cable (plug marked P5) to the power connector at the back of the drive.
3. Connect the other end of the IDE cable to the primary IDE connector (blue connector) on the motherboard.

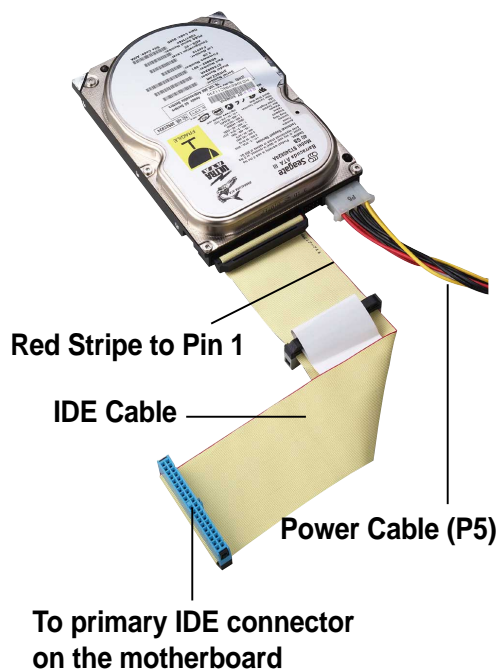

## 2.6 Replace the Cover

### Re-install the Cover

1. Position the cover in place, aligning the tabs on the inner side of the cover to the rail holes on the chassis edge.
2. Slide the cover toward the front panel until it fits in place.
3. Turn the thumbscrews to secure the cover to the chassis.





# Chapter 3

This chapter tells how to get started with the AP130 server. Powering up the server basically includes connecting the cables and turning power on.

# Powering Up

## 3.1 Getting Started

Make sure that you have completed the basic system installations in Chapter 2, then follow these steps to start up the server.

### Connect a Monitor

Connect a monitor by plugging the monitor cable to the video port (blue port) on the server rear panel.

Video Port

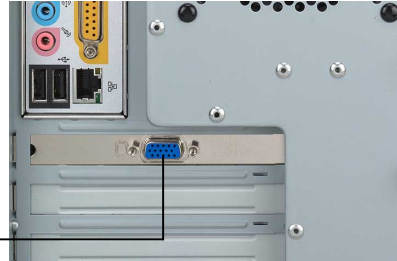

### Connect the Power Cord

1. Adjust the voltage selector to the correct voltage in your area.
2. Connect a power cord to the power connector on the rear panel.
3. Plug the power cord to a grounded wall socket.

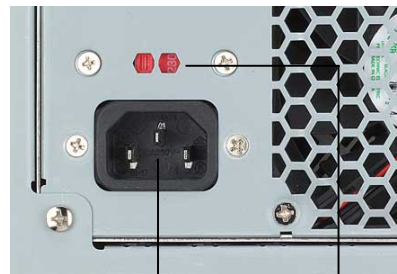

Power Connector

Voltage Selector

### Power On

Turn on the server by pressing the power switch on the front panel.

Power Switch



### Check Power Status

After turning on the power, the power LED lights up. If it doesn't, check the power connection.

Power LED





# Appendix A

This appendix gives information on the 200W switching power supply that comes with the AP130 server.

# Power Supply

## A.1 General Description

The server comes with a 200W ATX power supply with universal AC input that includes PFC and ATX-compliant output cables and connectors. The power supply has an internal cooling fan.

The power supply has seven plugs labeled PS1, P2, P3, P4, P5, P6, and P7. The picture below shows the specific device assignments for the plugs.

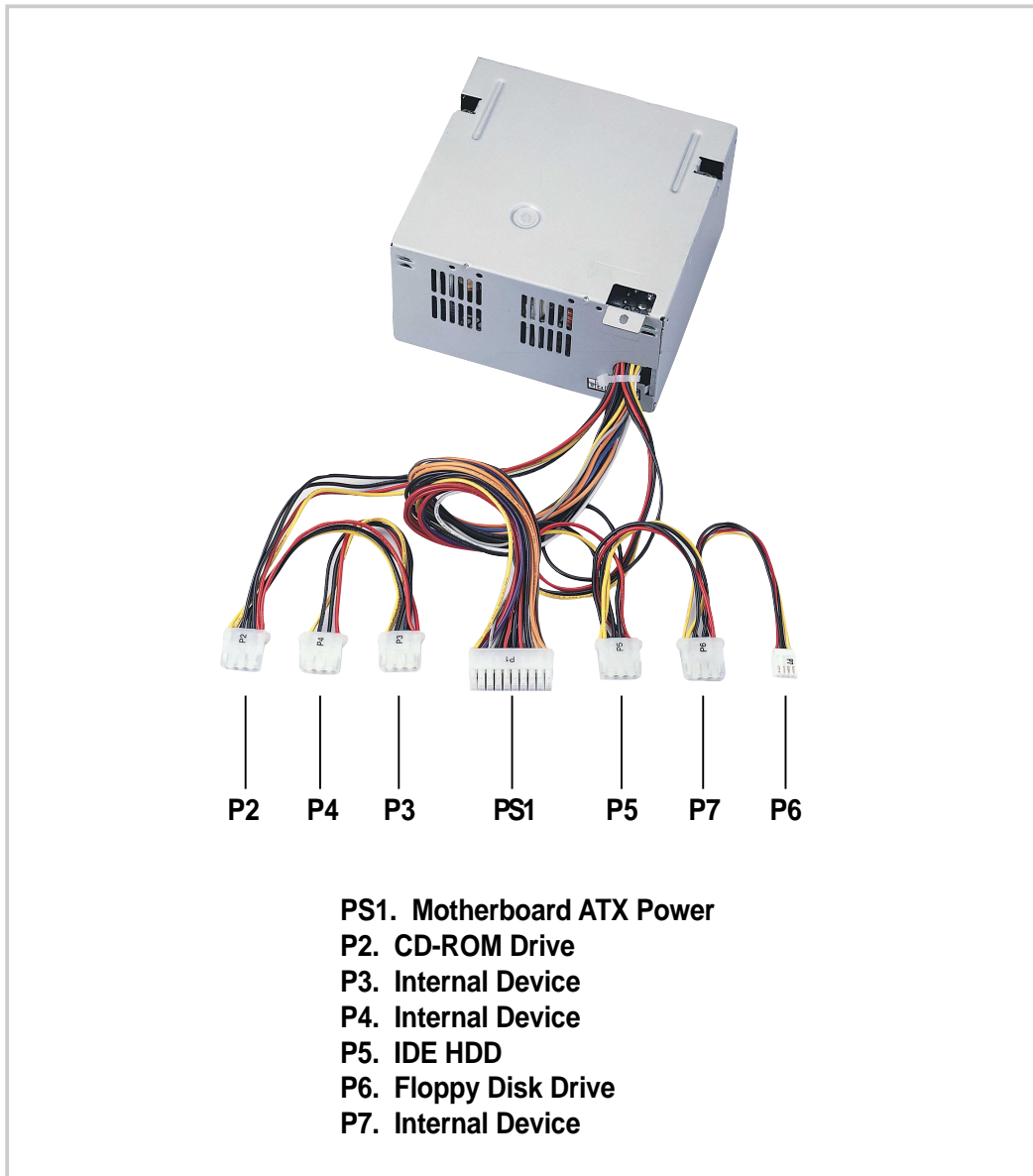

## A.2 Specifications

### Input Characteristics

Input Voltage Range	Min	Nom	Max
Range 1	90V	115V	140V
Range 2	180V	230V	264V
<b>Input Frequency Range</b>	43 Hz to 66 Hz		
<b>Maximum Input ac Current</b>	5A max at 115Vac 3A max. at 230Vac, maximum load		
<b>Inrush Current</b>	90A cold start 120A warm start		
<b>Efficiency</b>	65% min. at nominal input, maximum load		

### Output Characteristics

Output Voltage	Load Range		Regulation		Ripple
	Min	Max	Min	Max	Max
+5V	1.5A	25.0A	-5%	+5%	50mV <sub>p-p</sub>
+12V	0.2A	8.0A	-5%	+5%	120mV <sub>p-p</sub>
-12V	0A	0.8A	-10%	+10%	120mV <sub>p-p</sub>
+5Vsb	0A	2.0A	-5%	+5%	50mV <sub>p-p</sub>
+3V3	0A	14.0A	-5%	+5%	50mV <sub>p-p</sub>

### Over-Voltage Protection (OVP)

Output Voltage	Maximum Voltage
+5V	6.5V
+12V	15.6V
+3.3V	4.3V



#### NOTE

The power supply will shut down and latch off for shorting +5V, +12V, -12V, or +3.3V. By shorting +5Vsb, the power supply can latch down or automatically recover when the fault condition is removed.



# Appendix B

This appendix lists the common problems that you may encounter while using the AP130 server. It lists the possible causes of the problems and offers solutions. You may refer to this part and try to solve simple problems before calling customer support.

# Troubleshooting

## B.1 Simple Fixes



### NOTE

Some problems that you may encounter are not due to defects on the system or the components. These problems only requires simple troubleshooting actions that you can perform by yourself.

Problem	Action
The power LED on the server and/or the monitor do not light up	<ol style="list-style-type: none"><li>1. Make sure that the 115V/230V voltage selector switch is set to the correct voltage supply in your area.</li><li>2. Check the power cable connection on the system rear panel if properly connected.</li><li>3. Make sure that the power cables are connected to a grounded power outlet.</li><li>4. Press the power button to make sure that the system is turned on.</li></ol>
The keyboard does not work	Check the keyboard cable if properly connected to the keyboard port.
The mouse does not work	Check the mouse cable if properly connected to the mouse port.
The system does not perform power-on self tests (POST) after it was turned on	<ol style="list-style-type: none"><li>1. Check the memory modules and make sure you installed the DIMMs the system supports.</li><li>2. Make sure that the DIMMs are properly installed on the sockets.</li></ol>

<b>Problem</b>	<b>Action</b>
<b>The system continuously beeps after it was turned on</b>	<ol style="list-style-type: none"> <li>1. Check the memory modules and make sure you installed the DIMMs the system supports.</li> <li>2. Make sure that the DIMMs are properly installed on the sockets.</li> </ol>
<b>The message “Non-system disk or disk error” appears</b>	Check if bootable HDD is active.
<b>Onboard IDE HDD is unstable</b>	Install the utility drivers from the support CD that came with the package.
<b>Network connection not available</b>	<ol style="list-style-type: none"> <li>1. Make sure the network cable is connector the RJ-45 port on the rear panel.</li> <li>2. Make sure that you have installed the network drivers from the motherboard support CD.</li> </ol>





## Free Manuals Download Website

<http://myh66.com>

<http://usermanuals.us>

<http://www.somanuals.com>

<http://www.4manuals.cc>

<http://www.manual-lib.com>

<http://www.404manual.com>

<http://www.luxmanual.com>

<http://aubethermostatmanual.com>

Golf course search by state

<http://golfingnear.com>

Email search by domain

<http://emailbydomain.com>

Auto manuals search

<http://auto.somanuals.com>

TV manuals search

<http://tv.somanuals.com>