

# All-in-one PC

## *User Manual*



## **ET2220 Series**

### **COPYRIGHT INFORMATION**

No part of this manual, including the products and software described in it, may be reproduced, transmitted, transcribed, stored in a retrieval system, or translated into any language in any form or by any means, except documentation kept by the purchaser for backup purposes, without the express written permission of ASUSTeK COMPUTER INC. ("ASUS").

ASUS PROVIDES THIS MANUAL "AS IS" WITHOUT WARRANTY OF ANY KIND, EITHER EXPRESS OR IMPLIED, INCLUDING BUT NOT LIMITED TO THE IMPLIED WARRANTIES OR CONDITIONS OF MERCHANTABILITY OR FITNESS FOR A PARTICULAR PURPOSE. IN NO EVENT SHALL ASUS, ITS DIRECTORS, OFFICERS, EMPLOYEES OR AGENTS BE LIABLE FOR ANY INDIRECT, SPECIAL, INCIDENTAL, OR CONSEQUENTIAL DAMAGES (INCLUDING DAMAGES FOR LOSS OF PROFITS, LOSS OF BUSINESS, LOSS OF USE OR DATA, INTERRUPTION OF BUSINESS AND THE LIKE), EVEN IF ASUS HAS BEEN ADVISED OF THE POSSIBILITY OF SUCH DAMAGES ARISING FROM ANY DEFECT OR ERROR IN THIS MANUAL OR PRODUCT.

Products and corporate names appearing in this manual may or may not be registered trademarks or copyrights of their respective companies, and are used only for identification or explanation and to the owners' benefit, without intent to infringe.

SPECIFICATIONS AND INFORMATION CONTAINED IN THIS MANUAL ARE FURNISHED FOR INFORMATIONAL USE ONLY, AND ARE SUBJECT TO CHANGE AT ANY TIME WITHOUT NOTICE, AND SHOULD NOT BE CONSTRUED AS A COMMITMENT BY ASUS. ASUS ASSUMES NO RESPONSIBILITY OR LIABILITY FOR ANY ERRORS OR INACCURACIES THAT MAY APPEAR IN THIS MANUAL, INCLUDING THE PRODUCTS AND SOFTWARE DESCRIBED IN IT.

Copyright © 2012 ASUSTeK COMPUTER INC. All Rights Reserved.

### **LIMITATION OF LIABILITY**

Circumstances may arise where because of a default on ASUS' part or other liability, you are entitled to recover damages from ASUS. In each such instance, regardless of the basis on which you are entitled to claim damages from ASUS, ASUS is liable for no more than damages for bodily injury (including death) and damage to real property and tangible personal property; or any other actual and direct damages resulted from omission or failure of performing legal duties under this Warranty Statement, up to the listed contract price of each product.

ASUS will only be responsible for or indemnify you for loss, damages or claims based in contract, tort or infringement under this Warranty Statement.

This limit also applies to ASUS' suppliers and its reseller. It is the maximum for which ASUS, its suppliers, and your reseller are collectively responsible.

UNDER NO CIRCUMSTANCES IS ASUS LIABLE FOR ANY OF THE FOLLOWING: (1) THIRD-PARTY CLAIMS AGAINST YOU FOR DAMAGES; (2) LOSS OF, OR DAMAGE TO, YOUR RECORDS OR DATA; OR (3) SPECIAL, INCIDENTAL, OR INDIRECT DAMAGES OR FOR ANY ECONOMIC CONSEQUENTIAL DAMAGES (INCLUDING LOST PROFITS OR SAVINGS), EVEN IF ASUS, ITS SUPPLIERS OR YOUR RESELLER IS INFORMED OF THEIR POSSIBILITY.

### **SERVICE AND SUPPORT**

Visit our multi-language web site at <http://support.asus.com>

## Table of Contents

About this manual .....	5
Conventions used in this manual .....	6
Icons .....	6
Typography.....	6
Safety information .....	7
Setting up your system.....	7
Care during use .....	7
Sound Pressure Warning.....	8
TV Tuner (on selected models) .....	8
Adapter.....	8
DC Fan Warning.....	8
Package contents .....	9
<b>Chapter 1: Hardware Setup</b>	
Getting to know your All-in-one PC .....	10
Front view.....	10
Rear view .....	12
Side views.....	14
<b>Chapter 2: Using your All-in-one PC</b>	
Positioning your All-in-one PC .....	16
Placing on the table or desk .....	16
Mounting to the wall.....	17
Setting up your All-in-one PC .....	20
Connecting the wired keyboard and mouse.....	20
Connecting the wireless keyboard and mouse.....	20
Turning your All-in-one PC on .....	21
Gestures.....	22
Using the On Screen Display (OSD) Menu .....	24
OSD function instruction.....	24
Input signal selection.....	25
Configuring the audio output via an HDMI device (on selected models only) .....	25
<b>Chapter 3: Working with Windows® 8</b>	
System requirements.....	27
Starting for the first time .....	28
Windows® 8 lock screen.....	28

## Table of Contents

Windows® UI.....	29
Start screen .....	29
Windows® apps.....	30
Hotspots.....	30
Working with Windows® apps.....	33
Launching apps.....	33
Customizing apps.....	33
Accessing All Apps .....	34
Charm bar .....	35
Snap feature .....	37
Other keyboard shortcuts.....	38
Turning your All-in-one PC off .....	39
Entering the BIOS Setup .....	40
Quickly enter the BIOS.....	40
<b>Chapter 4: Connecting to the Internet</b>	
Wi-Fi connection .....	41
Wired connection.....	43
Configuring a dynamic IP/PPPoE network connection .....	43
Configuring a static IP network connection .....	46
<b>Chapter 5: Recovering your system</b>	
Resetting your PC.....	47
Recovering from a system image file.....	48
Creating a USB recovery drive.....	48
Removing everything and reinstalling Windows .....	49
<b>Appendices</b>	
Notices .....	50

## About this manual

This manual provides information about the hardware and software features of your All-in-one PC, organized through the following chapters:

### **Chapter 1: Hardware Setup**

This chapter details the hardware components of your All-in-one PC.

### **Chapter 2: Using your All-in-one PC**

This chapter provides you with information on using your All-in-one PC.

### **Chapter 3: Working with Windows® 8**

This chapter provides an overview of using Windows® 8 in your All-in-one PC.

### **Chapter 4: Connecting to the Internet**

This chapter provides information on connecting your All-in-one PC to a wired or Wi-Fi network.

### **Chapter 5: Recovering your system**

This chapter provides recovery options for your All-in-one PC.

### **Appendices**

This section includes notices and safety statements for your All-in-one PC.

## Conventions used in this manual

To highlight key information in this manual, some text are presented as follows:

---

**IMPORTANT!** This message contains vital information that must be followed to complete a task.

---

---

**NOTE:** This message contains additional information and tips that can help complete tasks.

---

---

**WARNING!** This message contains important information that must be followed to keep you safe while performing tasks and prevent damage to your All-in-one PC's data and components.

---

## Icons

The icons below indicate the devices you can use for completing a series of tasks or procedures on your All-in-one PC.



Use the touchscreen.



Use the keyboard.

## Typography

**Bold** This indicates a menu or an item that must be selected.

*Italic* This indicates sections that you can refer to in this manual.

All illustrations and screenshots in this manual are for reference only. Actual product specifications and software screen images may vary with territories. Visit the ASUS website at [www.asus.com](http://www.asus.com) for the latest information.

## Safety information

Your All-in-one PC ET2220 is designed and tested to meet the latest standards of safety for information technology equipment. However, to ensure your safety, it is important that you read the following safety instructions.

### Setting up your system

- Read and follow all instructions in the documentation before you operate your system.
- Do not use this product near water or a heated source such as a radiator.
- Set up the system on a stable surface.
- Openings on the chassis are for ventilation. Do not block or cover these openings. Ensure that you leave plenty of space around the system for ventilation. Never insert objects of any kind into the ventilation openings.
- Use this product in environments with ambient temperatures between 0°C and 40°C.
- If you use an extension cord, ensure that the total ampere rating of the devices plugged into the extension cord does not exceed its ampere rating.

### Care during use

- Do not walk on the power cord or allow anything to rest on it.
- Do not spill water or any other liquids on your system.
- When the system is turned off, a small amount of electrical current still flows. Always unplug all power, modem, and network cables from the power outlets before cleaning the system.
- The touch screen requires periodic cleaning to achieve the best touch sensitivity. Keep the screen clean from foreign objects or excessive dust accumulation. To clean the screen:
  - Turn off the system and disconnect the power cord from the wall.
  - Spray a small amount of a household glass cleaner onto the supplied cleaning cloth and gently wipe the screen surface.
  - Do not spray the cleaner directly on the screen.
  - Do not use an abrasive cleaner or a coarse cloth when cleaning the screen.
- If you encounter the following technical problems with the product, unplug the power cord and contact a qualified service technician or your retailer.
  - The power cord or plug is damaged.
  - Liquid has been spilled into the system.
  - The system does not function properly even if you follow the operating instructions.
  - The system was dropped or the cabinet is damaged.
  - The system performance changes.

## Sound Pressure Warning

Excessive sound pressure from earphones or headphones can cause hearing damage or loss. Adjustment of the volume control as well as the equalizer to settings other than the center position may increase the earphones or headphones output voltage and the sound pressure level.

## TV Tuner (on selected models)

Note to CATV System Installer—This reminder is provided to call the CATV systems installer's attention to Section 820-93 of the National Electric Code, which provides guidelines for proper grounding and, in particular, specify that the Coaxial cable shield be connected to the grounding system of the building as close to the point of cable entry as practical.

## Adapter





1. Adapter information (varies with models)
  - a. Input voltage: 100–240Vac  
Input frequency: 50–60Hz  
Rating output current: 130W (19V, 6.84A)  
Rating output voltage: 19Vdc
  - b. Input voltage: 100–240Vac  
Input frequency: 50–60Hz  
Rating output current: 120W (19V, 6.32A)  
Rating output voltage: 19Vdc
2. The socket outlet must be near to the unit and easily accessible.

## DC Fan Warning

Please note that the DC fan is a moving part that may cause DANGER. Ensure to keep your body from the moving fan blades.

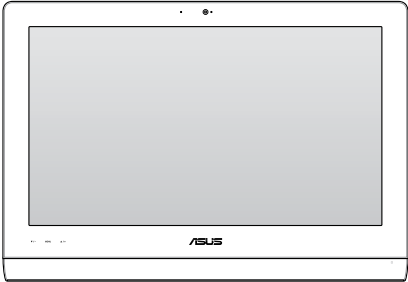

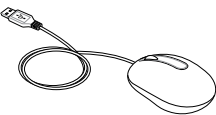
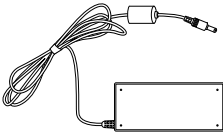
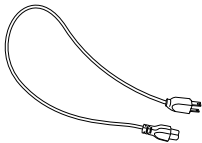
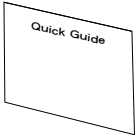
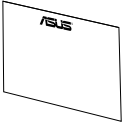
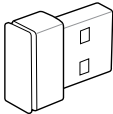
## Package contents

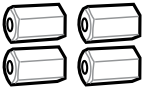
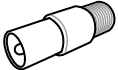
		
All-in-one PC ET2220		Keyboard (wired or wireless, optional)
		
Mouse (wired or wireless, optional)	AC adapter	Power cord
		
Quick Start Guide	Warranty Card	KBM USB receiver dongle (optional)
		<p><b>NOTE:</b> The keyboard, mouse, power supply, remote control, and KBM USB receiver dongle illustrations are for reference only. Actual product specifications may vary with territories.</p>
	Wall mount screws (optional)	
		
Remote Control (optional)	TV tuner (optional)	

# Chapter 1: Hardware Setup

## Getting to know your All-in-one PC

### Front view

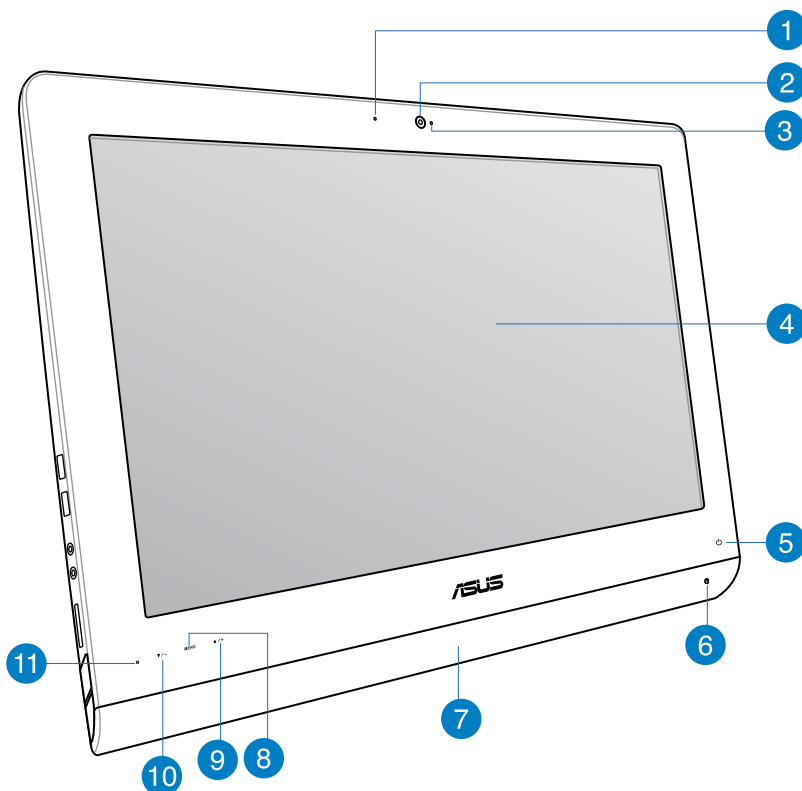

- 1 Webcam LED**  
Indicates that the built-in webcam is enabled.
- 2 Webcam**  
The built-in webcam with the built-in digital microphone allows you to start video chats online.

- 3 Digital Microphone (Built-in)**

The built-in digital microphone can be used for video conferencing, voice narrations, audio recordings, and multimedia applications.
- 4 LCD display (Touch-enabled function on selected models)**

The LCD display features optimal resolution. Touch-enabled models bring digital life to your fingertips.
- 5 Power LED**

Indicates that your All-in-one PC is turned on.
- 6 Hard Disk Drive LED**

Indicates hard disk drive activity.
- 7 Audio Speaker**

The built-in stereo speaker system allows you to hear audio without additional attachments. The multimedia sound system features an integrated digital audio controller that produces rich, vibrant sound.
- 8 MENU button**

Press to display the menu. Press this button to enter/select the highlighted icon (function) when the OSD is activated.
- 9 Menu up button**

Press to go up the menu.
- 10 Menu down button**

Press to go down the menu.
- 11 Remote Control Receiver**

The remote control receiver receives the infrared signal from the remote control.

## Rear view

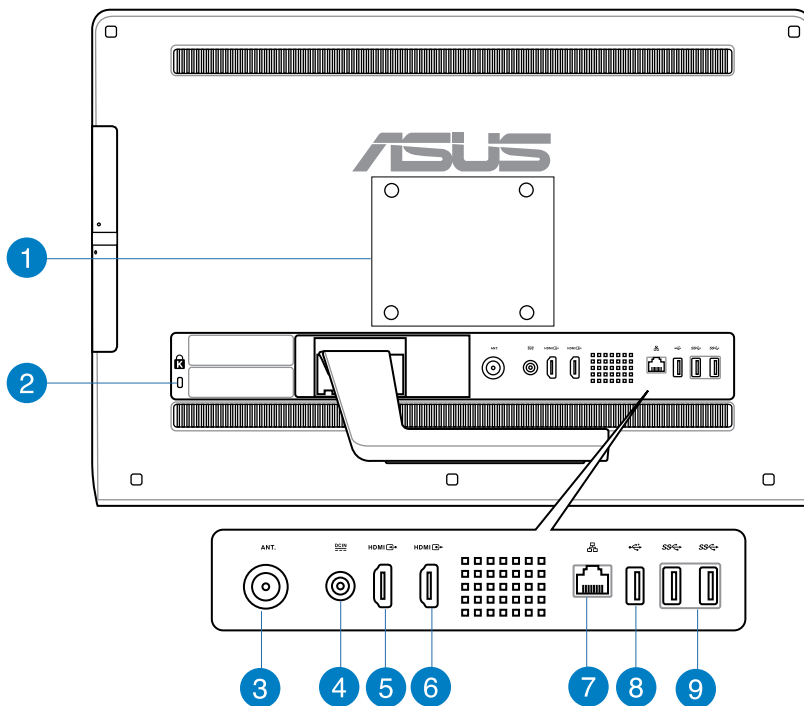

### 1 Wall mount holes

Secure the four wall mount screws into these holes and mount your All-in-one PC to a wall.

**NOTE:** The wall mount screws are optional items and are purchased separately.

### 2 Kensington® lock port

The Kensington® lock port allows you to secure your PC using Kensington® compatible PC security products.

### 3 Antenna Input (on selected models)

The antenna input is for TV frequency signal and allows for use with the digital TV antenna or input from subscription television services. The antenna can receive digital TV. Cable service connection can receive digital TV, analog TV, depending on paid services.

### 4 Power input

The supplied power adapter converts AC power to DC power for use with this jack. Power supplied through this jack supplies power to the PC. To prevent damage to the PC, always use the supplied power adapter.

---

**WARNING!** The power adapter may get warm or hot when in use. Do not cover the adapter and keep it away from your body.

---

### 5 HDMI Input Port

HDMI (High-Definition Multimedia Interface) is an uncompressed all-digital audio/video interface between any audio/video source, such as set-top box or DVD player.

### 6 HDMI Output Port

Connect this port with devices equipped with HDMI input port, such as LCD monitor or projector.

### 7 LAN port

The eight-pin RJ-45 LAN port supports a standard Ethernet cable for connection to a local network.

### 8 USB 2.0 port

The USB (Universal Serial Bus) port is compatible with USB 2.0 or USB 1.1 devices such as keyboards, pointing devices, flash disk drives, external HDDs, speakers, cameras and printers.

### 9 USB 3.0 ports

These USB (Universal Serial Bus) ports provide a transfer rate of up to 5Gbit/s and are backward compatible with USB2.0.

## Side views

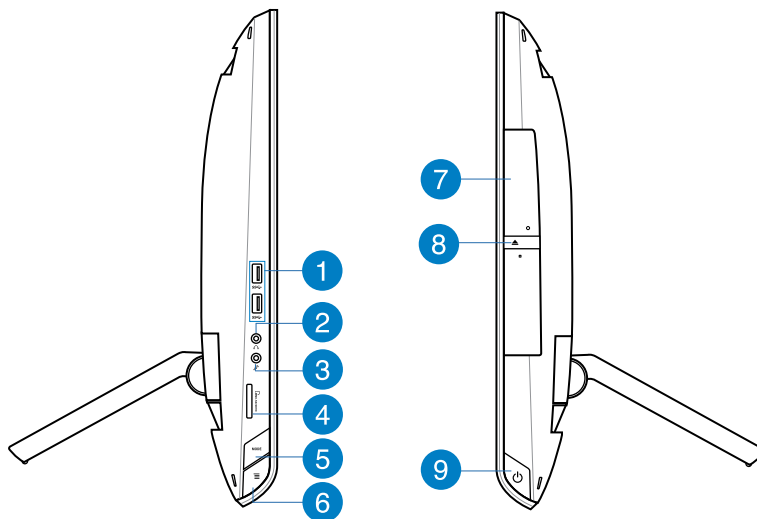

- 1 USB 3.0 ports**

These USB (Universal Serial Bus) ports provide a transfer rate of up to 5Gbit/s and are backward compatible with USB2.0.
- 2 Headphone jack**

The stereo headphone jack (3.5mm) is used to connect the system's audio out signal to headphones. Using this jack automatically disables the built-in speakers.
- 3 Microphone jack**

The microphone jack is designed to connect to a microphone used for video conferencing, voice narrations, or simple audio recordings.
- 4 Memory card reader**

This All-in-one PC has a single built-in memory card reader slot that supports MMC, SD, and SDHC formats.

- 5 Mode button**

Press to switch the display signal source. When switched to HDMI-in and VGA-in, the All-in-one PC can be used as a standard desktop LCD monitor.
- 6 Menu lock**

Press to activate or deactivate the MENU button on the front panel.
- 7 Optical Drive**

The built-in optical drive may support compact discs (CD), digital video discs (DVD), and/or Blu-ray discs (BD) and may have recordable (R) or re-writable (RW) capabilities. See the marketing specifications for details on each model.
- 8 Optical Drive Electronic Eject**

The optical drive eject has an electronic eject button for opening the tray. You can also eject the optical drive tray through any software player or by right clicking the optical drive in Windows "Computer" and selecting Eject.
- 9 Power button**

Press this button to turn on your All-in-one PC.

## Chapter 2: Using your All-in-one PC

### Positioning your All-in-one PC

#### Placing on the table or desk

##### To place on the table or desk:

1. Place your All-in-one PC on a flat surface such as a table or desk.
2. Push your All-in-one PC backwards to a 16 degree-angle until you hear a click sound to ensure that it stands firmly in place. You can orient your All-in-one PC at 16 degrees up to 45 degrees angle.

---

**IMPORTANT!** Orient the display panel within the given range to avoid damaging your All-in-one PC.

---

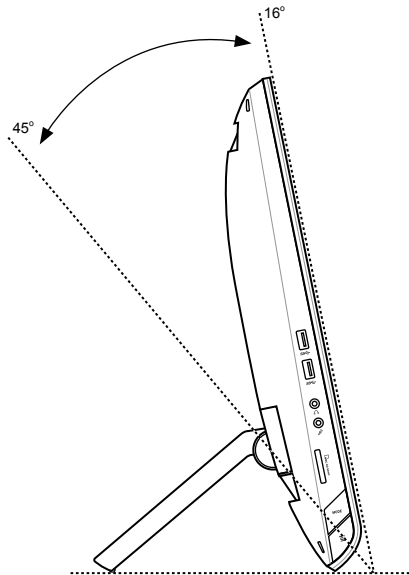



## Mounting to the wall

To mount your ASUS All-in-one PC to the wall, purchase optional wall mount screws and a wall mount kit (VESA 100). Install the wall mount components according to the following instructions.

1. To release the stand, place the All-in-one PC face-down first, resting the display panel on a flat even surface.
2. Remove the back cover.
3. Remove the four screws on the stand and save for future reinstallation (A). Take out the stand and put it aside (B).
4. Replace the back cover that you removed earlier.

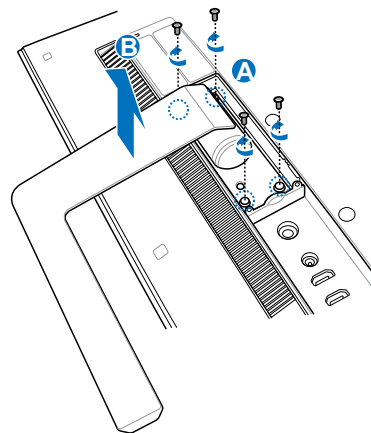
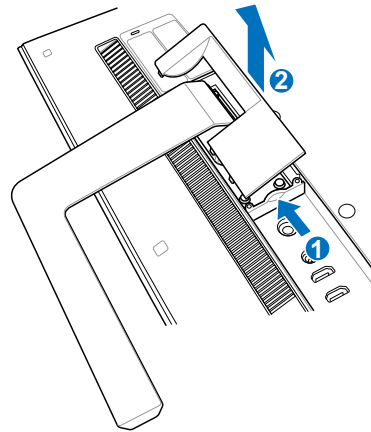

5. Remove the four plastic caps, from the rear panel holes.

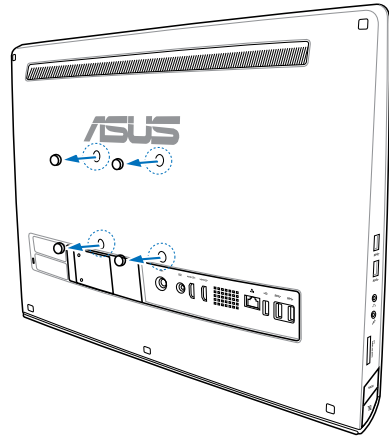

6. Secure the four wall mount screws to the rear panel holes.

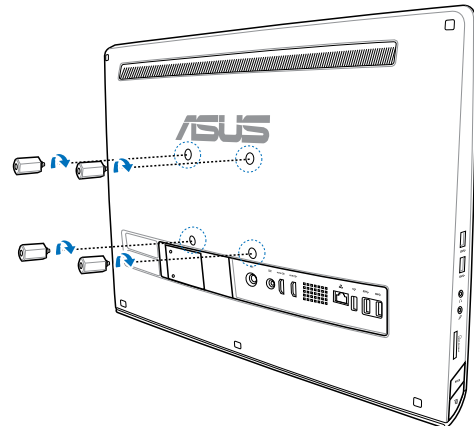

6. Mount the All-in-one PC onto a firm wall by applying a standard wall mount kit (pad and rack) to the wall mount screws. Follow the instructions described in the installation manual that came with your wall mount kit.

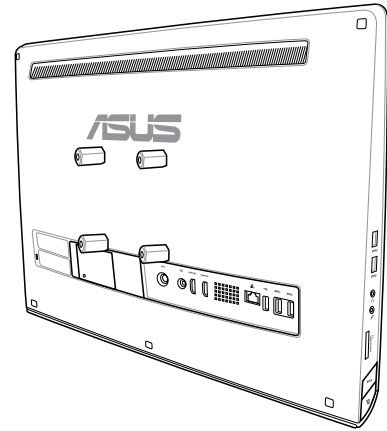

---

**IMPORTANT!**

- For machine ventilation, be sure to leave a distance of at least 6cm between the All-in-one PC and the wall.
  - The wall mount kit should comply with VESA standards.
  - To ensure safety, please read the wall mount kit installation manual carefully before mounting your All-in-one PC to the wall.
  - At least two persons are required to install or remove the All-in-one PC onto and from the wall to avoid hazard of falling objects and breakage. Qualified personnel is recommended.
  - The wall should be able to sustain four times the weight of the All-in-one PC and wall mount components combined (36kg at least). The mounting location must be able to withstand earthquake or other impacts. Cement or masonry walls recommended.
-

## Setting up your All-in-one PC

### Connecting the wired keyboard and mouse

Connect the keyboard and the mouse to the USB port on the rear panel. You may also connect the keyboard and mouse to the USB port on the left side of the panel if the keyboard cable is not long enough.

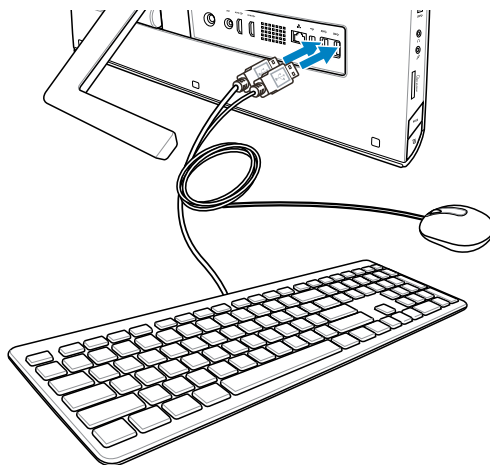

### Connecting the wireless keyboard and mouse

1. Install batteries to the wireless keyboard and mouse.
2. Connect the wireless dongle for keyboard and mouse to a USB port.
3. You can begin using the wireless keyboard and mouse.

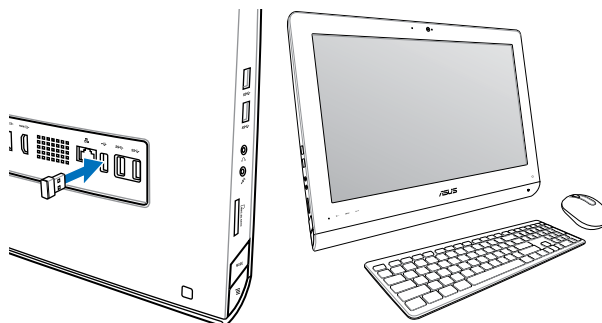

#### NOTES:

- Simply reconnect if the wireless keyboard and mouse lose connection. Avoid other nearby WiFi devices at least 20 cm as they may interfere with the connection.
- The illustrations above are for reference only. Actual appearances and specifications (wired or wireless) of the keyboard and mouse may vary by territory.

## Turning your All-in-one PC on

Connect the supplied AC adapter to the DC-In jack on the rear panel ( 1 2 3 ), wall outlet voltage 100Vac-240Vac) and then press the Power switch on the right ( 4 ) to turn on the system.

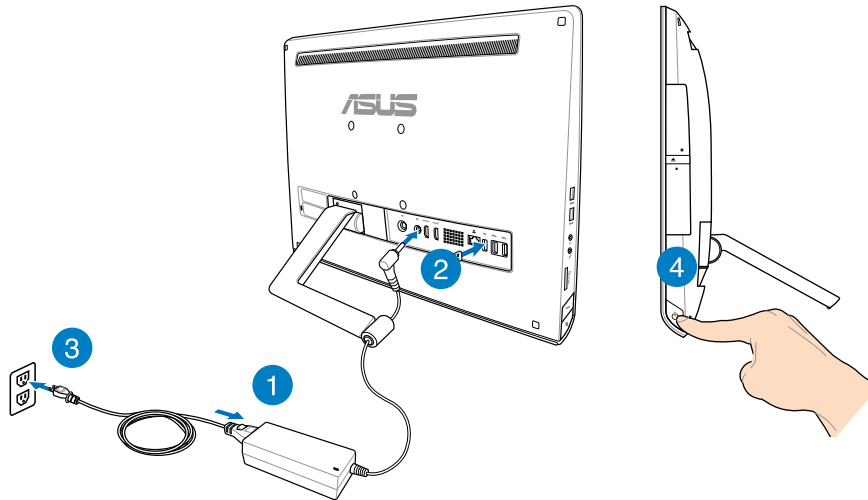

**WARNING!** DO NOT connect the AC power cord to an AC outlet prior to connecting the DC plug to the system. Doing so may damage the AC-DC adapter.

**NOTE:** For details on turning off your All-in-one PC, refer to the section *Turning off your All-in-one PC* under *Working with Windows® 8*.

## Gestures

The gestures allow you to launch programs and access the settings of your All-in-one PC. The functions can be activated by using the hand gestures to your All-in-one PC's display panel.

### Using gestures

#### Left edge swipe



Swipe from the left edge of the screen to shuffle your running apps.

#### Right edge swipe



Swipe from the right edge of the screen to launch the Charm bar.

#### Top edge swipe

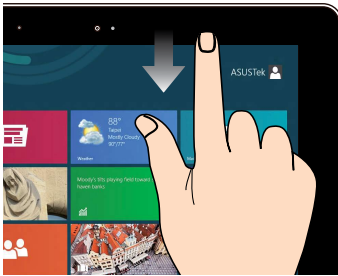

- In the Start screen, swipe from the top edge of the screen to view the All Apps bar.
- In a running app, swipe the from top edge of the screen to view its menu.

#### Finger slide



Slide your finger to scroll up and down and slide your finger to pan the screen left or right.

**Zoom out**

Bring together your two fingers on the touch panel.

**Zoom in**

Spread apart your two fingers on the touch panel.

**Tap and hold**

- To move an app, tap and hold the app tile and drag it to a new location.
- To close an app, tap and hold the top side of the running app and drag it down to the bottom of the screen to close it

**Tap/Double tap**

- Tap an app to launch it.
- On Desktop mode, double-tap an item to launch it.

## Using the On Screen Display (OSD) Menu

The On Screen Display (OSD) menu appears if you do the following:

- Activate the OSD via pressing the Menu lock button at the left side of your All-in-one PC, then press the Menu button at the front panel.

### OSD function instruction

To display the OSD menu, press the MENU button on the front panel. To navigate through the OSD functions or modify OSD settings, press the Menu up or Menu down keys. To activate the selected function, press the MENU button.

#### Panel Off

This function allows you to turn off the display panel of the All-in-one PC on. Press the MENU button to activate this function.

#### Color

- **Brightness:** The adjusting range is from 0 to 100.
- **Contrast:** The adjusting range is from 0 to 100.
- **Color Temp.:** Contains four color modes including Cool, Normal, Warm, and User mode.

#### Image

- **Sharpness:** The adjusting range is from 0 to 100.
- **Aspect Control:** Adjusts the aspect ratio to "Full" or "OverScan". This function is configurable only when you use the All-in-one PC as a standard desktop LCD monitor.
- **Auto Adjust:** Adjusts the horizontal position (H-Position) and the vertical position (V-Position) of the image. This function is configurable only when you use the All-in-one PC as a standard desktop LCD monitor and set the Display-input port as the input source.

#### Input Select

- **PC:** Sets the All-in-one PC as the display signal source.



## System Setup

- **OSD Setup:**
  - Adjusts the horizontal position (H-Position) / vertical position (V-Position) of the OSD menu.
  - Adjusts the OSD timeout from 10 to 120 seconds.
  - Enables or disables the DDC/CI (Display Data Channel/Command Interface) function.
- **Information:** Shows the monitor information.
- **Language:** Allows you to set the OSD language.
- **All Reset:** Allows you to reset all OSD settings.

## Input signal selection

An **Input Select** OSD menu appears when you connect the HDMI or VGA cable to the rear HDMI-input or Display-input port. Use the Menu up or Menu down keys to navigate through the input options and press the **MENU** button to activate the option. Refer to **Input Select** in the previous section for details.

## Configuring the audio output via an HDMI device (on selected models only)

If you want to use a high-definition TV as an audio output device, connect it to the Home Theater PC and follow the steps below to configure the audio settings.

### To configure the audio output via an HDMI device:

1. From the Start screen, click **Desktop** to launch the Desktop Mode.

---

**NOTE:** For more details, refer to the section *Start screen* under *Using Windows® 8*.

---

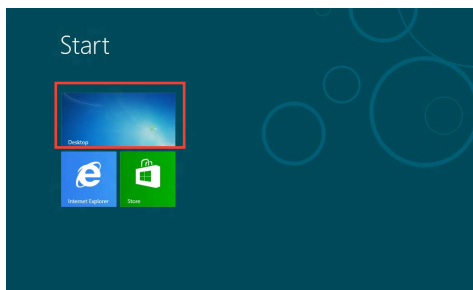

2. Right-click the Volume Mixer icon on the Windows® taskbar and click **Playback devices**.



3. From the Playback screen, select **Digital Audio (HDMI)**.

4. Click **Configure** and the Speaker Setup window pops up.

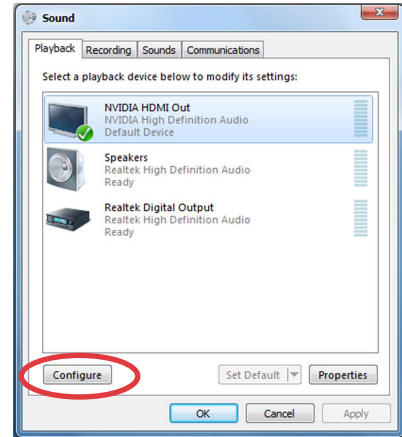

5. Select **Stereo** and click **Next**.

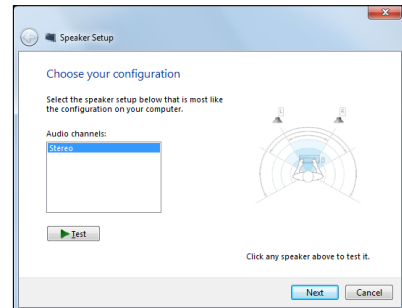

6. Tick the **Front left and right** option, and click **Next**.

7. Click **Finish** to exit the speaker setup.

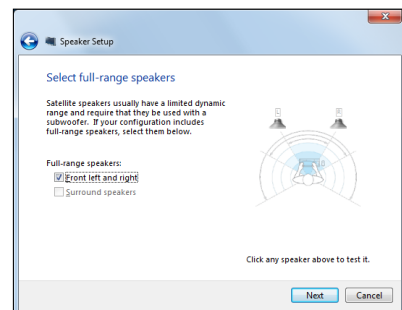

# Chapter 3: Working with Windows® 8

## System requirements

To facilitate a smoother transition from your previous operating system, read the system requirements below before upgrading to Windows® 8:

<b>Processor</b>	1GHz or faster
<b>RAM</b>	1GB (32-bit) or 2 GB (64-bit)
<b>Hard disk space</b>	16 GB (32-bit) or 20 GB (64-bit)
<b>Graphics card</b>	Microsoft DirectX9 graphics device with WDDM driver
<b>Screen resolution</b>	1024 x 768 for Windows® apps 1366 x 768 for Snap feature

---

**NOTE:** For updates on these system requirements, visit <http://www.windows.microsoft.com/en-us/windows-8/faq>

---

## Starting for the first time

When you start your computer for the first time, a series of screens appear to guide you in configuring the basic settings of your Windows® 8 operating system.

### To start for the first time:

1. Press the power button on your All-in-one PC. Wait for a few minutes until the setup screen appears.
2. Pick a language to use on your All-in-one PC.
3. Carefully read the License Terms. Tick **I accept the terms for using Windows** then click **Accept**.
4. Follow the onscreen instructions to configure the following basic items:
  - Personalize
  - Wireless
  - Settings
  - Sign in to your PC
5. Once you are done configuring the basic items, a Windows®8 tutorial appears. Watch this to learn more about Windows®8 functionalities.
6. The Start screen appears after successfully signing in to your user account.

## Windows® 8 lock screen

The Windows®8 lock screen may appear when your All-in-one PC enters the Windows®8 operating system. To proceed, tap on the lock screen or press any key on your All-in-one PC's keyboard.

## Windows® UI

The Windows® User Interface (UI) is the tile-based display used in Windows® 8. It includes the following features you can use while working on your All-in-one PC.

### Start screen

The Start screen appears after successfully signing in to your user account. It helps organize all the programs and applications you need in just one place.

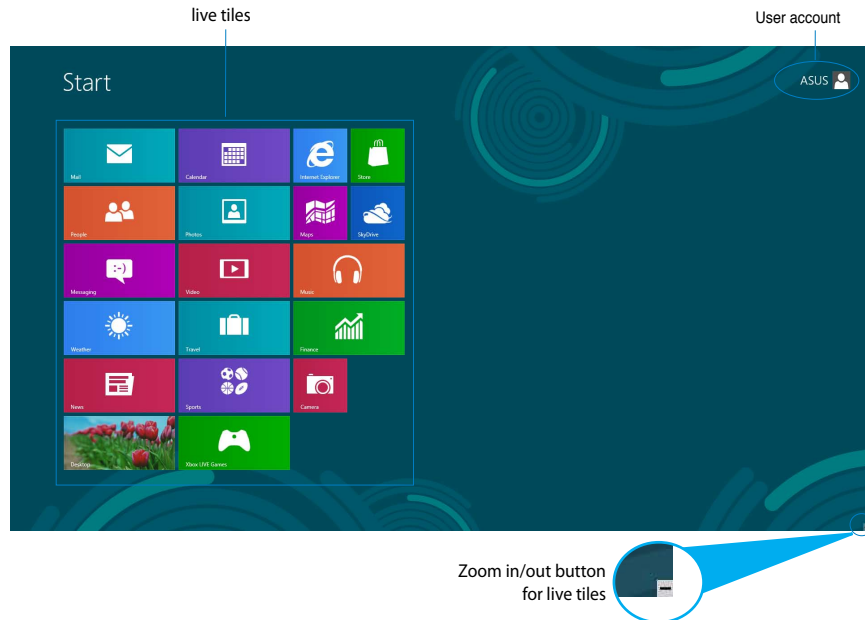

## Windows® apps

These are apps pinned on the Start screen and displayed on tiled-format for easy access.

---

**IMPORTANT!** A screen resolution of 1024 x 768 pixels or higher is required to run Windows® apps.

---

**NOTE:** Some apps require signing in to your Microsoft account before they are fully launched.

---

## Hotspots

Onscreen hotspots allow you to launch programs and access the settings of your PC. The functions in these hotspots can be activated using your mouse.

### Hotspots on a running app

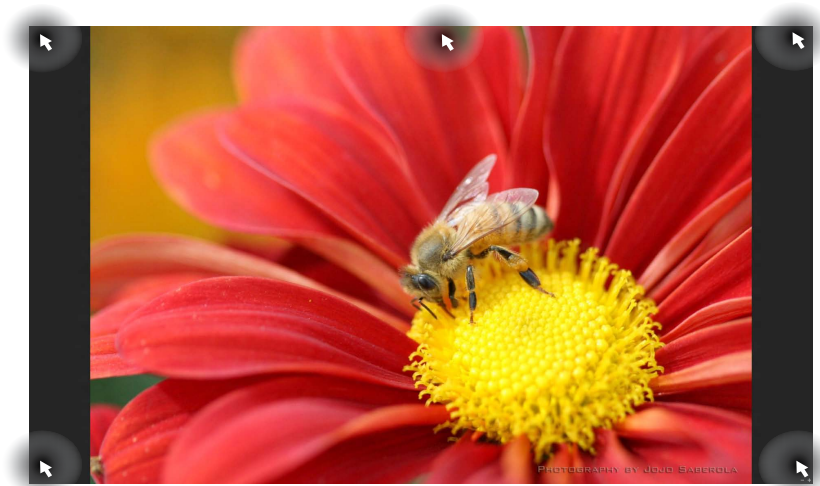

## Hotspots on the Start screen

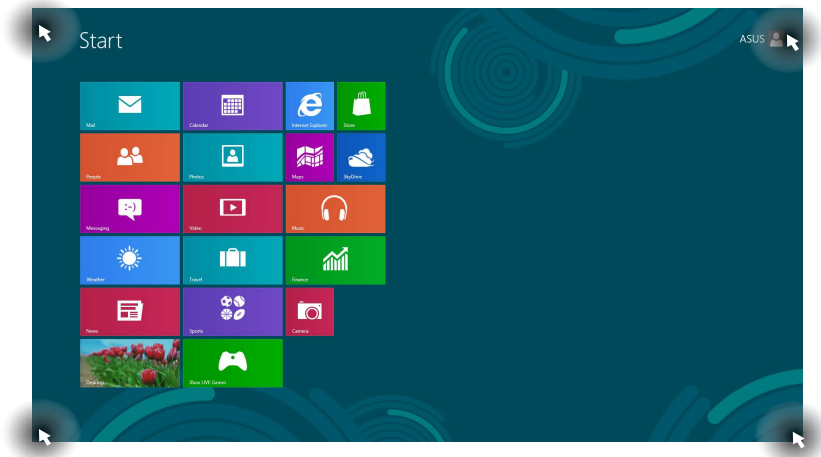

**NOTE:** Refer to the next page for the Hotspots' functions.

Hotspot	Action
<b>upper left corner</b>	<p>Hover your mouse pointer then tap on the recent app's thumbnail to revert back to that running app.</p> <hr/> <p>If you launched more than one app, slide down to show all running apps.</p>
<b>lower left corner</b>	<p><b>From a running app screen:</b></p> <p>Hover your mouse pointer then tap on the Start screen's thumbnail to go back to the Start screen.</p> <hr/> <p><b>NOTE:</b> You can also press the Windows key  on your keyboard to go back to the Start screen.</p> <hr/> <p><b>From the Start screen:</b></p> <p>Hover your mouse pointer then tap on the running app's thumbnail to go back to that app.</p> <p>Hover your mouse pointer then click on the recent app's thumbnail to go back to that app.</p>
<b>top</b>	<p>Hover your mouse pointer until it changes to a hand icon. Drag then drop the app to a new location.</p> <hr/> <p><b>NOTE:</b> This hotspot function only works on a running app or when you want to use the Snap feature. For more details, refer to <i>Snap feature</i> under <i>Working with Windows® apps</i>.</p>
<b>upper and lower right corner</b>	<p>Hover your mouse pointer to launch the Charm bar.</p>



## Working with Windows® apps



Use your All-in-one PC's touchscreen or keyboard to launch and customize your apps.

### Launching apps



Tap an app to launch it.



1. Press  twice then use the arrow keys to browse through the apps.
2. Press  to launch your selected app.

### Customizing apps

You can move, resize, or unpin apps from the Start screen using the following steps.



#### Moving apps



Tap and hold the app tile and drag it to a new location.

#### Resizing apps



Swipe down the app tile to select and launch its settings bar. Tap  to reduce or tap  to enlarge an app.

#### Unpinning apps





Swipe down the app tile to select and launch its settings bar. Tap  to unpin an app.

## Closing apps



Tap and hold the top side of the running app then drag it down to the bottom of the screen to close it.



From the running app's screen, press  + .

## Accessing All Apps

Aside from the apps already pinned on your Start screen, you can also open other applications like the exclusive ASUS Software apps bundled with your All-in-one PC through the Apps screen.

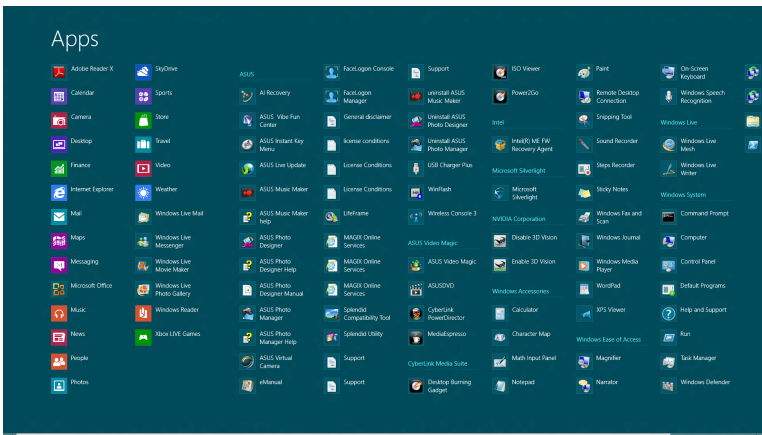



## Launching the Apps screen

Launch the Apps screen using your All-in-one PC's touchscreen or keyboard.





1. Swipe down the app tile to select and launch its settings bar.
2. Tap  to show all installed apps in your All-in-one PC.

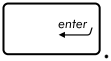

From the Start screen, press  +  to select the All Apps icon  then press .

## Pinning more apps on the Start screen

You can pin more apps on the Start screen using your touchscreen.

1. Swipe down the app tile to select and launch its settings bar. 
2. Tap  to pin the selected app to the Start screen.

## Charm bar

The Charm bar is a toolbar that can be triggered on the right side of your screen. It consists of several tools that allow you to share applications and provide quick access for customizing the settings of your All-in-one PC.





## Launching the Charm bar

**NOTE:** When called out, the Charm bar initially appears as a set of white icons. The image above shows how the Charm bar looks like once activated.

Use your All-in-one PC's touchscreen or keyboard to launch the Charm bar.

 Swipe the right edge of the screen.

 Press  + .

## Inside the Charm bar

---



### Search

This tool allows you to look for files, applications, or programs in your All-in-one PC.

---



### Share

This tool allows you to share applications via social networking sites or email.

---



### Start

This tool reverts the display back to the Start screen. From the Start screen, you can also use this to revert back to a recently opened app.

---



### Devices

This tool allows you to access and share files with the devices attached to your All-in-one PC such as an external display or printer.

---



### Settings

This tool allows you to access the PC settings of your All-in-one PC.

---

## Snap feature

The Snap feature displays two apps side-by-side, allowing you to work or switch between apps.

**IMPORTANT!** Ensure that your All-in-one PC's screen resolution is set to 1366 x 768 pixels or higher before using the Snap feature.



Snap bar





## Using Snap

Perform the following steps to activate Snap using your All-in-one PC's touchscreen or keyboard.



1. Launch the app you wish to snap.
2. Hover the mouse point on the top side of your screen.
3. Once the pointer changes to a hand icon, drag then drop the app to the left or right side of the display panel.
4. Launch another app.



1. Launch the app you wish to snap.
2. Press  + .
3. To switch between apps, press  + .

## Other keyboard shortcuts

Using the keyboard, you can also use the following shortcuts to help you launch applications and navigate Windows®8.



Switches between the Start screen and the last running app

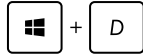

Launches the desktop

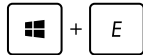

Launches the Computer window on Desktop mode



Opens the File search pane

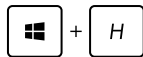

Opens the Share pane



Opens the Settings pane

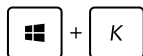

Opens the Devices pane

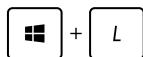

Activates the Lock screen

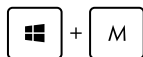

Minimizes the Internet Explorer window





Opens the Second screen pane

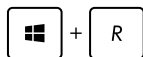

Opens the Apps search pane



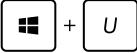
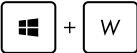

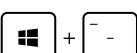
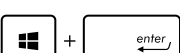
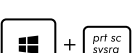

Opens the Run window

	Opens Ease of Access Center
	Opens the Settings search pane
	Opens a menu box of Windows tools
	Launches the magnifier icon and zooms in your screen
	Zooms out your screen
	Opens the Narrator Settings
	Enables the print screen function

## Turning your All-in-one PC off

Do either of the following to shut down your All-in-one PC:

-  Tap from  the Charm bar then tap  > **Shut down** to do a normal shutdown.
- From the log-in screen, tap  > **Shut down**.
- If your All-in-one PC is unresponsive, press and hold the power button for at least four (4) seconds until your All-in-one PC turns off.

## Entering the BIOS Setup

BIOS (Basic Input and Output System) stores system hardware settings that are needed for system startup in the PC.

In normal circumstances, the default BIOS settings apply to most conditions to ensure optimal performance. Do not change the default BIOS settings except in the following circumstances:

- An error message appears on the screen during the system bootup and requests you to run the BIOS Setup.
- You have installed a new system component that requires further BIOS settings or update.

---

**WARNING!** Inappropriate BIOS settings may result to instability or boot failure. We strongly recommend that you change the BIOS settings only with the help of a trained service personnel.

---

## Quickly enter the BIOS

Windows® 8 boot time is quite fast, so we developed these three ways for you to quickly access the BIOS:

- When your All-in-one PC is off, press the power button for at least four (4) seconds to access the BIOS directly.
- Press the power button for at least four (4) seconds to shut down your All-in-one PC, then press the power button again to turn your All-in-one PC back on, and press <F2> during POST.
- When your All-in-one PC is off, disconnect the power cord from your All-in-one PC's power connector. Reconnect the power cord and press the power button to turn on your All-in-one PC. Press <F2> during POST.

---

**NOTE:** POST (Power-On Self Test) is a series of software controlled diagnostic tests that run when you turn on your PC.

---



# Chapter 4: Connecting to the Internet

Access emails, surf the Internet, and share applications via social networking sites on or from your PC using wireless/Wi-Fi or wired connection.

## Wi-Fi connection

1. Launch the Charm bar from the Start screen or from any application mode.

**NOTE:** For details, refer to the section *Charm bar* under *Working with Windows® apps*.

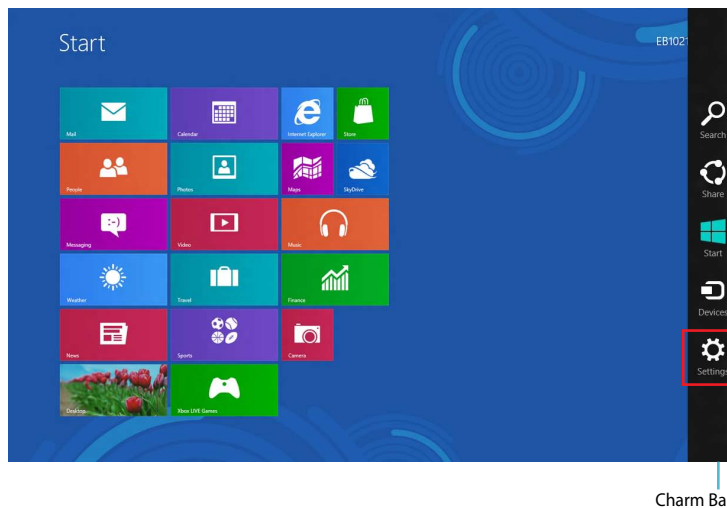

2. From the Charm bar, select **Settings** and click the network icon  Available.

3. Select the wireless network that you want to connect to from the list.
4. Click **Connect**.

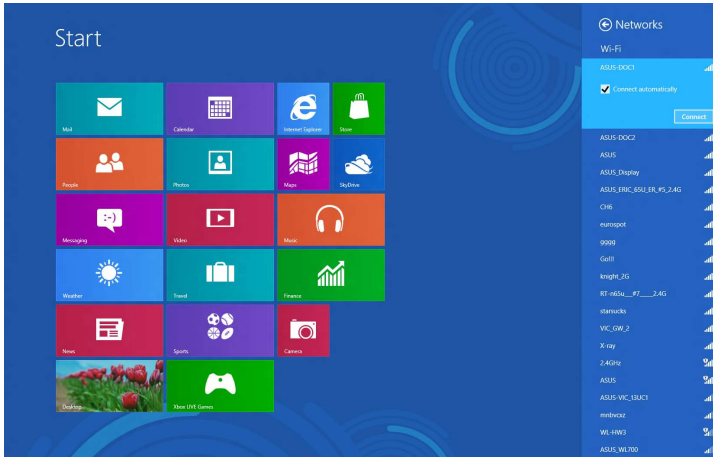

---

**NOTE:** You may be prompted to enter a security key to connect to a secured wireless network.

---

## Wired connection

1. Use a network (RJ-45) cable to connect your All-in-one PC to a DSL/cable modem or a local area network (LAN).
2. Turn on your computer.
3. Configure the necessary Internet connection settings.

---

### NOTES:

- For more details, refer to the sections *Configuring a dynamic IP/PPPoE network connection* or *Configuring a static IP network connection*.
  - Contact your Internet Service Provider (ISP) for details or assistance in setting up your Internet connection.
- 

## Configuring a dynamic IP/PPPoE network connection

### To configure a dynamic IP/PPPoE or static IP network connection:

1. From the Start screen, click **Desktop** to launch the Desktop mode.

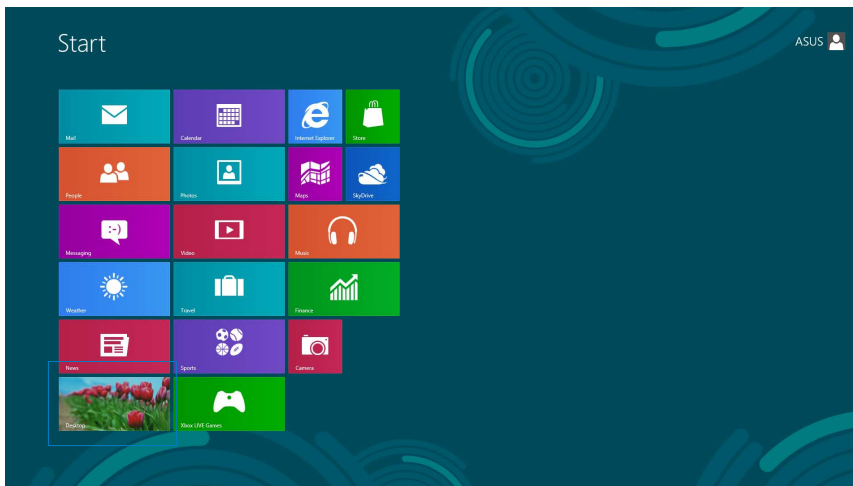

2. From the Windows® taskbar, right-click the network icon  and click **Open Network and Sharing Center**.
3. From the Open Network and Sharing Center screen, click **Change Adapter settings**.
4. Right-click on your LAN and select **Properties**.
5. Click **Internet Protocol Version 4(TCP/IPV4)** and click **Properties**.

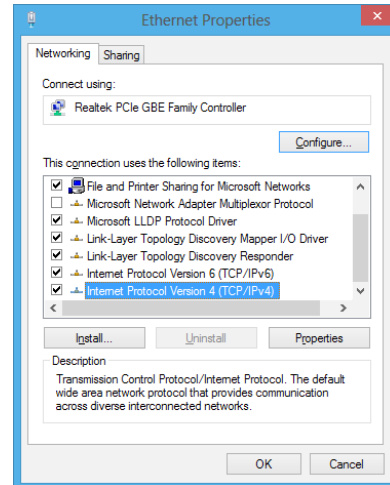

6. Click **Obtain an IP address automatically** and click **OK**.

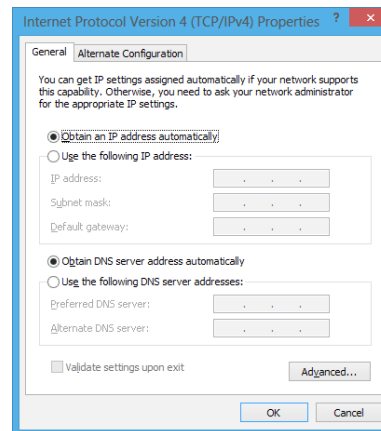

**NOTE:** Continue to the next steps if you are using PPPoE connection.

7. Return to the **Network and Sharing Center** and then click Set up a new connection or network.

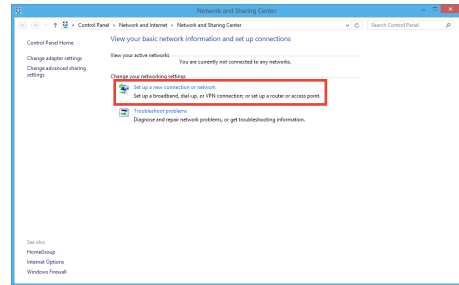

8. Select **Connect to the Internet** and click **Next**.

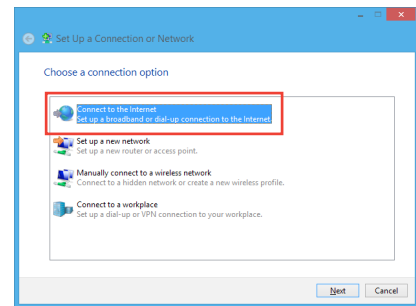

9. Select **Broadband (PPPoE)** and click **Next**.

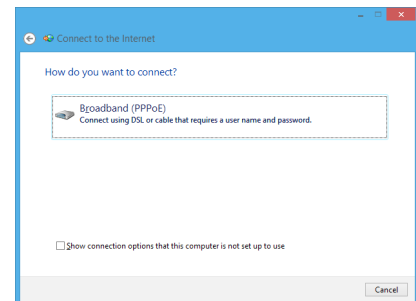

10. Enter your **Username, Password, and Connection name**. Click **Connect**.
11. Click **Close** to finish the configuration.
12. Click the network icon in the taskbar and click the connection you just created.
13. Enter your user name and password. Click **Connect** to connect to the Internet.

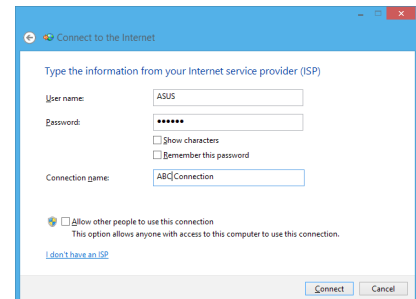

## Configuring a static IP network connection

### To configure a static IP network connection:

1. Repeat steps 1 to 4 of the previous section **Configuring a dynamic IP/PPPoE network connection**.
2. Click **Use the following IP address**.
3. Enter the IP address, Subnet mask and Gateway from your service provider.
4. If needed, enter the preferred DNS Server address and alternative address.
5. When done, click **OK**.

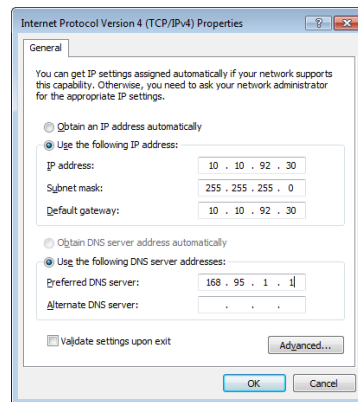

## Chapter 5: Recovering your system

### Resetting your PC

The **Reset your PC** option restores your PC to its factory default settings.

---

**IMPORTANT!** Back up all your data before using this option.

---

#### To reset your PC:

1. Press <**F9**> during bootup.

---

**IMPORTANT!** To go through POST, follow any of the ways described in the section *Quickly enter the BIOS* in Chapter 3.

---

2. From the screen, click **Troubleshoot**.
3. Select **Reset your PC**.
4. Click **Next**.
5. Select **Only the drive where the Windows is installed**.
6. Select **Just remove my files**.
7. Click **Reset**.

## Recovering from a system image file

You can create a USB recovery drive and use this to recover your PC's settings.

### Creating a USB recovery drive

**WARNING!** All files on your USB storage device will be permanently deleted during the process. Before you proceed, ensure that you back up all your important data.

#### To create a USB recovery drive:

1. Launch the Control Panel from the All Apps screen.

**NOTE:** For details, refer to *Launching the All Apps screen under Working with Windows® apps.*

2. From the Control Panel's System and Security, click **Find and fix problems**.
3. Click **Recovery > Create a recovery drive**.
4. Click **Next**.

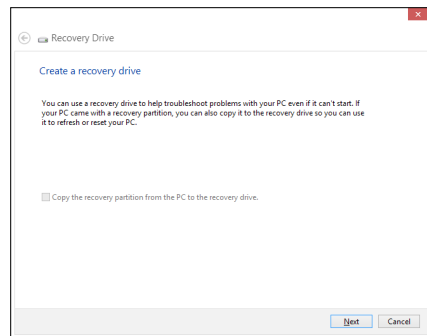

5. Select the USB storage device where you want to copy the recovery files.
6. Click **Next**.

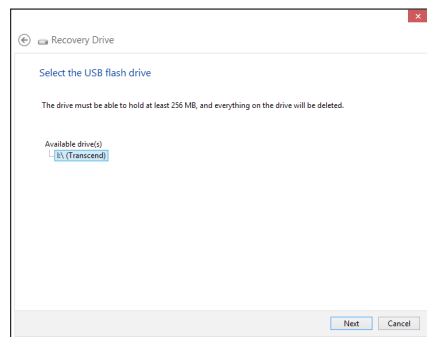



7. Click **Create**. Wait for a while for the process to complete.
8. When the process is completed, click **Finish**.

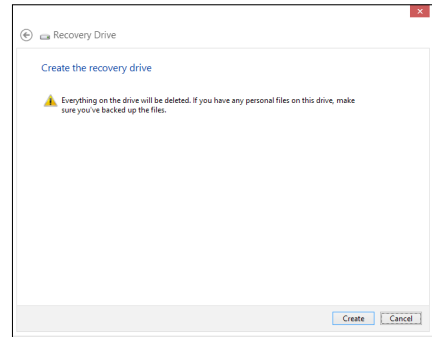

## Removing everything and reinstalling Windows

Restoring your PC to its original factory settings can be done using the Remove everything and reinstall option in PC Settings. Refer to the steps below to use this option.

---

**IMPORTANT!** Back up all your data before using this option.

---

---

**NOTE:** This process may take a while to complete.

---

1. Launch the Charm bar.
2. Click **Settings > Change PC Settings > General**.
3. Scroll down to view the Remove everything and reinstall Windows option. Under this option, click **Get Started**.
4. Follow the onscreen instructions to complete the reinstallation and reset process.

# Appendices

## Notices

### REACH

Complying with the REACH (Registration, Evaluation, Authorization, and Restriction of Chemicals) regulatory framework, we publish the chemical substances in our products at ASUS REACH website at <http://csr.asus.com/english/REACH.htm>

### ASUS Recycling/Takeback Services

ASUS recycling and takeback programs come from our commitment to the highest standards for protecting our environment. We believe in providing solutions for you to be able to responsibly recycle our products, batteries, other components, as well as the packaging materials. Please go to <http://csr.asus.com/english/Takeback.htm> for the detailed recycling information in different regions.

### COATING NOTICE

**IMPORTANT!** To provide electrical insulation and maintain electrical safety, a coating is applied to insulate the device except on the areas where the I/O ports are located.

### Federal Communications Commission Statement

This device complies with Part 15 of the FCC Rules. Operation is subject to the following two conditions:

- This device may not cause harmful interference, and
- This device must accept any interference received including interference that may cause undesired operation.

This equipment has been tested and found to comply with the limits for a Class B digital device, pursuant to Part 15 of the FCC Rules. These limits are designed to provide reasonable protection against harmful interference in a residential installation. This equipment generates, uses and can radiate radio frequency energy and, if not installed and used in accordance with manufacturer's instructions, may cause harmful interference to radio communications. However, there is no guarantee that interference will not occur in a particular installation. If this equipment does cause harmful interference to radio or television reception, which can be determined by turning the equipment off and on, the user is encouraged to try to correct the interference by one or more of the following measures:

- Reorient or relocate the receiving antenna.
- Increase the separation between the equipment and receiver.

- Connect the equipment to an outlet on a circuit different from that to which the receiver is connected.
- Consult the dealer or an experienced radio/TV technician for help.

**CAUTION:** Any changes or modifications not expressly approved by the guarantee of this device could void the user's authority to operate the equipment.

### RF exposure warning

This equipment must be installed and operated in accordance with provided instructions and the antenna(s) used for this transmitter must be installed to provide a separation distance of at least 20 cm from all persons and must not be co-located or operating in conjunction with any other antenna or transmitter. End-users and installers must be provided with antenna installation instructions and transmitter operating conditions for satisfying RF exposure compliance.

### Canadian Department of Communications Statement

This digital apparatus does not exceed the Class B limits for radio noise emissions from digital apparatus set out in the Radio Interference Regulations of the Canadian Department of Communications.

This class B digital apparatus complies with Canadian ICES-003.

### IC Radiation Exposure Statement for Canada

This equipment complies with IC radiation exposure limits set forth for an uncontrolled environment. To maintain compliance with IC RF exposure compliance requirements, please avoid direct contact to the transmitting antenna during transmitting. End users must follow the specific operating instructions for satisfying RF exposure compliance.

Operation is subject to the following two conditions:

- This device may not cause interference and
- This device must accept any interference, including interference that may cause undesired operation of the device.

## Declaration of Conformity (R&TTE directive 1999/5/EC)

The following items were completed and are considered relevant and sufficient:

- • Essential requirements as in [Article 3]
- • Protection requirements for health and safety as in [Article 3.1a]
- • Testing for electric safety according to [EN 60950]
- • Protection requirements for electromagnetic compatibility in [Article 3.1b]
- • Testing for electromagnetic compatibility in [EN 301 489-1] & [EN 301 489-17]
- • Effective use of the radio spectrum as in [Article 3.2]
- • Radio test suites according to [EN 300 328-2]

## CE Mark Warning

This is a Class B product, in a domestic environment, this product may cause radio interference, in which case the user may be required to take adequate measures.



## CE marking for devices without wireless LAN/Bluetooth

The shipped version of this device complies with the requirements of the EEC directives 2004/108/EC "Electromagnetic compatibility" and 2006/95/EC "Low voltage directive".



## CE marking for devices with wireless LAN/ Bluetooth

This equipment complies with the requirements of Directive 1999/5/EC of the European Parliament and Commission from 9 March, 1999 governing Radio and Telecommunications Equipment and mutual recognition of conformity.

**ⓘ is for class II device.**

## Wireless Operation Channel for Different Domains

N. America	2.412-2.462 GHz	Ch01 through CH11
Japan	2.412-2.484 GHz	Ch01 through Ch14
Europe ETSI	2.412-2.472 GHz	Ch01 through Ch13

**NO DISASSEMBLY**

**The warranty does not apply to the products that have been disassembled by users**

**Lithium-Ion Battery Warning**

**CAUTION:** Danger of explosion if battery is incorrectly replaced. Replace only with the same or equivalent type recommended by the manufacturer. Dispose of used batteries according to the manufacturer's instructions.

**No Exposure to Liquids**

DO NOT expose to or use near liquids, rain, or moisture. This product is not waterproof or oil-proof.



This symbol of the crossed out wheeled bin indicates that the product (electrical, electronic equipment, and mercury-containing button cell battery) should not be placed in municipal waste.

■ Check local regulations for disposal of electronic products.



DO NOT throw the battery in municipal waste. The symbol of the crossed out wheeled bin indicates that the battery should not be placed in municipal waste.

## Global Environmental Regulation Compliance and Declaration

ASUS follows the green design concept to design and manufacture our products, and makes sure that each stage of the product life cycle of ASUS product is in line with global environmental regulations. In addition, ASUS disclose the relevant information based on regulation requirements.

Please refer to <http://csr.asus.com/english/Compliance.htm> for information disclosure based on regulation requirements ASUS is complied with:

### Japan JIS-C-0950 Material Declarations

### EU REACH SVHC

### Korea RoHS

### Swiss Energy Laws

## UL Safety Precaution

To meet safety requirements, the All-in-one PC must be mounted to a bracket which guarantees the necessary stability considering the weight of the All-in-one PC. The All-in-one PC shall only be mounted and used with UL listed mounting adapters and brackets (e.g. VESA).

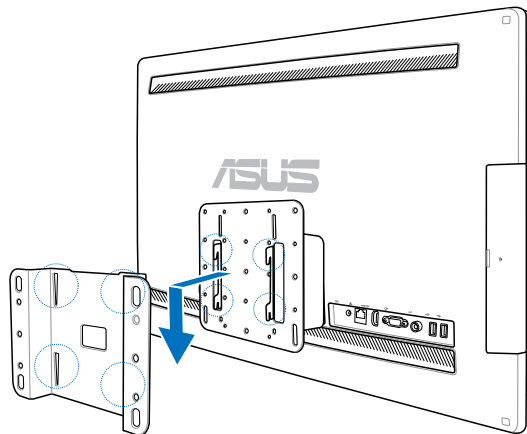

## ENERGY STAR complied product



ENERGY STAR is a joint program of the U.S. Environmental Protection Agency and the U.S. Department of Energy helping us all save money and protect the environment through energy efficient products and practices.

All ASUS products with the ENERGY STAR logo comply with the ENERGY STAR standard, and the power management feature is enabled by default. The monitor and computer are automatically set to sleep after 15 and 30 minutes of user inactivity. To wake your computer, click the mouse or press any key on the keyboard.

Please visit <http://www.energy.gov/powermanagement> for detail information on power management and its benefits to the environment. In addition, please visit <http://www.energystar.gov> for detail information on the ENERGY STAR joint program.

---

**NOTE:** ENERGY STAR is NOT supported on Freedos and Linux-based products.

---

<b>Manufacturer</b>	ASUSTeK Computer Inc.	
	Tel:	+886-2-2894-3447
	Address:	No. 150, LI-TE RD., PEITOU, TAIPEI 112, TAIWAN R.O.C
<b>Authorised representative in Europe</b>	ASUSTeK Computer GmbH	
	Address:	HARKORT STR. 21-23, 40880 RATINGEN, GERMANY



## Free Manuals Download Website

<http://myh66.com>

<http://usermanuals.us>

<http://www.somanuals.com>

<http://www.4manuals.cc>

<http://www.manual-lib.com>

<http://www.404manual.com>

<http://www.luxmanual.com>

<http://aubethermostatmanual.com>

Golf course search by state

<http://golfingnear.com>

Email search by domain

<http://emailbydomain.com>

Auto manuals search

<http://auto.somanuals.com>

TV manuals search

<http://tv.somanuals.com>