



NetCamera Pro IP Security Wireless Motorized Camera

A02-IPCAM2-W54



User Manual

A02-IPCAM2-W54_ME01

Where solutions begin





Copyright

The Atlantis Land logo is a registered trademark of Atlantis Land SpA. All other names mentioned may be trademarks or registered trademarks of their respective owners. Subject to change without notice. No liability for technical errors and/or omissions.

CE Mark Warning

This is a Class B product. In a domestic environment, this product may cause radio interference, in which case the user may be required to take adequate measures.

Important Note

The antenna(s) used for this equipment must be installed to provide a separation distance of at least 30 cm from all persons.

This equipment must not be operated in conjunction with any other antenna.

FCC Warning

Warning: Changes or modifications to this unit not expressly approved by the party responsible for compliance could void the user authority to operate the equipment.

This device complies with Part 15 of the FCC Rules. Operation is subject to the following two conditions: (1) this device may not cause harmful interference, and (2) this device must accept any interference received, including interference that may cause undesired operation.

The user's manual or instruction manual for an intentional or unintentional radiator shall caution the user that changes or modifications not expressly approved by the party responsible for compliance could void the user's authority to operate the equipment.

NOTE: This equipment has been tested and found to comply with the limits for a Class B digital device, pursuant to Part 15 of the FCC Rules. These limits are designed to provide reasonable protection against harmful interference in a residential installation. This equipment generates, uses and can radiate radio frequency energy and, if not installed and used in accordance with the instructions, may cause harmful interference to radio communications.

However, there is no guarantee that interference will not occur in a particular installation. If this equipment does cause harmful interference to radio or television reception, which can be determined by turning the equipment off and on, the user is encouraged to try to correct the interference by one or more of the following measures:

- Reorient or relocate the receiving antenna.
- Increase the separation between the equipment and receiver.
- Connect the equipment into an outlet on a circuit different from that to which the receiver is needed.
- Consult the dealer or an experienced radio/TV technician for help.

NOTE

THE MANUFACTURER IS NOT RESPONSIBLE FOR ANY RADIO OR TV INTERFERENCE CAUSED BY UNAUTHORIZED MODIFICATIONS TO THIS EQUIPMENT SUCH MODIFICATIONS COULD VOID THE USER'S AUTHORITY TO OPERATE THE EQUIPMENT.

TABLE OF CONTENTS

CHAPTER 1	1
1.1 INTRODUCTION	1
CHAPTER 2	2
2.1 NETWORK:.....	2
2.2 WEB BROWSER:.....	2
2.3 IPVIEW SE APPLICATION:.....	2
CHAPTER 3	3
3.1 SIMPLE TO USE	3
3.2 SUPPORT VARIETY OF PLATFORMS.....	3
3.3 WEB CONFIGURATION.....	3
3.4 REMOTE UTILITY	3
3.5 BROAD RANGE OF APPLICATIONS	3
CHAPTER 4	5
4.1 FRONT PANEL.....	5
4.2 REAR PANEL.....	6
CHAPTER 5	8
5.1 PACKAGE CONTENTS	8
CHAPTER 6	9
6.1 ATTACH WIRELESS ANTENNA	9
6.2 CONNECT AN ETHERNET CABLE AND POWER SUPPLY.....	9
6.3 ATTACHING THE METAL CLIP	10
CHAPTER 7	11
CHAPTER 8	12
8.1 DEFAULT SETTING.....	12
8.2 BROWSER CONFIGURATION	12
8.2.1 Controlling and Viewing Video.....	15
Zoom On / Zoom Off	15
Adjust the Viewing Angle.....	15
Adjust the Image Brightness.....	15
Audio Function	15
Capture Video and Still Images.....	15
NightShot.....	15
8.2.3 Basic Setup	16
Basic → Network	16
Basic → Camera Name	17
Basic → Time Zone.....	17
Basic → Report.....	18
8.2.4 Advanced Setup	19
Advanced → Video	19
Advanced → Network.....	22
Advanced → Wireless.....	24
Advanced → Tools	26
Advanced → Account.....	29
Advanced → Timezone.....	30
8.2.5 Maintenance.....	31
Maintenance → Configuration	31
Maintenance → Firmware Upload.....	33
8.2.6 Logout	35



8.2.7 Help 35

CHAPTER 9..... 36

9.1 APPLICATIONS 36

9.2 IP WIRELESS SECURITY MOTORIZED CAMERA APPLICATION DIAGRAMS 37

9.2.1 Home Applications: 37

9.2.2 SOHO Applications: 37

CHAPTER 10 38

10.1 INSTALLATION 38

CHAPTER 11 42

11.1 IPVIEW PRO 42

Item Feature 43

11.1.1 Using IPView Pro 45

Adding a Camera..... 45

Recording Video 46

Playing Recorded Video 47

11.1.2 Configuring the System 47

Camera Configuration..... 47

Mailing Configuration 49

Proxy Server..... 50

Recording Configuration..... 50

Others..... 51

Log List..... 52

Account 52

About 53

CHAPTER 12 54

12.1 WIZARD SETUP 54

12.2 HOW TO USE WIZARD SETUP 56

CHAPTER 13 60

13.1 INSTALLING FFDSHOW 60

13.2 CONFIGURATION OF FFDSHOW 62

13.3 PLAYING THE VIDEO 63

13.4 FIXING THE VIDEO FILE 64

APPENDIX A..... 65

APPENDIX B..... 67

APPENDIX C..... 72

APPENDIX D..... 74

APPENDIX E..... 75

APPENDIX F..... 81

APPENDIX G..... 83





Chapter 1

Introduction

1.1 Introduction

Thank you for purchasing the MPEG-4 (Wireless) Pan/Tilt Internet Camera, a standalone system that can be connected directly to an Ethernet or Fast Ethernet, and also supported by the wireless transmission based on the IEEE 802.11g standard. With support for latest MPEG-4 technology, you can record streaming video that utilizes high quality MPEG-4 images to your hard drive, enable motion detection and setup automated email alerts for security. The built-in microphone provides you with the audio function, allowing you to “watch” and “listen” from the camera. Compared to the conventional PC Camera, the camera features a built-in CPU and web-based solutions that can provide a cost-effective solution to transmit the real-time high-quality video images and sounds synchronously for monitoring.

The camera can be managed remotely, so that you can use a web browser to access and control it from any notebook/desktop PC over the Intranet or Internet. The simple installation procedures and web-based interface allow you to integrate it into your network easily. With comprehensive applications supported, the Internet camera is your best solution for remote monitor, high quality, and high performance video images.

Chapter 2

System Requirement

2.1 Network:

Local Area Network: 10Base-T Ethernet or 100Base TX Fast Ethernet

Wireless Local Area Network: IEEE 802.11b/g Wireless LAN

Recommended PC or Notebook to Access the IP Wireless Security Motorized Camera

2.2 Web Browser:

System requirement:

- CPU: Intel Celeron 1.5GHz or above (Intel Pentium 4 is preferred)
- Memory Size: 128 MB (256 MB recommended)
- VGA card resolution: 800x600 or above
- Internet Explorer 5.0 or above (ActiveX & JAVA Mode – Image View for Windows OS and JAVA Mode – Image View for other OS)
- Netscape 6.0 or above (JAVA Mode – Image View)

2.3 IPView SE Application:

System requirement:

- Support OS: Win 98 SE, Win 2000, Win Me, Win XP
- System requirement for IPView SE:
- CPU: Intel Celeron 1.5GHz or above (Intel Pentium 4 is preferred)
- Memory Size: 128 MB (256 MB recommended)
- VGA card resolution: 800x600 or above

Chapter 3

Features and Benefits

This section describes the features and benefits of the IP Wireless Security Motorized Camera.

3.1 Simple To Use

The MPEG-4 (Wireless) Pan/Tilt Internet Camera is a standalone system with built-in CPU, no special hardware (such as a PC frame capture card) or software required. The camera supports DirectX 9.0; therefore, the only requirement you need is the web browser software such as Internet Explorer 5.0 or above. Once you have a valid IP Address, just connect it and you can view the picture and receive sound from your camera. In addition, the camera's stand allows you to adjust the camera for optimal viewing angle. You can tilt the camera right or left (up to 170/ 170 degrees), forward or backward (up to 45/90 degrees).

3.2 Support Variety of Platforms

The camera supports TCP/IP networking, SMTP e-mail, HTTP and other Internet related protocols. It can be utilized in a mixed operating system environment, including Windows 98SE/ME/ 2000/XP. Moreover, it can be integrated easily into other www/ Intranet applications.

3.3 Web Configuration

Applying a standard web browser, the administrator can configure and manage the camera directly from its own web page via the Intranet or Internet. Up to 64 users name and password are permitted with privilege setting controlled by the administrator.

3.4 Remote Utility

The powerful IPView Pro application assigns the administrator with a pre-defined user ID and password, allowing the administrator to modify the camera settings from the remote site via Intranet or Internet. When new firmware is available, you can also upgrade remotely over the network for added convenience. Users are also allowed to monitor the image, and take snapshots.

3.5 Broad Range of Applications

With today's high-speed Internet services, the camera can provide the ideal solution for live video images over the Intranet or Internet for remote monitoring. The camera allows remote access from a web browser for live image viewing, and allows the administrator to manage and control the camera anywhere and anytime in the world. Apply the camera to monitor various objects and places such as homes, offices, banks, hospitals, child-care centers, amusement parks and other varieties of industrial



IP Wireless Security Motorized Camera

and public monitoring. The camera can also be used for intruder detection; in addition, it can capture still images for archiving and many more applications.

Chapter 4

Physical Description

This section describes the externally visible features of the IP Wireless Security Motorized Camera.

4.1 Front Panel



LED		Meaning
1	Power	The Power LED is positioned on the right side of the two LEDs. A steady light confirms that the camera is powered on
2	Link	The Link LED is positioned on the left side of the two LEDs. A steady light confirms that the camera has good connection to LAN connectivity. Dependent on the data traffic, the LED will begin to flash to indicate that the camera is receiving/sending data from/to the network.
3	Mic	The built-in omni-directional microphone allows the camera to receive sound and voice.

4.2 Rear Panel

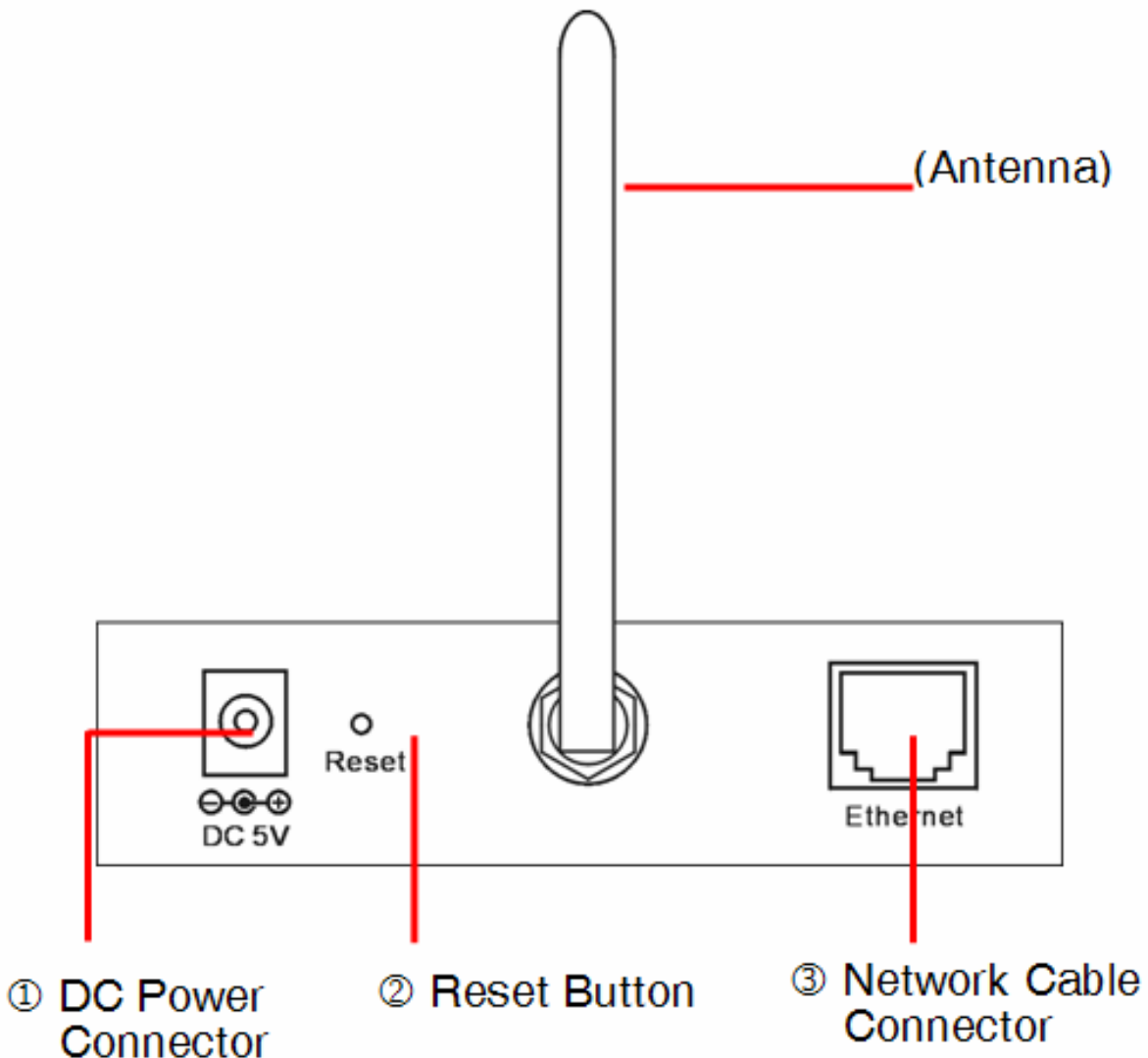

Port		Meaning
1	Network Cable	The Wireless Internet Camera's rear panel features an RJ-45 connector for connections to 10Base-T Ethernet cabling or 100Base-TX Fast Ethernet cabling. The port supports the N-Way protocol and "AutoMDIX" function, allowing the camera to automatically detect or negotiate the transmission speed of the network.
2	Antenna Connector	There is the SMA type antenna connector located on the rear panel of the Wireless Internet Camera, providing connection for one high sensitivity antenna included in the package. The rotatable external antenna allows you to adjust its position to obtain the maximum signal.
3	Reset Button	Factory Reset will be initiated when the reset button is pressed continuously for three seconds; meanwhile, the Link LED lights up or blinks. Release the reset button and the Link LED will turn off, indicating that the camera restores the factory default settings. When factory reset is completed, the configuration of camera will return to the defaults as:

		<ul style="list-style-type: none">• IP address: 192.168.1.2• Administrator's login name: admin• Password: admin• Wireless status (for wireless model): disabled
4	POWER (jack)	The DC power input connector is located on the camera's rear panel, and is labeled DC5V 2.5A with a single jack socket to supply power to the camera. Power will be generated when the power supply is connected to a wall outlet.

Chapter 5

Unpacking The IP Wireless Security Motorized Camera

5.1 Package Contents

Carefully remove all items from the package. In addition to this User's Guide, be certain that you have:

- One IP Wireless Security Motorized Camera
- One External Wireless Antenna
- One Installation CDROM (with IPView Pro)
- One Quick Installation Guide
- One DC power adapter suitable for your country's electric power
- One Metal Clip
- One RJ-45 Ethernet Cable

If any item is missing, or if you find any damage or mismatch, promptly contact your dealer for assistance immediately. Also, keep the box and packing materials in case you need to ship the unit in the future.

Chapter 6

Hardware Installation

This section describes the Hardware installation procedure for the IP Wireless Security Motorized Camera.

6.1 Attach Wireless Antenna

From the rear panel of the IP Wireless Security Motorized Camera, screw the external Antenna that came with the IP Wireless Security Motorized Camera into the antenna connector.

6.2 Connect an Ethernet cable and Power Supply

Connect an Ethernet cable to the network cable connector located on the camera's rear panel, and then attach it to the network.

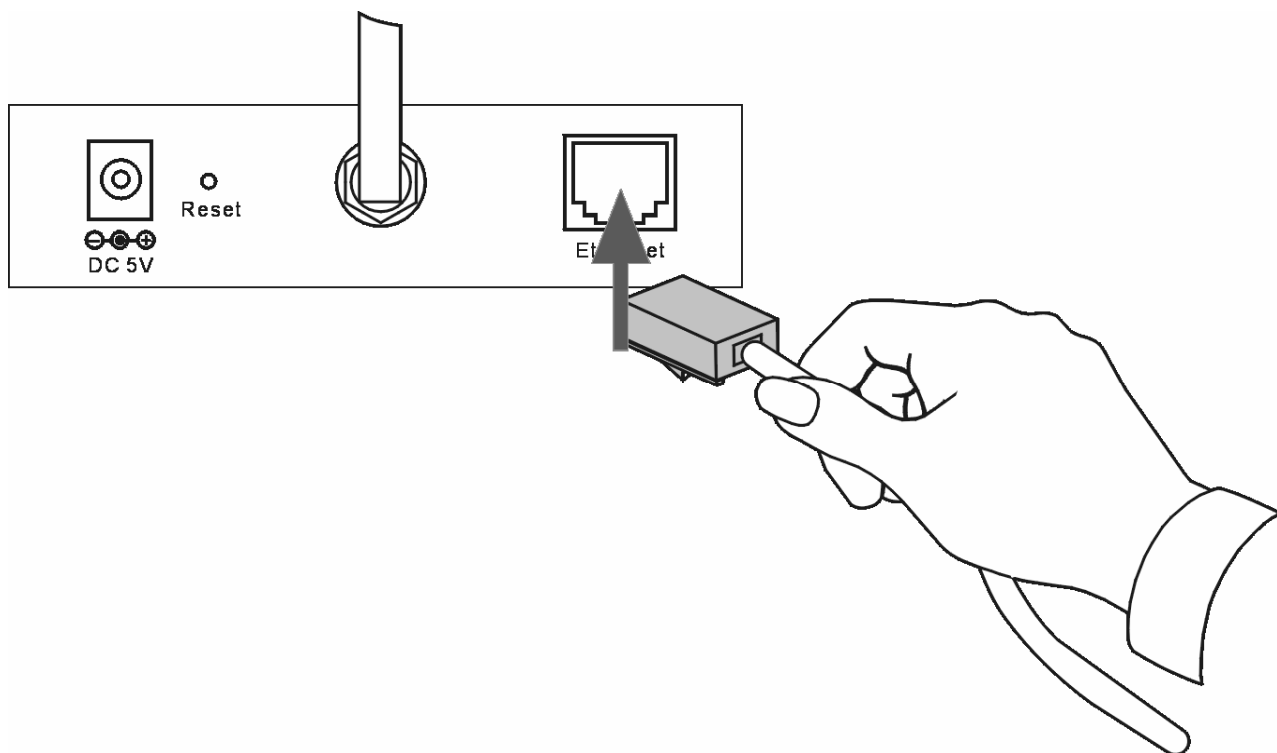

Attach the external power supply to the DC power input connector located on camera's rear panel, and then connect it to your local power supply. You can confirm power source is supplied from the Power LED on the camera is illuminated.

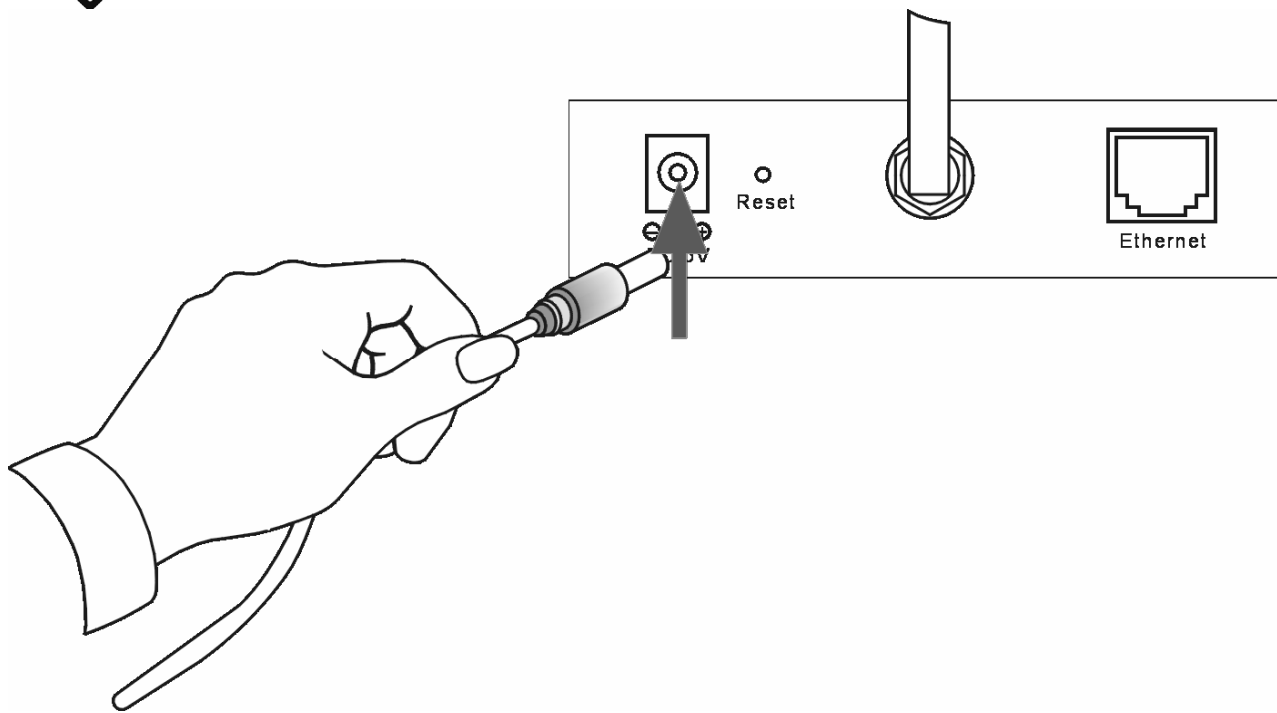

6.3 Attaching the Metal Clip

To attach the metal clip, remove the two rubber pads under the base of the camera firstly. Place the metal clip onto the camera base, and align the two holes of metal clip with two screw holes on the camera base. Then, secure the metal clip with two screws (provided in the package). There are two ears on each side of the metal clip, allowing the camera to be mounted on the ceiling or wall using two wall screws (provided in the package).

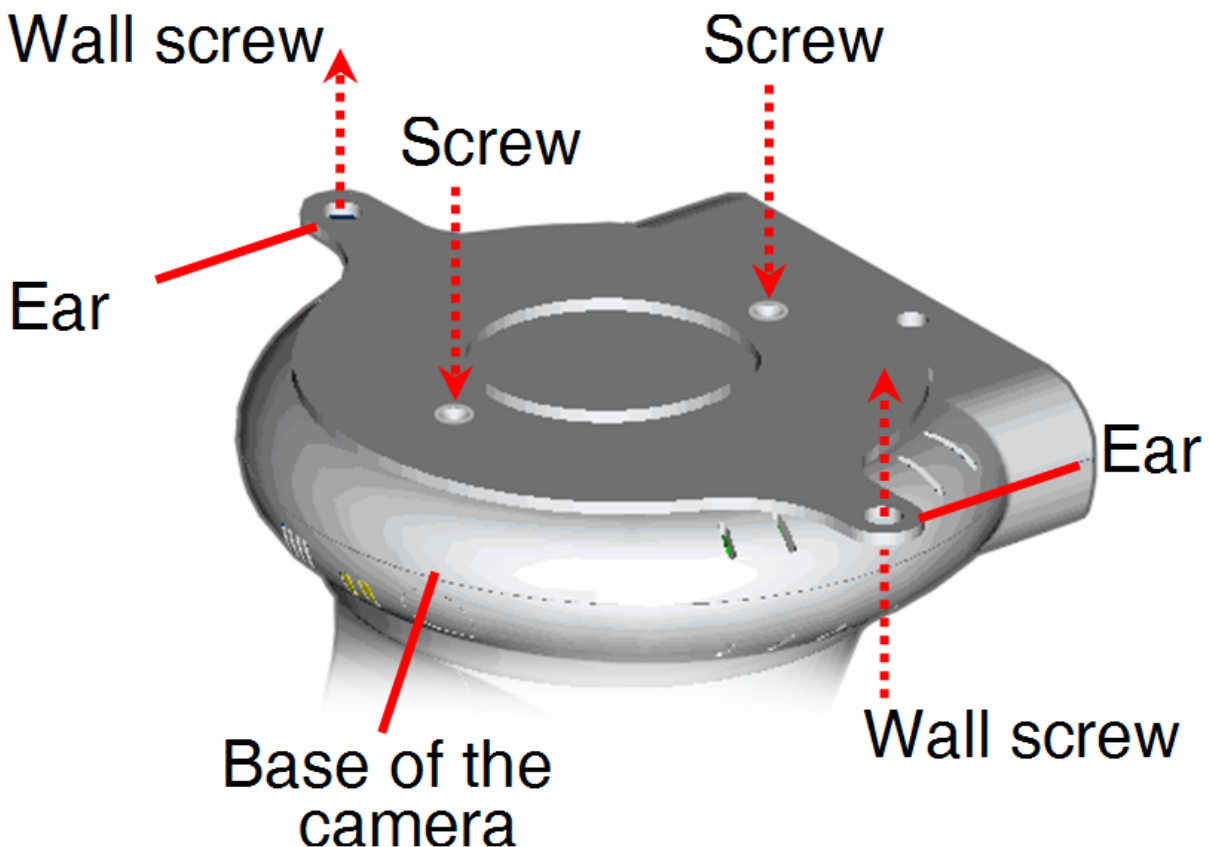

Chapter 7

Security

To ensure the highest security and prevent unauthorized usage of the IP Wireless Security Motorized Camera the Administrator has the exclusive privilege to access the System Administration for settings and control requirements to allow users the level of entry and authorize the privileges for all users. The IP Wireless Security Motorized Camera supports multi-level password protection and access to the IP Wireless Security Motorized Camera is strictly restricted to defined the user who has a "User Name" and "User Password" that is assigned by the Administrator.

Administrator can release a public user name and password so when remote users access the IP Wireless Security Motorized Camera they will have the right to view the image transmitted by the IP Wireless Security Motorized Camera.



Since the default settings are Null String, it is highly recommended to set the "Admin ID" and "Admin Password" when you are the first time to use the IP Wireless Security Motorized Camera. Once the ID and Password are defined, only the administrator has the access to management the IP Wireless Security Motorized Camera. This procedure should be done as soon as possible since the security features with the IP Wireless Security Motorized Camera will not be enabled until the "Admin ID" and "Admin Password" is defined.



The default settings of Administrator's login name/password are admin/admin, which are easily to be known by unauthorized users. Therefore, it is strongly recommended to change the login name and password when you are the first time to use the camera.

Chapter 8

Using the Camera

You can access and manage the camera through your web browser. This chapter describes the Web Configuration Utility, and provides the instructions on using the camera with a web browser.

8.1 Default Setting

Before you configure the NetCamera Pro, you need to know the following default settings:

- Password: **admin**
- Username: **admin**
- IP address : **192.168.1.2**
- Wireless : **disabled**

8.2 Browser configuration

Open the web browser, enter the local port IP address of this NetCamera Pro, which default at <http://192.168.1.2>, and click “Go” to get the login page.



Please refer to the appendix on how to install ActiveX.



IP Wireless Security Motorized Camera

Enter the default IP Address in the Address bar

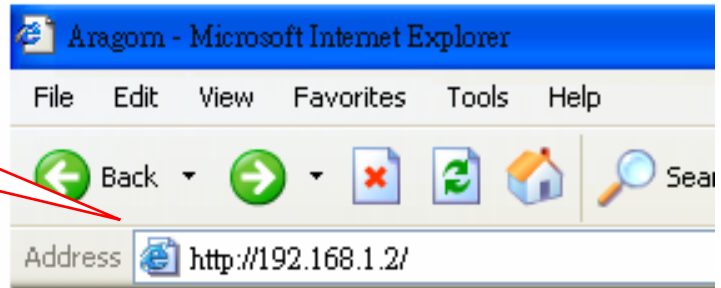

Aragorn Server

Enter Name and Password then click Login.

Name:

Password:

Enter the default username and password

When the login page appears, type **admin** in the Name and Password box, and then click **Login**. “admin” is the default username and password of the camera, and can be changed in the Web Configuration Utility.



The computer's IP address must correspond with the camera's IP address in the same segment for the two devices to communicate.

If you are denied to enter the Web Configuration Utility, the following warning message will appear on the screen. Please try to enter the correct username and password again, or contact your network administrator.

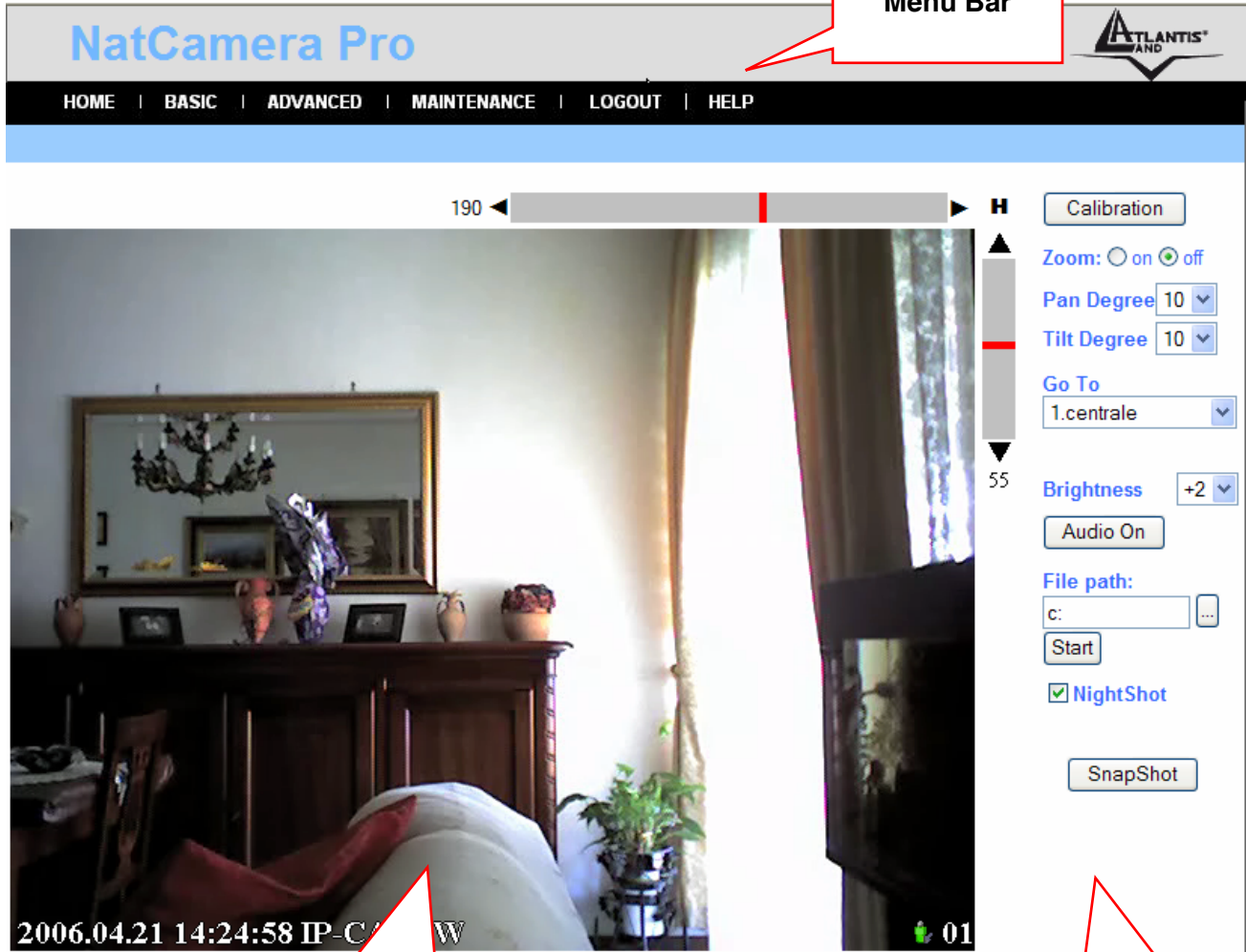

After login, the **Home** window of the Configuration Utility will appear as below, which includes three areas: **Menu Bar**, **Video Show Area**, and **Control Buttons**.

- **Menu Bar** – in the top of the window, containing six items that allow you to setup the camera.
- **Video Show Area** – allows you to view the image from the camera. You can adjust the viewing angle by using the **Slider bars**.
- **Control Buttons** – contains some buttons that allow you to control the camera’s viewing angle, position, audio, etc.

8.2.1 Controlling and Viewing Video

In the **Home** window, you can control the camera through the control buttons on the right side of the window. The real-time image from the camera will be displayed in the Video Show Area.

Zoom On / Zoom Off

When you select **ON**, move your mouse to the Video Show Area, and the cursor will change to the  icon. Then, you can zoom in/out the image by clicking the left/right button on your mouse.

When the camera is in zoom out mode, click on any position of the Video Show Area, then the position will be moved and displayed in the center of the screen.

Adjust the Viewing Angle

To adjust the camera's viewing angle, simply click the **Slider bar** at the right-top corner of Video Show Area. Then, you can easily move the camera's lens to focus on the object that you want. Clicking the **Calibration** button allows you return to the original position saved in the camera.

The **Pan Degree** and **Tilt Degree** options allow you to increase/ decrease the changing range (5~90) when you click the buttons.

When you have saved position(s) in the camera, select the position from the **Go To** pull-down list. The camera's lens will move to the position immediately.

Adjust the Image Brightness

You can adjust the image brightness level through the **Brightness** option. The range is from +5 to -5.

Audio Function

Click the **Audio On** button to enable the camera's audio function; click again to disable.

Capture Video and Still Images

Click the **Start** button to start record a video clip, and you can specify the destiny folder to save the file by clicking the browse button of the **File path** option.

Click the **Snapshot** button to capture a still image of the active camera, and save it into your computer.

NightShot

The camera is equipped with a high-resolution CCD lens to provide crystal clear images in real time, even at night. At dark or low light situation, select the **NightShot** option to switch the camera to deliver black & white images.

8.2.3 Basic Setup

The **Basic** menu contains three steps that will guide you through the basic configuration for the camera. Click **Basic** in the top menu bar to start the step-by-step configuration.

Basic → Network

The first step is to configure networking settings of the camera. According to your ISP's service, select one from the three connection types: **LAN**, **PPPoE**, and **DDNS**.

HOME | BASIC | ADVANCED | MAINTENANCE | LOGOUT | HELP

BASIC >> Network

LAN <<

Static IP **DHCP Client**

IP Address

IP Subnet Mask

Gateway IP Address

DNS

PPPoE <<

Yes **No**

User Name

Password

DDNS <<

Yes **No**

User Name

Password

Domain Name

LAN	If your network access uses a fixed IP address or DHCP service, select this option and fill in the required data provided by your network administrator in the fields of IP Address , IP Subnet Mask , Gateway IP Address , and DNS (Domain Name Server).
PPPoE	If your network access uses PPPoE (Point-to-Point Protocol over Ethernet), select this option. Fill in the required data in the User Name and Password fields, which are supplied by your ISP. The IP Address is usually allocated automatically.
DDNS	The camera supports Dynamic DNS (DDNS) feature, which allows you to assign a fixed host and domain name to a dynamic Internet IP address. Select Yes to enable this function, and then fill in the required data in the User Name , Password and Domain Name fields. Please note that you have to sign up for DDNS service with service providers before using this function.

When completed, click **Next** to continue.

Basic → Camera Name

The second step is to setup a descriptive name for the camera.

HOME	BASIC	ADVANCED	MAINTENANCE	LOGOUT	HELP
BASIC >> Camera Name					
Work Group	<input type="text" value="workgroup"/>				
Server Name	<input type="text" value="CAS-670W"/>				
Server Description	<input type="text" value="Camera Server"/>				
<input type="button" value="Next"/> <input type="button" value="Back"/>					

When completed, click **Next** to continue.

Basic → Time Zone

This step displays the current time setting of the camera. For system management purpose, a correct time setting is critical to have accurate time stamps on the system logs.

HOME	BASIC	ADVANCED	MAINTENANCE	LOGOUT	HELP
BASIC >> Time Zone					
Time	13 : 59 : 14	Date	2005 / 04 / 19		
Method	<input type="text" value="get time from my computer"/> <input type="button" value="Test"/>				
Time Zone	<input type="text" value="(GMT+08:00) Hong Kong, Perth, Singapore, Taipei"/>				
<input type="button" value="Apply"/> <input type="button" value="Back"/>					

The **Method** pull-down menu allows you to setup the correct time by getting time from the computer or time server (need an Internet connection). In the **Time Zone** pull-down menu, select a time zone according to your location.

When completed, click **Apply**.



If you setup these steps using incorrect networking settings, it will pop up a warning message on the screen. Click OK to modify these settings or Cancel to reserve the currently settings.

Basic → Report

The last step provides some tips when you have Internet access problems.

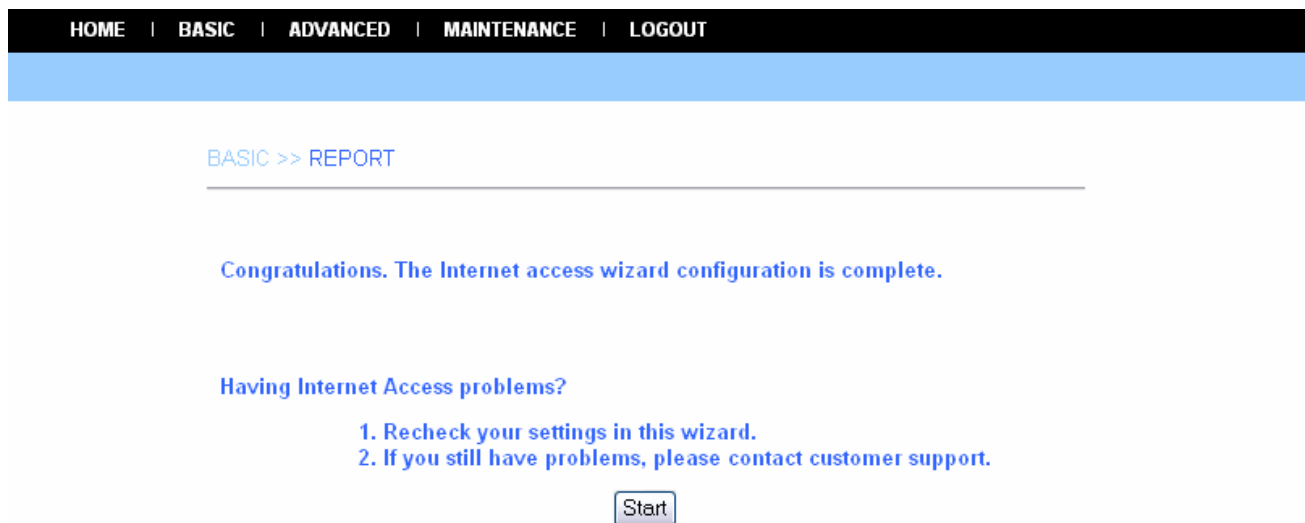

Click **Start** to complete your basic network configuration. When completed, you are brought to the **Home** window.



During the configuration, you can return to Home window by clicking the HOME button that is available in every page of the utility, or exit the utility by clicking the LOGOUT button whenever you want.

8.2.4 Advanced Setup

The camera will function fine after the **Basic** configuration, however, you may wish to explore more advanced options. This section explains each parameter and setting procedures for advanced configuration of the camera. Move your mouse onto the **Advanced** button, and it will automatically pop up a submenu bar as below.

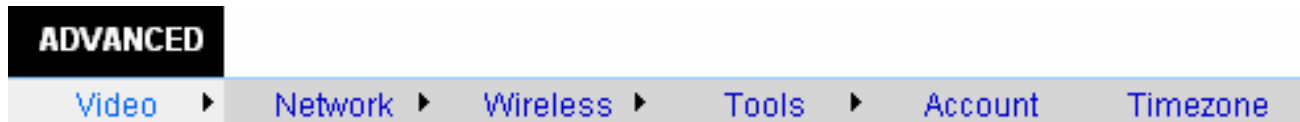

The submenu bar provides six submenu buttons: **Video**, **Network**, **Wireless** (for wireless model), **Tools**, **Account**, and **Timezone**. Each submenu button allows you to access advanced feature settings, and is explained details in the following sections.

Advanced → Video

The **Video** submenu contains three options: **Image Setting**, **Location Setting** and **Motion Detection**.

Image Setting

Click the **Image Setting** item of the **Video** submenu to bring up the following page, which allows you to setup the image settings of the camera.

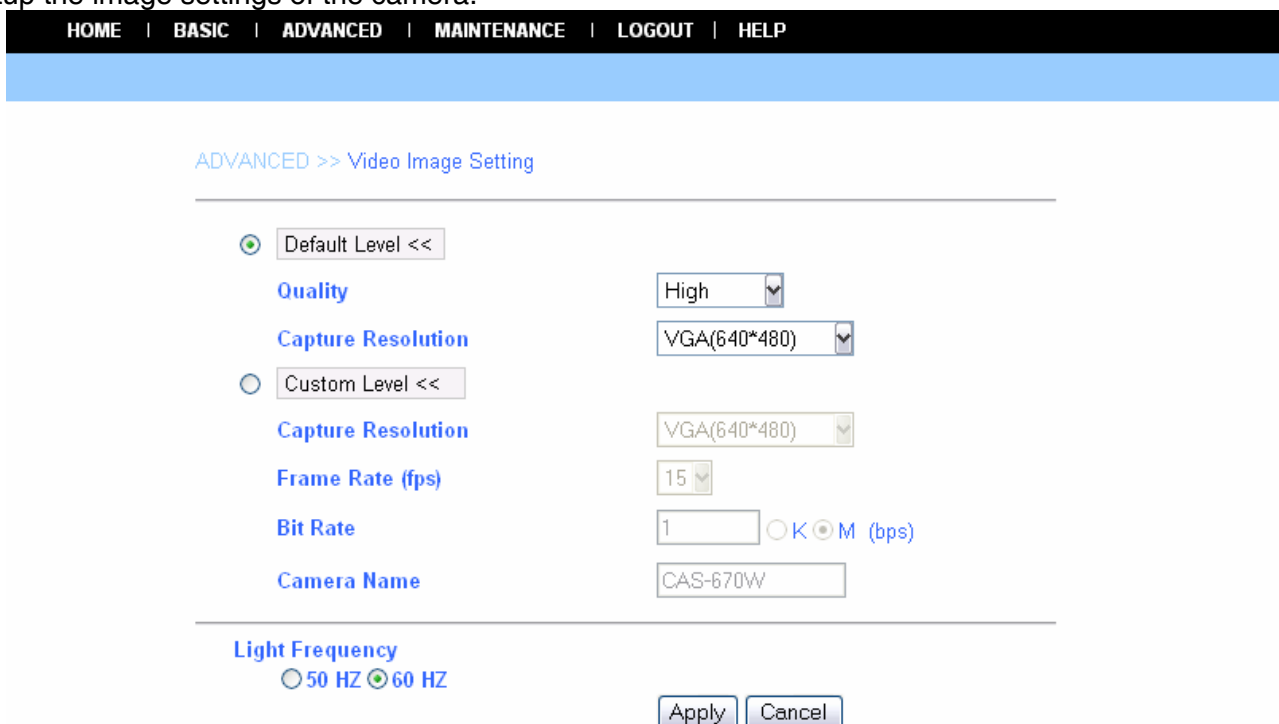

- **Default Level:** Select this option to use the default image settings of the camera.
 - **Quality:** You can setup the image quality from this pull-down list. The default setting is **High**.
 - **Capture Resolution:** You can setup the image resolution when you capture a still image. The default setting is **VGA(640*480)**.
- **Custom Level:** Select this option when you want to customize the image configuration.
 - **Capture Resolution:** You can setup the image resolution when you capture a still image. The default setting is **VGA(640*480)**.
 - **Frame Rate (fps):** Select the optimal setting depending on your network status. The higher setting can obtain better quality; however, it will use more resource within your network.

- **Bit Rate:** You can setup bit rate of the image by selecting **Kbps** or **Mbps**. The setting range is 4Kbps~3Mbps. The higher setting can obtain better quality; however, it will use more resource within your network.
- **Camera Name:** You can change the name of the camera.
- **Light Frequency:** Adjust the light frequency to suit your area of operation from the options either **50 Hz** or **60 Hz** (default).

Location Setting

Click the **Location Setting** item of the **Video** submenu to bring up the following page, which allows you to setup the video control settings of the camera.

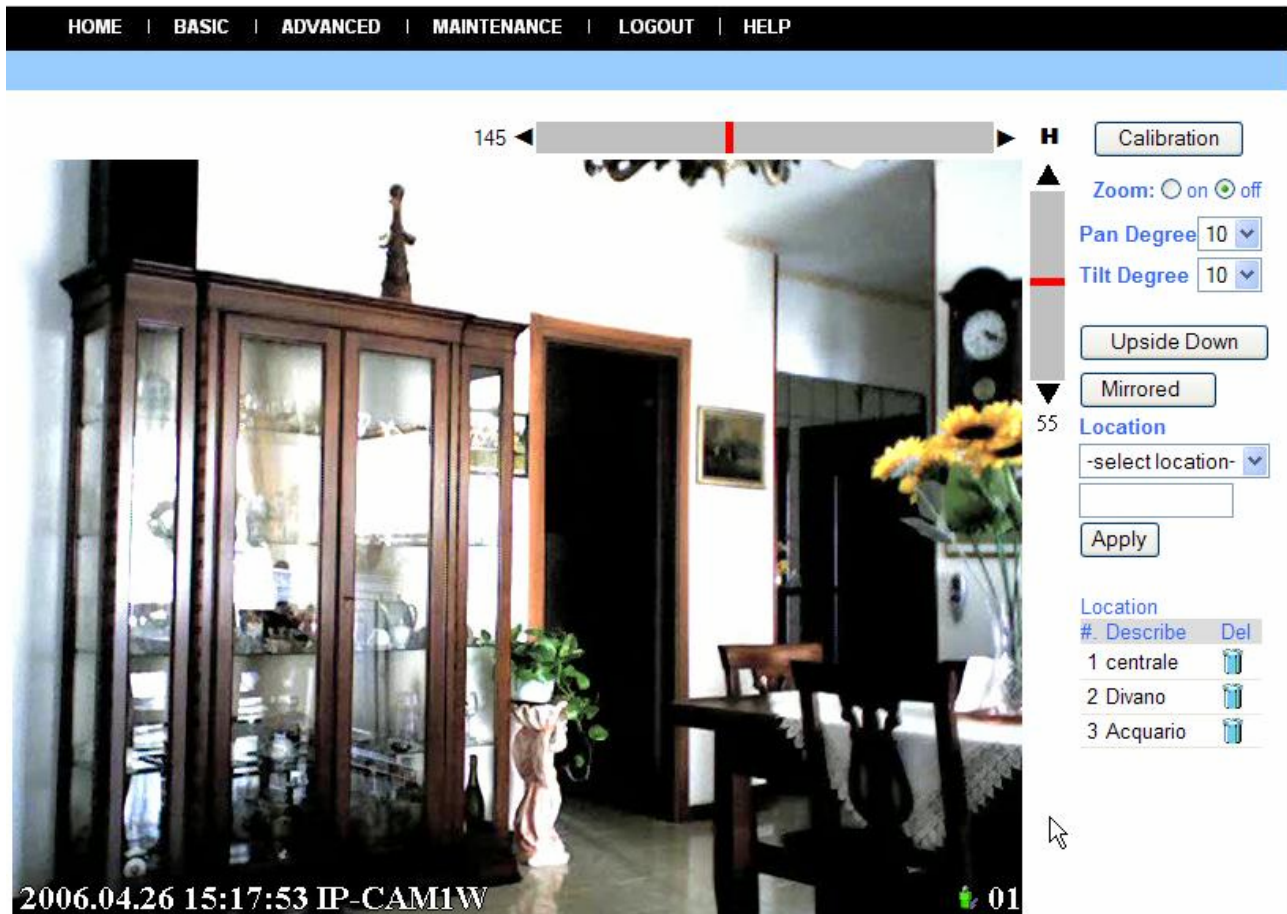

- **Upside Down:** Display the image in a vertical mirror mode.
- **Mirrored:** Display the image in a horizontal mirror mode.
- **Location:** When you have saved the position in the camera, select the location from the pull-down list, and then click **Apply**. The camera's lens will move to the location immediately.

Motion Detection

Click the **Motion Detection** item of the **Video** submenu to bring up the following page, which allows you to setup the motion detection settings of the camera.

ADVANCED >> Video Control Setting

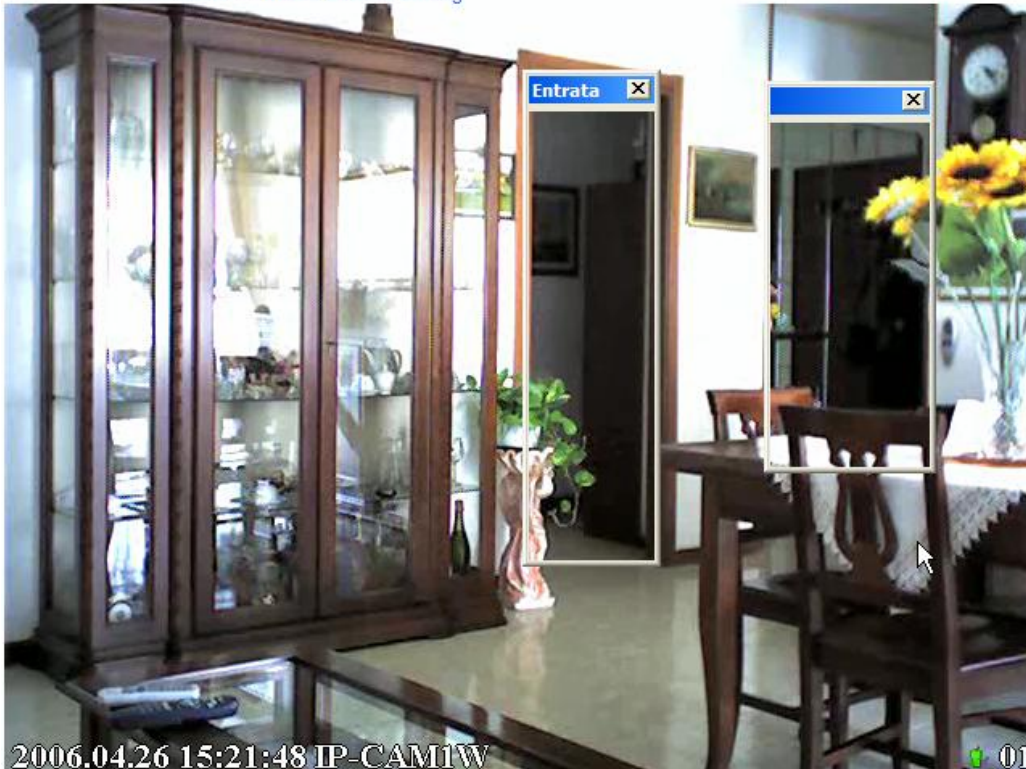

Motion

Sensitivity: 0 %

Percentage: 0 %

Entrata Zone1

Zone2

Zone3

Save

OpenMSD

- **Motion:** Check this option to enable motion detection function of your camera. Once enabled, you can setup the detecting region by giving a name for respective Zone# (#: 1/2/3). Then, build the Zone window(s) using your mouse to setup the detecting area(s). In addition, move the slide bars to adjust the **Sensitivity** level and **Percentage** level for detecting motion to record video or to send e-mail.
- **Open MSD:** Click this button to bring up a dialog window that displays the detected motion event(s) of Zone # (#: 1/2/3).

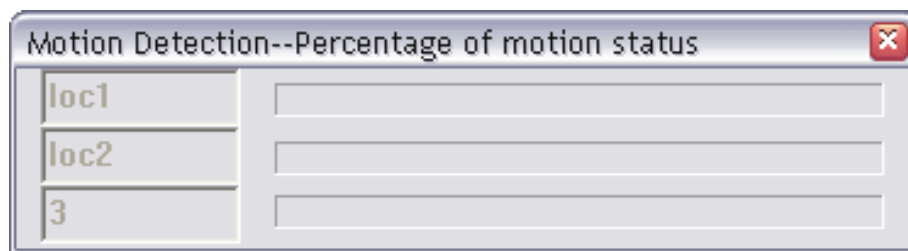

Advanced → Network

The **Network** submenu contains three options: **LAN**, **PPPoE** and **DDNS**. The settings in these three options are the same as in the **Network** under **Basic** configuration. (The settings here are the same as the configuration made in Basic menu.)

LAN

Click the **LAN** item of the **Network** submenu to bring up the following page.

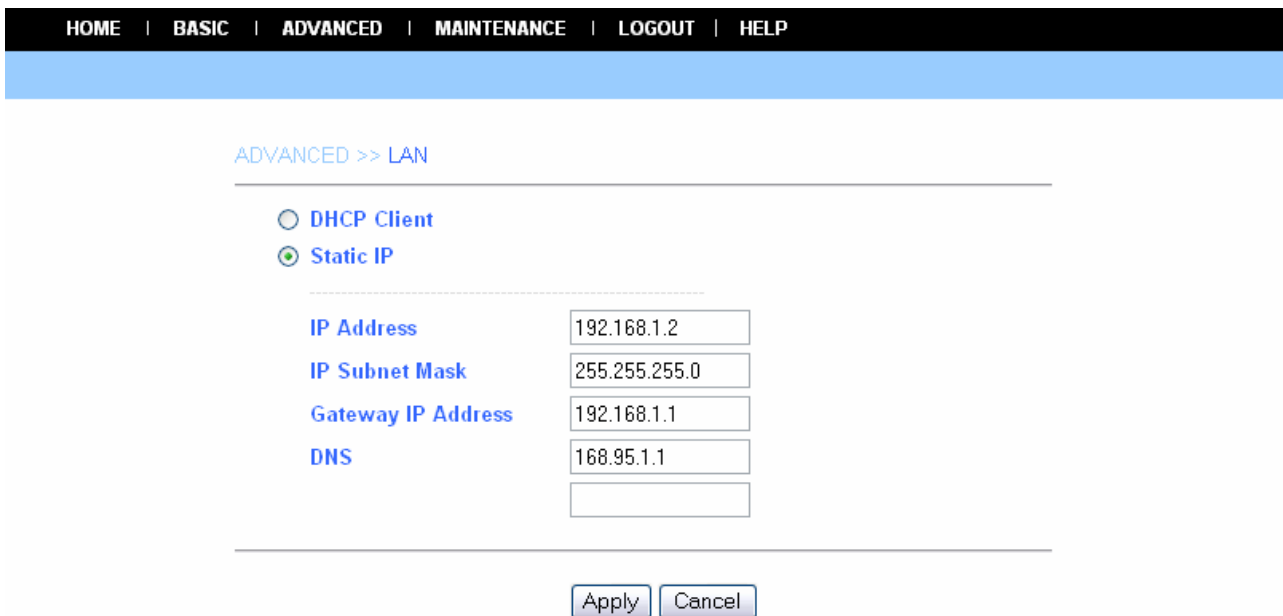

The screenshot shows the web interface for the LAN configuration. At the top, there is a navigation bar with links: HOME | BASIC | ADVANCED | MAINTENANCE | LOGOUT | HELP. Below this, the page title is "ADVANCED >> LAN". There are two radio button options: "DHCP Client" (unselected) and "Static IP" (selected). Below these options are five input fields: "IP Address" (192.168.1.2), "IP Subnet Mask" (255.255.255.0), "Gateway IP Address" (192.168.1.1), "DNS" (168.95.1.1), and an empty field. At the bottom, there are "Apply" and "Cancel" buttons.

If your network access uses a fixed IP address or DHCP service, select this option and fill in the required data provided by your network administrator in the fields of **IP Address**, **IP Subnet Mask**, **Gateway IP Address**, and **DNS** (Domain Name Server).

PPPoE

Click the **PPPoE** item of the **Network** submenu to bring up the following page.

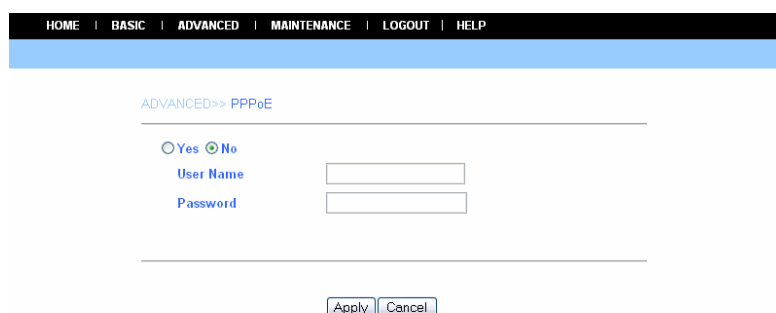

The screenshot shows the web interface for the PPPoE configuration. At the top, there is a navigation bar with links: HOME | BASIC | ADVANCED | MAINTENANCE | LOGOUT | HELP. Below this, the page title is "ADVANCED >> PPPoE". There are two radio button options: "Yes" (unselected) and "No" (selected). Below these options are two input fields: "User Name" and "Password". At the bottom, there are "Apply" and "Cancel" buttons.

If your network access uses PPPoE (Point-to-Point Protocol over Ethernet), select this option by checking the **Yes** item. Fill in the required data in the **User Name** and **Password** fields, which are supplied by your ISP. The IP Address is usually allocated automatically.

DDNS

Click the **DDNS** item of the **Network** submenu to bring up the following page.

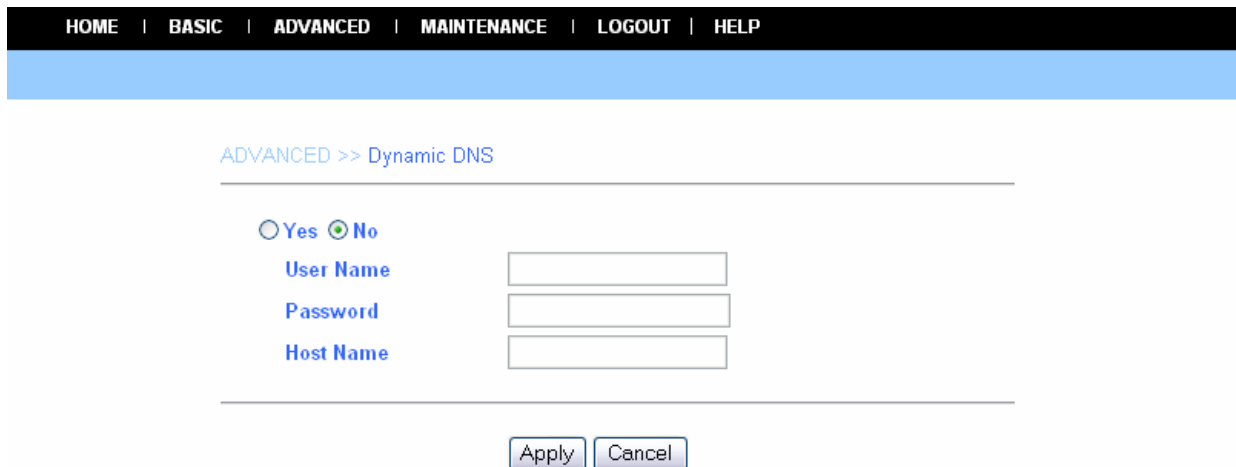

The screenshot shows a web interface with a navigation bar at the top containing links: HOME | BASIC | ADVANCED | MAINTENANCE | LOGOUT | HELP. Below the navigation bar is a blue header bar. The main content area displays the breadcrumb "ADVANCED >> Dynamic DNS". There are two radio buttons: "Yes" (unselected) and "No" (selected). Below the radio buttons are three input fields labeled "User Name", "Password", and "Host Name". At the bottom of the form are two buttons: "Apply" and "Cancel".

The camera supports Dynamic DNS (DDNS) feature, which allows you to assign a fixed host and domain name to a dynamic Internet IP address. Select **Yes** to enable this function, and then fill in the required data in the **User Name**, **Password** and **Domain Name** fields. Please note that you have to sign up for DDNS service with service providers before using this function.

Advanced → Wireless

If you use a wireless camera, you can configure the respective settings in the **Wireless** submenu, which contains two options: **Setting** and **Site Survey**.

Setting

Click the **Setting** item of the **Wireless** submenu to bring up the following page.

[HOME](#) | [BASIC](#) | [ADVANCED](#) | [MAINTENANCE](#) | [LOGOUT](#) | [HELP](#)

ADVANCED >> Wireless Setting

Wireless	<input type="radio"/> Enable <input checked="" type="radio"/> Disable
Connection Mode	<input checked="" type="radio"/> Infrastructure <input type="radio"/> Ad-Hoc
SSID	<input type="text"/>
Channel	Auto <input type="text"/>
Security Mode	None <input type="text"/>
Authentication	<input checked="" type="radio"/> Open <input type="radio"/> Shared
Encryption Mode	None <input type="text"/>
Key Format	HEX <input type="text"/>
Default Key	Key 1 <input type="text"/>
Key1	<input type="text"/>
Key2	<input type="text"/>
Key3	<input type="text"/>
Key4	<input type="text"/>
Pre-Shared Key	<input type="text"/>

- **Wireless:** The default setting is **Disable**. Select **Enable/Disable** to start/stop the wireless function of the camera.
- **Connection Mode:** Use this option to determine the type of wireless communication for the camera. There are two choices: **Infrastructure** mode and **Ad-Hoc** mode.
- **SSID:** SSID (Service Set Identity) is the name assigned to the wireless network. It will auto-detect and display the SSID of wireless network connected in this box. This default setting will let the camera connect to ANY access point under the infrastructure network mode.
- **Channel:** This pull-down menu provides the wireless channel for communication. A “channel” is a range of frequencies to be used in communication between the camera and access point in Infrastructure mode, or the camera and PC/Notebook in Ad-Hoc mode. Select the appropriate channel from the list provided depending on the regulatory region where the unit is sold.
- **Security Mode:** Wireless network communications can be intercepted easily. This option will help you protect your wireless network.
- **Authentication:** **Open** communicates the key across the network. **Shared** allows communication only with other devices with identical WEP settings.
- **Encryption Mode:** This option allows you to configure the setting of data encryption. The WEP key must be set before the data encryption is enforced.
- **Key Format:** To enable WEP Encryption, you should decide the encryption format first by selecting the **ASCII** or **HEX** option, and then input the WEP key (in the following **Key 1~4** box).

- **Pre-Shared Key:** This is used to identify each other in the network. Enter the name in the **Pre-Shared Key** box, and this name must match the Pre-Shared Key value in the remote device.



ASCII input format:

ASCII format causes each character you type to be interpreted as an eight-bit value. All unaccented upper-and lower-case Western European characters that can beinput through your keyboard's typing zone are valid. To setup a 64-bit WEP key, input 5 ASCII characters. For example, '12345'. To setup an 128-bit WEP key, input 13ASCII characters. For example, '1234567890123'. Thesecharacter counts result in bit counts of 40 and 104 respectively; the camera will automatically pad your input to a bit count of 64 or 128.

HEX input format:

Hex format causes each pair of characters you type to be interpreted as an eight-bit value in hexadecimal (base 16) notation. Only the digits 0 through 9 and the letters A through F (in upper or lower case) are valid. To setup a 64-bit WEP key, input 10 HEX format. For example, '3132333435', which is the same with ASCII input '12345'. To setup an 128-bit WEP key, input 26 HEX format. For example, '31323334353637383930313233', which is the same with ASCII input '1234567890123'. These character counts result in bit counts of 40 and 104, respectively; the Wireless Internet Camera will automatically pad your input to a bit count of 64 or 128.

Site Survey

Click the **Site Survey** item of the **Wireless** submenu to bring up the following page.

[HOME](#) | [BASIC](#) | [ADVANCED](#) | [MAINTENANCE](#) | [LOGOUT](#) | [HELP](#)

ADVANCED >> Site Survey

Join	SSID	BSSID	Channel	WEP	Signal

Profile

SSID	Modify	Join
OFF		<input type="button" value="Connect"/>

This field displays the available networks. To connect one wireless network, scroll up and down in the list and highlight the desired network, and click the **Connect** button.

You can click **Refresh** to re-search the available networks.

Advanced → Tools

The **Tools** submenu contains three options: **Recording**, **Port** and **Mail**.

Recording

Click the **Recording** item of the **Tools** submenu to bring up the following page, which allows you to setup the record function of the camera.

HOME | BASIC | ADVANCED | MAINTENANCE | LOGOUT | HELP

ADVANCED>> Remote_Recording

Upload image to Network share folder

Login Method Anonymous ▾

Login User

Password

Path Test

Shared Folder Mode

None

Recording File Number

Shared Folder Size (MB)

Recording Method

Always

Schedule

Day Mon Tue Wed Thu Fri Sat Sun

Time **Start:**

Stop:

Smart Recording

Skip Empty File

Save Time

- **Upload image to Network share folder:** Enable this function by checking the item, and then configure the following settings in this field.

- **Login Method:** If the network share folder allows you to login using **Anonymous**, you will be able to upload the images without enter the User Name and Password. If not, you have to use the correct settings to enter the folder.
- **Login User:** Enter the user name in this field.
- **Password:** Enter the user password in this field.
- **Path:** Enter an existing folder name in this field, and the images will be uploaded to the given folder.

Example: \\192.168.5.2\SHARE (the shared PC's IP is 192.168.5.2; the shared folder named is SHARE).

Then, you can select the upload mode and recording method from the following two fields: **Shared Folder Mode** and **Recording Method**.

- **Shared Folder Mode:** You can set up this option by selecting **None**, **Recording File Number**, or **Shared Folder Size**.
- **Recording Method:**
 - Always:** The recorded images will be always uploaded to the network share folder.
 - Schedule:** You can manage the uploading task by configuring the **Day** and **Time** options

Smart Recording: Allows you to upload the recorded image only, and skip the empty files. To select this mode, you have to enable and configure the Motion Detection option first.

Port

Click the **Port** item of the **Tools** submenu to bring up the following page, which allows you to setup the ports used to transmit the camera's data.

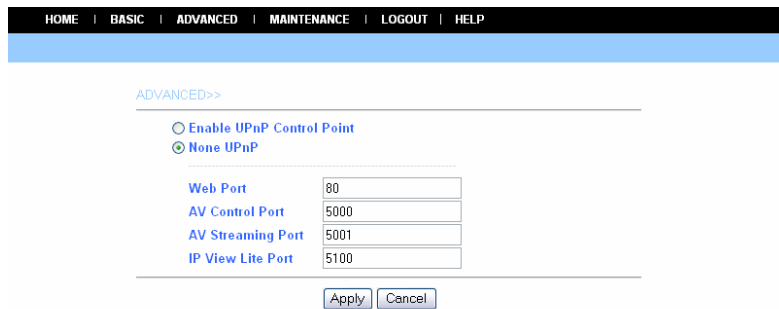

The screenshot shows the 'ADVANCED' configuration page. At the top, there is a navigation bar with links: HOME | BASIC | ADVANCED | MAINTENANCE | LOGOUT | HELP. Below this, the 'ADVANCED' section is expanded. There are two radio button options: 'Enable UPnP Control Point' (unselected) and 'None UPnP' (selected). Below these are four input fields for port numbers: 'Web Port' (80), 'AV Control Port' (5000), 'AV Streaming Port' (5001), and 'IP View Lite Port' (5100). At the bottom of the form are 'Apply' and 'Cancel' buttons.

- **Enable UPnP Control Point:** Setup the Web port to transmit the camera's image data. The default setting is port **80**.
- **Non UPnP:** When you select this option, you can set up the following items manually.
 - **Web Port:** Setup the Web port to transmit the camera's image data. The default setting is port **80**.
 - **AV Control Port:** Setup the transmission of streaming data within the network. The default setting is port **5000**.
 - **AV Streaming Port:** The default setting is port **5001**.
 - **IP View Lite Port:** The default setting is port **5100**.

Mail

Click the **Mail** item of the **Tools** submenu to bring up the following page, which allows you to setup e-mail function of the camera.

ADVANCED>>

By E-mail
 IP Change
 Motion Detection
 None

SMTP Login Name
 SMTP Password

 SMTP (mail) Server
 Return Email Address
 Recipient Email Address
 SMTP Port

Motion Detection Set Skip Time (second)

When you select **By E-mail**, the system will enable the alert function that notifies you the events of **IP Change** or **Motion Detection** by sending an e-mail. If you select **None**, the system will do nothing.

- **By E-mail:** Configure the following settings. This field contains the six basic settings for your e-mail server.
 - **SMTP Login Name:** Enter the user name in this field to login receiver's e-mail server.
 - **SMTP Password:** Enter the user password in this field to login receiver's e-mail server.
 - **SMTP (mail) Server:** SMTP (Simple Mail Transfer Protocol) is a protocol for sending e-mail messages between servers you need to input the mail server address in this field.
 - **Return Email Address:** Enter the e-mail address of the user who will send the e-mail.
 - **Recipient Email Address:** Enter the e-mail address of the user who will receive the e-mail.
 - **SMPT Port:** Enter the e-mail port used in your computer. The default setting is port **25**.
- **Motion Detection Set Skip Time:** You can setup the duration of motion detecting.



You can click the Test button to test the e-mail account you provided. To test, you have to enable and configure the Motion Detection option first.

Advanced → Account



The **Account** submenu contains the options that allow you to add/delete users. Also, you can manage the users of the camera.

[HOME](#) | [BASIC](#) | [ADVANCED](#) | [MAINTENANCE](#) | [LOGOUT](#) | [HELP](#)

ADVANCED >> Account

User Name	<input type="text"/>
Password	<input type="text"/>
Retype Password	<input type="text"/>

User List

No.	User Name	Modify	Delete
1	admin		
2	guest		

- **User Name:** Enter the user name in this field.
- **Password:** Enter the user password in this field.
- **Retype Password:** Enter the user password again to confirm the password.

When completed, click **Apply** to activate the user's account.

The following User List displays the existing users of the camera. You can modify and delete a user by click the respective icon.

Advanced → Timezone

The **Timezone** submenu displays the current time setting of the camera. For system management purpose, a correct time setting is critical to have accurate time stamps on the system logs.

[HOME](#) | [BASIC](#) | [ADVANCED](#) | [MAINTENANCE](#) | [LOGOUT](#) | [HELP](#)

ADVANCED >> Time Zone

Time 15 : 25 : 07 **Date** 2005 / 04 / 19

Method

Time Zone

- **Method:** Allow you to setup the correct time by getting time from the computer or time server (need an Internet connection).
- **Time Zone:** Select a time zone according to your location.

8.2.5 Maintenance

The **Maintenance** menu contains two submenus: **Configuration** and **Firmware Upload**. Move your mouse onto the **Maintenance** button, and it will automatically pop up a submenu bar as below.

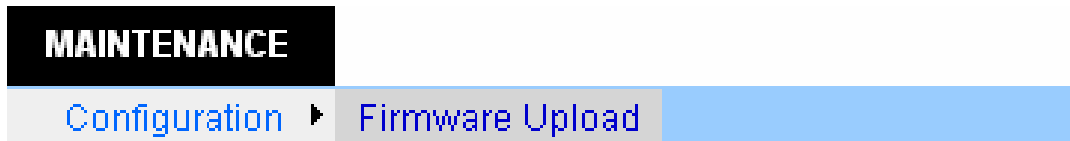

Maintenance → Configuration

The **Configuration** submenu contains four options: **Idle Time**, **Reset Default**, **Reboot** and **Status**.

Idle Time

Click the **Idle Time** item of the **Configuration** submenu to bring up the following page, which allows you to setup the idle time of the camera.

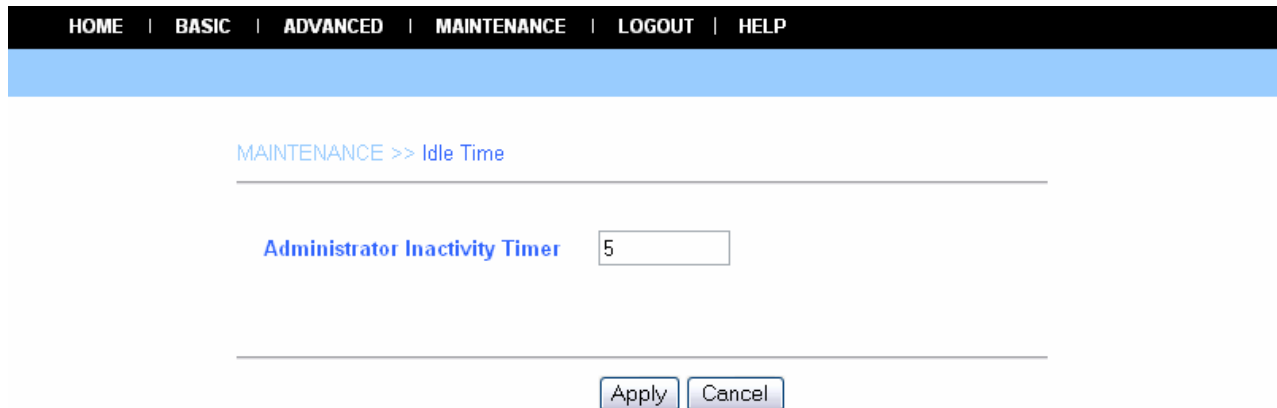
A screenshot of a web interface for configuring the 'Idle Time'. At the top, a black navigation bar contains the following links: HOME | BASIC | ADVANCED | MAINTENANCE | LOGOUT | HELP. Below this is a light blue header bar. The main content area has a breadcrumb trail: MAINTENANCE >> Idle Time. Below the breadcrumb is a horizontal line. Underneath, the text 'Administrator Inactivity Timer' is followed by a text input field containing the number '5'. Another horizontal line is below the input field. At the bottom, there are two buttons: 'Apply' and 'Cancel'.

- **Administrator Inactivity Timer:** location. If the user does nothing within the specified time in this option, the system would automatically logout. The idle time must be larger than **0**.

Reset Default

Click the **Reset Default** item of the **Configuration** submenu to bring up the following page, which allows you to load the default settings of the camera.

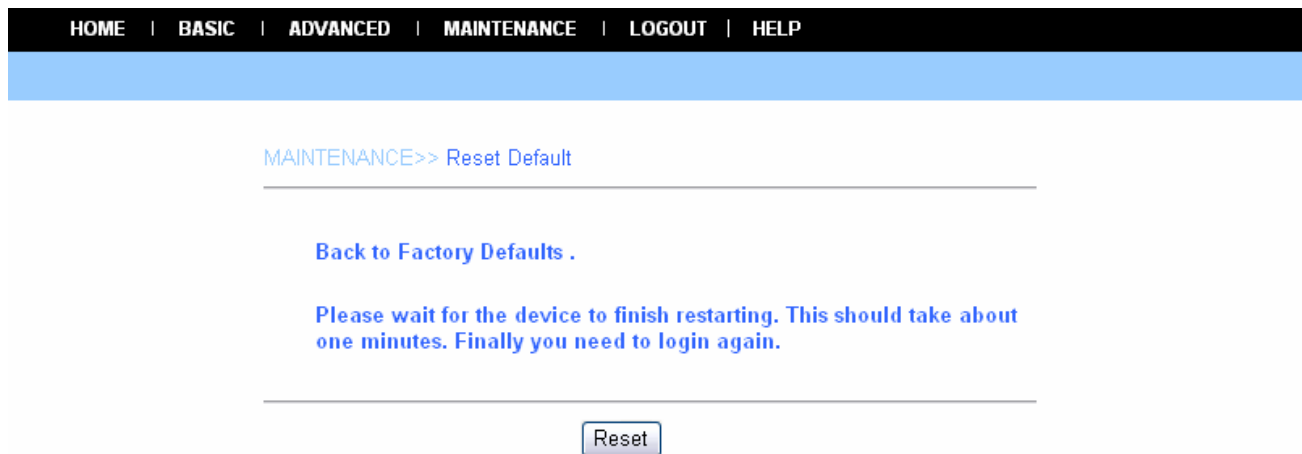

Clicking **Reset** allows you to resume the factory default settings of the camera. This function is the same as pressing the **Reset** button on the camera.

Reboot

Click the **Reboot** item of the **Configuration** submenu to bring up the following page, which allows you to restart the camera.

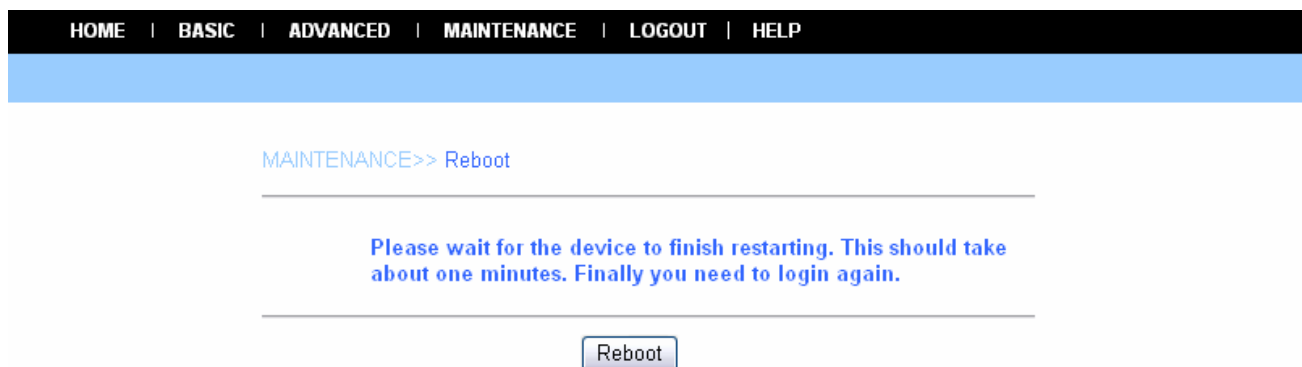

Click **Reboot** to restart the camera.

After reboot, both the Power LED and Link LED on the front panel will light on, and then you can enter your Name and Password to login.

Status

Click the **Status** item of the **Configuration** submenu to bring up the following page, which displays the current configuration of the camera.

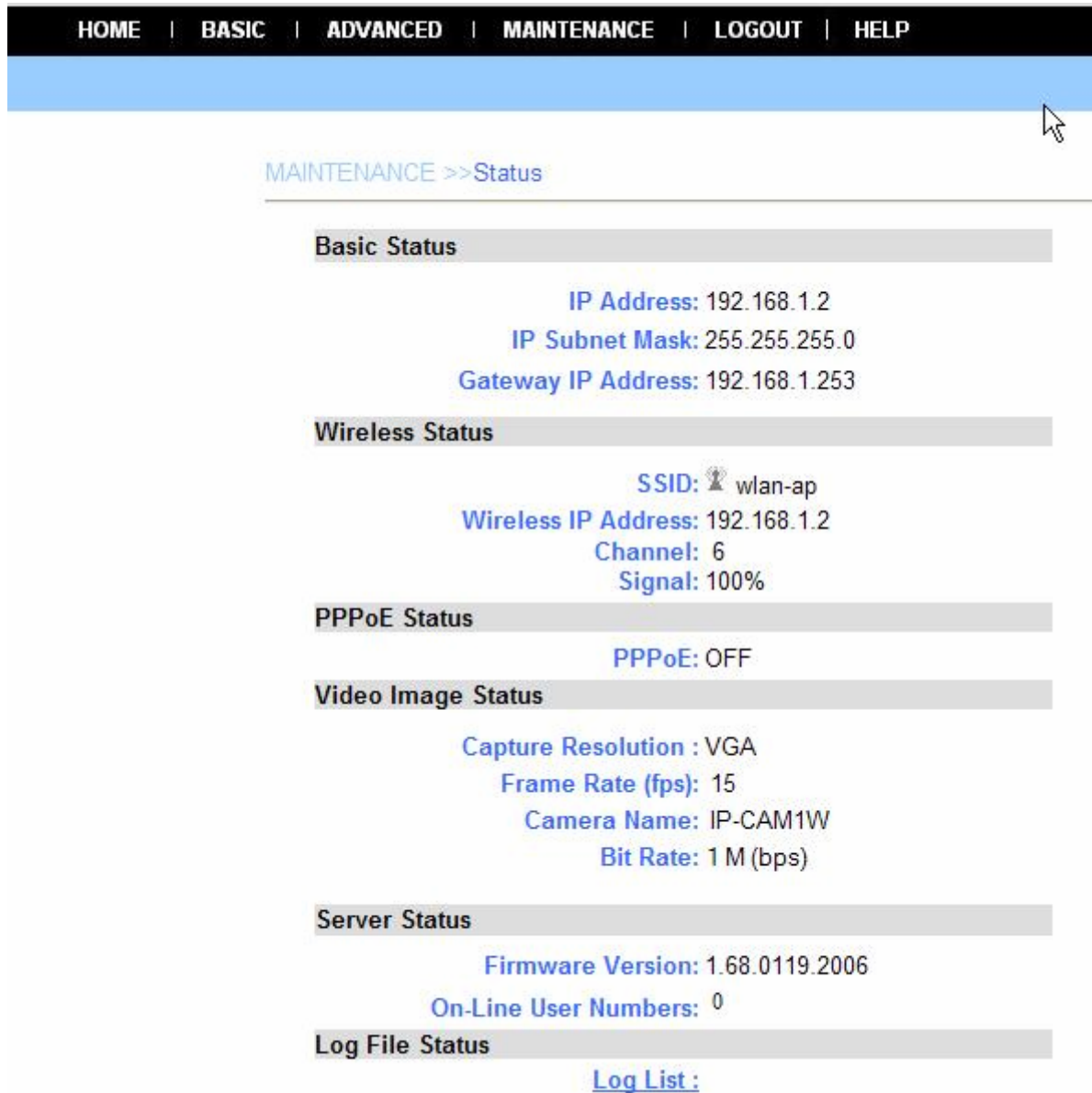

The screenshot shows a web interface with a black navigation bar at the top containing links: HOME | BASIC | ADVANCED | MAINTENANCE | LOGOUT | HELP. Below this is a light blue horizontal bar. The main content area has a breadcrumb trail: MAINTENANCE >> Status. The status is organized into several sections, each with a grey header bar:

- Basic Status**
 - IP Address: 192.168.1.2
 - IP Subnet Mask: 255.255.255.0
 - Gateway IP Address: 192.168.1.253
- Wireless Status**
 - SSID: wlan-ap
 - Wireless IP Address: 192.168.1.2
 - Channel: 6
 - Signal: 100%
- PPPoE Status**
 - PPPoE: OFF
- Video Image Status**
 - Capture Resolution : VGA
 - Frame Rate (fps): 15
 - Camera Name: IP-CAM1W
 - Bit Rate: 1 M (bps)
- Server Status**
 - Firmware Version: 1.68.0119.2006
 - On-Line User Numbers: 0
- Log File Status**
 - [Log List :](#)

The **Status** option contains information of the camera, including its basic status and the networking status.

Maintenance → Firmware Upload

The **Firmware Upload** submenu allows you to update the firmware of the camera once you obtained a latest version of firmware.

MAINTENANCE >> Firmware Upload

To upgrade the camera firmware, browse to the location of file "firmware" and click Upload. Upgraded file can be downloaded from website.

* This should take about few minutes.

File Path

Click **Browse** to point to the firmware file saved in your computer, and then click **Upload**. The system start to upgrade the firmware, and it will ask you to restart the camera. Click **Restart** when prompted.

MAINTENANCE >> Firmware Upload

To access the device after a successful firmware upload, Please wait for the device to finish restarting. This should take about one minutes. Finally you need to login again. Check you new firmware version in the system status page



It will take a few minutes to update firmware. Please wait to complete the procedure; you can then reboot the camera.

8.2.6 Logout

Click the **LOGOUT** button to exit the Web Configuration Utility, and it will return to the login screen of the utility.

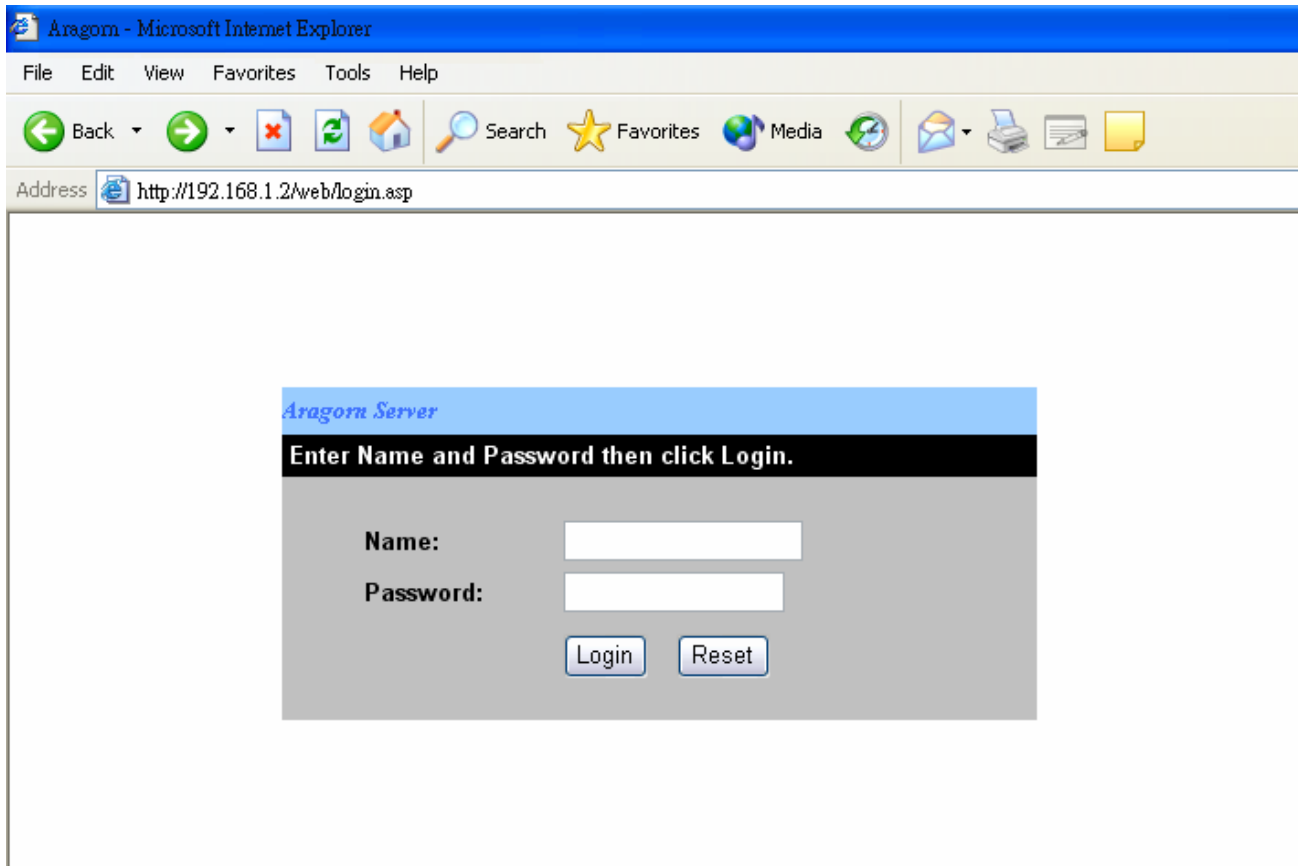

8.2.7 Help

Click the **HELP** button to bring up a window, providing you with the general help information to control the camera.

Chapter 9

IP Wireless Security Motorized Camera Application

The IP Wireless Security Motorized Camera can be applied in wide variety of applications. With the built-in CPU, it can work as a standalone system that provides a web-based solution transmitting high quality video images and sounds for monitoring purposes. It can be managed remotely, accessed and controlled from any PC desktop over the Intranet or Internet via a web browser. With the easy installation procedure, real-time live images will be available. In addition, once the IP Wireless Security Motorized Camera is installed coupled with the IPView SE application, you can further expand the scope of the IP Wireless Security Motorized Camera.

The following section will provide the typical applications for the IP Wireless Security Motorized Camera along with the IPView Pro application, and also includes some basic knowledge to assist in the installation and configuration of the IP Wireless Security Motorized Camera.

9.1 Applications

- Monitoring of local and remote places and objects such as construction sites, hospitals, amusement parks, schools and day-care centers through the use of a web browser.
- Capture single frame images from the IPView Pro application.
- Configure the camera to upload image or send-mail messages with a single frame image.

9.2 IP Wireless Security Motorized Camera Application Diagrams

9.2.1 Home Applications:

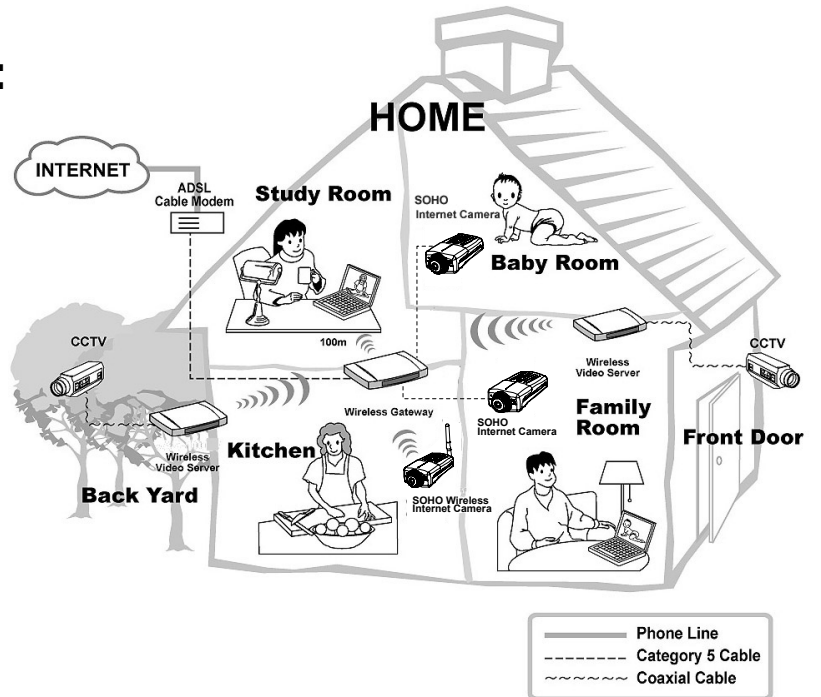

9.2.2 SOHO Applications:

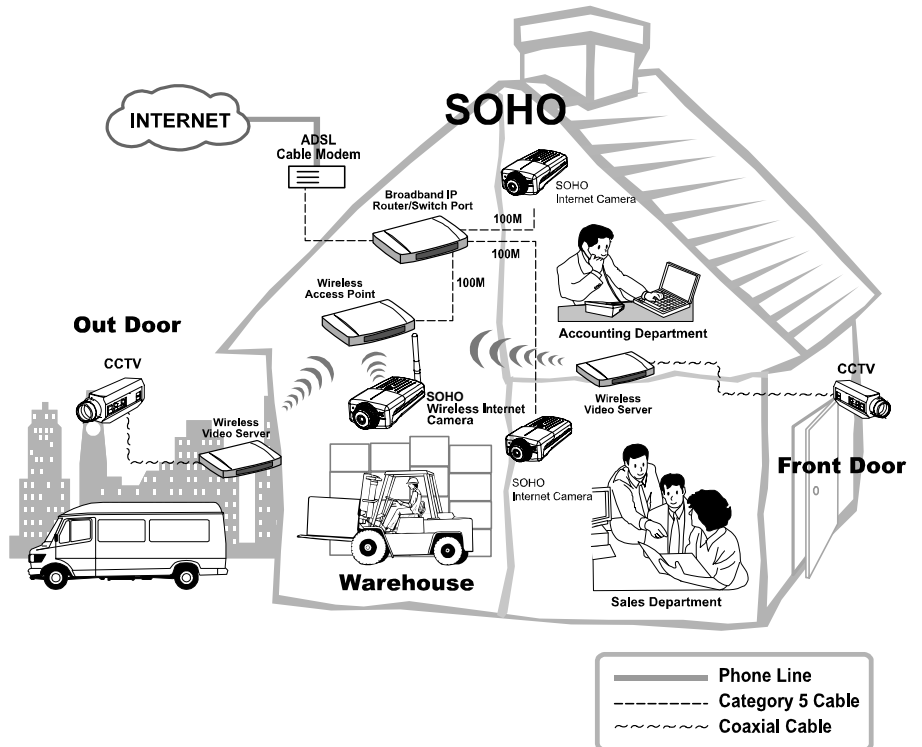

Chapter 10

IPView Pro Application

10.1 Installation

Insert the CD-ROM into the CD-ROM drive to initiate the auto-run program. Once completed, a menu screen will appear as below:



To install the IPView Pro application click the "IPView Pro" button to activate the installation procedure for the application program.

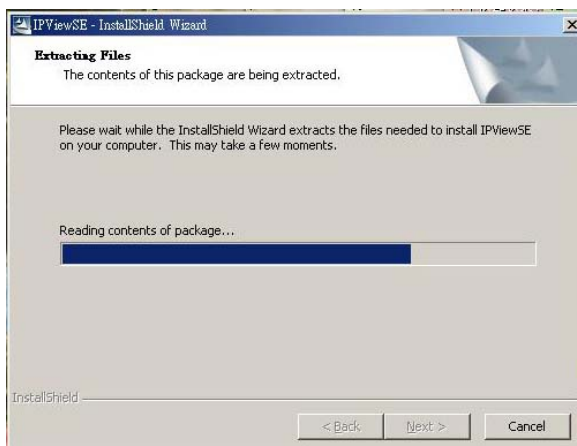

Once executed, you will be asked to select the desired language. Select the language you want and click **“OK”** to continue.



The Welcome screen will appear as below. Click the **“Next”** button.

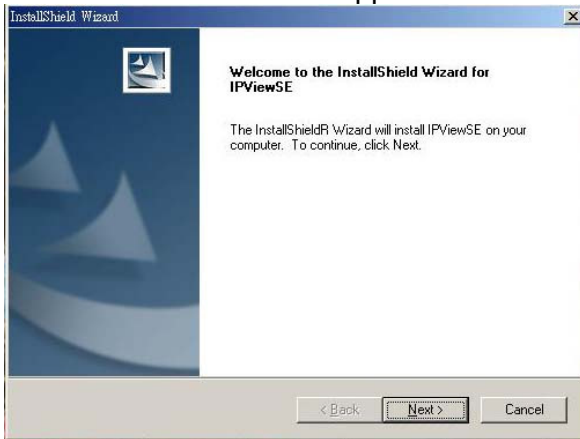

The License Agreement window will appear as below. Read the details carefully and click the **“Yes”** button.

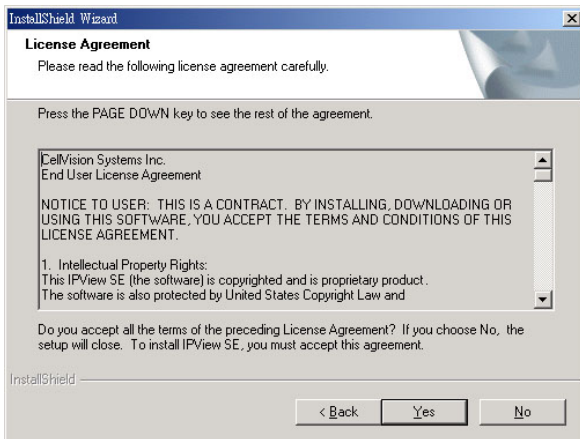

In the following window, you may click **“Next”** to accept the recommended destination location or click **“Browse”** to select another location. After specifying the desired destination location, click **“Next”**.

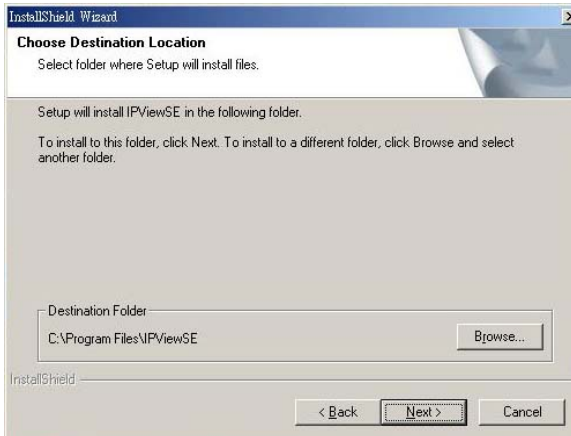

The following window allows you to select the folder where the IPView Pro application will be located, click **“Next”** to continue.



Please wait until one of the following two dialog boxes to appear. When the Digital Signature warning screen appears, click **Continue Anyway**.

If the system has to restart, select **“Yes, I want to restart my computer now”** and click the **“Finish”** button to complete the installation procedure.



Otherwise, you may simply click the **“Finish”** button to complete the installation procedure

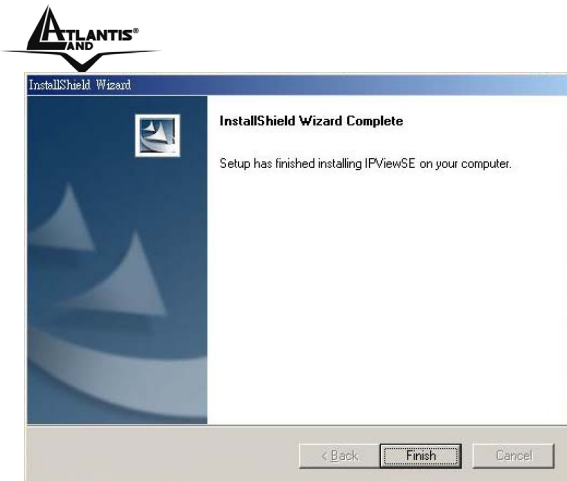

After successfully installing the IPView Pro, the application program for the IP Wireless Security Motorized Camera is automatically installed to \Programs\Files directory.
To start running the IPView Pro, click **Start -> Programs -> IPView Pro -> IPView Pro.**

Chapter 11

Getting Started

This section describes the operation of the IPView Pro application with detailed procedures for using the application.

11.1 IPView Pro

IPView Pro is responsible for the management of preview, configuration, and searching of each camera. It is designed with a user-friendly interface for ease of control and navigation requirements as illustrated below.

This section describes the User Interface of IPView Pro, with detailed procedures for using the application.



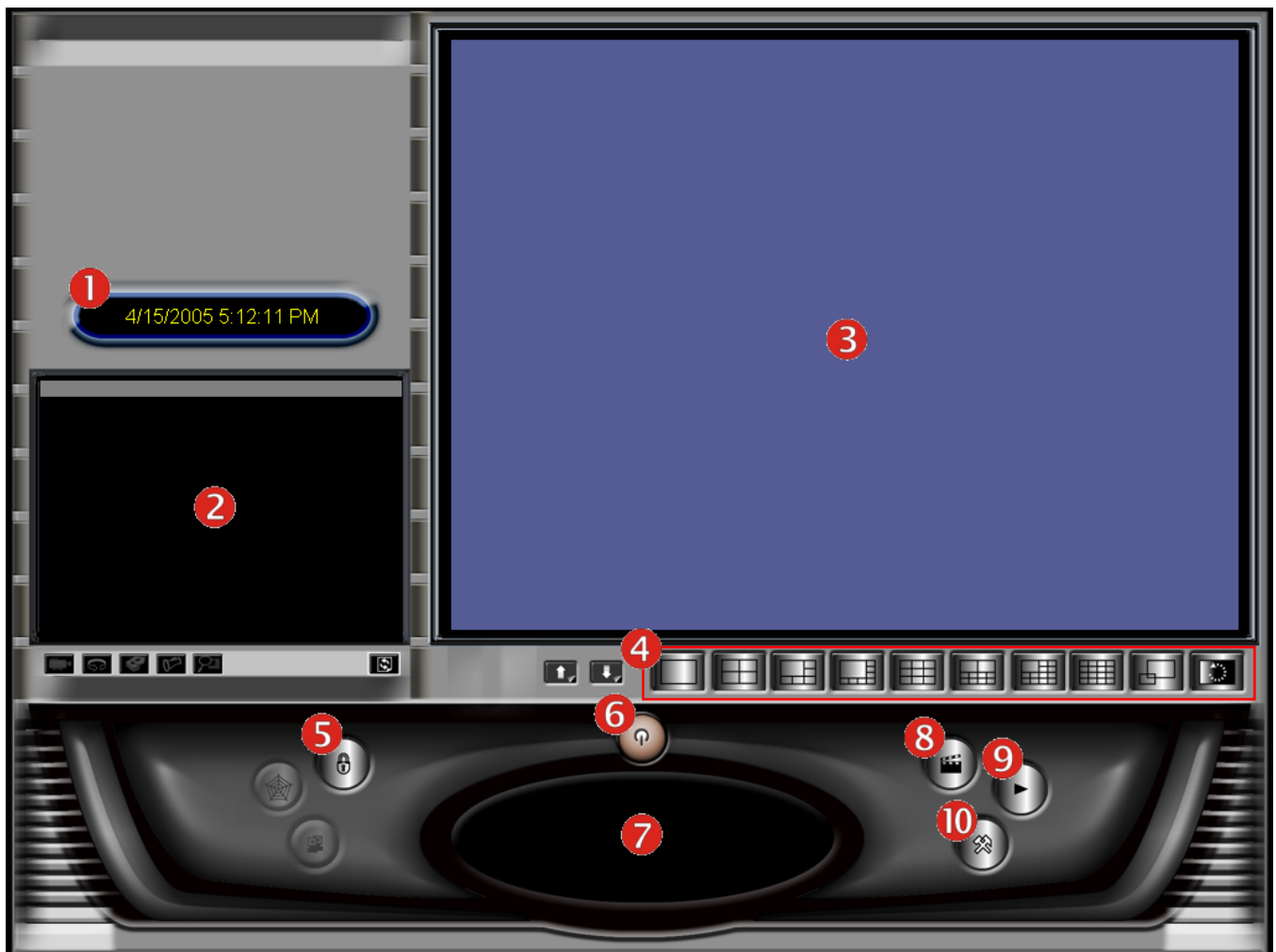







To launch IPView Pro, click **Start > Programs > IPView Pro > IPView Pro**. The main screen will appear as below:















IPView Pro requires the system's resolution setting up to 1024x768. Please configure the resolution to 1024x768 or higher; otherwise, it may shows incomplete screen when launching the program.

Item Feature

NO.	Item	Description
1	Date/Time	Show current date/time.
2	Status Mode Window	Show the camera's status in this window. Click the Change Status Mode button () on the right lower corner of the window to change the display mode: <p style="text-align: center;">Camera list mode Camera information mode</p>
3	View Window	Show the camera's view in this window.
4	View Mode Buttons	Select the view mode from these buttons.  Show one camera in View Window.  Show four cameras in View Window.  Show six cameras in View Window with the first one as the major view.  Show eight cameras in View Window with the first one as the major view.  Show nine cameras in View Window.  Show ten cameras in View Window with the first two as the major views.  Show thirteen cameras in View Window with the first one as the major view.  Show sixteen cameras in View Window. <hr/>  Show the selected camera in full screen view.  Enable displaying the video views in circles.
5	Key Lock Button	Click to lock/unlock the camera. When locked, the user cannot operate any camera.
6	Power Button	Click to exit or minimize IPView Pro.

<p>7</p>	<p>Pan/Tilt Control Panel</p>	<p>When the camera is added, the Pan/Tilt control buttons will appear on the panel, as shown below:</p>  <p>  /  /  /  /  /  /  /  : Click these buttons to adjust the camera's viewing angle to Up/ Down/Left/Right/Left-Up/Left-Down/Right-Up/Right-Down.  : Once you have saved two (or more) positions in the camera, click the Swing button to control the camera swinging from one position to another position.  : Click the Home button to return the camera to the default position. </p>
<p>8</p>	<p>Record Button</p>	<p>Record video clip of the selected camera and save it in the computer. The storage position can be configured in System Configuration. When you click the button, you can select Manual Record, Schedule Record, or Motion Record.</p>
<p>9</p>	<p>Play Button</p>	<p>Play the recorded video file in the computer.</p>
<p>10</p>	<p>Configuration Button</p>	<p>Click to enter the System Configuration.</p>

11.1.1 Using IPView Pro

Adding a Camera

To add a camera:

1. Click the **Configuration** button  to enter the System Configuration.

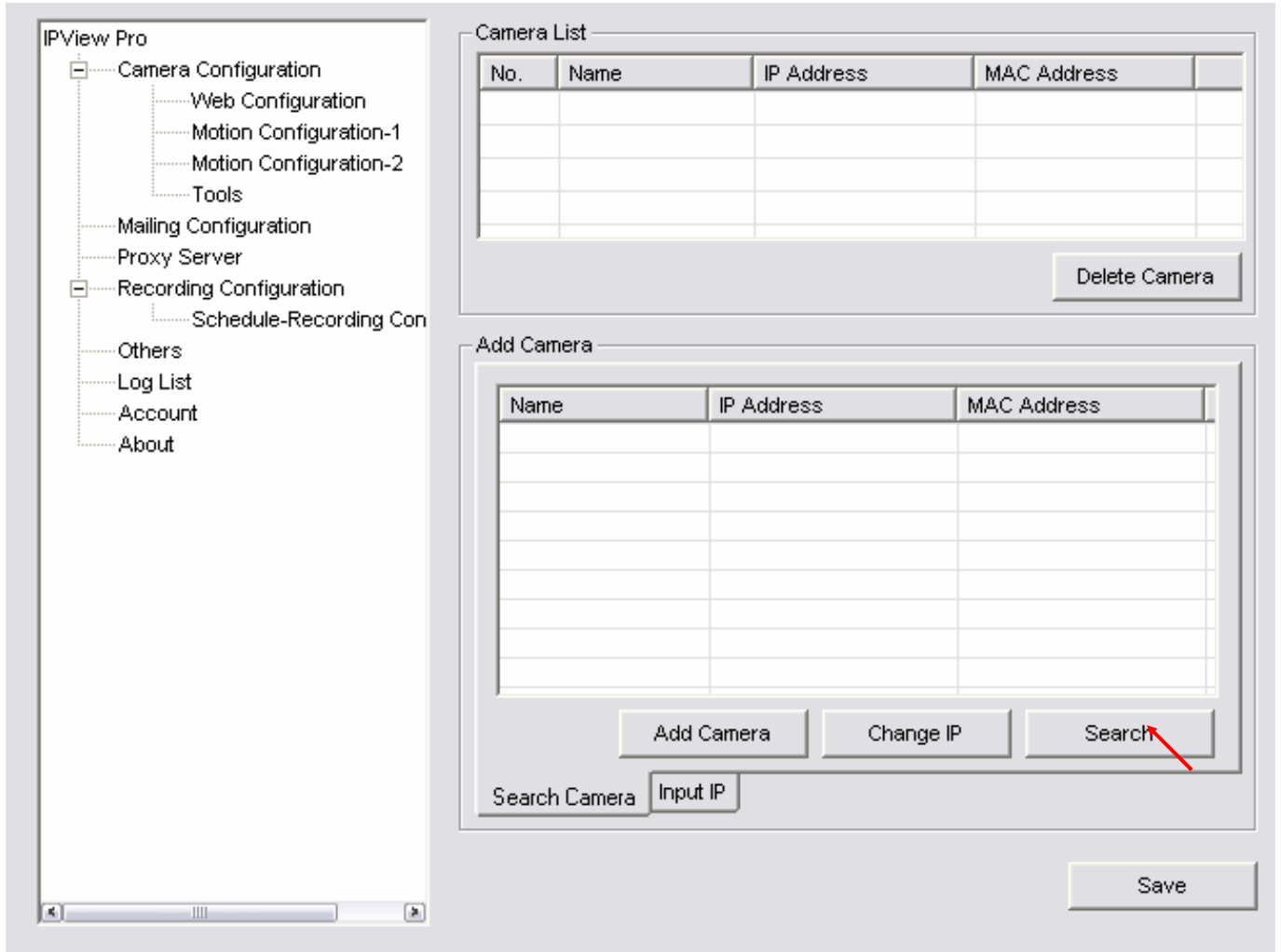

If you are not sure of the camera's IP address, you can click **Search** to search the available camera(s) within the network.

2. Select the camera you want by highlighting it, and then click **Add Camera**. Enter the User Name and Password when prompted.
3. Click **Save**, and then click the **Configuration** button to return to View Window. The selected camera's video will be displayed now.

Alternately, you can add a camera by entering its IP address:

4. Select the **Input IP** tab.
5. Enter the camera's IP address (default: 192.168.1.2) and Port (default: 80), and then click **Add Camera**.
6. Click **Save**, and then click the **Configure** button to return to View Window. The selected camera's video will be displayed now.

Removing a Camera

To remove the camera from the list:

1. Select the camera you want to remove.
2. Click **Delete Camera**.

Viewing a Camera

From the View Modes of the panel, you can select one-camera mode or other modes to display your video. IPView Pro allows a maximum of 16 cameras for viewing.

For example, if you use only one camera, select one-camera mode (), and the View Window will display the view as *figure 1*.

If there are four cameras, select four-camera mode (), and the View Window will display the view as *figure 2*.

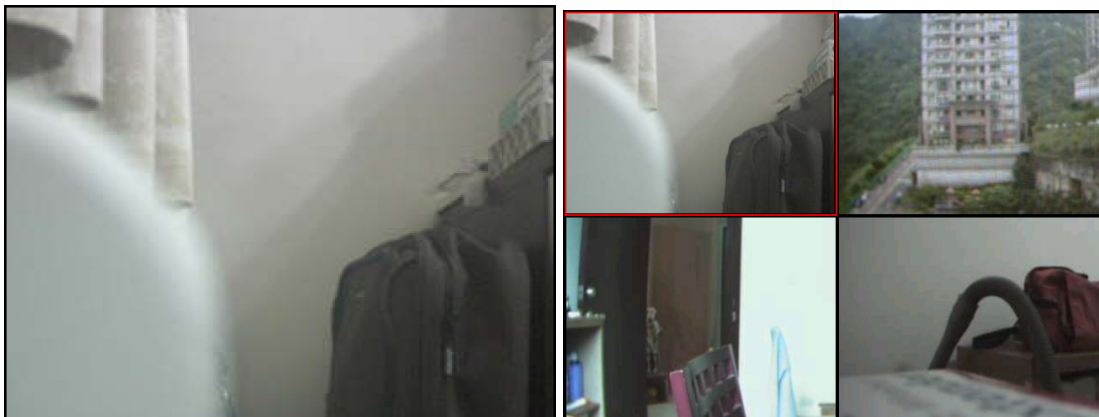

Figure 1.

Figure 2.

Recording Video

IPView Pro allows you to record the video clip and save it in your computer through the following methods: **Manual Record**, **Schedule Record**, and **Motion Record**.

When you click the **Record** button and select **Manual Record**, it will start recording. Click the button again to stop. If you select **Schedule Record** or **Motion Record**, the system will record the video clip according to the settings in System Configuration.

Playing Recorded Video

The recorded video clips are saved in your computer, and can be played using Windows Media Player. To start playback, simply click the **Play** button on the panel, and the following dialog screen will appear, allowing you to select the file to playback.

Select the recorded file in the computer, and then click **OK**.

11.1.2 Configuring the System

Clicking the **Configuration** button on the panel allows you to configure the system settings, and the **System Configuration Screen** will appear in the View Window as shown below. Once configured, click **Save** to save the settings, and then click the **Configuration** button again to exit configuration.

Camera Configuration

In this field, you can add/delete the camera (as described in the previous section). Also, you can configure the following settings:

Web Configuration

In the left column, selecting the **Web Configuration** item will launch the Web Configuration Utility in View Window.

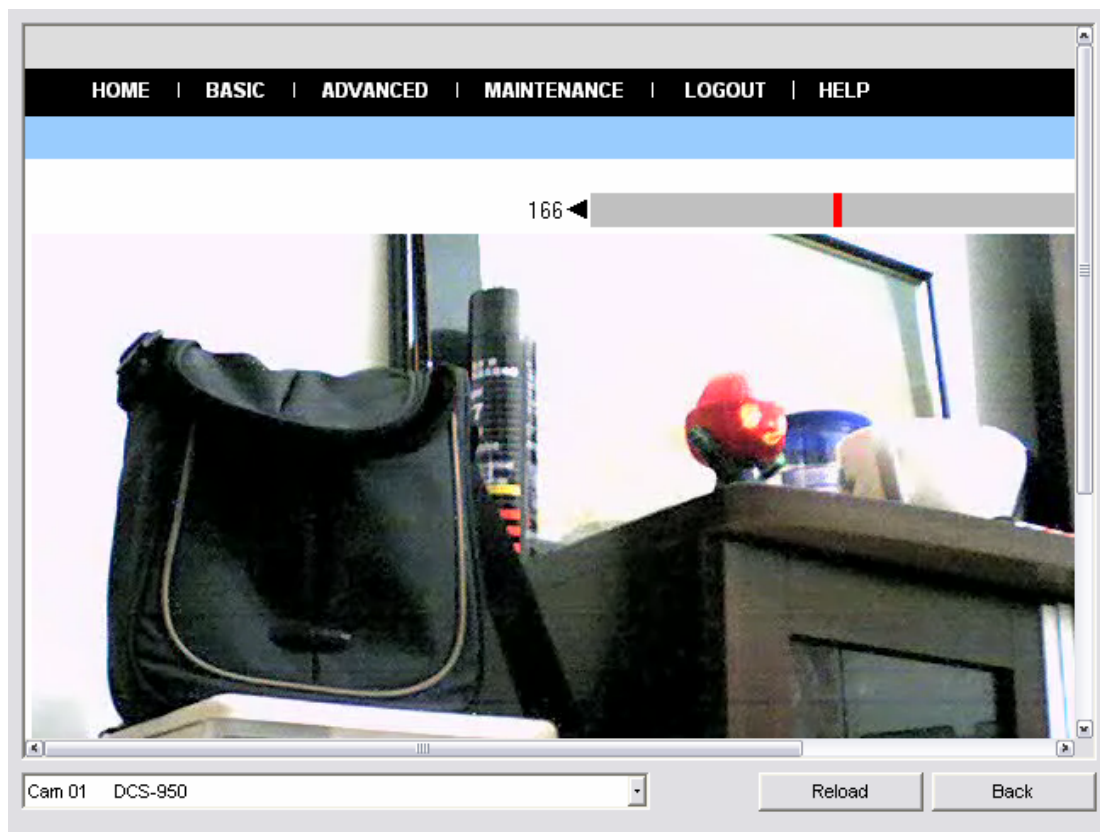

You can configure these settings according to the description in **Chapter 5, Using the Camera**. Click **Back** to exit the Web Configuration Utility.

Motion Configuration-1

The **Motion Configuration-1** item provides the commands for motion detection control. Before configuring, you should select one camera from the pull-down menu.

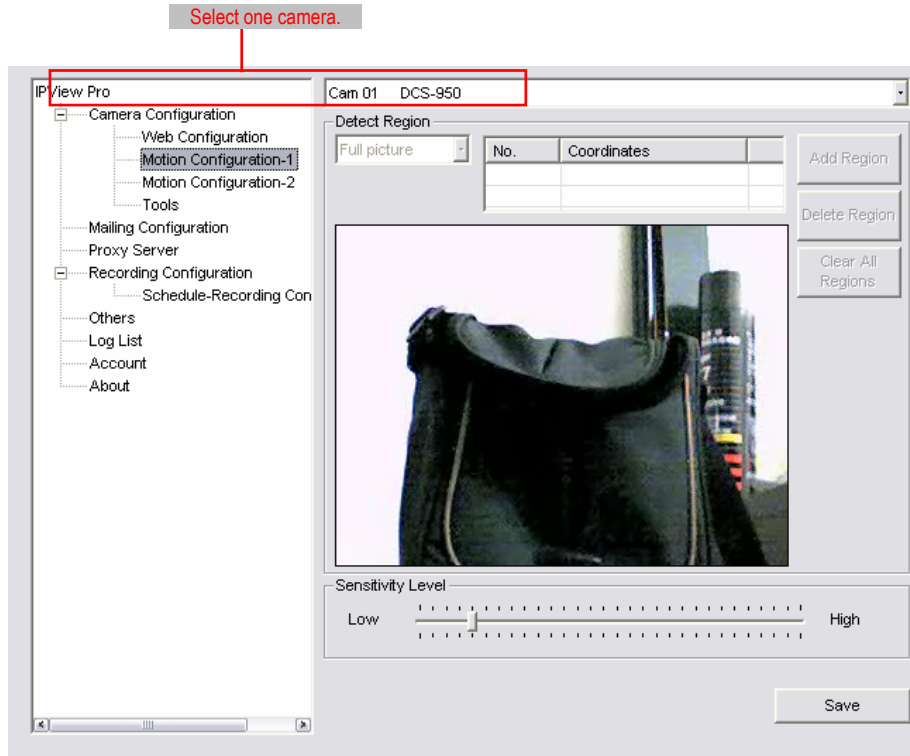

- **Detect Region:** When you select the **Full picture** option, the camera will monitor the whole area.
- **Sensitivity Level:** Move the slide bar to adjust the sensitivity level for detecting motion to record video.

Motion Configuration-2

The **Motion Configuration-2** item allows you to configure to the alarm and e-mail setting.

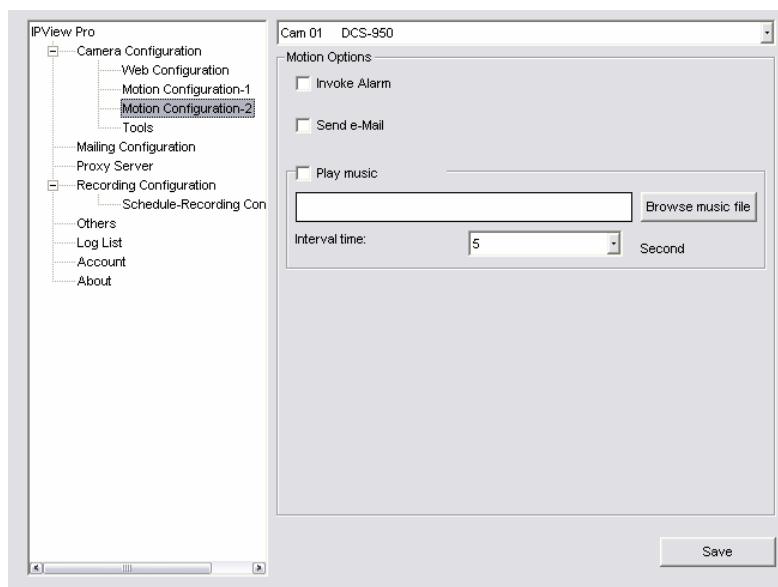

- **Invoke Alarm:** Select this option to enable alarm when some motion detected by the system.

- **Send e-mail:** When this option is checked, click the **Mailing Configuration** in the left column to enter the required information (see the following section).
- **Play music:** Selecting this option allows the system to play music. You can select a music file by clicking the **Browse music file** button, and set up the interval time in the following pull-down menu (1 to 20 seconds).

Tools

The **Tools** item allows you to configure to the alarm and e-mail setting.

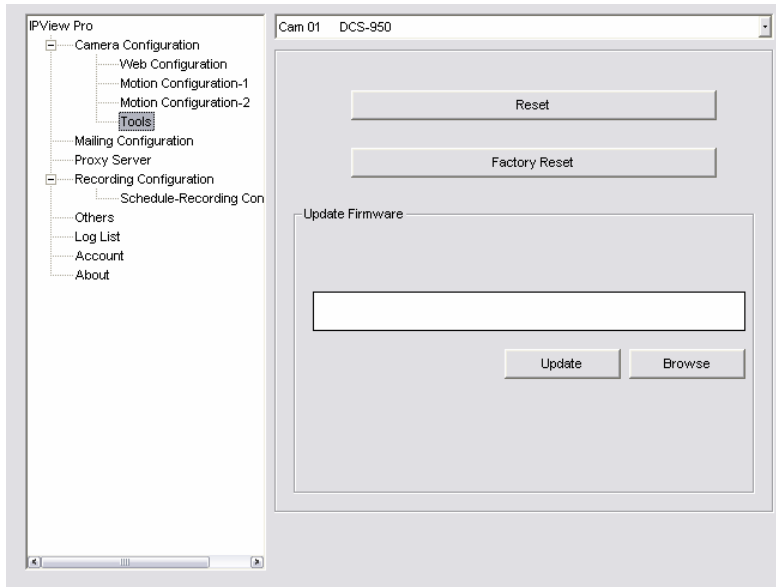

- **Reset:** Restore the original setting of your camera. Do you really want to reset this device? Click **Yes** in the pop-up dialog box to confirm.
- **Factory Reset:** Restore the factory default settings of the camera. Do you really want to factory reset this device? Click **Yes** in the pop-up dialog box to confirm.
- **Update Firmware:** When new firmware is available, you can upgrade it using this option. Click **Browse** to find the firmware file, and then click **Update**.

Mailing Configuration

When Motion Detection function is enabled and the **Send e-mail** option is checked, you should enter the required information in the respective fields.

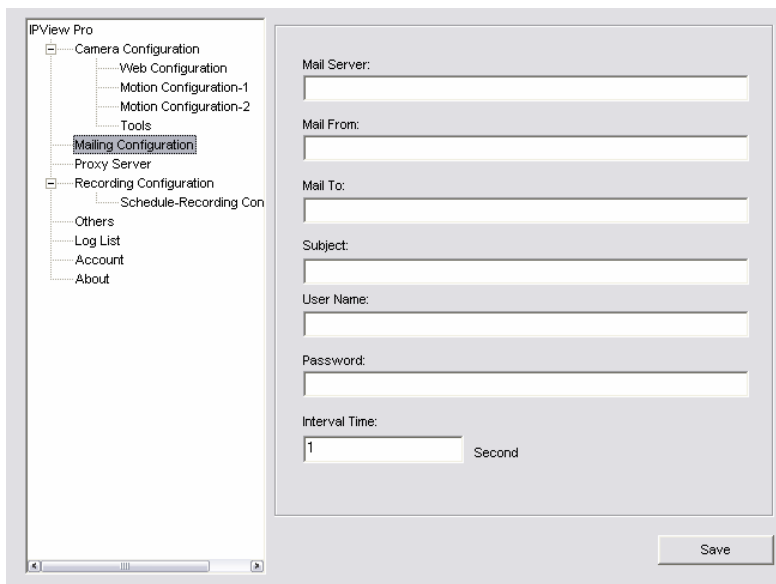

- **Mail Server:** Enter the mail server address that is used to send your e-mail.
- **Mail From/To:** Enter the sender's/receiver's e-mail address.
- **Subject:** Enter the title of the e-mail.
- **User Name/Password:** Enter the user name/password to login the mail server.
- **Interval Time:** Enter a number in this box to setup the time (in second) to send E-mail regularly.

Proxy Server

Check the Proxy Server option and enter the required settings in the **Address** and **Port** boxes to enable and use the Proxy Server function.

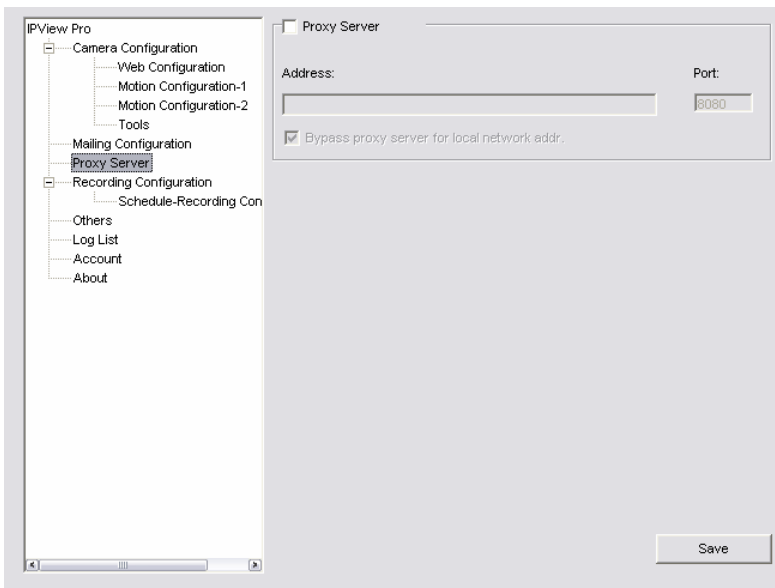

Recording Configuration

In this field, you can configure the storage settings.

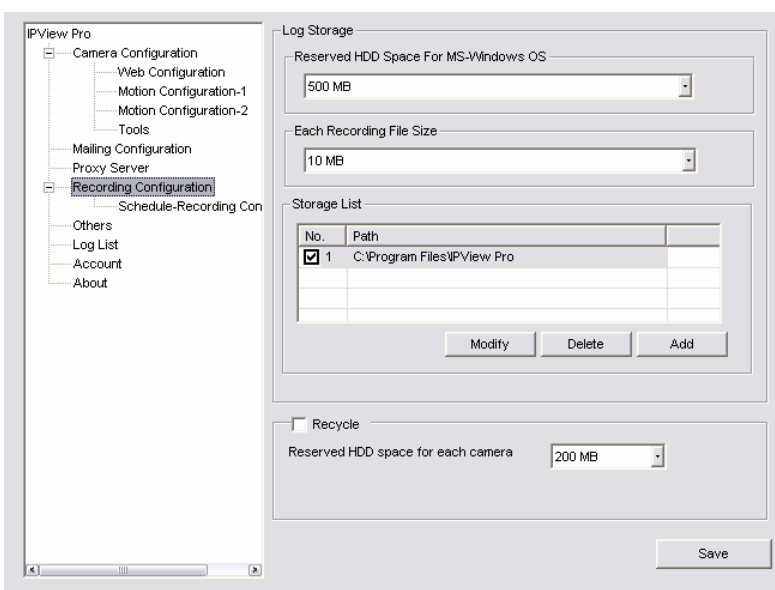

- **Log Storage:**

- **Reserved HDD Space For MS-Windows OS** – You can reserve **500 MB** to **1000 MB** hard disk space for the program.
- **Each Recording File Size** – If the recorded video files reach the file size limit, video images will be recorded into another file automatically. The available settings are from **10 MB** to **50 MB**.
- **Storage List** – The destination folder to save the recorded video file can be specified here. Click **Modify** to change the current path setting; click **Add** to add a new destination folder; click **Delete** to remove a selected path setting. Please note that you are not allowed to delete a path setting if there is only one setting in the list.
- **Recycle:** You can check this option to clear the files when the unreserved space of your hard disk is filled. The available settings are from **200 MB** to **50000 MB**.

Schedule-Recording Configuration

This recording function will work after you have enabled respective settings in the Schedule mode. The recording schedule can be defined by **Date Mode** or **Week Mode**.

Date Mode: First, select the camera desired from the pull-down menu. Then, setup the time in the **Start/Stop** fields. Click **Add** to add the recording schedule to the list. Click **Save** to save the settings.

Week Mode: First, select the camera desired from the pull-down menu. Then, setup the time in the **Start/Stop** fields, and select the weekday from the buttons. Click **Add** to add the recording schedule to the list. Click **Save** to save the settings.

Others

When multiple cameras connected, this option allows the system to display these views as the main view in circles according to your time settings. The range of **Time interval of scan** is from **1** to **20** seconds.

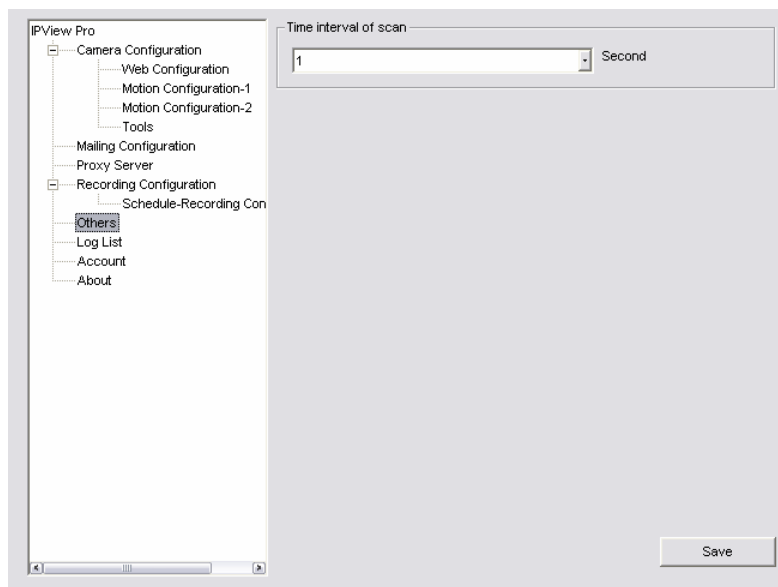

Log List

This filed displays the user(s) information, which includes the Date, MAC address, and the brief description of events.

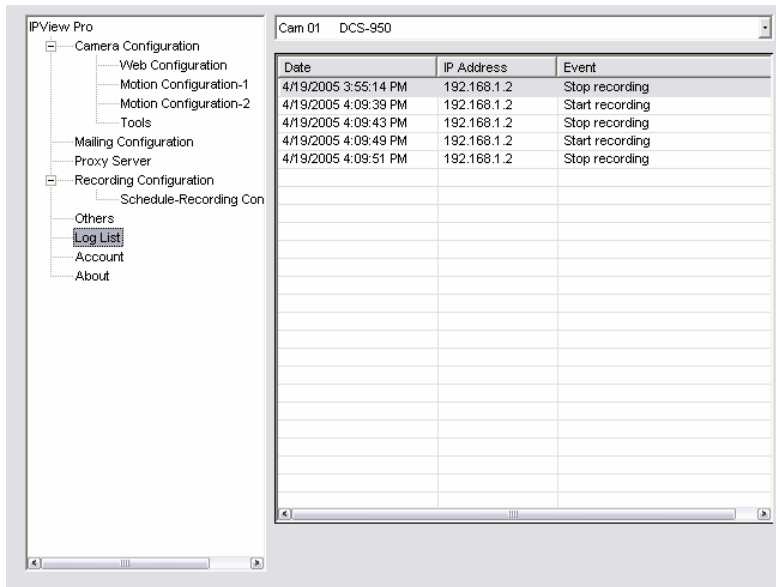

Account

This filed allows the system administrator to manage the account information. Selecting **Login Password check** to enable the system to check the password when login.

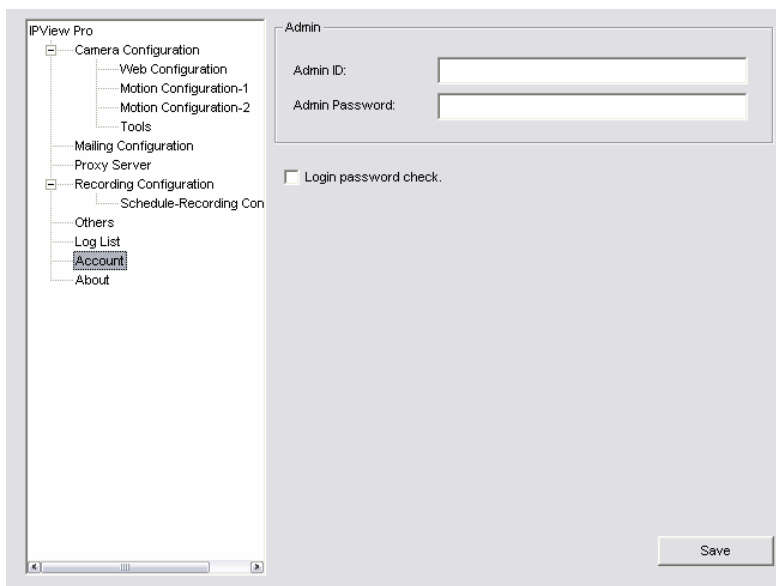

About

This file provides information of the software application.

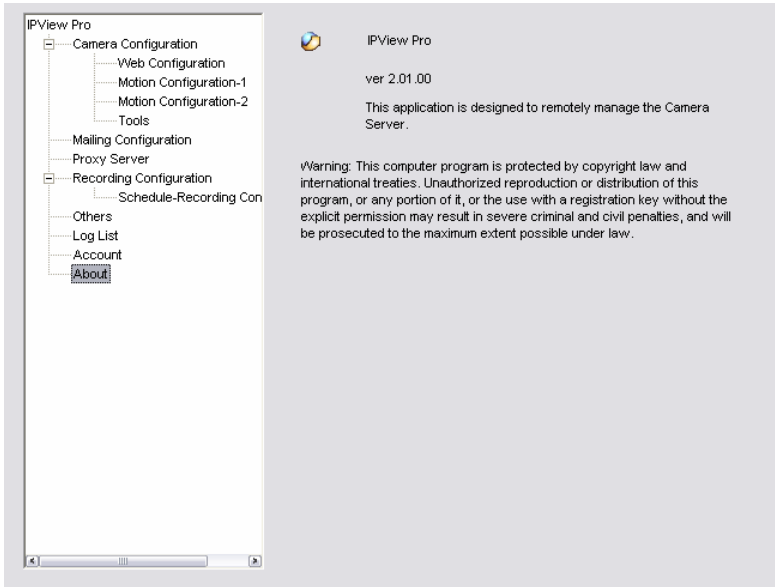

Chapter 12

Setup Wizard

12.1 Wizard Setup

The Setup Wizard is a convenient tool that will guide you through the installation of your camera easily and quickly. After connecting the camera to your computer, you can install the Setup Wizard and complete the configuration now.

Insert the CD-ROM into the CD-ROM drive to initiate the auto-run program. Once completed, a menu screen will appear as below:



To install the **Setup Wizard** application click the "**Install Wizard**" button to activate the installation procedure for the application program.

Once executed, you will be asked to select the desired language. Select the language you want and click “OK” to continue.

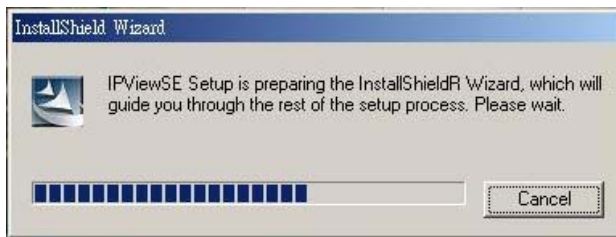

The Welcome screen will appear as below. Click the “Next” button. The License Agreement window will appear as below. Read the details carefully and click the “Yes” button.

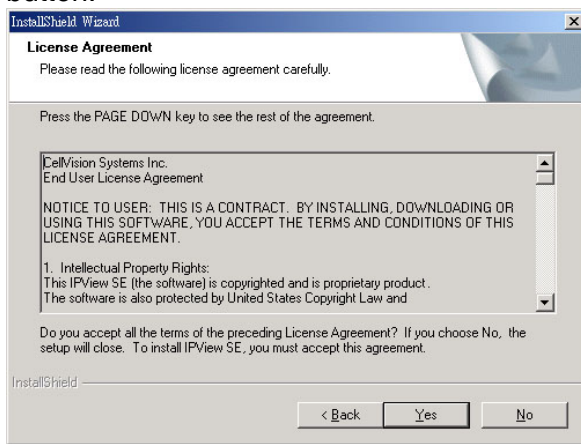

In the following window, you may click “Next” to accept the recommended destination location or click “Browse” to select another location. After specifying the desired destination location, click “Next”.

The following window allows you to select the folder where the IPView SE application will be located, click “Next” to continue.



Please wait until one of the following two dialog boxes to appear.

Otherwise, you may simply click the “Finish” button to complete the installation procedure

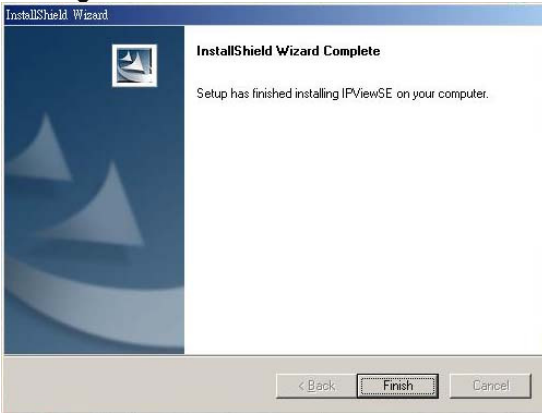

After successfully installing the Wizard, the application program for the IP Wireless Security Motorized Camera is automatically installed to \Programs\Files directory.

12.2 How to use Wizard Setup

To run the Setup Wizard, click **Start -> Programs -> Setup Wizard**.

When you launch the Setup Wizard, the main window will appear as shown, and the connected camera will be displayed in the list.



The components on the Setup Wizard:



Click **Wizard** to begin configuring the selected camera.



Click **Research** allows you to search the connected camera again.



Click **Link** to launch the web browser and view the images.



Click **About** to show the general information of the selected camera.



Click **Exit** to close the Setup Wizard.

Changing the Admin ID and Password

By default settings, the Admin ID and Password are blank. For security purpose, you are recommended to change the Admin ID and Password immediately.

Click **Wizard**. The dialog box as shown appears, asking you to enter the Admin ID and Password. Click **OK**.

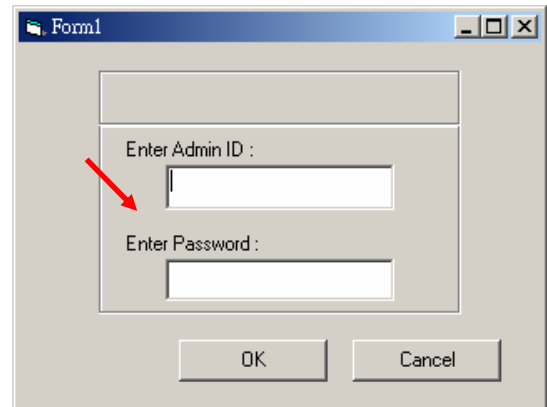

If required, select the **Change** options and enter the new Admin ID and Password.

Click **Next**.



The settings of IP Address, Subnet Mask and Default Gateway must correspond with your camera and networking settings. Please check with your network administrator for correct settings.

Click **Next**.





IP Wireless Security Motorized Camera

The **Connection Mode** depends on how your camera is connected to your network. Click **Infrastructure** for use with a router or **Adhoc** for peer-to-peer. The **Network Name**, **Wireless Channel**, and **Encryption Key** MUST correspond with your wireless network settings.

Setup Wizard

Wireless Interface

Connection Mode : Infrastructure Adhoc

Network Name (SSID) :

Wireless Channel :

Old Encryption WEP Key : ASCII HEX

Change Encryption WEP Key

New Encryption WEP Key :

Reconfirm WEP Key :

This window displays the settings you set up. For any change, click **Back** to modify your settings. Otherwise, click **Restart** to save and apply the settings.

Setup Wizard

Admin ID :

Password :

IP Address :

Subnet :

SSID :

Channel :

WEP Key :

The Setup Wizard has completed. Click on **Back** to modify your settings. Click **Restart** to save your current settings and reboot the MPEG4 Wireless Internet Camera.

The configuration is completed, and you will return to the main window. Click **Link** to launch the web browser and view the images.

Setup Wizard

Mac Address	Current IP Address	Assigned	Mode
00 03 1B 01 89 20	192.168.0.30		CAS-C330

Click About to show the general information of the selected camera.

Click **OK** to return to the main window.



Chapter 13

FFdshow & AVISavior

This chapter describes **FFdshow** and **AVISavior**, which are provided in the Installation CD. FFdshow allows you to play the recorded video files on your computer. AVISavior allows you to fix the damaged recorded video files.

13.1 Installing FFdshow

Step 1

Insert the CD-ROM into the CD-ROM drive to initiate the auto-run program. The menu screen will appear as below:

Step 2

Click the **FFdshow Install** item, and select the desired language in the pop-up dialog window.



Then, the InstallShield Wizard will appear, click **Next** in the welcome screen.

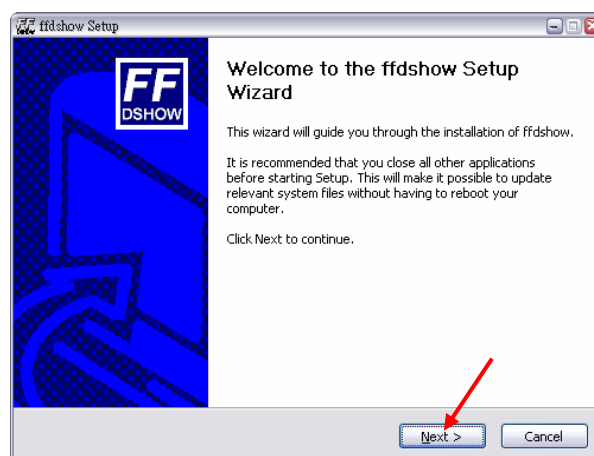

Step 3

Read and accept the License Agreement; then, click **I Agree**.

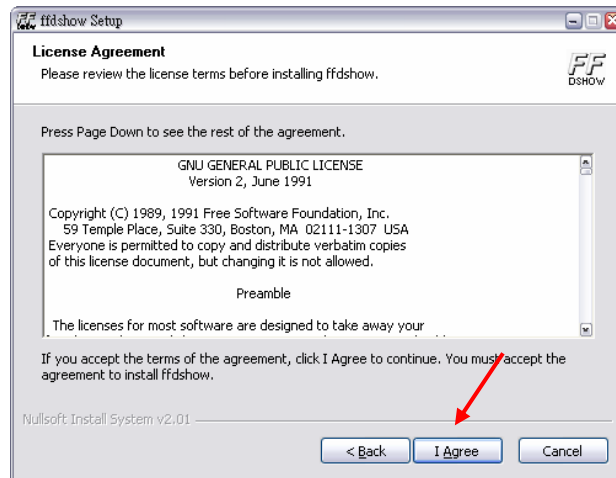

Step 4

Choose the components to be installed. If no specific requirement, leave the default setting and click **Next**.

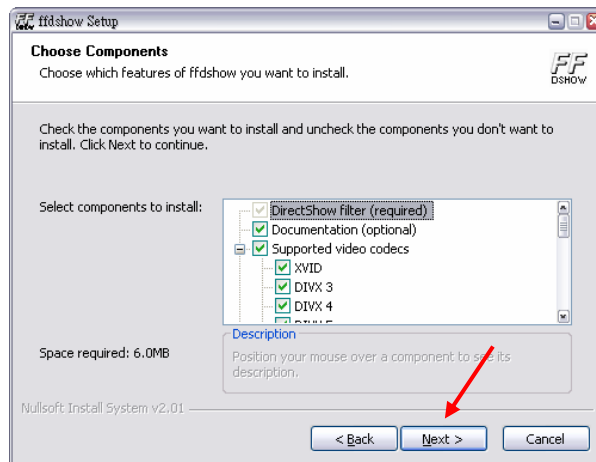

Step 5

Choose the destination location. If no specific requirement, leave the default setting and click **Install**.

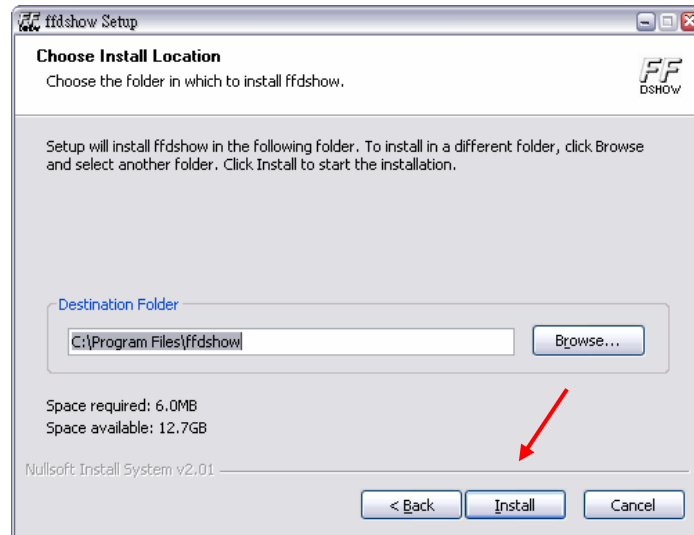

Step 6

The InstallShield Wizard starts to install the software, and the progress bar indicates the installation is proceeding. When completed, click **Next**. Then, click **Finish**.

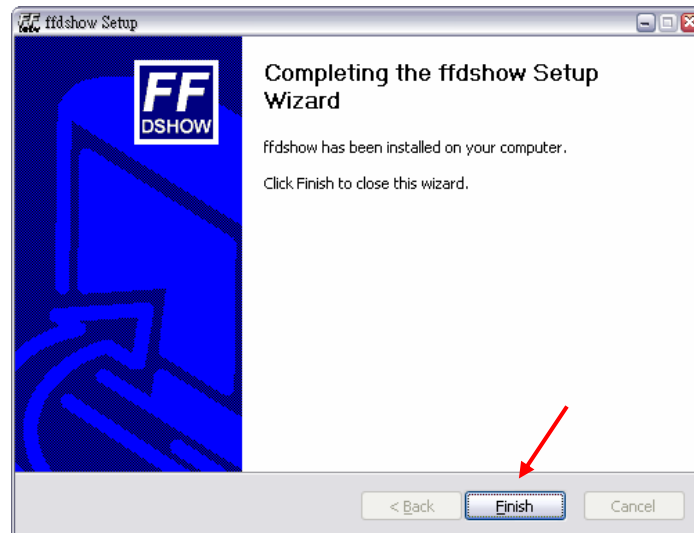

13.2 Configuration of FFdshow

Before playing the recorded video file, you have to change the following settings in FFdshow:

- Enable the **Subtitles** function.
 - Set the **Error resilience** option to **none**.
1. Click **Start > Programs > ffdshow > Configuration** to open the **ffdshow properties** window.
 2. Select to check the **Subtitles** item.
 3. Select the **Miscellaneous** item, and then set the **Error resilience** option to **none**.

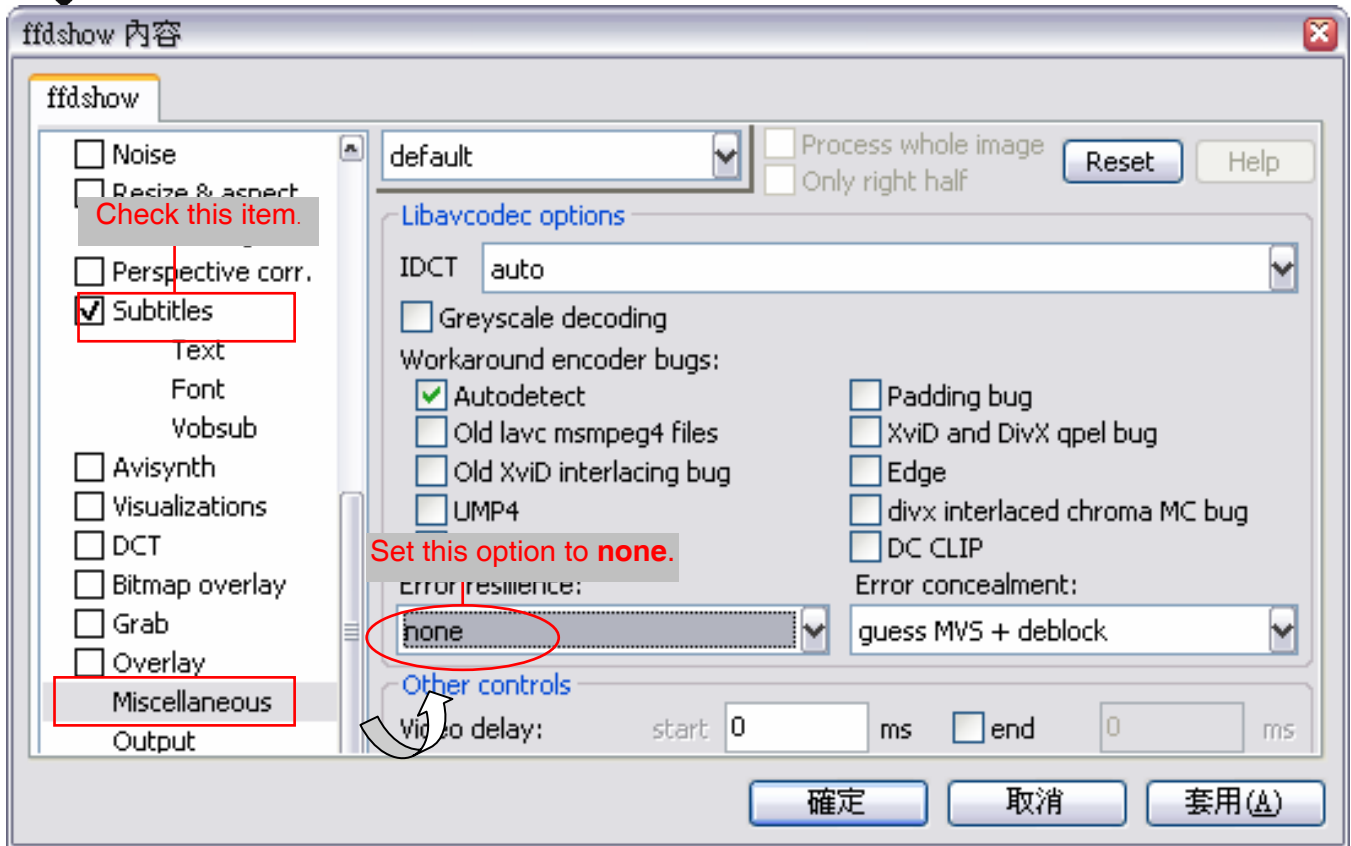

13.3 Playing the Video

Since you have recorded video files from the camera, you can play the video files simply using Windows Media Player in your computer.

1. Find the video file saved in the computer.
2. Double-click the file, and it will open Windows Media Player (as default in Microsoft Windows) to play the video file.



By default, the destination folder to save the recorded video files is :\\Program\\IPView Pro\\, and the file will be named as xxxxxxxx_yyyyyy.avi (where x is date and y is time). Also, it will automatically create a subtitle file named as xxxxxxxx_yyyyyy.sub (the same date/time settings with the corresponded .avi file). The destination folder can be changed in the Recording Configure option of IPView Pro.

13.4 Fixing the Video File

If, unfortunately, the recorded video restored in your computer is damaged, you can try to fix it using AVISavior. To launch the utility, insert the CD-ROM into the CD-ROM drive to initiate the auto-run program. The menu screen will appear as below:

Click the **AVISavior** item, and the following window will appear on the screen.

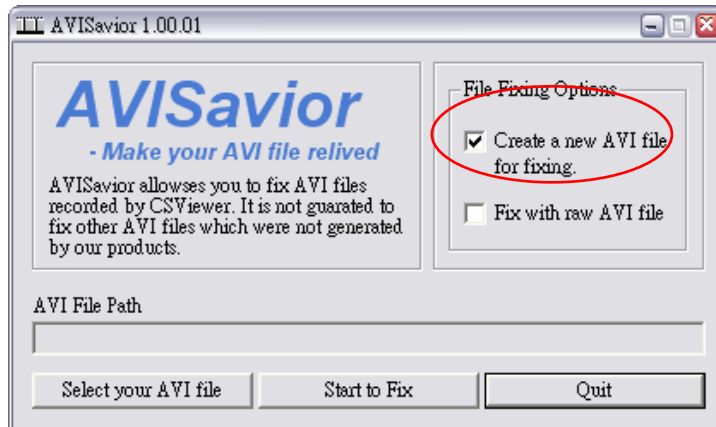

First, set up the File Fixing Options by checking the **“Create a new AVI file for fixing”** or **“Fix with raw AVI file”** item. Selecting the former one will create a new AVI file in the computer when fixed; selecting the latter one will overwrite the original file when fixed.

Then, select the AVI file that you want to fix. Click the **Select your AVI File** button to bring up a dialog window, which allows you to assign the AVI file to be fixed. When selected, the path of the AVI file will appear in the box, as shown below.

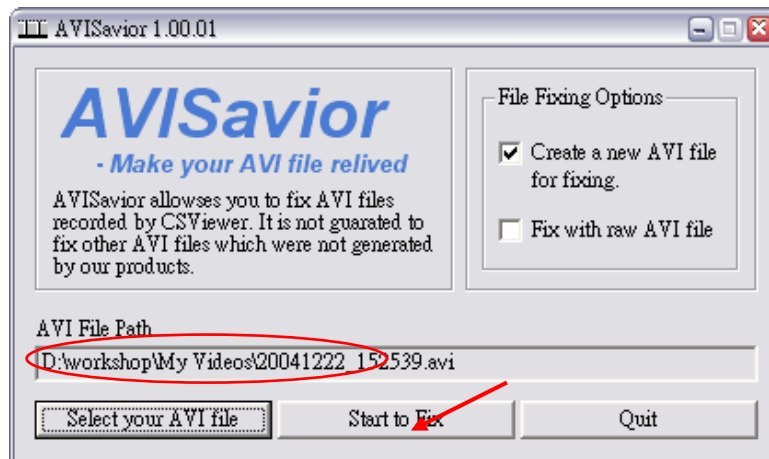

Click the **Start to Fix** button to start fixing.

Appendix A

Frequently Asked Questions

Question	Answer
What is an IP Wireless Security Motorized Camera?	The IP Wireless Security Motorized Camera is a standalone system connecting directly to an Ethernet or Fast Ethernet network and supported by the wireless transmission based on the IEEE 802.11b standard. It is different from the conventional PC Camera, the IP Wireless Security Motorized Camera is an all-in-one system with built-in CPU and web-based solutions providing a low cost solution that can transmit high quality video images for monitoring. The IP Wireless Security Motorized Camera can be managed remotely, accessed and controlled from any PC/Notebook over the Intranet or Internet via a web browser.

Question	Answer
What is the maximum number of users that can be allowed to access the IP Wireless Security Motorized Camera simultaneously?	Maximum number of users that can log onto the IP Wireless Security Motorized Camera at the same time is 10. Please keep in mind the overall performance of the transmission speed will slow down when many users are logged on.

Question	Answer
What algorithm is used to compress the digital image?	The camera utilizes the MPEG-4 image compression technology providing high quality images for users. MPEG-4 is adopted since it is a standard for image compression and can be applied to various web browsers and software applications.

Question	Answer
Can I change the wireless antenna attached to the IP Wireless Security Motorized Camera?	The wireless antenna can be changed for a variety of reasons such as extending the wireless transmission range, however, please consult authorized distributors before attempting as the connectors must be SMA connector type.

Question	Answer
What is the wireless transmission range for the IP Wireless Security Motorized Camera?	Generally the wireless distance can go up to 100 meters indoors and up to 300 meters outdoors. The range is limited by the number of walls, ceilings, or other objects that the wireless signals must pass through. Typical ranges vary depends on the types of materials and background Radio Frequency (RF) noise in your home or business and the configuration setting of your network environment.

Question	Answer
Can the IP Wireless Security Motorized Camera be used outdoors?	The IP Wireless Security Motorized Camera is not weatherproof. It needs to be equipped with a weatherproof case to be used outdoors and it is not recommended.

Question	Answer
What network cabling is required for the IP Wireless Security Motorized Camera?	The IP Wireless Security Motorized Camera uses Category 5 UTP cable allowing 10 Base-T and 100 Base-T networking

Question	Answer
Can the IP Wireless Security Motorized Camera be setup as a PC-cam on the computer?	No, the IP Wireless Security Motorized Camera is an IP Wireless Security Motorized Camera used only on Ethernet and Fast Ethernet network and supported by wireless transmission.

Question	Answer
Can the IP Wireless Security Motorized Camera be connected on the network if it consists of only private IP addresses?	The IP Wireless Security Motorized Camera can be connected to LAN with private IP addresses.

Question	Answer
Can the IP Wireless Security Motorized Camera be installed and work if a firewall exists on the network?	If a firewall exists on the network, port 80 is open for ordinary data communication. However, since the camera transmits image data, the default ports 5000, 5001 and 5100 are also required. Therefore, it is necessary to open ports 5000, 5001 and 5100 of the network for remote users to access the camera.

Appendix B

Trouble Shooting

Question	Answer
<p>I cannot access the IP Wireless Security Motorized Camera from a web browser.</p>	<p>The possible cause might be the IP Address for the IP Wireless Security Motorized Camera is already being used by another device. To correct the possible problem, you need to first disconnect the IP Wireless Security Motorized Camera from the network. Then run the PING utility.</p> <p>The PING (Packet Internet Groper) command can determine whether a specific IP address is accessible by sending a packet to the specific address and waiting for a reply. It can also provide a very useful tool to confirm if the IP address conflicts with the camera over the network.</p> <p>Follow the step-by-step procedure below to utilize the PING command. However, you must disconnect the camera from the network first.</p> <p>Start a DOS window.</p> <p>Type ping x.x.x.x, where x.x.x.x is the IP address of the camera.</p> <p>The succeeding replies as illustrated below will provide useful explanation to the cause of the problem with the camera IP address.</p>

Question	Answer
<p>I cannot access the IP Wireless Security Motorized Camera from a web browser.</p>	<p>Another possible reason is the IP Address is located on a different subnet. To fix the problem, run the PING utility (follow the instructions in Appendix B - PING Your IP Address). If the utility returns “no response” or similar, the finding is probably correct, then you should proceed as follows:-</p> <p>In Windows 95/98/2000 and Windows NT, double check the IP Address of the IP Wireless Security Motorized Camera is within the same subnet as your workstation.</p> <p>Click “Start”, “Setting”, “Control Panel”, and the “Network” icon.</p> <p>Select TCP/IP from the “Network” dialog box and from the “TCP/IP Properties” dialog box click “Specify an IP address”.</p> <p>If the IP Wireless Security Motorized Camera is situated on a different subnet than your workstation, you will not be able to set the IP address from this workstation. To verify make sure the first 3 sections of the IP address of the IP Wireless Security Motorized Camera corresponds to the first 3 sections of the workstation. Therefore the IP address of the IP Wireless Security Motorized Camera must be set from a workstation on the same subnet.</p>

Question	Answer
<p>I cannot access the IP Wireless Security Motorized Camera from a web browser.</p>	<p>Other possible problems might be due to the network cable. Try replacing your network cable. Test the network interface of the product by connecting a local computer to the unit, utilizing a standard Crossover (hub to hub) Cable. If the problem is not solved the IP Wireless Security Motorized Camera might be faulty.</p>

Question	Answer
<p>Why does the Power LED not light up constantly?</p>	<p>The power supply used might be at fault. Confirm that you are using the provided power supply DC 5V for the IP Wireless Security Motorized Camera and verify that the power supply is well connected.</p>

Question	Answer
<p>Why does the Link LED not light up properly?</p>	<ul style="list-style-type: none"> • There might be a problem with the network cable. To confirm that the cables are working, PING the address of a know device on the network. If the cabling is OK and your network is reachable, you should receive a reply similar to the following (...bytes = 32 time = 2 ms). • The network device utilized by the IP Wireless Security Motorized Camera is not functioning properly such as hubs or switches. Confirm the power for the devices are well connected and functioning. • The wireless connection might be at fault. In ad-hoc mode make sure the IP Wireless Security Motorized Camera wireless channel and ESS-ID is set to match the PC/Notebook wireless channel and ESS-ID for direct communication. Under infrastructure mode make sure the ESS-ID on the PC/Notebook and the IP Wireless Security Motorized Camera must match with the Access Point's ESS-ID.

Question	Answer
<p>Why does the IP Wireless Security Motorized Camera work locally but not externally?</p>	<ul style="list-style-type: none"> • Might be caused from the firewall protection. Need to check the Internet firewall with your system administrator. • The default router setting might be a possible reason. Need to double check if the configuration of the default router settings is required.

Question	Answer
<p>Why does a series of broad vertical white line appears through out the image?</p>	<p>A likely issue is that the CMOS sensor becomes overloaded when the light source is too bright such as direct exposure to sunlight or halogen light. You need to reposition the IP Wireless Security Motorized Camera into a more shaded area immediately as this will damage the CMOS sensor.</p>

Question	Answer
<p>There is bad focus on the IP Wireless Security Motorized Camera, what should be done?</p>	<ul style="list-style-type: none"> • The focus might not be correctly adjusted for the line of sight. You need to adjust the IP Wireless Security Motorized Camera focus manually as described in Adjust IP Wireless Security Motorized Camera Focus. • There is no adaptor fitted with your C-type lens. If you have previously changed the supplied CS-type lens, you may have unintentionally installed a C-type lens without fitting the adaptor first.

Question	Answer
<p>Noisy images occur how can I solve the problem?</p>	<ul style="list-style-type: none"> • The video images might be noisy if the IP Wireless Security Motorized Camera is used in a very low light environment. To solve this issue you need more lighting. • There might be wireless transmission interference make sure there are no other wireless devices on the network that will affect the wireless transmission.

Question	Answer
<p>There is poor image quality, how can I improve the image?</p>	<ul style="list-style-type: none"> • A probable cause might be the incorrect display properties configuration for your desktop. You need to open the Display Properties on your desktop and configure your display to show at least 65'000 colors for example at least 16-bit. • Applying only 16 or 256 colors on your computer will produce dithering artifacts in the image. • The configuration on the IP Wireless Security Motorized Camera image display is incorrect. Through the Web Configuration Image section you need to adjust the image related parameter for improve images such as brightness, contrast, hue and light frequency. Please refer to the Web Configuration section for detail information.

Question	Answer
Noisy images occur how can I solve the problem?	<ul style="list-style-type: none">• The video images might be noisy if the IP Wireless Security Motorized Camera is used in a very low light environment. To solve this issue you need more lighting.• There might be wireless transmission interference make sure there are no other wireless devices on the network that will affect the wireless transmission.

Question	Answer
There are no images available through the web browser?	The ActiveX might be disabled. If you are viewing the images from Internet Explorer make sure ActiveX has been enabled in the Internet Options menu. Alternatively, you can use the Java Applet for viewing the required images.

Appendix C

Xplug Control Installation

Installation To Web Server



It is highly recommended to install the Xplug Control application to the Web Server for IE 5.0. It must be installed to a Public Domain with Fixed IP address.

1. Installation:

Copy the “xplug.ocx” file to any WEB Server table.

2. Setting (Configuration):

From the Web Configuration menu select “System” and under the “Loading ActiveX From” input web server location

(<http://www.web server location.com/>).

Once the settings are completed, the user now is able to access the IP Wireless Security Motorized Camera from the web browser by selecting the image view – ActiveX mode.

Installation To Local PC

Insert the CD-ROM into the CD-ROM drive to initiate the auto-run program. Once completed, a menu screen will appear as below:

To install Xplug Control, click the "**Xplug Control**" button to activate the installation procedure for the plug-in program.

Once executed, a prompt will appear requesting the input of the desired language selection. Make the desired selection and click "**OK**" to continue.



The Welcome screen will appear. Click the "**Next**" button to proceed with the installation.

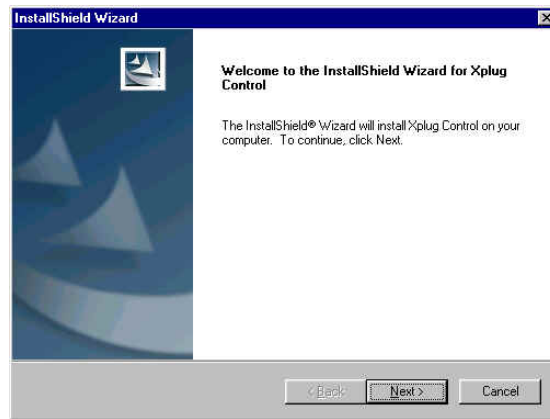

The License Agreement prompt will appear as below. Read the details carefully and click the **“Yes”** button to continue with the installation procedure.

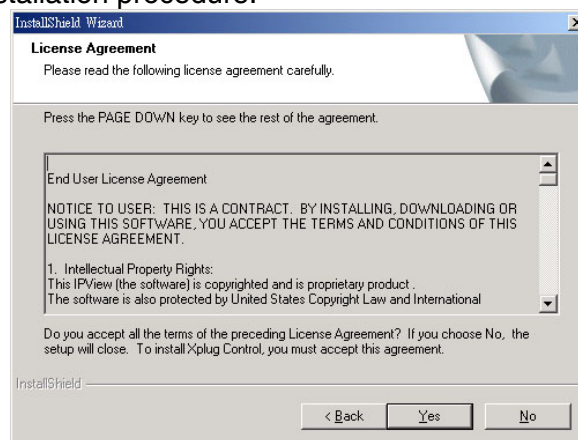

Click the **“Finish”** button to complete Setup of the Xplug Control Utility program for the IP Wireless Security Motorized Camera.

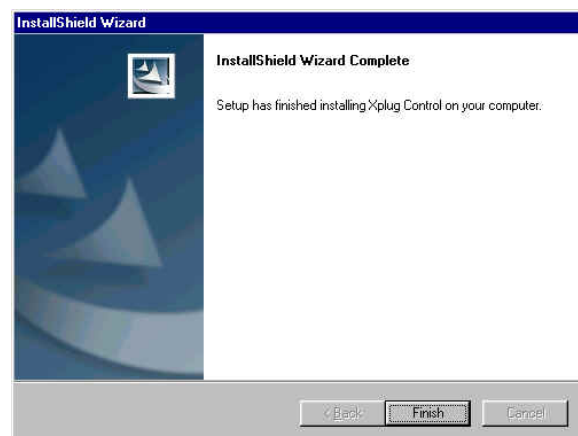

Appendix D

Adjust IP Wireless Security Motorized Camera Focus

To adjust the focus of the lens, you need to turn the lens slowly in either clockwise or anti-clockwise direction until the desired image appears. DO NOT over turn the lens in either of the directions as it will be out of focus.



You can further adjust the IP Wireless Security Motorized Camera's image quality through System Administration – Image of Web Configuration. Please refer to Web Configuration section for further details.



Direct exposure to sunlight may cause permanent damage to the CMOS sensor. Therefore do not expose the IP Wireless Security Motorized Camera's lens directly to sunlight. When operation is required in glaring light environment, it is recommended to use an iris lens.

The IP Wireless Security Motorized Camera is designed for indoor usage and if your application requires prolong exposure to sunlight, a sun visor is recommended to protect the IP Wireless Security Motorized Camera.

Appendix E

Glossary of Terms

NUMBERS

- 10BASE-T** 10BASE-T is Ethernet over UTP Category III,IV, or V unshielded twisted-pair media.
- 100BASE-TX** The two-pair twisted-media implementation of 100BASE-T is called *100BASE-TX*.
- 802.11g** An IEEE standard for wireless local area networks. It offers transmissions speeds at up to 54 Mbps in the 2.4-GHz band.

A

- Access point** It is the hardware interface between a wireless LAN and a wired LAN. The access point attaches to the wired LAN through an Ethernet connection.
- Applet** Applets are small Java programs that can be embedded in an HTML page. The rule at the moment is that an applet can only make an Internet connection to the computer from that the applet was sent.
- ASCII** American Standard Code For Information Interchange, it is the standard method for encoding characters as 8-bit sequences of binary numbers, allowing a maximum of 256 characters.
- ARP** Address Resolution Protocol. ARP is a protocol that resides at the TCP/IP Internet layer that delivers data on the same network by translating an IP address to a physical address.
- AVI** Audio Video Interleave, it is a Windows platform audio and video file format.

B

- BOOTP** Bootstrap Protocol is an Internet protocol that can automatically configure a network device in a diskless workstation to give its own IP address.

C

- Communication** Communication has four components: sender, receiver, message, and medium. In networks, devices and application tasks and processes communicate



messages to each other over media. They represent the sender and receivers. The data they send is the message. The cabling or transmission method they use is the medium.

Connection

In networking, two devices establish a connection to communicate with each other.

D

DHCP

Dynamic Host Configuration Protocol was developed by Microsoft a protocol for assigning dynamic IP addresses to devices on a network. With dynamic addressing, a device can have a different IP address every time it connects to the network. In some systems, the device's IP address can even change while it is still connected. DHCP also supports a mix of static and dynamic IP addresses. This simplifies the task for network administrators because the software keeps track of IP addresses rather than requiring an administrator to manage the task. This means a new computer can be added to a network without the hassle of manually assigning it a unique IP address. DHCP allows the specification for the service provided by a router, gateway, or other network device that automatically assigns an IP address to any device that requests one

DNS

Domain Name System is an Internet service that translates domain names into IP addresses. Since domain names are alphabetic, they're easier to remember. The Internet however, is really based on IP addresses every time you use a domain name the DNS will translate the name into the corresponding IP address. For example, the domain name *www.network_camera.com* might translate to *192.167.222.8*.

E

Enterprise network

An enterprise network consists of collections of networks connected to each other over a geographically dispersed area. The enterprise network serves the needs of a widely distributed company and operates the company's mission-critical applications.

Ethernet

The most popular LAN communication technology. There are a variety of types of Ethernet, including 10 Mbps (traditional Ethernet), 100 Mbps (Fast Ethernet), and 1,000 Mbps (Gigabit Ethernet). Most Ethernet networks use Category 5 cabling to carry information, in the form of electrical signals, between devices. Ethernet is an implementation of CSMA/CD that operates in a bus or star topology.

F

Fast Ethernet

Fast Ethernet, also called 100BASE-T, operates at 10 or 100Mbps per second over UTP, STP, or fiber-optic media.

Firewall

Firewall is considered the first line of defense in protecting private information. For better security, data can be encrypted. A system designed to prevent unauthorized access to or from a private network. Firewalls are frequently used to prevent unauthorized Internet users from accessing private networks connected to the Internet, especially Intranets all messages entering or leaving



the intranet pass through the firewall, which examines each message and blocks those that do not meet the specified security criteria.

- G**
- Gateway** A gateway links computers that use different data formats together.
- Group** Groups consist of several user machines that have similar characteristics such as being in the same department.
- H**
- HEX** Short for hexadecimal refers to the base-16 number system, which consists of 16 unique symbols: the numbers 0 to 9 and the letters A to F. For example, the decimal number 15 is represented as F in the hexadecimal numbering system. The hexadecimal system is useful because it can represent every byte (8 bits) as two consecutive hexadecimal digits. It is easier for humans to read hexadecimal numbers than binary numbers.
- I**
- IEEE** Institute of Electrical and Electronic Engineers.
- Intranet** This is a private network, inside an organization or company, that uses the same software you will find on the public Internet. The only difference is that an Intranet is used for internal usage only.
- Internet** The Internet is a globally linked system of computers that are logically connected based on the Internet Protocol (IP). The Internet provides different ways to access private and public information worldwide.
- Internet address** To participate in Internet communications and on Internet Protocol-based networks, a node must have an Internet address that identifies it to the other nodes. All Internet addresses are IP addresses
- IP** Internet Protocol is the standard that describes the layout of the basic unit of information on the Internet (the *packet*) and also details the numerical addressing format used to route the information. Your Internet service provider controls the IP address of any device it connects to the Internet. The IP addresses in your network must conform to IP addressing rules. In smaller LANs, most people will allow the DHCP function of a router or gateway to assign the IP addresses on internal networks.
- IP address** IP address is a 32-binary digit number that identifies each sender or receiver of information that is sent in packets across the Internet. For example 80.80.80.69 is an IP address, it is the closest thing the Internet has to telephone numbers. When you “call” that number, using any connection methods, you get connected to the computer that “owns” that IP address.
- ISP** Internet Service Provider, is a company that maintains a network that is linked to the Internet by way of a dedicated communication line. An ISP offers the use of its dedicated communication lines to companies or individuals who can't afford the high monthly cost for a direct connection.

J**JAVA**

Java is a programming language that is specially designed for writing programs that can be safely downloaded to your computer through the Internet without the fear of viruses. It is an object-oriented multi-thread programming best for creating applets and applications for the Internet, Intranet and other complex, distributed network.

L**LAN**

Local Area Network a computer network that spans a relatively small area sharing common resources. Most LANs are confined to a single building or group of buildings.

N**NAT**

Network Address Translator generally applied by a router, that makes many different IP addresses on an internal network appear to the Internet as a single address. For routing messages properly within your network, each device requires a unique IP address. But the addresses may not be valid outside your network. NAT solves the problem. When devices within your network request information from the Internet, the requests are forwarded to the Internet under the router's IP address. NAT distributes the responses to the proper IP addresses within your network.

Network

A network consists of a collection of two or more devices, people, or components that communicate with each other over physical or virtual media. The most common types of network are:

LAN – (local area network): Computers are in close distance to one another. They are usually in the same office space, room, or building.

WAN – (wide area network): The computers are in different geographic locations and are connected by telephone lines or radio waves.

NWay Protocol

A network protocol that can automatically negotiate the highest possible transmission speed between two devices.

P**PING**

Packet Internet Groper, a utility used to determine whether a specific IP address is accessible. It functions by sending a packet to the specified address and waits for a reply. It is primarily used to troubleshoot Internet connections.

PPPoE

Point-to-Point Protocol over Ethernet. PPPoE is a specification for connecting the users on an Ethernet to the Internet through a common broadband medium, such as DSL or cable modem. All the users over the Ethernet share a common connection.

Protocol

Communication on the network is governed by sets of rules called protocols. Protocols provide the guidelines devices use to communicate with each other, and thus they have different functions. Some protocols are responsible for



formatting and presenting and presenting data that will be transferred from file server memory to the file server's network adapter. Others are responsible for filtering information between networks and forwarding data to its destination. Still other protocols dictate how data is transferred across the medium, and how servers respond to workstation requests and vice versa. Common network protocols responsible for the presentation and formatting of data for a network operating system are the Internetwork Packet Exchange (IPX) protocol or the Internet Protocol (IP). Protocols that dictate the format of data for transfers over the medium include token-passing and Carrier Sense Multiple Access with Collision Detection (CSMA/CD), implemented as token-ring, ARCNET, FDDI, or Ethernet. The Routing Information Protocol (RIP), a part of the Transmission Control Protocol/Internet Protocol (TCP/IP) suite, forwards packets from one network to another using the same network protocol.

R

RARP

Reverse Address Resolution Protocol, a TCP/IP protocol that allows a physical address, such as an Ethernet address, to be translated into an IP address.

RJ-45

RJ-45 connector is used for Ethernet cable connections.

Router

A router is the network software or hardware entity charged with routing packets between networks.

S

Server

It is a simple computer that provides resources, such as files or other information.

SMTP

The Simple Mail Transfer Protocol is used for Internet mail.

SNMP

Simple Network Management Protocol. SNMP was designed to provide a common foundation for managing network devices.

Station

In LANs, a station consists of a device that can communicate data on the network. In FDDI, a station includes both physical nodes and addressable logical devices. Workstations, single-attach stations, dual-attach stations, and concentrators are FDDI stations.

Subnet mask

In TCP/IP, the bits used to create the subnet are called the subnet mask.

T

(TCP/IP)

Transmission Control Protocol/Internet Protocol is a widely used transport protocol that connects diverse computers of various transmission methods. It was developed by the Department of Defense to connect different computer types and led to the development of the Internet.

Transceiver

A transceiver joins two network segments together. Transceivers can also be used to join a segment that uses one medium to a segment that uses a different medium. On a 10BASE-5 network, the transceiver connects the network adapter or other network device to the medium. Transceivers also can be used on 10BASE-2 or 10BASE-T networks to attach devices with AUI ports.



U

UDP The User Datagram Protocol is a connectionless protocol that resides above IP in the TCP/IP suite

ULP The upper-layer protocol refers to Application Layer protocols such as FTP,SNMP, and SMTP.

User Name The USERNAME is the unique name assigned to each person who has access to the LAN.

Utility It is a program that performs a specific task.

UTP Unshielded twisted-pair. UTP is a form of cable used by all access methods. It consists of several pairs of wires enclosed in an unshielded sheath.

W

WAN Wide-Area Network. A wide-area network consists of groups of interconnected computers that are separated by a wide distance and communicate with each other via common carrier telecommunication techniques.

Windows Windows is a graphical user interface for workstations that use DOS.

Workgroup A workgroup is a group of users who are physically located together and connected to the same LAN, or a group of users who are scattered throughout an organization but are logically connected by work and are connected to the same network group.

Workstations Workstation refers to the intelligent computer on the user's desktop. This computer may be an Intel-based PC, a Macintosh, or a UNIX-based workstation. The workstation is any intelligent device a user works from.

Appendix F

Specification

Video specification:

Resolution: 640 x 480 pixel
Sensor: color CMOS sensor
Gain control: Automatic
Exposure: Automatic
White Balance: Automatic
Minimum Illumination: 0.5 LUX
Focal Length: 6.0 mm
Aperture: F=1.8
Focus Extent: 20 cm - ∞
Lens mounting: Fixed board lens

Image (Video Setting)

Image compression: MPEG4
Frame rate: 30fps@QQVGA, 30fps@QVGA, 30fps@VGA
Compression Rate selection: 5 levels, very low, low, middle, high, very high
Frame rate setting: 1, 5, 7, 15, 20, auto (depends on the video format)
Video resolution: 160x112, 320x240, 640x480
Brightness control: Range 1- 128
Contrast control: Range 1- 128
Saturation Control: Yes
Digital Zoom: Yes(4X)
Upside down and Mirror: Yes

Audio

MIC Input: Internal MIC (mono)
Sensitivity: 42dB

Hardware Interface

LAN Connector: One RJ-45 port to connect to 10/100Mbps Ethernet, auto-sensed
Wireless LAN: Built-in 802.11g (Wi-Fi compliant) wireless LAN module
LED Indicator: Power LED (Blue), Link LED (Orange)
Power Supply: DC 5V, switching type
Power Communication: 8 Watt (1600mA x 5V)
Antenna Connector: 1 connectors (Reverse-SMA)

Pan/Tilt

Pan -170°~ +170°
Tilt +30 ~ -85°



Communication Support

Communication: 10/100Mbps Ethernet and 802.11g wireless LAN.

Encryption: WAP-PSK, WEP 128 bit, WEP 64 bit or OFF

Communication protocol: HTTP, TCP/IP, UDP, ARP, ICMP, DHCP, PPPoE, DDNS, UPnP, UPnP AV, NetBIOS over TCP/IP

System

CPU: Infineon-ADMtek 5120

RAM: 32M Byte

Flash ROM: 4M Byte

OS: Linux

Browser Support

System requirement:

CPU: Celeron 1.5 GHz or above

Memory Size: 6128MB (256 MB recommended)

VGA card resolution: 800x600 or above

Internet Explorer 5.0 or above (ActiveX Mode –View Image supports Internet Explorer under Windows OS)

Netscape 6.0 or above

IPView Pro Application

Support OS: Win 98 SE, Win 2000, Win Me, Win XP

System requirement for IPView:

CPU: Celeron 1,5 GHz or above

Memory Size: 128 MB (256 MB recommended)

VGA card resolution: 800x600 or above

Powerful application software for image capture and video recording

- Bundle software supports image capture and video recording up to 16 channels simultaneously
- Multi-Window motion detection and send video e-mail when motion detected
- or scheduled events with notification.
- Single Frame Image Snap shot

Operating environment

Operating temperature: 5°C ~ 40°C

Storage temperature: -25°C ~ 50°C

Humidity: 5% ~ 95% non-condensing

Package Contents:

One IP Wireless Security Motorized Camera

One Quick Installation Guide

One External Antenna (2.2 dBi)

One Installation CD Rom with IPView Pro

One Metal Clip (wall mounting).

One DC Power Adapter

One RJ-45 Ethernet Cable

APPENDIX G

Support

If you have any problems with the IP Wireless Security Motorized Camera, please consult this manual.

If you have any other questions you can contact the Atlantis Land company directly at the following address:

Atlantis Land SpA
Viale De Gasperi, 122
20017 Mazzo di Rho(MI)
Tel: +39. 02.93906085, +39. 02.93907634(help desk)
Fax: +39. 02.93906161

Email: info@atlantis-land.com or tecnic@atlantis-land.com

WWW: <http://www.atlantis-land.com>

Free Manuals Download Website

<http://myh66.com>

<http://usermanuals.us>

<http://www.somanuals.com>

<http://www.4manuals.cc>

<http://www.manual-lib.com>

<http://www.404manual.com>

<http://www.luxmanual.com>

<http://aubethermostatmanual.com>

Golf course search by state

<http://golfingnear.com>

Email search by domain

<http://emailbydomain.com>

Auto manuals search

<http://auto.somanuals.com>

TV manuals search

<http://tv.somanuals.com>