

## Owners and Installation Manual

# MMD70

7" LCD MONITOR & DVD PLAYER

**Note:**

This Product incorporates copyright protection technology that is protected by method claims of certain patents and other intellectual property rights owned by Macrovision Corporation and other rights owners. Use of this copyright protection technology must be authorized by Macrovision Corporation, and is intended for home and other limited viewing uses only unless authorized by Macrovision Corporation. Reverse engineering or disassembly is prohibited.

**Warnings**

Do not use any solvents or cleaning materials when cleaning the video monitor.

Do not use any abrasive cleaners, they may scratch the screen.

Use only a lightly dampened lint free cloth to wipe the screen if it is dirty.

Lock the LCD screen in the fully closed position when not in use.

Before putting on headphones always adjust the volume setting to the lowest position.

Remember to leave the dome light switch in the off or auto positions when the vehicle is unattended, as the dome lights, if left on, can drain the vehicle's battery.

Do not put pressure on the screen.

Licensed under one or more of the following patents,  
Patent NOS. 5,775,762 and 5,927,784

## Important Notice

An LCD panel and/or video monitor may be installed in a motor vehicle and visible to the driver if the LCD panel or video monitor is used for vehicle information, system control, rear or side observation or navigation. If the LCD panel or video monitor is used for television reception, video or DVD play, the LCD panel or video monitor must be installed so that these features will only function when the vehicle is in “park” or when the vehicle’s parking brake is applied.

An LCD panel or video monitor used for television reception, video or DVD play that operates when the vehicle is in gear or when the parking brake is not applied must be installed to the rear of the driver’s seat where it will not be visible, directly or indirectly, to the operator of the motor vehicle.

## **A. Introduction**

Thank you for selecting the MMD70. The main features include a 7" Wide Screen (16:9 Aspect Ratio) Liquid Crystal Display (LCD) monitor and a built-in DVD player. The unit applies the latest state of the art electronics. The unit is constructed to provide years of reliable, trouble-free service. Please read the entire instruction manual supplied with this product prior to operation. The documentation will assist you in installing the system properly to obtain the best equipment performance. Please store this manual for later use.

## **B. Cautions and Warnings**

### ***1. Installation***

Ensure that the MMD70 is installed in accordance with the instructions and illustrations provided in this manual.

### ***2. Object and Liquid***

Do not push objects of any kind into the unit through openings; do not spill or spray liquid of any kind on or in the system (this may result in a fire or electric shock). To ensure proper ventilation and proper operation, never cover or block the slots and openings with a cloth or other material.

### ***3. Disassembly***

Do not attempt to disassemble the cabinet. There is a risk of electric shock and/or exposure to Laser Radiation. Contact qualified service personnel if your system is in need of repair.

### ***4. Cleaning Unit***

When cleaning, make sure the system is unplugged from the power source. Do not use liquid cleaners or aerosol cleaners. Use a cloth lightly dampened with water for cleaning the exterior of the system only.

## **5. Disc**

Do not use irregularly shaped discs such as heart or star-shaped discs as they may cause the unit to malfunction. Do not stick paper, tape or glue on the disc. Do not expose the disc to direct sunlight or heat sources such as hot air ducts. Do not touch the surface of disc. Handle the disc by its edge. Clean the disc by wiping the disc from the center out with a cleaning cloth. Remove the disc from the unit and store it in its case after playing. Some playback operations of discs may be intentionally fixed by software producers. Since this unit plays discs according to the disc contents the software producers designed, some playback features may not be available. Also refer to the instructions supplied with the discs.

\*Note: Please don't use disc of 8cm for the unit's shortage.

## **C. CONTENTS**

1. 7" LCD Monitor & DVD Player Combo
2. A/V Adapter Cable
3. Power/Domelight Harness
4. Hardware Package
  - 4 pcs M3.5 x 18mm Panhead Philips Machines Screws
  - 2 pcs Rubber Plugs
5. Remote Control
6. Mounting Plate
7. Instruction Manual

## D. INSTALLATION AND POWERING

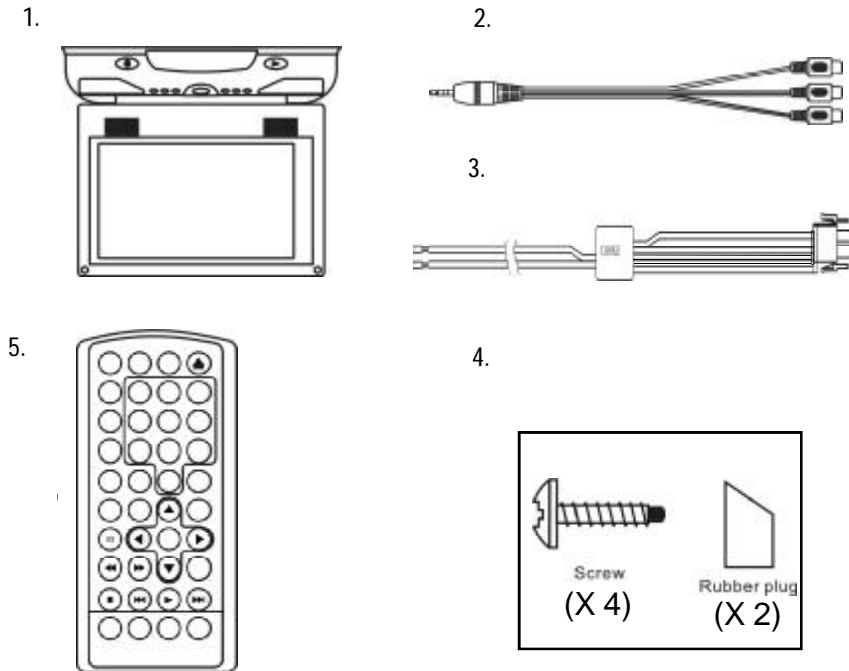

Figure 1

### TOOLS REQUIRED:

- #2 Philips Screwdriver
  - #1 Philips Screwdriver
  - Utility or Razor Knife or Shears
  - Wire Strippers
  - Upholstery hook tool (for removal of panels as necessary)
  - Electrical Tape
  - Masking Tape
  - Multimeter (to verify 12 volt DC and continuity: Do not use a test light or logic probe)
  - Marker pen – to mark headliner
  - Scribe (to mark trim ring if used)
  - Misc. electrical connectors (to connect to vehicle power source).
- Requirements will vary from vehicle to vehicle.

## **GENERAL INSTALLATION APPROACH:**

- 1) Decide upon system configuration and options that will be installed (i.e.: what components, VCP, Tuner, RF Modulator/external amp, remote headphones, DVD, etc.).
- 2) Review all manuals to become familiar with electrical requirements and hook ups.
- 3) Decide upon mounting locations of all components and method of mounting.
- 4) Prep the vehicle by removing any interior trim necessary to gain access to vehicle's wiring as well as all areas where interconnecting wire harnesses will need to be located. If any access holes need to be cut into the vehicle (headliner, other trim components etc.), this should be done now as well.
- 5) Route the wiring harnesses throughout the vehicle as necessary. (Refer to the Wiring Diagrams on page 10 of this manual as well as the wiring instructions for the individual components and accessory options being installed). Be sure that all wiring is protected from sharp edges and is routed in such a manner that it will not be pinched when all components and interior trim are fully installed. Be sure to leave enough slack in the wiring at each component to allow working room.
- 6) Remove all A/V system components from their packaging and place them loosely in the vehicle at their respective locations.
- 7) Connect all components together (electrically) and verify proper operation of all system functions. Note: This is best done BEFORE components have been permanently mounted.
- 8) After verifying proper operation of the system, proceed to mount each of the components.
- 9) When all components are mounted, recheck function of entire system again to ensure that no wiring was pinched or connected improperly during final installation.

Notes :The MMD70 video system is only intended for an overhead, drop down installation. It is not intended for seat back or any other type of mounting. The hinging mechanism is designed for horizontal, drop down use only.

**VEHICLE PREPARATION:**

- 1) Locate an accessory power source (+12v when key is in the ACC. and run positions, and 0v when key is off). Generally, this wire can be found at the ignition switch or fuse-box.
  
- 2) The mounting method and location will vary from vehicle to vehicle, so this manual will only focus on the installation of the video monitor and related console accessories.
  
- 3) Generally, the best location for the video monitor is where the vehicle's factory dome light is installed. The monitor should be located in such a manner that it can be comfortably viewed by rear seat passengers. NEVER INSTALL THE MONITOR IN A PLACE WITHIN THE DRIVER'S VIEW. THIS IS NOT ONLY DANGEROUS, BUT IT IS ALSO ILLEGAL.
  
- 4) Once the mounting location of the monitor has been determined, there may be additional preparation work necessary, depending on the vehicle structure and installation method. Some of the steps that may be required are:
  - A) Removal of the vehicle's dome light.
  - B) The headliner may need to be trimmed.



## MOUNTING THE MMD70

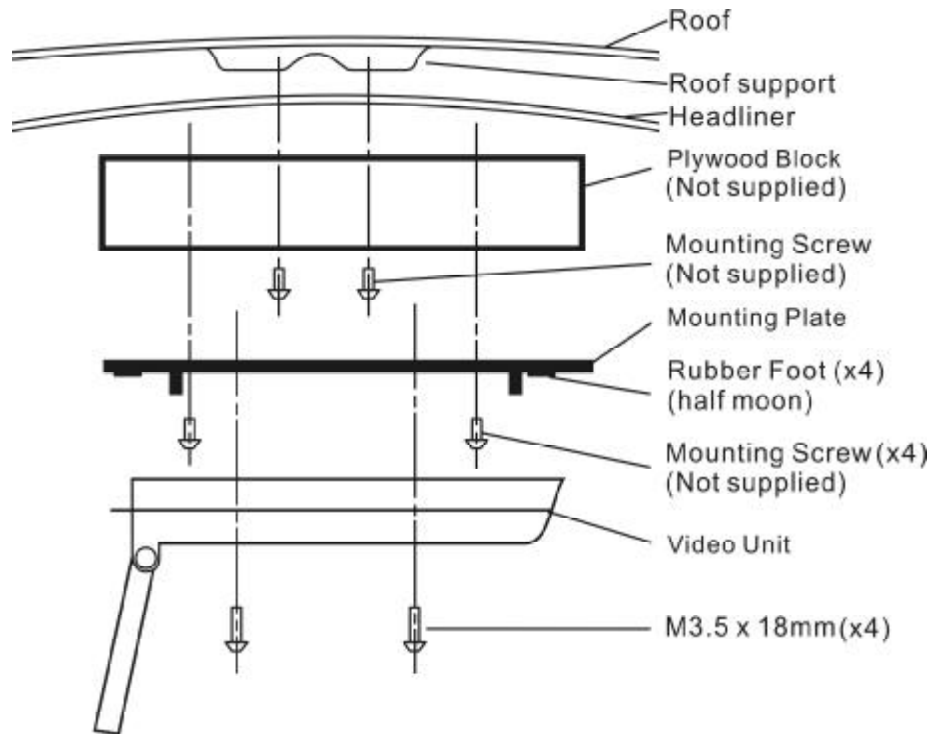

**Figure 2**

**NOTE:** Two of the mounting holes are located under the domelight covers.

# MMD70

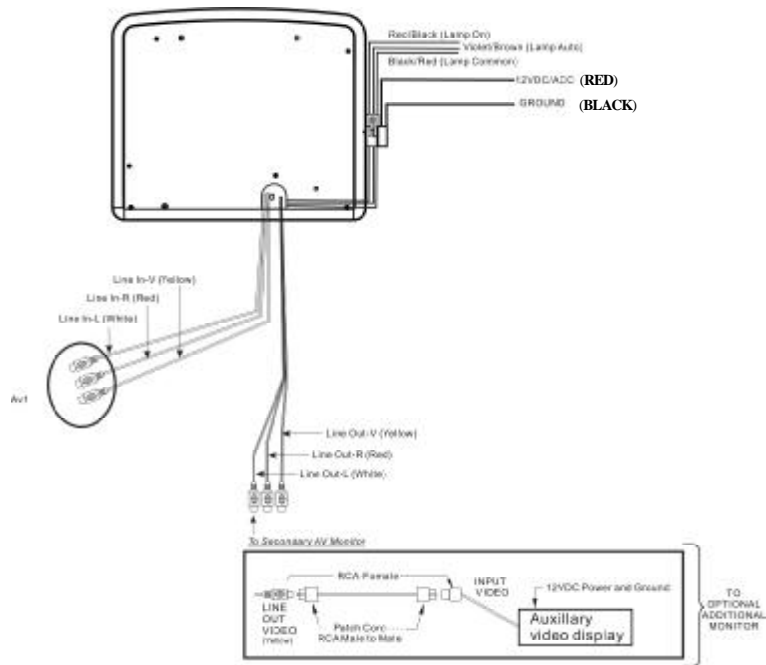

**Figure 3**

- 1) Make the connections to the vehicle with the 5 pin wiring harness.
- 2) Connect the 5 pin harness to the mating connector on the Video Monitor.
- 3) Connect power harness to vehicle's electrical system by tapping into an accessory hot line.
- 4) Verify all functions of the system before final mounting of the finished assembly.

**NOTE:** A VCP or other A/V Component can be connected to the video monitor system using an RCA A/V cable. This second harness would plug into the AV1 inputs or AUX jack.

A/V Source Definitions :

- 1 = Built-in DVD
- 2 = AV1 input ( VCP, Game, DVD, etc )
- 3 = AV2 Input ( VCP, Game, DVD, etc )

## CONNECTING THE DOME LIGHTS

The dome lights in the video monitor require three connections to the vehicle's wiring. There are two common types of dome light circuits used, positive or negative switched. Positive systems supply voltage to the interior lights to turn them on, negative switched systems apply ground to illuminate the bulbs. To determine which system you have you must locate the wires at the dome light. On a positive switched system, with all the doors closed and the lights out, both wires at the dome light will rest at ground. When the light is activated, one of these wires will switch to +12V DC. This is the vehicle's switching wire. On a negative switched system, with all the doors closed and the lights out, both wires at the dome light will rest at + 12V DC. When the light is activated, one of these wires will switch to ground. This is the switching wire.

For positive systems, connect the violet / brown (Lamp auto) wire to the vehicle's switched wire. Then connect the red / black (lamp on) wire to a fused constant 12 volt source and the black / red (lamp common) wire to a good ground. Positive systems are commonly found on Ford vehicles.

For negative systems, connect the violet / brown (Lamp auto) wire to the vehicle's switched wire. Then connect the red / black (lamp on) wire to a good ground and the black / red (lamp common) wire to fused constant 12 volt source. Negative systems are commonly found on General Motors and import vehicles.

***Note:***

*Some vehicles which incorporate transistorized control of the dome light circuit, such as the 1999 Dodge Caravan, may require that the violet / brown (Lamp auto) wire be connected to the door pin switch wire, as the additional current draw of the Monitor's lights may not be supported by the output of the vehicles body control computer.*

### Positive Switched Dome lighting

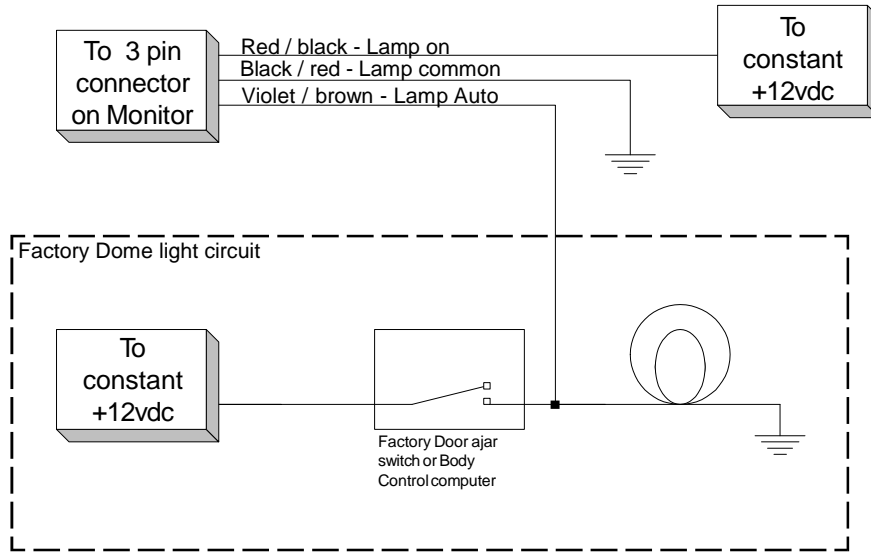

Figure 4

### Negative Switched Dome lighting

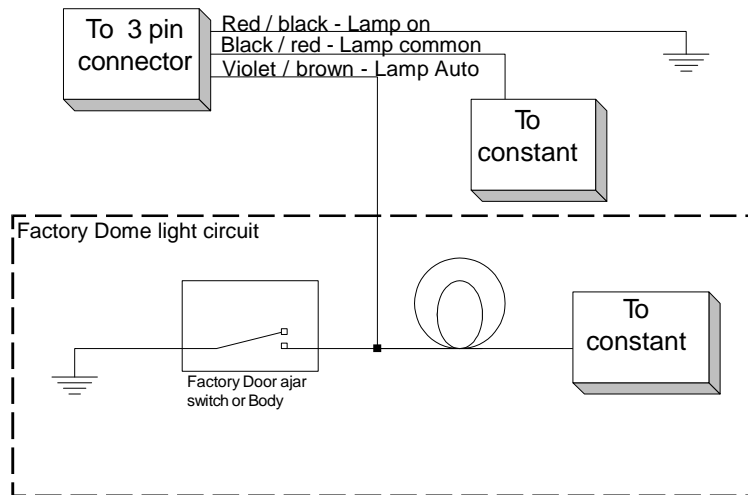
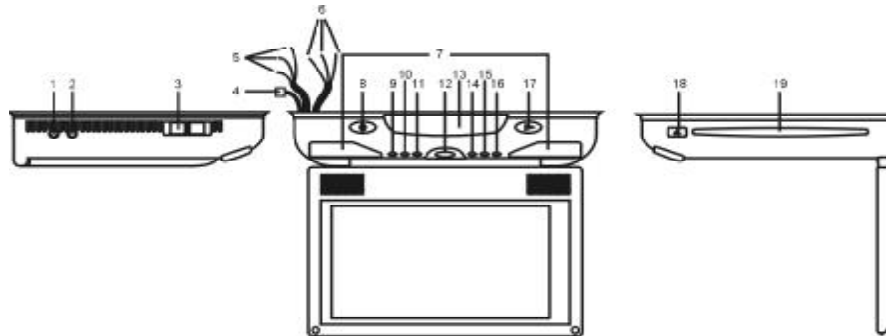

Figure 5

## E. Controls, Indicators, and Connectors

### 1. Unit View (Refer to Figure 5)

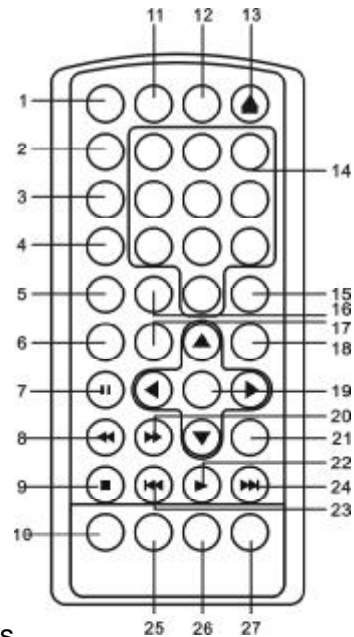

**Figure 6**

- 1) AV 2 In
- 2) Headphone Jack
- 3) Auto/Off/On(Dome Light)
- 4) Power and Dome Light Connector
- 5) AV1 RCA Jacks(red,white,yellow)
- 6) AV Output RCA Jacks (red,white,yellow)
- 7) Dome Lights
- 8) Power Button
- 9) Fast Reverse Button
- 10) STOP Button
- 11) Fast Forward Button
- 12) Monitor Open Button
- 13) IR Sensor and IR Transmitter for Wireless Headphones
- 14) Volume -
- 15) Picture
- 16) Volume +
- 17) Play button
- 18) Eject button
- 19) Disc Insertion Slot

## 2. Remote Control View (Refer to Figure 7)

- 1) Power Button
- 2) Display Button
- 3) Angle Button
- 4) Subtitle Button
- 5) A-B Button
- 6) Slow Button
- 7) Pause Button
- 8) Fast Reverse Button
- 9) Stop Button
- 10) Picture Button
- 11) DVD /AV1 /AV2
- 12) Zoom Button
- 13) Eject Button
- 14) Numeric Buttons
- 15) Audio Button
- 16) Repeat Button
- 17) Menu Button
- 18) Setup Button
- 19) Up/Down/Left/Right / Enter Buttons
- 20) Fast Forward Button
- 21) Return Button
- 22) Play Button
- 23) Previous Button
- 24) Next Button
- 25) Vol- Button
- 26) Vol+ Button
- 27) Wide Button



**Figure 7**

## F. Loading and Playing a Disc

- a. Turn power on by pressing the power button on the unit or the remote. Select DVD using the DVD/AV1/AV2 button on the remote.
- b. Place a disc into the slot with the label side facing up.
- c. Playback will start automatically.
- d. Rotate the LCD Screen for a good viewing angle.

## **G. BASIC OPERATION**

POWER	Turn the unit on/off
PLAY	Start Playback
SLOW	Play at 1/2, 1/4, 1/8, 1/16 times normal speed
PAUSE	Still Picture
STOP	(1 time) Stop at the present playing point / (2 times) Stop playing
FORWARD	Scan forward at 2, 4, 8, 20 times normal speed
REVERSE	Scan backward at 2, 4, 8, 20 times normal speed
UP/DOWN/LEFT /RIGHT	Used for Menu Navigation
ENTER	Confirm item or setting
NUMBERS	Select item or password setting
RETURN	Return
MENU	Display the root menu of the disc
REPEAT	Repeat playback of title, chapter, or track
A-B	Repeat a specific portion from point A to point B of the disc
DISPLAY	Display disc information (title, chapter, track, time, etc.)
ANGLE	Change the angles on the scene
SUBTITLE	Select the subtitle language and turn it on/off
AUDIO	Select the audio language
ZOOM	Enlarge an image to 2 or 3 times the original
SETUP	Display the setup menu to select and set items, and exit the setup menu.
DVD/AV1/AV2	Select source DVD, AV1, AV2
EJECT	Eject disc
PICTURE	Brightness/Contrast/Tint/Color
VOLUME-	Reduce volume/Lower picture setting
VOLUME+	Increase volume/Raise picture setting
SKIP-	Previous chapter/track
SKIP+	Next chapter/track

## H. MENU

A DVD is divided into sections called titles and chapters. When you play a DVD, a root menu of the disc will appear on the screen of your TV or Monitor. Contents of the menu will vary depending on the disc content. Press MENU during playback to display the main menu. Some DVDs only allow you to select disc playback options using the DVD root menu.

## I. DISPLAY

### 1) DISPLAY MODE

During playback press DISPLAY to display the current disc playback information. Press display again to remove the display.

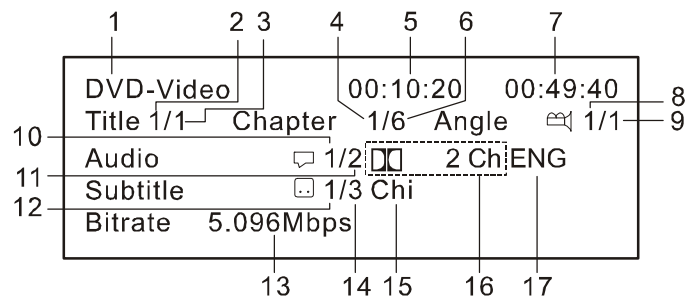

**Picture 1 Display Mode**

1. The type of disc.
2. The number of current title.
3. The number of total titles.
4. The number of current chapter.
5. The elapsed time of title.
6. The number of total chapters.
7. The remaining time of title.
8. The number of the current angle.
9. The number of total angles.
10. The number of the current audio language.
11. The number of total audio languages.
12. The number of current subtitle language.
13. The speed at which the disc is being read.
14. The number of total subtitle languages.
15. Current subtitle language.
16. Dolby audio mode.
17. Current audio language selected.



#### 4) ANGLE

During playback press ANGLE to change the current angle of discs containing multi-angles. (You can see item 8 in Picture 1 change)

DVD-Video	00:10:20	00:49:40
Title 1/1	Chapter 1/6	Angle 1/1
Audio	1/2	2 Ch ENG
Subtitle	1/3	Chi
Bitrate	5.096Mbps	

#### 'Angle' in Display Mode

1/1
-----

#### 'Angle' Display

#### 5) SUBTITLE

During disc playback press SUBTITLE\* to select the desired subtitle language. (You can see item 12 and 15 in Picture 1 change)

#### 6) AUDIO

During disc playback press AUDIO\* to select the desired audio language. (You can see item 10 and 17 change at the same time in Picture 1 change)

\*NOTE: Some DVD's only allow access to this function through the DVD menu.

## 7) ZOOM

DVD	00:10:20	00:49:40
Title 1/1	Chapter 1/6	Angle 1/1
Audio	1/2	2 Ch ENG
Subtitle	1/3 Chi	
Bitrate	5.096Mbps	Q2

### 'Zoom' in Display Mode



### 'Zoom' Display

During playback press 'ZOOM' to enlarge the picture by 2x or 3x with the current zoom multiple displayed.

## 8) REPEAT

DVD	00:10:20	00:49:40
Title 1/1	Chapter 1/6	Angle 1/1
Audio	1/2	2 Ch ENG
Subtitle	1/3 Chi	
Bitrate	5.096Mbps	Repeat Chapter

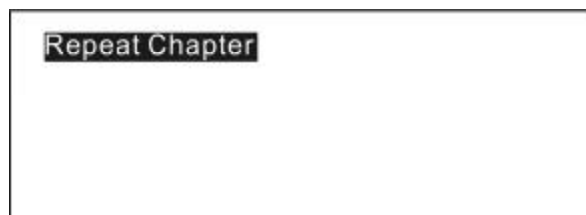

### 'Repeat' Display

During playback press 'REPEAT' once to repeatedly play the current chapter, press a 2nd time to repeat the current title, press a 3rd time and the repeat function is cancelled and normal playback resumes. Repeat mode sequence: Repeat Chapter/Repeat Title/Off.

## J. PLAYING AUDIO CDS

When playing an audio CD the display will automatically display the disc playback information. The options below show you what information is displayed. Press the 'DISPLAY' button to remove the display.

1. The current track.
2. The number of total tracks.
3. Playing time of the current song.

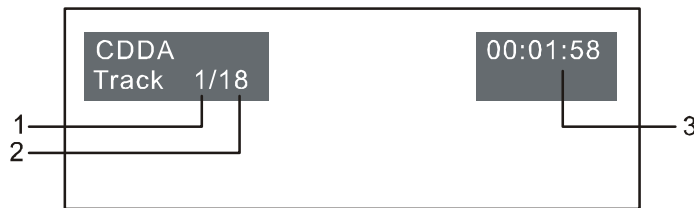

**Display in Playing CD**

## USING THE REPEAT FEATURE

The default mode for the Repeat feature is OFF. Pressing REPEAT consecutively changes the repeat options:

- *Repeat Single*- repeats the track that is playing.
- *Repeat All*- repeats the disc that is playing.
- *Off*

As you toggle through the options, the repeat option changes. The selected repeat option loops repeatedly until its turned off.

## K. PLAYING MP3 DISCS

MP3 is a digital audio format. An audio CD-quality song is compressed into the MP3 format with no significant loss of audio quality. CD-R / RW discs that have been encoded in MP3 format are compatible with this device.

Insert a MP3 Disc, the DVD player will initialize the disc and the directory (folder) will be shown on the monitor screen.

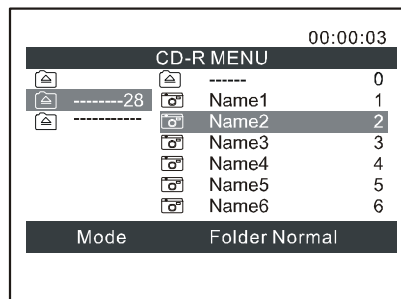

### 'MENU Screen' Display

When an MP3 disc is inserted into the unit, the menu screen appears automatically. You can use the menu screen to change folders and songs. The system plays the songs in the order they were recorded onto the disc.

1. Press the ▲ or ▼ button to choose a folder from the folder list on the left side of the screen.
2. Press ENTER to select the highlighted folder. All songs available under the selected folder will be listed.
3. Use ▲ or ▼ button to choose a song from the list then press ENTER to play the selected song.

4. Use the ►► ( NEXT ) button to move to the next song. Press the ◀◀ (PREVIOUS) button to move to the beginning of the song.



### **USING THE REPEAT FEATURE**

The default mode for the Repeat feature is OFF. Pressing REPEAT consecutively changes the repeat options:

- Repeat Single(repeat playback of a song)
- Repeat All(repeat playback of all folder)
- Off (normal playback)

Pressing REPEAT a 3rd time will resume normal playback. As you toggle through the options, the repeat option changes. Selected repeat option loops repeatedly until you turn it off.

### **NOTICE**

- “” sign in front of a file name indicates that this is a folder, not a MP3 file.
- “” sign in front of a file name indicates that this is a MP3 file. During MP3 playback, you cannot access “PLAY MODE” or folders.

### **L. PLAYING A JPEG FILE**

- 1) Insert the JPEG Disc into tray.
- 2) Select JPEG file by pressing the “UP/DOWN” button.
- 3) You can preview the JPEG file by pressing “Play” or “ENTER”.
- 4) Pressing the left or right button will rotate the JPEG counterclockwise or clockwise.
- 5) When browsing the photos, you can reverse the photo 180 degree centigrade using “UP/DOWN” key.
- 6) You can enlarge the picture by pressing “ZOOM” to 2 or 3 times.

## M. SETUP

Press 'SETUP' to display the Main screen of the SETUP Menu on the screen. Press 'SETUP' again to exit the SETUP Menu and the unit will resume its last playback mode.



**Main 'SETUP' Menu Screen**

- 1) Select 'LANGUAGE' page using the LEFT/RIGHT button.



**'Language' Display Menu**

- a. Select 'OSD Menu' using the UP/DOWN button, then press ENTER to enter the submenu. Select the OSD language you desire using the UP/DOWN button, then press ENTER/LEFT to confirm the setting and exit.



**'OSD Menu' Display Menu**

- b. Select 'Subtitle' using the UP/DOWN button, then press ENTER to enter the submenu. Select the 'Subtitle' language you desire using the UP/DOWN button, then press ENTER/LEFT to confirm the setting and exit.



**'Subtitle' Display**

- c. Select "Audio" using the UP/DOWN button, then press ENTER to enter the submenu. Select the audio language you desire using the UP/DOWN button, then press ENTER/LEFT to confirm the setting and exit.



**'Audio' Display**

- d. Select 'DISC Menu' using the UP/DOWN button, then press ENTER to enter the submenu. Select the 'DISC Menu' language you desire using the UP/DOWN button, then press ENTER/LEFT to confirm the setting and exit.



**'DISC Menu' Display**

2) Select 'Video' Page by using the LEFT/RIGHT button.

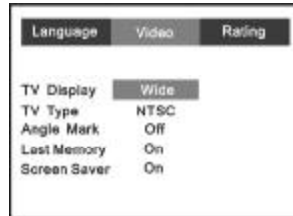

### 'Video' Display

- a. Select 'TV Display' using the UP/DOWN button, then press ENTER to enter the submenu. Select the TV display you desire using the UP/DOWN button, then press ENTER/LEFT to confirm the setting and exit.

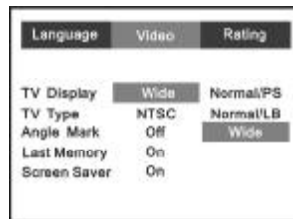

### 'TV Display' Display

- \* Normal/PS: When the player outputs signal to a normal TV, and a wide picture is shown on the full screen.
- \* Normal/LB: When the player outputs signal to a normal TV, and a wide picture is shown on the screen with a black strip at both the top and bottom of the screen.
- \* Wide: When the player outputs signal to a wide screen TV, a wide picture is shown on the full screen.



- b. Select 'TV Type' using the UP/DOWN button, then press ENTER to enter the submenu. Select the TV type you desire using the UP/DOWN button, then press ENTER/LEFT to confirm the setting and exit .

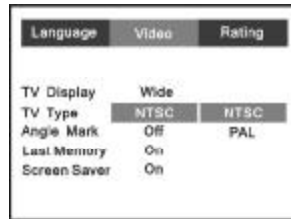

#### **'TV Type' Display**

- c. Select 'Angle Mark' using the UP/DOWN button and then press ENTER to enter the submenu. Choose Angle Mark on or off using the UP/DOWN button, then press ENTER/LEFT to confirm the setting and exit.

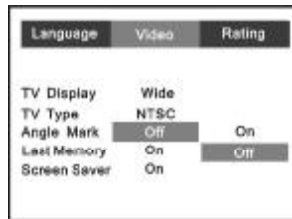

#### **'Angle Mark' Display**

- \* On: The screen will show angle mark.  
(\*If angle option is available).
- Off: The screen will not display the Angle Mark

- d. Select 'Last Memory' using the UP/DOWN button and then press ENTER to enter the submenu. Choose Angle Mark on or off using the UP/DOWN button, then press ENTER/LEFT to confirm the setting and exit.

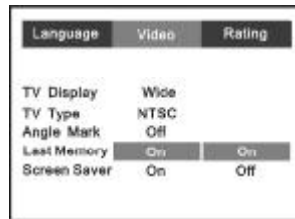

#### 'Last Memory' Display

- \*On: The unit will return to the last position on the disc.
- \*Off: The unit will not return to the last position on the disc.

- e. Select 'Screen Saver' using the UP/DOWN button and then press ENTER to enter the submenu. Choose Angle Mark on or off using the UP/DOWN button, then press ENTER/LEFT to confirm the setting and exit.



#### 'Screen Saver' Display

- \*On: Enables screen saver
- \***NOTE:** The DVD player will enter the Screen Saver mode after approximately five minutes if the same image remains on the screen.
- \*Off: Disables screen saver (off)

3) Select 'Rating' by using the LEFT/RIGHT button.



### 'Rating' Display

Select 'Password' using the UP/DOWN button. Input the password (For the first time use 3308) and press ENTER to unlock the unit. Select 'Rating' using the UP/DOWN button and press ENTER repeatedly to change the rating level you desire. Use the UP button to return to 'Password' and input either the default password or any new 4 digit password you want and press ENTER. Next time you can use these 4 new digital as your password.

Rating: 1. Kid Safe 2. G 3. PG 4. PG-13  
5. PG-R 6. R 7. NC-17 8. Adult

**NOTE:** For 1st time use the default password is 3308.

**NOTE:** The Default Password is **3308**. This password is always effective even after you have selected your own password to lock. To avoid the possibility of others using the default password to set the parental level and change the password, you can record this default password in another area and delete it from this manual. Some discs can be limited depending on the age of users while some discs can not.

**Load Factory:** To restore all of the options to the default settings select 'LOAD FACTORY' using the UP/DOWN button and press ENTER. This will return all of the settings (except rating level and the password you set) to the default settings.

#### **N. Playing a Video Game (Refer to Figure 8)**

Change the source by pressing the DVD/AV1/AV2 button on the remote. AV2\* is from the AV IN port on the side of the unit. AV1 is the RCA connectors on the top of the unit.

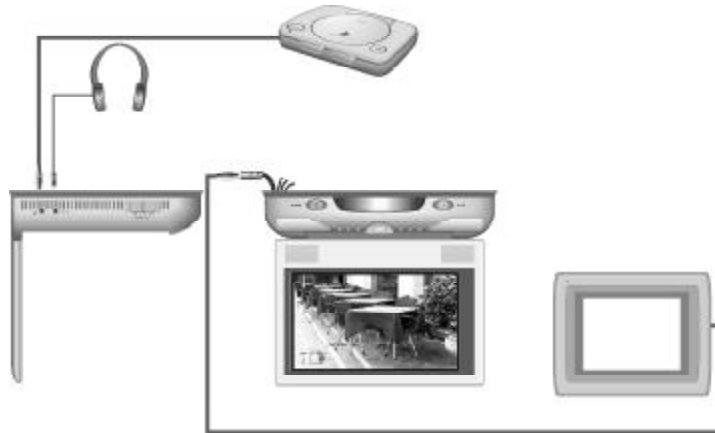

**Figure 8**

Connect the A/V output from your game system to the RCA inputs (AV1) or the 1/8 (AV2)\* input on the side. Adjust the volume and picture for individual preference.

#### **O. Wired Headphones and Wireless headphones**

(Refer to Figure 8)

1. Optional wired Headphones may be used. Connect the headphones to the Headphone Jack on the left side of the unit (Part Number MMWHS).
2. Optional wireless headphone can also be used (Part Number MMIRHS).

NOTE: Refer to the Owner's Manual with the headphones for complete instructions.

\*AV2 requires the use of the supplied AV adaptor cable.

## P. Specification

Disc format: DVD/CD/MP3

Color system: NTSC/PAL

Screen size: 7"

Frequency response: 20 Hz to 20 kHz

Video output: 1 Vp-p/75 Ohm, unbalanced

Audio output: 1.4V<sub>rms</sub>/10kOhm

Audio S/N: Better than 60 dB

Dynamic range : Better than 85 dB

Laser: Semiconductor Laser, Wave Length: 650 nm/790 nm

Power source: DC 12V

Power consumption: 30 W

Operating temperature: 5~35°C

Storage temperature: -20~60°C (4~140°F)

Operating humidity: 10~75%

Dimensions (W x H x D): 223 x 165 x 50 mm (8.78" x 6.5" x 1.97")

## Q. Troubleshooting:

### SYMPTOM:

### REMEDY:

#### **No power at Video Monitor**

-Verify +12 VDC on Red wire at 2 pin Power Harness behind video monitor. Verify ground connection with continuity test from known good ground to black wire at 2 pin Power Harness.

#### **Power but no video or sound**

-Verify that the correct source is selected (i.e.: DVD, AV1 or AV2). Verify that the source is on and playing a known good media (such as a videotape). Verify connections at both ends of the harness.

#### **Picture, but no sound**

-Verify that the headphones are turned on; check headphone batteries.  
-Verify that power is available to the FM Modulator; make sure the modulator and the vehicle radio are tuned to the FM station.



## 12 MONTH LIMITED WARRANTY

Applies to AEC Mobile Video Products

AUDIOVOX ELECTRONICS CORP. (the Company) warrants to the original retail purchaser of this product that should this product or any part thereof, under normal use and conditions, be proven defective in material or workmanship within 12 months from the date of original purchase, such defect(s) will be repaired or replaced with reconditioned product (at the Company's option) without charge for parts and repair labor. A game controller, if supplied, is similarly warranted for ninety (90) days.

To obtain repair or replacement within the terms of this Warranty, the product is to be delivered with proof of warranty coverage (e.g. dated bill of sale), specification of defect(s), transportation prepaid, to the Company at the address shown below.

This Warranty does not extend to the elimination of externally generated static or noise, to correction of antenna problems, to costs incurred for installation, removal or reinstallation of the product, or to damage to digital memory cards, discs, speakers, accessories, or vehicle electrical systems.

This Warranty does not apply to any product or part thereof which, in the opinion of the Company, has suffered or been damaged through alteration, improper installation, mishandling, misuse, neglect, accident, or by removal or defacement of the factory serial number/bar code label(s). THE EXTENT OF THE COMPANY'S LIABILITY UNDER THIS WARRANTY IS LIMITED TO THE REPAIR OR REPLACEMENT PROVIDED ABOVE AND, IN NO EVENT, SHALL THE COMPANY'S LIABILITY EXCEED THE PURCHASE PRICE PAID BY PURCHASER FOR THE PRODUCT.

This Warranty is in lieu of all other express warranties or liabilities. ANY IMPLIED WARRANTIES, INCLUDING ANY IMPLIED WARRANTY OF MERCHANTABILITY, SHALL BE LIMITED TO THE DURATION OF THIS WRITTEN WARRANTY. ANY ACTION FOR BREACH OF ANY WARRANTY HEREUNDER INCLUDING ANY IMPLIED WARRANTY OF MERCHANTABILITY MUST BE BROUGHT WITHIN A PERIOD OF 24 MONTHS FROM DATE OF ORIGINAL PURCHASE. IN NO CASE SHALL THE COMPANY BE LIABLE FOR ANY CONSEQUENTIAL OR INCIDENTAL DAMAGES FOR BREACH OF THIS OR ANY OTHER WARRANTY, EXPRESS OR IMPLIED, WHATSOEVER. No person or representative is authorized to assume for the Company any liability other than expressed herein in connection with the sale of this product.

Some states do not allow limitations on how long an implied warranty lasts or the exclusion or limitation of incidental or consequential damage so the above limitations or exclusions may not apply to you. This Warranty gives you specific legal rights and you may also have other rights which vary from state to state.

**U.S.A. :** AEC 150 MARCUS BLVD., HAUPPAUGE, NEW YORK 11788 | 1-800-645-4994

**CANADA :** CALL 1-800-645-4994 FOR LOCATION OF WARRANTY STATION  
SERVING YOUR AREA

128-6429E

© 2005 Audiovox Electronics Corporation



For Customer Service  
Visit Our Website At  
**[www.audiovox.com](http://www.audiovox.com)**  
Product Information, Photos,  
FAQ's Owner's Manuals

---

---

© 2005 Audiovox Electronics Corp., 150 Marcus Blvd., Hauppauge, N.Y. 11788

128-6985A

## Free Manuals Download Website

<http://myh66.com>

<http://usermanuals.us>

<http://www.somanuals.com>

<http://www.4manuals.cc>

<http://www.manual-lib.com>

<http://www.404manual.com>

<http://www.luxmanual.com>

<http://aubethermostatmanual.com>

Golf course search by state

<http://golfingnear.com>

Email search by domain

<http://emailbydomain.com>

Auto manuals search

<http://auto.somanuals.com>

TV manuals search

<http://tv.somanuals.com>