



**INSTRUCTION MANUAL
MANUAL DE INSTRUCCIONES**

Model Number / No. de Modelo: ORC2519SS



BEFORE USE, PLEASE READ AND FOLLOW ALL SAFETY RULES AND OPERATING INSTRUCTIONS.

La sección en español empieza en la página 15.

Avanti Products has a policy of continuous improvement on its products and reserves the right to change materials and specifications without notice.

**Avanti Products, A Division of The Mackle Co., Inc.
P.O. Box 520604 - Miami, Florida 33152
www.avantiproducts.com**

TABLE OF CONTENTS

Important Safety Instructions	3
Appliance Safety	3
Important Safeguides	4
Help Us Help You ...	5
Parts and Features	6
Electrical Connection / Extension Cord / Surge Protector	7
Installation Instructions	8
Before Using Your Appliance	8
Installation of Your Appliance	8
Casters (Wheels) Installation	9
Operating Your Appliance	10 - 11
ON/OFF Power	10
Setting the Temperature Control	10
Door Lock	11
Care and Maintenance	11
Cleaning the Beverage Cooler	11
Power Failure	11
Moving Your Beverage Cooler	11
Energy Saving Tips	11
Troubleshooting Guide	12
Service for Your Appliance	13
Wiring Diagram	13
Your Avanti Products Warranty	14
Instrucciones en Español	15 - 17
Registration Information and Registration Card	Last Page

IMPORTANT SAFETY INSTRUCTIONS

⚡ WARNING ⚡	To reduce the risk of fire, electrical shock, or injury when using your appliance, follow these basic precautions:
<ul style="list-style-type: none">• Read all instructions before using the Beverage Cooler.• DANGER or WARNING: Risk of child entrapment. Child entrapment and suffocation are not problems of the past. Junked or abandoned appliances are still dangerous . . . even if they will “just sit in the garage a few days”.• Before you throw away your old Beverage Cooler: Remove the doors. Leave the shelves/baskets in place so that children may not easily climb inside.• Never allow children to operate, play with, or crawl inside the appliance.• Never clean appliance parts with flammable fluids. The fumes can create a fire hazard or explosion.• Do not store or use gasoline or any other flammable vapors and liquids in the vicinity of this or any other appliance. The fumes can create a fire hazard or explosion. <p style="text-align: center;">-Save these instructions-</p>	

APPLIANCE SAFETY

Your safety and the safety of others are very important.

We have provided many important safety messages in this manual and on your appliance. Always read and obey all safety messages.



This is the Safety Alert Symbol. This symbol alerts you to potential hazards that can kill or injure you and others. All safety messages will follow the Safety Alert Symbol and either the words “DANGER”, “WARNING” or “CAUTION”.



Danger means that failure to heed this safety statement may result in severe personal injury or death.



Warning means that failure to heed this safety statement may result in extensive product damage, serious personal injury, or death.



Caution means that failure to heed this safety statement may result in minor or moderate personal injury, or property or equipment damage.

All safety messages will alert you do what the potential hazard is, tell you how to reduce the chance of injury, and let you know what can happen if the instructions are not followed.

IMPORTANT SAFEGUIDES



Before the appliance is used, it must be properly positioned and installed as described in this manual, so read the manual carefully. To reduce the risk of fire, electrical shock or injury when using the appliance, follow basic precaution, including the following:

DANGER

- Plug into a grounded 3-prong outlet, do not remove grounding prong, do not use an adapter, and do not use an extension cord.
- Replace all panels before operating.
- It is recommended that a separate circuit, serving only your appliance be provided. Use receptacles that cannot be turned off by a switch or pull chain.
- Never clean appliance parts with flammable fluids. These fumes can create a fire hazard or explosion. And do not store or use gasoline or other flammable vapors and liquids in the vicinity of this or any other appliance. The fumes can create a fire hazard or explosion.
- Before proceeding with cleaning and maintenance operations, make sure the power line of the unit is disconnected.
- Do not connect or disconnect the electric plug when your hands are wet.
- Unplug the appliance or disconnect power before cleaning or servicing. Failure to do so can result in electrical shock or death.
- Do not attempt to repair or replace any part of your appliance unless it is specifically recommended in this material. All other servicing should be referred to a qualified technician.

WARNING

FOLLOW WARNING CALL OUTS BELOW ONLY WHEN APPLICABLE TO YOUR MODEL

- Use two or more people to move and install appliance. Failure to do so can result in back or other injury.
- To ensure proper ventilation for your appliance, the front of the unit must be completely unobstructed. Choose a well-ventilated area with temperatures above 60°F (16°C) and below 90°F (32°C). This unit must be installed in an area protected from the element, such as wind, rain, water spray or drips.
- The appliance should not be located next to ovens, grills or other sources of high heat.
- The appliance must be installed with all electrical, water and drain connections in accordance with state and local codes. A standard electrical supply (115 V AC only, 60 Hz), properly grounded in accordance with the National Electrical Code and local codes and ordinances is required.
- Do not kink or pinch the power supply cord of appliance.
- The fuse (or circuit breaker) size should be 15 amperes.
- It is important for the appliance to be leveled in order to work properly. You may need to make several adjustments to level it.
- Never allow children to operate, play with or crawl inside the appliance.
- Do not use solvent-based cleaning agents or abrasives on the interior. These cleaners may damage or discolor the interior.
- Do not use this apparatus for other than its intended purpose.

HELP US HELP YOU...

Read this guide carefully.

It is intended to help you operate and maintain your new Beverage Cooler properly.

Keep it handy to answer your questions. If you don't understand something or you need more assistance, please call:

**Avanti Customer Service
800-220-5570**

Keep proof of original purchase date (such as your sales slip) with this guide to establish the warranty period.

CAUTION:

THIS BEVERAGE COOLER IS NOT DESIGNED FOR THE STORAGE OF MEDICINE OR OTHER MEDICAL PRODUCTS.

Write down the model and serial numbers.

You'll find them on a plate located on the rear outside wall of the Beverage Cooler.

Please write these numbers here:

Date of Purchase

Model Number

Serial Number

Use these numbers in any correspondence or service calls concerning your Beverage Cooler.

If you received a damaged Beverage Cooler, immediately contact the dealer (or builder) that sold you the Beverage Cooler.

Save time and money. Before you call for service, check the Troubleshooting Guide. It lists causes of minor operating problems that you can correct yourself.

IF YOU NEED SERVICE

We're proud of our service and want you to be pleased. If for some reason you are not happy with the service you receive, here are some steps to follow for further assistance.

FIRST, contact the people who serviced your Beverage Cooler. Explain why you are not pleased. In most cases, this will solve the problem.

NEXT, if you are still not pleased, write all the details, including your telephone number, and send it to:

**Customer Service
Avanti Products
10880 NW 30 Street
Miami, FL 33172 USA**

PARTS & FEATURES
ORC2519SS – Beverage Cooler

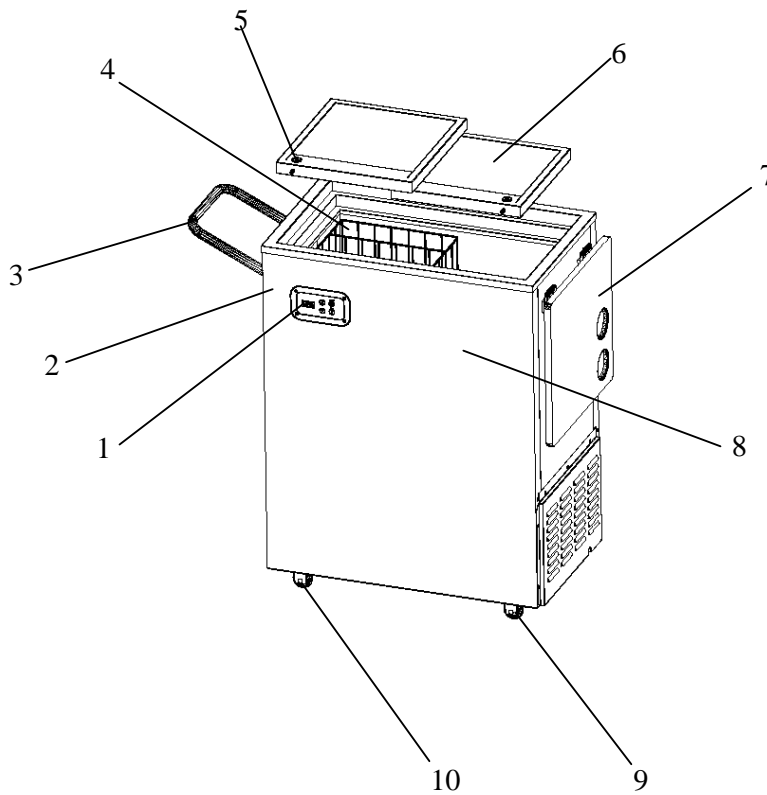
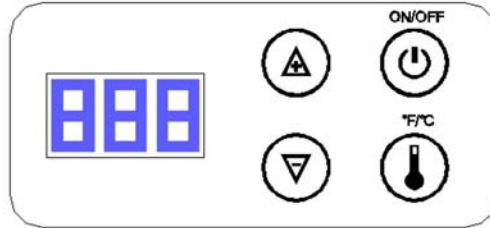

1	Control Panel	6	Glass Door
2	Cabinet	7	Collapsible Tabletop
3	Handle	8	Bottle Opener (Not Shown)
4	Storage Baskets	9	Caster without brakes
5	Security Lock	10	Casters with brakes

ELECTRICAL CONNECTION

⚡ Warning ⚡

Improper use of the grounded plug can result in the risk of electrical shock. If the power cord is damaged, have it replaced by an authorized Avanti Products service center.

This appliance should be properly grounded for your safety. The power cord of this appliance is equipped with a three-prong plug which mates with standard three prong wall outlets to minimize the possibility of electrical shock.

Do not under any circumstances cut or remove the third ground prong from the power cord supplied. For personal safety, this appliance must be properly grounded.

This appliance requires a standard 115/120 Volt AC ~/60Hz electrical ground outlet with three-prong. Have the wall outlet and circuit checked by a qualified electrician to make sure the outlet is properly grounded. When a standard 2-prong wall outlet is encountered, it is your responsibility and obligation to have it replaced with a properly grounded 3-prong wall outlet.

The cord should be secured behind the appliance and not left exposed or dangling to prevent accidental injury.

The appliance should always be plugged into its own individual electrical outlet which has a voltage rating that matches the rating label on the appliance. This provides the best performance and also prevent overloading house wiring circuits that could cause a fire hazard from overheated. Never unplug the appliance by pulling the power cord. Always grip the plug firmly and pull straight out from the receptacle. Repair or replace immediately all power cords that have become frayed or otherwise damaged. Do not use a cord that shows cracks or abrasion damage along its length or at either end. When moving the appliance, be careful not to damage the power cord.

➤ **EXTENSION CORD**

Because of potential safety hazards under certain conditions, it is strongly recommended that you do not use an extension cord with this appliance. However, if you must use an extension cord it is absolutely necessary that it be a UL/CUL-Listed, 3-wire grounding type appliance extension cord having a grounding type plug and outlet and that the electrical rating of the cord be 115 volts and at least 10 amperes.

➤ **SURGE PROTECTOR**

Most electrical appliances use a series of electric control boards to operate. These boards are very susceptible to power surges and could be damaged or destroyed.

If the appliance is going to be used in an area or if your city / country is prone to power surges / outages; it is suggested that you use a power surge protector for all electrical devices / appliances you use. The surge protector that you select must have a surge block high enough to protect the appliance it is connected to. If you have any questions regarding the type and size of surge protector needed contact a licensed electrician in your area.

Damages due to power surges are not considered a manufacturer covered defect and will void your product warranty.

INSTALLATION INSTRUCTIONS

➤ **BEFORE USING YOUR BEVERAGE COOLER**

- Remove the exterior and interior packing.
- Check to be sure you have all of the following parts:

1	Instruction Manual
2	Beverage Baskets
2	Keys
2	Casters with Brakes
2	Casters without Brakes
1	Hanging Basket
1	Handle Assembly with Screws (6)
1	Protective Cover
1	Bottle opener with screws (2)
1	Allen Wrench

- Before connecting this appliance to the power source, let it stand upright for approximately 2 hours. This will reduce the possibility of a malfunction in the cooling system from handling during transportation.
- Clean the interior surface with lukewarm water using a soft cloth.

➤ **INSTALLATION OF YOUR BEVERAGE COOLER**

- This appliance is designed to be for free standing installation.
 - Place your Beverage Cooler on a floor that is strong enough to support it when it is fully loaded.
 - Your Beverage Cooler is designed to either be moveable using the casters (included).
 - Install the casters (included) as shown in this manual on page 9.
 - Locate the Beverage Cooler away from sources of heat (stove, heater, radiator, etc.). Direct sunlight may affect the acrylic coating and heat sources may increase electrical consumption. Extreme cold ambient temperatures may also cause the unit not to perform properly.
 - Avoid locating the unit in moist areas.
 - Plug the Beverage Cooler into an exclusive, properly installed-grounded wall outlet. Do not under any circumstances cut or remove the third (ground) prong from the power cord. Any questions concerning power and/or grounding should be directed toward a certified electrician or an authorized Avanti Products service center.
-
- Collapsible Table:
 - 1) To lift it up, grab side and push upwards.
 - 2) To bring down table, lift top slightly and push latch up as shown on sketch until it releases.

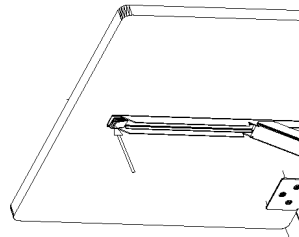
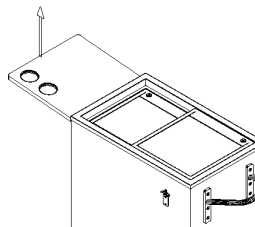

➤ **CASTER (WHEEL) INSTALLATION**

Your Beverage Cooler is designed to either be free standing in a fixed position or moveable using the casters (included). Follow the instructions below to correctly install the casters.

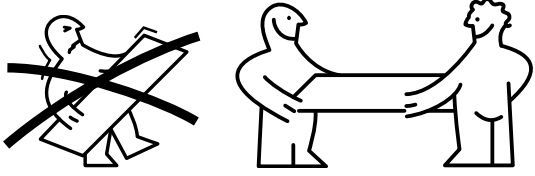
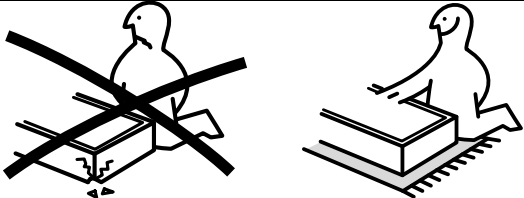
WARNING	This unit is very heavy and this process should not be done by one person alone. To avoid injury to yourself and/or damage to the unit we recommend that you proceed according to the following steps using 2 or more persons.	
WARNING	To avoid damage to the unit during installation, be sure that the area you are going to be working in is: <ul style="list-style-type: none"> • Clean • Soft stable surface for working • Flat and level 	
STEP 1	Lay the cabinet down on a soft stable surface to avoid: <ul style="list-style-type: none"> • scratching the unit • damage to the back panel 	
STEP 2	Using a Phillips head screwdriver. Install each caster as shown using four (4) M6 screws for each caster. Be sure that you install the two (2) casters with brakes in the front of the unit as shown.	
STEP 3	Installation Complete. Carefully stand the unit upright and allow it to stand for a minimum of 2 hours before connecting to the electrical outlet.	

➤ **HANDLE INSTALLATION**

Follow the instructions below to correctly install the handle.

STEP 1	Lay the cabinet down on a soft stable surface to avoid: <ul style="list-style-type: none"> • scratching the unit • damage to the back panel 	
STEP 2	Using a allen wrench. Install handle as shown using six(6) M6 screws for handle.	
STEP 3	Installation Complete. Carefully stand the unit upright and allow it to stand for a minimum of 2 hours before connecting to the electrical outlet.	

OPERATING YOUR BEVERAGE COOLER

IMPORTANT SAFEGUARDS

Do not store food in Beverage Center, as interior temperature may not get cool enough to prevent spoilage.

As a natural result of condensation, in summer months or areas of high humidity, the glass door may build up moisture on the outside. Just wipe it away.

If the ambient temperature is above or below recommended temperatures, the performance of the unit may be affected. For example, placing your unit in extreme cold (under 45°F) or hot conditions (over 110°F) may cause interior temperatures to fluctuate. The range of 34°-43°F (1°-6°C) may not be reached.

Your Beverage Cooler is designed to operate with at a range of 34° - 43° F (1 – 6°C).

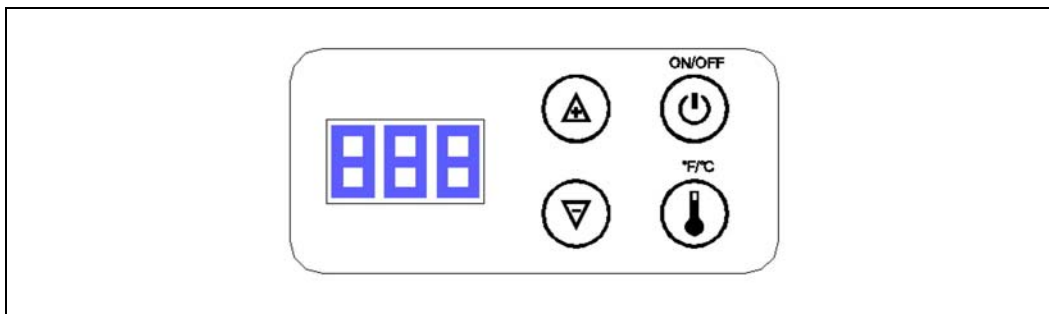



You can select temperature display setting from Fahrenheit to Celsius degree by pushing the °F/°C button/mark. Fahrenheit or Celsius degrees indicator will appear in blue color in the temperature display window.



➤ **ON/OFF POWER**

To turn ON or OFF the appliance, press the  button/mark-.

➤ **SETTING THE TEMPERATURE CONTROL**

You can press **UP**  and **DOWN**  buttons/marks to control the internal temperature .

The degrees indicators will appear in the display window.

- The temperature that you desire to set will increase 1°F or 1°C if you push the **UP**  button/mark once, on the contrary the temperature will decrease 1°F or 1°C if you push the **DOWN**  button/mark once.

NOTE:

- If the unit is unplugged, power lost, or turned off, you must wait 3 to 5 minutes before restarting the unit. If you attempt to restart before this time delay, the Beverage Cooler will not start.
- When you use the Beverage Cooler for the first time or restart the Beverage Cooler after having been shut off for a long time, there could be a few degrees variance between the temperature you select and the one indicated on the LED readout. This is normal and it is due to the length of the activation time. Once the Beverage Cooler is running for a few hours everything will be back to normal.
- Do not remove storage baskets otherwise cans or bottles may stick to the inner surface or develop excessive frost.

➤ **DOOR LOCK**

Your unit is provided with a lock and key combination.

The keys are located inside the plastic bag that contains the User's Guide.

Insert the key into the lock and turn it clockwise to unlock the door. To lock the door turn the key counterclockwise making sure metal pin is engaged completely.

Remove the key and place it in a secure place for safekeeping.

➤ **COLLAPSIBLE TABLE**

The table is designed for light weight operation and heavy items should not be placed on it.

Use caution when lowering the collapsible table.

CARE AND MAINTENANCE

➤ **CLEANING YOUR BEVERAGE COOLER**

- Turn off the power, unplug the appliance, and remove all items including shelves.
- Wash the inside surfaces with a warm water and baking soda solution. The solution should be about 2 tablespoons of baking soda to a quart of water.
- Wash the shelves with a mild detergent solution.
- Wring excess water out of the sponge or cloth when cleaning area of the controls, or any electrical parts.
- Wash the outside cabinet with warm water and mild liquid detergent. Rinse well and wipe dry with a clean soft cloth.
- Do not use steel wool or steel brush on the stainless steel. These will contaminate the stainless steel with steel particles and rusting may occur.

➤ **POWER FAILURE**

- Most power failures are corrected within a few hours and should not affect the temperature of your appliance if you minimize the number of times the door is opened. If the power is going to be off for a longer period of time, you need to take the proper steps to protect your contents.

➤ **MOVING YOUR BEVERAGE COOLER**

- Remove all items.
- Securely tape down all loose items (shelves) inside your appliance.
- Tape the door shut.
- Be sure the appliance stays secure in the upright position during transportation. Also protect outside of appliance with a blanket, or similar item.

➤ **ENERGY SAVING TIPS**

- The Beverage Cooler should be located in the coolest area of the room, away from heat producing appliances, and out of the direct sunlight.

PROBLEMS WITH YOUR BEVERAGE COOLER?

You can solve many common Beverage Cooler problems easily, saving you the cost of a possible service call. Try the suggestions below to see if you can solve the problem before calling the servicer.

TROUBLESHOOTING GUIDE

PROBLEM	POSSIBLE CAUSE
Beverage Cooler does not operate.	Not plugged in. The appliance is turned off. The circuit breaker tripped or a blown fuse.
Beverage Cooler is not cold enough.	Check the temperature control setting. The door is opened too often. The door is not closed completely. The door gasket does not seal properly.
Turns on and off frequently.	A large amount of contents has been added to the Beverage Cooler. The door is opened too often. The door is not closed completely. The temperature control is not set correctly. The door gasket does not seal properly.
The light does not work.	Not plugged in. The circuit breaker tripped or a blown fuse. The light button is "OFF".
Vibrations.	Check to assure that the Beverage Cooler is level.
The Beverage Cooler seems to make too much noise.	The rattling noise may come from the flow of the refrigerant, which is normal. As each cycle ends, you may hear gurgling sounds caused by the flow of refrigerant in your Beverage Cooler. Contraction and expansion of the inside walls may cause popping and crackling noises. The Beverage Cooler is not level.
The door will not close properly.	The door is misaligned. The Beverage Cooler is not level. The gasket is dirty. The shelves are out of position.
Display flashes Error message "E0"	Connection failure – there is a wire or component that is not connected correctly. Contact the Avanti Service Department – 1 – 800 – 220 – 5570
Display flashes Error message "E1"	Temperature sensor failure. Contact the Avanti Service Department – 1 - 800 – 220 - 5570
Display flashes Error message "E2"	Defrost sensor (Coil Sensor) failure. Contact the Avanti Service Department – 1 - 800 – 220 – 5570
Display flashes Error message "HH"	Temperature of inner cabinet is over 99°F / 37°C
Display flashes Error message "LL"	Temperature of inner cabinet is under 32°F / 0°C

SERVICE FOR YOUR BEVERAGE COOLER

We are proud of our customer service organization and the network of professional service technicians that provide service on your Avanti appliances. With the purchase of your Avanti appliance, you can have the confidence that if you ever need additional information or assistance, the Avanti Products Customer Service team will be here for you. Just call us toll-free.

AVANTI PRODUCTS CUSTOMER SERVICES

Product Information 800-323-5029	Whatever your questions are about our products, help is available.
Part Orders 800-220-5570	You may order parts and accessories that will be delivered directly to your home by personal check, money order, Master Card, or Visa.
In-Home Repair Service 800-220-5570	An Avanti Products authorized service center will provide expert repair service, scheduled at a time that is convenient for you. Our trained servicers know your appliance inside and out.

WIRING DIAGRAM

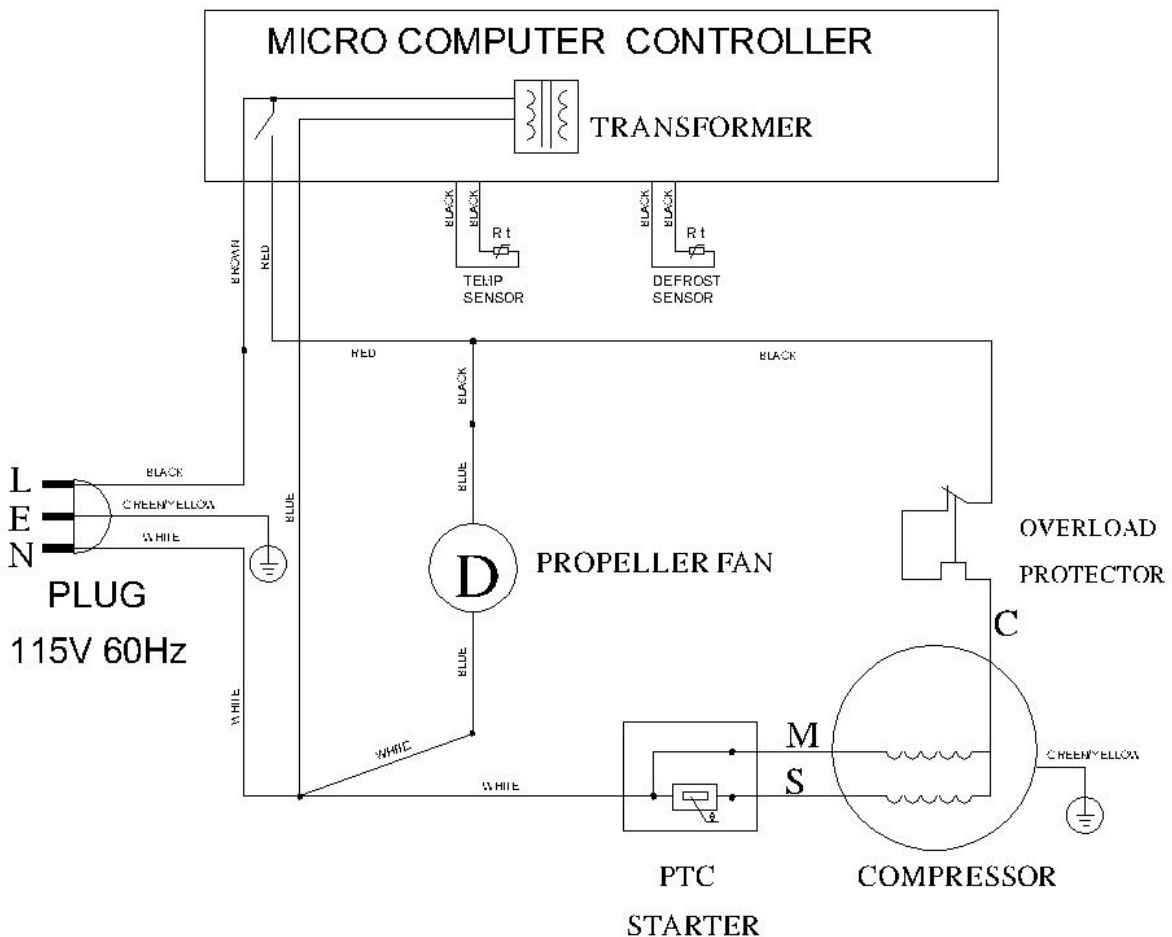

**WHAT IS COVERED
LIMITED ONE-YEAR
WARRANTY**

For one year from the date of purchase by the original owner, Avanti Products will, at its option, repair or replace any part of the unit, which proves to be defective in material or workmanship under normal use. During this period Avanti Products will provide all parts and labor necessary to correct such defects free of charge, so long as the unit has been installed and operated in accordance with the written instructions in this manual. In rental or commercial use, the warranty period is 90 days. Avanti Products will provide you with a reasonably similar replacement product that is either new or factory refurbished. All Avanti Appliances of 3.5 cubic feet capacity or less must be brought/sent to the appliance service shop for repair.

**LIMITED SECOND THROUGH
FIFTH YEAR WARRANTY**

For the second through the fifth year from date of original purchase, Avanti Products will provide a replacement compressor free of charge due to a failure. You are responsible for the service labor and freight charges. In rental or commercial use, the limited compressor warranty is one year and nine months. Cost to move the appliance to the servicers' shop and back to the user's home, as may be required, are the user's responsibility.

WHAT IS NOT COVERED

- Content losses of food or other, due to spoilage.
- Incidental or consequential damages.
- Parts and labor costs for the following will not be considered as warranty:
 - Door springs, and/or frames.
 - Inner door panels, door rails and/or door supports.
 - Light bulbs and/or plastic housing.
 - Plastic cabinet liners.
 - Punctured evaporator that voids the warranty on the complete sealed system.
 - Repairs performed by unauthorized servicers.
- Service calls that do not involve defects in material or workmanship such as customer education, door reversal, or proper installation.
- Surcharges including, but not limited to, any after hour, weekend, or holiday service calls, tolls, ferry trip charges, or mileage expense for service call to remote areas, including the State of Alaska.
- Service calls that are related to external problems, such as abuse, misuse, inadequate electrical power, accidents, fire, floods, or acts of God.
- Replacement of house fuses or resetting circuit breakers.
- Failure of the product if it is used for other than its intended purpose.
- This warranty does not apply outside the Continental USA.

INSTRUCCIONES DE SEGURIDAD

ATENCION

INSTRUCCIONES PARA LA CONEXION A TIERRA

Este aparato electrodoméstico debe estar conectado a tierra. En caso de un cortocircuito eléctrico, la conexión a tierra reduce el riesgo de choque eléctrico proporcionando un cable a tierra con una enchufe de conexión a tierra. Este enchufe debe estar conectado en un tomacorriente instalado correctamente y conectado a tierra.

ADVERTENCIA – El uso inadecuado del enchufe de conexión a tierra puede resultar en un riesgo de choque eléctrico. Consulte con un electricista o persona de reparaciones competente si no comprenden bien las instrucciones de conexión a tierra o si existe alguna duda sobre si el aparato esta conectado a tierra correctamente.

NO USE UN CORDON DE PROLONGACION ELECTRICA

Use un tomacorriente de pared exclusivo. No conecte su Enfriador a cordones de prolongación eléctrica o junto a cualquier otro electrodoméstico en el mismo tomacorriente de pared.

ADVERTENCIA IMPORTANTE:

Un Enfriador vacío es una atracción muy peligrosa para los niños. Saque todas las juntas, pestillos, tapas o puerta de todo electrodoméstico que no esté en uso, o tome alguna medida para asegurar que no presente peligro.

INSTRUCCIONES DE INSTALACION

Saque los embalajes exteriores, limpie bien el exterior con un paño suave seco, y el interior con un paño húmedo y tibio. Evite colocar el Enfriador cerca de una fuente de calor, luz de sol directa, o lugar húmedo.

Ubicación

Seleccione un lugar con su piso fuerte y nivelado.

OPERACION

PRECAUCIONES IMPORTANTES

La parte externa de la puerta de vidrio puede mostrar signos de humedad durante los meses de verano o en áreas de alta humedad, esto es el resultado natural de la condensación.

Si la temperatura ambiental es mayor o menor que la temperatura recomendada, el funcionamiento de la unidad podría ser afectado. Por ejemplo, si mantiene la unidad en condiciones de calor o frío extremadas, puede ocasionar que la temperatura interna fluctúe y que no se alcance el rango de 34° - 43°F (1° - 6°C).

Su Enfriador bebidas ha sido diseñado con un rango de temperatura de 34° - 43°F (1° - 6°C).

Para evitar vibraciones, el enfriador debe estar bien nivelado. La temperatura variará dependiendo de la cantidad de botellas o latas almacenadas y la frecuencia con que se abre la puerta.

Cuando el Enfriador no se use por un período largo, desconecte el enchufe y deje la puerta entreabierta.

Nota: Espere entre 3 a 5 minutos antes de volver a encender si el funcionamiento ha sido interrumpido. Cuando use su enfriador por primera vez o vuelva a encenderlo después de haber sido apagado por un período largo, podría ver una pequeña diferencia en la temperatura seleccionada y la indicada en la pantalla electrónica. Esto es normal y es debido al tiempo necesario de enfriarse. Como el aire frío cae y el aire caliente sube, podrá haber una pequeña variación de temperatura entre las secciones superiores y las inferiores.

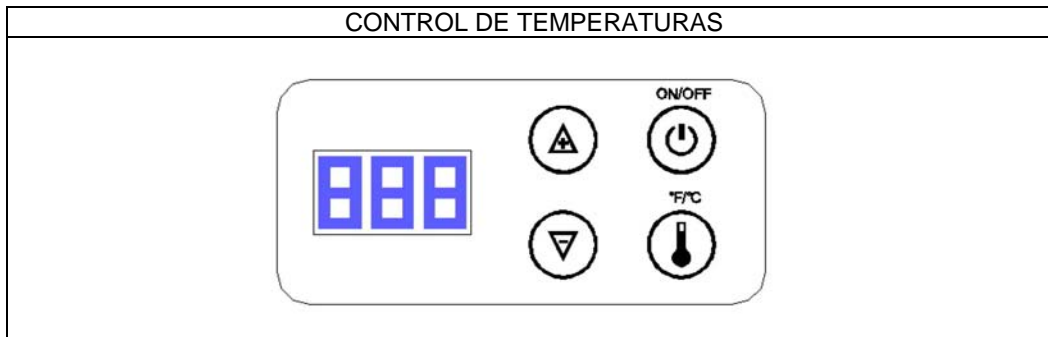







Ud puede cambiar entre grados Centígrados y Fahrenheit o viceversa, oprima el botón marcado **°F/°C**. La temperatura aparecerá en color azul los grados Centígrados o Fahrenheit en la pantalla electronic.

ENCENDIDO/APAGADO

Para apagar el enfriador, oprime el botón ()

Operación

Oprima los botones marcado “  ” y “  ” localizados en el panel de controles para programar la temperatura. Al presionar los botones marcados “  ” o “  ” por primera vez, el indicador en la pantalla mostrará la temperatura programada de fábrica o la más reciente.

Oprima el botón marcado () una vez y la temperatura aumentará un grado. Si Ud oprime el botón marcado () una vez la temperatura bajará un grado.

Cerradura de la puerta

Su unidad viene equipada con una combinación de cerradura y llave.

Las llaves (2) están dentro de la bolsa plástica junto al manual de instrucciones.

Introduzca la llave en la cerradura y gírela hacia la derecha para abrir la puerta.

Para cerrarla, gire la llave hacia el lado opuesto.

Quite la llave y colóquela en un lugar seguro para evitar que se pierda.

CUIDADO Y MANTENIMIENTO

Limpieza

Para limpiar el interior, use un paño suave con una solución de una cucharada de bicarbonato de sodio por cada cuarto de agua, o una solución de espuma de jabón suave, o un detergente suave. Para lavar las rejillas, sáquelas deslizándolas con cuidado, y use una solución de detergente suave; luego séquelas con un paño suave. Limpie el exterior con un paño húmedo suave y un poco de detergente suave o productos de limpieza para electrodomésticos.

Período de vacaciones

Para períodos cortos de vacaciones, deje los controles en la posición normal. Durante ausencias más largas;

- (a) saque todo el contenido,
- (b) desconecte el enfriador del tomacorriente,
- (c) limpie bien el enfriador,
- (d) deje la puerta abierta para evitar la formación de condensación, moho u olores.

Corte de corriente

La mayoría de los cortes de corriente se corrigen en una o dos horas y no afectarán las temperaturas de su enfriador. Sin embargo, Ud. deberá reducir la cantidad de veces que abra la puerta cuando la corriente esté apagada.

Si Ud. se muda

Saque o asegure todos los artículos dentro de su enfriador. Quite las ruedas.

Algunas reglas importantes para el uso correcto de su enfriador.

- Las bebidas se deben guardar en botellas o latas cerradas.
- No sobrecargue el compartimiento interior.
- No abra las puertas a menos que sea necesario.
- Si el enfriador se guardará sin uso por períodos largos, se sugiere que, luego de una limpieza cuidadosa, se deje una puerta entreabierta para permitir que el aire circule dentro de la caja y evitar una posible formación de condensación, moho u olores.
- Nunca cubra los estantes del compartimiento para bebidas con papel de aluminio o cualquier otro material para cubrir estantes que puedan obstruir la circulación del aire.

Registration Information

Thank you for purchasing this fine Avanti product. Please fill out this form and return it to the following address within 100 days from the date of purchase and receive these important benefits:

Avanti Products, A Division of The Mackle Co., Inc.
P.O.Box 520604 – Miami, Florida 33152

➤ **Protect your product:**

We will keep the model number and date of purchase of your new Avanti product on file to help you refer to this information in the event of an insurance claim such as fire or theft.

➤ **Promote better products:**

We value your input. Your responses will help us develop products designed to best meet your future needs.

------(detach here)-----

Avanti Registration Card

Name			Model #	Serial #
Address			Date Purchased	Store / Dealer Name
City	State	Zip	E-mail Address	
Area Code	Phone Number		Occupation	
<u>Did You Purchase An Additional Warranty</u> <input type="checkbox"/> Extended <input type="checkbox"/> None			<u>As your Primary Residence, Do You:</u> <input type="checkbox"/> Own <input type="checkbox"/> Rent	
<u>Reason for Choosing This Avanti Product:</u> Please indicate the most important factors That influenced your decision to purchase this product:			<u>Your Age:</u> <input type="checkbox"/> under 18 <input type="checkbox"/> 18-25 <input type="checkbox"/> 26-30 <input type="checkbox"/> 31-35 <input type="checkbox"/> 36-50 <input type="checkbox"/> over 50	
<input type="checkbox"/> Price <input type="checkbox"/> Product Features <input type="checkbox"/> Avanti Reputation <input type="checkbox"/> Product Quality <input type="checkbox"/> Salesperson Recommendation <input type="checkbox"/> Other: _____ <input type="checkbox"/> Friend / Relative Recommendation <input type="checkbox"/> Warranty <input type="checkbox"/> Other: _____			<u>Marital Status:</u> <input type="checkbox"/> Married <input type="checkbox"/> Single	
Comments:			<u>Is This Product Used In The:</u> <input type="checkbox"/> Home <input type="checkbox"/> Business	
			<u>How Did You Learn About This Product:</u> <input type="checkbox"/> Advertising <input type="checkbox"/> In-Store Demo <input type="checkbox"/> Personal Demo	

VER: 3.0 01272011

PRINTED IN CHINA

Free Manuals Download Website

<http://myh66.com>

<http://usermanuals.us>

<http://www.somanuals.com>

<http://www.4manuals.cc>

<http://www.manual-lib.com>

<http://www.404manual.com>

<http://www.luxmanual.com>

<http://aubethermostatmanual.com>

Golf course search by state

<http://golfingnear.com>

Email search by domain

<http://emailbydomain.com>

Auto manuals search

<http://auto.somanuals.com>

TV manuals search

<http://tv.somanuals.com>