

Avanti[®]

WINE COOLER
INSTRUCTION MANUAL
MANUAL DE INSTRUCCIONES

Model Number: WC412D
No. De Modelo.: WC412D

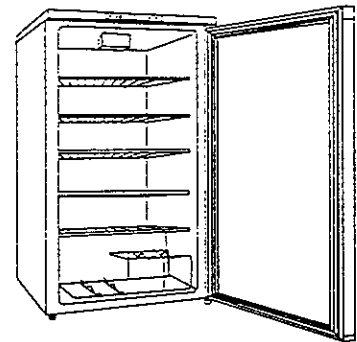

CAUTION:

**BEFORE USE, PLEASE READ AND FOLLOW ALL SAFETY
RULES AND OPERATING INSTRUCTIONS.**

La sección en español empieza en la página 16

Avanti has a policy of continuous improvement on its products and reserves the right to change materials and specifications without notice.

Avanti Products, A Division of The Mackle Co., Inc.
P.O. Box 520604 - Miami, Florida 33152
www.avantiproducts.com

Registration Information

Thank you for purchasing this fine Avanti product. Please fill out this card and return it within 100 days of purchase and receive these important benefits:

➤ **Protect your product:**

We will keep the model number and date of purchase of your new Avanti product on file to help you refer to this information in the event of an insurance claim such as fire or theft.

➤ **Promote better products:**

We value your input. Your response will help us develop products designed to best meet your future needs.

------(detach here)-----

Avanti Registration Card

Name _____

Model # _____ Serial # _____

Address _____

Date Purchased _____ Store/Dealer Name _____

City _____ State _____ Zip _____

Occupation _____

Area Code _____ Phone Number _____

As Your Primary Residence, Do You:

Did You Purchase An Additional

Own Rent

Warranty:

Extended Food Loss None

Your Age:

under 18 18-25 26-30
 31-35 36-50 over 50

Reason For Choosing This Avanti

Marital Status:

Product:

Married Single

Please indicate the most important factors that influenced your decision to purchase this product.

Is This Product Used In The:

Home Business

Price

How Did You Learn About This

Product Features

Product:

Advertising Product Features

Avanti Reputation

In Store Demo Personal Demo

Product Quality

Other _____

Salesperson Recommendation

Comments _____

Friend/Relative Recommendation

Warranty

Other _____

HELP US HELP YOU...

Read this guide carefully.
It is intended to help you operate and maintain your new refrigerator properly.

Keep it handy to answer your questions. If you don't understand something or you need more help, please call:

**Avanti Customer Service
800-220-5570**

Keep proof of original purchase date (such as your sales slip) with this guide to establish the warranty period.

CAUTION:

**THIS REFRIGERATOR
IS NOT DESIGNED FOR
THE STORAGE OF
MEDICINE OR OTHER
MEDICAL PRODUCTS.**

Write down the model and serial numbers.

You'll find them on a plate located on the rear wall outside the refrigerator.

Please write these numbers here:

Date of Purchase

Model Number

Serial Number

Use these numbers in any correspondence or service calls concerning your refrigerator. If you received a damaged refrigerator, immediately contact the dealer (or builder) that sold you the refrigerator.

Save time and money. Before you call for service, check the Troubleshooting Guide. It lists causes of minor operating problems that you can correct yourself.

IF YOU NEED SERVICE

We're proud of our service and want you to be pleased. If for some reason you are not happy with the service you receive, here are some steps to follow for further help.

FIRST, contact the people who serviced your appliance. Explain why you are not pleased. In most cases, this will solve the problem.

NEXT, if you are still not pleased, write all the details, including your telephone number, and send to:

**Customer Service
Avanti Products
10880 NW 30 Street
Miami, FL 33172**

Table of Contents

Registration Information and Registration Card-----	1
Help Us Help You-----	2
Parts and Features-----	3
Important Safety Instructions-----	5
Installation Instructions-----	5
Before Using Your Wine Cooler-----	5
Installation of Your Wine Cooler-----	5
Reversing the Door Swing of Your Refrigerator-----	7
Operating Your Wine Cooler-----	8
How To Use The Buttons On The Display Panel-----	9
Care and Maintenance-----	10
Change The Light Bulb-----	10
Cleaning Your Wine Cooler-----	11
Vacation Time-----	11
Moving Your Wine Cooler-----	11
Troubleshooting Guide-----	12
Service for Your Appliance-----	13
Your Avanti Products Warranty-----	14
Wiring Diagrams-----	15
Spanish Section-----	16,17,18

Important Safety Instructions

 WARNING	To reduce the risk of fire, electric shock, or injury when using your wine cooler, follow these basic precautions:
<ul style="list-style-type: none">• Read all instructions before using the appliance.• Child entrapment and suffocation are not problems of the past. Junked or abandoned appliances are still dangerous... even if they will "just sit in the garage a few days."• Before you throw away your old refrigerator or wine cooler: take off the door, leave the shelves in place, so that children may not easily climb inside.• Never allow children to operate, play with, or crawl inside the appliance.• Never clean appliance parts with flammable fluids. The fumes can create a fire hazard or explosion.• Do not store or use gasoline or any other flammable vapors and liquids in the vicinity of this or any other appliance. The fumes can create a fire or explosion.	
-Save these instructions-	

INSTALLATION INSTRUCTIONS

➤ Before Using Your Wine Cooler

- Remove the exterior and interior packing, including protective film on door panels .
- Check to be sure the following parts are included:
 - 6 slide out shelves (each can hold 5 bottles)
 - 1 wine rack (can hold 4 bottles)
 - 2 keys
 - 1 Instruction manual
- Before connecting the appliance to the power source, let it stand upright for approximately 2 hours. This will reduce the possibility of a malfunction in the cooling system from handling during transportation.
- Clean the interior surface with lukewarm water using a soft cloth.

➤ Installation of Your Wine Cooler

- Place your appliance on a floor that is strong enough to support the appliance when it is fully loaded. To level your appliance, adjust the legs at the front of the appliance.

- For recessed installation allow ½ inch of space between the sides of the appliance as well as the back and top. This will allow proper air circulation.
- Locate the appliance away from direct sunlight and sources of heat (stove, heater, radiator, etc.). Direct sunlight may affect the acrylic coating and heat sources may increase electrical consumption. Extreme cold ambient temperatures may also cause the appliance not to perform properly.
- Avoid locating the appliance in moist areas. Too much moisture in the air will cause frost to form quickly on the evaporator.
- Plug the appliance into an exclusive properly installed-grounded wall outlet. Do not under any circumstances cut or remove the third (ground) prong from the power cord. Any questions concerning power and or grounding should be directed toward a certified electrician or an authorized Avanti Products service center.
- Do not use an adapter plug with this appliance.
- Do not use an extension cord with this appliance. If the power cord is too short, have a qualified electrician or service technician install an outlet near the appliance.

⚡ Warning ⚡

Improper use of the grounded plug can result in the risk of electrical shock. If the power cord is damaged, have it replaced by an authorized Avanti Products service center.

➤ **Reversing the Door Swing of Your Wine Cooler**

This wine cooler has the capability of either opening the door from the left or right side. The unit is delivered to you with the door opening from the left side. Should you desire to reverse the opening direction, please follow these instructions.

NOTE:

Before Reversing the door ,the power must be shut off.

All parts removed must be saved to do the reinstallation of the door.

1. Remove the two screws(1)that hold the lower hinge(2)(right side)to the frame. Also, remove the screw-type leveling front leg(3).
2. Remove the left front leg(4) and transfer it to the right side.
3. Lift the door and place it on a padded surface to prevent scratching it. Make sure to remove the spring(5) located inside the upper right hole of the door and the upper right side pin(6).
4. Remove the plug button(7)from the upper left hole of the door and transfer it to the uncovered hole at the right side. Be sure to press the button firmly into the hole.
Insert the upper pin(6) previously removed from the right side (step 3) and transfer it to the other hole at the left side of the top frame.
5. Insert the spring(5)previously removed(step 3)inside the upper left side hole of the door.
6. Set the door in its place making sure the pin(6)enters the bushing at the lower upper frame section(hole).
7. While holding the door in the closed position, secure the lower left hinge(2)previously removed(step 1).Before placing this lower hinge , remove the upper bolt-pin(8) and reverse the direction of the hinge.
8. Insert the bolt-pin(8)and do not tighten until the top of the door is leveled with the counter top.
9. Insert the two screws(1)previously removed(step 1)and tighten them.

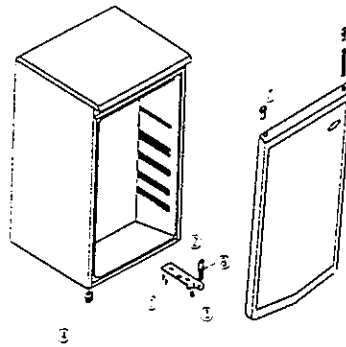

FIGURE 1(Position prior to door reversal)

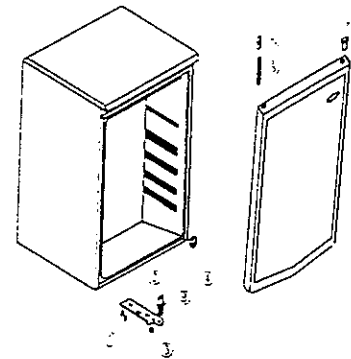

FIGURE 2(Position after door reversal)

- ① -Door Hinge Screws
- ② -Lower Door Hinge
- ③ -Front Leveling Legs
- ④ -Left Front Leg

- ⑤ -Door Frame Spring
- ⑥ -Door Frame Pin
- ⑦ -Hinge Plug(Door Frame)Left Side
- ⑧ -Door Hinge Bolt

IMPORTANT SAFEGUARDS

Do not store food in wine cooler, as interior temperature may not get cool enough to prevent spoilage. As a natural result of condensation, in summer months or area of high humidity, the glass door may built up moisture on the outside. Just wipe it away.

► OPERATING YOUR WINE COOLER

It is recommended you install the wine cooler in a place where the ambient temperature is between 72-78 degree Fahrenheit. If the ambient temperature is above or below the recommended temperature, conditions may cause interior temperature to fluctuate. The range of 45-65 degree Fahrenheit may not be reached.

If the interior light is left on, the temperature inside the wine cooler will be higher.



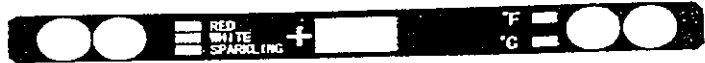

Recommended Temperatures for chilling Wine

Red wines:	60-65 F
Dry/White Wines	50-59 F
Sparkling Wines	45-49 F
Rose Wines	49-51 F

The above temperatures may fluctuate depending on whether or not the interior bulb is on or off of whether the bottles are located on the lower/middle or lower section.



➤ HOW TO USE THE BUTTONS ON THE DISPLAY PANEL:

You can set the temperature as you desire by pushing the button  or . When you push the two buttons for first time, the LED readout will show the original temperature set at previous time (the temperature preset at the factory is 50°F). The temperature that you desire to set will increase 1°F or 1°C if you push the  once, on the contrary the temperature will decrease 1°F or 1°C if you push the  once.

When you store mostly red wines, the temperature which you control by pushing the above two buttons need to be set between 60 to 65°F and the LED lamp beside "RED" will be lit red.

When you store mostly white wines, the temperature need to be set at between 50 to 59°F and the LED lamp beside "WHITE" will be lit green.
When you store mostly sparkling wine the temperature need to be set at between 45 to 49°F and the LED lamp beside "SPARKLING" will be lit amber.

You can select temperature display setting from Fahrenheit to Celsius degree by pushing the button marked F/C. Fahrenheit degree indicator will appear in red color in the display marked 'F' and the Celsius degrees indicator will appear in yellow color in the display marked 'C'.
You can turn the interior light on or off by pushing the button marked "bulb" symbol.

➤ Door Lock:

For safety and security, your unit is equipped with a door and key. Door will not lock until the key is moved. This eliminates the risk of accidental child entrapment. Two keys are included with your lock.

➤ **Shelves**

Shelving is chrome plated. To accommodate different size bottles, they can be moved up or down by sliding them out the tracks first. Shelves are designed to accommodate maximum amount of bottles.

➤ **Wine Rack**

There is an additional wine rack at bottom section of the unit where you can store up to 4 wine bottles. This rack is removable for cleaning purpose.

NOTE:

When you use the wine cooler for the first time or restart the wine cooler after having been shut off for long time, there could be a few degrees variance between the temperature you select and the one indicated on the LED readout. This is normal and it is due to the length of the activation time. Once the wine cooler is running for a few hours everything will be back to normal.

Also, there is a 6 to 8°F variance between the top and bottom shelves of the wine chiller. Therefore, if you have set the wine chiller for red wine only and the temperature reads 60°F and you want to place a mix of white and red wines, you should place the wine bottles on the bottom shelves and the red wines on the top shelves.

CARE AND MAINTENANCE

➤ **CHANGING THE LIGHT BULB**

NOTE:

All parts removed must be saved to do the replacement of the light bulb. Before removing the light bulb, either unplug the refrigerator or disconnect the electricity leading into the refrigerator at the main power supply. Failure to do so could result in electrical shock or personal injury.

- Remove the screw ⑤.
- Remove the light bulb cover ④ by pulling the bottom end of the light bulb cover gently.
- Unscrew the bulb ①.
- Replace with a 10 watt-refrigerator bulb that is the same shape and size.
- Replace the light bulb cover ④ and tighten screw ⑤.

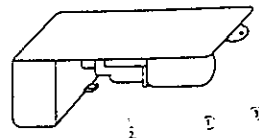

- 1 Bulb
- 2 Bulb Holder
- 3 Bulb Holder Case

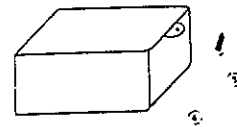

- 4 Bulb Cover
- 5 Screw

Note: Light bulb should not exceed 15 watts.

➤ **Cleaning Your Wine Cooler**

- Unplug the wine cooler, and remove the bottles.
- Wash the inside with a warm water and baking soda solution. The solution should be about 2 tablespoons of baking soda to a quart of water.
- Wash the shelves and trays with a mild detergent solution.
- The outside of the wine cooler should be cleaned with mild detergent and warm water.
- It may also be necessary to periodically wipe the bottom part of the storage area, as the wine cooler is designed to retain humidity, and condensation may collect there.

➤ **Maintenance of Your Wine Cooler**

• Power Failure

Most power failures are corrected within a few hours and should not affect the temperature of your wine cooler if you minimize the number of times the door is opened. If the power is going to be off for a longer period of time, you need to take the proper steps to protect your contents.

➤ **Vacation Time**

During long absences, remove all the bottles; unplug your wine cooler, clean your wine cooler, and leave the door open slightly to avoid possible formation of condensation, mold, or odors.

➤ **Moving Your Wine Cooler**

- Remove all the bottles.
- Securely tape down all loose items inside your wine cooler.
- Turn the leveling screws up to the base to avoid damage.
- Tape the doors shut.
- Be sure the wine cooler stays in the upright position during transportation.

PROBLEMS WITH YOUR WINE COOLER?

You can solve many common wine cooler problems easily, saving you the cost of a possible service call. Try the suggestions below to see if you can solve the problem before calling the servicer.

TROUBLESHOOTING GUIDE

PROBLEM	POSSIBLE CAUSE
Wine cooler does not operate.	Not plugged in. The circuit breaker tripped or blown fuse.
Wine cooler is not cold enough.	Check to be sure the temperature control setting. External environment may require a higher setting. The door is opened too often. The door is not closed completely. The door gasket does not seal properly. The wine cooler does not have the correct clearances.
Compressor turns on and off frequently	The room temperature is hotter than normal. A large amount of contents has been added to the wine cooler. The door is opened too often. The door is not closed completely. The temperature control is not set correctly. The door gasket does not seal properly. The wine cooler does not have the correct clearances.
The light does not work.	The home circuit breaker or fuse has tripped. The wine cooler is unplugged. The bulb has burned out(see maintenance section for the replacement procedure). The switch is in the "OFF" position.

Vibrations.	Check to assure that the wine cooler is level.
The wine cooler seems to make too much noise.	The rattling noise may come from the flow of the refrigerant, which is normal. As each cycle ends, you may hear gurgling sounds caused by the flow of refrigerant in your wine cooler. Contraction and expansion of the inside walls may cause popping and crackling noises. The wine cooler is not level.
The door will not close properly.	The wine cooler is not level. The doors were reversed and not properly installed. The gasket is dirty. The shelves are out of position.

SERVICE FOR YOUR APPLIANCE

We are proud of our customer service organization and the network of professional service technicians that provide service on your Avanti appliances. With the purchase of your Avanti appliance, you can have the confidence that if you ever need additional information or assistance, the Avanti Products Customer Service team will be here for you. Just call us toll-free.

AVANTI PRODUCTS CUSTOMER SERVICES

Product Information 800-323-5029	Whatever your questions are about our products, help is available.
Part Orders 800-220-5570	You may order parts and accessories that will be delivered directly to your home. You may order these items by personal check, money order, Master Card, or Visa.
In-Home Repair Service 800-220-5570	An Avanti Products authorized service center will provide expert repair service, scheduled at a time that is convenient for you. Our trained servicers know your appliance inside and out.

**YOUR Avanti Products
WARRANTY**

Staple your sales receipt here. Proof of original purchase date is needed to obtain service under warranty.

**WHAT IS COVERED
LIMITED ONE-YEAR
WARRANTY**

For one year from the date of purchase by the original owner, Avanti Products will, at its option, repair or replace any part of the appliance which proves to be defective in material or workmanship under normal use. During this period Avanti Products will provide all parts and labor necessary to correct such defects free of charge, so long as the appliance has been installed and operated in accordance with the written instructions in this manual. In rental or commercial use, the warranty period is 90 days. All Avanti appliances of 3.5 cubic foot capacity or less must be brought/sent to the applicable service shop for repair.

**LIMITED SECOND THROUGH
FIFTH YEAR WARRANTY**

For the second through the fifth year from date of original purchase, Avanti Products will provide a replacement compressor free of charge due to failure. You are responsible for the service labor and freight charges. In rental or commercial use, the limited compressor warranty is one year and nine months. Cost to move the appliance to the servicers shop and back to the user's home, as may be required, are the user's responsibility.

WHAT IS NOT COVERED

- Content losses of food due to spoilage.
- Incidental or consequential damages.
- Parts and labor costs for the following will not be considered as warranty:
 - Evaporator doors, door springs, and/or frames.
 - Inner door panels, door shelves, door rails, and/or door supports.
 - Chest appliance lid liners.
 - Vegetable crispers.
 - Light bulbs and/or plastic housing.
 - Plastic cabinet liners.
 - Punctured evaporator that voids the warranty on the complete sealed system.
- Repairs performed by unauthorized servicers.
- Service calls that do not involve defects in material or workmanship such as customer education, door reversal, or proper installation.
- Service calls that are related to external problems, such as abuse, misuse, inadequate electrical power, accidents, fire, floods, acts of God.
- Replacement of house fuses or resetting circuit breakers.
- Failure of the product if it is used for other than its intended purpose.
- This warranty does not apply outside the Continental USA.

WIRING DIAGRAM

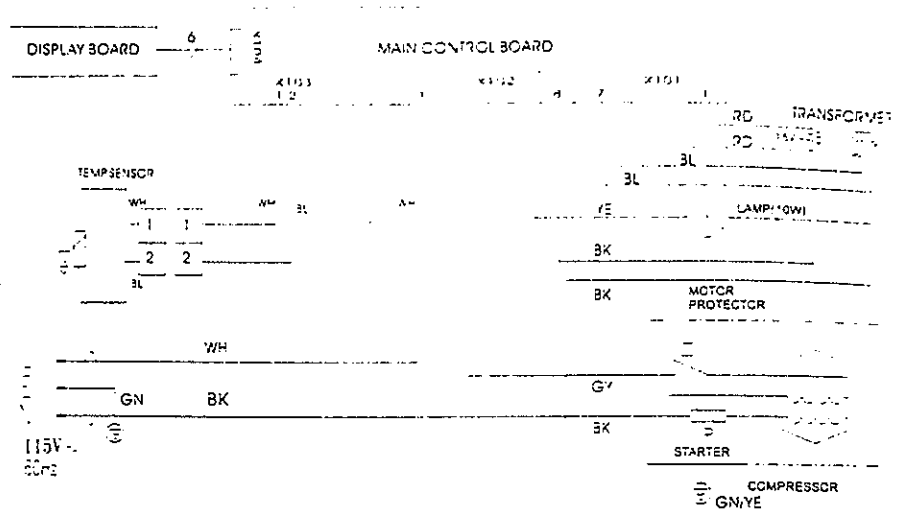

COOLING SYSTEM

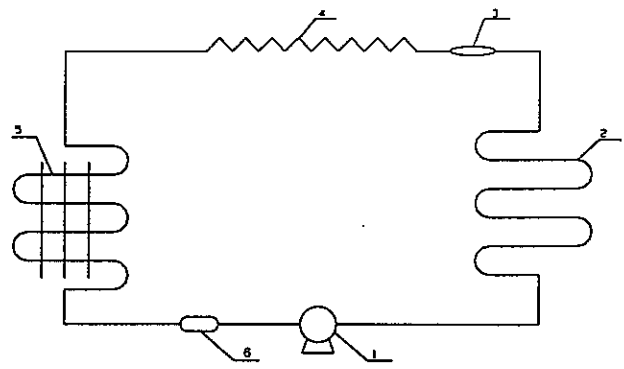

- 1. Compressor
- 2. Condenser
- 3. Filter and Drier
- 4. Capillary
- 5. Evaporator
- 6. Accumulator

PRECAUCIONES

No guarde alimentos en el refrigerador de vinos ya que la temperatura no es lo suficientemente baja para que los alimentos se preserven en buen estado.

La parte externa de la puerta de vidrio puede mostrar signos de humedad durante los meses de verano o en áreas de alta humedad, esto es el resultado natural de la condensación.

INSTRUCCIONES PARA LA INSTALACION

1. Seleccione un lugar donde el piso sea fuerte y esté nivelado. Si la unidad no está nivelada, ajuste las patas niveladoras delanteras.
2. Esta unidad puede ser empotrada. Asegúrese que quede media pulgada (1 centímetro) de distancia a cada lado en la parte trasera y superior entre la unidad y la pared.
3. No instale la unidad donde la temperatura sea menor a 65°F (18°C).
4. No instale la unidad cerca de una fuente de calor. Evite los rayos directos del sol.

Después de colocar la unidad en el lugar deseado y cada vez que la cambie de lugar, espere por lo menos 30 minutos antes de enchufar la unidad al tomacorriente. El refrigerante interno debe de asentarse después que la unidad ha sido movida.

USANDO SU REFRIGERADOR DE VINOS

Le recomendamos que instale su refrigerador de vinos en un lugar donde la temperatura esté entre los 72° a 78° Fahrenheit. Si la temperatura ambiental es mayor o menor que la temperatura recomendada, el funcionamiento de la unidad podría ser afectado. Por ejemplo si mantiene la unidad en condiciones de calor o frío extremo, puede ocasionar que la temperatura interna fluctúe y que no se alcance el rango de 45° a 65° Fahrenheit.

La luz interior se controla manualmente y no funciona al abrir ni cerrar la puerta. Para encender la luz presione el botón que enseña un "bombillo". Si deja encendida la luz interior, la temperatura será más alta.

TEMPERATURA RECOMENDADA PARA ENFRIAR EL VINO

Vino tinto:	59-65°F
Vino blanco / seco	49-56°F
Vino blanco / espumante	45-49°F
Vino rosé / Zinfandel	49-51°F

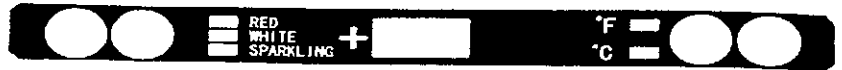

Estas temperaturas pueden fluctuar dependiendo si la luz interna está encendida o si las botellas son colocadas en la sección superior, media o inferior.



> OPERACION

El enfriador de vino viene programado de fábrica. Si en su mayoría Usted solamente guarda vinos blancos, presione el botón designado "white" o blanco y la vinera mantendrá una temperatura entre 10° y 11° C. La pantalla digital se alumbrará en color verde.

Al presionar el botón marcado "red" o rojo, la vinera mantendrá una temperatura entre 14° y 16° C. La pantalla digital se alumbrará en color rojo. Presione el botón marcado "sparkling" o espumoso y la vinera mantendrá una temperatura entre 7° y 9° C. El indicador (pantalla digital) se alumbrará en color amarillo.

Al conectar su vinera por primera vez, puede haber una variante de varios grados entre la temperatura seleccionada y la indicada en la pantalla digital. Esto es normal y es debido al largo período de activación y desactivación. También hay una variante de 6° a 8° F entre los estantes superiores e inferiores de la vinera, de forma que si usted quiere combinar una mezcla de vinos rojos (tintos) y blancos, deberá colocar las botellas de vino blanco en el estante inferior y las de vino tinto en el estante superior. Si usted ha programado el enfriador de vino a 15° por ejemplo, podría aumentarlo oprimiendo el botón marcado  sucesivamente o podría bajarlo oprimiendo el botón marcado .

También puede cambiar de grados centígrados a Fahrenheit, oprimiendo el botón marcado C/F° . F° aparecerá en la pantalla de color rojo, C° aparecerá en la pantalla de color amarillo.

➤ **ESTANTES:**

Los estantes están cromados. Para acomodar varios tamaños de botella los estantes se deslizan hacia afuera y pueden moverse hacia arriba o hacia abajo en cualquiera de los rieles moldeados a los lados.

➤ **CERRADURA:**

Por razones de seguridad, su vinera está equipada con una cerradura llave.

Para eliminar el riesgo que un niño quede atrapado accidentalmente, la puerta no se cierra con seguro hasta que la llave sea removida.

Dos llaves son incluidas con la cerradura.

PRINTED IN CHINA

Free Manuals Download Website

<http://myh66.com>

<http://usermanuals.us>

<http://www.somanuals.com>

<http://www.4manuals.cc>

<http://www.manual-lib.com>

<http://www.404manual.com>

<http://www.luxmanual.com>

<http://aubethermostatmanual.com>

Golf course search by state

<http://golfingnear.com>

Email search by domain

<http://emailbydomain.com>

Auto manuals search

<http://auto.somanuals.com>

TV manuals search

<http://tv.somanuals.com>