

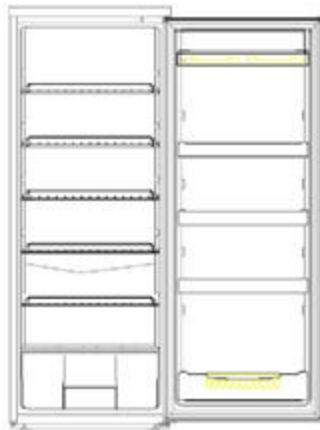

INSTRUCTION MANUAL MANUAL DE INSTRUCCIONES

Model Number / No. de Modelo: **BCA886**

**REFRIGERATOR
(REFRIGERADOR)**



BEFORE USE, PLEASE READ AND FOLLOW ALL SAFETY RULES AND OPERATING INSTRUCTIONS.

La sección en español empieza en la página 17.

Avanti has a policy of continuous improvement on its products and reserves the right to change materials and specifications without notice.

Avanti Products, A Division of the Mackle Co., Inc.
P.O. Box 520604- Miami, Florida 33152
www.avantiproducts.com

REFRIGERATOR SAFETY

Your safety and the safety of others are very important.

We have provided many important safety messages in this manual for your appliance. Always read and obey all safety messages.



This is the Safety Alert Symbol. This symbol alerts you to potential hazards that can kill or injure you and others. All safety messages will follow the Safety Alert Symbol and either the words "DANGER", "WARNING" or "CAUTION".



Danger means that failure to heed this safety statement may result in severe personal injury or death.



Warning means that failure to heed this safety statement may result in extensive product damage, serious personal injury, or death.



Caution means that failure to heed this safety statement may result in minor or moderate personal injury, property or equipment damage.

All safety messages will alert you to know what potential hazard is, tell you how to reduce the chance of injury, and let you know what can happen if the instructions are not followed.

IMPORTANT SAFEGUIDES



Before the refrigerator is used, it must be properly positioned and installed as described in this manual, so read the manual carefully. To reduce the risk of fire, electrical shock or injury when using the refrigerator, follow basic precaution, including the following:

DANGER

- ? Plug into a grounded 3-prong outlet, do not remove grounding prong, do not use an adapter, and do not use an extension cord.
- ? It is recommended that a separate circuit, serving only your refrigerator be provided. Use receptacles that cannot be turned off by a switch or pull chain.
- ? Never clean refrigerator parts with flammable fluids. These fumes can create a fire hazard or explosion. And do not store or use gasoline or other flammable vapors and liquids in the vicinity of this or any other appliance. The fumes can create a fire hazard or explosion.
- ? Before proceeding with cleaning and maintenance operations, make sure the power line of the unit is disconnected.
- ? Do not connect or disconnect the electric plug when your hands are wet.
- ? Unplug the refrigerator or disconnect power before cleaning or servicing. Failure to do so can result in electrical shock or death.
- ? Do not attempt to repair or replace any part of your refrigerator unless it is specifically recommended in this manual. All other servicing should be referred to a qualified technician.

WARNING

FOLLOW WARNING CALL OUTS BELOW ONLY WHEN APPLICABLE TO YOUR MODEL

- ? Use two or more people to move and install refrigerator. Failure to do so can result in back or other injury.
- ? To ensure proper ventilation for your refrigerator, the front of the unit must be completely unobstructed. Choose a well-ventilated area with temperatures above 60°F (16°C) and below 90°F (32°C). This unit must be installed in an area protected from the element, such as wind, rain, water spray or drips.
- ? The refrigerator should not be located next to ovens, grills or other sources of high heat.
- ? The refrigerator must be installed with all electrical, water and drain connections in accordance with state and local codes. A standard electrical supply (115 V AC only, 60 Hz), properly grounded in accordance with the National Electrical Code and local codes and ordinances is required.
- ? Do not kink or pinch the power supply cord of refrigerator.
- ? The fuse (or circuit breaker) size should be 15 amperes.
- ? It is important for the refrigerator to be leveled in order to work properly. You may need to make several adjustments to level it.
- ? All installation must be in accordance with local plumbing code requirements.
- ? Make certain that the pipes are not pinched or kinked or damaged during installations.
- ? Check for leaks after connection.
- ? Never allow children to operate, play with or crawl inside the refrigerator.
- ? Although the unit has been tested at the factory, due to long-term transit and storage, the first batch of cubes must be discarded.
- ? Do not use solvent-based cleaning agents or abrasives on the interior. These cleaners may damage or discolor the interior.
- ? Do not use this apparatus for other than its intended purpose.

REGISTRATION INFORMATION

Thank you for purchasing this fine Avanti product. Please fill out this form and return it within 100 days from the date of purchase and receive these important benefits to the following address:

Avanti Products, A Division of The Mackle Co., Inc.
P.O.Box 520604 – Miami, Florida 33152

✍ **Protect your product:**

We will keep this form, with the model number and date of purchase of your new Avanti product on file to help you refer to this information in the event of an insurance claim such as fire or theft.

✍ **Promote better products:**

We value your input. Your responses will help us develop products designed to best meet your future needs.

------(detach here)-----
Avanti Registration Form

Name	Model #	Serial #
Address	Date Purchased	Store/Dealer Name
City	State	Zip
Area Code	Occupation	
Phone Number		
<u>Did You Purchase An Additional Warranty:</u>		
<input type="checkbox"/> Extended <input type="checkbox"/> Food Loss <input type="checkbox"/> None		
<u>Reason For Choosing This Avanti Product:</u>		
Please indicate the most important factors that influenced your decision to purchase this product.		
<input type="checkbox"/> Price		
<input type="checkbox"/> Product Features		
<input type="checkbox"/> Avanti Reputation		
<input type="checkbox"/> Product Quality		
<input type="checkbox"/> Salesperson Recommendation		
<input type="checkbox"/> Friend/Relative Recommendation		
<input type="checkbox"/> Warranty		
<input type="checkbox"/> Other _____		
<u>As Your Primary Residence, Do You:</u>		
<input type="checkbox"/> Own <input type="checkbox"/> Rent		
<u>Your Age:</u>		
<input type="checkbox"/> under 18 <input type="checkbox"/> 18-25 <input type="checkbox"/> 26-30		
<input type="checkbox"/> 31-35 <input type="checkbox"/> 36-50 <input type="checkbox"/> over 50		
<u>Marital Status:</u>		
<input type="checkbox"/> Married <input type="checkbox"/> Single		
<u>Is This Product Used In The:</u>		
<input type="checkbox"/> Home <input type="checkbox"/> Business		
<u>How Did You Learn About This Product:</u>		
<input type="checkbox"/> Advertising		
<input type="checkbox"/> In Store Demo <input type="checkbox"/> Personal Demo		
<input type="checkbox"/> Other _____		
Comments _____		

HELP US HELP YOU...

Read this guide carefully.

It is intended to help you operate and maintain your new unit properly.

Keep it handy to answer your questions. If you don't understand something or you need more assistance, please call:

**Avanti Customer Service
800-220-5570**

Keep proof of original purchase date (such as your sales slip) with this guide to establish the warranty period.

CAUTION:

THIS UNIT IS NOT DESIGNED FOR THE STORAGE OF MEDICINE OR OTHER MEDICAL PRODUCTS.

Write down the model and serial numbers.

You'll find them on a plate located on the rear outside wall of the unit.

Please write these numbers here:

Date of Purchase

Model Number

Serial Number

Use these numbers in any correspondence or service calls concerning your unit.

If you received a damaged unit, immediately contact the dealer (or builder) that sold you the unit.

Save time and money. Before you call for service, check the Troubleshooting Guide. It lists causes of minor operating problems that you can correct yourself.

IF YOU NEED SERVICE

We're proud of our service and want you to be pleased. If for some reason you are not happy with the service you receive, here are some steps to follow for further assistance.

FIRST, contact the people who serviced your unit. Explain why you are not pleased. In most cases, this will solve the problem.

NEXT, if you are still not pleased, write all the details, including your telephone number, and send it to:

**Customer Service
Avanti Products
10880 NW 30 Street
Miami, FL 33172 USA**

PARTS & FEATURES

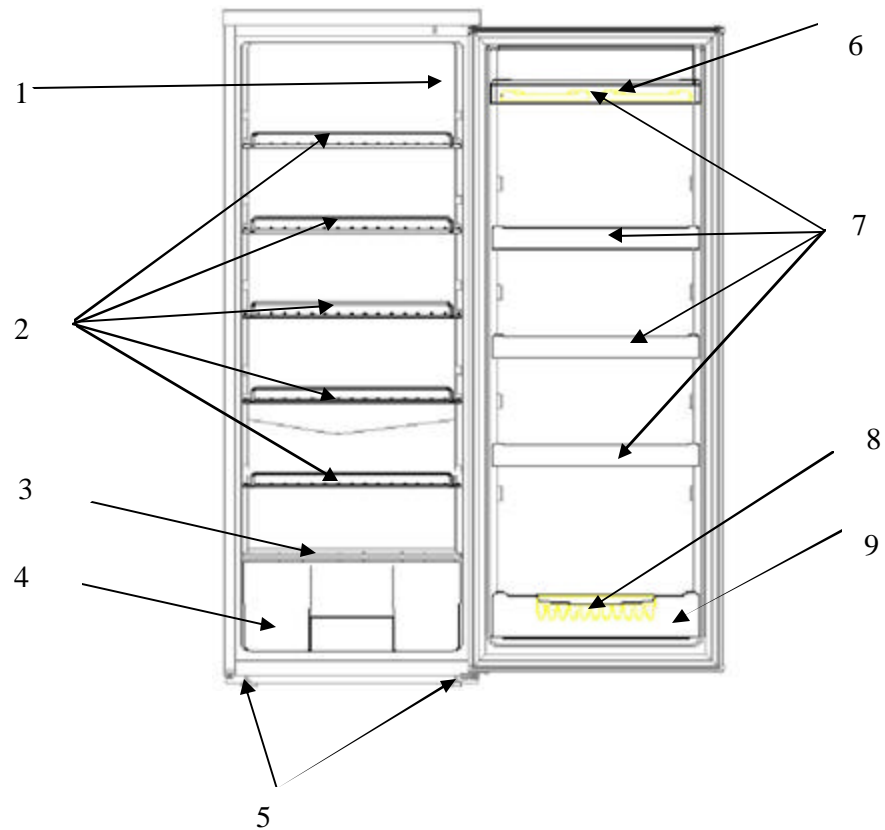



- 1 Temperature Control and Light**
- 2 Glass Shelves (5)**
- 3 Glass Crisper Cover**
- 4 Vegetable Crisper**
- 5 Leveling Legs (2)**
- 6 Egg Trays (2)**
- 7 Door Bins (4)**
- 8 Bottle Retainer**
- 9 Bottle Door Bin**

TABLE OF CONTENTS

Refrigerator Safety	3
Important Safeguides	4
Registration Information and Registration Card	5
Help Us Help You	7
Parts and Features	8
Important Safety Instructions	10
Installation Instructions	10
Before Using Your Appliance	10
Installation of Your Appliance	10
Electrical Connection	11
Reversing the Door Swing of Your Appliance	11
Operating Your Appliance	12
Temperature Control	12
Care and Maintenance	12
Cleaning Your Appliance	12
Power Failure	12
Vacation Time	12
Moving Your Appliance	12
Energy Saving Tips	13
Changing the Light bulb	13
Troubleshooting Guide	14
Service for Your Appliance	15
Your Avanti Products Warranty	16
Wiring Diagram	17
Instrucciones en Español	18-19

IMPORTANT SAFETY INSTRUCTIONS

 WARNING 	To reduce the risk of fire, electrical shock, or injury when using your appliance, follow these basic precautions:
<ul style="list-style-type: none">? Read all instructions before using the appliance.? DANGER or WARNING: Risk of child entrapment. Child entrapment and suffocation are not problems of the past. Junked or abandoned refrigerator-freezers are still dangerous. . . even if they will “just sit in the garage a few days.”? Before you throw away your old appliance: Take off the doors. Leave the shelves in place so that children may not easily climb inside.? Never allow children to operate, play with, or crawl inside the appliance.? Never clean the appliance parts with flammable fluids. The fumes can create a fire hazard or explosion.? Do not store or use gasoline or any other flammable vapors and liquids in the vicinity of this or any other appliance. The fumes can create a fire hazard or explosion. <p style="text-align: center;">-Save these instructions-</p>	

INSTALLATION INSTRUCTIONS

Before Using Your Appliance

- ? Remove the exterior and interior packing.
- ? Check to be sure you have all of the following parts:
 - ? 1 Crisper
 - ? 1 Glass Crisper Cover
 - ? 5 Glass Shelves
 - ? 5 Door Bins
 - ? 2 Egg Trays
 - ? 1 Bottle Retainer
 - ? 1 Instruction Manual
- ? Before connecting the unit to the power source, let it stand upright for approximately 2 hours. This will reduce the possibility of a malfunction in the cooling system from handling during transportation.
- ? Clean the interior surface with lukewarm water using a soft cloth.

Installing Your Appliance

- ? Place your unit on a floor that is strong enough to support the unit when it is fully loaded. To level your unit, adjust the leveling legs at the bottom of the unit.
- ? Allow space between the back and sides of the unit, which allows the proper air circulation to cool the compressor and condenser.
- ? Locate the unit away from direct sunlight and sources of heat (stove, heater, radiator, etc.). Direct sunlight may affect the acrylic coating and heat sources may increase electrical consumption. Extreme cold ambient temperatures may also cause the unit not to perform properly.
- ? Avoid locating the unit in moist areas.
- ? Do not under any circumstances cut or remove the third (ground) prong from the power cord. Any questions concerning power and/or grounding should be directed toward a certified electrician or an authorized Avanti Products service center.
- ? After plugging the appliance into a wall outlet, allow the unit to cool down for 2-3 hours before placing food in the refrigerator compartments.

[Electrical Connection](#)

Warning

Improper use of the grounded plug can result in the risk of electrical shock. If the power cord is damaged, have it replaced by an authorized Avanti Products service center.

This unit should be properly grounded for your safety. The power cord of this unit is equipped with a three-prong plug which mates with standard three prong wall outlets to minimize the possibility of electrical shock.

Do not under any circumstances cut or remove the third ground prong from the power cord supplied. For personal safety, this appliance must be properly grounded.

This unit requires a standard 115/120 Volt AC ~/60Hz electrical outlet with three-prong ground. Have the wall outlet and circuit checked by a qualified electrician to make sure the outlet is properly grounded. When a standard 2-prong wall outlet is encountered, it is your responsibility and obligation to have it replaced with a properly grounded 3-prong wall outlet.

The cord should be secured behind the unit and not left exposed or dangling to prevent accidental injury.

The unit should always be plugged into its own individual electrical outlet which has a voltage rating that matches the rating label on the appliance. This provides the best performance and also prevent overloading house wiring circuits that could cause a fire hazard from overheated. Never unplug the unit by pulling the power cord. Always grip the plug firmly and pull straight out from the receptacle. Repair or replace immediately all power cords that have become frayed or otherwise damaged. Do not use a cord that shows cracks or abrasion damage along its length or at either end. When moving the unit, be careful not to damage the power cord.

[Extension Cord](#)

Because of potential safety hazards under certain conditions, it is strongly recommended that you do not use an extension cord with this unit. However, if you must use an extension cord it is absolutely necessary that it be a UL/CUL-Listed, 3-wire grounding type appliance extension cord having a grounding type plug and outlet and that the electrical rating of the cord be 115 volts and at least 10 amperes.

[Reversing the Door Swing of Your Appliance](#)

This appliance has the capability of the door opening from either the left or right side. The unit is delivered to you with the door opening from the left side. Should you desire to reverse the opening direction, please call customer service for reversal instructions.

OPERATING YOUR APPLIANCE

Setting the Temperature Control

- ? Your unit has only one control for regulating the temperature in the compartment. The temperature control is located on the upper right hand side of the compartment.
- ? The first time you turn the unit on, set the temperature control to "5."
- ? The range of the temperature control is from position "0" to "5". After 24 to 48 hours, adjust the temperature control to the setting that best suites your needs. The setting of "3" should be appropriate for home or office use.
- ? To turn the appliance off, turn the temperature control to "0".

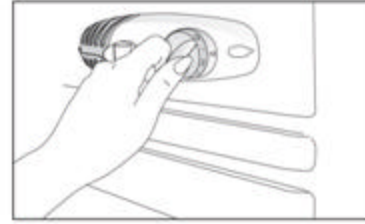

NOTE:

- ✗ Turning the temperature control to "0" position stops the cooling cycle but does not shut off the power to the unit
- ✗ If the unit is unplugged, has lost power, or is turned off, you must wait 3 to 5 minutes before restarting the unit. If you attempt to restart before this time delay, the unit will not start.

Interior Light

When you open the door the light will be ON automatically. When you close the door the light will turn OFF automatically.

CARE AND MAINTENANCE

Cleaning Your Appliance

- ? Turn the temperature control to "0", unplug the unit, and remove the food, shelves, and trays.
- ? Wash the inside surfaces with a warm water and baking soda solution. The solution should be about 2 tablespoons of baking soda to a quart of water.
- ? Wash the shelves and trays with a mild detergent solution.
- ? The outside of the unit should be cleaned with mild detergent and warm water.
- ? Wring excess water out of the sponge or cloth before cleaning the area of the controls, or any electrical parts.
- ? Wash the outside cabinet with warm water and mild liquid detergent. Rinse well and wipe dry with a clean soft cloth.

CAUTION:

Failure to unplug the unit could result in electrical shock or personal injury.

Power Failure

Most power failures are corrected within a few hours and should not affect the temperature of your unit if you minimize the number of times the door is opened. If the power is going to be off for a longer period of time, you need to take the proper steps to protect your food.

Vacation Time

- ? **Short vacations:** Leave the unit operating during vacations of less than three weeks.
- ? **Long vacations:** If the appliance will not be used for several months, remove all food and unplug the power cord. Clean and dry the interior thoroughly. To prevent odor and mold growth, leave the door open slightly: blocking it open if necessary.

Moving Your Appliance

- ? Remove all the food.
- ? Securely tape down all loose items inside your unit.

- ? Turn the leveling screws up to the base to avoid damage.
- ? Tape the door shut.
- ? Be sure the unit stays secure in the upright position during transportation. Also protect the outside of unit with a blanket, or similar item.

Energy Saving Tips

- ? The unit should be located in the coolest area of the room, away from heat producing appliances, and out of the direct sunlight.
- ? Let hot foods cool to room temperature before placing into the unit. Overloading the unit forces the compressor to run longer.
- ? Be sure to wrap foods properly, and wipe containers dry before placing them into the unit. This cuts down on frost build-up inside the unit.
- ? Unit storage bin should not be lined with aluminum foil, wax paper, or paper toweling. Liners interfere with cold air circulation, making the unit less efficient.
- ? Organize and label food to reduce door openings and extended searches. Remove as many items as needed at one time, and close the door as soon as possible.

Replacing Your Light Bulb

NOTE:

All parts removed must be saved to do the replacement of the light bulb.

Before removing the light bulb, either unplug the refrigerator or disconnect the electricity leading into the refrigerator at the main power supply. Failure to do so could result in electrical shock or personal injury.

- ? Unplug the AC power cord from the wall.
- ? Remove the screw with a Phillips screw driver.
- ? Remove the light bulb cover.
- ? Remove the bulb.
- ? Replace with a 10 watts bulb that is the same shape and size.
- ? Replace the light bulb cover and tighten screw.

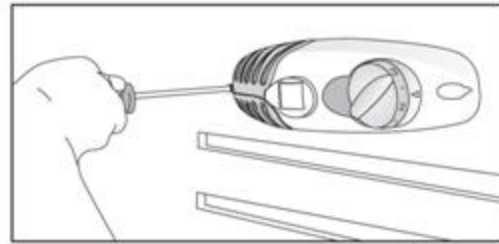

PROBLEMS WITH YOUR APPLIANCE

You can solve many common unit problems easily, saving you the cost of a possible service call. Try the suggestions below to see if you can solve the problem before calling the servicer.

TROUBLESHOOTING GUIDE

PROBLEM	POSSIBLE CAUSE
Unit does not operate.	Not plugged in. The circuit breaker tripped or a blown fuse. The unit temperature control is set at "0" position.
Turns on and off frequently.	The room temperature is hotter than normal. A large amount of food has been added to the unit. The door is opened too often. The door is not closed completely. The temperature control is not set correctly. The door gasket does not seal properly. The unit does not have the correct clearances. (5" on both sides and back of unit).
Vibrations.	Check to assure that the unit is level.
The unit seems to make too much noise.	The rattling noise may come from the flow of the refrigerant, which is normal. As each cycle ends, you may hear gurgling sounds caused by the flow of refrigerant in your unit. Contraction and expansion of the inside walls may cause popping and crackling noises. The unit is not level.
The door will not close properly.	The unit is not level. The door was reversed and not properly installed. The gasket is dirty or bent. The shelves, bins, or baskets are out of position.

SERVICE FOR YOUR APPLIANCE

We are proud of our customer service organization and the network of professional service technicians that provide service on your Avanti refrigerators. With the purchase of your Avanti unit, you can be confident that if you ever need additional information or assistance, the Avanti Products Customer Service team will be here for you. Just call us toll-free.

AVANTI PRODUCTS CUSTOMER SERVICES

Product Information 800-323-5029	Whatever your questions are about our products, help is available.
Part Orders 800-220-5570	You may order parts and accessories that will be delivered directly to your home, by personal check, money order, Master Card, or Visa.
In-Home Repair Service 800-220-5570	An Avanti Products authorized service center will provide expert repair service, scheduled at a time that is convenient for you. Our trained servicers know your refrigerator inside and out.

YOUR Avanti Products WARRANTY

Staple your sales receipt here. Proof of original purchase date is needed to obtain service under warranty.

WHAT IS COVERED
LIMITED ONE-YEAR
WARRANTY

For one year from the date of purchase by the original owner, Avanti Products will, at its option, repair or replace any part of the unit, which proves to be defective in material or workmanship under normal use.

During this period Avanti Products will provide all parts and labor necessary to correct such defects free of charge, so long as the unit has been installed and operated in accordance with the written instructions in this manual. In rental or commercial use, the warranty period is 90 days. All Avanti Appliances of 3.5 cubic feet capacity or less must be brought/sent to the appliance service shop for repair.

LIMITED SECOND THROUGH
FIFTH YEAR WARRANTY

For the second through the fifth year from date of original purchase, Avanti Products will provide a replacement compressor free of charge due to a failure. You are responsible for the service labor and freight charges. In rental or commercial use, the limited compressor warranty is one year and nine months. Cost to move the unit to the servicers' shop and back to the user's home, as may be required, are the user's responsibility.

WHAT IS NOT COVERED

- ? Content losses of food due to spoilage.
- ? Incidental or consequential damages.
- ? Parts and labor costs for the following will not be considered as warranty:
 - ? Evaporator doors, door springs, and/or frames.
 - ? Inner door panels, door shelves, door rails, and/or door supports.
 - ? Chest refrigerator lid liners.
 - ? Vegetable crispers.
 - ? Light bulbs and/or plastic housing.
 - ? Plastic cabinet liners.
 - ? Punctured evaporator that voids the warranty on the complete sealed system.
- ? Repairs performed by unauthorized servicers.
- ? Service calls that do not involve defects in material or workmanship such as customer education, door reversal, or proper installation.
- ? Service calls that are related to external problems, such as abuse, misuse, inadequate electrical power, accidents, fire, floods, or acts of God.
- ? Surcharges including, but not limited to, any after hour, weekend, or holiday service calls, tolls ferry trip charges, or mileage expenses for service calls to remote areas, including the State of Alaska.
- ? Replacement of house fuses or resetting circuit breakers.
- ? Failure of the product if it is used for other than its intended purpose.
- ? This warranty does not apply outside the Continental USA.

WIRING DIAGRAM

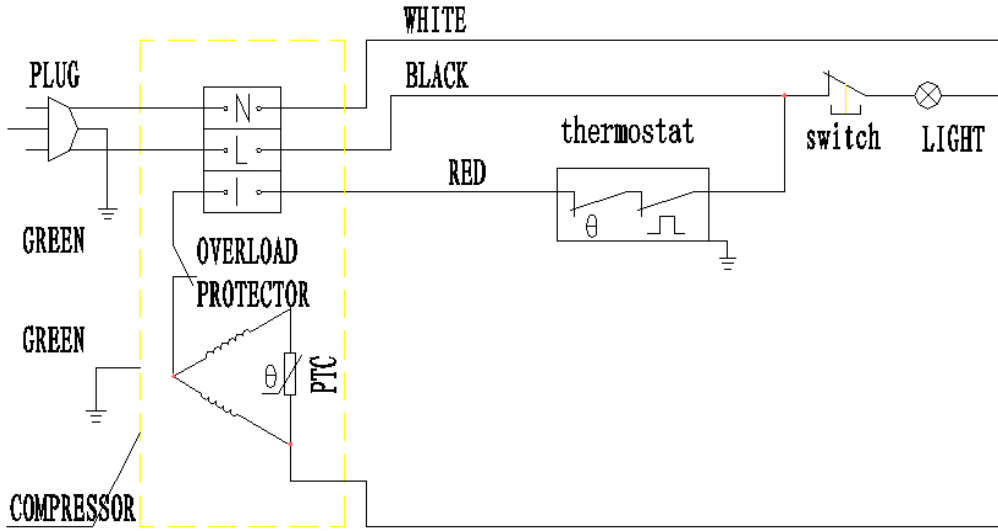

INSTRUCCIONES EN ESPAÑOL

INSTALACION

Retire los accesorios de empaque (plásticos protectores, cartón y tiras engomadas). Limpie el exterior con un trapo suave y seco, y el interior con un trapo húmedo y tibio.

UBICACION

1. Seleccione un lugar con un piso firme y nivelado.
2. Su refrigerador requiere ventilación. Deje un espacio mínimo hacia arriba y espacio suficiente en el respaldo para permitir la circulación de aire.
3. Evite luz directa del sol o calor. La luz directa del sol puede afectar la capa de pintura. Las fuentes de calor en su proximidad causarán un consumo mayor de electricidad.
4. Para un mejor desempeño, nivele el refrigerador utilizando las patas ajustables o tornillos niveladores. Para verificar el nivel, abra la puerta hasta la mitad, debe regresar sola.

INSTRUCCIONES PARA LA CONEXION A TIERRA

Este aparato electrodoméstico debe estar conectado a tierra. En caso de un cortocircuito eléctrico, la conexión a tierra reduce el riesgo de choque eléctrico proporcionando un cable de escape para la corriente eléctrica. Este aparato viene equipado con un cordón que posee un cable a tierra con un enchufe de conexión a tierra. Este enchufe debe estar conectado en un tomacorriente instalado correctamente y conectado a tierra.

ADVERTENCIA

El uso inadecuado del enchufe de conexión a tierra puede resultar en un riesgo de choque eléctrico. Consulte con un electricista si no comprende bien las instrucciones de conexión a tierra o si existe alguna duda sobre si el aparato está conectado a tierra correctamente.

NO USE UN CORDON DE EXTENSION ELECTRICA

Use un tomacorriente de pared exclusivo. No conecte su refrigerador a cordones de prolongación eléctrica o junto a cualquier otro electrodoméstico en el mismo tomacorriente de pared.

COMO AJUSTAR EL CONTROL DE TEMPERATURA

Su unidad tiene un solo control para regular la temperatura, este control se encuentra localizado en la parte superior derecha del compartimiento.

Al conectar y encender su unidad, asegúrese de rotar el control de temperatura hacia la posición de "6".

Este control de temperatura puede variar desde "0" hasta la posición "5", después de haberse mantenido en la posición "5" por 24 o 48 horas aproximadamente, regrese el control de temperatura para ajustarlo a la posición que más se ajuste a sus necesidades, por ejemplo la posición "3" sería apropiada para usar su unidad en su hogar u oficinas.

Para apagar su unidad, simplemente rote el control de temperatura hacia la posición de "0".

Nota:

Rotando el control de temperatura hacia la posición de "0", Usted solamente apaga el ciclo de enfriamiento, pero no desconecta su unidad de la fuente de corriente.

Si la unidad es desconectada de la pared o sufre una interrupción de electricidad Usted siempre debe esperar por un aproximado de 3 a 5 minutos para poder encenderla de nuevo, de no hacerlo así, su unidad no comenzará a funcionar.

ADVERTENCIA IMPORTANTE:

Un refrigerador vacío es una atracción muy peligrosa para los niños. Quite los sellos magnéticos, puertas o cerraduras de todo electrodoméstico que no esté en uso, es también aconsejable remover o quitar ambas puertas al momento de desechar su refrigerador.

OPERACION

Enchufe el cable a la toma de corriente, que debe ser 115-120v A/C, 10 AMP ó más. Para evitar vibraciones, este equipo debe estar bien nivelado. Para encender el refrigerador, gire el control de temperatura a la posición que corresponda al enfriamiento deseado.

CUIDADOS EN LOS PERIODOS DE AUSENCIA

- ? Para cortos períodos de ausencia (menos de 21 días) el congelador podrá quedar funcionando. Coloque el botón de control de temperaturas en la posición mínima.
- ? En períodos de ausencia más largos, se aconseja dejar el refrigerador limpio, sacando todo lo que tenga adentro del refrigerador. Haga el deshielo y la limpieza general, desconectándolo de la electricidad. También retire la bandeja del congelador, limpie bien y séquela internamente.
- ? Deje la puerta entreabierta para que penetre el aire y así evitar la formación de olores.

ECONOMIA DE ENERGIA

- ? Evite dejar por mucho tiempo la puerta abierta.
- ? Evite aperturas frecuentes de la puerta.
- ? Nunca coloque alimentos calientes dentro del refrigerador. Espere que estén a una temperatura ambiental.
- ? Coloque el botón de control de temperaturas en la posición adecuada.

SI USTED SE VA DE VACACIONES POR UN PERIODO DE 30 DIAS O MAS

- ≠ Saque todos los artículos del refrigerador-congelador.
- ? Desconecte el refrigerador del tomacorriente y limpie el refrigerador bien, incluyendo la bandeja del congelador.
- ? Deje la puerta abierta para evitar la formación de olores, condensación o moho.

SI USTED SE MUDA

- ? Desconecte el refrigerador del tomacorriente y limpie el refrigerador bien, incluyendo la bandeja del congelador.
- ? Saque todas las partes movibles y empaquételas para que no se muevan durante la transportación.
- ? Cierre la puerta del refrigerador y séllela con cinta adhesiva.
- ? Asegúrese que el refrigerador va parado durante el viaje y cúbralo con una frazada.

PRINTED IN CHINA

Free Manuals Download Website

<http://myh66.com>

<http://usermanuals.us>

<http://www.somanuals.com>

<http://www.4manuals.cc>

<http://www.manual-lib.com>

<http://www.404manual.com>

<http://www.luxmanual.com>

<http://aubethermostatmanual.com>

Golf course search by state

<http://golfingnear.com>

Email search by domain

<http://emailbydomain.com>

Auto manuals search

<http://auto.somanuals.com>

TV manuals search

<http://tv.somanuals.com>