

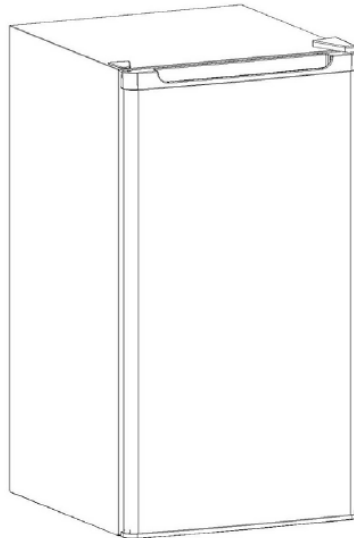

**INSTRUCTION MANUAL  
MANUAL DE INSTRUCCIONES**

**Model Numbers/ Nos. de Modelos: RM3250W-1 / RM3251B-1  
REFRIGERATOR  
(REFRIGERADOR)**



**CAUTION:**

**BEFORE USE, PLEASE READ AND FOLLOW ALL SAFETY RULES AND OPERATING INSTRUCTIONS.**

La sección en español empieza en la página 13.

Avanti has a policy of continuous improvement on its products and reserves the right to change materials and specifications without notice.

---

**Avanti Products, A Division of the Mackle Co., Inc.  
P.O. Box 520604 - Miami, Florida 33152  
[www.avantiproducts.com](http://www.avantiproducts.com)**

---

## Table of Contents

Refrigerator Safety	3
Important Safeguides	4
Help Us Help You	5
Parts and Features	6
Important Safety Instructions	7
Installation Instructions	7
Before Using Your Refrigerator	7
Installation of Your Refrigerator	7
Electrical Connection	8
Operating Your Appliance	8
Temperature Control	8
Using Your Ice Cube Tray	8
Defrosting Your Refrigerator	9
Reversing the Door of Your Refrigerator	9
Care and Maintenance	9
Cleaning Your Appliance	9
Maintenance of Your Appliance	9
Moving Your Refrigerator	9
Energy Saving Tips	9
Troubleshooting Guide	10
Service for Your Appliance	11
Wiring Diagram	11
Your Avanti Products Warranty	12
<u>Instrucciones en Español</u>	<u>13-14</u>
Registration Information and Registration Card	15

## REFRIGERATOR SAFETY

**Your safety and the safety of others are very important.**

We have provided many important safety messages in this manual for your appliance. Always read and obey all safety messages.



This is the Safety Alert Symbol. This symbol alerts you to potential hazards that can kill or injure you and others. All safety messages will follow the Safety Alert Symbol and either the words "DANGER", "WARNING" or "CAUTION".



Danger means that failure to heed this safety statement may result in severe personal injury or death.



Warning means that failure to heed this safety statement may result in extensive product damage, serious personal injury, or death.



Caution means that failure to heed this safety statement may result in minor or moderate personal injury, property or equipment damage.

All safety messages will alert you to know what the potential hazard is, tell you how to reduce the chance of injury, and let you know what can happen if the instructions are not followed.

## IMPORTANT SAFEGUIDES



Before the refrigerator is used, it must be properly positioned and installed as described in this manual, so read the manual carefully. To reduce the risk of fire, electrical shock or injury when using the refrigerator, follow basic precautions, including the following:

### **DANGER**

- Plug into a grounded 3-prong outlet, do not remove grounding prong, do not use an adapter, and do not use an extension cord.
- It is recommended that a separate circuit, serving only your refrigerator be provided. Use receptacles that cannot be turned off by a switch or pull chain.
- Never clean refrigerator parts with flammable fluids. These fumes can create a fire hazard or explosion. And do not store or use gasoline or other flammable vapors and liquids in the vicinity of this or any other appliance. The fumes can create a fire hazard or explosion.
- Before proceeding with cleaning and maintenance operations, make sure the power line of the unit is disconnected.
- Do not connect or disconnect the electric plug when your hands are wet.
- Unplug the refrigerator or disconnect power before cleaning or servicing. Failure to do so can result in electrical shock or death.
- Do not attempt to repair or replace any part of your refrigerator unless it is specifically recommended in this manual. All other servicing should be referred to a qualified technician.

### **WARNING**

FOLLOW WARNING CALL OUTS BELOW ONLY WHEN APPLICABLE TO YOUR MODEL

- Use two or more people to move and install refrigerator. Failure to do so can result in back or other injury.
- To ensure proper ventilation for your refrigerator, the front of the unit must be completely unobstructed. Choose a well-ventilated area with temperatures above 60°F (16°C) and below 90°F (32°C). This unit must be installed in an area protected from the elements, such as wind, rain, water spray or drips.
- The refrigerator should not be located next to ovens, grills or other sources of high heat.
- The refrigerator must be installed with all electrical, water and drain connections in accordance with state and local codes. A standard electrical supply (115 V AC only, 60 Hz), properly grounded in accordance with the National Electrical Code and local codes and ordinances is required.
- Do not kink or pinch the power supply cord of refrigerator.
- The fuse (or circuit breaker) size should be 15 amperes.
- It is important for the refrigerator to be leveled in order to work properly. You may need to make several adjustments to level it.
- All installation must be in accordance with local plumbing code requirements.
- Make certain that the pipes are not pinched or kinked or damaged during installation.
- Check for leaks after connection.
- Never allow children to operate, play with or crawl inside the refrigerator.
- Although the unit has been tested at the factory, due to long-term transit and storage, the first batch of cubes must be discarded.
- Do not use solvent-based cleaning agents or abrasives on the interior. These cleaners may damage or discolor the interior.
- Do not use this apparatus for other than its intended purpose.

---

## HELP US HELP YOU...

### Read this guide carefully.

It is intended to help you operate and maintain your new appliance properly.

Keep it handy to answer your questions. If you don't understand something or your need more help, please call:

**Avanti Customer Service  
800-220-5570**

Keep proof of original purchase date (such as your sales slip) with this guide to establish the warranty period.

### **CAUTION:**

**THIS APPLIANCE IS NOT  
DESIGNED FOR THE STORAGE  
OF MEDICINE OR OTHER  
MEDICAL PRODUCTS.**

### Write down the model and serial numbers.

You'll find them on a plate located on the inside left wall the appliance.

Please write these numbers here:

\_\_\_\_\_

Date of Purchase

\_\_\_\_\_

Model Number

\_\_\_\_\_

Serial Number

Use these numbers in any correspondence or service calls concerning your appliance.

If you received a damaged appliance, immediately contact the dealer (or builder) that sold you the appliance.

Save time and money. Before you call for service, check the Troubleshooting Guide. It lists causes of minor operating problems that you can correct yourself.

---

## IF YOU NEED SERVICE

We're proud of our service and want you to be pleased. If for some reason you are not happy with the service you receive, here are some steps to follow for further help.

FIRST, contact the people who serviced your appliance. Explain why you are not pleased. In most cases, this will solve the problem.

NEXT, if you are still not pleased, write all the details, including your telephone number, and send to:

**Customer Service  
Avanti Products  
10880 NW 30 Street  
Miami, FL 33172**

## PARTS & FEATURES

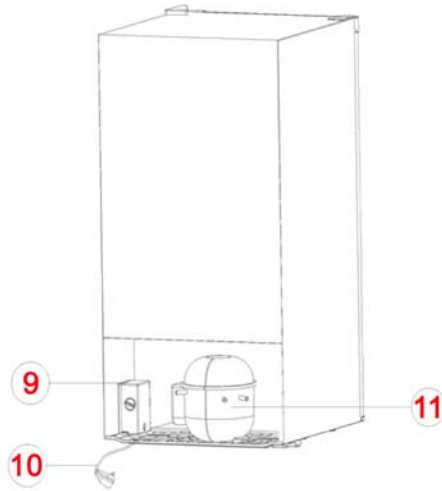
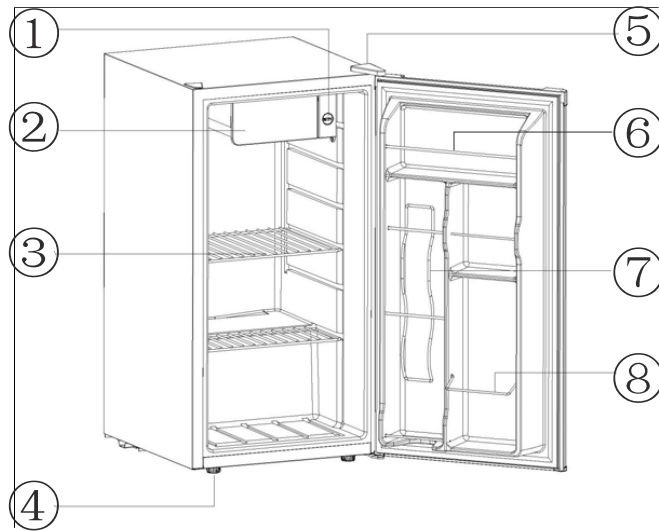

1. Temperature Control
2. Chiller Compartment
3. Storage Shelf (2)
4. Leveling Leg
5. Door Hinge (Reversible)
6. Door Bin
7. Beverage Can Dispenser (7 Can Capacity)
8. Bottle Rack
9. Temperature Control
10. Power Cord
11. Compressor

## Important Safety Instructions

<b>⚡WARNING⚡</b>	To reduce the risk of fire, electrical shock, or injury when using your refrigerator, follow these basic precautions:
<ul style="list-style-type: none"><li>• Read all instructions before using the refrigerator.</li><li>• <b>DANGER or WARNING:</b> Risk of child entrapment.</li><li>• <b>Before you throw away your old refrigerator or freezer:</b> Take off the doors. Leave the shelves in place so that children may not easily climb inside.</li><li>• Never allow children to operate, play with, or crawl inside the refrigerator.</li><li>• Never clean refrigerator parts with flammable fluids. The fumes can create a fire hazard or explosion.</li><li>• Do not store or use gasoline or any other flammable vapors and liquids in the vicinity of this or any other refrigerator. The fumes can create a fire hazard or explosion.</li></ul> <p style="text-align: center;">-Save these instructions-</p>	

### INSTALLATION INSTRUCTIONS

#### ➤ Before Using Your Refrigerator

- Remove the exterior and interior packing.
- Check to be sure you have all of the following parts:
  - 1 Ice cube tray
  - 2 Storage shelves (1 Large / 1 Small)
  - Instruction manual
- Before connecting the refrigerator to the power source, let it stand upright for approximately 2 hours. This will reduce the possibility of a malfunction in the cooling system from handling during transportation.
- Clean the interior surface with lukewarm water using a soft cloth.

#### ➤ Installation of Your Refrigerator

- This appliance is designed to be free standing only, and should not be recessed or built-in.
- Place your refrigerator on a floor that is strong enough to support the refrigerator when it is fully loaded. To level your refrigerator, adjust the front legs at the bottom of the refrigerator.
- Allow 5 inches of space between the back and sides of the refrigerator, which allows the proper air circulation to cool the compressor.
- Locate the refrigerator away from direct sunlight and sources of heat (stove, heater, radiator, etc.). Direct sunlight may affect the acrylic coating and heat sources may increase electrical consumption. Extreme cold ambient temperatures may also cause the refrigerator not to perform properly.
- Avoid locating the refrigerator in moist areas.
- Plug the refrigerator into an exclusive, properly installed-grounded wall outlet. Do not under any circumstances cut or remove the third (ground) prong from the power cord. Any questions concerning power and/or grounding should be directed toward a certified electrician or an authorized Avanti Products service center.
- After plugging the appliance into a wall outlet, allow the unit to cool down for 2-3 hours before placing food in the chiller or refrigerator compartment.

➤ **Electrical Connection**

**⚡ Warning ⚡**

Improper use of the grounded plug can result in the risk of electrical shock. If the power cord is damaged, have it replaced by an authorized Avanti Products service center.

This refrigerator should be properly grounded for your safety. The power cord of this refrigerator is equipped with a three-prong plug which mates with standard three prong wall outlets to minimize the possibility of electrical shock.

Do not under any circumstances cut or remove the third ground prong from the power cord supplied.

This refrigerator requires a standard 115/120a/c-volt/60Hz electrical outlet with three-prong ground.

The cord should be secured behind the refrigerator and not left exposed or dangling to prevent accidental injury.

Never unplug the refrigerator by pulling the power cord. Always grip the plug firmly and pull straight out from the receptacle.

Do not use an extension cord with this appliance. If the power cord is too short, have a qualified electrician or service technician install an outlet near the appliance

## OPERATING YOUR REFRIGERATOR

➤ **Setting the Temperature Control**

- To control the internal temperature, adjust the control dial according to the ambient temperature or purpose of use.
- The first time you turn the unit on, set the temperature control to "5."
- The range of the temperature control is from position "0 to 5." After 24 to 48 hours, adjust the temperature control to the setting that best suites your needs. The setting of "3" should be correct for home or office refrigerator use.

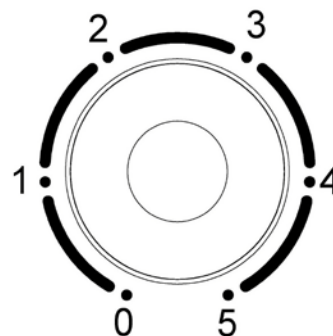

**NOTE:**

- If the unit is unplugged, has lost power, or turned off; you must wait 3 to 5 minutes before restarting the unit. If you attempt to restart before this time delay, the refrigerator will not start.

➤ **Use of the Ice Cube Trays**

- For your ice requirements, fill approximately  $\frac{3}{4}$  of the tray after washing it.
- If you want to make ice cubes quick, set thermostat to position "5".
- To release the ice cubes, hold the tray upside down and twist slightly at both ends until the pieces of ice fall.

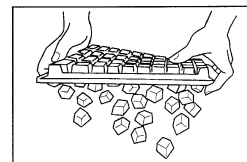



## CARE AND MAINTENANCE

### ➤ Defrosting Your Refrigerator

Defrost the refrigerator when the frost accumulated on the evaporator is about 5mm (1/5 inch) thick. Set the thermostat dial to "0" position. Remove frozen or perishable foods. Defrosting usually takes a few hours. After defrosting, return the thermostat dial to the desired position. To defrost quickly remove all foods from the refrigerator and leave the door open. Never use a knife or other metal instrument to scrape ice/frost from the evaporator.

### ➤ Reversing the Door Swing of Your Refrigerator

This appliance has the capability of the door opening from either the left or right side. The unit is delivered to you with the door opening from the left side. Should you desire to reverse the opening direction, please call service for reversal instructions.

### ➤ Cleaning Your Refrigerator

- Turn the temperature control to "0", unplug the refrigerator, and remove the food, shelves, and trays.
- Wash the inside surfaces with a warm water and baking soda solution. The solution should be about 2 tablespoons of baking soda to a quart of water.
- Wash the shelves and trays with a mild detergent solution.
- The outside of the refrigerator should be cleaned with mild detergent and warm water.
- Wring excess water out of the sponge or cloth before cleaning the area of the controls, or any electrical parts.
- Wash the outside cabinet with warm water and mild liquid detergent. Rinse well and wipe dry with a clean soft cloth.

### ➤ Vacation Time

- **Short vacations:** Leave the refrigerator operating during vacations of less than three weeks.
- **Long vacations:** If the appliance will not be used for several months, remove all food and unplug the power cord. Clean and dry the interior thoroughly. To prevent odor and mold growth, leave the door open slightly: blocking it open if necessary.

### ➤ Moving Your Refrigerator

- Remove all the food.
- Securely tape down all loose items inside your refrigerator.
- Turn the leveling screws up to the base to avoid damage.
- Tape the door shut.
- Be sure the refrigerator stays secure in the upright position during transportation. Also protect the outside of refrigerator with a blanket, or similar item.

### ➤ Energy Saving Tips

- The refrigerator should be located in the coolest area of the room, away from heat producing appliances, and out of the direct sunlight.
- Let hot foods cool to room temperature before placing in the refrigerator. Overloading the refrigerator forces the compressor to run longer.
- Be sure to wrap foods properly, and wipe containers dry before placing them in the refrigerator. This cuts down on frost build-up inside the refrigerator.
- Refrigerator storage bin should not be lined with aluminum foil, wax paper, or paper toweling. Liners interfere with cold air circulation, making the refrigerator less efficient.
- Organize and label food to reduce door openings and extended searches. Remove as many items as needed at one time, and close the door as soon as possible.

## PROBLEMS WITH YOUR REFRIGERATOR?

You can solve many common refrigerator problems easily, saving you the cost of a possible service call. Try the suggestions below to see if you can solve the problem before calling the servicer.

### TROUBLESHOOTING GUIDE

PROBLEM	POSSIBLE CAUSE
Refrigerator does not operate.	Not plugged in. The circuit breaker tripped or a blown fuse.
Turns on and off frequently.	The room temperature is hotter than normal. A large amount of food has been added to the refrigerator. The door is opened too often. The door is not closed completely. The temperature control is not set correctly. The door gasket does not seal properly. The refrigerator does not have the correct clearances.
Vibrations.	Check to assure that the refrigerator is level.
The refrigerator seems to make too much noise.	The rattling noise may come from the flow of the refrigerant, which is normal. As each cycle ends, you may hear gurgling sounds caused by the flow of refrigerant in your refrigerator. Contraction and expansion of the inside walls may cause popping and crackling noises. The refrigerator is not level.
The door will not close properly.	The refrigerator is not level. The door was reversed and not properly installed. The gasket is dirty. The shelves, bins, or baskets are out of position.

## SERVICE FOR YOUR REFRIGERATOR

We are proud of our customer service organization and the network of professional service technicians that provide service on your Avanti refrigerators. With the purchase of your Avanti refrigerator, you can have the confidence that if you ever need additional information or assistance, the Avanti Products Customer Service Team will be here for you. Just call us toll-free.

### AVANTI PRODUCTS CUSTOMER SERVICES

Product Information 800-323-5029	Whatever your questions are about our products, help is available.
Part Orders 800-220-5570	You may order parts and accessories that will be delivered directly to your home by personal check, money order, Master Card, or Visa.
In-Home Repair Service 800-220-5570	An Avanti Products authorized service center will provide expert repair service, scheduled at a time that is convenient for you. Our trained servicers know your refrigerator inside and out.

### WIRING DIAGRAM

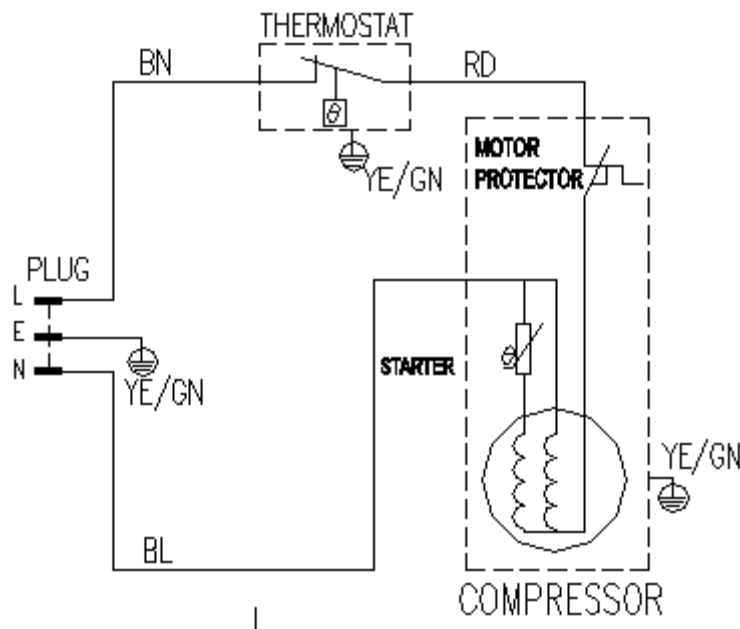

**WHAT IS COVERED**  
**LIMITED ONE-YEAR**  
**WARRANTY**

For one year from the date of purchase by the original owner, Avanti Products will, at its option, repair or replace any part of the refrigerator, which proves to be defective in material or workmanship under normal use. During this period Avanti Products will provide all parts and labor necessary to correct such defects free of charge, so long as the refrigerator has been installed and operated in accordance with the written instructions in this manual. In rental or commercial use, the warranty period is 90 days. Avanti Products will provide you with a reasonably similar replacement product that is either new or factory refurbished. All Avanti Appliances of 3.5 cubic foot capacity or less must be brought/sent to the appliance service shop for repair.

**LIMITED SECOND THROUGH**  
**FIFTH YEAR WARRANTY**

For the second through the fifth year from date of original purchase, Avanti Products will provide a replacement compressor free of charge due to a failure. You are responsible for the service labor and freight charges. In rental or commercial use, the limited compressor warranty is one year and nine months. Cost to move the refrigerator to the servicers' shop and back to the user's home, as may be required, are the user's responsibility.

---

**WHAT IS NOT COVERED**

- Content losses of food due to spoilage.
- Incidental or consequential damages.
- Parts and labor costs for the following will not be considered as warranty:
  - Evaporator doors, door springs, and/or frames.
  - Inner door panels, door shelves, door rails, and/or door supports.
  - Light bulbs and/or plastic housing.
  - Plastic cabinet liners.
  - Punctured evaporator that voids the warranty on the complete sealed system.
  - Repairs performed by unauthorized servicers.
  - Shipping and handling costs associated with the replacement of the unit.
- Service calls that do not involve defects in material or workmanship such as customer education, door reversal, or proper installation.
- Service calls that are related to external problems, such as abuse, misuse, inadequate electrical power, accidents, fire, floods, or acts of God.
- Surcharges including, but not limited to, any after hour, weekend, or holiday service calls, tolls, ferry trip charges, or mileage expense for service calls to remote areas, including the State of Alaska.
- Replacement of house fuses or resetting circuit breakers.
- Failure of the product if it is used for other than its intended purpose.
- This warranty does not apply outside the Continental USA.

## INSTRUCCIONES EN ESPAÑOL

### ➤ **INSTALACION**

Retire los accesorios de empaque (plásticos protectores, cartón y tiras engomadas). Limpie el exterior con un trapo suave y seco, y el interior con un trapo húmedo y tibio.

### ➤ **UBICACION**

1. Seleccione un lugar con un piso firme y nivelado.
2. Su refrigerador requiere ventilación. Deje un espacio mínimo de 5" hacia arriba y espacio suficiente en el respaldo para permitir la circulación de aire.
3. Evite luz directa del sol o calor. La luz directa del sol puede afectar la capa de pintura. Las fuentes de calor en su proximidad causarán un consumo mayor de electricidad.
4. Para un mejor desempeño, nivele el refrigerador utilizando las patas ajustables o tornillos niveladores. Para verificar el nivel, abra la puerta hasta la mitad, debe regresar sola.

### ➤ **INSTRUCCIONES PARA LA CONEXION A TIERRA**

Este aparato electrodoméstico debe estar conectado a tierra. En caso de un cortocircuito eléctrico, la conexión a tierra reduce el riesgo de choque eléctrico proporcionando un cable de escape para la corriente eléctrica. Este aparato viene equipado con un cordón que posee un cable a tierra con un enchufe de conexión a tierra. Este enchufe debe estar conectado en un tomacorriente instalado correctamente y conectado a tierra.

### ➤ **ADVERTENCIA**

El uso inadecuado del enchufe de conexión a tierra puede resultar en un riesgo de choque eléctrico. Consulte con un electricista si no comprende bien las instrucciones de conexión a tierra o si existe alguna duda sobre si el aparato está conectado a tierra correctamente.

### ➤ **NO USE UN CORDON DE EXTENSION ELECTRICA**

Use un tomacorriente de pared exclusivo. No conecte su refrigerador a cordones de prolongación eléctrica o junto a cualquier otro electrodoméstico en el mismo tomacorriente de pared.

### ➤ **ADVERTENCIA IMPORTANTE:**

Un refrigerador vacío es una atracción muy peligrosa para los niños. Quite los sellos magnéticos, puertas o cerraduras de todo electrodoméstico que esté en uso.

### ➤ **OPERACION**

Enchufe el cable a la toma de corriente, que debe ser 115-120v A/C, 10 AMP ó más.

Para evitar vibraciones, la caja debe estar bien nivelada. Su unidad tiene un solo control para regular la temperatura, este control se encuentra localizado en la parte superior derecha del compartimiento. Al conectar y encender su unidad, asegúrese de rotar el control de temperatura hacia la posición "5". Este control de temperatura puede variar desde "0" hasta la posición "5", después de haberse mantenido en la posición "5" por 24 o 48 horas aproximadamente, regrese el control de temperatura para ajustarlo a la posición que más se ajuste a sus necesidades. Por ejemplo la posición "3" sería apropiada para usar su unidad en su hogar u oficina.

Para apagar su unidad, simplemente rote el control de temperatura hacia la posición "0".

Nota:

Rotando el control de temperatura hacia la posición "0", Usted solamente apaga el ciclo de enfriamiento, pero no desconecta su unidad de la fuente de corriente.

Si la unidad es desconectada de la pared o sufre una interrupción de electricidad, Usted siempre debe esperar por un aproximado de 3 a 5 minutos para poder encenderla de nuevo, de no hacerlo así, su unidad no comenzará a funcionar.

### ➤ **COMO DESCONGELAR**

Coloque el dial del termostato en "0" (apagado). Quite todos los alimentos congelados ya que se puedan echar a perder. El descongelado generalmente tarda pocas horas. Para descongelar rápido quite todos los alimentos del refrigerador y deje la puerta abierta. **Nunca use un cuchillo u otro instrumento metálico para raspar el hielo o la escarcha del congelador.** Luego de descongelar, vacíe el agua de la bandeja de goteo y vuelva a colocar el dial del termostato en la posición deseada.

#### ➤ **USO DE LAS CUBETERAS DE HEILO**

- Llene la cubetera aproximadamente hasta  $\frac{3}{4}$  de la altura después de lavarla.
- La cubetera es flexible, tuérsela para sacar los hielos.
- Si los cubos de hielo no son usados, pueden disminuir de tamaño y adquirir olores.
- Se aconseja cambiarlos cada 30 días si no se han usado.

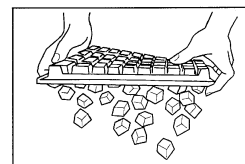

#### ➤ **CUIDADOS EN LOS PERIODOS DE AUSENCIA**

- Para cortos períodos de ausencia (menos de 21 días) el congelador podrá quedar funcionando. Coloque el botón de control de temperaturas en la posición "0".
- En períodos de ausencia más largos, se aconseja dejar el refrigerador limpio y desconectado.
- Saque todo lo que tenga adentro del refrigerador y haga el deshielo y la limpieza general. También retire las cubeteras, limpie bien y séquelas internamente.
- Deje la puerta entreabierta para que penetre el aire y así evitar la formación de olores.

#### ➤ **ECONOMIA DE ENERGIA**

- Evite dejar por mucho tiempo la puerta abierta.
- Evite aperturas frecuentes de la puerta.
- Nunca coloque alimentos calientes dentro del refrigerador. Espere que estén a una temperatura ambiental.
- Coloque el botón de control de temperaturas en la posición adecuada.

#### ➤ **SI USTED SE VA DE VACACIONES**

- Saque todos los artículos del refrigerador-congelador si Ud. se va de vacaciones por un mes o más.
- Desconecte el refrigerador del tomacorriente y limpie el refrigerador bien.
- Deje la puerta abierta para evitar la formación de olores, condensación o moho.

#### ➤ **SI USTED SE MUDA**

- Desconecte el refrigerador del tomacorriente y limpie el refrigerador bien.
- Saque todas las partes movibles y empaquételas para que no se muevan durante la transportación.
- Cierre la puerta del refrigerador y séllela con cinta adhesiva.
- Asegúrese que el refrigerador va parado durante el viaje y cúbralo con una frazada.

#### **COMO CAMBIAR LA DIRECCION DE APERTURA DE LA PUERTA**

En caso de que necesite cambiar el lado de apertura de la puerta, por favor consulte al servicio pos-venta de su localidad o al empleado que le vendió la unidad.

## Registration Information

Thank you for purchasing this fine Avanti product. Please fill out this card and return it within 100 days of purchase and receive these important benefits:

➤ **Protect your product:**

We will keep the model number and date of purchase of your new Avanti product on file to help you refer to this information in the event of an insurance claim such as fire or theft.

➤ **Promote better products:**

We value your input. Your responses will help us develop products designed to best meet your future needs.

------(detach here)-----

### Avanti Registration Card

Name _____			Model # _____	Serial # _____
Address _____			Date Purchased _____	Store/Dealer Name _____
City _____	State _____	Zip _____	Occupation _____	
Area Code _____	Phone Number _____		<b><u>As Your Primary Residence, Do You:</u></b> <input type="checkbox"/> Own <input type="checkbox"/> Rent	
<b><u>Did You Purchase An Additional Warranty:</u></b> <input type="checkbox"/> Extended <input type="checkbox"/> Food Loss <input type="checkbox"/> None			<b><u>Your Age:</u></b> <input type="checkbox"/> under 18 <input type="checkbox"/> 18-25 <input type="checkbox"/> 26-30 <input type="checkbox"/> 31-35 <input type="checkbox"/> 36-50 <input type="checkbox"/> over 50	
<b><u>Reason For Choosing This Avanti Product:</u></b> Please indicate the most important factors that influenced your decision to purchase this product. <input type="checkbox"/> Price <input type="checkbox"/> Product Features <input type="checkbox"/> Avanti Reputation <input type="checkbox"/> Product Quality <input type="checkbox"/> Salesperson Recommendation <input type="checkbox"/> Friend/Relative Recommendation <input type="checkbox"/> Warranty <input type="checkbox"/> Other _____			<b><u>Marital Status:</u></b> <input type="checkbox"/> Married <input type="checkbox"/> Single <b><u>Is This Product Used In The:</u></b> <input type="checkbox"/> Home <input type="checkbox"/> Business <b><u>How Did You Learn About This Product:</u></b> <input type="checkbox"/> Advertising <input type="checkbox"/> Product Features <input type="checkbox"/> In Store Demo <input type="checkbox"/> Personal Demo <input type="checkbox"/> Other _____	
Comments _____			Comments _____	

PRINTED IN CHINA



## Free Manuals Download Website

<http://myh66.com>

<http://usermanuals.us>

<http://www.somanuals.com>

<http://www.4manuals.cc>

<http://www.manual-lib.com>

<http://www.404manual.com>

<http://www.luxmanual.com>

<http://aubethermostatmanual.com>

Golf course search by state

<http://golfingnear.com>

Email search by domain

<http://emailbydomain.com>

Auto manuals search

<http://auto.somanuals.com>

TV manuals search

<http://tv.somanuals.com>