

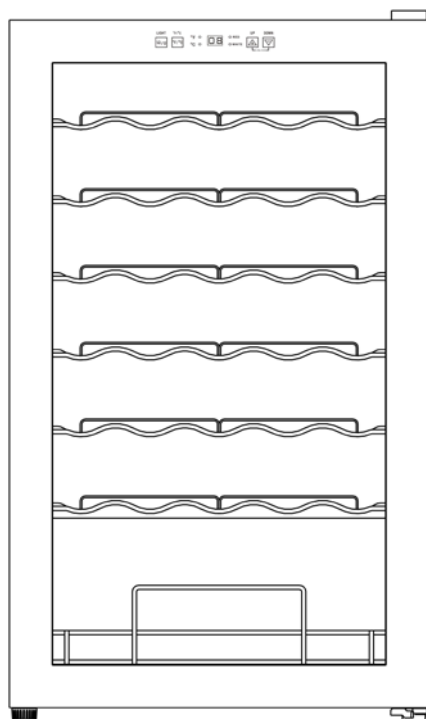

**INSTRUCTION MANUAL
MANUAL DE INSTRUCCIONES**

Model Number / No. de Modelo: WC3406

WINE CHILLER / VINERA



BEFORE USE, PLEASE READ AND FOLLOW ALL SAFETY RULES AND OPERATING INSTRUCTIONS.

La sección en español empieza en la página 12.

Avanti Products has a policy of continuous improvement on its products and reserves the right to change materials and specifications without notice.

**Avanti Products LLC,
P.O. Box 520604 - Miami, Florida 33152
www.avantiproducts.com**

TABLE OF CONTENTS

Appliance Safety	4
Important Safety Guides	5
Help Us Help You	6
Parts and Features	7
Important Safety Instructions	8
Installation Instructions	8
Before Using Your Wine Chiller	8
Installation of Your Wine Chiller	8
Electrical Connection	9
Extension Cord / Surge Protector	9
Operating Your Wine Chiller	10
Control Panel	10
Setting the Temperature	10
Storage Capacity	11
Interior Light	11
Care and Maintenance	11
Cleaning Your Wine Chiller	11
Power Failure	11
Vacation Time	11
Moving Your Wine Chiller	11
Energy Saving Tips	11
Troubleshooting Guide	12
Service for Your Appliance	13
Wiring Diagram	13
Your Avanti Products Warranty	14
Instrucciones en Español	15 – 17
Registration Information and Registration Card	19

APPLIANCE SAFETY

Your safety and the safety of others are very important.

We have provided many important safety messages in this manual and on your appliance. Always read and obey all safety messages.



This is the Safety Alert Symbol. This symbol alerts you to potential hazards that can kill or injure you and others. All safety messages will follow the Safety Alert Symbol and either the words "DANGER", "WARNING" or "CAUTION".



Danger means that failure to heed this safety statement may result in severe personal injury or death.







Warning means that failure to heed this safety statement may result in extensive product damage, serious personal injury, or death.



Caution means that failure to heed this safety statement may result in minor or moderate personal injury, or property or equipment damage.

All safety messages will alert you do what the potential hazard is, tell you how to reduce the chance of injury, and let you know what can happen if the instructions are not followed.

<u>REFRIGERANT GAS WARNINGS</u>	
	Risk of fire or explosion. Flammable refrigerant used. Do not use mechanical devices to defrost refrigerator. Do not puncture refrigerant tubing.
	Risk of fire or explosion. Flammable refrigerant used. To be repaired only by trained service personnel. Do not puncture refrigerant tubing.
	Risk of fire or explosion. Flammable refrigerant used. Consult repair manual/owner's guide before attempting to service this product. All safety precautions must be followed.
	Risk of fire or explosion. Dispose of property in accordance with federal or local regulations. Flammable refrigerant used.
	Risk of fire or explosion due to puncture of refrigerant tubing. Follow handling instructions carefully. Flammable refrigerant used.

IMPORTANT SAFEGUIDES



Before the appliance is used, it must be properly positioned and installed as described in this manual, so read the manual carefully. To reduce the risk of fire, electrical shock or injury when using the appliance, follow basic precaution, including the following:

DANGER

- Plug into a grounded 3-prong outlet, do not remove grounding prong, do not use an adapter, and do not use an extension cord.
- Replace all panels before operating.
- It is recommended that a separate circuit, serving only your appliance be provided. Use receptacles that cannot be turned off by a switch or pull chain.
- Never clean appliance parts with flammable fluids. These fumes can create a fire hazard or explosion. And do not store or use gasoline or other flammable vapors and liquids in the vicinity of this or any other appliance. The fumes can create a fire hazard or explosion.
- Before proceeding with cleaning and maintenance operations, make sure the power line of the unit is disconnected.
- Do not connect or disconnect the electric plug when your hands are wet.
- Unplug the appliance or disconnect power before cleaning or servicing. Failure to do so can result in electrical shock or death.
- Do not attempt to repair or replace any part of your appliance unless it is specifically recommended in this material. All other servicing should be referred to a qualified technician.

WARNING

FOLLOW WARNING CALL OUTS BELOW ONLY WHEN APPLICABLE TO YOUR MODEL

- Use two or more people to move and install appliance. Failure to do so can result in injury.
- To ensure proper ventilation for your appliance, the front of the unit must be completely unobstructed. Choose a well-ventilated area with temperatures above 60°F (16°C) and below 90°F (32°C). This unit must be installed in an area protected from the element, such as wind, rain, water spray or drips.
- The appliance should not be located next to ovens, grills or other sources of high heat.
- The appliance must be installed with all electrical, water and drain connections in accordance with state and local codes. A standard electrical supply (115 V AC only, 60 Hz), properly grounded in accordance with the National Electrical Code and local codes and ordinances is required.
- Do not kink or pinch the power supply cord of appliance.
- The fuse (or circuit breaker) size should be 2.5 amperes.
- It is important for the appliance to be leveled in order to work properly. You may need to make several adjustments to level it.
- Never allow children to operate, play with or crawl inside the appliance.
- Do not use solvent-based cleaning agents or abrasives on the interior. These cleaners may damage or discolor the interior.
- Do not use this apparatus for other than its intended purpose.

HELP US HELP YOU...

Read this guide carefully.

It is intended to help you operate and maintain your new Wine Chiller properly.

Keep it handy to answer your questions. If you don't understand something or you need more assistance, please call:

Avanti Customer Service
800-220-5570

Keep proof of original purchase date (such as your sales slip) with this guide to establish the warranty period.

CAUTION:

THIS WINE CHILLER IS NOT DESIGNED FOR THE STORAGE OF MEDICINE OR OTHER MEDICAL PRODUCTS.

Write down the model and serial numbers.

You'll find them on a plate located on the rear outside wall of the Wine Chiller.

Please write these numbers here:

Date of Purchase

Model Number

Serial Number

Use these numbers in any correspondence or service calls concerning your Wine Chiller.

If you received a damaged Wine Chiller, immediately contact the dealer (or builder) that sold you the Wine Chiller.

Save time and money. Before you call for service, check the Troubleshooting Guide. It lists causes of minor operating problems that you can correct yourself.

IF YOU NEED SERVICE

We're proud of our service and want you to be pleased. If for some reason you are not happy with the service you receive, here are some steps to follow for further assistance.

FIRST, contact the people who serviced your Wine Chiller. Explain why you are not pleased. In most cases, this will solve the problem.

NEXT, if you are still not pleased, write all the details, including your telephone number, and send it to:

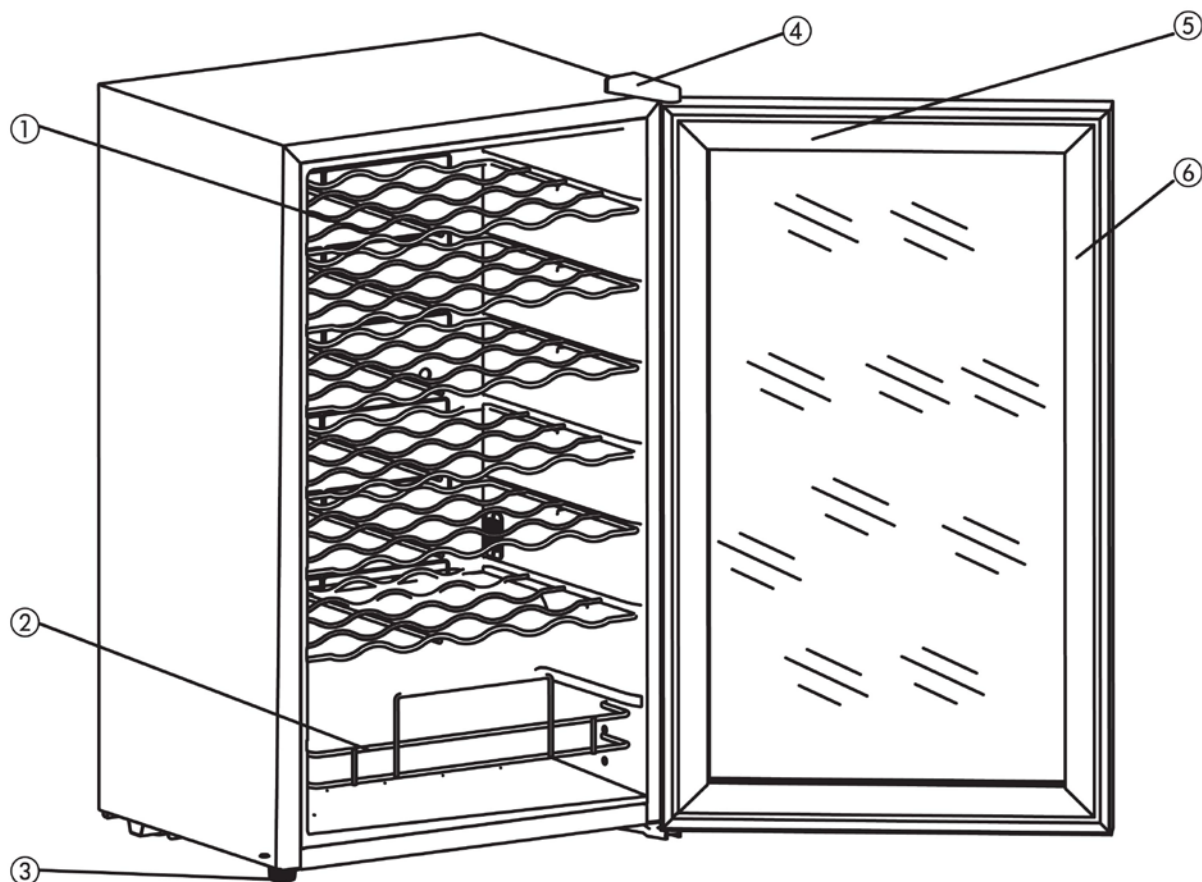

Customer Service
Avanti Products
10880 NW 30 Street
Miami, FL 33172 USA

PARTS & FEATURES



1. Wine Shelves (Total 6)
2. Lower Storage Bar (Total 1)
3. Leveling Leg
4. Top Door Hinge with Cover
5. Temperature Control Panel (Front of Door)
6. Glass Door with Integrated Handle

IMPORTANT SAFETY INSTRUCTIONS

 WARNING 	To reduce the risk of fire, electrical shock, or injury when using your appliance, follow these basic precautions:
<ul style="list-style-type: none">• Read all instructions before using the Wine Chiller.• DANGER or WARNING: Risk of child entrapment. Child entrapment and suffocation are not problems of the past. Junked or abandoned appliances are still dangerous . . . even if they will “just sit in the garage a few days”.• Before you throw away your old Wine Chiller: Take off the door. Leave the shelves in place so that children may not easily climb inside.• Never allow children to operate, play with, or crawl inside the appliance.• Never clean appliance parts with flammable fluids. The fumes can create a fire hazard or explosion.• Do not store or use gasoline or any other flammable vapors and liquids in the vicinity of this or any other appliance. The fumes can create a fire hazard or explosion.• Do not repair or replace any part of the refrigerator or attempt any servicing unless specifically recommended in the user-maintenance instructions or in published user-repair instructions. Replace the fuse with the same type. <p style="text-align: center;">-Save these instructions-</p>	

INSTALLATION INSTRUCTIONS

➤ Before Using Your Wine Chiller

- Remove the exterior and interior packing.
- Check to be sure you have all of the following parts:
 - 6 Shelves
 - Storage Retainer Bar
 - 1 Instruction Manual
- Clean the interior surface with lukewarm water using a soft cloth.

➤ Installation of Your Wine Chiller

- **This Wine Chiller is designed for free standing installation only, and should not be recessed or built-in (Fully recessed).**
- **Allow 5 inches of space between the back and sides of the refrigerator, which allows the proper air circulation.**
- Place your Wine Chiller on a surface that is strong enough to support it when it is fully loaded.
- Locate the Wine Chiller away from direct sunlight and sources of heat (stove, heater, radiator, etc.). Direct sunlight may affect the acrylic coating and heat sources may increase electrical consumption. Extreme cold ambient temperatures may also cause the unit not to perform properly.
- Avoid locating the unit in moist areas.
- Plug the Wine Chiller into an exclusive, properly installed-grounded wall outlet. Do not under any circumstances cut or remove the third (ground) prong from the power cord. Any questions concerning power and/or grounding should be directed toward a certified electrician or an authorized Avanti Products service center.
- After plugging the Wine Chiller into a wall outlet, allow the unit to cool down for 2-3 hours before placing any items in the compartment.

➤ **ELECTRICAL CONNECTION**

⚡ Warning ⚡

Improper use of the grounded plug can result in the risk of electrical shock. If the power cord is damaged, have it replaced by an authorized Avanti Products service center.

This appliance should be properly grounded for your safety. The power cord of this appliance is equipped with a three-prong plug which mates with standard three prong wall outlets to minimize the possibility of electrical shock.

Do not under any circumstances cut or remove the third ground prong from the power cord supplied. For personal safety, this appliance must be properly grounded.

This appliance requires a standard 115/120 Volt AC ~/60Hz electrical ground outlet with three-prong. Have the wall outlet and circuit checked by a qualified electrician to make sure the outlet is properly grounded. When a standard 2-prong wall outlet is encountered, it is your responsibility and obligation to have it replaced with a properly grounded 3-prong wall outlet.

The cord should be secured behind the appliance and not left exposed or dangling to prevent accidental injury.

The appliance should always be plugged into its own individual electrical outlet which has a voltage rating that matches the rating label on the appliance. This provides the best performance and also prevent overloading house wiring circuits that could cause a fire hazard from overheated. Never unplug the appliance by pulling the power cord. Always grip the plug firmly and pull straight out from the receptacle. Repair or replace immediately all power cords that have become frayed or otherwise damaged. Do not use a cord that shows cracks or abrasion damage along its length or at either end. When moving the appliance, be careful not to damage the power cord.

➤ **EXTENSION CORD**

Because of potential safety hazards under certain conditions, it is strongly recommended that you do not use an extension cord with this appliance. However, if you must use an extension cord it is absolutely necessary that it be a UL/CUL-Listed, 3-wire grounding type appliance extension cord having a grounding type plug and outlet and that the electrical rating of the cord be 115 volts and at least 10 amperes.

➤ **SURGE PROTECTOR**

Most electrical appliances use a series of electric control boards to operate. These boards are very susceptible to power surges and could be damaged or destroyed.

If the appliance is going to be used in an area or if your city / country is prone to power surges / outages; it is suggested that you use a power surge protector for all electrical devices / appliances you use. The surge protector that you select must have a surge block high enough to protect the appliance it is connected to. If you have any questions regarding the type and size of surge protector needed contact a licensed electrician in your area.

Damages due to power surges are not considered a manufacturer covered defect and will void your product warranty.

OPERATING YOUR WINE CHILLER

It is recommended you install the Wine Chiller in a place where the ambient temperature is between 23°-26°C/ 72°-78°F. If the ambient temperature is above or below recommended temperatures, the performance of the unit may be affected. For example, placing your unit in extreme cold or hot conditions may cause interior temperatures to fluctuate. The range of 5°-18°C/40°-65°F may not be reached.

Recommended Temperatures for Chilling Wine.

Red Wines	15° - 18° C	58 – 65° F
Dry/White Wines	9° - 14° C	48 – 57° F
Rose Wines	10° - 11° C	49 – 51° F
Sparkling Wines	5° - 9° C	40 – 47° F

Temperature Ranges For Your Wine Chiller

Temperature Range	5 - 18° C	40 – 65° F
-------------------	-----------	------------

CONTROL PANEL



You can select temperature display setting from Fahrenheit to Celsius degree by pushing the button. (Fahrenheit or Celsius indicator will appear in green color) The degrees will appear in blue color in the temperature display window.

➤ CONTROL PANEL LOCK

- Your Wine chiller is equipped with an automatic Control panel lock function. This function will prevent any unwanted changes to your temperature or power settings.
- The lock function will activate automatically 12 seconds after the last time a button is pushed on the control panel.
- To unlock the control panel lock press and hold the **(UP)** and the **(DOWN)** buttons simultaneously for 3 seconds the control panel will beep and blink once indicating that the control panel is active and the settings can be changed.

SETTING THE TEMPERATURE CONTROL

- You can set the temperature by pushing the or buttons on the control panel. The temperature that you desire to set will increase 1°F or 1°C if you push the button once, on the contrary the temperature will decrease 1°F or 1°C if you push the button once.
- When you store mostly red wines, the temperature which you control by pushing the above two buttons need to be set at between 15° - 18°C (58° - 64°F).
- When you store mostly white wines, the temperature needs to be set at between 8° - 14°C (46° - 57°F).
- When you store mostly sparkling wines, the temperature needs to be set at between 8° - 9°C (46° - 47°F).

NOTE:



- When you use the wine chiller for the first time or restart the wine chiller after having been shut off for a long time, there could be a few degrees variance between the temperature you select and the one indicated on the LED readout. This is normal and it is due to the length of the activation time. Once the wine chiller is running for a few hours everything will be back to normal.

➤ [Storage Capacity](#)

NOTE: You can place 34 standard bottles in this wine chiller.

Many bottles may differ in size and dimensions. As such the actual number of bottles you may be able to store may vary. Bottle capacities are approximate maximums when storing traditional Bordeaux 750ml bottles and include bulk storage.

➤ [Interior Light](#)

You can turn the interior light ON or OFF by pushing the button marked with the “bulb” symbol . You have to push the button marked with the “bulb” symbol  again and the light will turn back on.

CARE AND MAINTENANCE

➤ [Cleaning Your Wine Chiller](#)

- UNPLUG the Wine Chiller, and remove all items including shelves.
- Wash the inside surfaces with a warm water and baking soda solution. The solution should be about 2 tablespoons of baking soda to a quart of water.
- Wash the shelves with a mild detergent solution.
- Wring excess water out of the sponge or cloth when cleaning area of the controls, or any electrical parts.
- Wash the outside cabinet with warm water and mild liquid detergent. Rinse well and wipe dry with a clean soft cloth.

CAUTION

Failure to unplug the Wine Chiller could result in electrical shock or personal injury.

➤ [Power Failure](#)

- Most power failures are corrected within a few hours and should not affect the temperature of your appliance if you minimize the number of times the door is opened. If the power is going to be off for a longer period of time, you need to take the proper steps to protect your contents.

➤ [Vacation Time](#)

- **Short vacations:** Leave the Wine Chiller operating during vacations of less than three weeks.
- **Long vacations:** If the appliance will not be used for several months, remove all items and unplug the power cord. Clean and dry the interior thoroughly. To prevent odor and mold growth, leave the door open slightly: blocking it open if necessary.

➤ [Moving Your Wine Chiller](#)

- Remove all bottles.
- Securely tape down all loose items (shelves) inside your appliance.
- Tape the door shut.
- Protect outside of appliance with a blanket, or similar item.

➤ [Energy Saving Tips](#)

- The Wine Chiller should be located in the coolest area of the room, away from heat producing appliances, and out of the direct sunlight.

PROBLEMS WITH YOUR WINE CHILLER?

You can solve many common Wine Chiller problems easily, saving you the cost of a possible service call. Try the suggestions below to see if you can solve the problem before calling the servicer.

TROUBLESHOOTING GUIDE

PROBLEM	POSSIBLE CAUSE
Wine Chiller does not operate.	Not plugged in. The circuit breaker tripped or a blown fuse.
Wine Chiller is not cold enough.	Check the temperature control setting. External environment may require a higher setting. The door is opened too often. The door is not closed completely. The door gasket does not seal properly. The Wine Chiller does not have the correct clearances. Abnormal voltage.
The light does not work.	Not plugged in. The circuit breaker tripped or a blown fuse. The light button is "OFF".
Vibrations.	Check to assure that the Wine Chiller is level.
The door will not close properly.	The Wine Chiller is not level. The door was reversed and not properly installed. The gasket is dirty. The shelves are out of position.

SERVICE FOR YOUR WINE CHILLER

We are proud of our customer service organization and the network of professional service technicians that provide service on your Avanti appliances. With the purchase of your Avanti appliance, you can have the confidence that if you ever need additional information or assistance, the Avanti Products Customer Service team will be here for you. Just call us toll-free.

AVANTI PRODUCTS CUSTOMER SERVICES

Product Information 800-323-5029	Whatever your questions are about our products, help is available.
Part Orders 800-220-5570	You may order parts and accessories that will be delivered directly to your home by personal check, money order, Master Card, or Visa.
In-Home Repair Service 800-220-5570	An Avanti Products authorized service center will provide expert repair service, scheduled at a time that is convenient for you. Our trained servicers know your appliance inside and out.

WIRING DIAGRAM

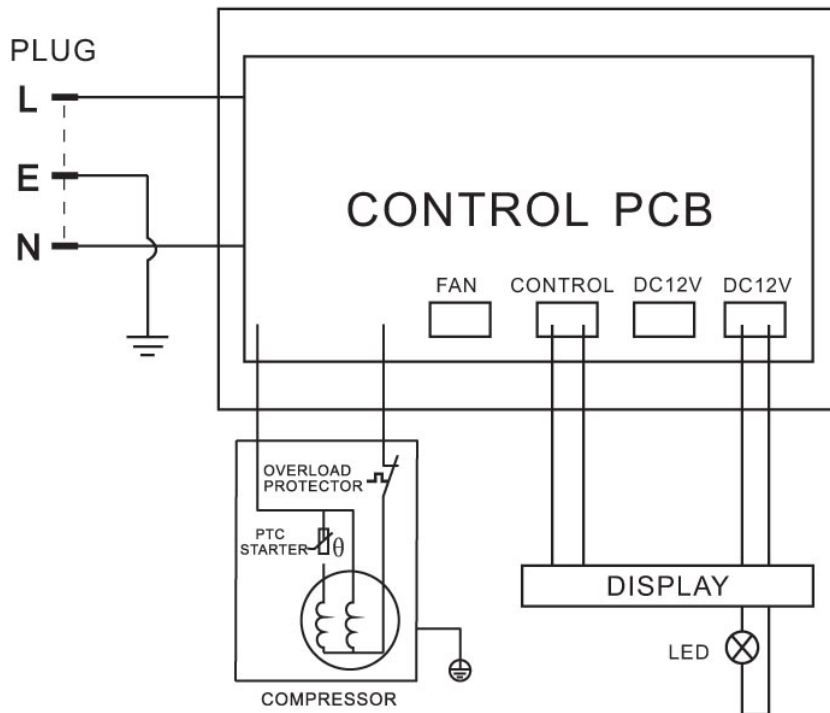

YOUR AVANTI PRODUCTS WARRANTY	Staple your sales receipt here. Proof of original purchase date is needed to obtain service under warranty.
<u>WHAT IS COVERED – LIMITED ONE-YEAR WARRANTY</u>	
Avanti Products warrants that the product is free from defects in materials and/or workmanship for a period of twelve (12) months from the date of purchase by the original owner. The foregoing timeline begins to run upon the date of purchase, and shall not be stalled, tolled, extended, or suspended for any reason whatsoever unless described in detail in the warranty document. For one year from the date of purchase by the original owner, Avanti products will, at its option, repair or replace any part of the product which proves to be defective in material or workmanship under normal use. Avanti Products will provide you with a reasonably similar product that is either new or factory refurbished. During this period Avanti Products will provide all parts and labor necessary to correct such defects free of charge, so long as the product has been installed and operated in accordance with the written instructions in this manual. In rental or commercial use, the warranty period is 90 days. All Avanti appliances of 3.5 cubic feet capacity or less must be brought/sent to the appliance service center for repair.	
<u>LIMITED SECOND THROUGH FIFTH YEAR WARRANTY</u>	
For the second through the fifth year from the date of original purchase, Avanti Products will provide a replacement compressor free of charge due to a failure. You are responsible for the service labor and freight charges. In rental or commercial use, the limited compressor warranty is one year and nine months. Costs involved to move the product to the service center and back to the user's home, as maybe required, are the user's responsibility.	
<u>WARRANTY EXCLUSIONS / WHAT IS NOT COVERED:</u>	
The warranty coverage described herein excludes all defects or damage that are not the direct fault of Avanti Products, including without limitation, one or more of the following:	
<ul style="list-style-type: none"> ● A failure to comply with any applicable state, local, city, or county electrical, plumbing and/or building codes, regulations, or laws, including failure to install the product in strict conformity with local fire and building codes and regulations. ● Any external, elemental and/or environmental forces and factors, including without limitation, rain, wind, sand, floods, fires, mud slides, freezing temperatures, excessive moisture or extended exposure to humidity, lightning, power surges, structural failures surrounding the appliance, and acts of God. 	
<ul style="list-style-type: none"> ● Content losses of food or other content due to spoilage. ● Incidental or consequential damages ● Parts and labor costs for the following will not be considered as warranty: <ul style="list-style-type: none"> ● Evaporator doors, door springs, and/or frames. ● Inner door panels, door shelves, door rails, and/or door supports. ● Light bulbs and/or plastic housing. ● Plastic cabinet liners. ● Punctured evaporator that voids the warranty on the complete sealed system. 	<ul style="list-style-type: none"> ● Shipping and handling costs associated with the replacement of the unit. ● Repairs performed by unauthorized servicers. ● Service calls that are related to external problems, such as abuse, misuse, inadequate electrical power, accidents, fire, floods, or any other acts of God. ● Failure of the product if it is used for other than it intended purpose. ● The warranty does not apply outside the Continental USA. ● Surcharges including but not limited to, any after hour, weekend, or holiday service calls, tolls, ferry trip charges, or mileage expense for service calls to remote areas.
In no event shall Avanti Products have any liability or responsibility whatsoever for damage to surrounding property, including cabinetry, floors, ceilings, and other structures and/or objects around the product. Also excluded from this warranty are scratches, nicks, minor dents, and other cosmetic damages on external surfaces and exposed parts; Products on which the serial numbers have been altered, defaced or removed; service visits for customer education, or visits where there is nothing wrong with the product; correction of installation problems (you are solely responsible for any structure and setting for the product, including all electrical, plumbing and/or other connecting facilities, for proper foundation/flooring, and for any alterations including without limitation cabinetry, walls, floors, shelving etc., as well as the resetting of breakers or fuses.	
<u>OUT OF WARRANTY PRODUCT</u>	
Avanti Products is under no obligation, at law or otherwise, to provide you with any concessions, including repairs, pro-rates, or product replacement, once this warranty has expired.	

WARRANTY – REFRIGERATION - COMPRESSOR

INSTRUCCIONES DE SEGURIDAD

ATENCION

INSTRUCCIONES PARA LA CONEXION A TIERRA

Este aparato electrodoméstico debe estar conectado a tierra. En caso de un cortocircuito eléctrico, la conexión a tierra reduce el riesgo de choque eléctrico proporcionando un cable a tierra con una enchufe de conexión a tierra. Este enchufe debe estar conectado en un tomacorriente instalado correctamente y conectado a tierra.

ADVERTENCIA – El uso inadecuado del enchufe de conexión a tierra puede resultar en un riesgo de choque eléctrico. Consulte con un electricista o persona de reparaciones competente si no comprenden bien las instrucciones de conexión a tierra o si existe alguna duda sobre si el aparato esta conectado a tierra correctamente.

NO USE UN CORDON DE PROLONGACION ELECTRICA

Use un tomacorriente de pared exclusivo. No conecte su vinera a cordones de prolongación eléctrica o junto a cualquier otro electrodoméstico en el mismo tomacorriente de pared.

ADVERTENCIA IMPORTANTE:

Una vinera vacía es una atracción muy peligrosa para los niños. Saque todas las juntas, pestillos, tapas o puerta de todo electrodoméstico que no esté en uso, o tome alguna medida para asegurar que no presente peligro.

INSTRUCCIONES DE INSTALACION

Saque los embalajes exteriores, limpie bien el exterior con un paño suave seco, y el interior con un paño húmedo y tibio. Evite colocar la vinera cerca de una fuente de calor, luz de sol directa, o lugar húmedo.

Ubicación

1. Seleccione un lugar con su piso fuerte y nivelado.
2. Deje cinco pulgadas de espacio entre la parte posterior de la vinera y toda pared contigua.
3. Evite la luz directa del sol o calor. La luz directa del sol puede afectar la capa de acrílico. Las fuentes de calor en su proximidad provocarán un consumo mayor de electricidad.

OPERACION

Para evitar vibraciones, el compartimiento interior debe estar bien nivelado. La temperatura variará dependiendo de la cantidad de botellas almacenadas y la frecuencia con que se abre la puerta.

Cuando la vinera no se use por un período largo, desconecte el enchufe y deje la puerta entreabierta.

CONTROL DE TEMPERATURA:

Se recomienda que Ud coloque su vinera en un lugar donde la temperatura ambiental se mantenga entre 23°-26°C / 72°-78°F.

Si la temperatura ambiental oscila afuera de esos límites, pueda afectar la temperatura de la unidad. Por ejemplo, si su unidad está situada en lugares donde hay temperaturas muy frías o calientes también puede afectar la temperatura de la unidad y no alcanzará los límites(5°-18°C/40°-65°F).

Temperaturas recomendadas para enfriar vinos:

Vinos rojos	15° - 18° C	58 – 65° F
Vinos blancos	9° - 14° C	48 – 57° F
Vinos tintos	10° - 11° C	49 – 51° F
Vinos espumantes	5° - 9° C	40 – 47° F

Rango de Temperatura de su vinera

Rango de Temperatura	5 - 18° C	40 – 65° F
----------------------	-----------	------------

PANEL DE CONTROLES:





Cambiar entre grados Centígrados y Fahrenheit

Ud. puede seleccionar los grados centígrados ó Fahrenheit oprimiendo el botón marcado  por aproximadamente 5 segundos .

En la pantalla digital aparecerá el F ó C indicador.





PANEL DE CONTROL DE SEGURIDAD

- Su vinera está equipada con un Panel de Control de Seguridad de función automática. Esta función previene cualquier cambio no deseado en el control de temperatura.
- La función de seguridad se activará automáticamente 12 segundos después de la última vez que cualquier botón del Panel de Control sea presionado.
- Para poder hacer cambios en el Panel de Control, oprima y mantenga presionados los botones () y () por 3 segundos, el Panel del Control emitirá un sonido de “Beep” y parpadeará una vez, indicando que el Panel de Control ha sido activado y que puede efectuar cambios en los controles.

Control de temperatura

Su unidad viene equipada con un control de temperatura electrónico con una pantalla digital.

Ud. se puede seleccionar la temperatura preferida a su gusto presionando los botones marcados

 O  . La temperatura que Ud. selecciona subará 1°C/F cada vez que presione el botón marcado  al contrario la temperatura bajará 1°C/F cada vez que presione el botón marcado 

AVISO:

Cuando Ud. encienda su vinera por primera vez o después de un largo tiempo de estar apagado, habrá una diferencia entre la temperatura que Ud. selecciona y la temperatura indicada en la pantalla

digital. Este situación es normal debido al tiempo de que estuvo apagado. En cuanto la unidad esté encendida por un par de horas la temperatura estará normal.

Luz interior

Ud. puedes encender o apagar la luz interior presionando el botón marcado . Ud. necesita presionar el botón de nuevo para encender la luz.

CUIDADO Y MANTENIMIENTO

Limpieza

Para limpiar el interior, use un paño suave con una solución de una cucharada de bicarbonato de sodio por cada cuarto de agua, o una solución de espuma de jabón suave, o un detergente suave. Para lavar las rejillas, sáquelas deslizándolas con cuidado, y use una solución de detergente suave; luego séquelas con un paño suave. Limpie el exterior con un paño húmedo suave y un poco de detergente suave o productos de limpieza para electrodomésticos.

Período de vacaciones

Para períodos cortos de vacaciones, deja los controles en su programación corriente. Durante ausencias más largas;

- (a) saque todas las botellas,
- (b) desconecte la vinera del tomacorriente,
- (c) limpie bien la vinera,
- (d) deje la puerta abierta para evitar la formación de condensación, moho u olores.

Corte de corriente

La mayoría de los cortes de corriente se corrigen en una o dos horas y no afectarán las temperaturas de su vinera. Sin embargo, Ud. deberá reducir la cantidad de veces que abra la puerta cuando la corriente esté apagada. Durante los cortes de corriente de larga duración, tome medidas para proteger sus botellas de vino.

Si Ud. se muda

Saque o asegure todos los artículos dentro de su vinera. Para evitar que los tornillos nivelantes se averíen, gírelos completamente hacia la base.

Algunas reglas importantes para el uso correcto de la vinera.

- Las bebidas deben guardarse en botellas cerradas.
- No sobrecargue el compartimiento interior.
- No abra la puerta a menos que sea necesario.
- Si la vinera se guardara sin uso por períodos largos, se sugiere que, luego de una limpieza cuidadosa, se deje la puerta entreabierta para permitir que el aire circule dentro de la caja y evitar una posible formación de condensación, moho u olores.
- Nunca cubra los estantes del compartimiento para vinos con papel de aluminio o cualquier otro material para cubrir estantes que puedan obstruir la circulación del aire.

Registration Information

Thank you for purchasing this fine Avanti product. Please fill out this form and return it to the following address within 100 days from the date of purchase and receive these important benefits:

Avanti Products LLC
P.O.Box 520604 – Miami, Florida 33152

➤ **Protect your product:**

We will keep the model number and date of purchase of your new Avanti product on file to help you refer to this information in the event of an insurance claim such as fire or theft.

➤ **Promote better products:**

We value your input. Your responses will help us develop products designed to best meet your future needs.

------(detach here)-----

Avanti Registration Card

Name		Model #	Serial #
Address		Date Purchased	Store / Dealer Name
City	State	Zip	E-mail Address
Area Code	Phone Number		Occupation
Did You Purchase An Additional Warranty		As your Primary Residence, Do You:	
<input type="checkbox"/> Extended <input type="checkbox"/> None		<input type="checkbox"/> Own <input type="checkbox"/> Rent	
Reason for Choosing This Avanti Product: Please indicate the most important factors That influenced your decision to purchase this product:		Your Age:	
<input type="checkbox"/> Price <input type="checkbox"/> Product Features <input type="checkbox"/> Avanti Reputation <input type="checkbox"/> Product Quality <input type="checkbox"/> Salesperson Recommendation <input type="checkbox"/> Other: _____ <input type="checkbox"/> Friend / Relative Recommendation <input type="checkbox"/> Warranty <input type="checkbox"/> Other: _____		<input type="checkbox"/> under 18 <input type="checkbox"/> 18-25 <input type="checkbox"/> 26-30 <input type="checkbox"/> 31-35 <input type="checkbox"/> 36-50 <input type="checkbox"/> over 50	
Comments:		Marital Status: <input type="checkbox"/> Married <input type="checkbox"/> Single	
		Is This Product Used In The: <input type="checkbox"/> Home <input type="checkbox"/> Business	
		How Did You Learn About This Product: <input type="checkbox"/> Advertising <input type="checkbox"/> In-Store Demo <input type="checkbox"/> Personal Demo	

Free Manuals Download Website

<http://myh66.com>

<http://usermanuals.us>

<http://www.somanuals.com>

<http://www.4manuals.cc>

<http://www.manual-lib.com>

<http://www.404manual.com>

<http://www.luxmanual.com>

<http://aubethermostatmanual.com>

Golf course search by state

<http://golfingnear.com>

Email search by domain

<http://emailbydomain.com>

Auto manuals search

<http://auto.somanuals.com>

TV manuals search

<http://tv.somanuals.com>