

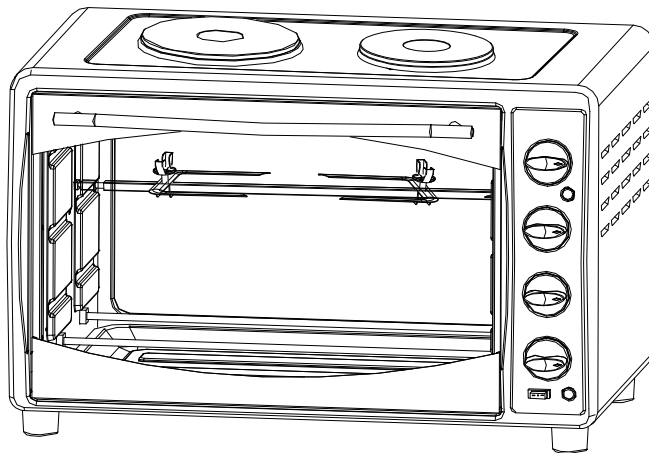

**TOASTER OVEN / ROTISSERIE
INSTRUCTION MANUAL
TOSTADOR-ASADOR / HORNEADOR
MANUAL DE INSTRUCCIONES**

Model Number / No. de Modelo: MKB42B



(Unit appearance may vary)

BEFORE USE, PLEASE READ AND FOLLOW ALL SAFETY RULES AND OPERATING INSTRUCTIONS.

Avanti has a policy of continuous improvement on its products and reserves the right to change materials and specifications without notice.

La sección en español empieza en la página 14

**Avanti Products, A Division of The Mackle Co., Inc.
P.O. Box 520604 - Miami, Florida 33152
www.avantiproductions.com**

TABLE OF CONTENTS

Important Safety Instructions	3
Help Us Help You	4
Parts and Features	5
Installation Instructions	6
Before Using Your Appliance	6
Installation of Your Appliance	6
Electrical Connection	6
Operating Your Appliance	7
Control Panel	7
Using Your Oven	8 – 11
Care and Maintenance	11
Cleaning Your Appliance	11
Storing Your Appliance	11
Troubleshooting Guide	12
Service for Your Appliance	12
Your Avanti Products Warranty	13
Instrucciones en Español	14 – 18
Registration Information / Registration Card	19

IMPORTANT SAFETY INSTRUCTIONS

⚡ WARNING ⚡

To reduce the risk of fire, electrical shock, or injury when using your appliance, follow these basic precautions:

When using electrical appliances, basic safety precautions should always be followed including the following:

READ ALL INSTRUCTIONS, PRODUCT LABELS AND WARNINGS BEFORE USING THE APPLIANCE.

- Do not touch hot surfaces, use handles or knobs. Always use oven mitts when handling hot materials and allow metal parts to cool before cleaning. Allow the unit to cool thoroughly before putting in or taking off parts.
- When the unit is not in use and before cleaning, unplug the appliance from the wall outlet. Make sure the appliance is turned off before unplugging.
- To protect against risk of electrical shock, do not immerse the appliance in water or any other liquids.
- Don't leave children alone or unattended where the appliance is hot or in operation. This appliance is not designed to be used by children.
- Never use your appliance for heating the room. Your oven is not designed to heat your kitchen.
- Do not operate this or any appliance with a frayed or damaged cord or plug, after the appliance malfunctions, is dropped or has been damaged in any manner.
- Do not use attachments not recommended by the manufacturer; they may cause fire, electric shock or personal injury.
- Do not use outdoors or for commercial purposes.
- Do not use this appliance for other than its intended use.
- Do not let the cord dangle over the edge of a tabletop, countertop or to touch hot surfaces.
- Do not place the appliance near a hot gas, electric burner or in a heated oven.
- Extreme caution should be used when using containers constructed of other than metal or glass.
- A fire may occur if the appliance is covered or touching flammable materials, including curtains, draperies, walls, etc., when in operation. Do not store any items on top of the appliance when in operation.
- Do not store any materials, other than manufacturer's recommended accessories in this unit when not in use.
- Do not place any flammable materials in the appliance, such as paper, cardboard, plastic or any materials that may catch fire or melt.
- Never clean the appliance with flammable liquids. The fumes can create a fire hazard or explosion.
- Do not cover the appliance with metal foil. This will cause overheating of the appliance.
- Oversized foods or metal utensils must not be inserted in the appliance as they may create a fire or risk of electrical shock.
- Do not clean with metal scouring pads. Pieces can break off the pad and touch electrical parts involving a risk of electrical shock.
- When broiling, use extreme caution when removing tray or disposing of hot grease.
- To turn this appliance off, return all controls to the "●" / "OFF" position, then remove the plug from wall outlet.
- Cooked food can be very hot, especially pastry filling. Handle with care.
- Never pick up a flaming pan. Turn the controls off. Smother a flaming pan on a surface unit by covering the pan completely with a well fitting lid.
- Do not use water on grease fires. Flaming grease outside a pan can be put out by covering it with baking soda, multipurpose dry chemical, or fire extinguisher. Flame in the oven can be smothered completely by closing the oven door and turning the oven off or by using baking soda, multipurpose dry chemical, or fire extinguisher.

This Unit Is For Household Use Only

- SAVE THESE INSTRUCTIONS -

HELP US HELP YOU...

Read this guide carefully.

It is intended to help you operate and maintain your new appliance properly.

Keep it handy to answer your questions. If you don't understand something or you need more assistance, please call:

Avanti Customer Service
800-220-5570

Keep proof of original purchase date (such as your sales slip) with this guide to establish the warranty period.

Write down the model and serial numbers.

You'll find them on a label located on the back side of the unit.

Please write these numbers here:

Date of Purchase

Model Number

Serial Number

Use these numbers in any correspondence or service calls concerning your appliance.

If you received a damaged appliance, immediately contact the dealer (or builder) that sold you the appliance.

Save time and money. Before you call for service, check the Problem Solver Guide. It lists causes of minor operating problems that you can correct yourself.

IF YOU NEED SERVICE

We're proud of our service and want you to be pleased. If for some reason you are not happy with the service you receive, here are some steps to follow for further assistance.

FIRST, contact the people who serviced your appliance. Explain why you are not pleased. In most cases, this will solve the problem.

NEXT, if you are still not pleased, write all the details, including your telephone number, and send it to:

Customer Service
Avanti Products
10880 NW 30 Street
Miami, FL 33172 USA

PARTS AND FEATURES

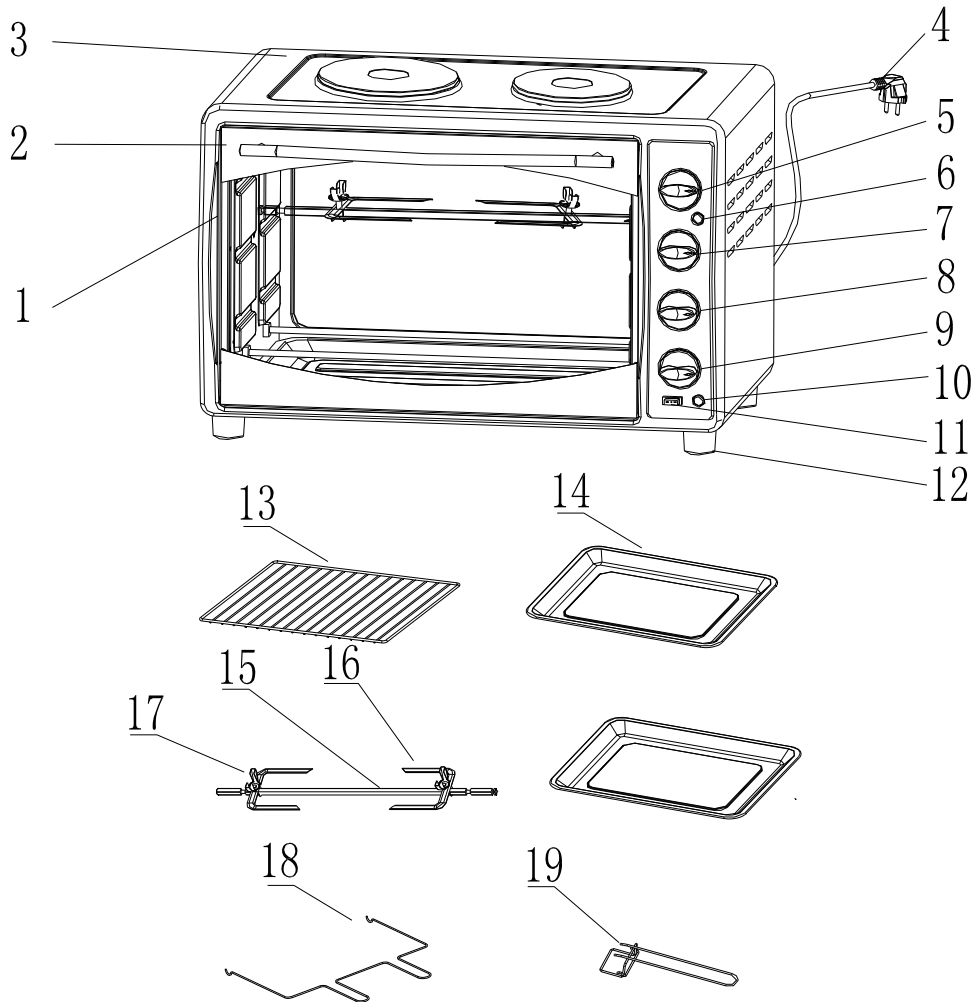

1	Glass Door	11	Cookertop and Oven Selector
2	Door Handle	12	Foot (Total 4)
3	Housing	13	Oven Rack
4	Power Cord	14	Bake / Broil / Drip Pan (Total 2)
5	Cookertop Selector Knob	15	Rotisserie Rod
6	Cookertop Indicator Light	16	Rotisserie Forks (Total 2)
7	Temperature Selector Knob	17	Rotisserie Fork Screws (Total 2)
8	Function Selector Knob	18	Rotisserie Handle
9	Timer Selector Knob	19	Tray Handle
10	Power Indicator Light		

INSTALLATION INSTRUCTIONS

➤ Before Using Your Appliance

- Remove the exterior and interior packing.
- Check to be sure you have all of the following parts:
 - 2 Bake/Broil/Drip Pan
 - 1 Oven Rack
 - 1 Tray Handle
 - 1 Instruction Manual
 - 1 – Rotisserie Rod
 - 2 – Rotisserie Forks with Screws
 - 1 – Rotisserie Handle
- Remove all the items inside your oven and clean the interior surface with lukewarm water using a soft cloth.
- Do not attempt to repair or replace any part of your oven unless it is specially recommended in this manual.
- This appliance requires 1700W and should be the only appliance operating on the circuit.

NOTICE

BEFORE YOU USE THIS OVEN FOR THE FIRST TIME: THE HEATING ELEMENTS HAVE A PROTECTIVE COATING, WHICH MUST BE BURNED OFF BEFORE USE. TO DO THIS, OPEN THE OVEN DOOR AND SET THE TEMPERATURE TO MAX. LEAVE THE APPLIANCE SWITCHED ON FOR APPROXIMATELY 15 MINUTES. IT IS IMPORTANT TO ENSURE ADEQUATE VENTILATION DURING PERIOD AS A BURNING SMELL IS NORMAL DURING THIS PROCESS.

➤ Installation of Your Appliance

Select a location for the appliance. The location should be in an open area on a flat counter where the plug will reach an outlet.

- When positioning the appliance, it should be set on a flat, steady surface.
- Do not block air vents. If they are blocked during operation, the oven may overheat and eventually cause the appliance failure.
- Keep the appliance away from hot air, steam or splashing liquids when choosing a place to locate it, otherwise, the unit's operation may be adversely affected, causing it to break down.
- Direct sunlight may affect the acrylic coating and heat sources may increase electrical consumption.
- Plug the appliance into an exclusive properly installed grounded wall outlet. Any questions concerning power should be directed toward a certified electrician or an authorized Avanti Products service center.
- Do not place anything on the top of the broiler oven and automatic toaster.
- Keep the appliance at least 5 inches away from rear wall to ensure the proper ventilation.

➤ Electrical Connection

- The appliance has a polarized plug (One blade is wider than the other), to reduce the risk of electric shock, this plug is intended to fit into the polarized outlet only one way. If the plug does not fit fully into the outlet, reserve the plug. If it still does not fit, contact a qualified electrician. Do not attempt to modify the plug in any way.
- A short power cord is provided to reduce the hazards resulting from entanglement or tripping over a longer cord. An extension cord may be used with care, however, be sure the marked electrical rating is at least as great as the rating of this appliance. The extension cord should be positioned such that it does not drape over the counter or tabletop where it can be pulled on by children or tripped over. The electrical rating of this appliance is listed on the bottom panel of the appliance.

OPERATING YOUR APPLIANCE

➤ Control Panel

OPERATION SELECTOR SWITCH

To switch off the mini kitchen, turn the operation selector switch to the **OFF** position. If you would like to use the oven, push the operation selector to the “OVEN ” position. There are three types of dual burner combinations for your choice – 900W, 500W and 1400W. If you would like to use the dual burners, push the operation selector switch to the corresponding setting “COOKTOP” position .





REMARK: Please be noted that you cannot use the oven and dual burners at the same time:

TEMPERATURE CONTROL KNOB

Turn the knob clockwise to select the desired temperature up to MAX. To switch off the heating elements of oven, push the OPERATION selector to the OFF position and and the timer control knob is in the “OFF” positio and turn the the temperature control to the “200” setting position.

FUNCTION SELECTOR KNOB

There are five (5) functions: Select the appropriate function for your use.

	CONVECTION BAKE		CONVECTION BROIL
	BAKE BROIL		BROIL ROTISSERIE
	CONVECTION ROTISSERIES		

TIMER SELECTOR KNOB

You can set cooking time up to 60 minutes. It will automatically turn the oven **OFF** at the end of the cooking time selected with the sound of a bell signal. To switch off the oven turn the timer selector to the “**OFF**” setting position. For cooking times greater than 60 minutes you can use the “STAY ON” position, the oven will operate in the selected function until you turn the TIMER selector knob to the “**OFF**” position.

POWER INDICATOR LIGHT

The OVEN and BURNER indicator lights will come **ON** separately when the oven and burner is in use.

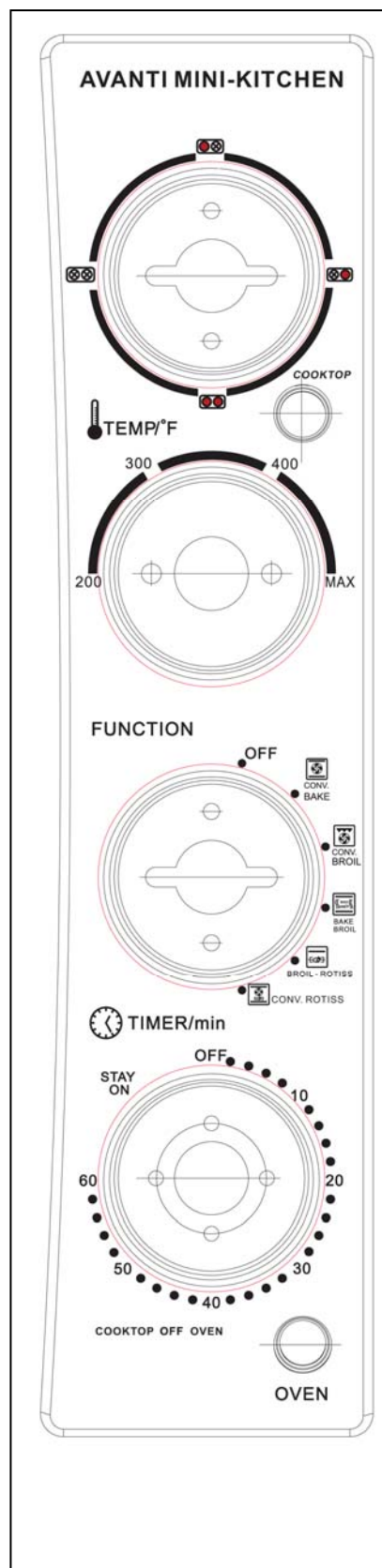

Using Your Oven

Be sure that the OPERATION selector is in the "OFF" position the temperature is in the "200" position and the timer control knob is in the "OFF" position before plugging the cord into the outlet for use and when unplugging the appliance after use.

Preheating The Oven

Push the OPERATION selector is in the "OVEN" position. Turn the function selector control knob to the desired function either CONV. BAKE or CONV. BROIL.

Turn the temperature control knob to the desired temperature.

Turn the timer selector knob to the "20 minutes marking" for the oven to preheat.

NOTE:

For cooking times greater than 60 minutes, you can turn the time control knob in a counter-clockwise motion to the "STAY ON" position.

When using the "STAY ON" position, the oven will continue to operate in the selected function and temperature as previously selected until the timer selector knob is turned in a clockwise motion to the "OFF" position.



Convection Bake

- Both the TOP and BOTTOM heating elements are used.
- Fan is used continuously (ON)
- **PREHEATING THE OVEN IS SUGGESTED WHEN USING THIS FUNCTION**

Convection baking offers fast and more efficient cooking times when compared to standard conventional baking. Convection bake provides a better overall and even result as the convection fan continuously circulates the heated air around the food being cooked giving an even coverage and application of heat.

Convection baking can be used for all types of food but the best results will be seen in the overall taste and quality of baked goods (breads, cookies etc).

Both the TOP and BOTTOM heating elements will cycle ON and OFF to maintain the appropriate heat exposure and temperature.

USING THE CONVECTION BAKE FUNCTION

- Arrange the food accordingly on the baking rack.
- Turn the function selector knob to the Convection Bake function (icon as shown).
- Turn the temperature selector knob to the desired oven temperature.
- Turn the timer selector knob to the desired cooking time (Maximum 60 minutes).
- At the end of the cooking time a bell signal will sound and the oven will turn off automatically.
- After the cooking time has finished, open the door completely and carefully remove the food.



Convection Broil

- Only the TOP heating element is used.
- Fan is used continuously (ON)
- **NO PREHEATING PERIOD IS REQUIRED TO USE THIS FUNCTION**

This function is best used to quickly defrost frozen foods or ingredients in preparation for further cooking either in this oven or by other any other method.

The convection fan circulates the air heated by the TOP heating element (lower wattage output is used in this function) around the food. This method of defrosting is faster, more efficient, and most importantly more hygienic than most other forms of defrosting.

USING THE CONVECTION BROIL FUNCTION

- Arrange the food on the broiler pan. Place the broiler pan on the oven rack.
- Turn the function selector knob to the CONVECTION BROIL function (icon as shown).
- Turn the temperature selector knob to the 250°F oven temperature.
- Turn the timer selector knob to the desired cooking time (Maximum 60 minutes).
- Always cook food promptly after thawing.
- At the end of the cooking time a bell signal will sound and the oven will turn off automatically.
- After the cooking time has finished, open the door completely and carefully remove the food.



Bake Broil

- Both the TOP and BOTTOM heating elements are used.
- Fan is not used (OFF)
- **NO PREHEATING PERIOD IS REQUIRED TO USE THE TOAST FUNCTION**

This function provides the same results as a standard stand-alone conventional oven.

Both the TOP and BOTTOM heating elements will cycle ON and OFF to maintain the appropriate heat exposure and temperature.

USING THE BAKE BROIL FUNCTION

- Place the bread to be toasted directly on the rack in the center of the oven and close the door.
- Turn the function selector knob to the BAKE BROIL function (icon as shown).
- Turn the timer selector knob to the appropriate cooking time as required (maximum 60 minutes).
- At the end of the cooking time a bell signal will sound and the oven will turn off automatically.
- After the cooking time has finished, open the door completely and carefully remove the food.



Broil Rotisserie

- Only the TOP heating element is used.
- Fan is not used (OFF)
- Rotating Rotisserie is used (ON)
- **PREHEATING THE OVEN IS SUGGESTED WHEN USING THIS FUNCTION**

Rotisserie - Broiling is a method of cooking tender cuts of meat by direct heat under the broil element of the oven. The direct high heat cooks quickly and gives the food a rich, brown appearance.

- Rotisserie - Broiling is best suited for meats, fish, and/or poultry in cuts up to 1" thick.

USING THE BROIL ROTISSERIE FUNCTION

- Mount the food to be cooked on the rotisserie rod. For best results the food should be placed in the center of the rod. Secure the food using the rotisserie forks and tighten the fork screws to hold the item in place while cooking.
- Place the broiler pan on the oven rack to collect the natural dripping of grease and juices while cooking.
- Close the door to the first notch leaving approximately a 3 inch gap. This will ensure adequate airflow during broiling.
- Turn the function selector knob to the Rotisserie function (icon as shown).
- Turn the temperature selector knob to the desired oven temperature.
- Turn the timer selector knob to the desired cooking time (Maximum 60 minutes).
- At the end of the cooking time a bell signal will sound and the oven will turn off automatically.
- After the cooking time has finished, open the door completely and carefully remove the food.





CONVECTION ROTISSERIE

- Both the TOP and BOTTOM heating elements are used.
- Fan is used continuously (ON)
- Rotating Rotisserie is used (ON)
- **PREHEATING THE OVEN IS SUGGESTED WHEN USING THIS FUNCTION**

Convection roasting offers fast and more efficient cooking times when compared to standard conventional roasting. Convection roasting provides a better overall and even result as the convection fan continuously circulates the heated air around the food being cooked giving an even coverage and application of heat. This function also gives you the option to use the rotating rotisserie to provide an even more efficient application of heat.

USING THE CONVECTION ROTISSERIE FUNCTION

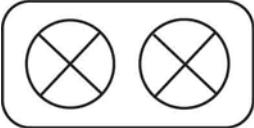
- Mount the food to be cooked on the rotisserie rod. For best results the food should be placed in the center of the rod. Secure the food using the rotisserie forks and tighten the fork screws to hold the item in place while cooking. Place the broiler pan on the oven rack to collect the natural dripping of grease and juices while cooking. If you prefer to roast the food in a fixed position (ie in a pan)
- If you would prefer to roast the food in a fixed position (ie in a pan), arrange the food on the broiler pan. Place the broiler pan on the oven rack.
- Turn the function selector knob to the Convection Roast function (icon as shown).
- Turn the temperature selector knob to the desired oven temperature.
- Turn the timer selector knob to the desired cooking time (Maximum 60 minutes).
- When broiling, the food should be turned over about half-way during the selected cooking time.
- At the end of the cooking time a bell signal will sound and the oven will turn off automatically.
- After the cooking time has finished, open the door completely and carefully remove the food.

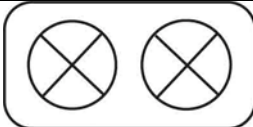
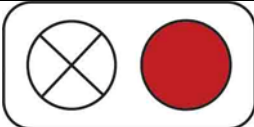
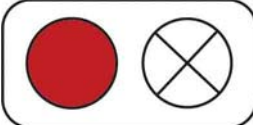
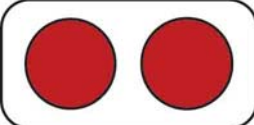
		<h1>COOK-TOP</h1>	
<ul style="list-style-type: none"> Place your cooking pan on the desired burner. Push the OPERATION selector to the COOKTOP position. Turn the BURNER selector to the desired position. Turn the TIMER selector knob to your desired cooking time. Then range top will operate. There are three different types of dual burner combinations for your choice (See graphic below). After using your range top, turn both the TIMER and BURNER selector knobs to the OFF /  position. Push the OPERATION selector to the OFF position. Note: Do not use pans with a diameter less than that of burner. It is advisable to use pans, which have flat bottom of good thickness. The burners should not be used without a pot or pan on them. If any liquid spillage occurs it is recommended to wait for the burners to cool down then wipe with a cloth. 			
	Burners are not ON		RIGHT BURNER ONLY (500W)
	LEFT BURNER ONLY (900W)		BOTH BURNERS WORKING (1400W)

CARE AND MAINTENANCE

➤ Cleaning Your Appliance

Before cleaning your appliance, unplug it and allow it to cool.

Remove the crumb tray, wire rack and drip/baking pan.

Use a damp cloth to wash the inside with warm water and a mild detergent. Do not Immerse in Water!

Abrasive cleaners, scrubbing brushes and chemical cleaners may damage the continuous clean coating on this unit.

Wash the crumb tray, wire rack, drip/baking pan and metal handling tool with a mild detergent solution.

The glass oven door should be cleaned regularly with a non-abrasive liquid cleaner.

Rinse with a damp cloth and then a dry one.

The outside of the appliance should be cleaned with mild detergent and warm water.

CAUTION

Failure to unplug the appliance could result in electrical shock or personal injury.

➤ Storing Your Appliance

Allow the appliance to cool completely before storing. If storing the appliance for long periods of time make certain that the appliance is clean and free of food particles. Store the appliance in a dry location such as on a table or countertop or in a cupboard shelf. Other than the recommended cleaning, no further user maintenance should be necessary.

PROBLEMS WITH YOUR APPLIANCE?

You can solve many common appliance problems easily, saving you the cost of a possible service call. Try the suggestions below to see if you can solve the problem before calling the servicer.

TROUBLESHOOTING GUIDE

PROBLEMS	POSSIBLE CAUSES/SOLUTIONS
<ul style="list-style-type: none"> Appliance does not operate. 	<ul style="list-style-type: none"> Unit not plugged in. Plug the unit into a 120V AC electrical outlet. The circuit breaker tripped or a blown fuse. Be sure that the temperature, function and timer selectors are set.
<ul style="list-style-type: none"> Only one heating element is heating up. 	<ul style="list-style-type: none"> Function setting selection determines which heating element will operate. When toasting, make sure the oven is not set to BROIL or BAKE setting.
<ul style="list-style-type: none"> Heating elements are not heating up. 	<ul style="list-style-type: none"> Heating elements will cycle ON and OFF to maintain proper heat. Make sure function selector is positioned to the desired cooking setting.
<ul style="list-style-type: none"> Overcooked/undercooked Foods 	<ul style="list-style-type: none"> Incorrect temperature setting. You may have to adjust the temperature to desired position. Rack placement. Rack may need to be adjusted to accommodate different foods.
<ul style="list-style-type: none"> Burnt Smell 	<ul style="list-style-type: none"> Food build-up inside appliance, on heating elements or in drip/baking pan. Refer to "Cleaning Your Appliance"

SERVICE FOR YOUR APPLIANCE

We are proud of our customer service organization and the network of professional service technicians that provide service on your Avanti appliances. With the purchase of your Avanti appliance, you can be confident that if you ever need additional information or assistance, the Avanti Products Customer Service team will be here for you. Just call us toll-free.

AVANTI PRODUCTS CUSTOMER SERVICES

Product Information 800-323-5029	Whatever your questions are about our products, help is available.
Part Orders 800-220-5570	You may order parts and accessories that will be delivered directly to your home by personal check, money order, Master Card, or Visa.
In-Home Repair Service 800-220-5570	An Avanti Products authorized service center will provide expert repair service, scheduled at a time that is convenient for you. Our trained servicers know your appliance inside and out.

YOUR AVANTI WARRANTY

LENGTH OF WARRANTY	WE WILL PAY FOR
FULL ONE YEAR WARRANTY FROM DATE OF PURCHASE ON ALL PARTS EXCEPT GLASS PARTS, AND/OR PARTS DAMAGED AS A RESULT OF MISUSE OR LACK OF REASONABLE CARE.	REPLACEMENT PARTS AND REPAIR LABOR TO CORRECT DEFECTS IN MATERIALS OR WORKMANSHIP. SERVICE MUST BE PROVIDED BY AN AUTHORIZED SERVICE COMPANY.
FULL 30-DAY WARRANTY FROM DATE OF PURCHASE ON GLASS PARTS AND FINISH OF PORCELAIN ENAMEL, PAINTED OR BRIGHT METAL FINISHED PARTS	REPLACEMENT PARTS AND REPAIR LABOR TO CORRECT DEFECTS IN MATERIAL OR WORKMANSHIP. SERVICE MUST BE PROVIDED BY AN AUTHORIZED SERVICE COMPANY.

CARRY IN SERVICE ONLY.

CUSTOMER WILL BE RESPONSIBLE FOR ALL TRANSPORTATION CHARGES TO AND FROM THE AUTHORIZED SERVICE COMPANY, ALSO MAKE SURE TO SEND A COPY OF PROOF OF PURCHASE WHEN SENDING THE UNIT FOR SERVICE REPAIRS.

AVANTI PRODUCTS SHALL NOT BE LIABLE FOR INCIDENTAL OR CONSEQUENTIAL DAMAGES.

Some states do not allow the exclusion or limitation of incidental or consequential damages, so this exclusion or limitation may not apply to you. This warranty gives you specific legal rights, and you may also have other rights that vary from state to state.

This warranty is not valid outside the Continental United States.

INSTRUCCIONES EN ESPAÑOL

PRECAUCIONES IMPORTANTES	PARA REDUCIR EL RIESGO DE INCENDIO, DESCARGA ELECTRICA, O DAÑO CUANDO ESTE USANDO SU HORNO SIGA ESTAS INDICACIONES.
<p>CUANDO USE APARATOS ELECTRICOS, SIEMPRE DEBEN TOMARSE ALGUNAS PRECAUCIONES BASICAS DE SEGURIDAD, INCLUYENDO LAS SIGUIENTES:</p> <ul style="list-style-type: none">• Lea todas las instrucciones, las etiquetas en el producto y las advertencias, antes de usar el horno tostador.• No recomendamos el uso extensiones de cordón eléctrico para operar esta unidad.• No toque las superficies calientes. Siempre use guantes cuando maneje materiales calientes y permita que las partes metálicas se enfríen antes de limpiar. Permita que la unidad se enfríe completamente antes de poner o quitar partes.• Desconecte el horno tostador de la toma de corriente cuando la unidad no esté en uso y antes de limpiarla. Nota: Verifique que el horno tostador esté apagado antes de desconectarlo.• Para protegerse contra una descarga eléctrica, no sumerja el aparato en agua o en otros líquidos.• Supervisión continua es necesaria cuando este o cualquier otro aparato sea usado cerca de niños. Este aparato no debe ser usado por niños.• No opere este ni ningún otro aparato con un cordón dañado o quemado o después de que el aparato ha funcionado inadecuadamente o ha sido dañado en cualquier forma.• No utilice accesorios o aditamentos no recomendados por el fabricante, ya que pueden causar incendios, descargas eléctricas o lesiones personales.• No se use en exteriores o con propósitos comerciales.• No use este aparato más que para lo que ha sido diseñado.• No permita que el cordón cuelgue sobre la orilla de la mesa o del mostrador o toque superficies calientes.• No lo coloque sobre o cerca de quemadores de estufas de gas o eléctricas, tampoco dentro de un horno caliente.• Tenga extremo cuidado cuando use recipientes de vidrio o metal.• Puede ocurrir un incendio si el horno tostador está en operación y en contacto o cubierto con materiales inflamables, incluyendo cortinas, tapicería, paredes, etc. No coloque ningún objeto sobre el aparato cuando esté en operación.• Cuando esta unidad no esté en operación, no almacene ningún material que no sea un accesorio recomendado por el fabricante.• No coloque dentro del horno ningún material inflamable como papel, cartón, plástico o cualquier material que se pueda incendiar o derretir.• No cubra la bandeja para migajas o ninguna parte del horno con papel aluminio o metálico. Esto puede causar el sobrecalentamiento del aparato.• Los alimentos grandes o utensilios metálicos no deben ser introducidos en el horno tostador ya que pueden causar incendios o descargas eléctricas.• No limpie con esponjas o fibras metálicas. Se pueden desprender piezas de la esponja o fibra y tocar partes eléctricas creando el riesgo de descargas eléctricas.• Cuando prepare alimentos, tenga cuidado extremo al remover la bandeja o al desechar la grasa caliente.• Para apagar este aparato, coloque todos los controles en las posiciones "0" or "OFF". <p style="text-align: center;">-Esta Unidad Es Sólo Para Uso Doméstico-</p> <p>Para reducir el riesgo de descarga eléctrica, este equipo posee una instalación polarizada, lo cual requiere que la persona que instale esta unidad la conecte apropiadamente a tierra sin invertir la posición de los cables.</p>	

PREPARANDO SU HORNO TOSTADOR

Si usted está usando su horno tostador por primera vez, por favor asegúrese de: Quitar todas las etiquetas de la superficie de su tostador.

Abra la puerta del tostador y saque los documentos impresos y papeles del interior del horno tostador. Limpie la rejilla, charola y bandeja con agua caliente y una pequeña cantidad de detergente líquido para lavar platos, utilice una esponja suave y no abrasiva. No sumerja el horno tostador en el agua.

Seque completamente la unidad antes de utilizarla.

AVISO

ANTES DE USAR LA UNIDAD POR PRIMERA VEZ. LOS ELEMENTOS CALENTADORES TIENEN UNA CAPA PROTECTIVA QUE NECESITA SER QUEMADA ANTES DE USAR EL HORNO.

PARA REMOVER LA CAPA PROTECTIVA:

ABRA LA PUERTA.

GIRE LA PERILLA DE CONTROL DE TEMPERATURA A 250°C/480°F.

GIRE LA PERILLA DE CONTROL DE TIEMPO A 15 MINUTOS.

USTED SENTIRA UN OLOR A QUEMADO, ESTO ES NORMAL.

ASEGURESE TENER VENTILACION ADECUADA MIENTRAS HAGA ESTE PROCESO.

Seleccione un lugar para colocar el horno tostador. El lugar debe ser una área abierta sobre un mostrador con superficie plana donde el enchufe tenga alcance a una toma de corriente.

Enchufe el cable en un tomacorriente de 120 voltios / 60 ciclos.

CALENTAMIENTO PREVIO DEL HORNO

Coloque la parrilla en la posición deseada antes de calentar el horno tostador.

Gire la perilla de control de temperatura y colóquela en la temperatura deseada.

Gire la perilla selectora en la función deseada.

Gire la perilla del reloj a la posición que aproxima 15 MINUTOS.



HORNEADO CON CONVECCION

Seleccione la posición deseada de la parrilla (consulte la sección de colocación de la parrilla).

Gire la perilla de control de temperatura al nivel deseado.

Gire la perilla selectora de función en la posición de hornear o "CONV BAKE". Ambos elementos calentadores, el superior y el inferior y el ventilador interno estarán en funcionamiento.

NOTA – Los elementos calentadores superiores e inferiores se encenderán y apagarán alternadamente para mantener una temperatura moderada.

Coloque los alimentos en la parrilla metálica o dentro de la bandeja para hornear.

El reloj puede seleccionarse para que esté operando hasta por 60 minutos. Al final del ciclo de cocción, emitirá una señal auditiva y el horno se apagará automáticamente, usted puede repetir el ciclo de tiempo si fuera necesario.

Cuando se haya completado el horneado, abra la puerta completamente y saque los alimentos. Cuando esté descongelando alimentos, no caliente el horno previamente. Gire el control de temperatura y colóquelo en 250°F (120°C).

Permita que cada lado de las carnes o pescados se descongele de 15 a 20 minutos. Siempre cocine los alimentos inmediatamente después de descongelar.



ASADO CON CONVECCION

Seleccione la posición deseada de la parrilla.
Gire la perilla de control de temperatura y colóquela en el nivel de temperatura deseado.
Gire la perilla selectora de función en la posición de ASADO CON CONVECCION o "CONV BROIL".
Gire la perilla del reloj hacia el tiempo deseado.
Solamente el elemento calentador de la parte superior y el ventilador interior estarán en funcionamiento.
Coloque la parrilla para asar, encima de la bandeja para hornear. Luego coloque los alimentos. Sobre la parrilla para asar.
El reloj puede seleccionarse para que esté operando hasta por 60 minutos. Al final del ciclo de cocción, emitirá una señal auditiva y el horno se apagará automáticamente. Si la cocción requiere más tiempo repita el ciclo.
Es recomendable siempre voltear los aumentos a la mitad del ciclo de cocción.
Cuando se haya completado la cocción, abra la puerta completamente y saque los alimentos cuidadosamente.



HORNEADO / ASADO

NOTA – No es necesario un período de calentamiento previo antes de tostar.
Seleccione la posición deseada de la parrilla.
Gire la perilla selectora de función en la posición de horneado / asado o "BAKE - BROIL". Gire la perilla del reloj al tiempo deseado. Ambos elementos calentadores superior y el inferior estarán en funcionamiento.
Coloque los alimentos en la parrilla metálica.
NOTA – Los elementos calentadores superiores e inferiores se encenderán y apagarán alternadamente para mantener una temperatura moderada.
Cuando se haya completado el tostado, abra la puerta completamente y saque los alimentos.



ASADO / ROSTISADO

Seleccione la posición deseada de la parrilla. Coloque los alimentos y cierre la puerta colocándola en la primera parada, dejando aproximadamente un espacio de 3 pulgadas en la parte superior. Esto asegurará que el aire fluya de manera adecuada durante este proceso.
Gire la perilla de control de temperatura y colóquela en el nivel de temperatura más alto.
Gire la perilla selectora de función en la posición de asar o "Broil - Rotiss". Gire la perilla del reloj hacia el tiempo deseado. Solamente el elemento calentador de la parte superior estará en funcionamiento.
Coloque la bandeja para hornear, encima de la parrilla para asar. El reloj puede seleccionarse para que esté operando hasta por 60 minutos. Al final del ciclo de cocción, emitirá una señal auditiva y el horno se apagará automáticamente. Si la cocción requiere más tiempo repita el ciclo.
Cuando se haya completado la cocción, abra la puerta completamente y saque los alimentos cuidadosamente.





ASADO con CONVECCION

Gire la perilla de control de temperatura al nivel deseado.
Gire la perilla selectora de función en la posición de asado con convección o "Convection Rotiss". Ambos elementos calentadores, el superior y el inferior y el ventilador interno estarán en funcionamiento.
Coloque los alimentos en la parrilla metálica o dentro de la bandeja para hornear.
El reloj puede seleccionarse para que esté operando hasta por 60 minutos. Al final del ciclo de cocción, emitirá una señal auditiva y el horno se apagará automáticamente, usted puede repetir el ciclo de tiempo

si fuera necesario.

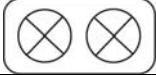
Cuando se haya completado el horneado, abra la puerta completamente y saque los alimentos.

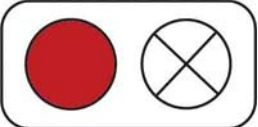
		COOK-TOP	
<ul style="list-style-type: none">• Coloque el sartén en la hornilla deseada.• Presione el selector de operation hacia la posición "COOKTOP".• Gire el selector de hornilla hacia la hornilla(s) deseada.• Gire la perilla del reloj hacia el tiempo deseado.• Las hornillas de su unidad funciona individualmente o juntos (Vea el grafico)• Después de usar las hornilla gire la perilla del relo y el selector de hornila hacia la posición OFF / .• Oprima el selector de operation hacia la posición OFF			
	AMBAS HORNILLAS ESTAN APAGADAS		SOLO LA HORNILLA DERECHA FUNCIONARA (500W)
	SOLO LA HORNILLA IZQUIERDA FUNCIONARA (900W)		AMBAS HORNILLAS FUNCIONARAN (1400W)

LIMPIEZA DE SU HORNO TOSTADOR

Antes de limpiar su Horno Tostador, desconéctelo y permita que se enfríe. Limpie con un paño suave y húmedo. No lo sumerja en agua! Asegúrese de usar solamente jabón suave y agua. Los limpiadores abrasivos, cepillos y limpiadores químicos pueden dañar el acabado de esta unidad. Vacíe la bandeja para migas frecuentemente para evitar la acumulación de residuos.

ALMACENANDO O GUARDANDO SU HORNO TOSTADOR

Deje que el aparato se enfríe completamente antes de almacenarlo. Si va a almacenar el horno tostador por períodos prolongados, asegúrese de que no contenga partículas o residuos de alimentos. Almacene el horno tostador en un lugar seco como encima de una mesa, mostrador, o sobre una repisa. Enrolle el cordón eléctrico. No es necesario otro tipo de mantenimiento que no sea la limpieza recomendada en este manual.

PROBLEMAS	POSIBLES CAUSAS/SOLUCIONES
Cocción excesiva o insuficiente de los alimentos.	Temperatura o tiempo incorrectos. <ul style="list-style-type: none"> • Usted debe asegurarse que el botón de temperatura esté posicionado a la temperatura deseada. • Debido a que su horno tostador es más pequeño que los hornos regulares este se calentará más pronto y generalmente cocinará en períodos de tiempo más cortos.
Olor a quemado.	<ul style="list-style-type: none"> • Si el olor se ocurre en cuando Ud. usa el horno por primera vez, esto es normal (Consulte la sección "Preparando su horno tostador" Acumulación de residuos de alimentos en el interior del horno, en los elementos calentadores o en la parrilla para migas. <ul style="list-style-type: none"> • Consulte la Sección "Limpieza de Su Horno Tostador"
El horno no inicia su operación Solamente un elemento calentador se calienta. El elemento calentador no se mantiene encendido.	La unidad está desconectada. <ul style="list-style-type: none"> • Enchufe el horno tostador en una toma de corriente eléctrica 120V / 60Hz. • Coloque la perilla de la temperatura en la posición deseada. Todos los demás controles deberán estar encendidos. La selección de la función determina cual elemento calentador operará. <ul style="list-style-type: none"> • Cuando tueste alimentos, asegúrese de que el horno no se encuentre en la función de asado. Los elementos calentadores se encenderán y se apagarán para mantener la temperatura adecuada. <ul style="list-style-type: none"> • Asegúrese de que la función seleccionada es la función que desea utilizar.

Registration Information

Thank you for purchasing this fine Avanti product. Please fill out this form and return it to the following address within 100 days from the date of purchase and receive these important benefits:

Avanti Products, A Division of The Mackle Co., Inc.
P.O.Box 520604 – Miami, Florida 33152

➤ **Protect your product:**

We will keep the model number and date of purchase of your new Avanti product on file to help you refer to this information in the event of an insurance claim such as fire or theft.

➤ **Promote better products:**

We value your input. Your responses will help us develop products designed to best meet your future needs.

------(detach here)-----

Avanti Registration Card

Name			Model #	Serial #
Address			Date Purchased	Store / Dealer Name
City	State	Zip	E-mail Address	
Area Code	Phone Number		Occupation	
Did You Purchase An Additional Warranty <input type="checkbox"/> Extended <input type="checkbox"/> None			As your Primary Residence, Do You: <input type="checkbox"/> Own <input type="checkbox"/> Rent	
Reason for Choosing This Avanti Product: Please indicate the most important factors That influenced your decision to purchase this product:			Your Age: <input type="checkbox"/> under 18 <input type="checkbox"/> 18-25 <input type="checkbox"/> 26-30 <input type="checkbox"/> 31-35 <input type="checkbox"/> 36-50 <input type="checkbox"/> over 50	
<input type="checkbox"/> Price <input type="checkbox"/> Product Features <input type="checkbox"/> Avanti Reputation <input type="checkbox"/> Product Quality <input type="checkbox"/> Salesperson Recommendation <input type="checkbox"/> Other: _____ <input type="checkbox"/> Friend / Relative Recommendation <input type="checkbox"/> Warranty <input type="checkbox"/> Other: _____			Marital Status: <input type="checkbox"/> Married <input type="checkbox"/> Single	
Comments:			Is This Product Used In The: <input type="checkbox"/> Home <input type="checkbox"/> Business	
			How Did You Learn About This Product: <input type="checkbox"/> Advertising <input type="checkbox"/> In-Store Demo <input type="checkbox"/> Personal Demo	

VER 01-09142010

PRINTED IN CHINA

Free Manuals Download Website

<http://myh66.com>

<http://usermanuals.us>

<http://www.somanuals.com>

<http://www.4manuals.cc>

<http://www.manual-lib.com>

<http://www.404manual.com>

<http://www.luxmanual.com>

<http://aubethermostatmanual.com>

Golf course search by state

<http://golfingnear.com>

Email search by domain

<http://emailbydomain.com>

Auto manuals search

<http://auto.somanuals.com>

TV manuals search

<http://tv.somanuals.com>