

Avanti[®]

WASHING MACHINE INSTRUCTION MANUAL

Model Numbers: W851/W852

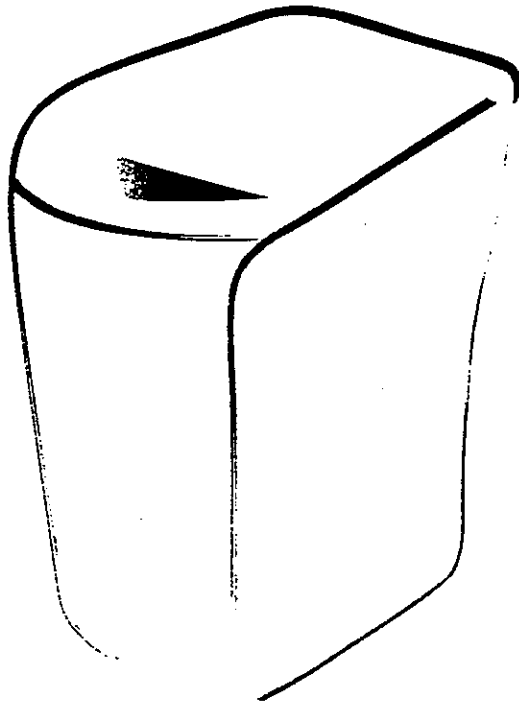

CAUTION:

BEFORE USE, PLEASE READ AND FOLLOW ALL SAFETY RULES AND OPERATING INSTRUCTIONS. SAVE THESE INSTRUCTIONS.

Avanti has a policy of continuous improvement on its products and reserves the right to change materials and specifications without notice.

Avanti Products
P.O. Box 520604 - Miami, Florida 33152
www.avantiproducts.com

Warranty Information

Thank you for purchasing this fine Avanti product. Please fill out this card and return it within 100 days of purchase and receive these important benefits:

- **Confirm your warranty:**
Your prompt product registration confirms your right to the protection available under the terms and conditions of your Avanti warranty.

- **Protect your product:**
We will keep the model number and date of purchase of your new Avanti product on file to help you refer to this information in the event of an insurance claim such as fire or theft.

- **Promote better products:**
We value your input. Your responses will help us develop products designed to best meet your future needs.

----- (detach here) -----

Avanti Registration Card

Name		Model #	Serial #
Address		Date Purchased	Store/Dealer Name
City	State	Zip	Occupation
Area Code	Phone Number		

As Your Primary Residence, Do You:

Own Rent

Did You Purchase An Additional Warranty:

Extended None

Reason For Choosing This Avanti Product:

Please indicate the most important factors that influenced your decision to purchase this product.

- Price
- Product Features
- Avanti Reputation
- Product Quality
- Salesperson Recommendation
- Friend/Relative Recommendation
- Warranty
- Other _____

Your Age:

under 18 18-25 26-30
 31-35 36-50 over 50

Marital Status:

Married Single

Is This Product Used In The:

Home Business

How Did You Learn About This Product:

Advertising Product Features
 In Store Demo Personal Demo
 Other _____

Comments _____

HELP US HELP YOU...

Read this guide carefully.

It is intended to help you operate and maintain your new appliance properly.

Keep it handy to answer your questions.
If you don't understand something or your need more help, please call:

Avanti Customer Service
800-220-5570

Keep proof of original purchase date (such as your sales slip) with this guide to establish the warranty period.

Write down the model and serial numbers.

You'll find them on a plate located on the back wall of the appliance.

Please write these numbers here:

Date of Purchase

Model Number

Serial Number

Use these numbers in any correspondence or service calls concerning your appliance.

If you received a damaged appliance, immediately contact the dealer (or builder) that sold you the appliance.

Save time and money. Before you call for service, check the Troubleshooting Guide. It lists causes of minor operating problems that you can correct yourself

IF YOU NEED SERVICE

We're proud of our service and want you to be pleased. If for some reason you are not happy with the service you receive, here are some steps to follow for further help.

FIRST, contact the people who serviced your appliance. Explain why you are not pleased. In most cases, this will solve the problem.

NEXT, if you are still not pleased, write all the details, including your telephone number, and send to:

Customer Service
Avanti Products
10880 NW 30 Street
Miami, FL 33172

PARTS AND FEATURES

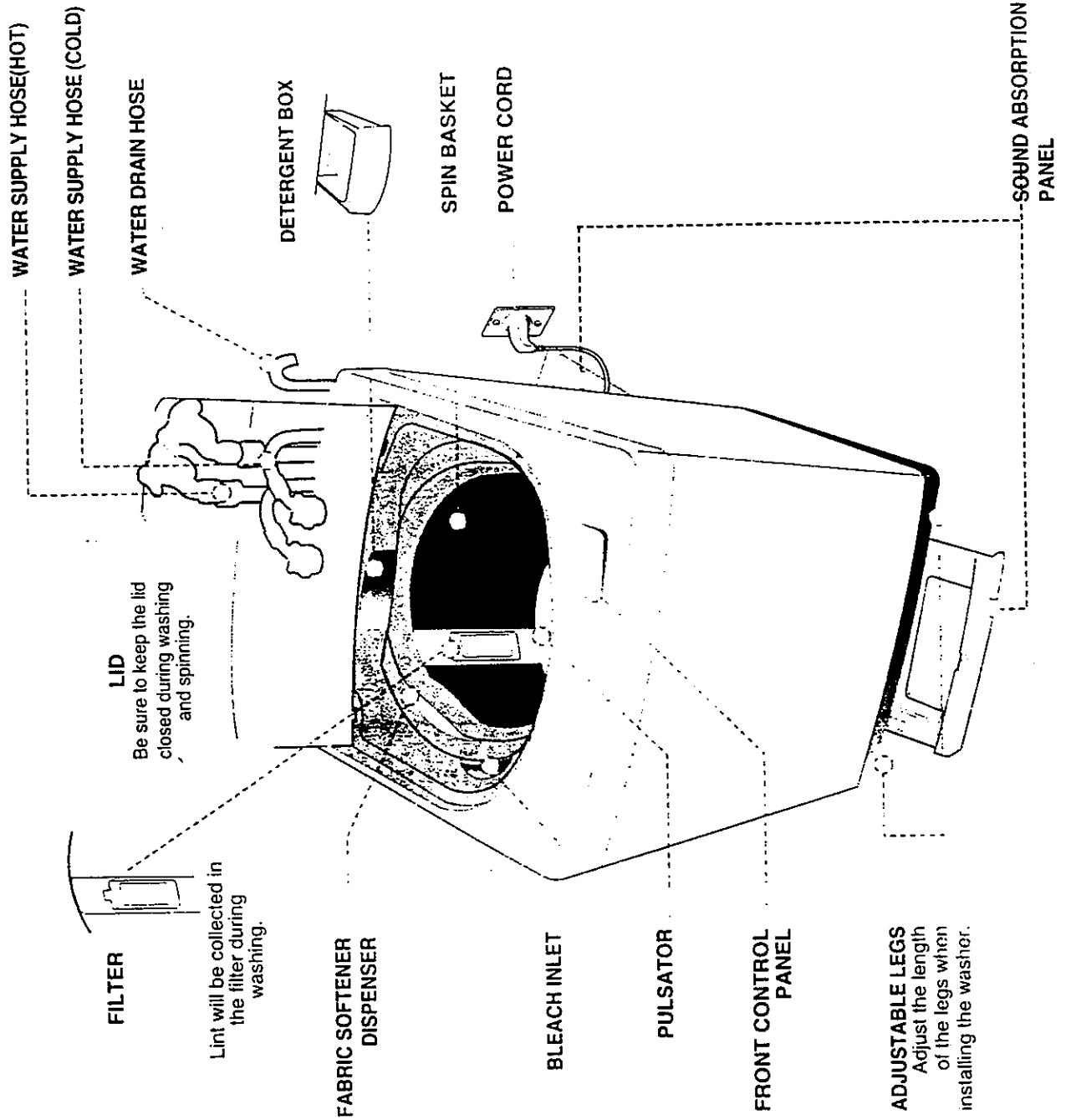

TABLE OF CONTENTS

Warranty Information and Registration Card	2
Help Us Help You	3
Parts and Features	4
Important Safety Instructions	6-7
Installation Instructions	8
Before Using Your Appliance	8
Installation of Your Appliance	9
Water Connections	10
Electrical Connection	11
Care and Maintenance	11
Control Panel	12
Washing Procedure	13-15
Troubleshooting Guide	16
Service For Your Appliance	16
Your Avanti Products Warranty	17
Parts Breakdown and Parts List	18
Wiring Diagram	22
Spanish Section	23 - 31

Important Safety Instructions



To reduce the risk of fire, electrical shock, or injury when using your appliance, follow these basic precautions:

- Read all instructions before using the appliance.
- Do not wash articles that have been previously cleaned in, washed in, soaked in, or spotted with gasoline, dry-cleaning solvents, other flammable, or explosive substances as they give off vapors that could ignite or explode.
- Under certain conditions, hydrogen gas may be produced in a hot water system that has not been used for 2 weeks or more. **HYDROGEN GAS IS EXPLOSIVE.** If the hot water system has not been used for such a period, before using a washing machine, turn on all hot water faucets and let the water flow from each for several minutes. This will release any accumulated hydrogen gas. As the gas is flammable, do not smoke or use an open flame during this time.
- Before the appliance is removed from service or discarded, remove the door.
- Do not tamper with controls.
- Do not repair or replace any part of the appliance or attempt any servicing unless specifically recommended in the user-maintenance instructions or in published user-repair instruction.
- **DANGER or WARNING :** Risk of child entrapment.
Child entrapment and suffocation are not problems of the past. Junked or abandoned appliances are still dangerous. . . even if they will "just sit in the garage a few days."
- **Before you throw away your old appliance:** Take off the door so that children may not easily climb inside.
- Never allow children to operate, play with, or crawl inside the appliance.
- Never clean appliance parts with flammable fluids. The fumes can create a fire hazard or explosion.
- Do not place the washer in steamy rooms or where the washer is directly exposed to rain. Moisture may destroy the electrical insulation causing an electrical shock hazard.
- During spinning, don't put your hand in the spin basket: Because the spin basket is rotating at high speed, rotating parts may injure your hand.



Important Safety Instructions

- Do not store or use gasoline or any other flammable vapors and liquids in the vicinity of this or any other appliance. The fumes can create a fire hazard or explosion.
- Turn off water taps when the washer is not in use to avoid water pressure damage to the pump.
- To minimize the possibility of electric shock, unplug this appliance from the power supply or disconnect the washer at the household distribution panel by removing the fuse or switching off the circuit breaker before attempting any maintenance or cleaning.
- The appliance is not intended for use by young children or infirm persons without supervision.
- If the power supply cord is damaged, it must be replaced by the manufacturer or its service agent or a similarly qualified person in order to avoid a hazard.
- Place clothes evenly into the washer as unevenly distributed laundry may cause excessive out of balance noise and vibration.
- Do not operate this appliance if it is damaged, malfunctioning, partially disassembled, or has missing or broken parts, including a damaged cord or plug.

-Save these instructions-



INSTALLATION INSTRUCTIONS

Before Using Your Appliance

- Remove the exterior and interior packing.
- Check to be sure you have all of the following parts:
 - Hot Water Supply Hose
 - Cold Water Supply Hose
 - Drain Hose (Pump)
 - Instruction Manual
 - Absorbing Panel & Screw
 - Male and Female Hose Thread Adapters
 - Support Legs
- Clean the interior surface with lukewarm water using a soft cloth.
- Place your washer on a floor that is strong enough to support the appliance when it is fully loaded.
- To level your washer, adjust the legs at the front of the appliance.
- Allow 5 inches of space between the back and sides of the appliance.
- Carpeting must not obstruct ventilation openings when the washing machine is installed on a carpeted floor.
- Locate the appliance away from direct sunlight and sources of heat (stove, heater, radiator, etc.). Direct sunlight may affect the acrylic coating, plastic and electrical components.
- Put your laundry into the washer evenly. Uneven laundry may cause noise or vibration.
- Don't use excessively hot water 50°C(122°F) or more. Plastic parts may be deformed or damaged. Also, clothing may be deformed or bleached.
- Before washing, check all pockets. If nails or pins remain in pockets, they may damage the washer or clothes.
- Never splash water on the control panel.
- Plug the washer into an exclusive properly installed-grounded wall outlet. Do not under any circumstances cut or remove the third (ground) prong from the power cord. Any questions concerning power and or grounding should be directed toward a certified electrician or an authorized Avanti Products service center.

INSTALLATION INSTRUCTIONS

➤ Assembling The Sound Absorbing Panel!

Lay down the washer with the rear side facing up and insert the panel until it clicks into the five slots provided (as shown in the figure). Use the screw in the hole provided to tighten the absorbing panel to the bottom of the washer.

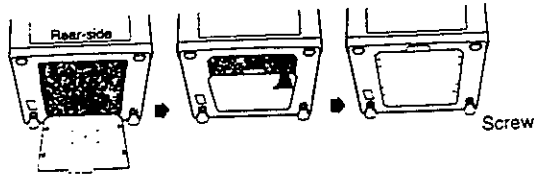

➤ Leveling

SEE IF THE MACHINE IS PLACED LEVEL BY CHECKING THE POSITION OF THE WASHING TUB.

- Open the lid of the machine. pour water into the tub up to the level just below the pulsator, and adjust the legs so that the pulsator is positioned at the center of the water as shown in the figure below.
- Place the machine more than 10cm away from the wall.

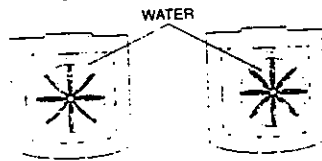

- Adjust the front legs for levelling.



Note : The protective rubber support inserts may leave marks on certain floor types. To prevent possible markings place a small piece of cloth, or similar item, under the rear legs when the machine is in use.

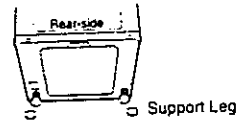

➤ Connecting The Drain Hose

- Take out the cap-hose and connect the outlet hose.

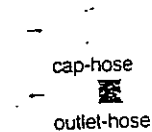

- Be sure to join tightly the drain hose outlet on the back of the machine.

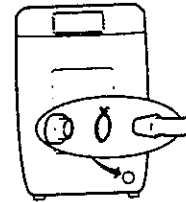

- Install the drain hose 28-32 inches above the ground.

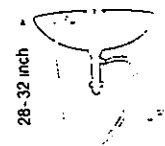

CAUTION : Drain hose may pop up during draining due to heavy water pressure. This is normal. We suggest to hold it down with a heavy water proof object, to keep hose in place.

> Cleaning the Magic Filter

1. Push the upper part of the filter and pull in.

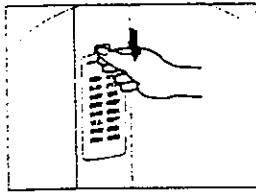

2. Open the cover as shown in the figure.

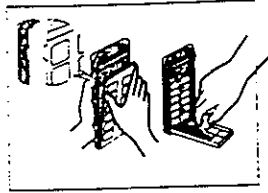

3. Clean the filter.

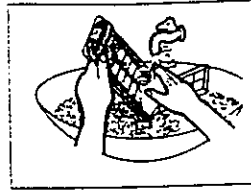

4. Close the cover and insert the lower part of the filter in the basket first and then push the filter until you hear a "click" sound.

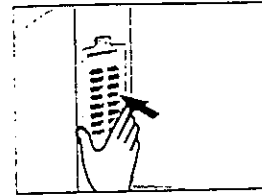

> Water Connection

For normal kitchen-sink tap only use the inlet hose with cold water inlet.

Connect the inlet hose to the male hose thread adapter by turning it clockwise to be fixed tightly.

Make sure to insert the rubber ring enclosed. Then connect tightly to your sink.

Note : Some faucets may require you to also use the female hose thread adapter between the male adapter and your sink as shown below. Make sure the rubber ring is inserted and connect to your sink.

Only necessary on some faucets.

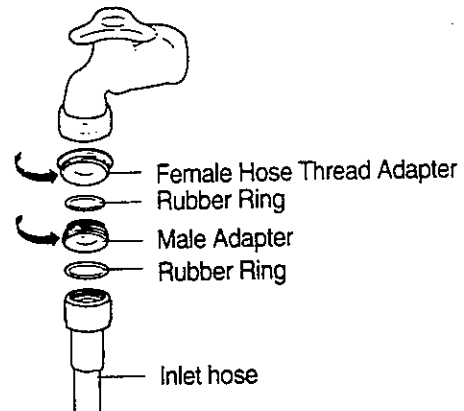
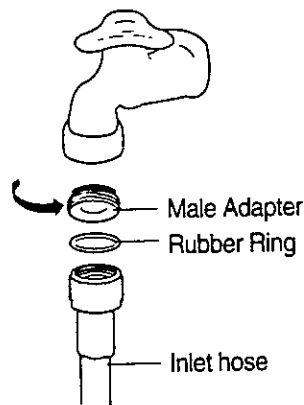

> Connecting The Water Supply Hoses

1. Your washer is provided with dual water inlets (hot & cold)
Connect the water supply hose to the water tap.
Fasten it tightly.

2. Next, connect the other end of the water supply hose to the inlet valve at the back of the washer.
Screw the hose clockwise all the way in.

3. When using as a portable washer connect hose to the cold side of the water valve.



> **Note:**

Be sure to connect the hot inlet hose to hot water tap and hot water valve. For best operating conditions your hot water should be approximately 50°C (122°F) otherwise water above this temperature will cause damage to the machine.

Turn on the water completely to check for any leakage.

If any, turn off the water and try again above procedures.

For special tap, use connectors provided or call a qualified plumber for the installation.

➤ Electrical Connection

⚡ Warning ⚡

Improper use of the grounded plug can result in the risk of electrical shock. If the power cord is damaged, have it replaced by an authorized Avanti Products service center.

This appliance should be properly grounded for your safety. The power cord of this appliance is equipped with a three-prong plug which mates with standard three prong wall outlets to minimize the possibility of electrical shock.

Do not under any circumstances cut or remove the third ground prong from the power cord supplied.

Use of extension cords is not recommended.

This appliance requires a standard 115/120-volt, 60Hz electrical outlet with three-prong ground. The cord should be secured behind the appliance and not left exposed or dangling to prevent accidental injury.

CARE AND MAINTENANCE

➤ Cleaning Your Washer

- Wash the inside with a warm water and baking soda solution. The solution should be about 2 tablespoons of baking soda to a quart of water.
- The outside of the washer should be cleaned with mild detergent and warm water.

FEATURES

➤ Fuzzy Control

Fuzzy control operates with best washing course by sensing the washload like artificial intelligence.

➤ Clear window

This see-thru Window is a new concept to solve the curiosity of users to see inside the washing machine while in operation. The laundry progress can be checked by looking through the clear window.

➤ Clean Wash By The Water Fall

Water Fall, falling down from top of the tub, cleans heavy dirt and dissolves detergent thoroughly with impact power.

➤ Boomerang pulsator

The Boomerang Pulsator helps water and detergent go through fabrics efficiently while providing both the powerful water action to clean larger and heavier clothes, and the gentle water action to clean all delicates with less wear and tear on clothes.

CONTROL PANEL

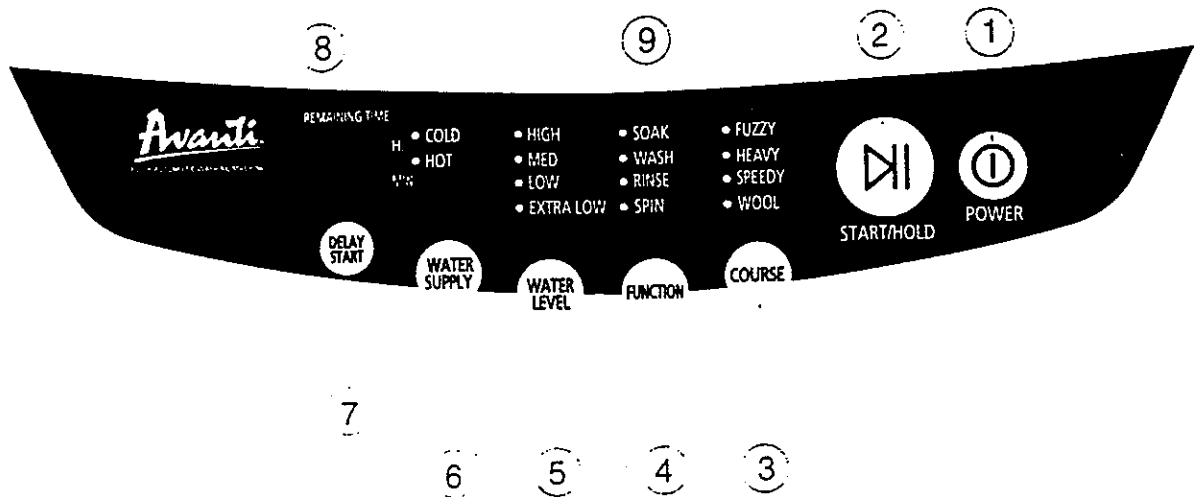

- 1) **Power Button**
Press this button once to operate. Press once again to turn the washer off.
- 2) **Start/Hold Button**
Use to pause and restart the operation. To change the washing procedure during operation, press this button to stop, and once again to restart after changing the procedure.
- 3) **Course Select Button**
With every press of this button, the washing course changes;
Fuzzy → Heavy → Speedy → Wool → Fuzzy
- 4) **Function Select Button**
With every press of this button, the washing course changes;
Wash+Rinse+Spin → Soak+Wash+Rinse+Spin → Wash → Rinse → Spin → Wash+Rinse → Rinse+Spin → Wash+Rinse+Spin
- 5) **Water Level Select Button**
According to the washload, select the water level:
Med → High → Extra Low → Low
- 6) **Water Supply Select Button**
As you press this button, the type of water is selected as follows.
Cold → Cold+Hot → Hot → Cold
When using as a portable washer use cold water setting only.
- 7) **Delay Start Button**
Press this button when delay start washing is needed.
- 8) **Remaining Time Indicator Light**
The indicator light shows the remaining time (in Minutes) of each wash cycle.
At the end of the cycle, the power automatically switches off.
- 9) **Function Indicator Light**
The function in use indicator shows the current function as a flashing symbol.
The light goes out at the end of the function.

WASHING PROCEDURE

FUZZY COURSE

Selects the best washing course automatically.

- 1) **Before starting washing, check the following;**
Connect the water supply hose to the water tap. Leave the tap open. Plug the power cord in.
- 2) **Put the laundry into the washer and add detergent, too.**
Be careful not to overload. Use right detergent for the fabrics you are washing.
- 3) **Press the POWER Button to "ON".**
The remaining time indicator should show "- -"



- 4) **Press the START/HOLD Button.**
Water level is selected automatically. Washing, rinsing, and spinning follow. If you want to pause, press the START/HOLD button again.
You can change the course when in pause mode.



- 5) **Close the Lid.**

HEAVY COURSE

For the heavy laundry, it gives powerful washing.

- 1) **Press the power button to "ON".**
- 2) **Press the course select button once.**
- 3) **Press the START/HOLD button.**
Water level is selected automatically. Washing, rinsing, and spinning follow.
If you want to pause, press the START/HOLD button again.
You can change the course when in pause mode.
• 10 minutes operation (1 minute for washing and 4 minutes for soaking) carry out during 30 minutes.



- 4) **Close the Lid.**

SPEEDY COURSE

Because washing is speedy, it is good for light or less stained laundry.

- 1) Press the power button to "ON"



- 2) Press the course select button three times.



- 3) Press the START/HOLD button
Water level is selected automatically. Washing, rinsing, and spinning follow. If you want to pause, press the START/HOLD button again. You can change the course when in pause mode.



ex)
High level

- 4) Close the Lid.

WOOL COURSE

Only high or medium water level is available. Cold water is selected.

- 1) Press the power button to "ON".



- 2) Press the course select button twice.



- 3) Press the START/HOLD button.
Washing, rinsing, and spinning follow. If you want to pause, press the START/HOLD button again. You can change the course when in pause mode.



START/HOLD



ex)
Low level

- 4) Close the Lid.

CAUTION:

- Do not use water above 30°C for WOOL washing.
- Refer to the tag attached on the clothes for washing information.
- Fasten buttons and turn inside out before washing.
- Use the detergent indicated in the laundry.
- When the degree of dirt is extreme, soak the laundry in warm water for about 10 minutes before pressing the WOOL course button in order to enhance washing efficiency.

DELAY START COURSE

Select this course when you have to go out or do something else.

1. Press the Power button to "ON".



2. Press the DELAY START button once.
You may change the delay start time with use of the DELAY START button. (From 3 hours to 18hours)



3. Press the START/HOLD button and put the proper amount of detergent into the detergent box.



4. Close the lid.
The washing starts at the time you selected.

MANUAL FUNCTIONS

SOAK AND WASH AND RINSE AND SPIN

Press the POWER button. Press the FUNCTION SELECT button once. Press the START/HOLD button once. Washing goes on for 69 minutes.

The laundry is soaked in water so that the dirt can be eliminated completely.

When the FUNCTION button is pressed during operation the rinse times can be changed to between 1 and 5 times in duration.

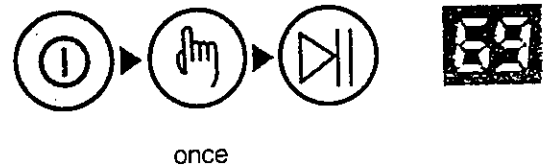

WASH ONLY

Press the POWER button. Press the FUNCTION SELECT button twice. Press the START/HOLD button once. Washing goes on for 18 minutes.

When the FUNCTION button is pressed during washing, the washtime can be changed to between 3 and 25 minutes in duration.

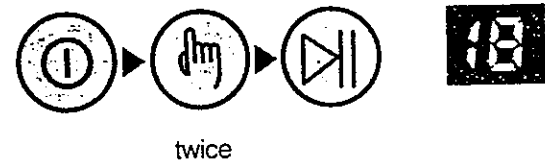

RINSE ONLY

Press the FUNCTION button three times. Press the START/HOLD button once. Rinsing goes on for 5 minutes.
When the FUNCTION button is pressed during rinsing, the rinse times can be changed to between 1 and 5 times in duration.

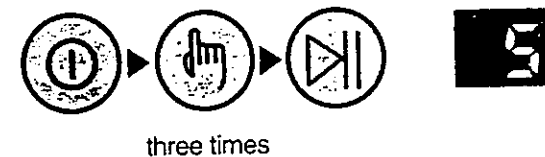

SPIN ONLY

Press the FUNCTION button four times. Press the START/HOLD button once. Spin-drying goes on for 11 minutes.
When the FUNCTION button is pressed during spinning, the spin time can be changed to from 1 to 7 minutes.

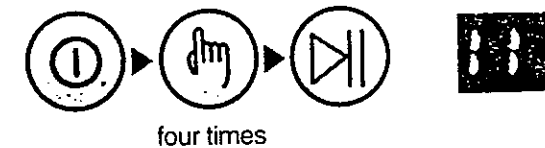

WASH AND RINSE

Press the FUNCTION button five times. Press the START/HOLD button once. Washing and rinsing go on for 28 minutes.
When the FUNCTION button is pressed during operation the rinse times can be changed to between 1 and 5 times in duration.

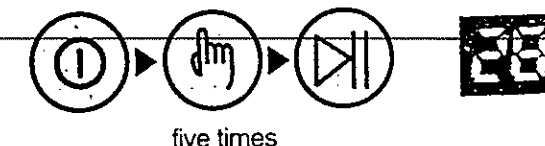

RINSE AND SPIN

Press the FUNCTION button six times. Press the START/HOLD button once. Washing, rinsing and spinning follows. When the FUNCTION button is pressed during operation, the rinse times can be changed to between 1 and 5 times in duration.

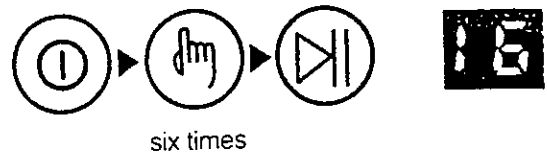

six times

WASH, RINSE AND SPIN

Press the FUNCTION button seven times. Press the START/HOLD button once. Washing, rinsing and spinning follow. When the Function button is pressed during operation the rinse times can be changed to between 1 and 5 times in duration.

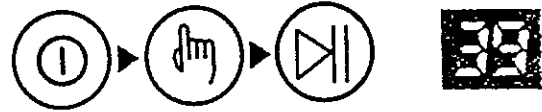

seven times

PROBLEMS WITH YOUR WASHER?

You can solve many common appliance problems easily, saving you the cost of a possible service call. Try the suggestions below to see if you can solve the problem before calling the servicer.

TROUBLESHOOTING GUIDE

PROBLEM	POSSIBLE CAUSE
Washer does not operate.	Not plugged in. The circuit breaker tripped or blown fuse.
Vibrations.	Check to assure that the washer is level.

➤ Washing machine won't work

- Is the water tap opened?
- Is the washer plugged in?
- Is the power cut off?
- Is there enough water?



➤ Water is not supplied

- Is the water tap opened?
- Is the water cut off?
- Is the water supply hose or hose connection clogged?
- Is the water tap frozen?

If water is not supplied in 1 hour, a buzzer will sound, and the remaining time indicator will show "4E / 7E".

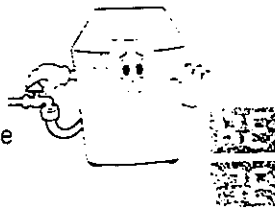

➤ Water dose not drain

- Is the drain hose down? (No pump)
- Is the drain hose frozen?
- Is the drain hose clogged?

If the water dose not drain in 15 minutes, a buzzer will sound, and the remaining time indicator will show "E / 5E".



➤ Spinning does not work

- Is the laundry spread out evenly in the washer?
- Is the washer set on a sturdy flat surface?

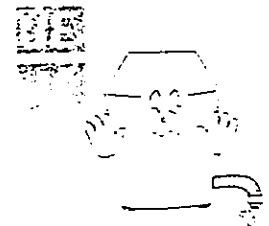

➤ Water is overflowed

- Restart after spinning.
- If the error sign still indicates, call agency.

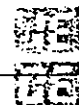

YOUR Avanti Products WARRANTY

Staple your sales receipt here. Proof of original purchase date is needed to obtain service under warranty.

WHAT IS COVERED LIMITED ONE-YEAR WARRANTY

For one year from the date of purchase by the original owner, Avanti Products will, at its option, repair or replace any part of the appliance that proves to be defective in material or workmanship under normal use. During this period Avanti Products will provide all parts and labor necessary to correct such defects free of charge, so long as the appliance has been installed and operated in accordance with the written instructions in this manual. In rental or commercial use, the warranty period is 90 days.

LIMITED 5 YEAR WARRANTY ON PLASTIC TUB

After one year and until five years from date of purchase, Avanti will furnish a replacement plastic tub, which is defective in material or workmanship. You will be charged for labor.

LIMITED 7 YEAR WARRANTY ON STAINLESS STEEL TUB

After one year and until seven years from date of purchase, Avanti will furnish a replacement stainless steel tub, which is defective in material or workmanship. You will be charged for labor.

WHAT IS NOT COVERED

- Incidental or consequential damages.
- Parts and labor costs for the following will not be considered as warranty:
 - Plastic cabinet liners.
 - Repairs performed by unauthorized servicers.
 - Service calls that do not involve defects in material or workmanship such as customer education, or improper installation.
- Service calls that are related to external problems, such as abuse, misuse, inadequate electrical power, accidents, fire, floods, or acts of God.
- Replacement of house fuses or resetting circuit breakers.
- Failure of the product if it is used for other than its intended purpose.
- This warranty does not apply outside the Continental U.S.A.

SERVICE FOR YOUR WASHER

We are proud of our customer service organization and the network of professional service technicians that provide service on your Avanti appliances. With the purchase of your Avanti washer, you can have the confidence that if you ever need additional information or assistance, the Avanti Products Customer Service team will be here for you. Just call us toll-free.

AVANTI PRODUCTS CUSTOMER SERVICES

Product Information 800-323-5029	Whatever your questions are about our products, help is available.
Part Orders 800-220-5570	You may order parts and accessories that will be delivered directly to your home. You may order these items by personal check, money order, Master Card, or Visa.
In-Home Repair Service 800-220-5570	An Avanti Products authorized service center will provide expert repair service, scheduled at a time that is convenient for you. Our trained servicers know your washer inside and out.

Parts Breakdown

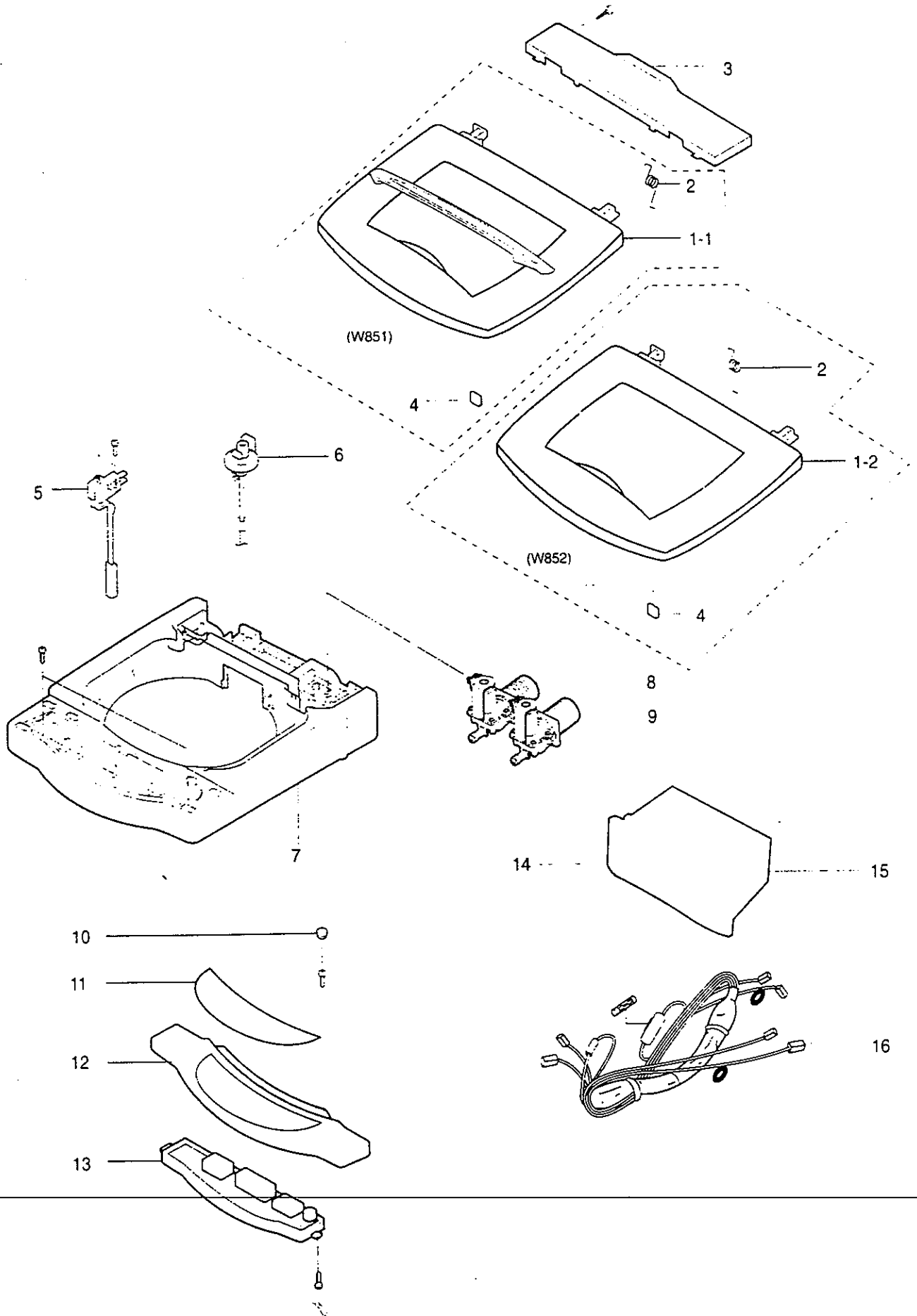

Parts Breakdown

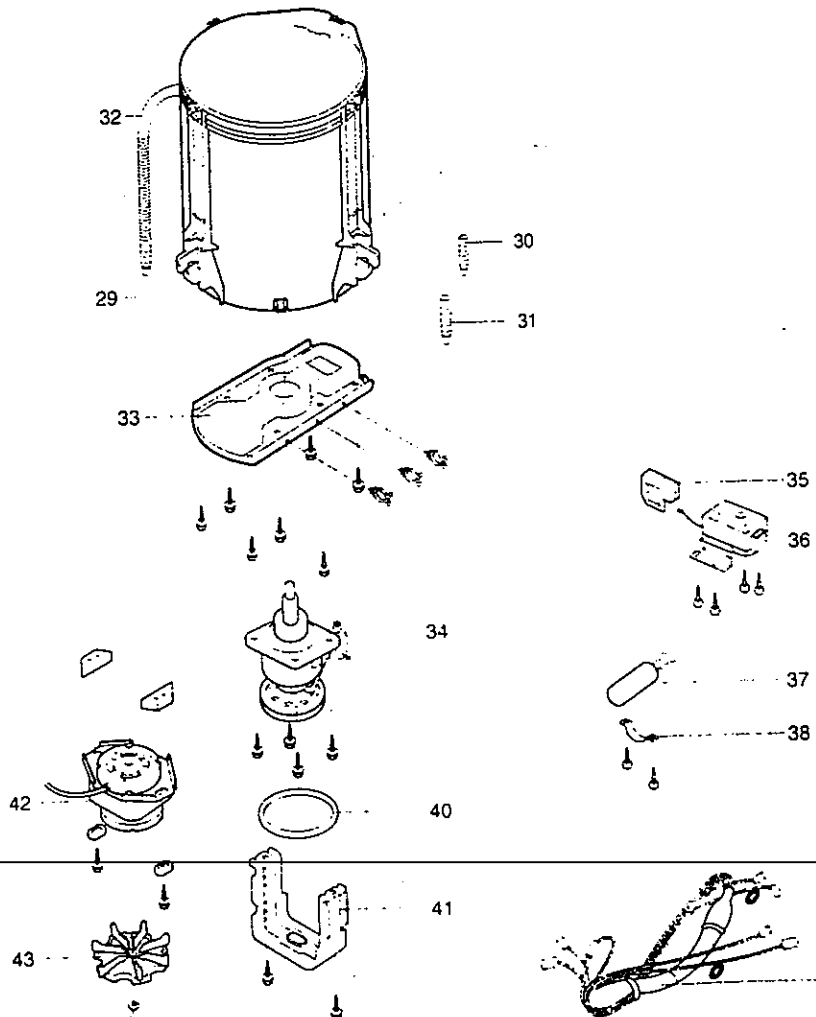
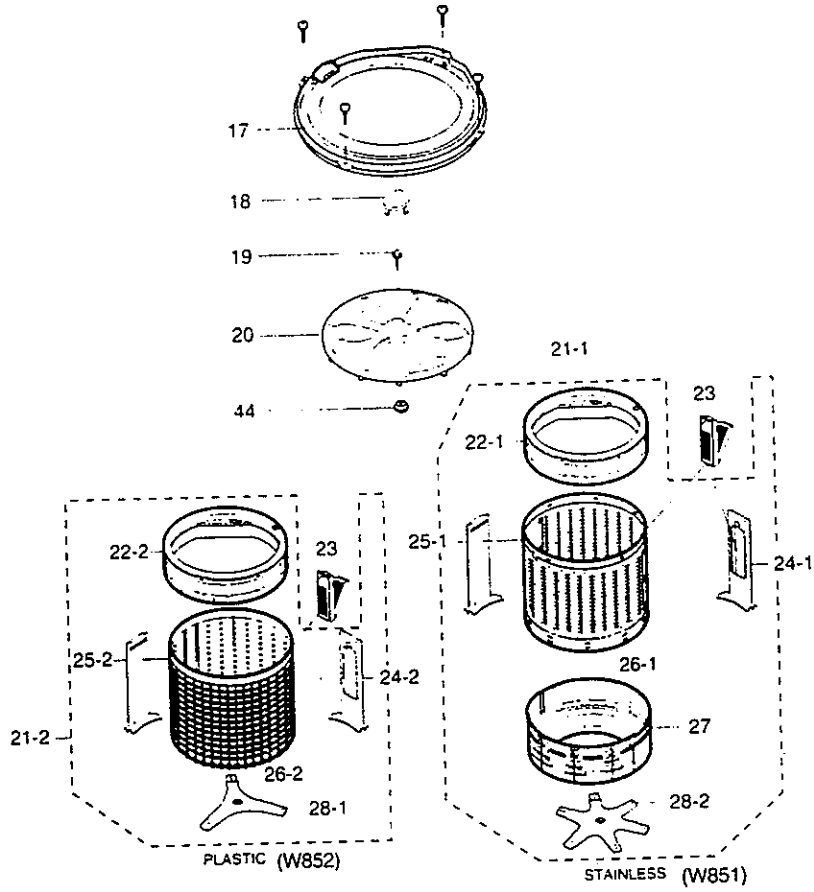

Parts Breakdown

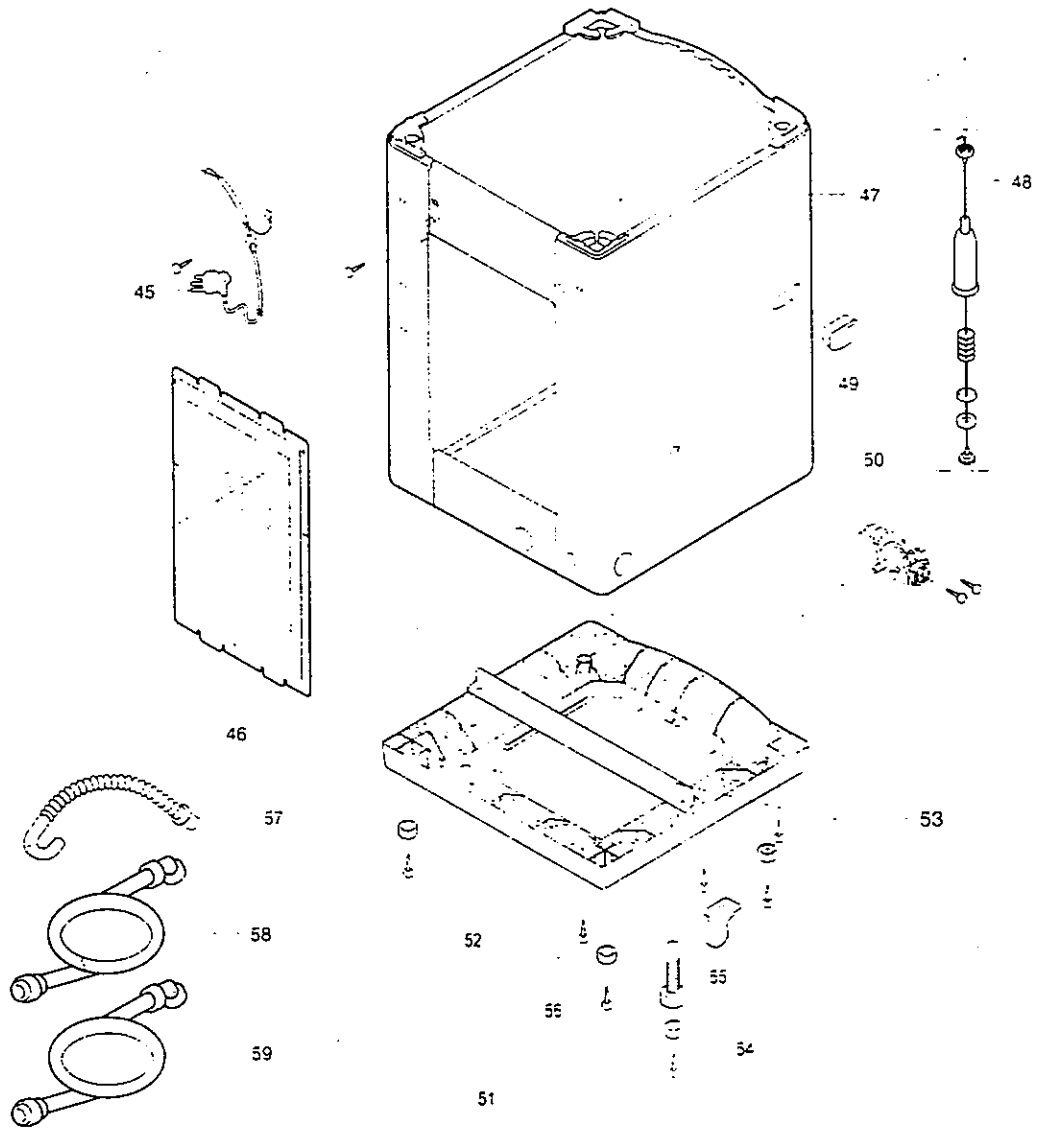

Parts List

Location No.	Code No.	Description	Specification	Qty	Remarks
1-1	DC97-01750P	ASSY-LID T.C	W851/W852.SWHT(POWER/DRUM)	1	
1-2	DC97-01751K	ASSY-LID T.C	W852DW/YML,SNOW:WHT(NO-PRINT)	1	
2	DC61-00343A	SPRING-Q(R):	KS-PJT,STEEL WIRE.CD2.0.-.	1	
3	DC63-00283E	COVER-T.C	W851/W852.ABS.....AVANT.SNOW/W-T.NO-PRINT	1	
4	DC61-60044J	CUSHION-LID:	SW-46J1.NBR.-...T5.5-LIGHT	6	
5	DC90-10104K	ASSY-CHECKER S/W:	WA7564C0.5KG/STANDARD/1	1	
6	DC32-30006T	SENSOR PRESSURE:	DN-S18,-...5KG/STANDARD,	1	
7	DC63-00124G	COVER-TOP;	WA7064C1.ABS.-...SNOW/WHT.NON-	1	
8	DC62-30310K	VALVE-WATER:	SW70AI.PP.-...110-120V/50-	1	
9	DC62-30310M	VALVE-WATER:	SW70AI.PP.-...110-120V/50-	1	
10	DC61-10331P	COVER-SCREW:	-ABS.-...WHT,SW-5A1	1	

Parts List

Location No.	Code No.	Description	Specification	Q'ty	Remarks
11	DC64-00287G	INLAY-PANEL	W851/W852,PET,....SNOW/WHT,AVANTI/OEM	1	
12	DC63-00185F	PANEL-CONTROL	W851/W852,ABS(V0),....SNOW/WHT,KS6/INLAY/UL-AVANTI	1	
13	MF-KS6AVT-09	ASSY PCB PARTS	MF-KS6AVT-09	1	
14	DC63-00125F	CASE-DETERGENT:	WA7064C1DW/YE,ABS,....	1	
15	DC97-01838A	ASSY-BODY DETERGENT:	SEOUL-PJT.BACK-TPYE	1	
16	DC96-00433A	ASSY-M.WIRE HARNESS	W851/AVANTI.H+C(REED-S/W)UL1015	1	
17	DC61-00129A	COVER-TUB:	PP,P-COOL/GRY,G6-NEW/6KG	1	
18	DC66-00032A	PULSATOR-CAP:	ABS,PEACOCK/GRN,SEW-G6/G8,-	1	
19	DC60-00004A	BOLT-PULSATOR:	-.HEX,M6,L20.5,-.SW70A1.	1	
20	DC66-50194D	PULSATOR:	PP,LIGHT/GRY,SEW-M550,HI50S.-	1	
21-1	DC97-00155R	ASSY-S.BASKET SPIN:	WA8540D0/R6.M-FILTER(1	
21-2	DC97-00113F	ASSY-S.BASKET	SPIN SW70C1(PP),M-FILTER(P/GRY)3WING	1	
22-1	DC97-01807A	ASSY-BALANCER:	SW-R6,R6-PJT	1	
22-2	DC97-00033A	ASSY-BALANCER	SEW-G6,1.18/1960GR	1	
23	DC97-00114F	ASSY-FILTER:	G6,ABS/GRN	1	
24-1	DC61-00336A	GUIDE-W.F(P):	WA8065D1,PP,....R6-PJT	1	
24-2	DC61-60524A	GUIDE-W.F(P)	SW70A1(G6),SHV-745CC1,SSEC,....N/GRY(FALL)	1	
25-1	DC61-00337A	GUIDE-W.F(F):	WA8065D1,PP,....R6-PJT	1	
25-2	DC61-60525A	GUIDE-W.F(P)	SW70A1(G6),TN-5630T,SSEC,....N/GRY(FILTER)	1	
26-1	DC61-00333A	BASKET-WRAPPER	WA8065D1,STS430,....T0.5	1	
26-2	DC61-30123A	BASKET-SPIN	PANTONE-CO,....SW-5A1	1	
27	DC61-00335A	BASKET-BOWL	WA8065D1,PP,....R6-PJT	1	
28-1	DC66-40010A	FLANGE-SHAFT:	-.ALDC,....SW-5A1	1	
28-2	DC66-00046B	FLANGE-SHAFT	SW70D1,ALDC,....ID- PROCESS	1	
29	DC61-00128A	TUB-OUTER:	-.PP,....NTR,G6-NEW/6kg	1	
30	DC62-10293A	HOSE-DRAIN	-.EPDM,....L245,BLK,SW-5C1P	1	
31	DC62-10092C	HOSE-PUMP	-.EPDM,ID30,....L349.5,BLK,SW-5C1P	1	
32	DC62-00020B	HOSE- O.F:	-.LDPE,ID18,OD22 L560	1	
33	DC61-70063A	DIE-MOTOR:	-.SBHG1,....T1.6	1	
34	SCA-06RPHF21	ASSY-CLUTCH:	SCA-06RPHF21	1	
35	DC66-00140A	LINK:	SEM-AM550,PP+TALC30%,....NTR,-	1	
36	DC31-20014D	MOTOR DRAIN:	KD-SM11TB,100-120V,50-60HZ(B	1	
37	DC62-00015G	CONDENSER-M.F	DAL-2EJ030,UL CAN TYPE,....D40,L75,.....250VAC 30MFD	1	
38	DC61-40077A	HOLDER-CONDENSER:	PP,....NTR	1	
39	DC96-00322A	ASSY-WIRE HARNESS:	MC(G6),SUB/REC/PUMP	1	
40	DC66-10170B	BELT-V;	RUBBER,M21.6,L596,SEW-950,-	1	
41	DC61-40053B	SADDLE:	T1.0,EGI,....SW-5A1	1	
42	DC31-10025W	MOTOR-WASHING:	WAS161WQSA,SW-70X1,-60HZ,	1	
43	DC66-10175A	PULLEY-MOTOR:	ALDC,M20,PCD41.8,SW80W1P,60	1	
44	DC60-50004A	NUT-SPIN:	1C,M24,ALDC,-	1	
45	DC96-00038B	ASSY-POWER CORD	W752P,HOUSING-TYPE(SAMIL)125V/10A(UL/CSA)	1	
46	DC63-00232A	COVER-BACK:	WA7564CO,SBHG-A.T0.4,....KS6-	1	
47	DC99-00087A	ASSY-PAINT:	W751SC:AVANTI,GE-WHT,HANDLE/P	1	
48	DC97-00121B	ASSY-DAMPER:	SW70C1,REAR	2	
49	DC61-20018Q	HANDLE:	PP(BJ-730),....SNOW/WHT,WS7000.	2	
50	DC96-00256C	ASSY-PUMP DRAIN:	GE,(120V/60Hz)COVER	1	
51	DC97-00398N	ASSY-BASE	W851DW/YML(KS6),CASTER(NIGHT/GRY)	1	
52	DC61-00163A	BASE:	-.PP,....SYSTEM/GRY,SW70D1	1	
53	DC61-00243A	GUIDE-FRAME(R)	W752/W751S.CR(SCP1),....T2.3XW21XL535	1	
54	DC97-00170A	ASSY-LEG:	SW70A1P,PP+RUBBER(70HS)	1	
55	DC61-40077A	HOLDER CONDENSER	PP	1	
56	DC61-50015B	LEG-RUBBER:	BUTYL,SW70A1,BLK	3	
57	DC97-00139C	ASSY-HOSE DRAIN(O)	SW65ASP2/SW55APP2,PUMP-TYPE	1	
58	DC97-01298A	ASSY-HOSE WATER	W751SC,1.5MT/METER/COLD	1	
59	DC97-01298B	ASSY-HOSE WATER	W751SC,1.5MT/METER/HOT	1	

Wiring Diagram

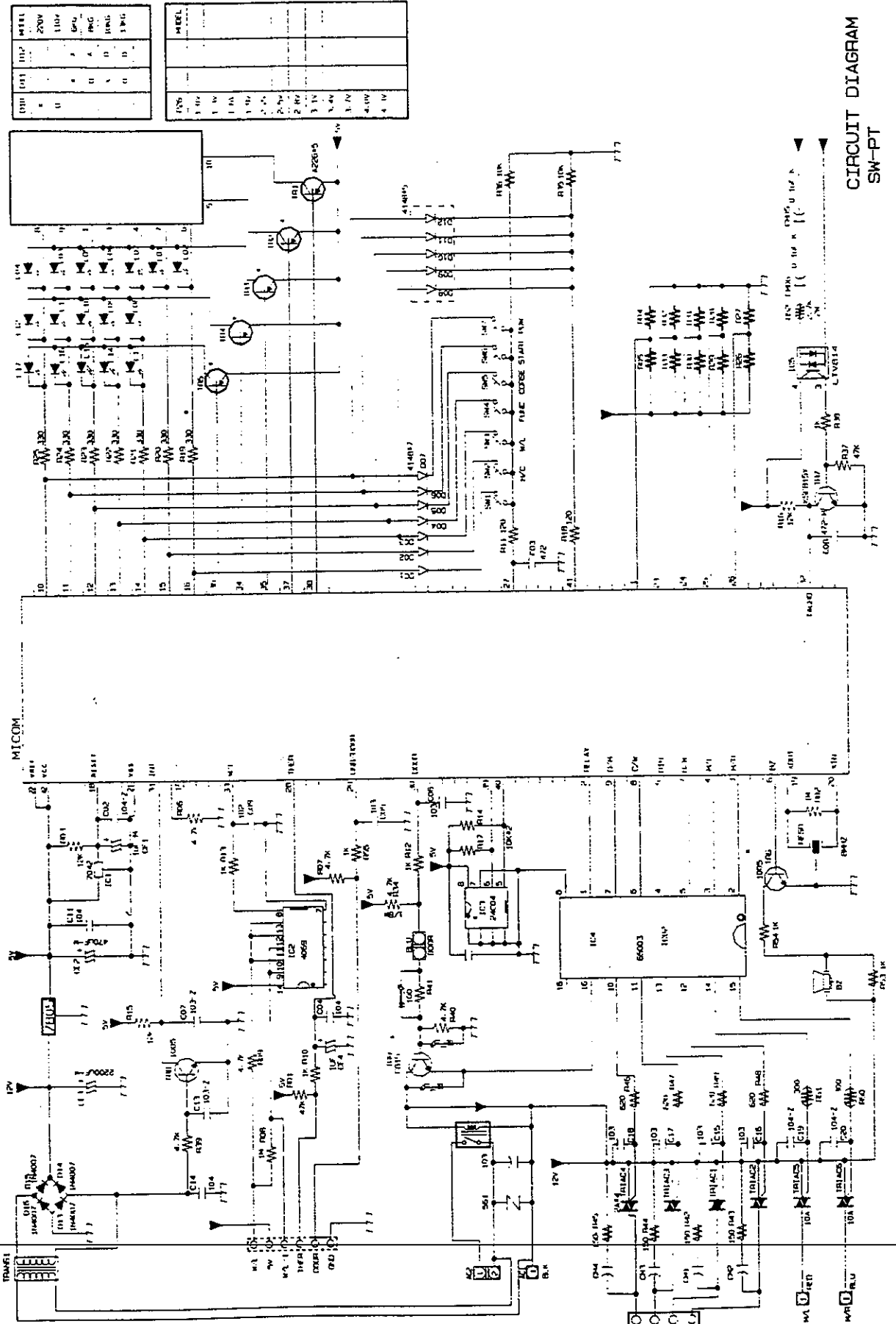

DESCRIPCION DE PIEZAS

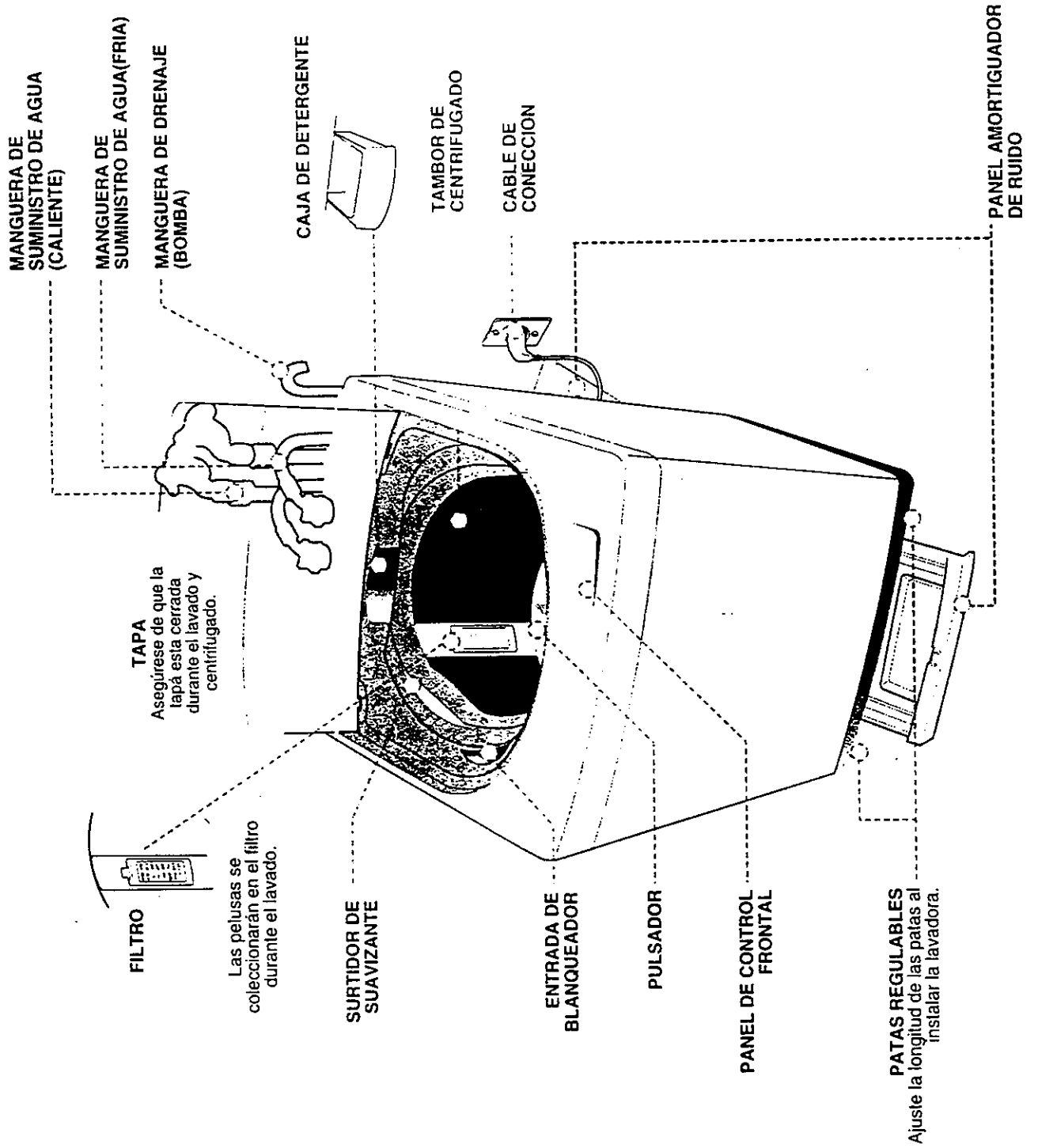

➤ COMO ARMAR EL PANEL DE AMORTIGUADOR DE RUIDO

Empuje la lavadora un poco y suba el panel hasta que pueda oír el sonido como la figura que está abajo.

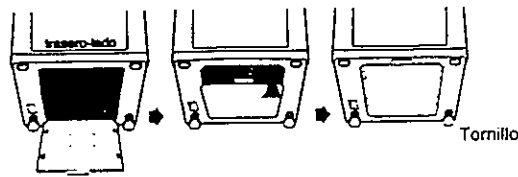

➤ NIVELAR

Mire si la máquina está nivelada observando la posición del pulsador dentro de la lavadora. Abra la tapa de la máquina, llene de agua el tanque hasta un nivel un poco debajo del pulsador. Ajuste las patas hasta que el pulsador se coloque al centro del agua como aparece en el dibujo.

Ajuste las dos patas delanteras hasta que la máquina esté completamente nivelada.

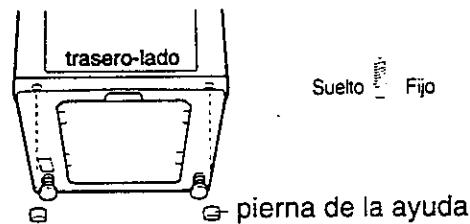
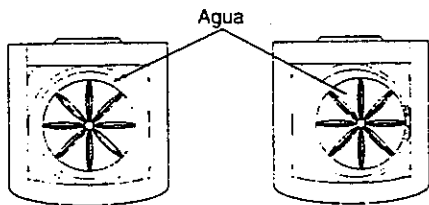

➤ PARA LAVADORA CON BOMBA DE DESCARGA

- Saque la tapa de la manguera, conecte la manguera de desagüe



- Asegúrese de conectar correctamente la manguera de desagüe a la salida de la válvula de desagüe que está en la parte posterior de la máquina.

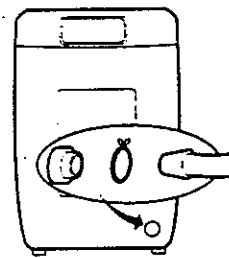

- Instale la manguera de desagüe aproximadamente 28-32 inches sobre el nivel del suelo.

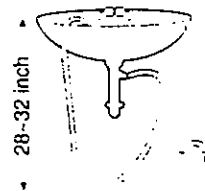

CARACTERÍSTICAS

➤ CONTROL FUZZY

El control fuzzy funciona con el mejor programa de lavado al detectar la carga de lavado inmediate.

➤ Lavado Limpio Por Sistema De Caída

La ropa cae desde la parte superior de cilindro, eliminando la suciedad y disolviendo completamente el detergente mediante un sistema de impacto.

INSTRUCCIONES DE SEGURIDAD

- **Asegúrese que la lavadora esté conectada a tierra.**
- Para evitar choque eléctrico. al hacer la conexión a tierra use una tubería metálica.
- No haga la conexión a tierra de la lavadora en cañerías de gas o líneas telefónicas debido a que hay peligro de explosión o sobretensión por descarga atmosférica.
- Las aperturas de ventilación no deben ser obstruidas por la alfombra cuando la máquina de lavar está instalada en un piso con alfombra.
- **Durante el centrifugado, no coloque las manos dentro del cilindro.**
- Debido a que el cilindro está girando a alta velocidad. las piezas que giran pueden causarle heridas en las manos.
- Nunca permita que los niños operen o jueguen con la lavadora.
- Desconecte el cordón de electricidad del suministro de energía cuando no está en uso.
- **Coloque la ropa dentro de la lavadora en forma pareja.**
Si coloca la ropa en forma dispareja es posible que se produzca ruido y vibración.
- No use agua excesivamente caliente. 50°C (122°F) ó mas
- Las piezas plásticas se pueden deformar o dañar. Igualmente, la ropa puede dañarse o desteñirse.
- Antes de lavar, revise los bolsillos. Si no se vacían pueden producirse daños a la máquina y a la ropa.
Si se daña el cable de energía de la lavadora, este deberá ser cambiado por el servicio técnico designado por el fabricante debido a que es necesario utilizar herramientas especiales.

Como conectar la manguera de suministro de agua a una sola llave de agua.

1. Conecte la manguera a la llave de agua apretándola firmemente.
2. Si es necesario, saque el adaptador de rosca de la llave y reemplácelo con el adaptador macho de rosca que viene como accesorio.
3. Entonces, conecte el otro extremo de la manguera de suministro de agua a la válvula de entrada de agua que está en la parte posterior de la máquina. Atomille completamente la manguera a la derecha. Utilice el aro de espacio antes de introducir el adaptador.
4. Algunas llaves requieren usar los dos adaptadores (macho y hembra) que vienen como accesorios. Fíjese en el dibujo a continuación.

Nota : Para una sola llave de agua en la cocina use solamente la manguera de suministro de agua fría.

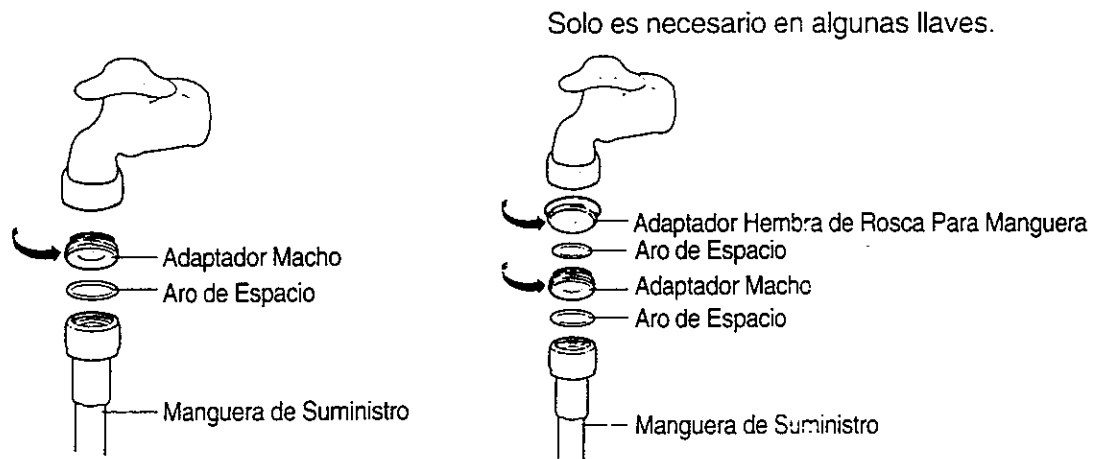

Como conectar las mangueras de suministro de agua.

Su lavadora posee dos válvulas de suministro de agua (fría y caliente)

1. Conecte la manguera de suministro de agua a la llave de agua. Apriétela firmemente.
2. Conecte el otro extremo de la manguera a la válvula de entrada de agua que está en la parte posterior de la máquina. Atomille completamente la manguera a la derecha.

Notas :

- A. Asegúrese de conectar la manguera de suministro de agua caliente a la válvula de agua de entrada (marcada caliente). Para mejor resultados el agua caliente no debe sobrepasar los 50°(122°F) grados centígrados. Si el agua está mucho más caliente que la temperatura recomendada puede dañarse la máquina.
- B. Abra la llave de agua completamente buscando por salideros. Si se encuentra alguno, repita los mismos pasos antes indicados.
- C. Si es una llave de agua no convencional, llame un plomero calificado para la instalación correcta.



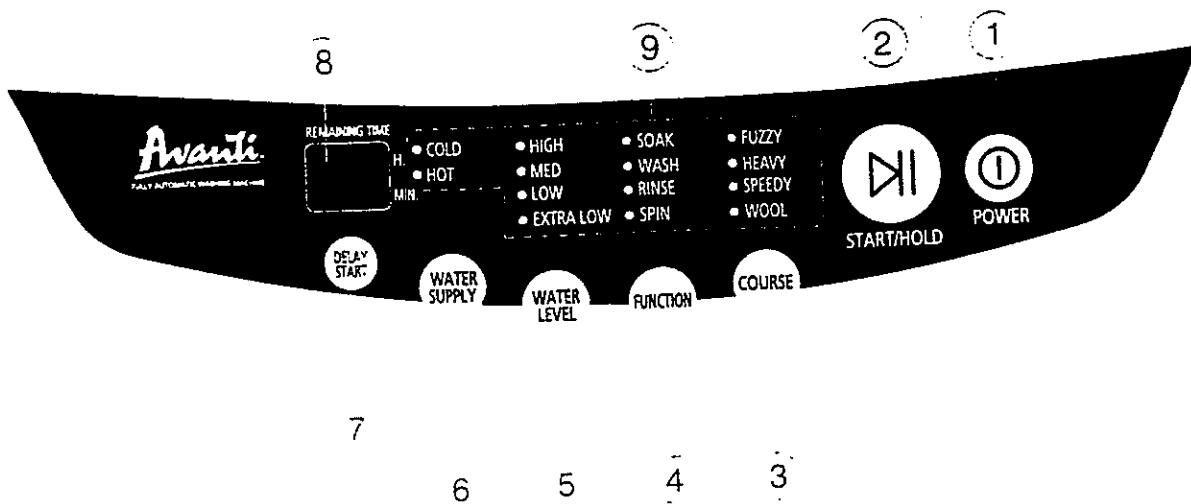

- 1) **Botón De Power**
Presione este botón para operar. Para apagar la máquina, vuelva a presionarlo.
- 2) **Botón Start/Hold**
Presione este botón para detener y reiniciar la operación de lavado. Para cambiar el procedimiento de lavado durante la operación, presione este botón para detener la máquina y vuelva a presionarlo para que vuelva a operar después de cambiar el procedimiento.
- 3) **Botón Selector De Course**
Cada vez que se presiona este botón, el programa de lavado cambia.
FUZZY -> HEAVY -> SPEEDY -> WOOL -> FUZZY
- 4) **Botón De Selector De Function.**
Cada vez que se presiona este botón, la función cambia.
Wash+Rinse+Spin -> Soak+Wash+Rinse+Spin -> Wash+Rinse+Spin -> Wash+Rinse -> Rinse+Spin -> Wash+Rinse+Spin
- 5) **Botón Selector De Water Level**
De acuerdo a la carga de lavado, seleccione el nivel de agua.
MED -> HIGH -> EXTRA LOW -> LOW
- 6) **Botón Selector De Water Supply**
Al presionar este botón, el tipo de agua se selecciona de la siguiente manera:
COLD -> COLD+HOT -> HOT -> COLD
Si es una llave de agua no convencional, llame un plomero calificado para la instalación correcta.
- 7) **Botón De Delay Start**
Presione este botón cuando desee un lavado programado.
- 8) **Luz Indicadora De Tiempo Restante**
La luz indicadora muestra el tiempo restante (en minutos) de cada ciclo de lavado. Al término de cada ciclo, la máquina se apaga automáticamente.
- 9) **Luz Indicadora De Función**
Una luz intermitente indica la función que está en uso. Al término de la función la luz indicadora se apaga.

PROCESO DE LAVADO

PROGRAMA FUZZY

El mejor programa de lavado se selecciona automáticamente.

- 1) **Antes de comenzar el proceso de lavado, verifique lo siguiente;**
Conecte la manguera de suministro de agua a la llave de agua. Abra la llave. Enchufe la máquina.
Asegúrese de bajar la manguera de descarga (En caso que no cuente con una bomba de descarga)
- 2) **Coloque la ropa en la lavadora y luego agregue detergente.**
Asegúrese de no sobrecargar la máquina. Use el detergente correcto para el tipo de ropa que está lavando.
- 3) **Presione el botón POWER.**
El indicador de tiempo remanente debería indicar. "- -"



- 4) **Presione el botón START/HOLD.**
El nivel de agua se selecciona automáticamente. Luego comienza el proceso de lavado, enjuague y centrifugado. Si desea detener la máquina, presione nuevamente el botón INICIO/PAUSA. Es posible cambiar el programa cuando la máquina se encuentra detenida.



- 5) **Cierre la tapa.**
Desenchufe la máquina cuando termine el proceso de lavado.

PROGRAMA HEAVY

Para la pieza de tela pesada , esto permite un lavado fuerte.

- 1) **Presione el botón POWER.**



- 2) **Presione una vez el botón de selección de course de lavado.**



- 3) **Presione el botón START/HOLD.**
Comienza el proceso de lavado, enjuague y centrifugado. Si desea detener la máquina, presione nuevamente este botón. Cuando la máquina esta detenida es posible cambiar el programa de lavado.



**Se lleva a cabo una operacion de diez minutos (1 minuto de lavado y 4 minutos de remojado) durante 30 minutos.*

- 4) **Cierre la tapa.**

PROGRAMA SPEEDY

Debido a que el proceso de lavado es más rápido, es conveniente para la ropa que está menos sucia o manchada.

- 1) Presione el botón POWER



POWER



- 2) Presione tres veces el botón de selección de course de lavado..



COURSE



- 3) Presione el botón START/HOLD.

El nivel de agua queda automáticamente seleccionado. Luego comienza el proceso de lavado, enjuague y centrifugado. Si desea detener la máquina, presione nuevamente el botón START/HOLD.



START/HOLD



- 4) Cierre la tapa.

PROGRAMA WOOL

Solo se dispone de nivel alto o medio. Se selecciona agua fría.

- 1) Presione el botón POWER.



POWER



- 2) Presione dos veces el botón de seleccion de course de lavado.



COURSE



- 3) Presione el botón START/HOLD..

Comienza el proceso de lavado, enjuague y centrifugado. Si desea detener la máquina, presione nuevamente el botón START/HOLD.



START/HOLD



- 4) Cierre la tapa.

PRECAUCION:

- No use agua sobre 30°C para lavar ropa de lana.
- Consulte la etiqueta adherida a las piezas de tela para obtener información acerca del lavado.
- Abroche los botones y lave la ropa por el revés.
- Use el tipo de detergente indicado en la etiqueta.
- Si la ropa está demasiado sucia, déjela remojar unos 10 minutos en agua tibia antes de presionar el botón del programa WOOL para obtener la máxima eficiencia de su lavadora.

LAVADO DELAY START

Seleccione este programa cuando tenga que salir o desee hacer otra cosa.

1. Presione el botón de POWER.



2. Presione el botón de DELAY START.



Se puede cambiar el tiempo de lavado programado. (desde 3 horas a 18 horas)

3. Presione el botón START/HOLD y ponga la cantidad adecuada de detergente en la caja de detergente.



4. Cierre La tapa.
El lavado empieza cuando usted lo programó.

FUNCIONES MANUALES

SOAK, WASH RINSE Y SPIN

Presione el botón de POWER. Presione una vez el botón de SELECTOR DE FUNCTION. Presione una vez el botón de START/HOLD. El proceso de lavado comienza y continúa durante 69 minutos. Las ropas son remojadas en agua para que la suciedad sea eliminada completamente. *Al presionar el botón de FUNCTION durante la operación, puede modificar el tiempo de enjuague en un rango de uno a cinco veces.*



una vez

SOLO WASH

Presione el botón de POWER. Presione dos veces el botón FUNCTION. Presione una vez el botón START.HOLD. El proceso de lavado comienza y continúa por 18 minutos. *Al presionar el botón FUNCTION, el tiempo de lavado se modifica a una razón de 2 minutos por presión en un rango de 3 a 25 minutos.*



dos veces

SOLO RINSE

Presione el botón de POWER. Presione tres veces el botón FUNCTION. Presione una vez el botón START.HOLD. El proceso de enjuague comienza y continúa por 5 minutos. *Al presionar el botón FUNCTION, el tiempo de enjuague se modifica en un rango de 1 a 5 veces.*



tres veces

SOLO SPIN

Presione cuatro veces el botón de FUNCTION. Presione una vez el botón de START/HOLD. El proceso de centrifugado durará 11 minutos. *Al presionar el botón de FUNCTION durante centrifugado el tiempo de centrifugado se modifica en un rango de 5 a 11 minutos.*



cuatro veces

WASH Y RINSE

Presione el botón de POWER. Presione cuatro veces el botón FUNCTION. Presione una vez el botón START/HOLD. El proceso de lavado y enjuague comienza y continúa por 28 minutos. *Al presionar el botón FUNCTION, el tiempo de enjuague se modifica en un rango de 1 a 5 veces.*

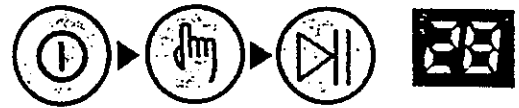

cinco veces

RINSE Y SPIN

Presione el botón de POWER. Presione seis veces el botón FUNCTION. Presione una vez el botón START/HOLD. El proceso de enjuague y centrifugado comienza. *Al presionar el botón FUNCTION, el tiempo de enjuague se modifica en un rango de 1 a 5 veces.*

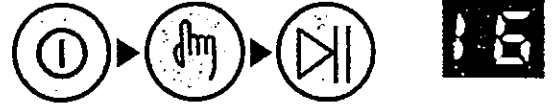

seis veces

WASH, RINSE Y SPIN

Presione el botón de POWER. Presione siete veces el botón FUNCTION. Presione una vez el botón START/HOLD. Comienza el proceso de lavado enjuague y centrifugado. *Al presionar el botón FUNCTION, el tiempo de enjuague se modifica en un rango de 1 a 5 veces.*

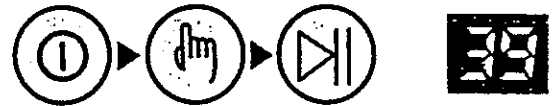

siete veces

Free Manuals Download Website

<http://myh66.com>

<http://usermanuals.us>

<http://www.somanuals.com>

<http://www.4manuals.cc>

<http://www.manual-lib.com>

<http://www.404manual.com>

<http://www.luxmanual.com>

<http://aubethermostatmanual.com>

Golf course search by state

<http://golfingnear.com>

Email search by domain

<http://emailbydomain.com>

Auto manuals search

<http://auto.somanuals.com>

TV manuals search

<http://tv.somanuals.com>