



INSTRUCTION MANUAL

Model Number/Número de Modelo:

WDP75

**ELECTRONIC CONTROLLED WATER DISPENSER
ENFRIADOR ELECTRONICO DE AGUA FRIA Y CALIENTE**

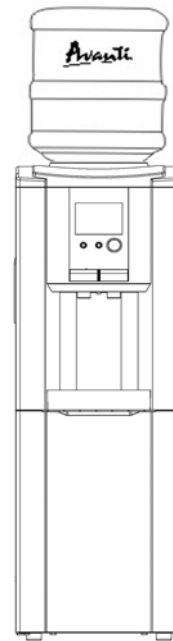

BEFORE USE, PLEASE READ AND FOLLOW ALL SAFETY RULES AND OPERATING INSTRUCTIONS.

La sección en español empieza en la página 14.

Avanti has a policy of continuous improvement on its products and reserves the right to change materials and specifications without notice.

Avanti Products
P.O. Box 520604 - Miami, Florida 33152
www.avantiproducts.com

HELP US HELP YOU

Read this guide carefully.

It is intended to help you operate and maintain your new water dispenser properly.

Keep it handy to answer your questions. If you don't understand something or you need more assistance please call:

Avanti Customer Service

800-220-5570

Keep proof of original purchase date (such as your sales slip) with this guide to establish the warranty period.

Write down the model and serial numbers.

You'll find them on a label located on the back side of the unit.

Please write these numbers here:

Date of Purchase

Model Number

Serial Number

Use these numbers in any correspondence or service calls concerning your water dispenser.

If you received a damaged water dispenser, immediately contact the dealer (or builder) that sold you the water dispenser.

Save time and money. Before you call for service, check the Trouble Shooting Guide. It lists causes of minor operating problems that you can correct yourself.

IF YOU NEED SERVICE

We're proud of our service and want you to be pleased. If for some reason you are not happy with the service you receive, here are some steps to follow for further assistance.

FIRST, contact the people who serviced your appliance. Explain why you are not pleased. In most cases, this will solve the problem.

NEXT, if you are still not pleased, write all the details, including your telephone number, and send it to:

**Customer Service
Avanti Products
10880 NW 30 Street
Miami, FL 33172**

PARTS AND FEATURES

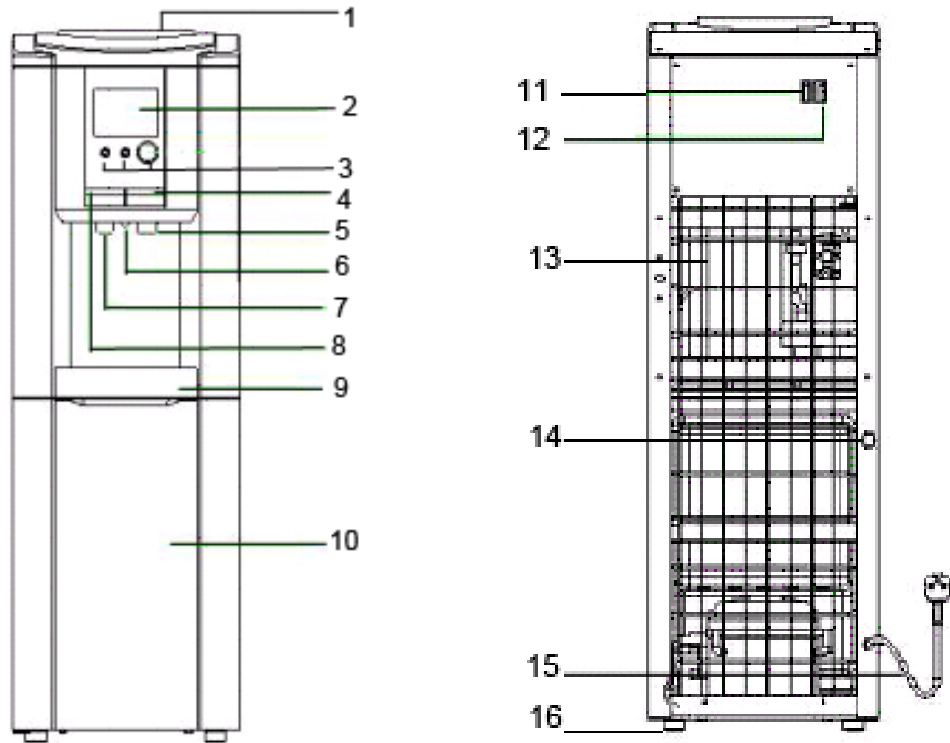

1	Water Intake	9	Drip Tray
2	Electronic LED Display	10	Storage Compartment
3	Control Panel	11	Cooling Power Switch (Green)
4	Cold Water Faucet	12	Heating Power Switch (Red)
5	Cold Water Outlet	13	Condenser
6	Nite-Light	14	Hot Water Drain Valve
7	Hot Water Outlet	15	Power Cord
8	Hot Water Faucet (with Child Safety Guard)	16	Leveling Legs

Table of Contents

Help Us Help You	3
Parts and Features	4
Important Safety Instructions	6
Installation Instructions	6
Before Using Your Dispenser	6
Operating Your Water Dispenser	7
Electrical Connection	8
Control and Display Panel	8
Energy Saving Program	8
Normal Program	9
Child Safety Guard on Hot Water Faucet	9
Care and Maintenance	10
Taking Dispenser Out of Service	10
Problems with Your Dispenser	10
Troubleshooting Guide	10
Service for Your Water Dispenser	11
Your Avanti Products Warranty	12
Wiring Diagram	13
Instrucciones en Español	14 – 17
Registration Information and Registration Card	19

Important Safety Instructions

⚡ WARNING ⚡	To reduce the risk of fire, electrical shock, or injury when using your appliance, follow these basic precautions:
<ul style="list-style-type: none">• Read all instructions before using the water dispenser.• Never clean parts with flammable fluids. The fumes can create a fire hazard or explosion.• Do not store or use gasoline or any other flammable vapors and liquids in the vicinity of this or any other water dispenser. The fumes can create a fire hazard or explosion. <p style="text-align: center;">-Save these instructions-</p>	

INSTALLATION GUIDELINES:

- Remove the exterior and interior packing.
- Place your appliance on a floor that is strong enough to support the dispenser when it is fully loaded. The unit is provided with four plastic feet, if it does not sit level on the floor, adjust the front feet to level the unit well to the floor.
- Locate the appliance away from direct sunlight and sources of heat (stove, heater, radiator, etc.). Direct sunlight may affect the acrylic coating and heat sources may increase electrical consumption. Extreme cold ambient temperatures may also cause the appliance not to perform properly.
- Allow 2 inches of space between the water dispenser and the wall, which allows for proper air circulation to cool the compressor.
- Plug the appliance into an exclusive properly installed-grounded wall outlet. Do not cut or remove the third (ground) prong from the power cord under any circumstances. Any questions concerning power and/or grounding should be directed toward a certified electrician or an authorized Avanti Products service center.
- This water dispenser is not recommended for outdoor use.
- Do not locate the dispenser in area where the temperature may fall below freezing (32° F).
- Keep area around dispenser free of dust and dirt.
- Keep the reserve supply of water bottles away from excessive heat and light.
- Never unplug the water cooler, except for maintenance.

OPERATION INSTRUCTIONS:

Before Using Your Water Dispenser

- Check to be sure the following parts are included:
 - Instruction manual
 - 2 extra cup dispenser cabinet plugs
 - 2 extra drain seals
 - Accessories order form.
- Before connecting the appliance to the power source, let it stand upright for approximately 2 hours. This will reduce the possibility of a malfunction in the cooling system from handling during transportation.
- The water dispenser is pre-cleaned at the factory but the reservoir and water lines must be flushed with fresh water before use as follows:
- Keep the unit unplugged.

- Fill water tank with tap water full to capacity. Wait for 5 minutes until water settles.
- Slide child safety button then push the hot water faucet until water comes out, then stop.
- Plug the dispenser into the electrical outlet. We are ready to complete the first cycle. In order to do that, wait for the hot water to reach temperature in approximately 10 minutes, and then wait for the cold to reach temperature (another 40 minutes, approximately).
- Unplug the dispenser from the electrical outlet. Proceed to drain the water from the faucets one at a time until no more water remains.
(Note: To facilitate this operation, use a large container).
- Then, drain any water left in the tanks by opening the drain plug located on the back, until it drains completely.
- Proceed to close the drain cap.
- Remove the cap from the 5-gallon bottle and use a clean cloth to wipe off the neck of the bottle.
- Place the 5-gallon bottle of water on the water intake, allow water to stand for approximately one minute.
- Push water faucet buttons to insure water flows from both faucets.
- Plug dispenser back into the electrical outlet.
- Now you are ready to use your water dispenser.

NOTE: Your water dispenser has been cleaned and sanitized before leaving the factory, but in case a taste problem develops, place two tablespoons of baking soda and add tap water. Fill water tank again and repeat basic operations previously outlined, except turn hot water function "OFF" to avoid leaving residues in hot water tank.

ATTENTION:

If you do not plan to use the water heating function for more than three days, we recommend that you turn off the hot water function.

⚡ WARNING ⚡

IMPROPER USE OF THE GROUNDED PLUG CAN RESULT IN THE RISK OF ELECTRICAL SHOCK. IF THE POWER CORD IS DAMAGED, HAVE IT REPLACED BY AN AUTHORIZED AVANTI PRODUCTS SERVICE CENTER.

OPERATING YOUR WATER DISPENSER

Steps To Replace Water Bottles

- Remove cap.
- Use a clean cloth to wipe off neck of bottle.
- Carefully lift bottle (approx. 40 lbs.) using your legs and not your back. Do not place hands on opening of bottle while placing in reservoir.
- Insert the water bottle on the water intake over reservoir opening so it settles properly on it.
- Wipe off any water which may have splashed on dispenser top.
- When a new bottle is installed you must open the hot water faucet and remove no less than 4 full cups of water to insure the water flows properly and the water reservoir is at the proper level.

When a new bottle is installed you must open the hot water faucet and remove no less than 4 full cups of water to insure the water flows properly and the water reservoir is at the proper level.

Electrical Connection

This appliance should be properly grounded for your safety. The power cord of this appliance is equipped with a three-prong plug which mates with standard three prong wall outlets to minimize the possibility of electrical shock.

Plug the appliance into an exclusive properly installed-grounded wall outlet. Do not under any circumstances cut or remove the third (ground) prong from the power cord. Any questions concerning power and or grounding should be directed toward a certified electrician or an authorized Avanti Products service center.

This appliance requires a standard 115/120-volt, 60Hz electrical outlet with three-prong ground.

The cord should be secured behind the appliance and not left exposed or dangling to prevent accidental injury.

Do not use an adapter plug with this appliance.

Do not use an extension cord with this appliance. If the power cord is too short, have a qualified electrician or service technician install an outlet near the appliance.

Control and Display Panel

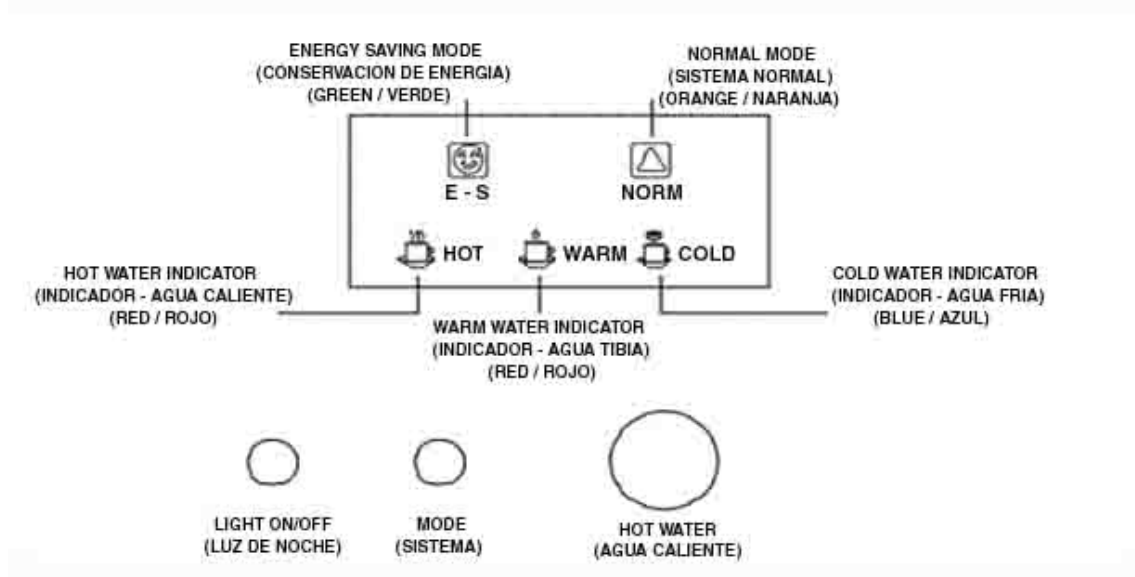

For operation of unit, please fill water and make sure water settles inside the water tank, and then switch on both hot and cold switches at back of unit.

Working Programs:

Energy Saving Program:

When the PROGRAM button is pushed down, it's under Energy Saving Program; The (green) E-S indicator will be displayed. During operation the (red) "WARM" cycle indicator will be displayed until the temperature of the water in the reservoir reaches 60°C/140°F. Once the temperature reaches 60°C/140°F (approximately 4 minutes) the (red) "WARM" indicator will turn off and will remain off until the temperature of the water in the reservoir drops to 50°C/122°F at which time the (red) "WARM" cycle indicator will turn on and the cycle will start again.

During "Energy Saver" Program, when you press the "HOT WATER" button, the (red) "HOT" cycle indicator will be on and water temperature in the reservoir will be heated to 90°C/194°F (approximately 4 minutes). Once the water temperature reaches 90°C/194°F the (red) "HOT" cycle indicator will turn off and will remain off until the "HOT WATER" button is pressed again.

Normal Program:

When the PROGRAM button is released, it's under Normal operation mode and the (orange) NORM indicator light will displayed. During operation the (red) "HOT" cycle indicator will be on until the temperature of the water in the reservoir reaches 90°C/194°F (approximately 9 minutes). The (red) "HOT" cycle indicator will turn off and will remain off until the temperature of the water in the reservoir drops to 81°C/178°F at which time the (red) "HOT" cycle indicator will turn on and the cycle will start again.

When the unit is in "NORMAL PROGRAM" the "HOT WATER" button is non-functional.

Cold Temp (Energy Saver / Normal Modes):

The cold water cycle is not affected by either program and continuously runs to maintain a cold water temperature between 5°C/41°F and 10°C/50 °F. Once the "Cold Switch" at the rear of the unit is turned ON the (blue) "COLD" cycle indicator will be on until the temperature of the water in the reservoir drops to 7°C/44°F or less, the (blue) "COLD" cycle indicator will turn off and the cooling cycle will stop until the temperature reaches 10 /50°F, at which time the (blue) "COLD" cycle indicator will turn on again and the cooling cycle will start again.

Light:

When the light button is pushed, the light will turn on. Pushed again, the light will turn off.

**NOTE:
THE HOT WATER FAUCET HAS A CHILD-SAFETY GUARD ATTACHMENT.**

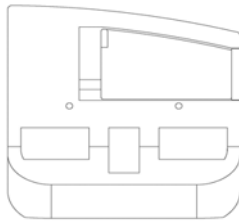

To get hot water:

- ◆ Slide red safety button to the right and hold while pressing downward on hot water faucet to dispense hot water.
- ◆ Safety button will return to its original position when faucet is released.

Cup Dispenser (OPTIONAL)

The cup dispenser may be installed by using the mounting holes (covered with plastic caps) located near the top of the right side panel of the cooler. The cup dispenser comes equipped with a mounting bracket and screws and may be ordered by completing the enclosed order form provided with your instruction manual.

CARE AND MAINTENANCE

- Wash the inside of the reservoir with a warm water and baking soda solution. The solution should

- be about 2 tablespoons of baking soda to a quart of water. (Turn off the hot water function).
- The drip tray and water faucets should be cleaned with mild detergent and warm water.
- At regular intervals or once a month inspect the coils located across the back of the dispenser. Vacuum accumulation of dust or clean it with a hard brush.

TAKING DISPENSER OUT OF SERVICE

- If the water dispenser will not be used for a long period of time, unplug the power cord from the wall outlet.
- Turn off the hot water.
- Drain the water through the faucets.
- Drain the water from the tanks by removing the plug from the back of the dispenser.

WARNING—THE WATER COMING OUT OF THE BACK MAY BE SCOLDING HOT.

- Unit should NOT be transported on the units side. Place it upright if possible and cover it with a blanket.

PROBLEMS WITH YOUR WATER DISPENSER?

You can solve many common water dispenser problems easily, saving you the cost of a possible service call. Try the suggestions outlined below to see if you can solve the problem before calling the servicer.

TROUBLESHOOTING GUIDE

PROBLEM	POSSIBLE CAUSE
Water dispenser does not operate.	Not plugged in. The circuit breaker tripped or a blown fuse.
Water cooler is not cold enough.	Check to be sure the cold switch on the back is ON. The water dispenser does not have the correct clearances.
Water dispenser hot water is not hot enough.	Check to be sure the hot switch on the back is ON.
Compressor turns on and off frequently.	The room temperature is hotter than normal. The temperature control is not set correctly. The water dispenser does not have the correct clearances.
Vibrations.	Check to assure that the water dispenser is level.
The water dispenser seems to make too much noise.	The rattling noise may come from the flow of the refrigerant, which is normal. As each cycle ends, you may hear gurgling sounds caused by the flow of refrigerant in your water dispenser. Contraction and expansion of the inside walls may cause popping and crackling noises. The water dispenser is not level.
Bottle feels warm.	The water system is overfilled. Dispense Cold water until air is released into the bottle.
Water bottle is hot.	Water is boiling in the hot tank and bubbling up into the bottle. Press the hot dispenser button until water flows to remove air from the hot tank.

SERVICE FOR YOUR WATER DISPENSER

We are proud of our customer service organization and the network of professional service technicians that provide service on your Avanti appliances. With the purchase of your Avanti appliance, you can be confident that if you ever need additional information or assistance, the Avanti Products Customer Service Team will be here for you. Just call us toll-free.

AVANTI PRODUCTS CUSTOMER SERVICES

Product Information 800-323-5029	Whatever your questions are about our products, help is available.
Part Orders 800-220-5570	You may order parts and accessories that will be delivered directly to your home, by personal check, money order, Master Card, or Visa.
In-Home Repair Service 800-220-5570	An Avanti Products authorized service center will provide expert repair service, scheduled at a time that is convenient for you. Our trained servicers know your appliance inside and out.

YOUR Avanti Products WARRANTY

Staple your sales receipt here. Proof of original purchase date is needed to obtain service under warranty.

**WHAT IS COVERED
LIMITED ONE-YEAR
WARRANTY**

For one year from the date of purchase by the original owner, Avanti Products will, at its option, repair or replace any part of the appliance which proves to be defective in material or workmanship under normal use. During this period Avanti Products will provide all parts and labor necessary to correct such defects free of charge, so long as the appliance has been installed and operated in accordance with the written instructions in this manual. Avanti Products will provide you with a reasonably similar replacement product that is either new or factory refurbished. In rental or commercial use, the warranty period is 90 days.

**LIMITED SECOND THROUGH
FIFTH YEAR WARRANTY**

For the second through the fifth year from date of original purchase, Avanti Products will provide a replacement compressor free of charge due to a failure. You are responsible for the service labor and freight charges. In rental or commercial use, the limited compressor warranty is one year and nine months. Cost to move the appliance to the servicers' shop and back to the users' home, as may be required, are the users' responsibility.

WHAT IS NOT COVERED

- Incidental or consequential damages.
- Parts and labor costs for the following will not be considered as warranty:
 - Light bulbs and/or plastic housing.
 - Plastic cabinet liners.
 - Punctured evaporator that voids the warranty on the complete sealed system.
 - Replacement of house fuses or resetting circuit breakers.
 - Shipping and handling costs associated with the replacement of the unit.
- Repairs performed by unauthorized servicers.
- Surcharges including, but not limited to, any after hour, weekend, or holiday service calls, tolls, ferry trip charges, or mileage expense for service calls to remote areas, including the State of Alaska.
- Service calls that do not involve defects in material or workmanship such as customer education, or improper installation.
- Service calls that are related to external problems, such as abuse, misuse, inadequate electrical power, accidents, fire, floods, or acts of God.
- Failure of the product if it is used for other than its intended purpose.
- This warranty does not apply outside the continental U.S.A.

WIRING DIAGRAM

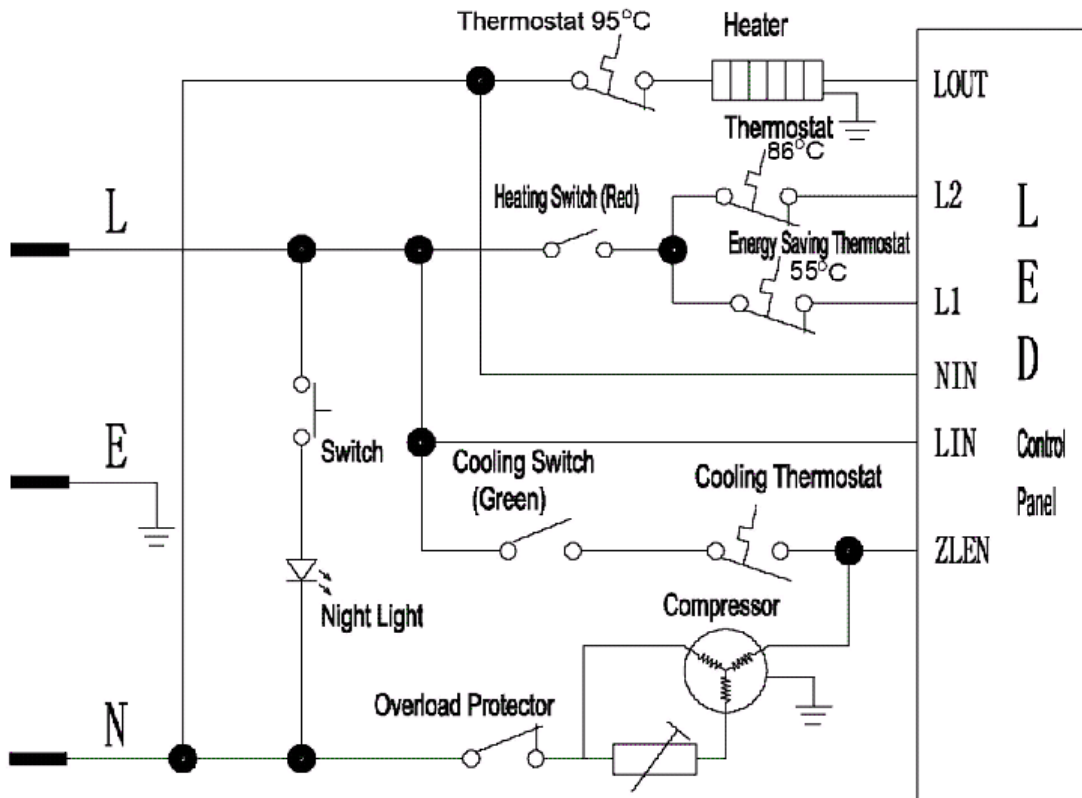

INSTRUCCIONES EN ESPAÑOL

ADVERTENCIA

EL USO INCORRECTO DEL CABLE A TIERRA PUEDE OCASIONAR UN CHOQUE ELECTRICO. SI EL CORDON ESTA DAÑADO, REEMPLACELO EN UN CENTRO DE SERVICIOS AUTORIZADO POR AVANTI PRODUCTS.

PASOS RECOMENDADOS PARA CAMBIAR EL BOTELLON

- QUITA EL BOTELLON VACIO.
- LIMPIA EL CUELLO DEL BOTELLON NUEVO CON UN TRAPO LIMPIO.
- LEVANTA EL BOTELLON HACIENDO FUERZA CON LAS PIERNAS Y NO LA ESPALDA.
- TOMA EL BOTELLON POR LOS LADOS Y DIRIJA EL CUELLO DEL MISMO HACIA LA APERTURA DEL TANQUE.
- VOLTEA EL BOTELLON COMO SI FUERA A BOTAR AGUA E INSERTE EL CUELLO DEL BOTELLON EN LA APERTURA DEL TANQUE HASTA QUE SE COLOQUE EN LA POSICION CORRECTA.

DIRECCIONES BASICAS DE OPERACION:

- COLOQUE EL ENFRIADOR DE PIE POR UN PERIODO DE 2 HORAS ANTES DE ENCHUFAR LA UNIDAD A LA PARED.
- COLOQUE EL ENFRIADOR EN UN AREA BIEN VENTILADA Y DEJE UN ESPACIO DE UN POCO MAS DE 2 PULGADAS ENTRE LA UNIDAD Y LA PARED.
- ESCOJA UN LUGAR CON PISO NIVELADO.
- NO COLOQUE EL ENFRIADOR DONDE LA TEMPERATURA AMBIENTAL PUEDA BAJAR DE 32°F (0°C).

ANTES DE ENCHUFARLO

AUNQUE EL ENFRIADOR SALE LIMPIO DE LA FABRICA, DEBE LIMPIAR Y ESTERILIZAR LOS CONDUCTOS DEL TANQUE Y LOS GRIFOS DE ACUERDO A LOS SIGUIENTES PASOS:

- LLENE EL TANQUE DE AGUA (HASTA EL TOPE) CON AGUA DE LA PILA.
- DEJE NIVELAR EL AGUA POR 5 MINUTOS.
- ENCHUFE LA UNIDAD A LA PARED.
- ENCIENDA LOS INTERRUPTORES DE AGUA CALIENTE Y FRIA LOCALIZADOS EN LA PARTE TRASERA DE LA UNIDAD.
- VACIE EL TANQUE COMPLETAMENTE ABRIENDO LAS TAPAS DE DRENAJE SITUADAS ABAJO DEL GABINETE. CIERRELAS. AHORA SU DISPENSADOR DE AGUA ESTA LISTO PARA USAR.

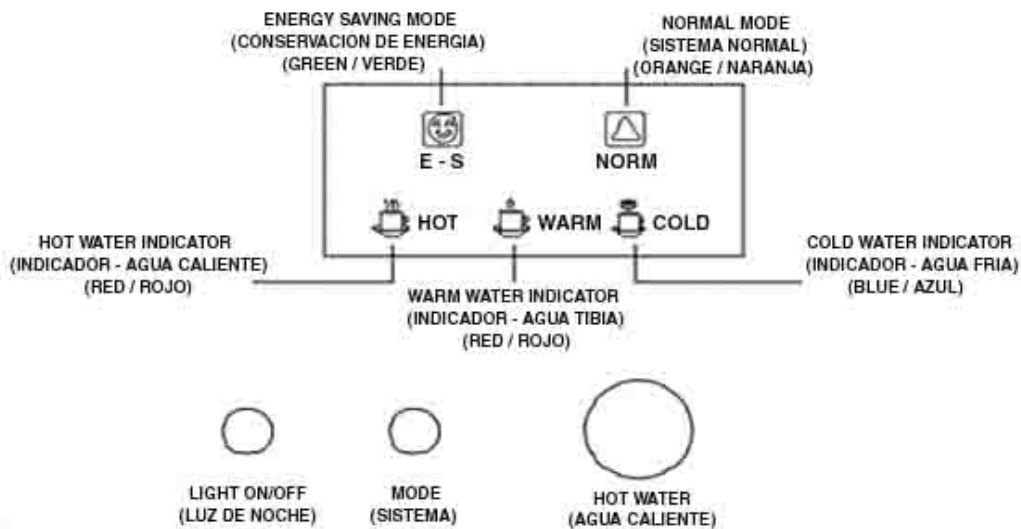

CONTROLES DE OPERACION

- INDICADOR MARCADO E-S (CONSERVACION DE ENERGIA):**
 CUANDO UD PRESIONE EL BOTON MARCADO "PROGRAM", LA UNIDAD OPERARA EN CONDICIONES DESIGNADAS PARA CONSERVAR ENERGIA. DURANTE ESTE PERIODO EL INDICADOR VERDE MARCADO "E-S" (CONSERVACION DE ENERGIA) SE ALUMBRARA EN LA PANTALLA.

DURANTE LA OPERACION E-S, EL INDICADOR ROJO MARCADO "WARM" (TIBIO) SE ENCENDERA EN LA PANTALLA HASTA QUE EL AGUA ALCANCE LA TEMPERATURA DE 60°C/140°F (APROXIMADAMENTE EN 4 MINUTOS). EN ESE MOMENTO EL INDICADOR SE APAGARA TAN PRONTO EL AGUA EN EL TANQUE ALCANCE LOS 50°C/122°F, Y EL CICLO DE CALENTAMIENTO EMPEZARA DE NUEVO.

DURANTE LA OPERACION E-S, CUANDO UD PRESIONE EL BOTON MARCADO "HOT WATER" (AGUA CALIENTE), EL INDICADOR "HOT" (CALIENTE) SE ENCENDERA HASTA QUE EL AGUA ALCANCE LA TEMPERATURA DE 90°C/144°F (APROXIMADAMENTE 4 MINUTOS). EN ESE MOMENTO, EL INDICADOR SE APAGARA Y EL CICLO DE CALENTAMIENTO NO VOLVERA EMPEZAR HASTA QUE UD PRESIONE EL BOTON MARCADO "HOT WATER" (AGUA CALIENTE) DE NUEVO.
- INDICADOR MARCADO "NORM" (SISTEMA NORMAL):**
 CUANDO UD PRESIONE EL BOTON MARCADO "PROGRAM", EL INDICADOR COLOR NARANJA MARCADO "NORM" SE ENCENDERA EN LA PANTALLA Y LA UNIDAD OPERARA EN EL PROGRAMA NORMAL. EL INDICADOR "HOT" (CALIENTE) DE COLOR ROJO SE ENCENDERA HASTA QUE EL AGUA ALCANCE LA TEMPERATURA DE 90°C/194°F (APROXIMADAMENTE EN 9 MINUTOS). EN ESE MOMENTO, EL INDICADOR DE COLOR ROJO SE APAGARA TAN PRONTO EL AGUA EN EL TANQUE ALCANZE 81°C/178°F Y EL CICLO DE CALENTAMIENTO EMPEZARA DE NUEVO.

- **AGUA FRIA (CONSERVACION DE ENERGIA Y SISTEMA NORMAL):**
ESTE CICLO DE ENFRIAMIENTO NO SERA AFECTADO POR ESTOS PROGRAMAS Y CONTINUARA FUNCIONANDO PARA MANTENER LA TEMPERATURA FRIA ENTRE 7°C/44°F Y 10°C/50°F. A LA VEZ QUE EL INTERRUPTOR MARCADO "COLD" (FRIO) EN LA PARTE TRASERA SE ENCIENDA, EL INDICADOR "COLD" DE COLOR AZUL SE ENCENDERA EN LA PANTALLA Y EL CICLO FRIO CONTINUARA HASTA QUE LA TEMPERATURA ALCANCE LOS 5°C/41°F. EN ESE MOMENTO EL INDICADOR DE COLOR AZUL SE APAGARA TAN PRONTO EL AGUA EN EL TANQUE ALCANCE 10°C/50°F Y EL CICLO COMENZARA DE NUEVO.
- **LUZ DE NOCHE:**
CUANDO PRESIONE EL BOTON MARCADO (LIGHT ON/OFF) LA LUZ DE NOCHE SE ENCENDERA.
PRESIONELO DE NUEVO Y LA LUZ SE APAGARA.

AVISO:
ESTE GRIFO DE AGUA CALIENTE TIENE UN ADAPTADOR DE SEGURIDAD PARA NIÑOS.

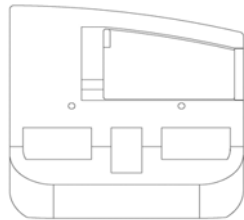

PARA OBTENER AGUA CALIENTE:

- ◆ MUEVA EL BOTON DE SEGURIDAD HACIA LA DERECHA SIN SOLTARLO.
- ◆ MANTENGA AGARRADO ESE BOTON DE SEGURIDAD MIENTRAS QUE EMPUJE EL GRIFO HACIA ABAJO PARA DISPENSAR EL AGUA CALIENTE.
- ◆ CUANDO SUELTE EL GRIFO ASEGURESE DE RETORNARLO A LA POSICION ORIGINAL.

NOTA: SU ENFRIADOR FUE LIMPIADO Y ESTIRILIZADO ANTES DE SALIR DE LA FABRICA. EN CASO QUE SIENTA ALGUN SABOR EN EL AGUA, ECHE UNA CUCHARADA DE BICARBONATO DE SODIO Y AÑADA AGUA DE LA PILA. LLENE EL TANQUE Y REPITA LA OPERACION INICIAL.

MANTENIMIENTO

- ANTES DE EFECTUAR LA LIMPIEZA, DESENCHUFE EL ENFRIADOR.
- PARA LIMPIAR LAS PARTES DE PLASTICO SE REQUIERE JABON LIQUIDO Y AGUA TIBIA. NO USE LIMPIADORES ABRASIVOS EN LA SUPERFICIE SUPERIOR NI EN LA BANDEJA DE ESCURRIMIENTO.

SI NO VA A USAR EL ENFRIADOR POR UN TIEMPO PROLONGADO

- DESENCUFE LA UNIDAD.
- QUITA EL BOTELLON DE AGUA.
- COLOQUE LOS INTERRUPTORES (10) Y (11) (EN LA PARTE TRASERA) EN LA POSICION "OFF". (APAGADO)
- DRENE EL AGUA ABRIENDO LAS LLAVES.
- DRENE LA APERTURA EN LA PARTE TRASERA QUITANDO EL TAPON (14).

CENTRO DE SERVICIOS

LA MAYORIA DE LOS PROBLEMAS SE RESUELVEN CON UNA SIMPLE LLAMADA TELEFONICA A NUESTRO NUMERO SIN CARGO.

1-800-220-5570

ANTES DE DEVOLVER EL PRODUCTO O PARA OBTENER LA DIRECCION Y NUMERO DE TELEFONO DEL CENTRO DE SERVICIO MAS CERCANO LLAME AL SIGUIENTE NUMERO.

1-800-220-5570

GUIA PARA RESOLVER PROBLEMAS

POSIBLES PROBLEMAS	CAUSAS
DERRAME DE AGUA POR FUERA DEL ENFRIADOR.	LA BOTELLA ESTA PERFORADA – REEMPLACELA.
EL AGUA NO ESTA SUFICIENTEMENTE FRIA.	VERIFIQUE QUE EL INTERRUPTOR (COLD). ESTE EN POSICION "ON". NO DIO SUFICIENTE TIEMPO PARA QUE ENFRIE EL AGUA. PARA REPONER DOS O MAS VASOS DE 8 oz. SE NECESITA APROXIMADAMENTE UNA HORA.
EL AGUA NO ESTA SUFICIENTEMENTE CALIENTE.	VERIFIQUE QUE EL INTERRUPTOR (HOT) ESTE EN POSICION "ON". NO DIO SUFICIENTE TIEMPO PARA QUE CALIENTE EL AGUA. PARA REPONER DOS O MAS VASOS DE 8 oz. SE NECESITA APROXIMADAMENTE UNA HORA.
EL ENFRIADOR NO ENFRIA O CALIENTA EL AGUA.	VERIFIQUE LOS CIRCUITOS, FUSIBLES O DISYUNTORES.
VIBRACIONES	VERIFIQUE QUE EL ENFRIADOR ESTE EN UN PISO FIRME Y NIVELADO.

Registration Information

Thank you for purchasing this fine Avanti product. Please fill out this card and return it within 100 days of purchase and receive these important benefits:

➤ **Protect your product:**

We will keep the model number and date of purchase of your new Avanti product on file to help you refer to this information in the event of an insurance claim such as fire or theft.

➤ **Promote better products:**

We value your input. Your responses will help us develop products designed to best meet your future needs.

------(detach here)-----

Avanti Registration Card

Name

Model # Serial #

Address

Date Purchased Store/Dealer Name

City State Zip

Occupation

Area Code Phone Number

As Your Primary Residence, Do You:

Own Rent

Did You Purchase An Additional Warranty:

Extended None

Your Age:

under 18 18-25 26-30
 31-35 36-50 over 50

Reason For Choosing This Avanti Product:

Please indicate the most important factors that influenced your decision to purchase this product.

- Price
 Product Features
 Avanti Reputation
 Product Quality
 Salesperson Recommendation
 Friend/Relative Recommendation
 Warranty
 Other _____

Marital Status:

Married Single

Is This Product Used In The:

Home Business

How Did You Learn About This Product:

Advertising
 In Store Demo Personal Demo

Other _____

Comments _____

PRINTED IN CHINA

Free Manuals Download Website

<http://myh66.com>

<http://usermanuals.us>

<http://www.somanuals.com>

<http://www.4manuals.cc>

<http://www.manual-lib.com>

<http://www.404manual.com>

<http://www.luxmanual.com>

<http://aubethermostatmanual.com>

Golf course search by state

<http://golfingnear.com>

Email search by domain

<http://emailbydomain.com>

Auto manuals search

<http://auto.somanuals.com>

TV manuals search

<http://tv.somanuals.com>