

AXIS 231D/232D
Network Dome Camera

User's Manual

2 About This Document

This manual is intended for administrators and users of the AXIS 231D/232D Network Dome Camera, and is applicable for Firmware release 4.30. It includes instructions for using and managing the AXIS 231D/232D on your network. Previous experience of networking will be of use when installing and using this product. Some knowledge of UNIX or Linux-based systems would also be beneficial, for developing shell scripts and applications. Later versions of this document will be posted to the Axis Website, as required. See also the product's online help, available via the Web-based interface.

Safety Notices Used In This Manual

Caution! - Indicates a potential hazard that can damage the product.

Important! - Indicates a hazard that can seriously impair operation.

Do not proceed beyond any of the above notices until you have fully understood the implications.

Intellectual Property Rights

Axis AB has intellectual property rights relating to technology embodied in the product described in this document. In particular, and without limitation, these intellectual property rights may include one or more of the patents listed at <http://www.axis.com/patent.htm> and one or more additional patents or pending patent applications in the US and other countries.

This product includes software developed by the OpenSSL Project for use in the OpenSSL Toolkit:
<http://www.openssl.org/>

Legal Considerations

Camera surveillance can be prohibited by laws that vary from country to country. Check the laws in your local region before using this product for surveillance purposes. This product includes one (1) MPEG-4 decoder license. To purchase further licenses, contact your reseller.

Electromagnetic Compatibility (EMC)

This equipment generates, uses and can radiate radio frequency energy and, if not installed and used in accordance with the instructions, may cause harmful interference to radio communications. However, there is no guarantee that interference will not occur in a particular installation.

If this equipment does cause harmful interference to radio or television reception, which can be determined by turning the equipment off and on, the user is encouraged to try to correct the interference by one or more of the following measures: Re-orient or relocate the receiving antenna. Increase the separation between the equipment and receiver. Connect the equipment to an outlet on a different circuit to the receiver. Consult your dealer or an experienced radio/TV technician for help. Shielded (STP) network cables must be used with this unit to ensure compliance with EMC standards.

USA - This equipment has been tested and found to comply with the limits for a Class A digital device, pursuant to Part 15 of the FCC rules. These limits are designed to provide reasonable protection against harmful interference when the equipment is operated in a commercial environment. This equipment generates, uses and can radiate radio frequency energy and, if not installed and used in accordance with the instruction manual, may cause harmful interference to radio communications. Operation of this equipment in a residential area is likely to cause interference, in which case the user will be required to correct the interference at his own expense.

Canada - This Class A digital apparatus complies with Canadian ICES-003.

Europe -  This digital equipment fulfills the requirements for radiated emission according to limit A of EN55022/1998, and the requirements for immunity according to EN55024/1998 residential,

commercial, and industry. **Warning!** This is a Class A product. In a domestic environment this product may cause radio interference, in which case the user may be required to take adequate measures.

Japan - This is a class A product based on the standard of the Voluntary Control Council for Interference by Information Technology Equipment (VCCI). If this equipment is used in a domestic environment, radio disturbance may arise. When such trouble occurs, the user may be required to take corrective action.

Australia - This electronic device meets the requirements of the Radio communications (Electromagnetic Compatibility) Standard 1998 AS/NZS 3548.

Warning! This is a Class A product. In a domestic environment this product may cause radio interference, in which case the user may be required to take adequate measures.

Liability

Every care has been taken in the preparation of this manual; Please inform your local Axis office of any inaccuracies or omissions. Axis Communications AB cannot be held responsible for any technical or typographical errors and reserves the right to make changes to the product and manuals without prior notice. Axis Communications AB makes no warranty of any kind with regard to the material contained within this document, including, but not limited to, the implied warranties of merchantability and fitness for a particular purpose. Axis Communications AB shall not be liable nor responsible for incidental or consequential damages in connection with the furnishing, performance or use of this material.

Trademark Acknowledgments

Acrobat, Adobe, Boa, Ethernet, IBM, Internet Explorer, Linux, Macintosh, Microsoft, Mozilla, Netscape Navigator, UNIX, Windows, WWW are registered trademarks of the respective holders. Java and all Java-based trademarks and logos are trademarks or registered trademarks of Sun Microsystems, Inc. in the United States and other countries. UPnP is a certification mark of the UPnP™ Implementers Corporation. Axis Communications AB is independent of Sun Microsystems Inc.

Axis Customer Services

Should you require any technical assistance, please contact your Axis reseller. If your questions cannot be answered immediately, your reseller will forward your queries through the appropriate channels to ensure a rapid response. If you are connected to the Internet, you can:

- download user documentation and firmware updates
- find answers to resolved problems in the FAQ database. Search by product, category, or phrases
- report problems to Axis support staff by logging in to your private support area
- visit the Axis Support Web at www.axis.com/techsup/

Safety Notice - Battery Replacement

The AXIS 231D/232D uses a 3.0V CR2032 Lithium battery as the power supply for its internal real-time clock (RTC). This battery will, under normal conditions, last for a minimum of 5 years. Low battery power affects the operation of the RTC, causing it to reset at every power-up. A log message will appear when battery replacement is required.

The battery should not be replaced unless required!

If the battery does need replacing, please observe the following points:

Caution!

- Danger of Explosion if battery is incorrectly replaced
- Replace only with the same or equivalent battery, as recommended by the manufacturer.
- Dispose of used batteries according to the manufacturer's instructions.

AXIS 231D/232D Network Dome Camera User's Manual
Revision 2.1

Date: October 2005

Part No: 25788

Copyright© Axis Communications AB, 2004-2005

Table of contents

- AXIS 231D/232D 5
 - AXIS 232D 5
 - Hardware Inventory 6
 - Hardware Description 6
- Using the Network Dome Camera 8
 - Accessing the AXIS 231D/232D 8
 - The Live View page 9
 - The Control panel 11
- Video Streams 13
 - Stream Types 13
 - MPEG-4 protocols and communication methods 14
 - How to stream MPEG-4 14
 - The AXIS Media Control 15
 - Other methods of accessing the video stream 15
- Configuring the Network Dome Camera 17
 - Accessing the Setup Tools 17
 - Overview of the Setup Tools 17
 - Video & Image Settings 18
 - MPEG-4 Settings 21
- Live View Config 22
 - Layout 22
 - HTML Examples 25
 - External Video 25
 - Sequence Mode 25
- Dome Configuration 26
- Event Configuration 28
 - Event Servers 28
 - Event Types 29
 - Motion Detection 32
 - Port Status 33
- System Options 34
 - Security 34
 - Date & Time 35
 - Network - Basic TCP/IP Settings 37
 - Network - Advanced TCP/IP Settings 38
 - SOCKS 40

| | |
|--|----|
| SMTP (email) | 40 |
| SNMP | 40 |
| UPnP™ | 41 |
| RTP (Multicast)/MPEG-4 | 41 |
| Ports & devices - I/O Ports | 41 |
| Maintenance | 41 |
| Support | 42 |
| Advanced | 43 |
| About | 43 |
| Resetting to Factory Default Settings | 43 |
| Using the Control Button | 43 |
| Connection Module | 45 |
| Troubleshooting | 47 |
| Checking the Firmware | 47 |
| Updating the Firmware | 47 |
| Emergency Recovery Procedure | 48 |
| Support | 48 |
| Symptoms, Possible Causes and Remedial Actions | 49 |
| Technical Specifications | 51 |
| General performance considerations | 54 |
| Optimizing your system | 54 |
| Frame rates - Motion JPEG | 55 |
| Frame rates - MPEG-4 | 55 |
| Bandwidth | 55 |
| Index | 57 |

AXIS 231D/232D

Ideal for demanding surveillance and remote monitoring applications, the AXIS 231D/232D Network Dome Camera features precise pan/tilt/zoom control, superior quality Motion JPEG and MPEG-4 video, advanced event management functionality, 4 alarm inputs/4 alarm outputs (i.e. door sensors, alarm bells), 20 preset positions, Sequence Mode and Guard Tour. With security features such as HTTPS and IP address filtering, the AXIS 231D/232D is perfect for professional security installations.

Up to 20 viewers can access the camera simultaneously when using Motion JPEG and MPEG-4 unicast. Video can be viewed in 5 resolutions (up to 4CIF), image compression is configurable.

The AXIS 231D/232D has a built-in Web server, providing full access to all features through the use of a standard Web browser. The built-in scripting tool allows basic applications to be created, providing basic surveillance solutions. For advanced functionality, the Network Dome Camera can be integrated via the use of AXIS HTTP API. For more information, refer to <http://www.axis.com/developer>

Axis products are supported by the industry's largest base of application software for managing and recording video, and integrating alarm and access control systems.



AXIS 232D

The AXIS 232D Network Dome Camera is a day and night camera with an IR cut filter which enables the camera to capture color video in light conditions down to 0.3 lux, and black and white video in conditions down to 0.005 lux. The IR-cut filter can be automatically enabled/disabled according to the current light conditions or manually enabled/disabled from the internal web pages.

Hardware Inventory

Check the items supplied with your network dome camera against the following list:

| Item | Title/variant | Notes |
|----------------------------|-----------------------------------|--|
| Network Dome Camera | AXIS 231D/232D | |
| Printed user documentation | AXIS 231D/232D Installation Guide | |
| Warranty | Warranty document | |
| Connection module | Connection module | Power/alarm connections |
| Cable | 22-pol connection cable | 24V AC, 3A power connection I/O connections |
| Power supply | | Country specific |

Hardware Description



Network Connector- After completion of the startup and self test routines, the Network and Power Indicators show as follows:

| Indicator | Color | Description |
|-----------|-------|--|
| Network | Green | Flashes for network activity |
| | Red | Slow flash for failed firmware upgrade |
| | None | No connection |
| Power | Green | Normal operation |
| | Amber | Flashes green/amber during upgrade. |

Detail - network connector:

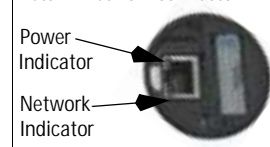

Control Button - Press this button to restore the factory default settings, as described in *Resetting to Factory Default Settings, on page 43* or for installation as described in the provided AXIS 231D/232D Installation Guide and also available from the Axis Web site at <http://www.axis.com>.

The Serial Number (S/N) is located on the label on the unit.

Network Connector - The AXIS 231D/232D connects to the network via a standard RJ45 connector. The AXIS 231D/232D detects the speed of the local network segment (10BaseT/100BaseTX Ethernet).

Connection Module - The connection module provides the physical interface to 4 transistor outputs, 4 digital inputs and is the connection point for AC power. See *Connection Module*, on page 45.

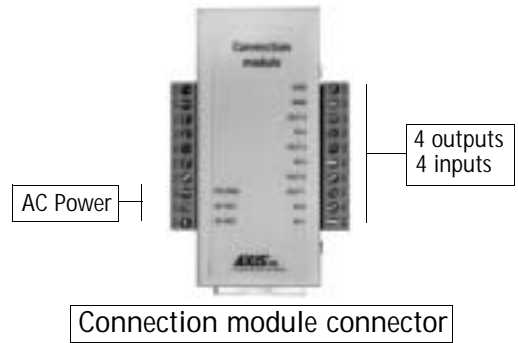

For instructions on how to install the AXIS 231D/232D, please refer to the AXIS 231D/232D Installation Guide which is supplied with the product in printed format or in PDF format from the Axis Web site at <http://www.axis.com>.

Using the Network Dome Camera

This document includes instructions for using and managing the AXIS 231D/232D. Instructions on how to install the AXIS 231D/232D on your network are provided in the AXIS 231D/232D Installation guide which is available on the Axis Web site. The AXIS 231D/232D can be used with most standard operating systems and supports Microsoft Internet Explorer 6.x or later, Netscape 7.x or later and Mozilla 1.4 or later.

Accessing the AXIS 231D/232D

1. Start a Web browser (Internet Explorer, Mozilla, Netscape Navigator).
2. Enter the IP address or host name of the AXIS 231D/232D in the Location/Address field of your Web browser.
3. Enter the user name and password set by the administrator.
4. A video image is displayed in your Web browser.

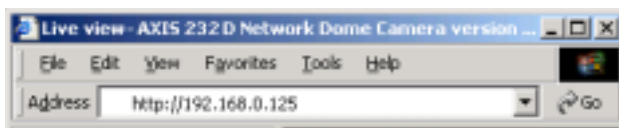

- Note:**
- To view streaming video in Microsoft Internet Explorer, Axis recommends you set your browser to allow the AXIS Media Control (AMC) to be installed on your computer. The first time an MPEG-4 video stream is accessed AMC also installs an MGPEG-4 decoder for viewing the video streams. As a license is required for each instance of the decoder, the product administrator may have disabled the installation. If your work environment restricts the use of additional software components, you can configure the AXIS 231D/232D to use a Java applet for updating images. Please refer to the online help files for more information.
 - User functions in the AXIS 231D/232D may have been customized to meet the specific requirements of the application. Consequently, many of the examples and functions in this section may differ from those displayed in your Live View page.

The Live View page

If the dome camera has been customized, the buttons and other items described below will be displayed accordingly on the Live View page. The following provides an overview of each button:

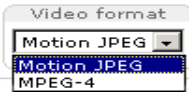

The Video Format drop-down list allows the video format on the Live View page to be temporarily changed.



The **Output** buttons control an output directly from the Live View page. These buttons are configured under **Setup > Live View Config > Layout**.



Pulse - click this button to activate the port for a defined period of time, e.g. to switch on a light for 20 seconds.

Active/Inactive - click these buttons to manually start and stop a connected device, e.g. switch a light on/off.



These buttons start/stop the **Sequence Mode**. This mode is created in **Setup > Live View Config > Sequence mode** and automatically displays the view from preset positions at set intervals.



The **Action** buttons trigger an action directly from the Live View page. These buttons are configured under **Setup > Live View Config > Layout**. Click these buttons to manually start and stop events.



Use the **Snapshot** button to capture a snapshot of the image currently being displayed in the window. Right-click on the image to save it in JPEG format on your computer.

The Live View toolbar displays the following buttons:



The **Play/Stop** buttons start and stop the live video stream.



The **Snapshot** button takes a snapshot of the currently displayed image. The Snapshot function and the target directory for saving snapshots can be configured from AMC (AXIS Media Control), which is available from the Windows Control Panel (Internet Explorer only).



Click the **View Full Screen** button and the video image will fill the entire screen area. No other windows will be visible. Press Esc (Escape) on the computer keyboard to cancel full screen view.

Pan/Tilt/Zoom controls

The controls available for the Pan/Tilt/Zoom (PTZ) are displayed on the Live View by default. These are enabled/disabled for specified users by the administrator under **System Options > Security > Users > User List**.

The Pan Tilt and Zoom bars control their respective functions in two different ways. Clicking anywhere on the bar's gradient allows for a 'smooth' adjustment of the camera's position, while clicking on the arrows at the two ends of the bar cause a stepped, incremental change

- the Pan bar - moves the camera to the right and left
- the Tilt bar - tips the camera up and down
- the Zoom bar - zooms the view in and out
- the Focus bar - adjusts the focus
- the Iris bar - adjusts the brightness of the image



Clicking on the bars themselves or on the arrows at the end of the bars will move the camera to a new position.

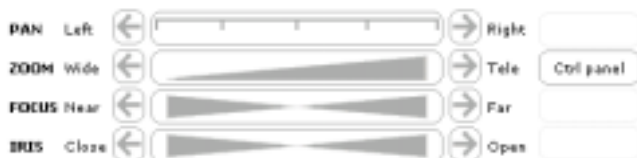

Note: Setting the iris and focus manually will disable Auto iris/Auto focus.

Each position on the bar represents a defined position in the camera's range of movement, with the center of the bar representing the point midway between the two extremes of movement.

Clicking a position directly on the bar moves the camera directly to the new position in one smooth movement. Clicking on the arrows at the ends of a bar causes a stepped, incremental change.

Click-in-image

The PTZ device can also be controlled using click-in-image movement, which has two different types of navigation; Center and Joystick.

Center mode means that when clicking in the image, the camera view will center on the absolute position that was clicked.

Joystick mode moves the camera in the direction of the mouse pointer. By clicking and holding the mouse button down in the image, the PTZ device moves the camera in that direction, relative to the center of the image. The further from the center the image is clicked, the greater the movement. The camera stops moving when the button is released.

Focus and Iris Controls

The Focus and Iris (image brightness) can be adjusted manually by using the control bars, or they can be set for automatic adjustment, by clicking the **Auto Iris** and **Auto Focus** buttons.

Preset Positions

These presets are selected from the drop-down **Source** list on the Live View page and will move and/or zoom the camera to a pre-defined position, i.e. to cover an area of particular interest. Events can also be configured to go to preset positions when triggered. For information on setting up preset positions, please see *Dome Configuration*, on page 26 and the online help.

Using CGI links to control PTZ devices

User-defined CGI links on the Live View page can be used to issue HTTP API requests, e.g. PTZ commands. These links are configured in the Live View Layout settings, see page 23.

The Control panel

Click the **Ctrl** panel button to display the control panel, where the following settings are available:

- **Auto focus:** Automatically adjusts the image focus.
- **Auto iris:** Automatically adjusts the amount of light reaching the camera and gives the best results, This also protects the image sensor from strong light.
- **Backlight comp:** Enabling backlight compensation makes the subject clearer if the image background is too bright, or if the subject is too dark.
- **Navigation mode:** "Center" will move the camera view to center on the position that was clicked. "Joystick" moves the camera in the direction indicated by a mouse click, relative to the center of the image. The further from the center the image is clicked, the greater the movement.



- **IR cut filter** - when set to off, the camera will be able to “see” infrared light, e.g. at night, thus making the image clearer. The image is shown in black & white when the IR cut filter is off. Set to **Auto** to automatically turn the filter off when the available visible light falls below the minimum requirement.
- **Shortcuts** - These buttons can be configured to provide direct access to various built-in auxiliary commands provided by the PTZ driver. See **Advanced - Ctrl Panel** on page 26.

Pan/Tilt/Zoom Control Queue

This means that the time the user is in control of the PTZ settings is limited and that a queue of users has been set up. Use the buttons to request or release control of the Pan/Tilt/Zoom controllers.



The screenshot shows a web interface titled "PTZ Control Queue". It contains the following elements:

- Status in queue:** A text box containing the message "You are processing the control".
- Position in queue:** A text box containing the number "1".
- Time remaining:** A text box containing "27" followed by the label "seconds".
- Release control:** A button located at the bottom right of the interface.

The Pan/Tilt/Zoom Control Queue is set up by the administrator under:
Dome Configuration > Control Queue > PTZ Control Queue.

For more information on using Pan/Tilt/Zoom controls, please see page 10

Video Streams

The AXIS 231D/232D provides several different image and video stream formats. The type to use depends on your requirements and on the properties of your network.

The Live View page in the AXIS 231D/232D provides access to Motion JPEG and MPEG-4 video streams, as well as to single JPEG images. Other applications and clients can also access these video streams/images directly, without going via the Live View page.

Stream Types

Motion JPEG

This format uses standard JPEG still images in the video stream. These images are then displayed and updated at a rate sufficient to create a stream that shows constantly updated motion.

The Motion JPEG stream uses considerable amounts of bandwidth, but also provides excellent image quality and access to each and every individual image contained in the stream.

Note also that multiple clients accessing Motion JPEG streams can use different image settings.

MPEG-4

This is a video compression standard that makes good use of bandwidth, and which can provide high quality video streams at less than 1 Mbit/s.

- Notes:**
- MPEG-4 is licensed technology. The AXIS 231D/232D includes one viewing client license. Installing additional unlicensed copies of the viewing client is prohibited. To purchase additional licenses, contact your Axis reseller.
 - All clients viewing the MPEG-4 stream must use the same image settings.

The MPEG-4 standard provides scope for a large range of different coding tools for use by various applications in different situations, and the AXIS 231D/232D provides certain subsets of these tools. These are represented as **Video object types**, which are selected for use with different viewing clients. The supported video object types are:

- **Simple** - sets the coding type to H.263, as used by e.g. QuickTime™.
- **Advanced Simple** - sets the coding type to MPEG-4 Part 2, as used by AMC (AXIS Media Control)

When using MPEG-4 it is also possible to control the bit rate, which in turn allows the amount of bandwidth usage to be controlled. CBR (Constant Bit Rate) is used to achieve a specific bit rate by varying the quality of the MPEG-4 stream. When using VBR (Variable Bit Rate), the quality of the video stream is kept as constant as possible, at the cost of a varying bit rate.

MPEG-4 protocols and communication methods

To deliver live streaming video over IP networks, various combinations of transport protocols and broadcast methods are employed.

- RTP (Realtime Transport Protocol) is a protocol that allows programs to manage the real-time transmission of multimedia data, via unicast or multicast.
- RTSP (Real Time Streaming Protocol) serves as a control protocol, to negotiate which transport protocol to use for the stream. RTSP is thus used by a viewing client to start a unicast session, see below.
- UDP (User Datagram Protocol) is a communications protocol that offers limited service for exchanging data in a network that uses the Internet Protocol (IP). UDP is an alternative to the Transmission Control Protocol (TCP). The advantage of UDP is that it is not required to deliver all data and may drop network packets when there is e.g. network congestion. This is suitable for live video, as there is no point in re-transmitting old information that will not be displayed anyway.
- Unicasting is communication between a single sender and a single receiver over a network. This means that the video stream goes independently to each user, and each user gets their own stream. A benefit of unicasting is that if one stream fails, it only affects one user.
- Multicast is bandwidth-conserving technology that reduces bandwidth usage by simultaneously delivering a single stream of information to multiple network recipients. This technology is used primarily on delimited networks (intranets), as each user needs an uninterrupted data flow and should not rely on network routers.

How to stream MPEG-4

Deciding on the combination of protocols and methods to use depends on your viewing requirements, and on the properties of your network.

RTP+RTSP

This method (actually RTP over UDP and RTSP over TCP) should be your first consideration for live video, especially when it is important to always have an up-to-date video stream, even if some images do get dropped. This can be configured as multicast or unicast.

Multicasting provides the most efficient usage of bandwidth, especially when there are large numbers of clients viewing simultaneously. Note however, that a multicast broadcast cannot pass a network router unless the router is configured to allow this. It is thus not possible to multicast over e.g. the Internet.

Unicasting should be used for video-on-demand broadcasting. However, if more and more unicast clients connect simultaneously, the server will at some point become overloaded. There is also a maximum of 20 simultaneous viewers to be considered.

RTP/RTSP

This unicast method is RTP tunneled over RTSP. This can be used to exploit the fact that it is relatively simple to configure firewalls to allow RTSP traffic.

RTP/RTSP/HTTP or RTP/RTSP/HTTPS

These two methods can also be used to traverse firewalls. Firewalls are commonly configured to allow the HTTP protocol, thus allowing RTP to be tunneled.

The AXIS Media Control

The recommended method of accessing live video (MPEG-4 and/or Motion JPEG) from the AXIS 231D/232D is to use the AXIS Media Control (AMC) in Microsoft Internet Explorer for Windows. This ActiveX component is automatically installed on first use, after which it can be configured by opening the AMC Control Panel applet from the Windows Control Panel. Alternatively, right-click the video image in Internet Explorer.

Other methods of accessing the video stream

Video/images from the AXIS 231D/232D can also be accessed in the following ways:

- If supported by the client, the AXIS 231D/232D can use Motion JPEG server push to display video. This option maintains an open HTTP connection to the browser and sends data as and when required, for as long as required.
- As single JPEG images in a browser. Enter e.g. the path: `http://<ip address>/axis-cgi/jpg/image.cgi?resolution=CIF`
- Windows Media Player. This requires AMC and the MPEG-4 decoder to be installed. The paths that can be used are listed below, in the order of preference.
 - Unicast via RTP: `axrtpu://<ip address>/mpeg4/media.amp`
 - Unicast via RTSP: `axrtsp://<ip address>/mpeg4/media.amp`
 - Unicast via RTSP, tunneled via HTTP: `axrtsphhttp://<ip address>/mpeg4/media.amp`
 - Unicast via RTSP, tunneled via HTTPS: `axrtsphhttps://<ip address>/mpeg4/media.amp`
 - Multicast: `axrtpm://<ip address>/mpeg4/media.amp`

Other MPEG-4 clients

Although it may be possible to use other clients to view the MPEG-4 stream, this is not guaranteed by Axis.

For some other clients, e.g. QuickTime™ the Video Object Type must be set to *Simple*. It may also be necessary to adjust the advanced MPEG-4 settings.

To assess the video stream from e.g. QuickTime™ the following path can be used:

```
rtsp://<ip address>/mpeg4/1/media.amp
```

This path is for all supported methods, and the client will negotiate with the network camera to determine exactly which transport protocol to use.

Configuring the Network Dome Camera

This section describes how to configure the AXIS 231D/232D and is intended for the product Administrator who has unrestricted access to all Setup tools and Operator who has access to Video & Image, Live View Config and Event Configuration. See the section on *Security*, on page 34 for more information on user access control.

The AXIS 231D/232D is configured under Setup from a standard browser.

Accessing the Setup Tools

Follow the instructions below to access the Setup Tools from a Web browser.

1. Start the Web browser and enter the IP address or domain name of the AXIS 231D/232D in the location/address field.

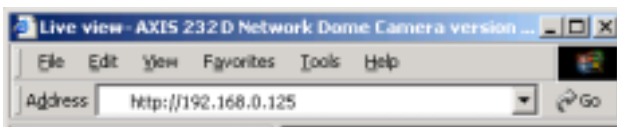

2. The Live View page is now displayed. Click Setup to display the Setup tools.

Overview of the Setup Tools



Video & Image Settings

The following descriptions offer examples of the available features in the AXIS 231D/232D. For details of each setting, please refer to the online help files which are available from each page. Click  to access the help files.

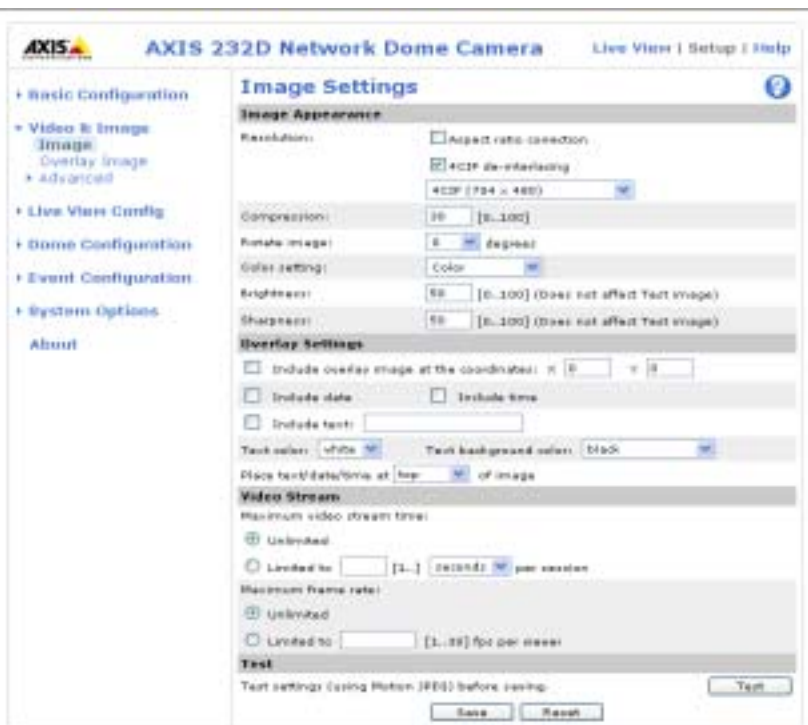



Image Settings

To optimize the video images according to your requirements, modify the following settings under **Image Appearance**. Each setting is described in the online help files .

All configuration of images and overlays will affect the performance of the network camera, depending on the usage and the available bandwidth.

- High resolution generates larger files
- Lower compression improves image quality, but generates larger files
- Black & White uses less bandwidth than Color
- Rotating the image 90 or 270 degrees will lower the maximum frame rate

See also the specifications for frame rates and bandwidth in *General performance considerations*, on page 54.

Overlay Settings

Use these settings to include a) an image as an overlay, and/or b) the date and time, along with text of your own.

Text overlays are all included on one line at the top or bottom of the video image. Image overlays can be placed anywhere in the video image.

To upload an overlay image, see below.



Video Stream

The **Maximum video stream time** can be set as *Unlimited*, or a **maximum stream time** per session in seconds, minutes or hours can be defined. When the set time has expired, a new stream can be started by refreshing the page in the Web browser. Note that the maximum video stream time does not apply to clients connecting via multicast.

To avoid bandwidth problems on the network, the **frame rate** allowed to each viewer can also be limited. Select either *Unlimited* or define a maximum frame rate per viewer.

For a preview of the image and overlay settings before saving, click **Test**. When you are satisfied with the settings, click **Save**.

Overlay Image Settings

An overlay image is an image included in the **Live View**. This might, for example, be your own company logo. Follow these instructions to upload and use an overlay image:

1. Go to **Setup > Video & Image > Overlay Image**.
2. To upload the file (a logo or image) to the AXIS 231D/232D, click the **Browse** button and locate it on your computer or server.
3. Click the **Upload** button and follow the on-screen instructions.
4. The image is now available in the **Use overlay image** drop-down list.
5. Click **Save**.
6. Go to **Setup > Video & Image** and modify the parameters under **Overlay Settings**.

Overlay image requirements:

| Image Formats | Image Size |
|--|---|
| <ul style="list-style-type: none"> Windows 24-bit BMP (full color) Windows 4-bit BMP (16 colors) OS/2 4-bit BMP (16 colors) | The height and width of the overlay image in pixels must be exactly divisible by 4. |

Overlay image limitations:

- If the image overlay and text overlay are larger than the video image, no overlay will be displayed. When also using a text overlay, this will occupy 16 pixels in height and as many in width as the video image. Please consider this when configuring the overlay image.
- If the overlay is initially positioned so that part of it is outside the video image, it will be relocated so that it appears over the video image, i.e. the entire image is always displayed.
- The maximum overlay image size supported by the AXIS 231D/232D is the same as the maximum image resolution. See Technical Specifications, on page 46.

Please use the online help files  for more information.

Advanced

Advanced Camera Settings -To optimize the lighting settings according to your requirements, modify the following settings under **Lighting Conditions**:

- **White balance** - the white balancing system in the AXIS 231D/232D can automatically detect white in the image and intelligently use this as a reference for other colors.
- **Exposure control** - this setting is used to adapt to the amount/type of light being used. **Allow slow shutter** can be enabled/disabled when the exposure control is set to **Automatic**.
- **IR cut filter (AXIS 232D only)**- when the IR cut filter is set to **OFF**, the camera will be able to 'see' infrared light, e.g. at night, thus making the image clearer. The image is shown in black & white when the IR cut filter is off.
Note: If set to **Auto**, the camera will automatically switch between IR cut filter **ON** and **OFF**, according to the current lighting conditions. This is only possible when the iris is set to **Auto Iris**, and the exposure control is set to **Automatic**.
- **Backlight compensation** - this setting is used to make the subject appear clearer. against e.g. a bright background.

Image Settings

- **Auto focus enabled** (default setting).
- **Sensitivity** - sets the speed of the auto focus. **High** is used when focusing on objects that move frequently. **Low** improves the stability of the focus.

Note: In certain situations, the white balancing system will not operate effectively. Problems may occur if the image contains no white color at all, or if the dominant color is not white. In these circumstances, the white balance may incorrectly be based on another visible color in the image, and colors may become distorted. A pale background picture with reddish or blue foreground objects is very symptomatic of this condition. In such cases it is recommended that a fixed white balance setting is selected.

Please use the online help files  for more information.

MPEG-4 Settings

Tools for adjusting the MPEG-4 settings and for controlling the video bit rate.

The MPEG-4 standard provides many different coding tools for various applications in different situations. As most MPEG-4 clients do not support all of these tools, it is usual to instead define and use subsets for different clients or groups of clients. These settings allow you to define the type of viewing client to use.

Adjusting the maximum bit rate and setting it to variable or constant is a good way of controlling the bandwidth used by the MPEG-4 video stream.

For more information on these advanced settings, please see the online help files .

Live View Config

Layout

These are the tools for deciding the layout of the Live View page.

The layout can be set in 3 ways:

- Use Axis look - the layout is unchanged.
- Use custom settings - modify the default page with your own colors, images etc. Click the **Configure** button and see the Custom Settings page.
- Own Home Page - Upload and use your own custom made page as the default web page. Click the **Configure** button and see the following page.

The other settings on this page concern which additional features to include, such as buttons and links. See page 23 for more information.



Customizing the default page

The appearance of the default AXIS 231D/232D Live View page can be customized to suit your own requirements, or you can upload and use your own home page. To upload your own files, click the **Upload/Remove** button under Custom Settings and follow the **Upload Own Web Files** instructions.



Note that the setup address is `http://<ip address>/operator/basic.shtml`

Upload Own Web Files - Your own web files, background picture, color etc. must first be uploaded to the AXIS 231D/232D in order to be available for selection in the Custom Settings dialog. Once uploaded, the files are shown in the drop-down list.

1. Enter the path to the file, e.g. a file located on your workstation or click the **Browse** button.
2. Select the **User level** for the uploaded file. Setting the user access level means that you have complete control over which pages can be viewed by which users.
3. When the path is shown correctly in the text field, click the **Upload** button.

All uploaded files are shown in the drop-down lists in the lower section of the page. To remove a file, check the box provided next to it and then click the **Remove** button.

Modify the Axis Look - In this area of the Custom Settings dialog you can use your uploaded files, choose colors and include logos and banners. Click the radio button **Own:** and select the file from the drop-down list.

To use an external file located somewhere other than in the AXIS 231D/232D, click the radio button **External:** and enter the URL.

Own Home Page- To use a previously uploaded web page as the default page, check the box **Use own home page** and select the page from the drop-down list.

User Defined Links

User defined links can be CGI links or web links. Once configured, the link(s) will appear on the **Live View** page.

To set up a **web link**, select the **Use as web link** radio button, enter a descriptive name and enter the URL in the provided field. Click **Save** and the link will appear on the **Live View** page.

User defined **CGI links** can be used to issue HTTP API requests, e.g. PTZ commands.

Example:

1. Check **Show Custom Link 1**
2. Enter a descriptive name, e.g. CAM START.
3. Select the **Use as cgi link** radio button and enter the cgi link in the field:
`http://192.168.0.125/axis-cgi/com/ptz.cgi?continuouspaniltmove=30,-30`
4. Check **Show Custom Link 2**.
5. Enter a descriptive name, e.g. CAM STOP.



User Defined Links

6. Select the **Use as cgi link** radio button and enter the cgi link in the field:
`http://192.168.0.125/axis-cgi/com/ptz.cgi?continuouspaniltmove=0,0`
7. These links will appear in the web interface and can be used to control the dome camera.

Please use the online help files  for more information.

For more information on the Axis HTTP API, see the Support / Developer pages on the Axis Web site at <http://www.axis.com>. See also the section on PTZ, on page 37.

Action Buttons

These buttons can be used to manually trigger and stop an event from the Live View page. See *Event Servers*, on page 32. The snapshot button allows you to take a snapshot of the video stream and save it to a computer.

Output Buttons

These buttons are used to control the outputs on the AXIS 231D/232D and thus the equipment connected to them, e.g. to switch a light on or off:

- The Pulse button activates the port for a defined period
- Active/Inactive displays 2 buttons, one for each action (on/off)

Default Video Format

Select the default format to use on the Live View page. Checking the box for Show video format selection displays a drop-down list on the Live View page allowing you to temporarily change the format.

Default Viewer

When using *Microsoft Internet Explorer (IE)* in Windows, select your preferred method of viewing moving images. The options are:

- **AMC(ActiveX)**- This is the best choice for fast image updating in Internet Explorer, but might not be possible on computers that have restriction on the installation of additional software.
- **QuickTime** - For use with MPEG-4 only, select this to use the QuickTime plug-in for Microsoft Internet Explorer.
- **Java applet** - This alternative uses a Java applet to update the images in the browser.
- **Still Image** - Displays still images only. Hit the Refresh button in your browser to view a new image.

When using any other browser than Internet Explorer, select the appropriate method from the drop-down list for viewing images. The available options are similar to Internet Explorer except for **Server Push**. With this method, the camera maintains and controls an open HTTP connection to the browser and sends data as and when required for as long as required.

Please see the online help  for more information.

HTML Examples

You can add live video from your AXIS 231D/232D to your own web site. The video server can send Motion-JPEG or MPEG-4 images to up to 20 simultaneous connections, although an administrator can restrict this to fewer. This does not affect or include the number of multicast viewers.

By choosing the video format from the drop-down list, a new dialog appears where you enter the **Image Type**, **Image size** and other settings to suit your web page and click **Update**.

External Video

An external video source is a source originating from another Axis device on the network. The images from these sources can be displayed just as if they were produced by the AXIS 232D.

The External Video Source list shows all of the external video sources currently configured. The information displayed is the source's name and the path to the video stream. Up to 20 external video sources can be configured.

To add a new video source, click the **Add** button. This opens the External Video Source Setup dialog, which is used to make all the necessary settings.

Sequence Mode

The Live View page can be configured to rotate through the selected preset positions, in a set order or randomly.

Select the desired PTZ preset positions and enter the time in seconds to display each position (up to 59 minutes). Click **Save**.



The Sequence buttons will appear on the Live View page to enable the viewer to start and stop the sequence mode.

Dome Configuration

Preset Positions

A preset position is a pre-defined camera view that can be used to quickly move the camera to a specific location.

From **Preset Position Setup**, use the Pan, Tilt and Zoom (PTZ) controls to steer the camera to the required position. When satisfied with the camera's position, enter a descriptive name and click on **Add**. The camera position, iris and focus settings are then saved as a preset position.

The position can be assumed at any time, by selecting the preset's name from the Preset positions drop-down list. Preset positions can be used in a **Sequence mode** (Live View Config>Sequence mode) and **Event Types** (Event Configuration>Event Types)

One position can be set as the **Home** position, which is readily accessible by clicking on the **Home** button in both the Preset Position Setup window and the Live View window.



Guard Tour

A guard tour moves between chosen **Preset Positions**, one-by-one, in a pre-determined order or randomly, and for configurable time periods. Unlike the **Sequence Mode**, which is a viewing application under **Live View Config** (see page 25), the guard tour sequence will keep running after the user has logged off or closed the Web browser.

Advanced

Limits - Define the pan, tilt, zoom and focus limits for the AXIS 231D/232D. Movements to the left and right, up and down can be restricted to narrow the area under surveillance. The near focus limit can be set to avoid focusing on objects too close to the camera.

Note: Once a limit has been saved, this position can not be exceeded by the dome camera unless the values have been reset and saved to a greater value first (i.e. reset the default values of the mechanical restrictions).

Move speed sets the speed of the camera's Pan/Tilt movements. The default setting is maximum speed.

Ctrl Panel - Panel view Settings is a list of configured Shortcut command buttons. Follow the online help for instructions to configure buttons to provide direct access to various built-in auxiliary commands provided by the PTZ driver and other programmable commands. Shortcut buttons are then displayed on the ctrl Panel.

Control Queue

The administrator can set up a queue for the PTZ controllers. Once set up, the PTZ Control Queue buttons will appear on the Live View page offering one viewer exclusive control for a limited amount of time. Other users will be placed in the queue.



PTZ Control Queue on Live View page

Please see the online help [?](#) for more information.

Event Configuration

This section describes how to configure the AXIS 231D/232D for alarm handling. The AXIS 231D/232D can be configured to perform actions when defined types of events occur.

| | | |
|-------------------------|---|--|
| Event type | A set of parameters describing how and when the Network Dome Camera is to perform certain actions | |
| Triggered Event page 29 | the circumstances that start an event | e.g. at a signal from an external device, such as a door switch or a motion sensor |
| Scheduled Event page 31 | the circumstances that start an event | e.g. at a pre-programmed time |
| Action | what occurs when the event triggers | e.g. uploaded video images to an FTP server, email notification, etc. |

Event Servers

Event Servers are used for receiving uploaded image files and/or notification messages. To set up Event server connections in your AXIS 231D/232D, go to **Setup > Event Configuration > Event Servers** and enter the required information according to the selected server type.

| Server type | Purpose | Requires information |
|-------------|---|--|
| FTP Server | <ul style="list-style-type: none"> used for uploading saved images | <ul style="list-style-type: none"> Descriptive name of your choice User Name and Password (to FTP server) Upload path e.g. images/ Port number e.g. port 21 Use passive mode if there is a firewall between the dome camera and the FTP server Use temporary file if your FTP server doesn't allow an existing file to be overwritten by a new file with the same name |
| HTTP Server | <ul style="list-style-type: none"> used for uploading saved images used for notification messages | <ul style="list-style-type: none"> Descriptive name of your choice URL User Name and Password (to HTTP server) Proxy address/Proxy port (if required) Proxy User Name and Password (if required) |
| TCP Server | <ul style="list-style-type: none"> used for notification messages | <ul style="list-style-type: none"> Descriptive name of your choice User Name and Password (to TCP server) Port number e.g. port 80 |

For details on each setting, please refer to the online help files  which are available from each web page.

Note: Pre-trigger and Post-trigger buffers will be lost if the connection to the event server fails.

When the setup is complete, the connection can be tested by clicking the Test button (the connection test will take approximately 10 seconds).

Event Types

An **Event Type** is a set of parameters describing how and when the Network Dome Camera is to perform certain actions.

Example: If a door is opened, and an event has been configured to act on this, the Network Dome Camera can e.g. record and save video images to an FTP server or send a notification email to a pre-configured email address with a pre-configured message. Video images can be sent as an attachment with the email.



Triggered Event

A Triggered event can be activated from:

- a switch (doorbell) connected to an input port on the Network Dome Camera
- a Pan/Tilt/Zoom Preset position (see page 26)
- Motion detection (see page 32)
- a manually activated action e.g. from an action button in the web interface
- on restart (reboot) after e.g. power loss

How to set up a triggered event

This example describes how to set the Network Dome Camera to upload images when the main door is opened:

1. Click **Add triggered** on the **Event types** page.
2. Enter a descriptive **name** for the event, e.g. Main door.
3. Set the **priority** - High, Normal or Low (see online help files).
4. Set the **Respond to Trigger...** parameters when the event is to be active, e.g. only after office hours
5. Select the trigger alternative from the **Triggered by...** drop-down list, e.g. an Input port with a connected sensor if the door is opened.
6. Set the **When Triggered...** parameters i.e. set what the Network Dome Camera is to do if the main door is opened e.g. upload images to an FTP server or send an email.
7. Click **OK** to save the Event in the Event Types list.

Please use the online help  for descriptions of each available option. Image file names can be formatted according to specific requirements, such as time/date or type of triggered event. See *File Naming & Date/Time Formats* under *Event Configuration*.

Pre-trigger and Post-trigger buffers

This function is very useful when checking to see what happened immediately before and after a trigger, e.g. 2 minutes before and after a door has been opened.

Go to **Event Types > Add Triggered... > When Triggered ...** and check the **Upload images** checkbox to expand the web page with the available options.

Buffer size - up to 9 MB buffer. The maximum length of time of the pre-/post-buffer depends on the image size and selected frame rate.

Include pre-trigger buffer - images stored internally in the server from the time immediately preceding the trigger. Check the box to enable the pre-trigger buffer, enter the desired length of time and specify the required image frequency.

Include post-trigger buffer - contains images from the time immediately after the trigger. Configure as for pre-trigger.

Note: If the pre- or post-buffer is too large for the internal memory, the frame rate will be reduced and individual images may be missing. If this occurs, an entry will be created in the unit's log file.

Continue image upload (unbuffered) - enable the upload of images for a fixed length of time. Specify the length of time for the uploaded recording, in seconds, minutes or hours, or for as long as the trigger is active. Finally, set the desired image frequency to the maximum (the maximum available) or to a specified frame rate. The frame rate will be the best possible, but might not be as high as specified, especially if uploading via a slow connection.

Scheduled Event

A **Scheduled** event can be activated at pre-set times, in a repeating pattern on selected weekdays.

How to set up a scheduled event

This example describes how to set the Network Dome Camera to send an email notification with saved images from at a set time:

1. Click **Add scheduled** on the Event types page.
2. Enter a descriptive name for the event, e.g. Scheduled email.
3. Set the **priority** (High, Normal or Low).
4. Set the **Activation Time** parameters (24h clock) when the event is to be active, e.g. start on Fridays at 18.00 with a duration of 62 hours.
5. Set the **When Activated...** parameters i.e. set what the Network Dome Camera is to do at the specified time e.g. send uploaded images to an email address.
6. Click **OK** to save the Event in the Event Types list.

Please use the online help files  for descriptions of each available option.

Motion Detection

Motion detection is used to generate an alarm whenever movement occurs (or stops) in the video image. A total of 10 Include and/or Exclude windows can be configured.

- **Include** windows target specific areas within the whole video image
- **Exclude** windows define areas within an Include window that should be ignored (areas outside Include windows are automatically ignored)

Once configured, the motion detection windows will appear in a list of available triggers, for triggering events. See [How to set up a triggered event](#), page 29.

Note: Using the motion detection feature may decrease the camera's overall performance.



Configuring Motion Detection

1. Click **Motion Detection** in the Event Configuration menu.
2. Click the **Configure Included Windows** radio button.
3. Click **New**.
4. Enter a descriptive name under **Windows name**.
5. Adjust the size (drag the bottom right-hand corner) and position (click on the text at the top and drag to the desired position).
6. Adjust the **Object size**, **History** and **Sensitivity** profile sliders (see table below for details). Any detected motion within an active window is then indicated by red peaks in the **Activity** window (the active window has a red frame).
7. Click **Save**.

If there are parts of the Include window that you wish to exclude, click the **Configure Excluded Windows** radio button and repeat steps 1-8 above.

Please use the online help for descriptions of each available option.

| Parameter | Object Size | History | Sensitivity |
|----------------|--|---|---|
| High | Only very large objects trigger motion detection | An object that appears in the region will trigger the motion detection for a long period | Ordinary colored objects against ordinary backgrounds will trigger the motion detection |
| Low | Even very small objects trigger motion detection | An object that appears in the region will trigger motion detection for only a very short period | Only very bright objects against a dark background will trigger motion detection |
| Default values | Low | Medium to High | Medium to High |

Note:

- Avoid triggering on small objects in the image by selecting a high size level.
- To trigger motion detection as long as there is activity in the area, select a high history level.
- To only detect flashing light, low sensitivity can be selected. In other cases, a high sensitivity level is recommended.
- Motion detection is disabled while the PTZ unit is being used.

Port Status

Under **Event Configuration > Port Status** there is a list that shows the status for the connected inputs and outputs of the AXIS 231D/232D for the benefit of the Operator who cannot access the System Options section.

Note: If the Normal state for a push button (e.g. doorbell) connected to an input is set to **Open circuit** - as long as the button is not pushed, the state is inactive. If the push button is pushed, the state of the input changes to active.

System Options

Security

User access control is enabled by default, the administrator sets the root password on first access. Other users are authorized with user names and passwords, or the administrator can choose to allow anonymous viewer login to the Live View page, as described below:

Users - the user list displays the authorized users and access levels:

| User | Description |
|---------------|---|
| Viewer | Provides the lowest level of access, which only allows the user access to the Live View page. |
| Operator | An Operator can view the Live View page, create and modify event types and adjust certain other settings. The Operator does not have access to the Systems Options configuration pages. |
| Administrator | An administrator has unrestricted access to the Setup Tools and can determine the registration of all other users. |

User Settings - check the corresponding checkboxes to enable:

- **Anonymous viewer login** - allows any viewer direct access to the Live View page.
- **Anonymous PTZ control login** - allows any viewer access to the Pan/Tilt/Zoom controllers on the Live View page.

Maximum number of simultaneous viewers -Limiting the number of viewers accessing the server at any one time can be useful if there are limitations on the available bandwidth. The maximum of 20 viewers means that subsequent viewers will not see the video stream, but instead a blank image.

IP Address Filtering

Enable IP Address Filtering- To allow or deny access to the AXIS 231D/232D Network Dome Camera check the box **Enable IP address filtering**. Once enabled, the IP addresses in the list will be allowed or denied access according to the choice made in the drop-down list **Allow/Deny the following IP addresses**.

The administrator can add up to 256 IP addresses to the list (a single entry can contain multiple IP addresses). The users from these IP addresses need to be specified in the user list with the appropriate access rights (**User**, **Operator** or **Administrator**).

Referrals - to prevent unauthorized sources from including the video stream from the AXIS 231D/232D into external Web pages, check the **Referrals** checkbox and enter the IP address or Host name of the computer that hosts the Web pages with the included video stream. Several IP addresses/host names can be defined and are separated by semicolons(;

- Notes:**
- If the referrers feature is enabled and you wish to also allow normal access to the Live View page, the product's own IP address or host name must be added to the list of allowed referrers.
 - Restricting referrers has no effect on an MPEG-4 video stream. To restrict an MPEG-4 stream, IP address filtering must be enabled.
 - Restricting referrers is of greatest value when not using IP address filtering. If IP address filtering is used, then the allowed referrers are automatically restricted to those allowed IP addresses.

HTTPS

For greater security, the AXIS 231D/232D can be configured to use HTTPS (Hypertext Transfer Protocol over SSL (Secure Socket Layer)). That is, all communication that would otherwise go via HTTP will instead go via an encrypted HTTPS connection.

Certificate - to use HTTPS for communication with the AXIS 231D/232D, a Certificate must be created using one of the following methods:

- A self-signed certificate can be created in the network camera, but this does not guarantee the same level of security as an official certificate.
- An official certificate issued by a CA (Certificate Authority). A CA issues and manages security credentials and public keys for message encryption.
 1. Click either **Create self-signed certificate** or **Create Certificate Request** and enter the required information in the provided fields.
 2. Click **OK**.
 3. **Create self-signed certificate** generates and installs a certificate which will be displayed under **Installed Certificate**.
Create Certificate Request generates a PEM formatted request which you copy and send to a CA for signing. When the signed certificate is returned, click **Install signed certificate...** to install the certificate in the AXIS 231D/232D.
 4. Set the **HTTPS Connection Policy** for the administrator, Operator and Viewer to enable HTTPS connection (set to HTTP by default)

Please refer to the home page of your preferred CA for information on where to send the request etc. For more information, please refer to the online help files 

Date & Time

Current Server Time - displays the current date and time (24h clock). The time can be displayed in 12h clock format in the Overlay Images (see **Date & Time Format Used in Images**).

New Server Time - Select your time zone from the drop-down list and check the daylight saving time changes, if desired.

From the **Time Mode** section, select the preferred method to use for setting the time:

- **Synchronize with computer time** - sets the time from the clock on your computer.
- **Synchronize with NTP Server** - the network camera will obtain the time from an NTP server every 60 minutes. Specify the NTP server's IP address or host name.

Note: Note that if using a host name for the NTP server, a DNS server must be configured under TCP/IP settings.
See **Network > Advanced TCP/IP Settings** below.

- **Set manually** - this option allows you to manually set the time and date.

Date & Time Format Used in Images - specify the formats for the date and time (12h or 24h) displayed in the Live View video streams.

Use the predefined formats or use your own custom date and time formats. See **Advanced File Naming & Date/Time Formats** in the help files  for information on how to create your own file formats.

Network - Basic TCP/IP Settings

IP Address Configuration- the IP address of the Network Dome Camera can be set automatically via DHCP, or a fixed IP address can be set manually. DHCP is enabled by default. To use a fixed IP address, you must also enter the correct subnet mask and default router.

- Notes:**
- DHCP is a protocol for automatic IP address assignment on a network. IP address assignment via DHCP may lead to the situation where the IP address changes and you lose contact. Configure the options for notification of IP address change (under Services) to receive notification from the network camera when the IP address changes.
 - Alternatively, if your DHCP server can update a DNS server, you can access the AXIS 231D/232D by host name which is always the same, regardless of the IP address.

For more information, please refer to the online help files 

Services

Options for notification of IP address change - if the IP Address for the Network Dome Camera is changed e.g. automatically by DHCP, you can choose to be notified of the change. Click Settings... and enter the required information.

AXIS Internet Dynamic DNS Service - If the AXIS 231D/232D Network Dome Camera has been registered with the Axis Internet Dynamic DNS service and the IP address for the product changes, the service is updated to reflect the change. Check the box to enable/disable automatic updates.

The domain name currently registered at the Axis Internet Dynamic DNS service for your product can at any time be removed. To do this click Settings... and follow the instructions.

For more information, please refer to the online help files 

Network - Advanced TCP/IP Settings

DNS Configuration

DNS (Domain Name Service) provides the translation of host names to IP addresses on your network.

Obtain DNS server address via DHCP - automatically use the DNS server settings provided by the DHCP server. Click the View button to see the current settings.

Use the following DNS server address - enter the desired DNS server by specifying the following:

Domain name - enter the domain(s) to search for the host name used by the AXIS 231D/232D. Multiple domains can be separated by semicolons (;). The host name is always the first part of a Fully Qualified Domain Name, e.g. myserver is the host name in the Fully Qualified Domain Name myserver.mycompany.com where mycompany.com is the Domain name.

DNS servers - enter the IP addresses of the primary and secondary DNS servers.

NTP Configuration

Configuring the NTP server can be done automatically or manually. By checking the radio button **Obtain NTP server address via DHCP** the AXIS 231D/232D automatically looks up and uses the NTP server as provided by DHCP.

To specify the server manually, check the radio button **Use the following NTP server address**. Enter the server's IP address or host name. Note that a DNS server must be specified if using a host name.

Host Name Configuration

The AXIS 231D/232D can be accessed using a host name, instead of an IP address. The host name is usually the same as the assigned DNS Name. It is always the first part of a Fully Qualified Domain Name and is always one word, with no period. For example, myserver is the host name in the Fully Qualified Domain Name myserver.mycompany.com.

The **enable dynamic DNS updates** allows you to alias a dynamic IP address to a static host name, allowing your computer to be more easily accessed from various locations on the Internet. Outside users can always access your server using the associated DNS name regardless of the WAN IP. The DNS server used by the user and/or the DNS server responsible for the domain in use must support RFC2136 and allow updates from the dome camera.

The TTL (Time To Live) value determines how long (in seconds) the reply from the DNS server should be remembered when checking that the domain name for the registered IP address is still valid. For more information, please see the online help 

Link-Local Address

This is enabled by default and assigns the AXIS 231D/232D an additional IP address for use with UPnP™. The AXIS 231D/232D can have both a Link-Local IP and a static/DHCP-supplied IP address at the same time - these will not affect each other.

HTTP

The default HTTP port number (80) can be changed to any port within the range 1024-65535. This is useful for e.g. simple port mapping.

HTTPS

If applicable, enter the HTTPS port the AXIS 231D/232D will use. The default setting (443) can be changed to any port within the range 1024-65535. HTTPS is used to provide encrypted web browsing.

NAT traversal

Use NAT traversal when your AXIS 231D/232D is located on an intranet (LAN) and you wish to make it available from a NAT router. When properly configured all HTTP traffic to an external port in the NAT router will be forwarded to the network camera.

Enable/Disable - When enabled, the AXIS 232D will attempt to configure port mapping in a NAT router on your network, using UPnP™.

Use manually selected NAT router - Select this option to manually select a NAT router. Enter the IP address for the router in the field provided.

If a router is not manually specified, the AXIS 231D/232D will automatically search for NAT routers on your network. If more than one router is found, the default router will be selected.

Alternative HTTP port - Select this option to manually define an external HTTP port. Enter the port number in the field provided. If no port is entered here a port number will automatically be selected when NAT traversal is enabled.

For more information, please see the online help 

RTSP

The RTSP protocol allows a connecting client to start an MPEG-4 stream. Enter the RTSP port number to use. The default setting is (554).

Network Traffic

The default setting is **Auto-negotiate** which means that the correct speed is automatically selected. If necessary, you can set the connection speed by selecting it from the drop-down list.

Maximum bandwidth - Specify, in Mbit/s or kbit/s, the maximum bandwidth that the network camera is allowed to use on your network. This is a useful function when connecting your network camera to busy or heavily loaded networks. The default setting is **Unlimited**.

Note: When using MPEG-4 as the video format, remember that setting a maximum bandwidth value here may create problems for individual video streams if the maximum value is less than the sum of the bit rates set for the video streams.

For more information, please see the online help 

SOCKS

SOCKS is a networking proxy protocol. The AXIS 231D/232D can be configured to use a SOCKS server to reach networks on the other side of a firewall/proxy server. This functionality is useful if the Network Dome Camera is located on a local network behind a firewall, but notifications, uploads, alarms, etc., need to be sent to a destination outside the local network (e.g. to the Internet).

SMTP (email)

(Simple Mail Transfer Protocol) Enter the host names or addresses for your primary and secondary mail servers in the fields provided to enable event and error email messages from the Network Dome Camera to predefined addresses, via SMTP.

SNMP

The Simple Network Management Protocol (SNMP) allows remote management of network devices. Depending on the level of security required, select the version of SNMP to use. The three levels of security are:

- SNMP V1 - includes no security.
- SNMP V2c - uses very simple security. The community name can be specified as a password for read or read/write access to all supported SNMP objects. The community is the group of network devices using SNMP.
- SNMP V3 - provides encryption and secure passwords. HTTPS must be enabled.

UPnP™

(Universal Plug and Play) The Network Dome Camera includes support for UPnP™ in Windows ME and Windows XP. UPnP™ is enabled by default.

Note: UPnP must be installed on your workstation. To do this, open the Control Panel from the Start Menu and select Add/Remove Programs. Select Add/Remove Windows Components and open the Networking Services section. Click Details and then select UPnP as the service to add. Refer to the Windows help files for more information.

RTP (Multicast)/MPEG-4

These settings are the IP address, port number, and Time-To-Live value to use for the video stream(s) in multicast MPEG-4 format. Only certain IP addresses and port numbers should be used for multicast streams. For more information, please see the online help.

Ports & devices - I/O Ports

The pinout, interface support and the control and monitoring functions are described in the section on the *Connection Module*, on page 45.

Maintenance

- **Restart** - The unit is restarted without changing any of the settings. Use this method if the unit is not behaving as expected.
- **Restore** - The unit is restarted and most current settings are reset to factory default values. The settings that will not be reset are as follows:
 - the boot protocol (DHCP or static)
 - the static IP address
 - the default router
 - the subnet mask
 - the system time
- **Default** - The default button should be used with caution. Pressing this will return all of the network camera's settings to the factory default values (including the IP address).

Dome Status - Click the Test button to check the camera and dome mechanics for errors. Contact Axis Customer Services if you receive an error message as the result of this test.

Upgrade Server - See *Upgrading the Firmware*, on page 55.

Backup - To take a backup of all of the parameters, and any user-defined scripts, click this button. If necessary, it is then possible to return to a previous configuration if settings are changed and there is unexpected behavior.

Restore - click the **Browse** button to locate the saved backup file (see above) and then click the **Restore** button. The settings will be restored to the previous configuration.

Note: Backup and Restore can only be used on the same unit running the same firmware. This feature is not intended for multi-configurations or for firmware upgrades.

Support

The **Support Overview** page provides valuable information on troubleshooting and contact information, should you require technical assistance.

System Overview - is a quick look over the camera's status and settings. Information that can be found here includes the camera's Firmware version, IP address, Security, Event and Image settings and Recent log items. Many of the captions are also links to the proper **Setup** page to conveniently make adjustments in the camera's settings.

Logs & Reports - when contacting Axis support, please be sure to provide a valid **Server Report** with your query.

View Information - The **Log** report and the **Parameter List** also provide valuable information for troubleshooting and when contacting Axis' support service.

Configuration:

Log Level for Log Files - from the drop-down list, select the level of information to be added to the Log file

Log Level for Email - from the drop-down list, select the level of information to send as email and enter the destination email address.

Advanced

Scripting is an advanced function that provides the possibility to customize and use scripts. This function is a very powerful tool.

Caution!

Improper use may cause unexpected behavior or even cause loss of contact with the unit. If a script does cause problems, reset the unit to its factory default settings. A backup file may be of use to return the unit to its latest configuration).

Axis strongly recommends that you do not use this function unless you fully understand the consequences. Note that Axis support does not provide assistance for problems with customized scripts.

For more information, please visit the Developer pages at www.axis.com/developer

Plain Config - this function is for the advanced user with experience of Axis network camera configuration. All parameters can be set and modified from this page. Help is available from the standard help pages.

About

Third Party Software Licenses - click **View licenses** for a list of the licensed software used in the AXIS 231D/232D Network Dome Camera.

Resetting to Factory Default Settings

To reset the AXIS 231D/232D to the original default settings, go to the **System Options > Maintenance** web page (described in *Maintenance*, on page 41) or use the control button on the AXIS 231D/232D as described below:

Using the Control Button

Follow the instructions below to reset the AXIS 231D/232D to factory default settings using the Control Button.

1. Switch off the AXIS 231D/232D by disconnecting the power.
2. Press and hold the Control button while you reconnect the power.
3. Keep the Control button pressed until the **Power Indicator** flashes amber (this may take up to 15 seconds).
4. Release the Control button.
5. When the Power Indicator changes to green (may take up to 1 minute), the process is complete and the AXIS 231D/232D has been reset.

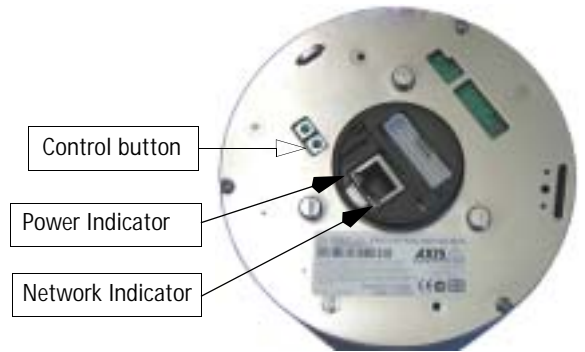

Connection Module

This section describes the pinout provided by the Connection module consisting of:

- 4 transistor outputs
- 4 digital inputs
- power and GND (ground)

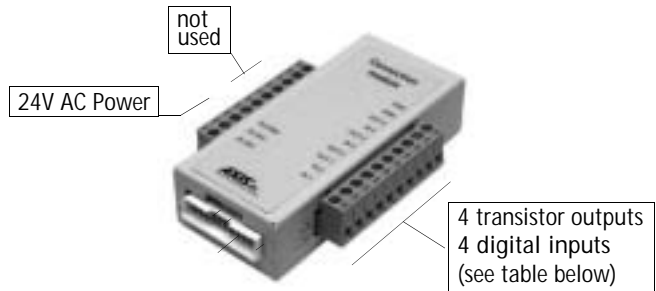

The inputs/outputs are used in applications for, e.g. event triggering, time lapse recording, alarm notification via email, picture storage to FTP locations.

- **Input** - e.g. a doorbell. If the doorbell is pressed, the state changes, and the input will be active (shown under **Event Configuration > Port Status**).
- **Output** - e.g. an alarm device that can be activated from Output buttons from the **Live View** page or as an action to an **Event Type**. The output will show as **active** (under **Event Configuration > Port Status** if the alarm device is activated).

Connection Module Pinout

| Function | Description | Function | Description |
|----------|-------------|---------------------|-------------|
| n/a | not used | GND | ground |
| n/a | not used | GND | ground |
| n/a | not used | Transistor Output 4 | See below |
| n/a | not used | Digital Input 4 | See below |
| n/a | not used | Transistor Output 3 | See below |
| n/a | not used | Digital Input 3 | See below |
| n/a | not used | Transistor Output 2 | See below |
| PS GND | ground | Transistor Output 1 | See below |
| 24 VAC | 24 VAC | Digital Input 2 | See below |
| 24 VAC | 24 VAC | Digital Input 1 | See below |

Digital Input (1-4)- connect to GND to activate or leave floating (unconnected) to deactivate
 Transistor Output (1-4)- Max. load 100mA, max. voltage 24V DC. An open-collector NPN transistor with the emitter connected to pin 2 (GND). If used with an external relay, a diode must be connected in parallel with the load for protection against any voltage transients.

1. Loosen the corresponding screw on top of the pin (see the table above to determine which pin to use).
2. Push the cable into the connector and secure it by fastening the screw.

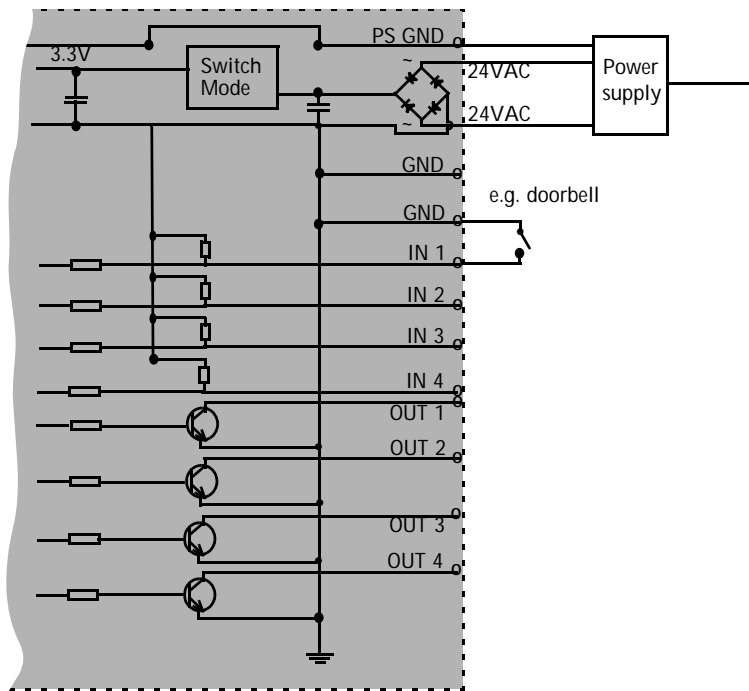
Schematic Diagram - AXIS 231D/232D I/O connectors and power

Note: Unmarked I/O connectors on the connection module can not be used.

Troubleshooting

Checking the Firmware

One of your first actions when troubleshooting a problem should be to check the currently installed firmware version. The latest version may contain a correction that fixes your particular problem. See the support section at <http://www.axis.com/techsup> for information on the latest available firmware version. The current software version in your AXIS 231D/232D is available from the product Web pages under **Setup > Basic Configuration**.

Updating the Firmware

The firmware is software that determines the functionality of the AXIS 231D/232D. When you upgrade to the latest available firmware from the Axis Web site, your Axis product will receive the latest available functionality. Always read the upgrade instructions and release notes available with each new release, before upgrading the firmware.

New firmware can be uploaded to the AXIS 231D/232D over the network.

Note: Preconfigured and customized settings will be retained for use when the new firmware is running (providing that the features are available in the new firmware) although this is not guaranteed by Axis Communications.

1. Save the firmware file to your computer. The latest version of the AXIS 231D/232D firmware is available free of charge from the Axis Web site at <http://www.axis.com/techsup> or from your local distributor.
2. Go to **Setup > System Options > Maintenance** in the AXIS 231D/232D Web pages.
3. In the **Upgrade Server** section and browse to the desired firmware file on your computer. Click **Upgrade**.

Notes: After starting the process, you should always wait at least 20 minutes before restarting the AXIS 231D/232D, even if you suspect the procedure has failed.

Your dealer reserves the right to charge for any repair attributable to faulty updating by the user.

Emergency Recovery Procedure

If power or the network connection to the AXIS 231D/232D is lost during the upgrade, the process will fail and the unit will become unresponsive. A flashing red Network LED indicates a failed upgrade. To recover the unit, follow the steps below. The serial number is found on the label on the product casing.

1. **Unix/Linux** - From the command line, type the following:
arp -s <IP address of AXIS 231D/232D> <Serial number> temp
ping -s 408 <IP address of AXIS 231D/232D>

Windows - From a command/DOS prompt, type the following:
arp -s <IP address of AXIS 231D/232D> <Serial number>
ping -l 408 -t <IP address of AXIS 231D/232D>

Note: the ping -l command is the lower-case letter (L)

2. If the unit does not reply within a few seconds, restart it and wait for a reply. Press CTRL+C to stop Ping.
3. Open a browser and type in the AXIS 231D/232D's IP address. In the page that appears, use the **Browse** button to select the upgrade file to use, e.g. axis231d.bin or axis232d.bin. Then click the **Load** button to restart the upgrade process.
4. After the upgrade has completed (1-10 minutes), the unit will automatically restart and show a steady green on the Power LED and flashing green or amber on the Network LED.
5. Reinstall the AXIS 231D/232D.

If the emergency recovery procedure does not get the AXIS 231D/232D up and running again, please contact Axis support at www.axis.com/techsup/

Support

If you contact Axis Customer Services, please help us help you resolve your problems expediently by providing a server report, log file and a brief description of the problem.

Server Report - go to **Setup > System Options > Support Overview**. The server report contains important information about the server and its software, as well as a list of the current parameters.

Log file - go to **Setup > System Options > Logs & Reports**. The Log file records events within the unit since the last restart of the system and can prove a useful diagnostic tool for troubleshooting.

Symptoms, Possible Causes and Remedial Actions

Problems setting the IP address

| | |
|--|--|
| Using ARP Ping | The IP address must be set within two minutes after the power has been applied to the AXIS 231D/232D, restart the server and try again. Also, make sure the ping length is set to 408. See the ARP ping description in the installation section. |
| The AXIS 231D/232D is located on a different subnet. | If the IP address intended for the AXIS 231D/232D and the IP address of your computer are located on different subnets, you will not be able to set the IP address. Contact your network administrator for an IP address on the same subnet as the computer you are performing the installation from. |
| The IP address is being used by another device | <p>Disconnect the power from the AXIS 231D/232D.</p> <p>Run the Ping command (in a Command/DOS window, type ping and the IP address of the unit).</p> <p>If you receive: Reply from <IP address>: bytes = 32; time = 10 ms.... - this means that the IP address may already be in use by another device on your network. You must obtain a new IP address and reinstall the unit.</p> <p>If you receive: Request timed out - this means that the IP address is available for use with your AXIS 231D/232D. In this case, check all cabling and reinstall the unit.</p> |

The AXIS 231D/232D cannot be accessed from a Web browser

| | |
|---|---|
| Cannot log in. | If the AXIS 231D/232D has been configured to use HTTPS, check that the protocol in the URL used to access the unit is correct. You may need to type this in manually (i.e. http or https) in the browser's address field. |
| The IP address has been changed by DHCP | <ol style="list-style-type: none"> 1) Move the AXIS 231D/232D to an isolated network or to one with no DHCP or BOOTP server. Set the IP address again, using AXIS IP Utility or the ARP Ping command. 2) Access the unit and disable BOOTP and DHCP in the TCP/IP settings. Return the unit to the main network. The unit now has a fixed IP address that will not change. 3) As an alternative to 2), if dynamic IP address via DHCP or BOOTP is required, select the required service and then configure IP address change notification from the network settings. Return the unit to the main network. The unit will now have a dynamic IP address, but will notify you if the address changes. |
| Other networking problems | Test the network cable by connecting it to another network device, then Ping that device from your workstation. See instructions above. |

Cannot send notifications, uploads, alarms, etc. to a destination outside the local network

| | |
|---------------------|--|
| Firewall protection | The AXIS 231D/232D can be configured to use a SOCKS server to reach networks on the other side of a firewall/proxy server. See <i>SOCKS</i> , on page 40 for more information. |
|---------------------|--|

Your AXIS 231D/232D is accessible locally, but not externally

| | |
|---|--|
| Firewall protection | Check the Internet firewall with your system administrator. |
| Default routers required | Check if you need to configure the default router settings. |
| The Internet site is too heavily loaded | Use a script running on your web server to relay images from the AXIS 231D/232D to the Internet. |

The Power indicator is not constantly lit

| | |
|---------------------|---|
| Faulty power supply | Verify that you are using the correct power supply. |
|---------------------|---|

The Network Indicator is slowly flashing red

| | |
|---|---|
| A firmware upgrade has been interrupted or the firmware has in some other way been damaged. | <p>A rescue firmware is running in the product. First, set the IP address using AXIS IP utility or ARP and Ping,</p> <p>Then, from a Web browser, access the unit and upgrade the latest firmware to the product, see <i>Updating the Firmware</i>, on page 47.</p> |
|---|---|

No images are displayed in the Web interface

| | |
|--|--|
| Problem with AMC (<i>Internet Explorer only</i>) | To enable the updating of images in Microsoft Internet Explorer, set your Web browser to allow ActiveX controls. Also, make sure that AXIS Media Control (AMC) component is installed on your workstation. |
|--|--|

| | |
|---|--|
| Installation of additional ActiveX component restricted or prohibited | Configure your AXIS 231D/232D to use a Java applet for updating the images under Live View Config > Layout > Default Viewer for Internet Explorer. See help files for more information. |
| Video Image Problems | |
| Image too dark or too light. | See the help files on Video & Image Settings |
| Problems uploading own files | There is only limited space available for the upload of your own files. Try deleting one or more existing files, to free up space. |
| Missing images in uploads | This can occur when trying to use a larger image buffer than is actually available. Try lowering the frame rate or the upload period. |
| Slow image update | Configuring, e.g. pre-buffers, hi-res images, high frame rate etc will reduce the performance of the AXIS 231D/232D. |
| Slow performance | Slow performance may be caused by e.g. heavy network traffic, many users with access to unit, low performing client, use of features such as Event handling, Image rotation. |
| Bad snapshot images | |
| Display incorrectly configured on your workstation | In Display Properties, configure your display to show at least 65000 colors, i.e. at least 16-bit. Using only 16 or 256 colors on your display will produce dithering artifacts in the image. |
| Problems with the MPEG-4 format | |
| Lower frame rate than expected. | Check with the administrator that there is enough bandwidth available. Check also the settings for bit rate control, in the Video & Image > Advanced > MPEG-4 settings. Using an inappropriate video object type can also affect the frame rate. See the online help for more information. Check in the AMC control panel applet (MPEG-4 tab) that video processing is not set to Decode only I frames. Lower the image resolution. Reduce the number of applications running on the client computer. |
| No MPEG-4 displayed in the client. | Check that the correct network interface is selected in the AMC control panel applet (network tab). Check that the relevant MPEG-4 connection methods are enabled in the AMC control panel applet (network tab). In the AMC control applet, select the MPEG-4 tab and click the button Set to default MPEG-4 decoder. |
| No multicast MPEG-4 displayed in the client. | Check with your network administrator that the multicast addresses used by the AXIS 231D/232D are valid for your network. Check with your network administrator to see if there is a firewall preventing viewing. |
| Multicast MPEG-4 only accessible by local clients. | Check if your router supports multicasting, or if the router settings between the client and the server need to be configured. The TTL (Time To Live) value may need to be increased. |
| Poor rendering of MPEG-4 images. | Color depth set incorrectly on clients. Set to 16-bit or 32-bit color. |
| Unexpected PTZ behavior | |
| Problem with hardware | Go to System Options > Maintenance > Dome Status and click Test to test the camera and dome mechanics for errors. Contact Axis Customer Services if you receive an error message as the result of this test. |

For additional assistance, please contact your reseller or check the product's support pages on the Axis Website at <http://www.axis.com/techsup>

Technical Specifications

| Item | Specification |
|----------------------------|--|
| Models | <ul style="list-style-type: none"> • AXIS 231D 50Hz/PAL • AXIS 231D 60Hz/NTSC • AXIS 232D 50Hz/PAL (Automatic Day/Night functionality) • AXIS 232D 60Hz/NTSC (Automatic Day/Night functionality) |
| Image Sensor | <ul style="list-style-type: none"> • 1/4" Sony EXview HAD CCD |
| Lens | <ul style="list-style-type: none"> • Autofocus with 18x optical zoom f=4.1mm wide to 73.8mm tele. F1.4-3.0 • Focus range: 0.2m - ∞ (wide), 0.8m - ∞ (tele) |
| Angle of view | <ul style="list-style-type: none"> • 48° (wide end) to 2.8° (tele end) |
| Zoom | <ul style="list-style-type: none"> • 18x optical and 12x digital, total 216x |
| Minimum illumination | <ul style="list-style-type: none"> • Color:0.3 lux at 30IRE • B/W: 0.005lux at 30IRE (Only AXIS 232D) |
| Shutter time | <ul style="list-style-type: none"> • 1sec to 1/10.000sec |
| Pan range | <ul style="list-style-type: none"> • 360° endless |
| Tilt range | <ul style="list-style-type: none"> • 0 °- 90° |
| Max speed | <ul style="list-style-type: none"> • Pan 360°/s • Tilt 360°/s |
| Video compression | <ul style="list-style-type: none"> • Motion JPEG • MPEG-4 Part 2(ISO/IEC 14496-2), Profiles: ASP and SP |
| Resolutions | <ul style="list-style-type: none"> • 4CIF, 2CIF Expanded, 2CIF, CIF, QCIF • Maximum 768x575 (PAL) 704x480 (NTSC) • Minimum 176x144 (PAL) 160x120 (NTSC) |
| Frame rates (NTSC/PAL) | <ul style="list-style-type: none"> • Motion JPEG: Up to 30/25 fps in 4CIF • MPEG-4: Up to 30/25 fps in 2CIF |
| Video streaming | <ul style="list-style-type: none"> • Simultaneous Motion JPEG and MPEG-4 • Controllable frame rate and total bandwidth • Constant and variable bit rate (MPEG-4) |
| Image settings | <ul style="list-style-type: none"> • Compression levels: 11 (Motion JPEG), 23 (MPEG-4) • Configurable brightness, sharpness, white balance, exposure control, backlight compensation. • Overlay capabilities: time, date, text, custom logo or image • De-interlacing (4CIF resolution) |
| PTZ Control | <ul style="list-style-type: none"> • 20 preset positions • Guard tour • Control queue |
| Security | <ul style="list-style-type: none"> • Multiple user levels with password protection • IP address filtering • HTTPS encryption |
| Alarm and event management | <ul style="list-style-type: none"> • Events triggered by built-in motion detection, external inputs or scheduled • Image uploads via FTP, email and HTTP • Notification over TCP, email, HTTP and external outputs • Pre- and post-alarm buffer of 9 MB (approx. 4 min CIF video at 4 fps) |

| Item | Specification |
|--|--|
| Connectors | <ul style="list-style-type: none"> • Ethernet 10BaseT/100BaseTX, RJ-45 • 4 alarm inputs, 4 outputs |
| Processors and memory | <ul style="list-style-type: none"> • CPU: ETRAX-100 LX 32-bit • Video processing and compression: ARTPEC-2 • RAM: 32MB • Flash memory - 8 MB • Battery backed up real-time clock |
| Power | <ul style="list-style-type: none"> • 24V AC or DC, max 25W |
| Operating conditions | <ul style="list-style-type: none"> • 5 - 50°C (41 - 122° F) • Humidity: 20-80% RH (non-condensing) |
| Installation, management and maintenance | <ul style="list-style-type: none"> • Installation tool on CD and web-based configuration • support for configuration backup and restore • Support for firmware upgrades over HTTP or FTP, firmware available at www.axis.com |
| Video access from Web browser | <ul style="list-style-type: none"> • Camera live view • Sequence tour capability for up to 20 Axis cameras • Customizable HTML pages • Complete remote control of pan, tilt and zoom |
| Minimum web browsing requirements | <ul style="list-style-type: none"> • Pentium III CPU 500 MHz or higher or equivalent AMD • 128 MB RAM • AGP graphic card, DirectDraw, 32 MB RAM • Windows: XP, 2000, NT 4.0*, ME* or 98* • DirectX 9.0 or later • Internet Explorer 6.x or later • For other operating systems and browsers, see www.axis.com/techsup *Motion JPEG only |
| System integration support | <ul style="list-style-type: none"> • Powerful API for software integration available at www.axis.com • Event trigger data in video stream • AXIS Media Control SDK • Embedded scripting support • Embedded operating system: Linux 2.4 |
| Supported protocols | <p>HTTP, HTTPS, SSL/TLS*, TCP, SNMPv1/2cv/v3(MIB-II) RTSP, RTP, UDP, IGMP, RTCP, SMTP, FTP, DHCP, UPnP, ARP, DNS, DynDNS, SOCKS. More information on protocol usage available at www.axis.com</p> <p>*This product includes software developed by the Open SSL Project for use in the Open SSL Tool kit. See www.openssl.org</p> |
| Applications (not included) | <ul style="list-style-type: none"> • AXIS Camera Station - Surveillance application for viewing, recording and archiving up to 25 cameras • AXIS Camera Recorder Surveillance application for viewing and recording up to 16 cameras • AXIS Camera Explorer- Basic software for viewing and manual recording <p>See www.axis.com/partner/adp_partners.htm for more software application via partners</p> |

| Item | Specification | |
|----------------------------|--|--|
| Included Accessories | <ul style="list-style-type: none"> • Power supply 24V AC • Hard ceiling mounting bracket • Drop ceiling mounting bracket • CD with installation tool, Software, User manual, MPEG-4 licenses (1 encoder, 1 decoder) and MPEG-4 decoder (Windows) • Transparent bubble • Quick installation guide • Connection module for power and alarm in/out | |
| Accessories (not included) | <ul style="list-style-type: none"> • Videotek DBH24K Dome Housing IP65 rated • Various mounting brackets for outdoor housing • Smoked bubble • Outdoor IP66 rated power supply AXIS PS24 • IR Illumination (Only AXIS 232D) | |
| Approvals - EMC | <ul style="list-style-type: none"> • EMC:CE:EN55022:1994+A1+A2 Class A • EN61000-3-2:2000 • EN61000-3-3:1995+A1 • EN55024:1998+A1 • EN61000-6-1:2001 • EN61000-6-2:2001 | <ul style="list-style-type: none"> • FCC part 15 Subpart B Class A • VCCI: Class A;C-Tick AS/NZS 3548 • ICES-003 • Safety: UL and CSA(power supply), EN60950(power supply) |
| Weight | <ul style="list-style-type: none"> • 1.93kg (4.3lbs) excluding power supply | |

General performance considerations

When setting up your system, it is important to consider how various settings and situations will affect performance. Some factors affect the amount of bandwidth (the bit rate) required, others can affect the frame rate, and some will affect both. If the load on the CPU reaches its maximum, this will also affect the frame rate.

The following factors are among the most important to consider:

- High image resolutions and/or lower compression levels result in larger images. Bandwidth affected.
- Access by large numbers of Motion JPEG and/or unicast MPEG-4 clients. Bandwidth affected.
- Simultaneous viewing of different streams (resolution, compression, etc.) by different clients. Frame rate and bandwidth affected.
- Accessing both Motion JPEG and MPEG-4 video streams simultaneously. Frame rate and bandwidth affected.
- Heavy usage of event settings affects the CPU load. Frame rate affected.
- Heavy network utilization due to poor infrastructure. Bandwidth affected.
- Viewing on poorly performing client PC's lowers perceived performance. Frame rate affected.

Optimizing your system

To see the bandwidth and frame rate currently required by the video stream, the AXIS 231D/232D provides a tool that can be used to display these values directly in the video image.

To do this, special format strings are added as part of a text overlay. Simply add `#r` (average frame rate in fps) and/or `#b` (average bandwidth in Kbps) bandwidth in Kbps) to the overlay.

For detailed instructions, please see the online help for **Video & Image > Overlay Settings**, and the help for **File Naming & Date/Time Formats**.



Important!

- The figures displayed here are the values as delivered by the server. If other restrictions are currently in force, (e.g. bandwidth limitation) these values might not correspond to those actually received by the client.
- For Motion JPEG, these values will only be accurate as long as no frame rate limit has been specified.

Frame rates - Motion JPEG

The following test results show the frame rates in frames/second (fps) for Motion JPEG streams from the AXIS 231D/232D, using a compression level of 50%. Note that these values are guidelines only - actual values may vary.

| | fps (PAL) | fps (NTSC) |
|---------------|-----------|------------|
| 4CIF | 25 | 30 |
| 2CIF expanded | 25 | 30 |
| 2CIF | 25 | 30 |
| CIF | 25 | 30 |
| QCIF | 25 | 30 |

Frame rates - MPEG-4

The following test results show the frame rates in frames/second (fps) for MPEG-4 streams from the AXIS 231D/232D. Note that these values are guidelines only - actual values may vary.

The MPEG-4 test conditions:

- Compression level = 50%
- Video Object Type = Advanced Simple
- GOV structure = IP*

| | fps (PAL) | fps (NTSC) |
|---------------|-----------|------------|
| 4CIF | 17 | 21 |
| 2CIF expanded | 17 | 21 |
| 2CIF | 25 | 30 |
| CIF | 25 | 30 |
| QCIF | 25 | 30 |

*Note that setting the GOV structure to use "I-frames only" will increase the frame rate.

Bandwidth

As there are many factors affecting bandwidth, it is very difficult to predict the required amounts. The settings that affect bandwidth are:

- the image resolution
- the image compression
- the frame rate
- the MPEG-4 object type
- the MPEG-4 GOV structure

There are also factors in the monitored scene that will affect the bandwidth. These are:

- the amount of motion
- the image's complexity
- the lighting conditions.

For MPEG-4, if there is only limited bandwidth available, and if this is more important than the image quality, using a constant bit rate (CBR) is recommended. Use a variable bit rate (VBR) if the image quality needs to be maintained at a higher level. If supported on the network, consider also using MPEG-4 multicasting, as the bandwidth consumption will be much lower.

Index

A

Accessing the video stream 15
Action Buttons 9
Action buttons 24
Active/Inactive 9, 24
Administrator 17, 34
Advanced TCP/IP settings 38
Alarm 28, 45
AMC 9, 15

B

Backlight Compensation 20
Backup 41
Bandwidth 13, 55
Buffer Size 30
Buffers 30

C

CGI links 11, 23
Click-in-image 10
Connection Module 45
Constant bit rate 13
Control Button 6, 43
Control panel 11
Control Queue 27
Customize 22

D

Date & Time 35
Default Viewer 24
Default viewer 24
DNS configuration 38

E

Emergency recovery 48
Event 28
Event Servers 28
Event Types 29

F

Factory Default 43
Focus 11
Frame rates 19, 55
FTP Server 28

G

Guard Tour 26

H

Host name 38
HTML examples 25
HTTP 39
HTTP API 11, 23
HTTP port number 39
HTTP Server 28
HTTPS 35

I

Include windows 32
IP Address Filtering 34
IR Cut Filter 20
IR light 12
Iris 11

L

Live View 17
Logs & Reports 42

M

Maximum bandwidth 40
Motion JPEG 13
MPEG-4 13
MPEG-4 clients 16
MPEG-4 protocols 14
MPEG-4 settings 41
Multicasting 14

N

NAT traversal 39
Network 37
Network Connector 7
New Server Time 35

Night Vision 20
NTP Configuration 38

O

Operator 34
Output Buttons 9
Output buttons 24
Overlay Image 19
Overlay Settings 19
Own home page 23
Own web files 23

P

Pan/Tilt/Zoom Controls 10
Port Status 32, 33
Ports & Devices 41
Post-trigger Buffer 30
Preset Positions 11
Preset positions 11
Pre-trigger Buffer 30
PTZ commands 11, 23
PTZ control queue 11
PTZ Controls 25
Pulse 9, 24

R

Recovery 48
Referrals 34
Restart 41
Restore 41
RTP 14, 41
RTSP 14, 39

S

Scheduled Event 28, 31
Security 34
Sequence Mode 9
Serial Number 6
Services 37
Setup Tools 17
Shortcut buttons 27
Shortcuts 12
SMTP 40

Snapshot 9
SNMP 40
SOCKS 40
Specifications 51
Streaming MPEG-4 14
Support 42
System Options 34

T

TCP Server 28
Time Mode 36
Triggered Event 28, 29
Troubleshooting 47

U

UDP 14
Unicasting 14
Upgrade Server 41
UPnP 40, 41
User 34
User defined links 23

V

Variable bit rate 13
Video format 9
Video Stream 19

W

White Balance 20

Free Manuals Download Website

<http://myh66.com>

<http://usermanuals.us>

<http://www.somanuals.com>

<http://www.4manuals.cc>

<http://www.manual-lib.com>

<http://www.404manual.com>

<http://www.luxmanual.com>

<http://aubethermostatmanual.com>

Golf course search by state

<http://golfingnear.com>

Email search by domain

<http://emailbydomain.com>

Auto manuals search

<http://auto.somanuals.com>

TV manuals search

<http://tv.somanuals.com>